

**CONNECTORS
(HIGH VOLTAGE,
HIGH CURRENT,
HYBRIDE)**

**STECKVER-
BINDUNGEN
(HOCH-
SPANNUNG,
HOCHSTROM,
GEMISCHT)**



 **LEMO**



Bestellbeispiele	3	Part number examples
Hochspannung	5	High voltage
Serie Y	6-7	Series Y
Serie 1Y.3Y	8	Series 1Y.3Y
Serie B	9-10	Series B
Serie 0S.1S	11	Series 0S.1S
Kontaktfiguration	12-13	Contactfiguration
Hochspannungskabel	14	High voltage cable
Konfektionierungsanleitung	15	Assembling Instructions
Technische Informationen	16	Technical informations
Hochspannungsfest	17	High voltage firm
Serie S	18-22	Series S
Serie E	23-25	Series E
Kontaktfiguration	26-27	Contactfiguration
Konfektionierungsanleitung	28	Assembling Instructions
Einpolig Hochstrom	29	Unipole high current
Serie S	30-36	Series S
Serie E	36-39	Series E
Kontaktfiguration	40	Contactfiguration
Konfektionierungsanleitung	41	Assembling instructions
Gemischt / Mehrpolig Hochstrom	43	Hybride / Multipole high current
Serie S	44-48	Series S
Serie E	48-51	Series E
Serie B	51/52	Series B
Serie K	53/54	Series K
Kontaktfiguration	55-58	Contactfiguration
PVC-isolierte Kabel	59	PVC-insulated Cables
Konfektionierungsanleitung	60	Assembling Instructions
Materialien	61	Materials
Serie Y	61	Series Y
Serie B+K	62	Series B+K
Serie S+E	63	Series S+E
Spannzangen	64	Collets
Serie Y	64	Series Y
Serie B	65-66	Series B
Serie K	66-69	Series K
Serie S	70-76	Series S
Serie E	77-79	Series E
Zubehör	80	Accessories
Knickschutztüllen	80-81	Bend Relief
Schutztüllen	82	Overall Bend Relief



BESTELLBEISPIELE | PART NUMBER EXAMPLES

Straight plug



FFA.1Y.405.CLAC32 = straight plug with cable collet, 1Y series, high voltage 5kV, outer shell in chrome plated brass, PEEK insulator, 1 male solder contact, C type collet for a 3,2 mm diameter cable.

Fixed socket



ERA.1Y.405.CTL = fixed socket, nut fixing, 1Y series, high voltage 5kV, outer shell in chrome plated brass, PTFE insulator, 1 female solder contact.

Fixed coupler



SWH.1S.405 = straight coupler, nut fixing, 1S series, high voltage firm, outer shell in chrome plated brass, PEEK insulator, 1 female contacts each end.

Note:
 "the „Variant“ position in the reference is used to specify either the presence of a collet nut for fitting the bend relief or the anodized colour of the housing in aluminium alloy.
 For models with collet nut for fitting the bend relief, a „Z“ should be indicated and a bend relief can be ordered separately as indicated in the „Accessories“ section. An order for a connector with bend relief should thus include two part numbers.
 For the various housings available in colours, the corresponding letter in the part number for the colour see Unipole/Multipole catalogue.
 For the watertight models of socket, the letter „P“ is used; for the vacuumtight models of socket the letters „PV“ shall be indicated.
 For the plug and socket that should be fitted with an FPM O-ring the letter „H“ shall be indicated.
²⁾Variants see Unipole/Multipole catalogue.

**Steckverbindungen
Connectors
Kontaktfiguration
Contactfiguration
Kabel
Cable
Konfektionierungsanleitung
Assembling Instructions**

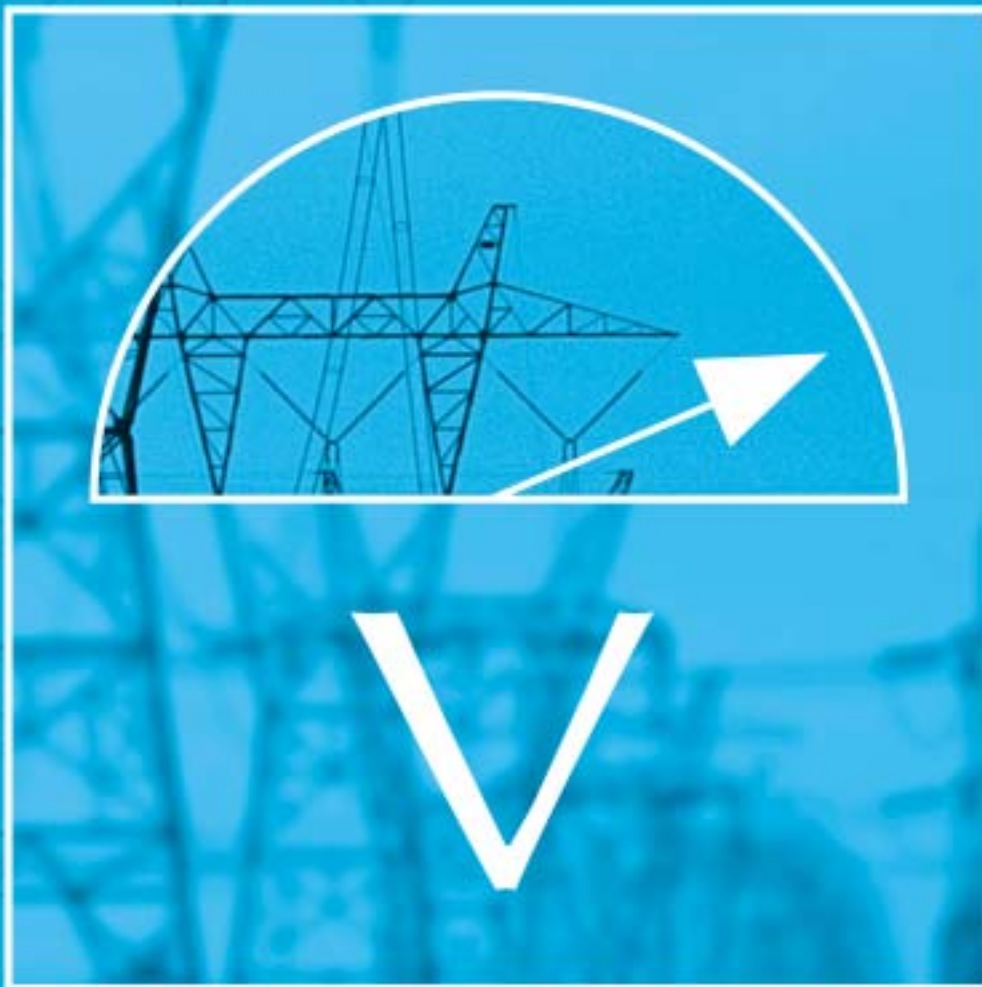

**HOCHSPANNUNG
HIGH VOLTAGE**

HOCHSPANNUNG | HIGH VOLTAGE
BAUFORM Y-SERIE | MODEL Y-SERIES



FFA Straight plug with cable collet

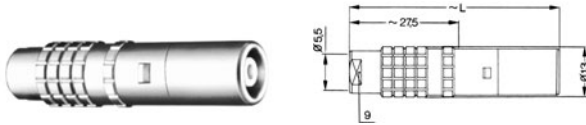

Reference		
Model	Series	Type
FFA	1Y	405 ✓
FFA	1Y	410 ✓

Dimensions L (mm)	
male contact	female contact
54	66
63	83

ERA Fixed socket, nut fixing

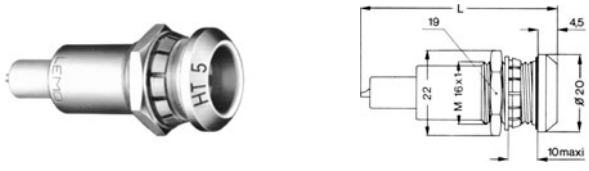

Reference		
Model	Series	Type
ERA	1Y	405 ✓
ERA	1Y	410 ✓

Dimensions L (mm)	
male contact	female contact
61	51
79	69

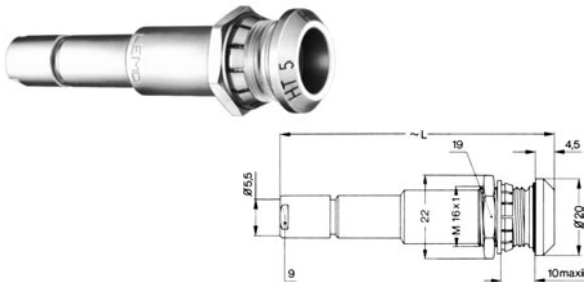

PSA Fixed socket, nut fixing, with cable collet

Reference		
Model	Series	Type
PSA	1Y	405 ✓
PSA	1Y	410 ✓

Dimensions L (mm)	
male contact	female contact
71	74
81	93

FFA Straight plug with cable collet

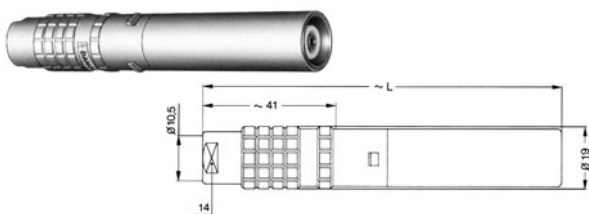

Reference		
Model	Series	Type
FFA	3Y	415 ✓
FFA	3Y	430 ✓

Dimensions L (mm)	
male contact	female contact
96	105
113	198



Part number example see page 3



HOCHSPANNUNG | HIGH VOLTAGE
BAUFORM Y-SERIE | MODEL Y-SERIES

ERA Fixed socket, nut fixing

Reference			Dimensions L (mm)	
Model	Series	Type	male contact	female contact
ERA	3Y	415 ✓	77	109
ERA	3Y	430 ✓	108	150



ERA.3Y.260.CZZ Microswitch for fitting onto fixed socket



PSA Fixed socket, nut fixing, with cable collet

Reference			Dimensions L (mm)	
Model	Series	Type	male contact	female contact
PSA	3Y	430 ✓	-	146

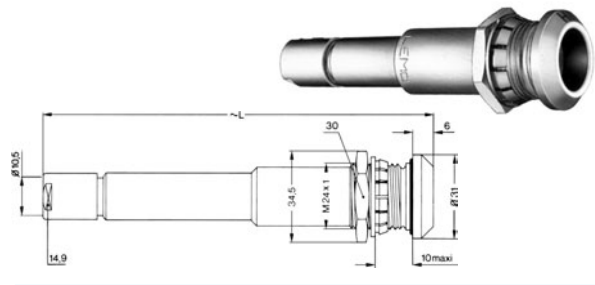

FFB.6Y Straight plug with cable collet and safety nut

50 kV Version, technische Daten auf Anfrage.
 50 kV version, technical informations on request.

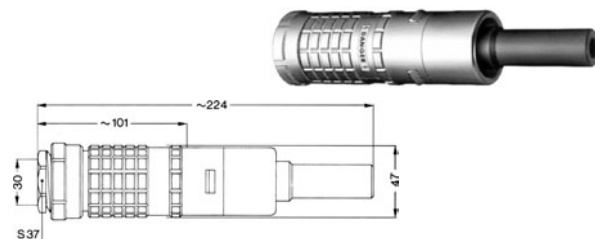

ERA.6Y Fixed socket, nut fixing

50 kV Version, technische Daten auf Anfrage.
 50 kV version, technical informations on request.

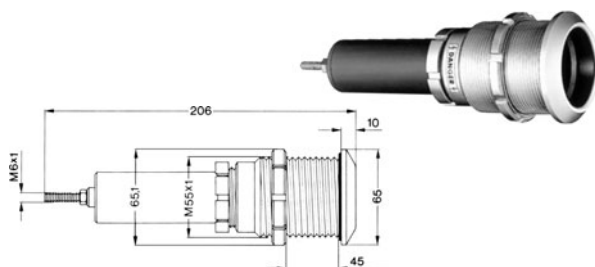

HOCHSPANNUNG | HIGH VOLTAGE
BAUFORM 1Y.3Y-SERIE | MODEL 1Y.3Y-SERIES



FFR Straight plug for cable crimping, with bend relief and safety ring

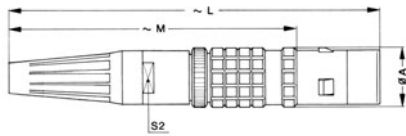

Reference		Dimensions (mm)			
Model	Series	A	L	M	S2
FFR	1Y ✓	13	83	65	9
FFR	3Y ✓	19	114	84	15

ERA Fixed socket, nut fixing

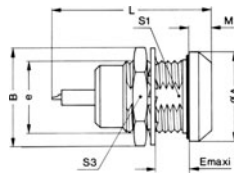

Reference		Dimensions (mm)							
Model	Series	A	B	e	E	L	M	S1	S3
ERA	1Y ✓	20	22.0	M16x1.0	8	34	4.5	14.5	19
ERA	3Y ✓	31	34.5	M24x1.0	12	50	6.5	22.5	30

PEP Fixed socket, nut fixing, with cable collet nut (back panel mounting)

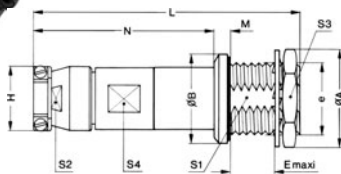

Reference		Dimensions (mm)											
Model	Series	A	B	e	E	H	L	M	N	S1	S2	S3	S4
PEP	3Y ✓	35	31	M24x1.0	13	24	86	3.5	62	22.5	20	30	20

VCP Fixed socket, nut fixing, with key, vacuumtight (back panel mounting)

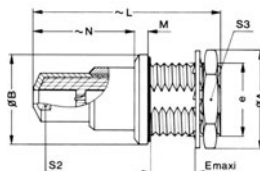

Reference		Dimensions (mm)								
Model	Series	A	B	e	E	L	M	N	S2	S3
VCP	1Y	20	22.0	M16x1.0	8	42	3.0	24	9	19
VCP	3Y ✓	31	34.5	M24x1.0	12	60	3.5	36	15	30

Note: HGP (flange version)
 VPP (watertight version)



Part number example see page 3



HOCHSPANNUNG | HIGH VOLTAGE
BAUFORM B-SERIE | MODEL B-SERIES

FCJ Straight plug with cable clamp and safety ring, keyway (J)

Reference		Dimensions (mm)					
Model	Series	A	H	L	M	S1	S2
FCJ	4B ✓	25	24	77	59	21	20
FCJ	5B ✓	35	34	107	82	31	30



EGJ Fixed socket, nut fixing, with keyway (J)

Reference		Dimensions (mm)							
Model	Series	A	B	e	E	L	M	S1	S3
EGJ	4B ✓	28	32	M25x1.0	12.5	38	2.5	23.5	30
EGJ	5B ✓	40	40	M35x1.0	11.0	43	3.0	33.5	-



ECJ Fixed socket, with two nuts and keyway (J) (back panel mounting)

Reference		Dimensions (mm)								
Model	Series	A	B	e	E	L	M	S1	S3	S4
ECJ	4B ✓	30	32	M25x1.0	10.5	38	4.5	23.5	27	27
ECJ	5B	41	40	M35x1.0	9.0	43	5.0	33.5	37	37



PFJ Fixed socket, with two nuts cable clamp and keyway (J) (back panel mounting)

Reference		Dimensions (mm)										
Model	Series	A	B	e	E	H	L	M	S1	S2	S3	S4
PFJ	4B ✓	30	32	M25x1.0	10.5	24	75	4.5	23.5	20	30	27
PFJ	5B ✓	41	40	M35x1.0	9.0	34	103	5.0	33.5	30	-	37



HOCHSPANNUNG | HIGH VOLTAGE
BAUFORM B-SERIE | MODEL B-SERIES



PHJ Free socket with cable clamp and keyway (J)



Reference		Dimensions (mm)				
Model	Series	A	H	L	S1	S2
PHJ	4B ✓	24.4	24	75	21	20
PHJ	5B ✓	34.2	34	103	31	31

**VEJ Fixed socket, nut fixing, with keyway (J)
vacuumtight (back panel mounting)**



Reference		Dimensions (mm)										
Model	Series	A	B	C	E	e	e1	L	M	N	S1	S3
VEJ	4B ✓	32	32	25	13	M25x1	M22x1	58	3.5	34.5	23.5	30
VEJ	5B	40	45	34	13	M35x1	M30x1	73	5.0	42.0	33.5	-

**VPJ Fixed socket, nut fixing, with cable clamp and keyway (J)
vacuumtight (back panel mounting)**



Reference		Dimensions (mm)												
Model	Series	A	B	C	E	e	H	L	M	N	S1	S2	S3	S4
VPJ	4B ✓	32	32	25	13	M25x1	24	91	3.5	67.5	23.5	20	30	21
VPJ	5B	40	45	34	13	M35x1	34	112	5.0	81.0	33.5	30	-	31

BAUFORM 0S.1S-SERIE | MODEL 0S.1S-SERIES

FFR Straight plug for cable crimping with safety ring

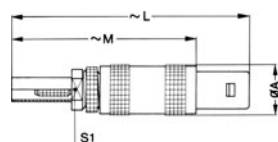

Reference		Dimensions (mm)			
Model	Series	A	L	M	S1
FFR	0S ✓	9	42	32	6.5
FFR	1S ✓	12	53	42	8.5



Part number example see page 3



HOCHSPANNUNG | HIGH VOLTAGE
BAUFORM 0S.1S-SERIE | MODEL 0S.1S-SERIES

ERA Fixed socket, nut fixing

Reference		Dimensions (mm)							
Model	Series	A	B	e	E	L	M	S1	S3
ERA	0S ✓	10	12.5	M9x0.6	7	25	1.2	8.2	11
ERA	1S ✓	14	16.0	M12x1.0	7	30	1.5	10.5	14

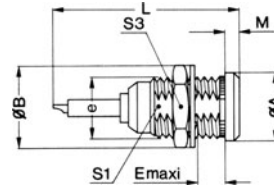

PCS Free socket for cable crimping

Reference		Dimensions (mm)		
Model	Series	A	L	S1
PCS	0S ✓	9	38	6.5
PCS	1S ✓	12	52	8.5

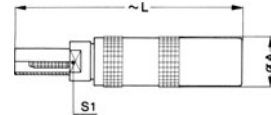

PSS Fixed socket for cable crimping, nut fixing

Reference		Dimensions (mm)								
Model	Series	A	B	e	E	L	M	S1	S2	S3
PSS	0S ✓	10	12.5	M9x0.6	7	38	1.2	8.2	6.5	11
PSS	1S ✓	14	16.0	M12x1.0	7	52	1.5	10.5	8.5	14

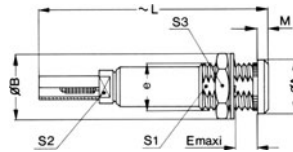

EWB Fixed socket, nut fixing, vacuumtight

Reference		Dimensions (mm)							
Model	Series	A	B	e	E	L	M	S3	S4
EWB	0S ✓	13	12.5	M9x0.6	10	34	3.5	9	11
EWB	1S ✓	18	16.0	M12x1.0	10	40	4.0	11	14

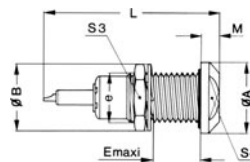

HOCHSPANNUNG | HIGH VOLTAGE

KONTAKTFIGURATION SERIE Y | CONTACTFIGURATION SERIES Y



Soldersided seen		Order-No.	Size	Number of contacts	Contact-ø	Dielectric-ø max.	Conductor-ø max.	Supply voltage ² (kV =) DC	Supply voltage ² (kV ~) AC	Test voltage ³ (kV =) DC	Test voltage ³ (kV ~) AC	Rated current ⁴
Male contact	Female contact											
		405	1	1	1.3	3.2	1.45	7	5.0	10.5	7.5	8
		410	1	1	1.3	3.2	1.45	10	7.0	15.0	10.5	8
		415	3	1	4.5	7.3	2.45	15	10.5	22.5	16.0	15
		430	3	1	4.5	7.3	2.45	30	21.0	45.0	32.0	15
		450	6	1	7.0	23	6.6	50	-	70	-	25

BAUFORM 1Y.3Y-SERIE | MODEL 1Y.3Y-SERIES

Soldersided seen		Order-No.	Size	Number of contacts	Contact-ø	Supply voltage ¹ (kVrms)	Supply voltage ¹ (kV dc)	Supply voltage ² (kVrms)	Supply voltage ² (kV dc)	Test voltage ³ (kVrms)	Test voltage ³ (kV dc)	Rated current ⁴
Male contact	Female contact											
		416	1	1	0.9	11.2	16	16.0	23	25	35	6
		425	3	1	1.6	17.5	25	24.5	35	37	52	8

BAUFORM 0S.1S-SERIE | MODEL 0S.1S-SERIES

		405	0	1	0.7	3.5	5	5.6	8	8.5	12	4
		408	1	1	0.9	5.6	8	8.5	12	12.7	18	6



Part number example see page 3



HOCHSPANNUNG | HIGH VOLTAGE
KONTAKTFIGURATION SERIE B | CONTACTFIGURATION SERIES B

Soldersided seen		Order-No.	Size	Number of contacts	Contact-ø mm	Supply voltage ¹ (kV rms)	Supply voltage ¹ (kV dc)	Supply voltage ² (kV rms)	Supply voltage ² (kV dc)	Test voltage ³ (kV rms)	Test voltage ³ (kV dc)	Rated current ⁴ A
Male contact	Female contact											
		460	4	10	0.9	3.5	5	5.6	8	8.5	12	3
		464	4	4	0.9	5.6	8	8.5	12	12.7	18	4
		467	4	7	0.9	5.6	8	8.5	12	12.7	18	4
		474	5	14	0.9	5.6	8	8.5	12	12.7	18	4
		481	5	21	0.9	5.6	8	8.5	12	12.7	18	4

Test norms:

¹ IEC 130.1 §14.5 a) $U_s = \frac{U_e - 1.5}{2}$

² IEC 130.1 §14.5 b) $U_s = \frac{U_e}{1.5}$

³ MIL

⁴ IEC 512-3





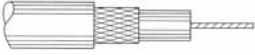

HOCHSPANNUNG | HIGH VOLTAGE
HOCHSPANNUNGSKABEL | HIGH VOLTAGE CABLE

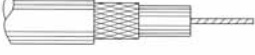

Special LEMO-HV-cables with small outer diameters matching exactly our LEMO-HV-connectors

	Lead Time		Suitable Size	Price	Order-No.
	Stk.	Req.		€/m	
	x	-	0-2	0.41	140 470

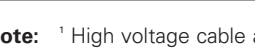
Conductor resistance	Insulation resistance	Operating Voltage U_{max}	Testing Voltage U_{max}	Temperature range		Inner conductor			Insulation		Outer sheath	
				from	to	Mat.	Struct.	Ø	Mat.	Ø	Mat.	Ø
				°C	°C			mm		mm		mm
Ω/km	MΩ/km	kV dc	kV dc									mm
50.0	104	3	5	-15	+70	Cu Sn	7x0.25	0.75	PE wt	2.05	PVC	3.0

	Lead Time		Suitable Size	Price	Order-No.
	Stk.	Req.		€/m	
	x	-	0-2	1.00	150 470
	x	-	1-3	0.87	106 330
	x	-	3-5	1.72	315 650
	x	-	1-4	1.52	130 660
	-	x	1-4	2.22	130666 ¹
	x	-	2-4	7.54	201 340 ¹

Capacitance	Conductor resistance	Insulation resistance	Operating Voltage U_{max}	Testing Voltage U_{max}	Temperature range		Inner conductor			Insulation		Screen		Outer sheath	
					from	to	Mat.	Struct.	Ø	Mat.	Ø	Mat.	Ø	Mat.	Ø
					°C	°C			mm		mm		mm		mm
pF/m	Ω/km	MΩ/km	kV dc	kV dc											mm
83.1	38.2	220	3	6	-5	+70	Cu bl	7x0.25	0.75	PE nat	2.05	Cu bl	2.4	PVCrd	4.0
84.0	77.5	5,000	9	18	-10	+70	Cu bl	14x0.15	0.60	PE nat	2.80	Cu bl	3.5	PVCrd	4.6
85.0	15.0	5,000	18	25	-10	+70	Cu blk	-	1.50	PE nat	6.50	Cu bl	7.3	PVCgr	8.8
82.7	55.8	5,000	30	60	-25	+90	Cu Sn	7x0.25	0.75	PErd	3.90	Cu bl	4.4	PVCrd	5.4 (+0.2 -0.0)
82.7	55.8	5,000	30	60	-25	+90	Cu Sn	7x0.25	0.75	PErd	3.90	Cu bl	4.4	PVCrd	6±0.1
-	56.1	1,000	50	75	-20	+105	Cu Sn	7x0.25	0.75	PE nat	3.15	Cu Sn	5.45	PVCrd	7.25

¹ High voltage cable according to UL-style

¹ Hochspannungskabel gemäß UL-Ausführung



HOCHSPANNUNG | HIGH VOLTAGE KONFEKTIONIERUNGSANLEITUNG | ASSEMBLING INSTRUCTIONS



Reference			Unisolated length (mm)		
Model	Series	Type	A	B	C
FFA	1Y	405	8	28	34
FFA	1Y	405X	8	26	31
PSA	1Y	405	size on request		
PSA	1Y	405X	size on request		
FFA	1Y	410	8	34	40
FFA	1Y	410X	8	34	40
PSA	1Y	410	8	33	40
PSA	1Y	410X	8	33	40
FFA	3Y	415	15	62	72
FFA	3Y	415X	7	32	43
PSA	3Y	415	size on request		
PSA	3Y	415X	size on request		
FFA	3Y	430	14	82	92
FFA	3Y	430X	12	88	95
PSA	3Y	430	8	40	50
PSA	3Y	430X	size on request		

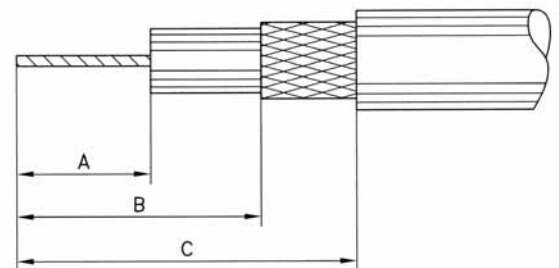

Note: The dimensions are standard values and may vary depending on the cable quality.

Die Abmessungen sind Richtwerte und können sich je nach Kabelqualität ändern.

TECHNISCHE INFORMATIONEN | TECHNICAL INFORMATION

SERIE Y | SERIES Y



Die Hochspannungsserie Y besitzt das LEMO Push-Pull Verriegelungssystem mit hohem Sicherheitsfaktor.	The high voltage Y-series with the LEMO Push-Pull Self Latching Connection System provides high security.
<ul style="list-style-type: none"> Stecker und Buchse sind mit männlichen oder weiblichen Kontakten lieferbar. 	<ul style="list-style-type: none"> Plug and socket are available with male or female contacts.
<ul style="list-style-type: none"> Die Luft- und Kriechstrecken sind nach DIN EN 61010 gewährleistet. 	<ul style="list-style-type: none"> The creepage distance and air clearance are guaranteed according to DIN EN 61010.
<ul style="list-style-type: none"> Einfache Kabelmontage. 	<ul style="list-style-type: none"> Simple cable assembly.
<ul style="list-style-type: none"> Die Serie Y ist für gepulste Spannungen geeignet, auf Wunsch führen wir einen Langzeittest exakt nach Ihren Spannungsverhältnissen durch. 	<ul style="list-style-type: none"> The Y-series is appropriate for pulsed voltage, on request long-term tests are conducted exactly according to your voltage ratio.

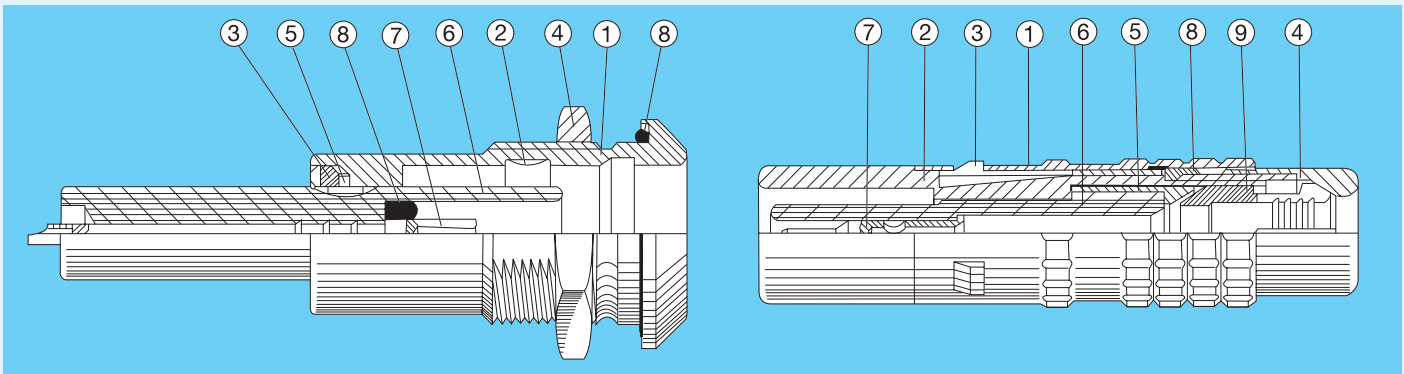

Fixed socket

- 1) outer shell
- 2) earthing crown
- 3) castellated ring
- 4) hexagonal nut
- 5) locking ring
- 6) insulator
- 7) female contact
- 8) sealing ring

Straight plug

- 1) outer shell
- 2) inner shell
- 3) latch sleeve
- 4) collet nut
- 5) centre-piece
- 6) insulator
- 7) male contact
- 8) circlip
- 9) collet

Electrical Datas

Characteristic	Units	Series					Standards	Methode
		1Y.405	1Y.410	3Y.415	3Y.430	6Y.450		
Operating Voltage	kV dc	7	10	15	30	50	IEC 130.1	
	kV eff	5	7	10.5	21	-		
Contact resistance	mΩ	<3	<3	<2	<2	<0.4	MIL-STD-202	307
Insulations resistance	Ω	>10 ¹²					MIL-STD-1344A	3003.1

Mechanical Datas and Temperature Informations

Characteristic	Units	Series			Standards	Methode
		1Y	3Y	6Y		
Contact-pullout strength	N	<24	<60	-	MIL-STD-1344A	2007.1
Cable-tensile strength	N	<300	<550	<800	MIL-STD-1344A	2009.1
Mechanical Lifetime	Cycles	<1000			MIL-STD-1344A	2016
	°C	-55 +230 (-67 °F +446 °F)				

Panel Cut out

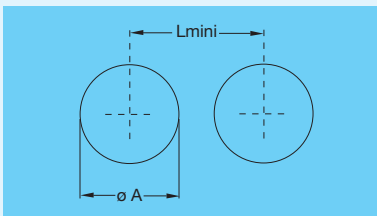

Series	Dimensions (mm)		Torque (Nm)
	øA	L	
1Y	16.1	22.0	14
3Y	24.2	35.5	25
6Y	55.3	67.5	55

Zubehörteile und Werkzeuge siehe Unipole/Multipole Katalog.
Accessories and Tools see Unipole/Multipole Catalogue.

1N = 0.102 Kg

**Steckverbindungen
Connectors
Kontaktfiguration
Contactfiguration
Konfektionierungsanleitung
Assembling Instructions**



**HOCHSPANNUNGSFEST
HIGH VOLTAGE FIRM**

HOCHSPANNUNGSFEST | HIGH VOLTAGE FIRM
BAUFORM S-SERIE | MODEL S-SERIES



FFA Straight plug, cable collet

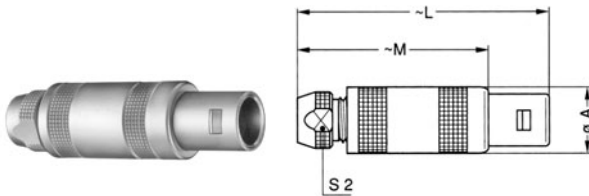

Reference		Dimensions (mm)			
Model	Series	A	L	M	S2
FFA	0S	9.0	34.5	24.5	6.5
FFA	1S ✓	12.0	42.5	31.5	8.5
FFA	2S	14.8	52.0	40.0	11.0
FFA	3S ✓	17.8	61.0	46.0	14.0
FFA	4S ✓	24.8	77.0	59.0	19.0
FFA	5S ✓	35.1	103.0	78.0	29.0

FFA Straight plug with oversize cable collet

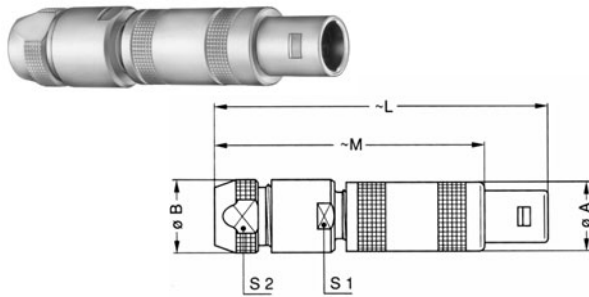

Reference		Dimensions (mm)					
Model	Series	A	B	L	M	S1	S2
FFA	0S ✓	9.0	10.0	45.5	35.5	9.0	8.5
FFA	1S ✓	12.0	13.0	57.0	46.0	12.0	11.0
FFA	2S ✓	14.8	18.0	67.0	55.0	14.0	14.0
FFA	3S ✓	17.8	21.0	85.0	70.0	19.0	19.0
FFA	4S ✓	24.8	31.8	107.0	89.0	28.5	29.0
FFA	5S ✓	35.1	41.8	138.0	113.0	37.5	38.0

Note: the fitting of oversize collets onto this model allows them to be fitted to the cables that can be accommodated by the next housing size up

FFA Straight plug, cable collet and nut for fitting a bend relief

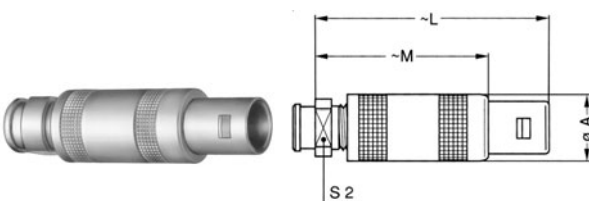

Reference		Dimensions (mm)			
Model	Series	A	L	M	S2
FFA	0S ✓	9.0	34.5	24.5	7
FFA	1S ✓	12.0	42.5	31.5	9
FFA	2S ✓	14.8	52.0	40.0	12
FFA	3S ✓	17.8	61.0	46.0	14
FFA	4S ✓	24.8	77.0	59.0	20

Note: the bend relief must be ordered separately (see page 80)

FFP Straight plug, cable collet and inner anti-rotating device

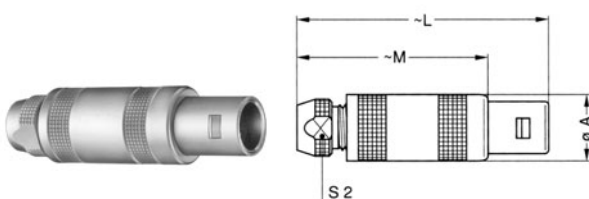

Reference		Dimensions (mm)			
Model	Series	A	L	M	S2
FFP	0S	9.0	34.5	24.5	6.5
FFP	1S	12.0	42.5	31.5	8.5
FFP	2S	14.8	52.0	40.0	11.0
FFP	3S ✓	17.8	61.0	46.0	14.0
FFP	4S	24.8	77.0	59.0	19.0



Part number example see page 3



HOCHSPANNUNGSFEST | HIGH VOLTAGE FIRM BAUFORM S-SERIE | MODEL S-SERIES

FFB Straight plug, cable collet and safety locking ring

Reference		Dimensions (mm)			
Model	Series	A	L	M	S2
FFB	0S ✓	9.0	36.8	26.8	6.5
FFB	1S ✓	12.0	45.0	34.0	8.5
FFB	2S ✓	14.8	55.5	43.5	11.0
FFB	3S ✓	17.8	65.0	50.0	14.0



FFB Straight plug, cable collet and safety locking ring and nut for fitting a bend relief

Reference		Dimensions (mm)			
Model	Series	A	L	M	S2
FFB	0S	9.0	36.8	26.8	7
FFB	1S ✓	12.0	45.0	34.0	9
FFB	2S	14.8	55.5	43.5	12
FFB	3S	17.8	65.0	50.0	14



Note: series 0S, 2S and 3S are available on request
the bend relief must be ordered separately (see page 80)

FZP Straight plug for remote handling, cable collet and inner anti-rotating device

Reference		Dimensions (mm)					
Model	Series	A	L	M	N	S2	S3
FZP	1S	16	42.5	31.5	15	8.5	12
FZP	2S ✓	24	52.0	40.0	21	11.0	18
FZP	3S ✓	24	61.0	46.0	24	14.0	18
FZP	4S	35	77.0	59.0	30	19.0	28
FZP	5S	43	103.0	78.0	44	29.0	35
FZP	6S	60	106.0	81.0	44	38.0	50



FAA Fixed plug non-latching, nut fixing

Reference		Dimensions (mm)									
Model	Series	A	B	e	E	L	L ¹	L ²	M	S1	S3
FAA	0S ✓	10	12.5	M9x0.6	2.0	18.5	18.0	26,3	11.2	8.2	11
FAA	1S ✓	14	16.0	M12x1.0	2.5	22.5	21.7	33,5	12.5	10.5	14
FAA	2S	18	19.5	M15x1.0	4.0	25.0	25.3	43,0	13.8	13.5	17
FAA	3S ✓	22	25.2	M18x1.0	4.0	31.0	29.0	49,0	17.0	16.5	22
FAA	4S	28	32.0	M25x1.0	2.5	35.5	39.0	-	20.5	23.5	30
FAA	5S	40	40.0	M35x1.0	2.5	45.0	-	-	28.0	33.5	-

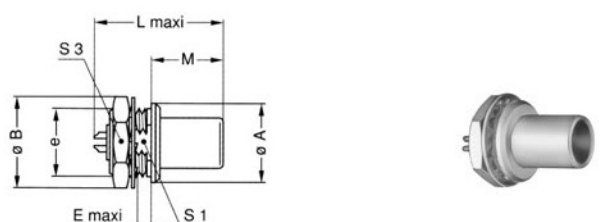

Note: ¹ unipole model
2 high voltage

✓ Bei Lemo vorhanden | available at Lemo

HOCHSPANNUNGSFEST | HIGH VOLTAGE FIRM
BAUFORM S-SERIE | MODEL S-SERIES



FLA Elbow (90°) plug, cable collet

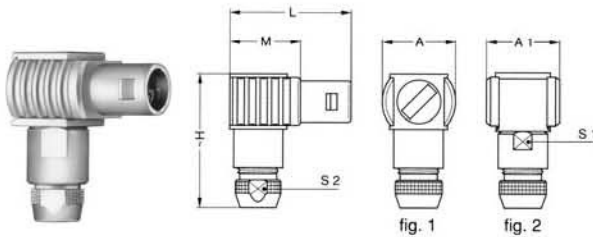

Reference		Dimensions (mm)						
Model	Series	A	A1	H	L	M	S1	S2
FLA	0S ✓	13	13	24.5	23.0	13.0	8	6.5
FLA	1S	16	16	28.5	26.5	15.5	10	8.5
FLA	2S ✓	20	20	37.0	31.0	19.0	13	11.0
FLA	3S ✓	21	21	44.0	38.5	23.5	15	14.0
FLA	4S	28	28	56.0	49.0	31.0	20	19.0
FLA	5S ✓	-	37	76.5	65.0	40.0	30	29.0

Note: fig. 1 is used for the unipole type. fig. 2 is used for the multipole type

ERA Fixed socket, nut fixing

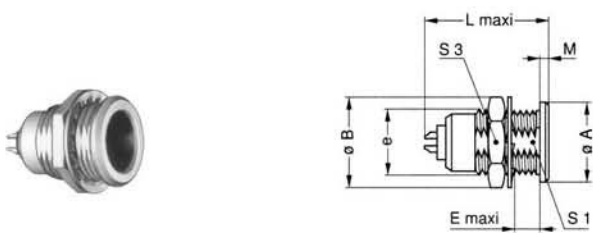

Reference		Dimensions (mm)									
Model	Series	A	B	e	E	L	L'	L ²	M	S1	S3
ERA	0S ✓	10	12.5	M9x0.6	7.0	17.5	18.5	24,6	1.2	8.2	11
ERA	1S ✓	14	16.0	M12x1.0	7.5	20.2	21.5	32,0	1.5	10.5	14
ERA	2S ✓	18	19.5	M15x1.0	8.5	24.5	26.0	41,4	1.8	13.5	17
ERA	3S ✓	22	25.2	M18x1.0	11.5	32.0	30.0	52,0	2.0	16.5	22
ERA	4S ✓	28	32.0	M25x1.0	12.0	34.0	36.0	56,7	2.5	23.5	30
ERA	5S ✓	40	40.0	M35x1.0	15.5	45.0	78.5	-	3.0	33.5	-

Note: the 5S series is delivered with a tapered washer and a round nut.
¹ unipole model
² high voltage

EHP Fixed socket, nut fixing, protruding shell

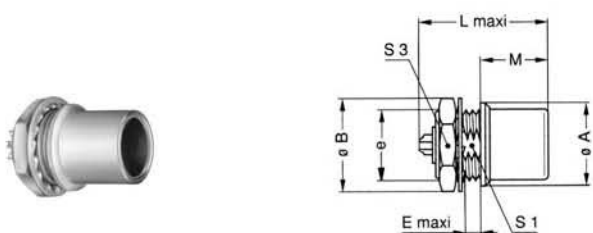

Reference		Dimensions (mm)									
Model	Series	A	B	e	E	L	L'	L ²	M	S1	S3
EHP	0S ✓	10	12.5	M9x0.6	2.5	17.5	18.5	25	12.5	8.2	11
EHP	1S ✓	14	16.0	M12x1.0	3.5	20.2	21.5	32	12.0	-	14
EHP	3S ✓	22	25.2	M18x1.0	4.0	29.0	30.0	52	18.7	-	22

Note: ¹ unipole model
² high voltage



Part number example see page 3



HOCHSPANNUNGFEST | HIGH VOLTAGE FIRM BAUFORM S-SERIE | MODEL S-SERIES

PCA Free socket, cable collet

Reference		Dimensions (mm)		
Model	Series	A	L	S2
PCA	0S ✓	8.9	33.5	6.5
PCA	1S ✓	11.9	40.5	8.5
PCA	2S ✓	14.8	50.0	11.0
PCA	3S ✓	17.8	59.0	14.0
PCA	4S ✓	24.8	75.0	19.0
PCA	5S ✓	34.7	99.0	29.0



PCA Free socket with oversize cable collet

Reference		Dimensions (mm)				
Model	Series	A	B	L	S1	S2
PCA	0S ✓	8.9	10,0	44.5	9.0	8.5
PCA	1S ✓	11.9	13.0	55.0	12.0	11.0
PCA	2S ✓	14.8	18.0	65.0	14.0	14.0
PCA	3S ✓	17.8	21.0	83.0	19.0	19.0
PCA	4S ✓	24.8	31.8	105.0	28.5	29.0



Note: the fitting of oversize collets onto this model allows it to be fitted to the cables that can be accommodated by the next housing size up.

PCA Free socket, cable collet and nut for fitting a bend relief

Reference		Dimensions (mm)		
Model	Series	A	L	S2
PCA	0S ✓	8.9	33.5	7.0
PCA	1S ✓	11.9	40.5	9.0
PCA	2S ✓	14.8	50.0	12.0
PCA	3S ✓	17.8	59.0	14.0
PCA	4S ✓	24.8	75.0	20.0



Note: the bend relief must be ordered separately (see page 80)

PCP Free socket, cable collet and inner anti-rotating device

Reference		Dimensions (mm)		
Model	Series	A	L	S2
PCP	0S ✓	8.9	33.5	6.5
PCP	1S ✓	11.9	40.5	8.5
PCP	2S ✓	14.8	50.0	11.0
PCP	3S ✓	17.8	59.0	14.0
PCP	4S ✓	24.8	75.0	19.0



HOCHSPANNUNGSFEST | HIGH VOLTAGE FIRM
BAUFORM S-SERIE | MODEL S-SERIES



PSA Fixed socket, nut fixing, cable collet



Reference		Dimensions (mm)								
Model	Series	A	B	e	E	L	M	S1	S2	S3
PSA	0S ✓	10	12.5	M9x0.6	7.0	33.5	1.2	8.2	6.5	11
PSA	1S ✓	14	16.0	M12x1.0	7.5	40.5	1.5	10.5	8.5	14
PSA	2S ✓	18	19.5	M15x1.0	8.5	50.0	1.8	13.5	11.0	17
PSA	3S ✓	22	25.2	M18x1.0	11.5	59.0	2.0	16.5	14.0	22
PSA	4S ✓	28	32.0	M25x1.0	12.0	75.0	2.5	27.5	19.0	30
PSA	5S ✓	40	40.0	M35x1.0	15.5	99.0	3.0	33.5	29.0	-

Note: the 5S series is delivered with a tapered washer and a round nut.

PSP Fixed socket, nut fixing, cable collet and inner anti-rotating device



Reference		Dimensions (mm)								
Model	Series	A	B	e	E	L	M	S1	S2	S3
PSP	0S ✓	10	12.5	M9x0.6	7.0	33.5	1.2	8.2	6.5	11
PSP	1S ✓	14	16.0	M12x1.0	7.5	40.5	1.5	10.5	8.5	14
PSP	2S ✓	18	19.5	M15x1.0	8.5	50.0	1.8	13.5	11.0	17
PSP	3S ✓	22	25.2	M18x1.0	11.5	59.0	2.0	16.5	14.0	22
PSP	4S ✓	28	32.0	M25x1.0	12.0	75.0	2.5	23.5	19.0	30

RAD Fixed coupler, nut fixing



Reference		Dimensions (mm)							
Model	Series	A	B	e	E	L	M	S1	S2
RAD	0S ✓	10	12.5	M9x0.6	7.0	25.0	1.2	8.2	11
RAD	1S ✓	14	16.0	M12x1.0	7.5	28.5	1.5	10.5	14
RAD	2S ✓	18	19.5	M15x1.0	8.5	31.5	1.8	13.5	17
RAD	3S ✓	22	25.2	M18x1.0	11.5	38.5	2.0	16.5	22
RAD	4S ✓	28	32.0	M25x1.0	12.0	46.5	2.5	-	30
RAD	5S ✓	40	40.0	M35x1.0	15.5	60.5	3.0	-	-

Note: the 5S series is delivered with a tapered washer and a round nut.

SWH Fixed coupler, nut fixing watertight or vacuumtight



Reference		Dimensions (mm)							
Model	Series	A	B	e	E	L	M	S1	S3
SWH	0S ✓	14	13.8	M10x0.75	17	34	2.0	9.0	12
SWH	1S ✓	17	16.0	M12x1.00	28	39	2.5	10.5	14
SWH	2S ✓	20	21.8	M16x1.00	25	44	4.0	15.0	19
SWH	3S ✓	25	27.0	M20x1.00	30	53	4.0	18.5	24
SWH	4S ✓	34	32.0	M25x1.00	50	65	4.0	23.5	30
SWH	5S ✓	45	40.0	M35x1.00	58	80	5.0	33.5	-

Note: see page 26 for the available plug and contact configurations and in order to ensure correct contact alignment.
 The 5S series is delivered with a round nut.



Part number example see page 3



HOCHSPANNUNGSFEST | HIGH VOLTAGE FIRM BAUFORM E-SERIE | MODEL E-SERIES

FFA Straight plug, cable collet – watertight

Reference		Dimensions (mm)			
Model	Series	A	L	M	S2
FFA	0E ✓	11	34	23.0	8
FFA	1E ✓	13	42	28.0	9
FFA	2E ✓	16	52	36.0	12
FFA	3E ✓	19	61	41.0	15
FFA	4E ✓	25	71	50.5	19
FFA	5E ✓	38	92	67.0	32

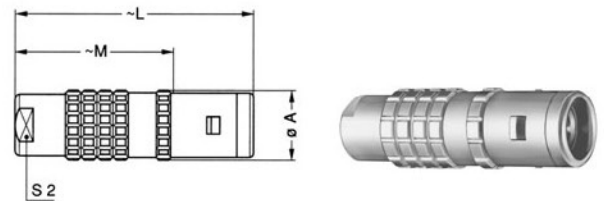

FFA Straight plug with oversize cable collet – watertight

Reference		Dimensions (mm)					
Model	Series	A	B	L	M	S1	S2
FFA	1E ✓	13	14.5	55	41	12	12
FFA	2E ✓	16	17.0	65	49	15	15
FFA	3E ✓	19	22.0	80	60	19	19
FFA	4E ✓	25	36.0	105	84	30	32

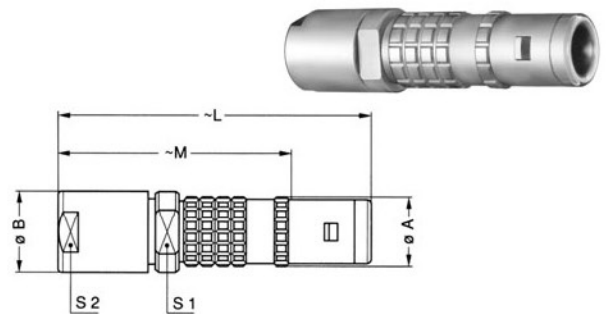

Note: the fitting of oversize collets onto this model allows them to be fitted to the cables that can be accommodated by the next housing size up

FFA Straight plug, cable collet and nut for fitting a bend relief – watertight

Reference		Dimensions (mm)			
Model	Series	A	L	M	S2
FFA	0E ✓	11	34	23.0	7
FFA	1E ✓	13	42	28.0	9
FFA	2E ✓	16	52	36.0	12
FFA	3E ✓	19	60	40.0	15
FFA	4E ✓	25	71	50.5	19

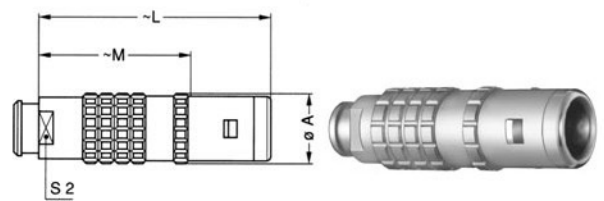

Note: the bend relief must be ordered separately (see page 80)

EBR Fixed socket with round flange, watertight, protruding shell and screw fixing

Reference		Dimensions (mm)									
Model	Series	A	B	C	H1	H2	L	L ¹	L ²	M	N
EBR	2E ✓	28	19	2.8	11.8	20.4	32.5	28.0	-	19	15

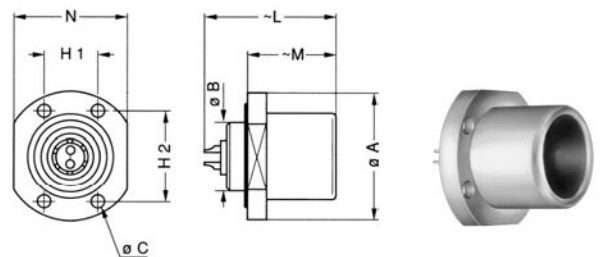

Note: this model is only available in a watertight version
¹ unipole model

2 high voltage on request

✓ Bei Lemo vorhanden | available at Lemo

HOCHSPANNUNGSFEST | HIGH VOLTAGE FIRM
BAUFORM E-SERIE | MODEL E-SERIES



ERA Fixed socket, nut fixing – watertight

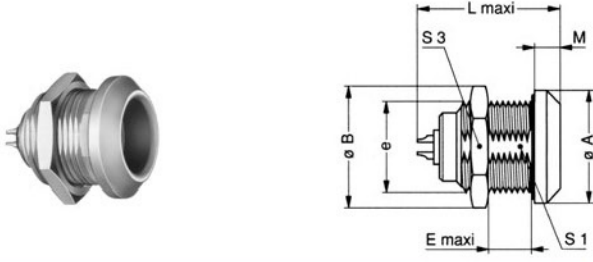

Reference		Dimensions (mm)									
Model	Series	A	B	e	E	L	L ¹	L ²	M	S1	S3
ERA	0E ✓	18	19.5	M14x1.0	7.0	19.5	20.5	26	4.0	12.5	17
ERA	1E ✓	20	21.5	M16x1.0	9.0	24.0	25.3	36	4.5	14.5	19
ERA	2E ✓	25	27.5	M20x1.0	9.0	28.5	30.0	45,8	5.0	18.5	24
ERA	3E ✓	31	34.5	M24x1.0	11.0	34.0	35.0	58	6.0	22.5	30
ERA	4E ✓	37	41.5	M30x1.0	9.0	36.0	38.0	59,7	6.5	28.5	36
ERA	5E ✓	55	54.0	M45x1.5	10.0	44.5	78.0		9.0	42.5	-

Note: the 5E series is delivered with a tapered washer and a round nut
¹unipole model
²high voltage

PCA Free socket, cable collet – watertight

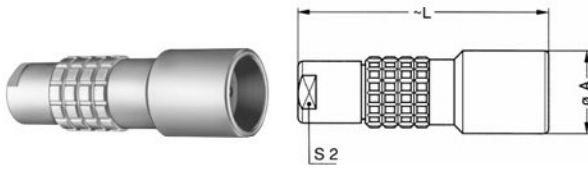

Reference		Dimensions (mm)		
Model	Series	A	L	S2
PCA	0E	13	34.0	8
PCA	1E ✓	15	45.0	9
PCA	2E ✓	19	54.0	12
PCA	3E ✓	23	65.0	15
PCA	4E ✓	29	75.5	19
PCA	5E	42	95.0	32

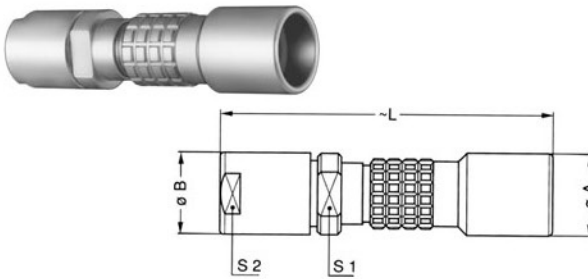

PCA Free socket with oversize cable collet – watertight

Reference		Dimensions (mm)				
Model	Series	A	B	L	S1	S2
PCA	1E ✓	15	14.5	58	12	12
PCA	2E ✓	19	17.0	67	15	15
PCA	3E ✓	23	22.0	84	19	19
PCA	4E ✓	29	36.0	109	30	32

Note: the fitting of oversize collets onto this model allows them to be fitted to the cables that can be accommodated by the next housing size up

PCA Free socket, cable collet and nut for fitting a bend relief – watertight

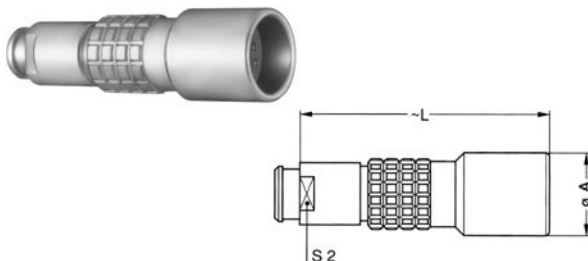

Reference		Dimensions (mm)		
Model	Series	A	L	S2
PCA	0E ✓	13	34.0	7
PCA	1E ✓	15	45.0	9
PCA	2E ✓	19	54.0	12
PCA	3E ✓	23	64.0	15
PCA	4E ✓	29	75.5	19

Note: the bend relief must be ordered separately (see page 80)



Part number example see page 3



HOCHSPANNUNGSFEST | HIGH VOLTAGE FIRM BAUFORM E-SERIE | MODEL E-SERIES

RMA Free coupler – watertight

Reference		Dimensions (mm)	
Model	Series	A	L
RMA	0E ✓	14	30
RMA	1E ✓	16	40
RMA	2E ✓	20	44
RMA	3E	25	54
RMA	4E ✓	30	57
RMA	5E	44	67

Note: see page 26 for the available plug and contact configurations and in order to ensure correct contact alignment

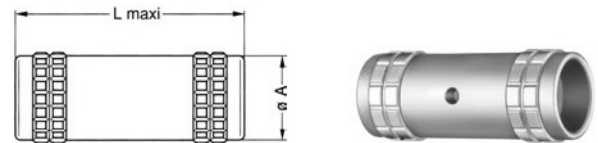

SWH Fixed coupler, nut fixing, watertight and vacuumtight

Reference		Dimensions (mm)							
Model	Series	A	B	ø	E	L	M	S1	S3
SWH	0E	18	19.5	M14x1.0	21	36.0	4.0	12.5	17
SWH	1E ✓	20	21.5	M16x1.0	29	47.0	4.5	14.5	19
SWH	2E	25	27.5	M20x1.0	28	52.5	5.0	18.5	24
SWH	3E	31	34.5	M24x1.0	33	64.0	6.0	22.5	30
SWH	4E	37	41.5	M30x1.0	43	70.0	6.5	28.5	36
SWH	5E ✓	55	54.0	M45x1.5	45	81.0	9.0	42.5	-

Note: The 5E series are delivered with a round nut. See page 26 for the available plug and contact configurations and in order to ensure correct contact alignment.

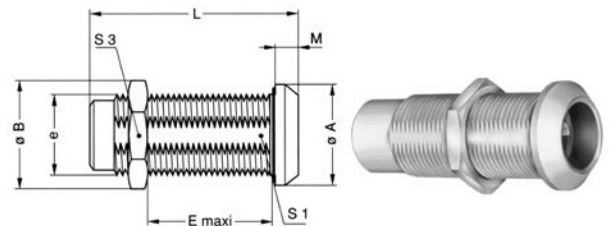

HGP Fixed socket, nut fixing, watertight and vacuumtight

Reference		Dimensions (mm)									
Model	Series	A	B	ø	E	L	L'	L ²	M	S1	S3
HGP	0E	18	19.5	M14x1.0	7.0	23.5	22.0	26,2	4.0	12.5	17
HGP	1E	20	21.5	M16x1.0	9.0	28.0	28.0	33,9	4.5	14.5	19
HGP	2E	25	27.5	M20x1.0	10.5	32.5	28.0	45,7	5.0	18.5	24
HGP	3E	31	34.5	M24x1.0	15.5	39.5	38.5	64,7	6.0	22.5	30
HGP	4E ✓	37	41.5	M30x1.0	17.5	43.0	44.0		6.5	28.5	36
HGP	5E ✓	55	54.0	M45x1.5	20.0	52.0	76.0		9.0	42.5	-

Note: the 5E series are delivered with a round nut
 1 unipole model
 2 high voltage

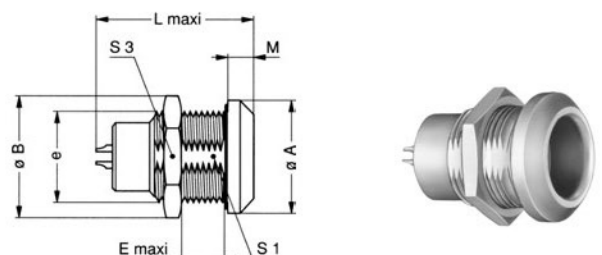

✓ Bei Lemo vorhanden | available at Lemo

HOCHSPANNUNGSFEST | HIGH VOLTAGE FIRM
KONTAKTFIGURATION SERIE S+E | CONTACTFIGURATION SERIES S+E

Soldersided seen		Order-No.	Size	Impedance	Contact- ϕ	Max. conductor- ϕ	Valid current	Supply voltage U_s (kV dc)		Test voltage U_e (kV dc)		Cable-order-no.	Type of insulation	Delivery time
Male contact	Female contact							K-K	K-M	K-K	K-M			
		403	0	-	0.9	0.8	4	-	4	-	6	RG-174A/U	high voltage	●
		405	1	-	1.35	1.1	8	-	7	-	10.5	106 330	high voltage	●
		405X	1	-	1.35	1.1	10	-	7	-	10.5	106 330	high voltage	●
		408	2	-	2	1.8	10	-	8	-	12.0	130 660	high voltage	●
		408X	2	-	2	1.8	10	-	8	-	12.0	130 660	high voltage	●
		405	3	-	4	3.5	15	-	7	-	10.6	130 660	high voltage	●
		410	3	-	2	1.8	10	-	10	-	15.0	130 660	high voltage	●
		410X	3	-	2	1.8	6	-	10	-	15.0	130 660	high voltage	●
		415	3	-	1.3	1.0	8	-	15	-	21.0	130 660	high voltage	●
		415X	3	-	1.3	1.0	2	-	15	-	21.0	210 440	high voltage	●
		432	3	-	1.3	1.0	3	3	3	4.5 ¹ 8	4.5 8	on request	high voltage	●
		410	4	-	2.5	3.2	12	-	10	-	15	on request	high voltage	◐
		433	4	-	2	1.8	14	2.1	3	3.1 ¹ 8	4.5 8	on request	high voltage	◐
		434	4	-	2	1.8	14	2.1	3	3.1 ¹ 8	4.5 8	on request	high voltage	◐
		442	4	-	1.3	1	14	3.5	5.0	5.2 ¹ 14	7.5 14	on request	high voltage	◐

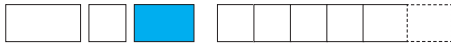

Part number example see page 3



HOCHSPANNUNGSFEST | HIGH VOLTAGE FIRM

KONTAKTFIGURATION SERIE S+E | CONTACTFIGURATION SERIES S+E

Soldersided seen		Order-No.	Size	Impedance	Contact- ϕ	Max. conductor- ϕ	Valid current	Supply voltage U_s (kV dc)		Test voltage U_e (kV dc)		Cable-order-no.	Type of insulation	Delivery time
Male contact	Female contact							K-K	K-M	K-K	K-M			
		442	5	-	2	1.8	20	3.5	5.0	5.2 ¹ 14	7.5 14	on request	high voltage	○
		438	5	-	2	1.8	18	2.1	3.0	3.1 ¹ 14	10.5 14	on request	high voltage	○
		443	5	-	2	1.8	20	3.5	5.0	5.2 ¹ 14	7.5 14	on request	high voltage	○
		444	5	-	2	1.8	18	3.5	5.0	5.2 ¹ 14	7.5 14	on request	high voltage	○

Note: ¹ Test nach CEI 130.1 § 14.5b $U_s = \frac{U_e}{1.5}$



Reference			Contact ø (mm)	Unisolated length (mm)		
Series	Type	Cable		A	B	C
0S/0E	403	HS	0.9	4.0	6.0	9.0
0S/0E	403X	HS	0.9	4.0	6.0	9.0
1S/1E	405	HS	1.35	5.0	10.5	14.0
1S/1E	405X	HS	1.35	5.0	10.5	14.0
2S/2E	408	HS	2.0	7.0	14.0	18.0
2S/2E	408X	HS	2.0	7.0	14.0	18.0
3S/3E	405	HS	4.0	6.5	12.0	17.0
3S/3E	405X	HS	4.0	6.5	12.0	17.0
3S/3E	410	HS	2.0	7.5	19.0	24.0
3S/3E	410X	HS	2.0	7.5	19.0	24.0
3S/3E	415	HS	1.3	6.5	27.0	32.0
3S/3E	415X	HS	1.3	6.5	27.0	32.0
4S/4E	410	HS	2.5	10.0	20.0	26.0
4S/4E	410X	HS	2.5	10.0	20.0	26.0



Note: The dimensions are standard values and may vary depending on the cable quality.

Die Abmessungen sind Richtwerte und können sich je nach Kabelqualität ändern.

The background features a technical drawing of a high-current connector assembly in white lines on a blue background. A large, stylized lightning bolt graphic is positioned on the right side, extending from the top towards the bottom. The drawing shows various components like a grid, a cylindrical part, and a multi-pin connector.

Steckverbindungen
Connectors
Kontaktfiguration
Contactfiguration
Konfektionierungsanleitung
Assembling Instructions



EINPOLIG HOCHSTROM
UNIPOLE HIGH CURRENT

EINPOLIG / HOCHSTROM | UNIPOLE / HIGH CURRENT
BAUFORM S-SERIE | MODEL S-SERIES



FFA Straight plug, cable collet



Reference		Dimensions (mm)			
Model	Series	A	L	M	S2
FFA	00 ✓	6.4	26.0	18.0	4.5
FFA	0S ✓	9.0	34.5	24.5	6.5
FFA	1S ✓	12.0	42.5	31.5	8.5
FFA	2S ✓	14.8	52.0	40.0	11.0
FFA	3S ✓	17.8	61.0	46.0	14.0
FFA	4S ✓	24.8	77.0	59.0	19.0
FFA	5S ✓	35.1	103.0	78.0	29.0

FFA Straight plug with oversize cable collet

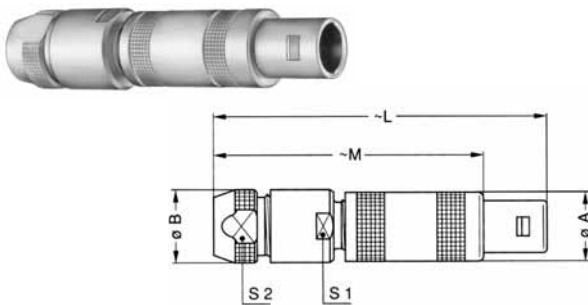

Reference		Dimensions (mm)					
Model	Series	A	B	L	M	S1	S2
FFA	00 ✓	6.4	8.0	34.0	26.0	7.0	6.5
FFA	0S ✓	9.0	10.0	45.5	35.5	9.0	8.5
FFA	1S ✓	12.0	13.0	57.0	46.0	12.0	11.0
FFA	2S ✓	14.8	18.0	67.0	55.0	14.0	14.0
FFA	3S ✓	17.8	21.0	85.0	70.0	19.0	19.0
FFA	4S ✓	24.8	31.8	107.0	89.0	28.5	29.0
FFA	5S ✓	35.1	41.8	138.0	113.0	37.5	38.0

Note: the fitting of oversize collets onto this model allows them to be fitted to the cables that can be accommodated by the next housing size up

FFA Straight plug, cable collet
and nut for fitting a bend relief

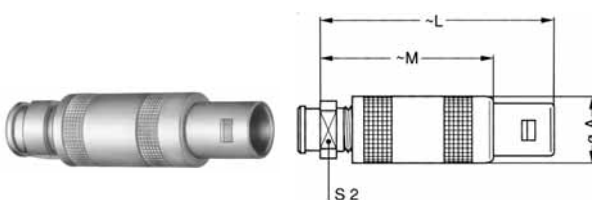

Reference		Dimensions (mm)			
Model	Series	A	L	M	S2
FFA	00 ✓	6.4	26.0	18.0	6
FFA	0S ✓	9.0	34.5	24.5	7
FFA	1S ✓	12.0	42.5	31.5	9
FFA	2S ✓	14.8	52.0	40.0	12
FFA	3S ✓	17.8	61.0	46.0	14
FFA	4S ✓	24.8	77.0	59.0	20

Note: the bend relief must be ordered separately (see page 80)



Part number example see page 3



EINPOLIG / HOCHSTROM | UNIPOLE / HIGH CURRENT
BAUFORM S-SERIE | MODEL S-SERIES

FFP Straight plug, cable collet and inner anti-rotating device

Reference		Dimensions (mm)			
Model	Series	A	L	M	S2
FFP	0S	9.0	34.5	24.5	6.5
FFP	1S	12.0	42.5	31.5	8.5
FFP	2S	14.8	52.0	40.0	11.0
FFP	3S ✓	17.8	61.0	46.0	14.0
FFP	4S	24.8	77.0	59.0	19.0



FFB Straight plug, cable collet and safety locking ring

Reference		Dimensions (mm)			
Model	Series	A	L	M	S2
FFB	0S	9.0	36.8	26.8	6.5
FFB	1S ✓	12.0	45.0	34.0	8.5
FFB	2S	14.8	55.5	43.5	11.0
FFB	3S ✓	17.8	65.0	50.0	14.0



FFB Straight plug, cable collet and safety locking ring and nut for fitting a bend relief

Reference		Dimensions (mm)			
Model	Series	A	L	M	S2
FFB	0S	9.0	36.8	26.8	7
FFB	1S ✓	12.0	45.0	34.0	9
FFB	2S	14.8	55.5	43.5	12
FFB	3S	17.8	65.0	50.0	14

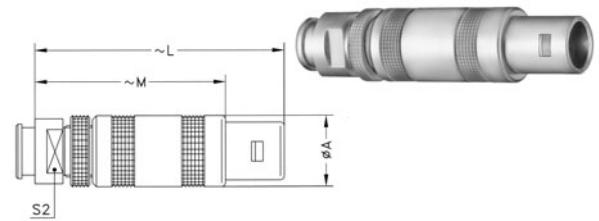

Note: series 0S, 2S and 3S are available on request
the bend relief must be ordered separately (see page 80)

FFF Straight plug, non-latching, cable collet

Reference		Dimensions (mm)			
Model	Series	A	L	M	S2
FFF	00 ✓	6.4	26.0	18.0	4.5
FFF	0S ✓	9.0	34.5	24.5	6.5
FFF	1S	12.0	42.5	31.5	8.5
FFF	2S	14.8	52.0	40.0	11.0



EINPOLIG / HOCHSTROM | UNIPOLE / HIGH CURRENT
BAUFORM S-SERIE | MODEL S-SERIES

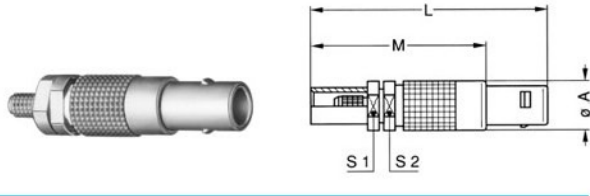

FFS Straight plug for cable crimping

Reference		Dimensions (mm)				
Model	Series	A	L	M	S1	S2
FFS	00 ✓	6.4	31	23	5.5	5.5

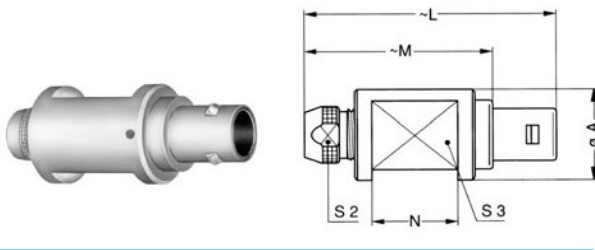

FZP Straight plug for remote handling, cable collet and inner anti-rotating device

Reference		Dimensions (mm)					
Model	Series	A	L	M	N	S2	S3
FZP	1S	16	42.5	31.5	15	8.5	12
FZP	2S	24	52.0	40.0	21	11.0	18
FZP	3S	24	61.0	46.0	24	14.0	18
FZP	4S	35	77.0	59.0	30	19.0	28
FZP	5S ✓	43	103.0	78.0	44	29.0	35

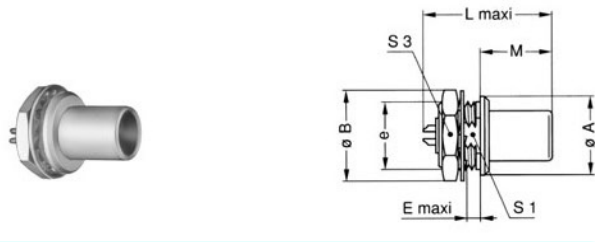

FAA Fixed plug non-latching, nut fixing

Reference		Dimensions (mm)							
Model	Series	A	B	e	E	L'	M	S1	S3
FAA	00 ✓	8	10.3	M7x0.5	2.0	15.5	9.0	6.3	9
FAA	0S ✓	10	12.5	M9x0.6	2.0	18.0	11.2	8.2	11
FAA	1S ✓	14	16.0	M12x1.0	2.5	21.7	12.5	10.5	14
FAA	2S ✓	18	19.5	M15x1.0	4.0	25.3	13.8	13.5	17
FAA	3S ✓	22	25.2	M18x1.0	4.0	29.0	17.0	16.5	22
FAA	4S ✓	28	32.0	M25x1.0	2.5	39.0	20.5	23.5	30
FAA	5S	40	40.0	M35x1.0	2.5	-	28.0	33.5	-

Note: ¹unipole model

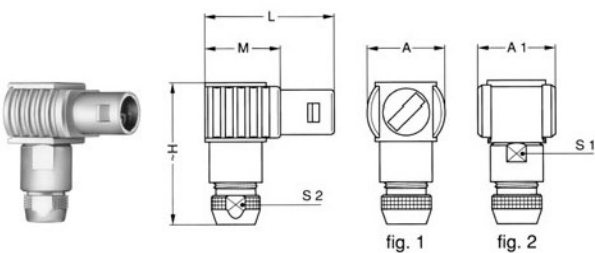

FLA Elbow (90°) plug, cable collet

Reference		Dimensions (mm)						
Model	Series	A	A1	H	L	M	S1	S2
FLA	00 ✓	9	-	16.0	17.5	9.5	-	4.5
FLA	0S ✓	13	13	24.5	23.0	13.0	8	6.5
FLA	1S ✓	16	16	28.5	26.5	15.5	10	8.5
FLA	2S ✓	20	20	37.0	31.0	19.0	13	11.0
FLA	3S ✓	21	21	44.0	38.5	23.5	15	14.0
FLA	4S ✓	28	28	56.0	49.0	31.0	20	19.0
FLA	5S	-	37	76.5	65.0	40.0	30	29.0

Note: fig.1 is used for the unipole type, fig.2 is used for the multipole type



Part number example see page 3



EINPOLIG / HOCHSTROM | UNIPOLE / HIGH CURRENT
BAUFORM S-SERIE | MODEL S-SERIES

FLS Elbow (90°) plug for cable crimping

Reference		Dimensions (mm)			
Model	Series	A	H	L	M
FLS	00 ✓	9	16	17.5	9.5

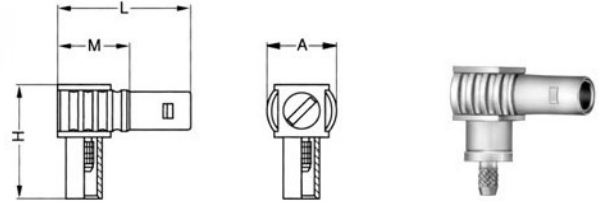

ERA Fixed socket, nut fixing

Reference		Dimensions (mm)							
Model	Series	A	B	e	E	L'	M	S1	S3
ERA	00 ✓	8	10.3	M7x0.5	5.5	15.2	1.0	6.3	9
ERA	0S ✓	10	12.5	M9x0.6	7.0	18.5	1.2	8.2	11
ERA	1S ✓	14	16.0	M12x1.0	7.5	21.5	1.5	10.5	14
ERA	2S ✓	18	19.5	M15x1.0	8.5	26.0	1.8	13.5	17
ERA	3S ✓	22	25.2	M18x1.0	11.5	30.0	2.0	16.5	22
ERA	4S ✓	28	32.0	M25x1.0	12.0	36.0	2.5	23.5	30
ERA	5S ✓	40	40.0	M35x1.0	15.5	78.5	3.0	33.5	-

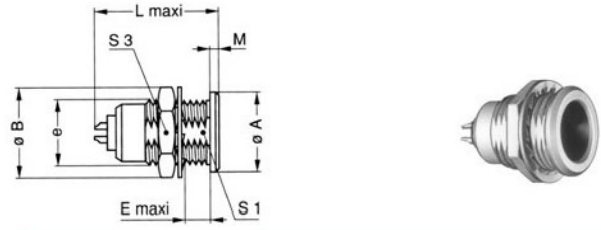

Note: the 5S series is delivered with a tapered washer and a round nut
 *unipole model

ERN Fixed socket, nut fixing, with earthing tag

Reference		Dimensions (mm)							
Model	Series	A	B	e	E	L'	M	S1	S3
ERN	0S ✓	10	12.5	M9x0.6	7.0	19.3	1.2	8.2	11
ERN	1S ✓	14	16.0	M12x1.0	7.5	23.0	1.5	10.5	14
ERN	2S ✓	18	19.5	M15x1.0	8.5	26.3	1.8	13.5	17
ERN	3S ✓	22	25.2	M18x1.0	11.5	30.0	2.0	16.5	22

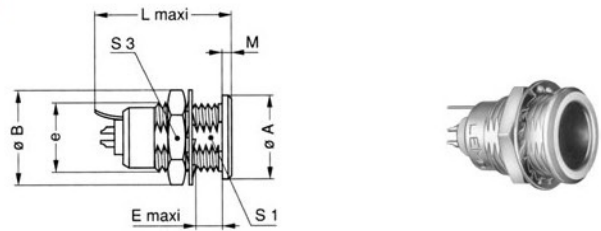

Note: *unipole model

ERC Fixed socket, nut fixing with slot in the flange

Reference		Dimensions (mm)								
Model	Series	A	B	e	E	F	L'	M	S1	S3
ERC	00 ✓	8	10.3	M7x0.5	5.5	1.6	15.1	1.0	6.3	9
ERC	0S	10	12.5	M9x0.6	7.0	2.0	18.5	1.2	8.2	11
ERC	1S	14	16.0	M12x1.0	7.5	2.5	21.5	1.5	10.5	14

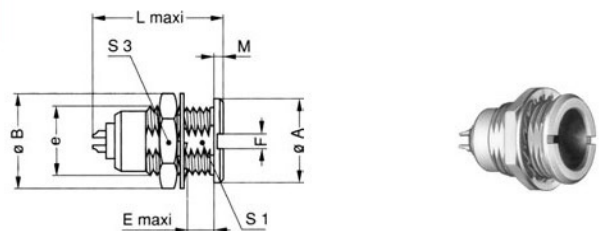

Note: *unipole model

EINPOLIG / HOCHSTROM | UNIPOLE / HIGH CURRENT
BAUFORM S-SERIE | MODEL S-SERIES

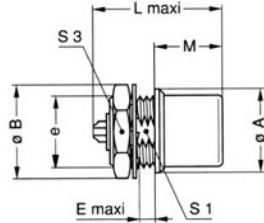

EHP Fixed socket, nut fixing, protruding shell

Reference		Dimensions (mm)							
Model	Series	A	B	e	E	L'	M	S1	S3
EHP	0S ✓	10	12.5	M9x0.6	2.5	18.5	12.5	8.2	11
EHP	1S	14	16.0	M12x1.0	3.5	21.5	12.0	-	14
EHP	3S ✓	22	25.2	M18x1.0	4.0	30.0	18.7	-	22

Note: ¹unipole model

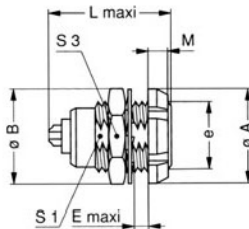

**ERD Fixed socket with two nuts
(back panel mounting)**

Reference		Dimensions (mm)							
Model	Series	A	B	e	E	L'	M	S1	S3
ERD	0S ✓	12	12.5	M9x0.6	5.5	18.5	2.5	8.2	11
ERD	1S ✓	16	16.0	M12x1.0	6.0	21.5	3.5	10.5	14
ERD	2S ✓	20	19.5	M15x1.0	6.5	26.0	3.5	13.5	17
ERD	3S	24	25.2	M18x1.0	9.0	30.0	4.5	16.5	22
ERD	4S	30	32.0	M25x1.0	10.0	36.0	4.5	23.5	30

Note: the 3S and 4S series are delivered with a conical nut
¹unipole model

RMA Free coupler

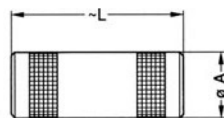
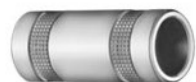

Reference		Dimensions (mm)	
Model	Series	A	L
RMA	00 ✓	6.4	22.0
RMA	0S ✓	8.9	25.0
RMA	1S	11.9	28.5
RMA	2S	14.8	31.5
RMA	3S ✓	17.8	38.5
RMA	4S ✓	24.8	46.5
RMA	5S	34.7	60.5

Note: see page 40 for the available plug and contact configurations and in order to ensure correct contact alignment



Part number example see page 3



EINPOLIG / HOCHSTROM | UNIPOLE / HIGH CURRENT
BAUFORM S-SERIE | MODEL S-SERIES

RAD Fixed coupler, nut fixing

Reference		Dimensions (mm)							
Model	Series	A	B	e	E	L	M	S1	S2
RAD	00 ✓	8	10.3	M7x0.5	5.5	22.0	1.0	6.3	9
RAD	0S	10	12.5	M9x0.6	7.0	25.0	1.2	8.2	11
RAD	1S	14	16.0	M12x1.0	7.5	28.5	1.5	10.5	14
RAD	2S	18	19.5	M15x1.0	8.5	31.5	1.8	13.5	17
RAD	3S	22	25.2	M18x1.0	11.5	38.5	2.0	16.5	22
RAD	4S ✓	28	32.0	M25x1.0	12.0	46.5	2.5	-	30
RAD	5S	40	40.0	M35x1.0	15.5	60.5	3.0	-	-

Note: the 5S series is delivered with a tapered washer and a round nut see page 40 for the available plug and contact configurations and in order to ensure correct contact alignment



SWH Fixed coupler, nut fixing watertight or vacuumtight

Reference		Dimensions (mm)							
Model	Series	A	B	e	E	L	M	S1	S3
SWH	0S ✓	14	13.8	M10x0.75	17	34	2.0	9.0	12
SWH	1S ✓	17	16.0	M12x1.00	28	39	2.5	10.5	14
SWH	2S ✓	20	21.8	M16x1.00	25	44	4.0	15.0	19
SWH	3S ✓	25	27.0	M20x1.00	30	53	4.0	18.5	24
SWH	4S ✓	34	32.0	M25x1.00	50	65	4.0	23.5	30
SWH	5S ✓	45	40.0	M35x1.00	58	80	5.0	33.5	-

Note: see page 40 for the available plug and contact configurations and in order to ensure correct contact alignment. The 5S series is delivered with a round nut.



PCA Free socket, cable collet

Reference		Dimensions (mm)		
Model	Series	A	L	S2
PCA	00 ✓	6.5	25.0	4.5
PCA	0S ✓	8.9	33.5	6.5
PCA	1S ✓	11.9	40.5	8.5
PCA	2S	14.8	50.0	11.0
PCA	3S ✓	17.8	59.0	14.0
PCA	4S ✓	24.8	75.0	19.0
PCA	5S	34.7	99.0	29.0



PCA Free socket with oversize cable collet

Reference		Dimensions (mm)				
Model	Series	A	B	L	S1	S2
PCA	00 ✓	6.5	8.0	33.0	7.0	6.5
PCA	0S ✓	8.9	10.0	44.5	9.0	8.5
PCA	1S ✓	11.9	13.0	55.0	12.0	11.0
PCA	2S ✓	14.8	18.0	65.0	14.0	14.0
PCA	3S ✓	17.8	21.0	83.0	19.0	19.0
PCA	4S ✓	24.8	31.8	105.0	28.5	29.0

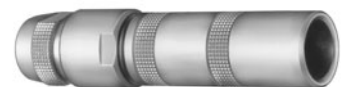
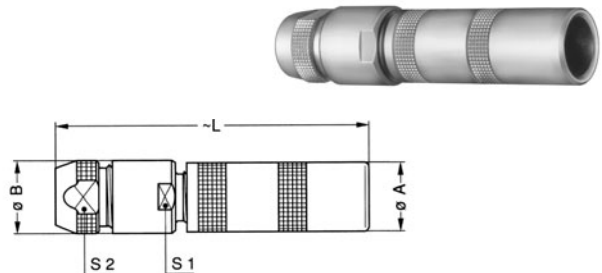

Note: the fitting of oversize collets onto this model allows them to be fitted to the cables that can be accommodated by the next housing size up

✓ Bei Lemo vorhanden | available at Lemo

EINPOLIG / HOCHSTROM | UNIPOLE / HIGH CURRENT
BAUFORM S-SERIE | MODEL S-SERIES



PCA Free socket, cable collet and nut for fitting a bend relief

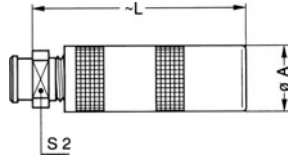

Reference		Dimensions (mm)		
Model	Series	A	L	S2
PCA	00 ✓	6.5	25.0	6
PCA	0S ✓	8.9	33.5	7
PCA	1S ✓	11.9	40.5	9
PCA	2S ✓	14.8	50.0	12
PCA	3S ✓	17.8	59.0	14
PCA	4S ✓	24.8	75.0	20

Note: the bend relief must be ordered separately (see page 80)

PSA Fixed socket, nut fixing, cable collet

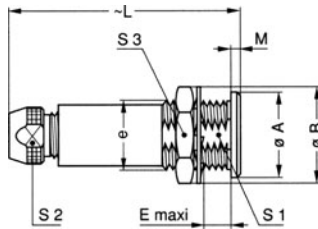

Reference		Dimensions (mm)								
Model	Series	A	B	e	E	L	M	S1	S2	S3
PSA	00 ✓	8	10.3	M7x0.5	5.5	25.0	1.0	6.3	4.5	9
PSA	0S ✓	10	12.5	M9x0.6	7.0	33.5	1.2	8.2	6.5	11
PSA	1S ✓	14	16.0	M12x1.0	7.5	40.5	1.5	10.5	8.5	14
PSA	2S ✓	18	19.5	M15x1.0	8.5	50.0	1.8	13.5	11.0	17
PSA	3S ✓	22	25.2	M18x1.0	11.5	59.0	2.0	16.5	14.0	22
PSA	4S ✓	28	32.0	M25x1.0	12.0	75.0	2.5	23.5	19.0	30
PSA	5S ✓	40	40.0	M35x1.0	15.5	99.0	3.0	33.5	29.0	-

Note: the 5S series is delivered with a tapered washer and a round nut.

BAUFORM E-SERIE | MODEL E-SERIES

FFA Straight plug, cable collet – watertight

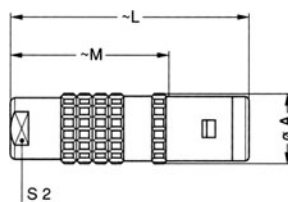

Reference		Dimensions (mm)			
Model	Series	A	L	M	S2
FFA	0E ✓	11	34	23.0	8
FFA	1E ✓	13	42	28.0	9
FFA	2E ✓	16	52	36.0	12
FFA	3E ✓	19	61	41.0	15
FFA	4E ✓	25	71	50.5	19
FFA	5E ✓	38	92	67.0	32



Part number example see page 3



EINPOLIG / HOCHSTROM | UNIPOLE / HIGH CURRENT
BAUFORM E-SERIE | MODEL E-SERIES

FFA Straight plug with oversize cable collet – watertight

Reference		Dimensions (mm)					
Model	Series	A	B	L	M	S1	S2
FFA	1E ✓	13	14.5	55	41	12	12
FFA	2E ✓	16	17.0	65	49	15	15
FFA	3E ✓	19	22.0	80	60	19	19
FFA	4E ✓	25	36.0	105	84	30	32

Note: the fitting of oversize collets onto this model allows them to be fitted to the cables that can be accommodated by the next housing size up

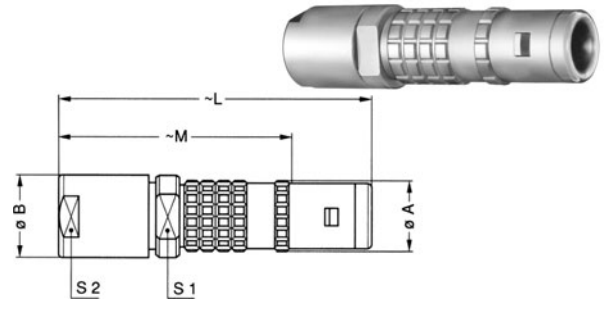

FFA Straight plug, cable collet and nut for fitting a bend relief – watertight

Reference		Dimensions (mm)			
Model	Series	A	L	M	S2
FFA	0E ✓	11	34	23.0	7
FFA	1E ✓	13	42	28.0	9
FFA	2E ✓	16	52	36.0	12
FFA	3E ✓	19	60	40.0	15
FFA	4E ✓	25	71	50.5	19

Note: the bend relief must be ordered separately (see page 80)



FFF Straight plug non-latching, cable collet – watertight

Reference		Dimensions (mm)			
Model	Series	A	L	M	S2
FFF	0E	11	34	23	8
FFF	1E ✓	13	42	28	9

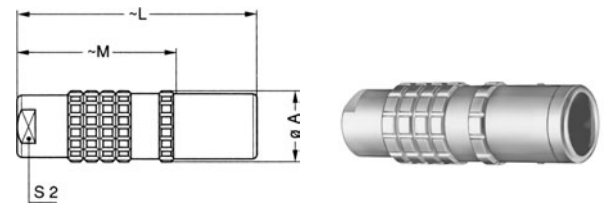

FLA Elbow (90°) plug, cable collet – watertight

Reference		Dimensions (mm)							
Model	Series	A	D	H	L	M	S1	S2	S3
FLA	0E	11.5	7.6	27	36	25.0	10	8	8
FLA	1E	14.0	8.8	33	43	29.0	12	9	10
FLA	2E	17.5	10.5	40	51	35.0	15	12	13
FLA	3E ✓	21.0	11.5	47	60	40.0	18	15	15
FLA	4E	27.5	15.5	57	72	51.5	24	19	20

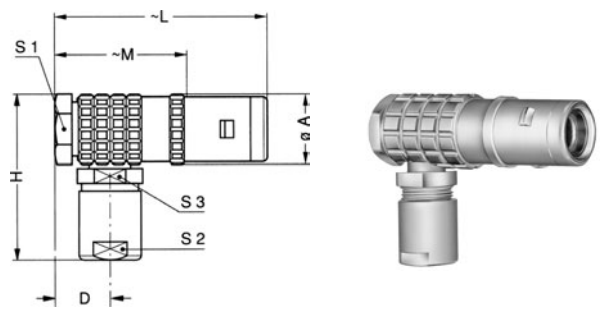

EINPOLIG / HOCHSTROM | UNIPOLE / HIGH CURRENT
BAUFORM E-SERIE | MODEL E-SERIES

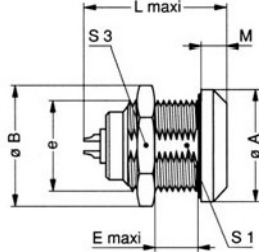

ERA Fixed socket, nut fixing – watertight

Reference		Dimensions (mm)							
Model	Series	A	B	e	E	L'	M	S1	S3
ERA	0E ✓	18	19.5	M14x1.0	7	20.5	4.0	12.5	17
ERA	1E ✓	20	21.5	M16x1.0	9	25.3	4.5	14.5	19
ERA	2E ✓	25	27.5	M20x1.0	9	30.0	5.0	18.5	24
ERA	3E ✓	31	34.5	M24x1.0	11	35.0	6.0	22.5	30
ERA	4E ✓	37	41.5	M30x1.0	9	38.0	6.5	28.5	36
ERA	5E ✓	55	54.0	M45x1.5	10	78.0	9.0	42.5	-

Note: the 5E series is delivered with a round nut
 1 unipole model

PCA Free socket, cable collet – watertight

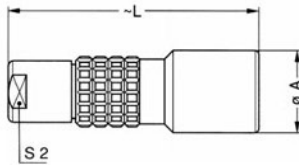
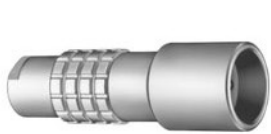

Reference		Dimensions (mm)		
Model	Series	A	L	S2
PCA	0E ✓	13	34.0	8
PCA	1E ✓	15	45.0	9
PCA	2E ✓	19	54.0	12
PCA	3E ✓	23	65.0	15
PCA	4E	29	75.5	19
PCA	5E	42	95.0	32

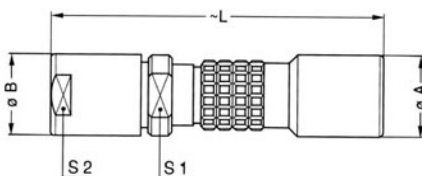

PCA Free socket with oversize cable collet – watertight

Reference		Dimensions (mm)				
Model	Series	A	B	L	S1	S2
PCA	1E ✓	15	14.5	58	12	12
PCA	2E ✓	19	17.0	67	15	15
PCA	3E ✓	23	22.0	84	19	19
PCA	4E ✓	29	36.0	109	30	32

Note: the fitting of oversize collets onto this model allows them to be fitted to the cables that can be accommodated by the next housing size up



Part number example see page 3



EINPOLIG / HOCHSTROM | UNIPOLE / HIGH CURRENT
BAUFORM E-SERIE | MODEL E-SERIES

PCA Free socket, cable collet and nut for fitting a bend relief – watertight

Reference		Dimensions (mm)		
Model	Series	A	L	S2
PCA	0E ✓	13	34.0	7
PCA	1E ✓	15	45.0	9
PCA	2E ✓	19	54.0	12
PCA	3E ✓	23	64.0	15
PCA	4E ✓	29	75.5	19

Note: the bend relief must be ordered separately (see page 80)

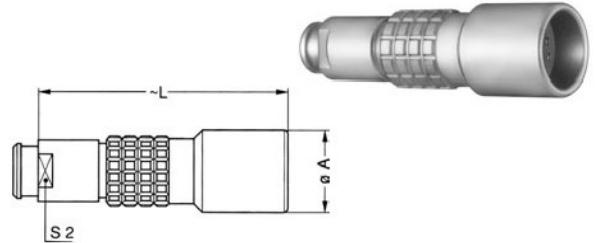

HGP Fixed socket, nut fixing, watertight and vacuumtight

Reference		Dimensions (mm)							
Model	Series	A	B	ø	E	L'	M	S1	S3
HGP	0E ✓	18	19.5	M14x1.0	7.0	22.0	4.0	12.5	17
HGP	1E ✓	20	21.5	M16x1.0	9.0	28.0	4.5	14.5	19
HGP	2E	25	27.5	M20x1.0	10.5	28.0	5.0	18.5	24
HGP	3E	31	34.5	M24x1.0	15.5	38.5	6.0	22.5	30
HGP	4E	37	41.5	M30x1.0	17.5	44.0	6.5	28.5	36
HGP	5E	55	54.0	M45x1.5	20.0	76.0	9.0	42.5	-

Note: the 5E series is delivered with a round nut
 'unipole model

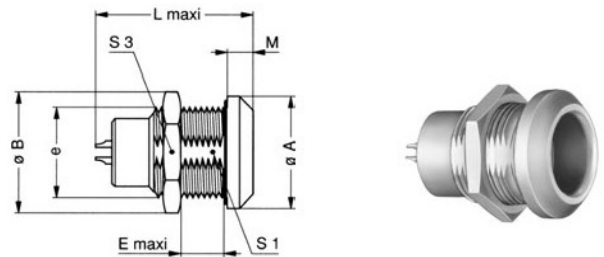

EINPOLIG / HOCHSTROM | UNIPOLE / HIGH CURRENT
KONTAKTFIGURATION SERIE E+S | CONTACTFIGURATION SERIES E+S

Soldersided seen		Order-No.	Size	Impedance Ω	Contact-ø (øA) mm	Max. conductor-ø mm	Valid current A	Supply voltage U _s (kV dc)		Test voltage U _e (kV dc)		Cable-order-no.	Type of insulation	Delivery time
Male contact	Female contact							K-K	K-M	K-K	K-M			
		113	00	-	1.3	1.0	8	0.25	0.4	0.8	1.2	RG-174/U	unipole	●
		116	0	-	1.6	1.4	12	-	0.7	-	2.1	RG-174/U	unipole	●
		120	1	-	2	1.8	18	-	0.9	-	2.7	RG-174 A/U	unipole	●
		130	1	-	3	2.7	25	-	0.7	-	2.1	140 470	unipole	●
		130	2	-	3	2.7	30	-	1.0	-	3.0	on request	unipole	●
		140	2	-	4	3.7	40	-	0.8	-	2.4	on request	unipole	●
		140	3	-	4	3.7	43	-	1.1	-	3.3	on request	unipole	●
		160	3	-	6	5.5	65	-	0.8	-	2.4	on request	unipole	●
		140	4	-	4	3.7	46	-	1.4	-	4.2	on request	unipole	◐
		160	4	-	6	5.5	70	-	1.3	-	3.9	on request	unipole	◐
		112	5	-	12	12	230	-	0.7	-	2.1	on request	unipole	○



EINPOLIG / HOCHSTROM | UNIPOLE / HIGH CURRENT KONFEKTIONIERUNGSANLEITUNG | ASSEMBLING INSTRUCTIONS

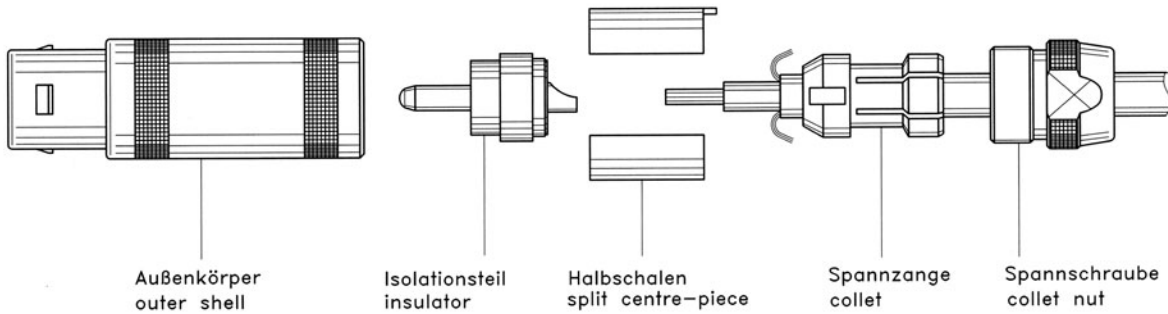

Reference			Contact ø (mm)	Unisolated length (mm)		
Series	Type	Cable		A	B	C
0S/0E	116	one-lead	1.6	3.0	4.5	6.0
1S/1E	120	one-lead	2.0	3.0	5.0	7.0
1S/1E	130	one-lead	3.0	3.0	5.0	7.0
2S/2E	130	one-lead	3.0	5.0	6.0	9.0
2S/2E	140	one-lead	4.0	4.0	6.0	9.0
3S/3E	140	one-lead	4.0	4.0	9.0	12.0
3S/3E	160	one-lead	6.0	5.0	9.0	12.0
4S/4E	140	one-lead	4.0	3.5	8.0	12.0
4S/4E	160	one-lead	6.0	5.5	8.0	12.0
5S/5E	112	one-lead	12.0	16.0	-	19.0



Note: The dimensions are standard values and may vary depending on the cable quality.

Die Abmessungen sind Richtwerte und können sich je nach Kabelqualität ändern.

**Steckverbindungen
Connectors
Kontaktfiguration
Contactfiguration
Kabel
Cable
Konfektionierungsanleitung
Assembling Instructions**



**GEMISCHT / MEHRPOLIG HOCHSTROM
HYBRID / MULTIPOLE HIGH CURRENT**

GEMISCHT/MEHRPOLIG HOCHSTROM | HYBRIDE/MULTIPOLE HIGH CURRENT
BAUFORM S-SERIE | MODEL S-SERIES



FFA Straight plug, cable collet



Reference		Dimensions (mm)			
Model	Series	A	L	M	S2
FFA	2S	14.8	52	40	11
FFA	3S ✓	17.8	61	46	14
FFA	4S ✓	24.8	77	59	19
FFA	5S ✓	35.1	103	78	29

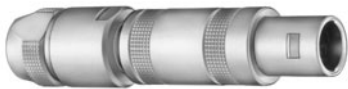

FFA Straight plug with oversize cable collet

Reference		Dimensions (mm)					
Model	Series	A	B	L	M	S1	S2
FFA	2S ✓	14.8	18.0	67	55	14.0	14
FFA	3S ✓	17.8	21.0	85	70	19.0	19
FFA	4S ✓	24.8	31.8	107	89	28.5	29
FFA	5S ✓	35.1	41.8	138	113	37.5	38

Note: the fitting of oversize collets onto this model allows them to be fitted to the cables that can be accommodated by the next housing size up

FFA Straight plug, cable collet and nut for fitting a bend relief



Reference		Dimensions (mm)			
Model	Series	A	L	M	S2
FFA	2S ✓	14.8	52	40	12
FFA	3S ✓	17.8	61	46	14
FFA	4S ✓	24.8	77	59	20

Note: the bend relief must be ordered separately (see page 80)

FFP Straight plug, cable collet and inner anti-rotating device



Reference		Dimensions (mm)			
Model	Series	A	L	M	S2
FFP	2S	14.8	52	40	11
FFP	3S ✓	17.8	61	46	14
FFP	4S ✓	24.8	77	59	19



Part number example see page 3



GEMISCHT/MEHRPOLIG HOCHSTROM | HYBRIDE/MULTIPOLE HIGH CURRENT BAUFORM S-SERIE | MODEL S-SERIES

FFB Straight plug, cable collet and safety locking ring

Reference		Dimensions (mm)			
Model	Series	A	L	M	S2
FFB	2S ✓	14.8	55.5	43.5	11.0
FFB	3S ✓	17.8	65.0	50.0	14.0

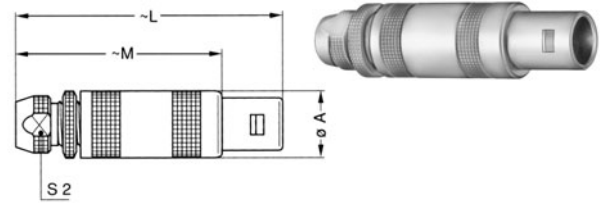

FFB Straight plug, cable collet and safety locking ring and nut for fitting a bend relief

Reference		Dimensions (mm)			
Model	Series	A	L	M	S2
FFB	2S	14.8	55.5	43.5	12
FFB	3S	17.8	65.0	50.0	14

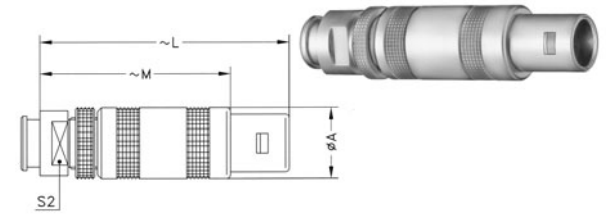

Note: series 2S and 3S are available on request
the bend relief must be ordered separately (see page 80)

FLA Elbow (90°) plug, cable collet

Reference		Dimensions (mm)						
Model	Series	A	A1	H	L	M	S1	S2
FLA	2S	20	20	37.0	31.0	19.0	13	11
FLA	3S	21	21	44.0	38.5	23.5	15	14
FLA	4S ✓	28	28	56.0	49.0	31.0	20	19
FLA	5S ✓	-	37	76.5	65.0	40.0	30	29

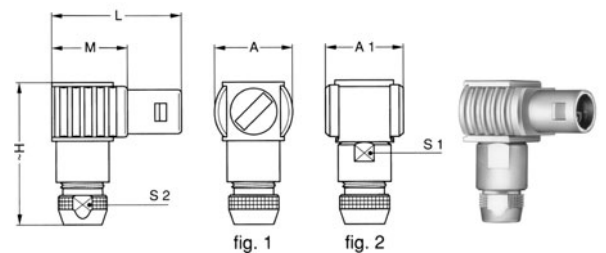

Note: fig.1 is used for the unipole type; fig.2 is used for the multipole type

ERA Fixed socket, nut fixing

Reference		Dimensions (mm)								
Model	Series	A	B	e	E	L	L'	M	S1	S3
ERA	2S	18	19.5	M15x1.0	8.5	24.5	26.0	1.8	13.5	17
ERA	3S ✓	22	25.2	M18x1.0	11.5	29.0	30.0	2.0	16.5	22
ERA	4S ✓	28	32.0	M25x1.0	12.0	34.0	36.0	2.5	23.5	30
ERA	5S ✓	40	40.0	M35x1.0	15.5	45.0	78.5	3.0	33.5	-

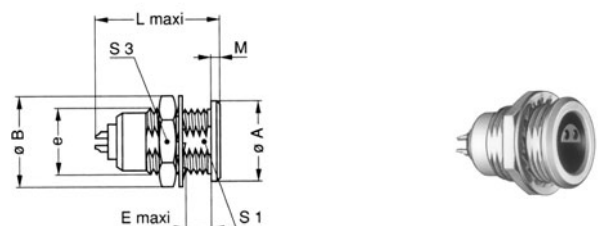

Note: the 5S series is delivered with a tapered washer and a round nut
1 unipole model

✓ Bei Lemo vorhanden | available at Lemo

GEMISCHT/MEHRPOLIG HOCHSTROM | HYBRIDE/MULTIPOLE HIGH CURRENT
BAUFORM S-SERIE | MODEL S-SERIES



ERN Fixed socket, nut fixing, with earthing tag

Reference		Dimensions (mm)								
Model	Series	A	B	e	E	L	L'	M	S1	S3
ERN	2S ✓	18	19.5	M15x1.0	8.5	26.3	26.3	1.8	13.5	17
ERN	3S	22	25.2	M18x1.0	11.5	29.8	30.0	2.0	16.5	22

Note: ¹ unipole model

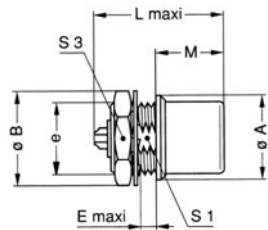

EHP Fixed socket, nut fixing, protruding shell

Reference		Dimensions (mm)								
Model	Series	A	B	e	E	L	L'	M	S1	S3
EHP	3S ✓	22	25.2	M18x1.0	4	29	30	18.7	-	22

Note: ¹ unipole model



EBC Fixed socket with square flange, protruding shell and screw fixing

Reference		Dimensions (mm)								
Model	Series	A	B	C	H	L	L'	M	N	
EBC	2S	22	15	3.2	15.5	24.5	26.0	18.5	4.4	
EBC	3S	25	18	3.2	18.0	29.0	30.0	23.5	3.0	
EBC	5S ✓	45	40	4.3	36.8	45.0	53.5	15.0	4.0	

Note: ¹ unipole model

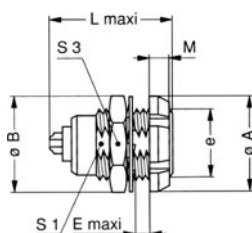

ERD Fixed socket with two nuts (back panel mounting)

Reference		Dimensions (mm)								
Model	Series	A	B	e	E	L	L'	M	S1	S3
ERD	2S	20	19.5	M15x1.0	6.5	24.5	26	3.5	13.5	17
ERD	3S ✓	24	25.2	M18x1.0	9.0	29.0	30	4.5	16.5	22
ERD	4S	30	32.0	M25x1.0	10.0	34.0	36	4.5	23.5	30

Note: the 3S and 4S series are delivered with a conical nut ¹ unipole model



Part number example see page 3



GEMISCHT/MEHRPOLIG HOCHSTROM | HYBRIDE/MULTIPOLE HIGH CURRENT
BAUFORM S-SERIE | MODEL S-SERIES

ECP Fixed socket with two nuts, long threaded shell, with straight contact for printed circuit (back panel mounting)

Reference		Dimensions (mm)							
Model	Series	A	B	e	E	M	N	S1	S3
ECP	2S ✓	20	19.5	M15x1.0	11	3.5	20	13.5	17
ECP	3S ✓	24	25.2	M18x1.0	14	4.5	24	16.5	22

Note: This contact type is available for all EXX socket models. Length 'L' depends on the number of contacts. The 3S-series is delivered with a conical nut.

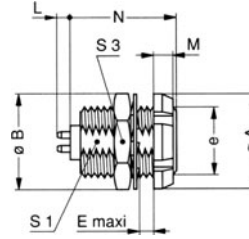

PCA Free socket, cable collet

Reference		Dimensions (mm)		
Model	Series	A	L	S2
PCA	2S	14.8	50	11
PCA	3S ✓	17.8	59	14
PCA	4S ✓	24.8	75	19
PCA	5S ✓	34.7	99	29

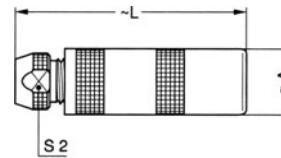

PCA Free socket with oversize cable collet

Reference		Dimensions (mm)				
Model	Series	A	B	L	S1	S2
PCA	2S ✓	14.8	18.0	65	14.0	14
PCA	3S ✓	17.8	21.0	83	19.0	19
PCA	4S ✓	24.8	31.8	105	28.5	29

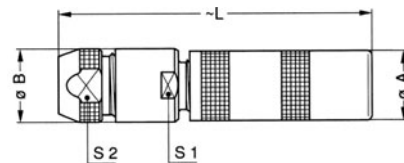

Note: the fitting of oversize collets onto this model allows it to be fitted to the cables that can be accommodated by the next housing size up

PCA Free socket, cable collet and nut for fitting a bend relief

Reference		Dimensions (mm)		
Model	Series	A	L	S2
PCA	2S ✓	14.8	50	12
PCA	3S ✓	17.8	59	14
PCA	4S ✓	24.8	75	20

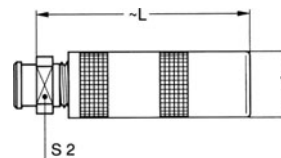

Note: the bend relief must be ordered separately (see page 80)

GEMISCHT/MEHRPOLIG HOCHSTROM | HYBRIDE/MULTIPOLE HIGH CURRENT
BAUFORM S-SERIE | MODEL S-SERIES



PSA Fixed socket, nut fixing, cable collet

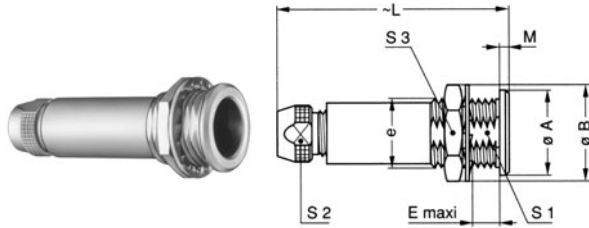

Reference		Dimensions (mm)								
Model	Series	A	B	e	E	L	M	S1	S2	S3
PSA	2S	18	19.5	M15x1.0	8.5	50	1.8	13.5	11	17
PSA	3S ✓	22	25.2	M18x1.0	11.5	59	2.0	16.5	14	22
PSA	4S ✓	28	32.0	M25x1.0	12.0	75	2.5	23.5	19	30
PSA	5S ✓	40	40.0	M35x1.0	15.5	99	3.0	33.5	29	-

Note: the 5S series is delivered with a tapered washer and a round nut

PSP Fixed socket, nut fixing, cable collet and inner anti-rotating device

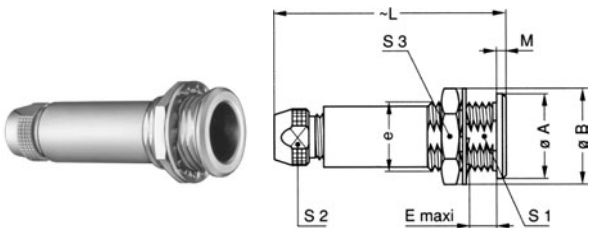

Reference		Dimensions (mm)								
Model	Series	A	B	e	E	L	M	S1	S2	S3
PSP	2S	18	19.5	M15x1.0	8.5	50	1.8	13.5	11	17
PSP	3S	22	25.2	M18x1.0	11.5	59	2.0	16.5	14	22
PSP	4S ✓	28	32.0	M25x1.0	12.0	75	2.5	23.5	19	30

BAUFORM E-SERIE | MODEL E-SERIES

FFA Straight plug, cable collet – watertight

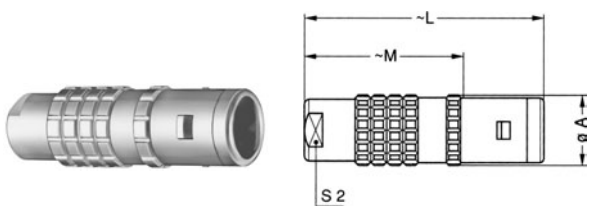

Reference		Dimensions (mm)			
Model	Series	A	L	M	S2
FFA	2E ✓	16	52	36.0	12
FFA	3E ✓	19	61	41.0	15
FFA	4E ✓	25	71	50.5	19
FFA	5E	38	92	67.0	32

FFA Straight plug with oversize cable collet – watertight

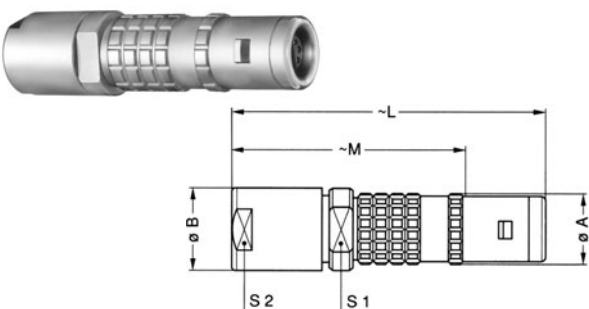

Reference		Dimensions (mm)					
Model	Series	A	B	L	M	S1	S2
FFA	2E ✓	16	17	65	49	15	15
FFA	3E ✓	19	22	80	60	19	19
FFA	4E ✓	25	36	105	84	30	32

Note: the fitting of oversize collets onto this model allows them to be fitted to the cables that can be accommodated by the next housing size up

✓ Bei Lemo vorhanden | available at Lemo



Part number example see page 3



GEMISCHT/MEHRPOLIG HOCHSTROM | HYBRIDE/MULTIPOLE HIGH CURRENT

BAUFORM E-SERIE | MODEL E-SERIES

FFA straight plug, cable collet and nut for fitting a bend relief – watertight

Reference		Dimensions (mm)			
Model	Series	A	L	M	S2
FFA	2E ✓	16	52	36.0	12
FFA	3E ✓	19	60	40.0	15
FFA	4E ✓	25	71	50.5	19

Note: the bend relief must be ordered separately (see page 80)

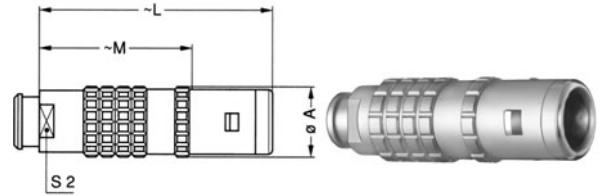

FAA Fixed plug non-latching, nut fixing – watertight

Reference		Dimensions (mm)								
Model	Series	A	B	e	E	L	L'	M	S1	S3
FAA	2E	25	27.5	M20x1.0	4.0	27.0	27.0	18.0	18.5	24
FAA	3E ✓	31	34.5	M24x1.0	4.5	32.5	32.5	22.5	22.5	30

Note: ¹ unipole model

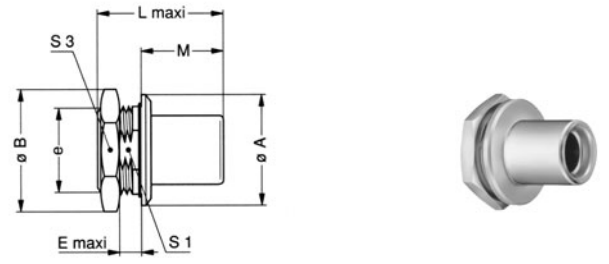

FLA Elbow (90°) plug, cable collet – watertight

Reference		Dimensions (mm)							
Model	Series	A	D	H	L	M	S1	S2	S3
FLA	2E	17.5	10.5	40	51	35.0	15	12	13
FLA	3E ✓	21.0	11.5	47	60	40.0	18	15	15
FLA	4E	27.5	15.5	57	72	51.5	24	19	20

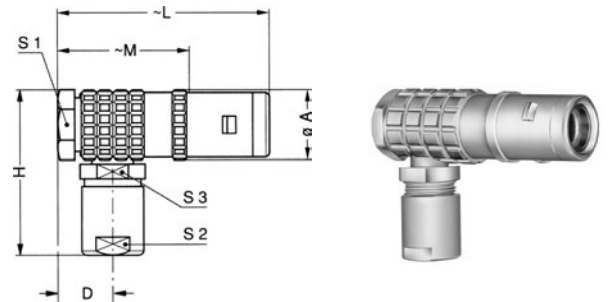

ERA Fixed socket, nut fixing – watertight

Reference		Dimensions (mm)								
Model	Series	A	B	e	E	L	L'	M	S1	S3
ERA	2E ✓	25	27.5	M20x1.0	9	28.5	30	5.0	18.5	24
ERA	3E ✓	31	34.5	M24x1.0	11	34.0	35	6.0	22.5	30
ERA	4E ✓	37	41.5	M30x1.0	9	36.0	38	6.5	28.5	36
ERA	5E	55	54.0	M45x1.5	10	44.5	78	9.0	42.5	-

Note: the 5E series is delivered with a round nut.
¹ unipole model

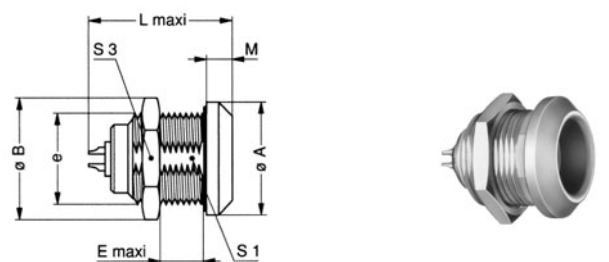

GEMISCHT/MEHRPOLIG HOCHSTROM | HYBRIDE/MULTIPOLE HIGH CURRENT
BAUFORM E-SERIE | MODEL E-SERIES

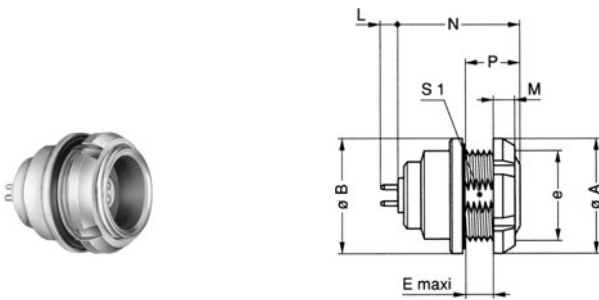

EEP Fixed socket, nut fixing, with straight contact for printed circuit (back panel mounting) – watertight

Reference		Dimensions (mm)							
Model	Series	A	B	e	E	M	N	P	S1
EEP	2E ✓	25	25	M20x1.0	5	3.5	25.5	10	18.5
EEP	3E ✓	30	31	M24x1.0	7	4.5	30.5	12	22.5

Note: length 'L' depends on the number of contacts

PCA Free socket, cable collet – watertight

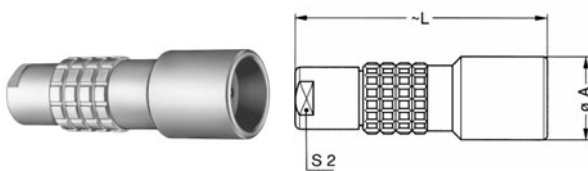

Reference		Dimensions (mm)		
Model	Series	A	L	S2
PCA	2E ✓	19	54.0	12
PCA	3E ✓	23	65.0	15
PCA	4E ✓	29	75.5	19
PCA	5E	42	95.0	32

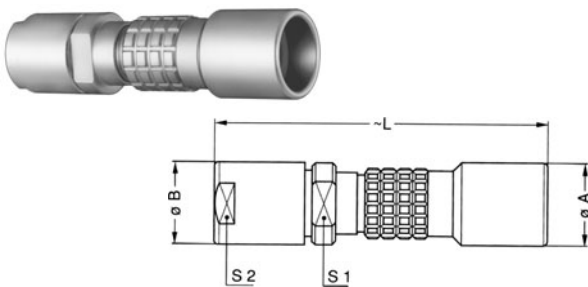

PCA Free socket with oversize cable collet – watertight

Reference		Dimensions (mm)				
Model	Series	A	B	L	S1	S2
PCA	2E ✓	19	17	67	15	15
PCA	3E ✓	23	22	84	19	19
PCA	4E ✓	29	36	109	30	32

Note: the fitting of oversize collets onto this model allows them to be fitted to the cables that can be accommodated by the next housing size up

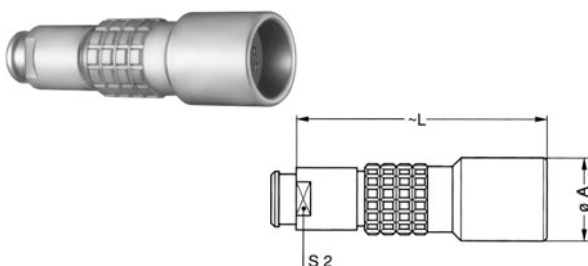

PCA Free socket, cable collet and nut for fitting a bend relief – watertight

Reference		Dimensions (mm)		
Model	Series	A	L	S2
PCA	2E ✓	19	54.0	12
PCA	3E ✓	23	64.0	15
PCA	4E ✓	29	75.5	19

Note: the bend relief must be ordered separately (see page 80)



Part number example see page 3



GEMISCHT/MEHRPOLIG HOCHSTROM | HYBRIDE/MULTIPOLE HIGH CURRENT BAUFORM E-SERIE | MODEL E-SERIES

PSA Fixed socket, nut fixing, cable collet – watertight

Reference		Dimensions (mm)								
Model	Series	A	B	e	E	L	M	S1	S2	S3
PSA	2E	25	27.5	M20x1.0	9	54.0	5.0	18.5	12	24
PSA	3E	31	34.5	M24x1.0	11	65.0	6.0	22.5	15	30
PSA	4E ✓	37	41.5	M30x1.5	9	75.5	6.5	28.5	19	36
PSA	5E	51	54.0	M45x1.5	10	95.0	9.0	-	32	54

Note: the 5E series is delivered with a round nut

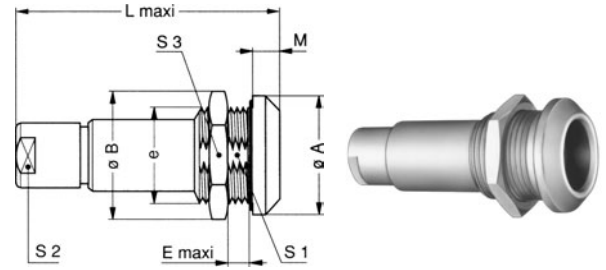

HGP Fixed socket, nut fixing, watertight and vacuumtight

Reference		Dimensions (mm)								
Model	Series	A	B	e	E	L	L'	M	S1	S3
HGP	2E ✓	25	27.5	M20x1.0	10.5	32.5	28.0	5.0	18.5	24
HGP	3E ✓	31	34.5	M24x1.0	15.5	39.5	38.5	6.0	22.5	30
HGP	4E	37	41.5	M30x1.0	17.5	43.0	44.0	6.5	28.5	36
HGP	5E	55	54.0	M45x1.5	20.0	52.0	76.0	9.0	42.5	-

Note: the 5E series is delivered with a round nut
 1 unipole model

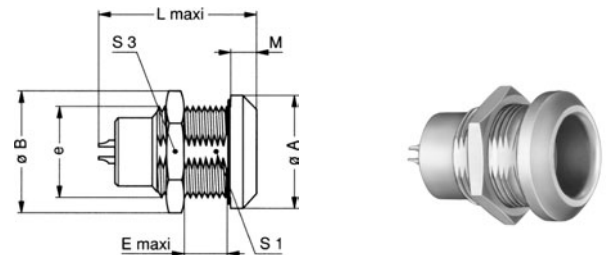

BAUFORM B-SERIE | MODEL B-SERIES

FGG Straight plug with key (G) or keys (code A to M and R)

Reference		Dimensions (mm)				
Model	Series	A	L	M	S1	S2
FGG	1B ✓	12	43	32	10	9
FGG	2B ✓	15	49	37	13	12
FGG	3B ✓	18	58	43	15	14
FGG	4B ✓	25	75	57	21	20
FGG	5B ✓	35	103	78	31	30

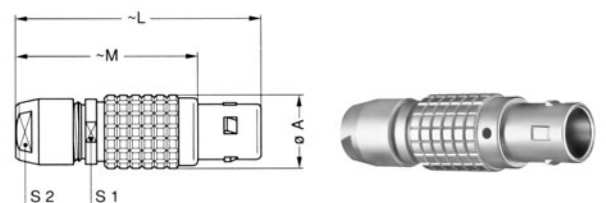

GEMISCHT/MEHRPOLIG HOCHSTROM | HYBRIDE/MULTIPOLE HIGH CURRENT
BAUFORM B-SERIE | MODEL B-SERIES



EGG Fixed socket with nut fixing and key (G) or keys (code A to M and R)



Reference		Dimensions (mm)								
Model	Series	A	B	e	E	L	M	N	S1	S3
EGG	1B ✓	14	16	M12x1.0	7.5	21.7	1.5	19.5	10.5	14
EGG	2B ✓	18	20	M15x1.0	8.5	25.0	1.8	21.5	13.5	17
EGG	3B ✓	22	25	M18x1.0	11.5	30.0	2.0	25.5	16.5	22
EGG	4B ✓	28	32	M25x1.0	12.0	34.5	2.5	30.5	23.5	30
EGG	5B ✓	40	40	M35x1.0	15.5	45.5	3.0	36.5	33.5	-

PKG Fixed socket with nut fixing and key (G) or keys (code A to M and R) and cable collet



Reference		Dimensions (mm)								
Model	Series	A	B	e	E	L	M	S1	S2	S3
PKG	1B ✓	14	16.0	M12x1.0	7.5	40.5	1.5	10.5	9	14
PKG	2B ✓	18	19.5	M15x1.0	8.5	47.0	1.8	13.5	12	17
PKG	3B ✓	22	25.0	M18x1.0	11.5	56.0	2.0	16.5	14	22
PKG	4B ✓	28	32.0	M25x1.0	12.5	73.0	2.5	23.5	20	30
PKG	5B ✓	40	40.0	M35x1.0	11.0	99.0	3.0	33.5	30	-

PFG Fixed socket with two nuts, key (G) or keys (code A to M and R) and cable collet

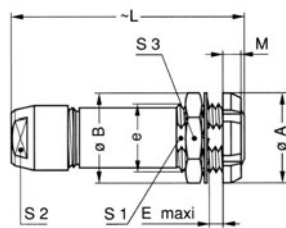

Reference		Dimensions (mm)								
Model	Series	A	B	e	E	L	M	S1	S2	S3
PFG	1B ✓	16	16	M12x1.0	5.0	40.5	3.5	10.5	9	14
PFG	2B ✓	20	20	M15x1.0	6.5	47.0	3.5	13.5	12	17
PFG	3B ✓	24	25	M18x1.0	9.0	56.0	4.5	16.5	14	22
PFG	4B ✓	30	32	M25x1.0	11.0	73.0	4.5	23.5	20	30

PHG Free socket with key (G) or keys (code A to M and R) and cable collet

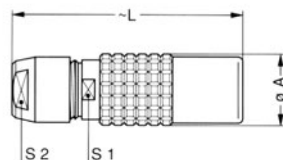

Reference		Dimensions (mm)			
Model	Series	A	L	S1	S2
PHG	1B ✓	12.5	40.5	10	9
PHG	2B ✓	16.5	47.0	13	12
PHG	3B ✓	19.0	56.0	15	14
PHG	4B ✓	24.4	73.0	21	20
PHG	5B ✓	34.2	99.0	31	30



Part number example see page 3



GEMISCHT/MEHRPOLIG HOCHSTROM | HYBRIDE/MULTIPOLE HIGH CURRENT
BAUFORM K-SERIE | MODEL K-SERIES

FGG Straight plug with key (G) or keys (code A to F and L) and cable collet – watertight

Reference		Dimensions (mm)				
Model	Series	A	C	L	M	S2
FGG	1K ✓	13	7.1	42	28.0	8.9
FGG	2K ✓	16	9.2	52	36.0	11.9
FGG	3K ✓	19	10.5	61	41.0	14.9
FGG	4K ✓	25	14.0	71	50.5	18.9
FGG	5K ✓	38	23.5	92	67.0	31.9



FGG Straight plug with key (G) or keys (code A to F and L) and oversize collet – watertight

Reference		Dimensions (mm)						
Model	Series	A	B	C	L	M	S1	S2
FGG	1K ✓	13	14.5	9.2	55	41	11.9	11.9
FGG	2K ✓	16	17.0	10.5	65	49	14.9	14.9
FGG	3K ✓	19	22.0	15.3	80	60	18.9	18.9
FGG	4K ✓	25	36.0	23.5	105	84	30.0	31.9



FGG Straight plug with key (G) or keys (code A to F and L) and bend relief – watertight

Reference		Dimensions (mm)				
Model	Series	A	C	L	M	S2
FGG	1K ✓	13	7.1	45.0	31.0	9.0
FGG	2K ✓	16	8.7	49.0	33.0	11.9
FGG	3K ✓	19	10.8	62.0	42.0	15.0
FGG	4K ✓	25	15.3	78.5	50.5	18.9



Note: the bend relief must be ordered separately (see page 82)

EGG Fixed socket with nut fixing and key (G) or keys (code A to F and L) – watertight

Reference		Dimensions (mm)							
Model	Series	A	B	e	E	L	M	S1	S3
EGG	1K ✓	20	21.5	M16x1.0	9	26.0	4.5	14.5	19
EGG	2K ✓	25	27.5	M20x1.0	9	29.0	5.0	18.5	24
EGG	3K ✓	31	34.5	M24x1.0	11	34.5	6.0	22.5	30
EGG	4K ✓	37	41.5	M30x1.0	9	35.0	6.5	28.5	36
EGG	5K ✓	54	54.0	M45x1.5	10	43.5	9.0	42.5	54



GEMISCHT/MEHRPOLIG HOCHSTROM | HYBRIDE/MULTIPOLE HIGH CURRENT
BAUFORM K-SERIE | MODEL K-SERIES

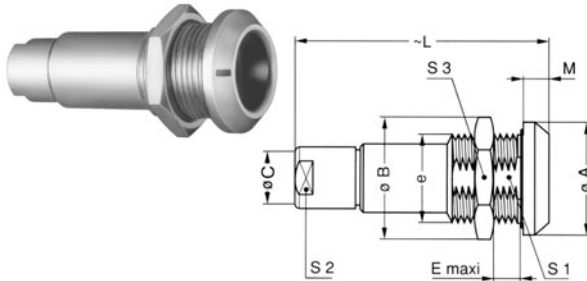

PKG Fixed socket, nut fixing, with key (G) or keys (code A to F and L) and cable collet – watertight

Reference		Dimensions (mm)								
Model	Series	A	B	e	E	L	M	S1	S2	S3
PKG	1K ✓	20	21.5	M16x1.0	9	45.0	4.5	14.5	9	19
PKG	2K ✓	25	27.5	M20x1.0	9	54.0	5.0	18.5	12	24
PKG	3K ✓	31	34.5	M24x1.0	11	65.0	6.0	22.5	15	30
PKG	4K ✓	37	41.5	M30x1.0	9	75.5	6.5	28.5	19	36
PKG	5K ✓	55	54.0	M45x1.0	15	95.0	9.0	42.5	32	-

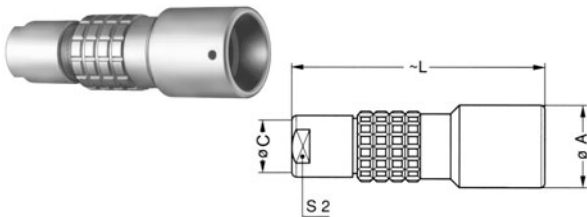

PHG Free socket, nut fixing, with key (G) or keys (code A to F and L) and cable collet – watertight

Reference		Dimensions (mm)			
Model	Series	A	C	L	S2
PHG	1K ✓	15	7.1	45.0	8.9
PHG	2K ✓	19	9.2	54.0	11.9
PHG	3K ✓	23	10.5	65.0	14.9
PHG	4K ✓	29	14.0	75.5	18.9
PHG	5K ✓	42	23.5	95.0	31.9

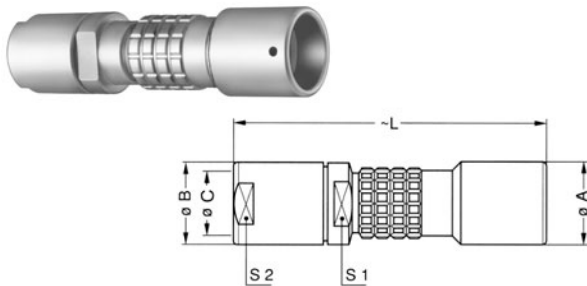

PHG Free socket, nut fixing, with key (G) or keys (code A to F and L) and oversize collet – watertight

Reference		Dimensions (mm)					
Model	Series	A	B	C	L	S1	S2
PHG	1K ✓	15	14.5	9.2	58.0	11.9	11.9
PHG	2K ✓	19	17.0	10.5	67.0	14.9	14.9
PHG	3K ✓	23	22.0	14.0	86.0	18.9	18.9
PHG	4K ✓	29	36.0	14.0	123.5	30.0	31.9

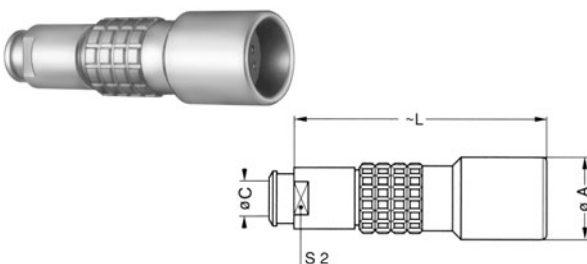

PHG Free socket, nut fixing, with key (G) or keys (code A to F and L) and nut for fitting a bend relief – watertight

Reference		Dimensions (mm)			
Model	Series	A	C	L	S2
PHG	1K ✓	15	7.1	48.0	9.0
PHG	2K ✓	19	9.2	57.0	11.9
PHG	3K ✓	23	10.5	66.0	15.0
PHG	4K ✓	29	14.0	75.5	18.9

Note: the bend relief must be ordered separately (see page 80)



Part number example see page 3



GEMISCHT/MEHRPOLIG HOCHSTROM | HYBRIDE/MULTIPOLE HIGH CURRENT
KONTAKTFIGURATION SERIE S+E | CONTACTFIGURATION SERIES S+E

Soldersided seen		Order-No.	Size	Impedance	Contact- ϕ	Max. conductor- ϕ	Valid current	Supply voltage		Test voltage		Cable-order-no.	Type of insulation	Delivery time
Male contact	Female contact							U_s (KV dc)	U_e (KV dc)	K-K	K-M			
		702	2	-	1.3 3.0	1.0 2.7	15 -	0.6 3.5	0.8 5.0	1.8 -	2.4 -	020 140 106 330	mixed	●
		702	3	-	1.3 2.0 2.0	1.0 1.8 1.8	10 18	3.0 0.35	3.0 0.5	4.5 1.0	4.5 1.5	317 440	mixed	●○
		703	3	-	1.3 1.3	1.0 1.0	3 14	3.0 0.7	3.0 1.0	4.5 2.1	4.5 3.0	317 440	mixed	●○
		704	3	-	1.3 1.3	1.0 1.0	3 10	3.0 0.35	3.0 0.5	4.5 1.0	4.5 1.5	317 440	mixed	●
		705	3	-	1.3 1.3	1.0 1.0	3 9	3.0 0.35	3.0 0.5	4.5 1.0	4.5 1.5	317 480	mixed	●
		706	3	-	1.3 1.3	1.0 1.0	3 8	3.0 0.35	3.0 0.5	4.5 1.0	4.5 1.5	317 480	mixed	●
		707	3	-	1.3 1.3	1.0 1.0	3 8	3.0 0.35	3.0 0.5	4.5 1.0	4.5 1.5	317 480	mixed	●
		708	3	-	1.3 0.9	1.0 0.8	8 6	3.0 0.25	3.0 0.4	4.5 0.8	4.5 1.2	317 480	mixed	●
		732	3	-	1.3 1.3	1.0 1.0	10 14	3.0 0.7	3.0 1.0	4.5 2.1	4.5 3.0	321 740	mixed	●
		734	3	-	1.3 1.3	1.0 1.0	3 10	3.0 0.7	3.0 1.0	4.5 2.1	4.5 3.0	321 740	mixed	●
		702	4	-	2.0 3.0	1.8 2.7	6 22	3.0 0.7	3.0 1.0	4.5 2.1	4.5 3.0	RG-cable	mixed	●
		703	4	-	2.0 2.0	1.8 1.8	6 16	3.0 0.7	3.0 1.0	4.5 2.1	4.5 3.0	on request	mixed	●
		704	4	-	2.0 1.3	1.8 1.0	6 13	3.0 0.9	3.0 1.3	4.5 2.7	4.5 3.9	on request	mixed	●

GEMISCHT/MEHRPOLIG HOCHSTROM | HYBRIDE/MULTIPOLE HIGH CURRENT
KONTAKTFIGURATION SERIE S+E | CONTACTFIGURATION SERIES S+E



Soldersided seen		Order-No.	Size	Impedance	Contact- ϕ	Max. conductor- ϕ	Valid current	Supply voltage U_s (kV dc)		Test voltage U_e (kV dc)		Cable-order-no.	Type of insulation	Delivery time
Male contact	Female contact							K-K	K-M	K-K	K-M			
		705	4	-	2.0	1.8	6	3.0	3.0	4.5	4.5	on request	mixed	●
				-	1.3	1.0	11	0.7	1.0	8.0	8.0			
		706	4	-	2.0	1.8	6	3.0	3.0	4.5	4.5	on request	mixed	●
				-	1.3	1.0	9	0.7	1.0	8.0	8.0			
		707	4	-	2.0	1.8	6	3.0	3.0	4.5	4.5	on request	mixed	●
				-	1.3	1.0	9	0.7	1.0	8.0	8.0			
		708	4	-	2.0	1.8	6	3.0	3.0	4.5	4.5	on request	mixed	●
				-	1.3	1.0	9	0.7	1.0	8.0	8.0			
		709	4	-	2.0	1.8	6	3.0	3.0	4.5	4.5	on request	mixed	●
				-	0.9	0.7	7	0.7	1.0	2.1	3.0			
		712	4	-	2.0	1.8	6	3.0	3.0	4.5	4.5	on request	mixed	●
				-	0.9	0.8	7	0.7	1.0	2.1	3.0			
		734	4	-	2.0	1.8	14	3.0	3.0	4.5	4.5	on request	mixed	●
				-	1.3	1.0	13	0.7	1.0	2.1	3.1			
		714	4	-	2.0	1.8	14	3.0	3.0	4.5	4.5	on request	mixed	●
				-	0.9	0.8	7	0.7	1.0	2.1	3.0			
		735	4	-	2.0	1.8	14	3.0	3.0	4.5	4.5	on request	mixed	●
				-	1.3	1.0	11	0.7	1.0	2.1	3.0			
		737	4	-	2.0	1.8	14	3.0	3.0	4.5	4.5	on request	mixed	●
				-	1.3	1.0	9	0.7	1.0	2.1	3.0			
		742	4	-	2.0	1.8	15	3.0	3.0	4.5	4.5	on request	mixed	●
				-	0.9	1.0	7	0.7	1.0	2.1	3.0			
		706	5	-	2.0	1.8	10	5.0	5.0	7.5	7.5	on request	mixed	○
				-	2.0	1.8	10	0.8	1.0	14.0	14.0			

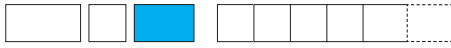

Part number example see page 3



GEMISCHT/MEHRPOLIG HOCHSTROM | HYBRIDE/MULTIPOLE HIGH CURRENT
KONTAKTFIGURATION SERIE S+E | CONTACTFIGURATION SERIES S+E

Soldersided seen		Order-No.	Size	Impedance	Contact- ϕ	Max. conductor- ϕ	Valid current	Supply voltage U_s (kV dc)		Test voltage U_e (kV dc)		Cable-order-no.	Type of insulation	Delivery time
Male contact	Female contact							K-K	K-M	K-K	K-M			
		708	5	-	2	1.8	10	5.0	5.0	7.5	7.5	on request	mixed	○
				-	2	1.8	15	0.4	0.6	1.2	1.8			
		710	5	-	2	1.8	20	5.0	5.0	7.5	7.5	on request	mixed	○
				-	1.6	1.4	11	0.6	0.8	1.8	2.4			
		724	5	-	2	1.8	10	5.0	5.0	7.5	7.5	on request	mixed	○
				-	1.3	1.0	6	0.4	0.6	1.2	1.8			
		730	5	-	3	2.7	12	10	10	15	15	on request	mixed	○
				-	2	1.8	15	0.4	0.6	1.2	1.8			
		733	5	-	2	1.8	6	5.0	5.0	7.5	7.5	see catalogue	mixed	○
				-	3	2.7	10	0.2	1.0	2.5	3.0			
		736	5	-	2	1.8	15	5.0	5.0	7.5	7.5	see catalogue	mixed	○
				-	2	1.8	18	0.7	1.0	2.1	3.0			
		738	5	-	2	1.8	6	5.0	5.0	7.5	7.5	see catalogue	mixed	○
				-	2	1.8	15	0.7	1.0	2.1	3.0			
		740	5	-	2	1.8	20	5.0	5.0	7.5	7.5	see catalogue	mixed	○
				-	1.6	1.4	11	0.6	0.8	1.8	2.4			
		754	5	-	2	1.8	6	5.0	5.0	7.5	7.5	catalogue	mixed	○
				-	1.3	1.0	6	0.4	0.6	1.2	1.8	catalogue	mixed	○
		746	5S	-	1.3	1.0	6	0.4	0.6	1.6	2.2	316 250	mixed	●
				-	2.0	1.8	-	3.5	5.0	-	-	106 330		
		760	5S	-	1.3	1.0	6	0.4	0.6	1.2	1.8	430 250	mixed	●
				-	2.0	1.8	-	3.5	5.0	-	-	106 330		



GEMISCHT/MEHRPOLIG HOCHSTROM | HYBRIDE/MULTIPOLE HIGH CURRENT
KONTAKTFIGURATION SERIE B+K | CONTACTFIGURATION SERIES B+K



Soldersided seen		Order-No.	Standart Group	Watertight Group	High Voltage (HV)					Low Voltage (LV)								
Male contact	Female contact				Nb of contacts	ø Dielectric	AWG max	Us (kV r.m.s.)	Us (kV dc)	Nb of contacts	ø A	Contact Type		Us (kV r.m.s.)	Us (kV dc)	Test Voltage (kV r.m.s.)	Test Voltage (kV dc)	Rated Current
					mm		kV	kV		mm	To solder	To crimp	kV	kV	kV	kV	A	
		702	1B	1K	1	2.0	26	2.1	3.0	2	1.3	●	○	0.40	0.60	1.2	1.8	12.0
		731	1B	1K	2	0.7	-	-	-	1	1.3	●	○	0.40	0.60	1.2	1.8	12.0
		704	2B	2K	1	2.0	20	2.1	3.0	4	0.7	●	○	0.40	0.60	1.2	1.8	5.0
		718	3B	-	1	2.0	22	3.0	-	18	0.7	●	●	-	0.60	-	2.0	5.5
		740	3B	-	2	2.0	22	3.0	-	10	0.7	●	●	-	0.60	-	2.0	5.5
		745	4B	4K	2	2.0	22	5.6	8.0	16	0.9	●	●	0.63	0.90	1.9	2.7	7.0
		752	5B	5K	2	3.8	14	1.5	2.2	20	1.3	●	●	0.53	0.70	1.6	2.3	10.0
											1.6	○	0.90	1.30	2.9	4.1	10.0	
		759	5B	5K	2	2.0	22	5.6	8.0	54	0.9	●	●	0.53	0.70	1.6	2.3	3.0

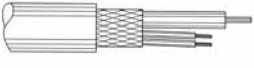

GEMISCHT/MEHRPOLIG HOCHSTROM | HYBRIDE/MULTIPOLE HIGH CURRENT
PVC-ISOLIERTE KOMBINATIONSKABEL | PVC-INSULATED COMBINATION CABLES

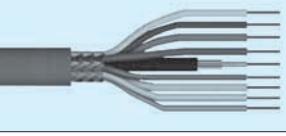
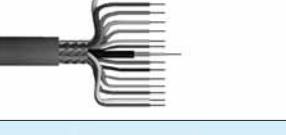
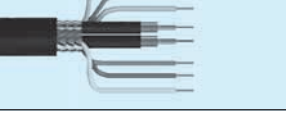
	Lead Time		Price	Order-No.	Amount of Order	Wave impedance	Constructed of	Twisting	Tape	Screen		Outer Sheath	
	Stk.	Req.	€/m							Mat.	Mat.	Ø	
					m	$\Omega (\pm 2)$							mm
	x	-	3.38	317 440	20/100	50	1 coax cable type RG 174 A/U as well as 4 control wires 14x0.15 mm cross section 0.25 mm ²	RG 174+ control wires	PETP-Folie	CuSn	PVC gr	7.2	
	x	-	4.97	317 480	20/100	50	1 coax cable type RG 174 A/U as well as 8 control wires 14x0.15 mm cross section 0.25 mm ²	RG 174+ control wires	PETP-Folie	CuSn	PVC gr	7.3	
	x	-	6.03	417 410	20/100	50	1 coax cable type RG 174 A/U as well as 14 control wires 14x0.15 mm cross section 0.25 mm ²	RG 174+ control wires	PETP-Folie	CuSn	PVC gr	10.0	
	x	-	5.58	321 740	20/100	50	1 coax cable type RG 174 A/U as well as 6 control wires 18x0.10 mm cross section 0.14 mm ²	RG 174+ control wires	PETP-Folie	CuSn	PVC bk	8.0	



Due to different cables,
 please ask for the stripping length





Housings (Y-series)



Reference	Material
C	Brass

Detailed characteristics of these materials are presented on table.

Insulators (Y-series)



Reference	Material or form	Note
L	PEEK	●
T	PTFE	●

Detailed characteristics of these materials are presented on table.

Contacts (Y-series)



Contacts for plugs, free or fixed sockets

Reference	Contact type
A	Male solder
L	Female solder

Material and treatment

Component (see picture page 16)	Material (Standard)	Surface treatment (µm)			
		Cu	Ni	Cr	Au
Outer shell and collet nut	Brass (ASTM C 385)	0.5	3	0.3	
Earthing crown	Cu-Be (FS-QQ-C-530)	0.5	3		1.5
Latch sleeve	Special brass	0.5	3	0.3	
Locking ring	Brass (ASTM C 385)	0.5	3		
Inner sleeve	Brass (ASTM C 385)	0.5	3		
Other metallic parts	Brass (ASTM C 385)	0.5	3		
O-ring	Silicone rubber (ASTM D 200)				
Insulator	PTFE (ASTM D 1457-83)				
	PEEK (MIL-P-46183)				
Male contact	Brass (ASTM C 385)	0.5	3		1.5
Female contact	Cu-Be (FS-QQ-C-530)	0.5	3		2.0

The surface treatment standards are as follows:
 - Nickel FS-QQ-N-290A
 - Chrome FS-QQ-C-320B
 - Gold MIL-G-45204C type I, class 1.



Part number example see page 3

Housings (B + K series)

Ref.	Material	Surface treatment		Note
		Outer shell and collet nut	Latch sleeve and earthing crown	
C	Brass	chrome	nickel	●
N	Brass	nickel	nickel	○
K	Brass	black chrome	nickel	○
S	Stainless steel	without treatment	nickel-plated brass	○
T	Stainless steel	without treatment	stainless steel	○
U	Stainless steel ¹⁾	without treatment	stainless steel	○
L	Aluminium alloy ²⁾	anodized	nickel-plated brass	○
G	PEEK ³⁾	without treatment	nickel-plated brass	○
P	PSU ⁴⁾	without treatment	nickel-plated brass	○
R	PPSU ⁵⁾	without treatment	nickel-plated brass	○
X	Avional ⁶⁾	nickel	nickel-plated brass	○

Note:
detailed characteristics of these materials and treatments are presented on Unipole/Multipole catalogue.

¹⁾ the other metallic parts are in stainless steel.
²⁾ the „variant“ position of the reference is used to specify the anodized colour.
³⁾ only available for FGG and ENG models of the B series.
⁴⁾ only available for ENY and FGY models of the B series. For the colour, see the „variant“ position.
⁵⁾ only available for ENY and FGY models of the B series.
⁶⁾ anthracite colour.

● First choice alternative
 ○ Special order alternative

Part number example see page 3

Insulators (B + K series)

Reference	Material
L	PEEK

Detailed characteristics of these materials are presented on Unipole/Multipole catalogue.

Part number example see page 3

Contacts (B + K series)

Contacts for plugs, free or fixed sockets

Reference	Contact type
A	Male solder
C	Male crimp (fig.1) ¹⁾
B	Male crimp (fig.2) ¹⁾
G	Male crimp (fig.2) ¹⁾

Reference	Contact type
L	Female solder
M	Female crimp (fig.1) ¹⁾
P	Female crimp (fig.2) ¹⁾
U	Female crimp (fig.2) ¹⁾

Note:
¹⁾ there are two forms of crimp barrels. Please consult adjacent table for contact selection and see Unipole/Multipole catalogue.



MATERIALIEN | MATERIALS
SERIE S+E | SERIES S+E



Part number example see page 3

Housings (S + E series)

Ref.	Material	Surface treatment		Note
		Outer shell and collet nut	Latch sleeve and earthing crown	
C	Brass ¹⁾	chrome	nickel	●
D	Brass	gold-plated	nickel	○
N	Brass	nickel	nickel	○
K	Brass	black chrome	nickel	○
S	Stainless steel	without treatment	nickel-plated brass	○
T	Stainless steel	without treatment	stainless steel	○
U	Stainless steel ²⁾	without treatment	stainless steel	○
L	Aluminium alloy ³⁾	anodized	nickel-plated brass	○
B	POM black ⁴⁾	without treatment	nickel-plated brass	○
G	PEEK ⁴⁾	without treatment	nickel-plated brass	○
P	PSU ⁵⁾	without treatment	nickel-plated brass	○
R	PPSU ⁶⁾	without treatment	nickel-plated brass	○

Note:
detailed characteristics of these materials are presented on Unipole/Multipole catalogue.

¹⁾ in the E series the latch sleeve is chrome-plated.

²⁾ the other metallic components are in stainless steel.

³⁾ the „variant“ position of the reference is used to specify the anodized colour.

⁴⁾ only available for FFP, ERN and PCP models of the S series.

⁵⁾ available only for the FFL model of the S series.

⁶⁾ available only for the FFL model of the S series.

● First choice alternative
○ Special order alternative



Part number example see page 3

Insulators (S + E series)

Reference	Material or form	Note
L	PEEK	●
T	PTFE ¹⁾	●

Note:
detailed characteristics of these materials are presented on Unipole/Multipole catalogue.

¹⁾ only for unipole types.

● First choice alternative ○ Special order alternative



Part number example see page 3

Contacts (S + E series)

Contacts for plugs, free or fixed sockets

Ref.	Contact type
A	Male solder
C	Male crimp ^{1) 4)}
L	Female solder
M	Female crimp ^{2) 4)}

Note:

¹⁾ for the FFS model of the 00 series and FFA or FFL models of the S series.

²⁾ for the PSS model of the 00 series and PCA or PSA models of the S series.

³⁾ for the FTA model of the S series.

⁴⁾ for conductor range that can fit with crimp contacts consult Unipole/ Multipole catalogue.

Contacts for couplers

Ref.	Contact type	unipole	multipole
A	Male - Female	○	—
L	Female - Male	○	●
M	Female - Female	●	○

Multipole connectors are fitted with hermaphroditic inserts including male and female contacts. However, by convention, the letter indicating the contact type in the part number composition will be the male contact (reference A) for plugs and female contact (reference A) for sockets. In case of an odd number of contacts, the letter of reference corresponds to the one with the large number of contacts. For example, a 309 type connector with contact (reference A) will include 5 male and 4 female contacts.

For RAD and SWH fixed couplers, the first contact type mentioned is always the one at the flange end.
Connectors can be configured „inverted“ i.e. plugs equipped with female contacts (reference L), sockets with male contacts (reference A). This solution is particularly useful when plugs are mated to a coupler and it is essential to respect contact alignment.

SPANNZANGEN | COLLETS

SERIE Y | SERIES Y



Reference		Serie	Ø Collet (mm)		Ø Cable (mm)		Part number of the collet ¹⁾	Lead time
Type	Ø		Ø A	Ø B	max.	min.		
C	17	1Y	1.7	-	1.6	1.3	FFA.1S.717.CN	○
C	22		2.2	-	2.1	1.7	FFA.1S.722.CN	○
C	27		2.7	-	2.6	2.2	FFA.1S.727.CN	●
C	32		3.2	-	3.1	2.6	FFA.1S.732.CN	●
C	37		3.7	-	3.6	2.7	FFA.1S.737.CN	●
C	42		4.2	-	4.1	3.3	FFA.1S.742.CN	●
C	47		4.7	-	4.6	3.8	FFA.1S.747.CN	●
C	52		5.2	-	5.1	4.3	FFA.1S.752.CN	●
C	57		5.7	-	5.6	4.8	FFA.1S.757.CN	●
C	62		6.2	5.2	6.1	5.3	FFA.1S.762.CN	●
C	66		6.6	5.5	6.5	5.9	FFA.1S.766.CN	●
C	68		6.8	5.5	6.7	6.0	FFA.1S.768.CN	○
C	42	3Y	4.2	-	4.0	3.1	FFA.3S.742.CN	○
C	52		5.2	-	5.0	4.1	FFA.3S.752.CN	●
C	57		5.7	-	5.5	4.6	FFA.3S.757.CN	●
C	62		6.2	-	6.0	5.1	FFA.3S.762.CN	●
C	67		6.7	-	6.5	5.6	FFA.3S.767.CN	●
C	72		7.2	-	7.0	6.1	FFA.3S.772.CN	●
C	77		7.7	-	7.5	6.6	FFA.3S.777.CN	●
C	82		8.2	-	8.0	7.1	FFA.3S.782.CN	●
C	87		8.7	-	8.5	7.6	FFA.3S.787.CN	●
C	92		9.2	8.7	9.0	8.1	FFA.3S.792.CN	●
C	97		9.7	8.7	9.5	9.1	FFA.3S.797.CN	●
C	10		10.2	8.7	10.0	9.6	FFA.3S.710.CN	○
C	11	10.7	8.7	10.5	10.1	FFA.3S.711.CN	●	
C	12	6Y	12.2	12.2	12.0	11.1	FFB.6Y.712.CN	●
C	14		14.2	14.2	14.0	13.1	FFB.6Y.714.CN	●
C	21		21.2	21.2	21.0	20.0	FFB.6Y.721.CN	●
C	27		26.6	23.0	26.4	25.5	FFB.6Y.727.CN	○
C	29		29.0	24.5	28.8	27.9	FFB.6Y.729.CN	○
C	30		30.2	27.2	30.0	29.1	FFB.6Y.730.CN	●

Note:
¹⁾ for ordering collets separately.

- on stock
- on request



Part number example see page 3



SPANNZANGEN | COLLETS
SERIE B | SERIES B

D and M type collets



Reference		Serie	ø Collet (mm)		ø Cable (mm)		Part number of the collet ¹⁾	Part number of the reducer ²⁾	Part number of the reducing cone ²⁾	Part number of the collet nut
Type	ø		ø A	ø B	max.	min.				
M	27	1B	2.7	–	2.6	2.2	FFC.00.727.CN	FGG.1B.138.LN	FGG.1B.158.LN	FGG.1B.130.LC
M	31		3.1	–	3.0	2.6	FFC.00.731.CN	FGG.1B.138.LN	FGG.1B.158.LN	FGG.1B.130.LC
D	42		4.2	–	4.0	3.1	FGG.1B.742.DN	–	–	FGG.1B.130.LC
D	52		5.2	–	5.0	4.1	FGG.1B.752.DN	–	–	FGG.1B.130.LC
D	62		6.2	–	6.0	5.1	FGG.1B.762.DN	–	–	FGG.1B.130.LC
D	72		7.2	6.7	7.0	6.1	FGG.1B.772.DN	–	–	FGG.1B.130.LC
D	76		7.6	6.7	7.5	7.1	FGG.1B.776.DN ³⁾	–	–	FGG.1B.132.LC
M	21	2B	2.1	–	2.0	1.5	FGG.0B.721.DN	FGG.2B.138.LN	FGG.2B.158.LN	FGG.2B.130.LC
M	31		3.1	–	3.0	2.1	FGG.0B.731.DN	FGG.2B.138.LN	FGG.2B.158.LN	FGG.2B.130.LC
M	42		4.2	–	4.0	3.1	FGG.0B.742.DN	FGG.2B.138.LN	FGG.2B.158.LN	FGG.2B.130.LC
D	52		5.2	–	5.0	4.1	FGG.2B.752.DN	–	–	FGG.2B.130.LC
D	62		6.2	–	6.0	5.1	FGG.2B.762.DN	–	–	FGG.2B.130.LC
D	72		7.2	–	7.0	6.1	FGG.2B.772.DN	–	–	FGG.2B.130.LC
D	82		8.2	–	8.0	7.1	FGG.2B.782.DN	–	–	FGG.2B.130.LC
D	92		9.2	8.6	9.0	8.1	FGG.2B.792.DN	–	–	FGG.2B.130.LC
D	99		9.9	8.6	9.7	9.1	FGG.2B.799.DN ³⁾	–	–	FGG.2B.132.LC
M	52	3B	5.2	–	5.0	4.1	FGG.1B.752.DN	FGG.3B.138.LN	FGG.3B.158.LN	FGG.3B.130.LC
D	62		6.2	–	6.0	5.1	FGG.3B.762.DN	–	–	FGG.3B.130.LC
D	72		7.2	–	7.0	6.1	FGG.3B.772.DN	–	–	FGG.3B.130.LC
D	82		8.2	–	8.0	7.1	FGG.3B.782.DN	–	–	FGG.3B.130.LC
D	92		9.2	–	9.0	8.1	FGG.3B.792.DN	–	–	FGG.3B.130.LC
D	10		10.2	–	10.0	9.1	FGG.3B.710.DN	–	–	FGG.3B.130.LC
D	11		11.2	10.2	11.0	10.1	FGG.3B.711.DN	–	–	FGG.3B.130.LC
D	12		11.9	10.2	11.7	11.1	FGG.3B.712.DN ³⁾	–	–	FGG.3B.132.LC

Note:

- ¹⁾ for ordering collets separately.
- ²⁾ for ordering an M type collet, a reducer and its reducing cone should also be ordered.
- ³⁾ these collets cannot be used for connector models with nut for fitting a bend relief.

All dimensions are in millimetres.

SPANNZANGEN | COLLETS
SERIE B | SERIES B



D and M type collets



Reference		Serie	ø Collet (mm)		ø Cable (mm)		Part number of the collet ¹⁾	Part number of the reducer ²⁾	Part number of the reducing cone ²⁾	Part number of the collet nut
Type	ø		ø A	ø B	max.	min.				
M	62	4B	6.2	–	6.0	5.1	FGG.2B.762.DN	FGG.4B.138.LN	FGG.4B.158.LN	FGG.4B.130.LC
M	72		7.2	–	7.0	6.1	FGG.2B.772.DN	FGG.4B.138.LN	FGG.4B.158.LN	FGG.4B.130.LC
M	82		8.2	–	8.0	7.1	FGG.2B.782.DN	FGG.4B.138.LN	FGG.4B.158.LN	FGG.4B.130.LC
M	92		9.2	8.6	9.0	8.1	FGG.2B.792.DN	FGG.4B.138.LN	FGG.4B.158.LN	FGG.4B.130.LC
D	10		10.8	–	10.5	9.1	FGG.4B.710.DN	–	–	FGG.4B.130.LC
D	12		12.3	–	12.0	10.6	FGG.4B.712.DN	–	–	FGG.4B.130.LC
D	13		13.8	12.5	13.5	12.1	FGG.4B.713.DN	–	–	FGG.4B.130.LC
D	15		15.3	12.5	15.0	13.6	FGG.4B.715.DN	–	–	FGG.4B.130.LC
D	16		16.3	12.5	16.0	15.1	FGG.4B.716.DN ³⁾	–	–	FGG.4B.132.LC
D	11	5B	11.8	–	11.5	9.6	FGG.5B.711.DN	–	–	FGG.5B.130.LC
D	13		13.8	–	13.5	11.6	FGG.5B.713.DN	–	–	FGG.5B.130.LC
D	15		15.8	–	15.5	13.6	FGG.5B.715.DN	–	–	FGG.5B.130.LC
D	17		17.8	–	17.5	15.6	FGG.5B.717.DN ³⁾	–	–	FGG.5B.130.LC
D	19		19.8	–	19.5	17.6	FGG.5B.719.DN ³⁾	–	–	FGG.5B.130.LC
D	21		21.8	–	21.5	19.6	FGG.5B.721.DN ³⁾	–	–	FGG.5B.130.LC
D	23		23.8	21.8	23.5	21.6	FGG.5B.723.DN ³⁾	–	–	FGG.5B.130.LC
D	25		25.3	21.8	25.0	23.6	FGG.5B.725.DN ³⁾	–	–	FGG.5B.132.LC

Bend relief collet nut and bend relief



Reference		Serie	Part number of the collet nut	Bend relief to be used ¹⁾
Type	ø			
M	27 and 31	1B	FFM.1B.130.LC	GMA.1B.***.●●
D	42 to 72		FFM.1B.130.LC	GMA.1B.***.●●
M	21 and 31	2B	FFM.2B.132.LC	GMA.0B.***.●●
M	42		FFM.2B.130.LC	GMA.2B.***.●●
D	52 to 92		FFM.2B.130.LC	GMA.2B.***.●●
M	52	3B	FFM.3B.131.LC	GMA.1B.***.●●
D	62 to 11		FFM.3B.130.LC	GMA.3B.***.●●
M	62 and 72	4B	FFM.4B.132.LC	GMA.2B.***.●●
M	82 and 92		FFM.4B.130.LC	GMA.4B.***.●●
D	10 to 15		FFM.4B.130.LC	GMA.4B.***.●●
D	11 to 15	5B	FFM.5B.130.LC	GMA.4B.***.●●

Note:

- ¹⁾ for ordering collet separately.
- ²⁾ for ordering an M type collet, a reducer and its reducing cone should also be ordered.
- ³⁾ these collets cannot be used for connector models with collet nut for fitting a bend relief.

Note:

¹⁾ the bend relief is to be ordered separately (see page 80). All dimensions are in millimetres.



Part number example see page 3



SPANNZANGEN | COLLETS
SERIE K | SERIES K

C + K type collets



Reference		Serie	ø Collet (mm)		ø Cable (mm)		Part number of the collet system ¹⁾	Part number of the oversize collet and of the two split centre-pieces ²⁾	Part number of the collet nut ²⁾
Type	ø		ø A	ø B	max.	min.			
C	15	1K	1.6	–	1.5	1.3	FFA.1E.715.CNS	–	FFA.1E.130.LC
C	20		2.2	–	2.0	1.6	FFA.1E.720.CNS	–	FFA.1E.130.LC
C	25		3.2	–	2.5	2.1	FFA.1E.725.CNS	–	FFA.1E.130.LC
C	30		3.2	–	3.0	2.6	FFA.1E.730.CNS	–	FFA.1E.130.LC
C	35		4.2	–	3.5	3.1	FFA.1E.735.CNS	–	FFA.1E.130.LC
C	40		4.2	–	4.0	3.6	FFA.1E.740.CNS	–	FFA.1E.130.LC
C	45		5.2	–	4.5	4.1	FFA.1E.745.CNS	–	FFA.1E.130.LC
C	50		5.2	–	5.0	4.6	FFA.1E.750.CNS	–	FFA.1E.130.LC
C	55		6.2	6.2	5.5	5.1	FFA.1E.755.CNS	–	FFA.1E.130.LC
C	60		6.2	6.2	6.0	5.6	FFA.1E.760.CNS	–	FFA.1E.130.LC
C	65		7.2	6.7	6.5	6.1	FFA.1E.765.CNS	–	FFA.1E.130.LC
K	70		7.2	–	7.0	6.6	FFA.2E.770.CNS	FFA.1K.137.LCN	FFA.2E.130.LC ²⁾
K	75		8.2	8.2	7.5	7.1	FFA.2E.775.CNS	FFA.1K.137.LCN	FFA.2E.130.LC ²⁾
K	80		8.2	8.2	8.0	7.6	FFA.2E.780.CNS	FFA.1K.137.LCN	FFA.2E.130.LC ²⁾
K	85		9.2	8.6	8.5	8.1	FFA.2E.785.CNS	FFA.1K.137.LCN	FFA.2E.130.LC ²⁾
C	15		2K	2.2	–	1.5	1.3	FFA.2E.715.CNS	–
C	20	2.2		–	2.0	1.6	FFA.2E.720.CNS	–	FFA.2E.130.LC
C	25	3.2		–	2.5	2.1	FFA.2E.725.CNS	–	FFA.2E.130.LC
C	30	3.2		–	3.0	2.6	FFA.2E.730.CNS	–	FFA.2E.130.LC
C	35	4.2		–	3.5	3.1	FFA.2E.735.CNS	–	FFA.2E.130.LC
C	40	4.2		–	4.0	3.6	FFA.2E.740.CNS	–	FFA.2E.130.LC
C	45	5.2		–	4.5	4.1	FFA.2E.745.CNS	–	FFA.2E.130.LC
C	50	5.2		–	5.0	4.6	FFA.2E.750.CNS	–	FFA.2E.130.LC
C	55	6.2		–	5.5	5.1	FFA.2E.755.CNS	–	FFA.2E.130.LC
C	60	6.2		–	6.0	5.6	FFA.2E.760.CNS	–	FFA.2E.130.LC
C	65	7.2		–	6.5	6.1	FFA.2E.765.CNS	–	FFA.2E.130.LC
C	70	7.2		–	7.0	6.6	FFA.2E.770.CNS	–	FFA.2E.130.LC
C	75	8.2		8.2	7.5	7.1	FFA.2E.775.CNS	–	FFA.2E.130.LC
C	80	8.2		8.2	8.0	7.6	FFA.2E.780.CNS	–	FFA.2E.130.LC
C	85	9.2		8.6	8.5	8.1	FFA.2E.785.CNS	–	FFA.2E.130.LC
K	90	9.2		–	9.0	8.6	FFA.3E.790.CNS	FFA.2K.137.LCN	FFA.3E.130.LC ²⁾
K	95	10.2		10.2	9.5	9.1	FFA.3E.795.CNS	FFA.2K.137.LCN	FFA.3E.130.LC ²⁾
K	10	10.2		10.2	10.0	9.6	FFA.3E.710.CNS	FFA.2K.137.LCN	FFA.3E.130.LC ²⁾
K	11	11.2		10.6	11.0	10.1	FFA.3E.711.CNS	FFA.2K.137.LCN	FFA.3E.130.LC ²⁾

Note:

¹⁾ for ordering the collet system separately.

²⁾ for ordering the K type collet, the oversize collet and the split centre-pieces, as well as the corresponding collet nut should also be ordered.
All dimensions are in millimetres.

SPANNZANGEN COLLETS

SERIE K SERIES K



C + K type collets

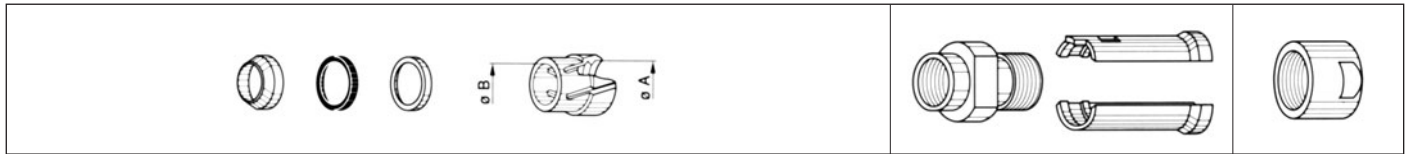

Reference		Serie	ø Collet (mm)		ø Cable (mm)		Part number of the collet system ¹⁾	Part number of the oversize collet and of the two split centre-pieces ²⁾	Part number of the collet nut ²⁾
Type	ø		ø A	ø B	max.	min.			
C	30	3K	3.2	-	3.0	2.6	FFA.3E.730.CNS	-	FFA.3E.130.LC
C	35		4.2	-	3.5	3.1	FFA.3E.735.CNS	-	FFA.3E.130.LC
C	40		4.2	-	4.0	3.6	FFA.3E.740.CNS	-	FFA.3E.130.LC
C	45		5.2	-	4.5	4.1	FFA.3E.745.CNS	-	FFA.3E.130.LC
C	50		5.2	-	5.0	4.6	FFA.3E.750.CNS	-	FFA.3E.130.LC
C	55		6.2	-	5.5	5.1	FFA.3E.755.CNS	-	FFA.3E.130.LC
C	60		6.2	-	6.0	5.6	FFA.3E.760.CNS	-	FFA.3E.130.LC
C	65		7.2	-	6.5	6.1	FFA.3E.765.CNS	-	FFA.3E.130.LC
C	70		7.2	-	7.0	6.6	FFA.3E.770.CNS	-	FFA.3E.130.LC
C	75		8.2	-	7.5	7.1	FFA.3E.775.CNS	-	FFA.3E.130.LC
C	80		8.2	-	8.0	7.6	FFA.3E.780.CNS	-	FFA.3E.130.LC
C	85		9.2	-	8.5	8.1	FFA.3E.785.CNS	-	FFA.3E.130.LC
C	90		9.2	-	9.0	8.6	FFA.3E.790.CNS	-	FFA.3E.130.LC
C	95		10.2	10.2	9.5	9.1	FFA.3E.795.CNS	-	FFA.3E.130.LC
C	10		10.2	10.2	10.0	9.6	FFA.3E.710.CNS	-	FFA.3E.130.LC
C	11		11.2	11.2	10.5	10.1	FFA.3E.711.CNS	-	FFA.3E.130.LC
K	11		12.3	-	12.0	10.6	FFA.4E.711.CNS	FFA.3K.137.LCN	FFA.4E.130.LC ²⁾
K	12		13.8	13.8	12.8	12.1	FFA.4E.712.CNS	FFA.3K.137.LCN	FFA.4E.130.LC ²⁾
K	13		13.8	13.8	13.5	12.9	FFA.4E.713.CNS	FFA.3K.137.LCN	FFA.4E.130.LC ²⁾
K	14		15.3	15.3	14.0	13.6	FFA.4E.714.CNS	FFA.3K.137.LCN	FFA.4E.130.LC ²⁾
K	15	15.3	15.3	15.0	14.1	FFA.4E.715.CNS	FFA.3K.137.LCN	FFA.4E.130.LC ²⁾	
C	50	4K	6.3	-	5.0	4.8	FFA.4E.750.CNS	-	FFA.4E.130.LC
C	55		6.3	-	5.5	5.1	FFA.4E.755.CNS	-	FFA.4E.130.LC
C	60		6.3	-	6.0	5.6	FFA.4E.760.CNS	-	FFA.4E.130.LC
C	65		7.3	-	6.5	6.1	FFA.4E.765.CNS	-	FFA.4E.130.LC
C	70		7.3	-	7.0	6.6	FFA.4E.770.CNS	-	FFA.4E.130.LC
C	75		8.3	-	7.5	7.1	FFA.4E.775.CNS	-	FFA.4E.130.LC
C	80		8.3	-	8.0	7.6	FFA.4E.780.CNS	-	FFA.4E.130.LC
C	85		9.3	-	8.5	8.1	FFA.4E.785.CNS	-	FFA.4E.130.LC
C	90		9.3	-	9.0	8.6	FFA.4E.790.CNS	-	FFA.4E.130.LC
C	95		10.8	-	9.5	9.1	FFA.4E.795.CNS	-	FFA.4E.130.LC
C	10		10.8	-	10.5	9.6	FFA.4E.710.CNS	-	FFA.4E.130.LC
C	11		12.3	-	12.0	10.6	FFA.4E.711.CNS	-	FFA.4E.130.LC
C	12		13.8	13.8	12.8	12.1	FFA.4E.712.CNS	-	FFA.4E.130.LC
C	13		13.8	13.8	13.5	12.9	FFA.4E.713.CNS	-	FFA.4E.130.LC
C	14		15.3	15.3	14.0	13.6	FFA.4E.714.CNS	-	FFA.4E.130.LC
C	15		15.3	15.3	15.0	14.1	FFA.4E.715.CNS	-	FFA.4E.130.LC
K	16		17.8	-	16.5	15.6	FFA.4K.716.CNS	FFA.4K.137.LCN ³⁾	FFA.4K.136.LC ²⁾
K	17		17.8	-	17.5	16.6	FFA.4K.717.CNS	FFA.4K.137.LCN	FFA.4K.136.LC ²⁾
K	18		19.8	-	18.5	17.6	FFA.4K.718.CNS	FFA.4K.137.LCN	FFA.4K.136.LC ²⁾
K	19		19.8	-	19.5	18.6	FFA.4K.719.CNS	FFA.4K.137.LCN	FFA.4K.136.LC ²⁾
K	20		21.8	-	20.5	19.6	FFA.4K.720.CNS	FFA.4K.137.LCN	FFA.4K.136.LC ²⁾
K	21		21.8	-	21.5	20.6	FFA.4K.721.CNS	FFA.4K.137.LCN	FFA.4K.136.LC ²⁾
K	22		23.8	23.8	22.5	21.6	FFA.4K.722.CNS	FFA.4K.137.LCN	FFA.4K.136.LC ²⁾
K	23		23.8	23.8	23.5	22.6	FFA.4K.723.CNS	FFA.4K.137.LCN	FFA.4K.136.LC ²⁾

Note: ¹⁾ for ordering the collet system separately.
²⁾ for ordering the K type collet, the oversize collet and the split centre-pieces, as well as the corresponding collet nut should also be ordered.

³⁾ in 4K series, the centre-piece is made of one piece.

All dimensions are in millimetres.



Part number example see page 3



SPANNZANGEN | COLLETS
SERIE K | SERIES K

C type collets

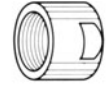

Reference		Serie	ø Collet (mm)		ø Cable (mm)		Part number of the collet system ¹⁾	Part number of the collet nut
Type	ø		ø A	ø B	max.	min.		
C	10	5K	11.8	-	10.5	9.6	FFA.5K.710.CNS	FFA.5K.130.LC
C	11		11.8	-	11.5	10.6	FFA.5K.711.CNS	FFA.5K.130.LC
C	12		13.8	-	12.5	11.6	FFA.5K.712.CNS	FFA.5K.130.LC
C	13		13.8	-	13.5	12.6	FFA.5K.713.CNS	FFA.5K.130.LC
C	14		15.8	-	14.5	13.6	FFA.5K.714.CNS	FFA.5K.130.LC
C	15		15.8	-	15.5	14.6	FFA.5K.715.CNS	FFA.5K.130.LC
C	16		17.8	-	16.5	15.6	FFA.5K.716.CNS	FFA.5K.130.LC
C	17		17.8	-	17.5	16.6	FFA.5K.717.CNS	FFA.5K.130.LC
C	18		19.8	-	18.5	17.6	FFA.5K.718.CNS	FFA.5K.130.LC
C	19		19.8	-	19.5	18.6	FFA.5K.719.CNS	FFA.5K.130.LC
C	20		21.8	-	20.5	19.6	FFA.5K.720.CNS	FFA.5K.130.LC
C	21		21.8	-	21.5	20.6	FFA.5K.721.CNS	FFA.5K.130.LC
C	22		23.8	23.8	22.5	21.6	FFA.5K.722.CNS	FFA.5K.130.LC
C	23		23.8	23.8	23.5	22.6	FFA.5K.723.CNS	FFA.5K.130.LC

Note:

¹⁾ for ordering the collet system separately.

Bend relief collet nut and bend relief

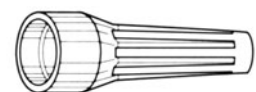
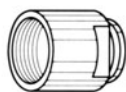

Reference		Serie	Part number of the collet nut	Bend relief to be used ¹⁾
Type	ø			
C	15 to 65	1K	FFM.1E.130.LC	GMA.1B.***.●●
K	70 to 85		FFM.2E.130.LC	GMA.2B.***.●●
C	15 to 85	2K	FFM.2E.130.LC	GMA.2B.***.●●
K	90 to 11		FFM.3E.130.LC	GMA.3B.***.●●
C	30 to 10	3K	FFM.3E.130.LC	GMA.3B.***.●●
K	11 to 15		FFM.4E.130.LC	GMA.4B.***.●●
C	50 to 15	4K	FFM.4E.130.LC	GMA.4B.***.●●

Note:

¹⁾ the bend relief is to be ordered separately (see page 80).
All dimensions are in millimetres.

SPANNZANGEN COLLETS

SERIE S SERIES S



C, K and L type collets

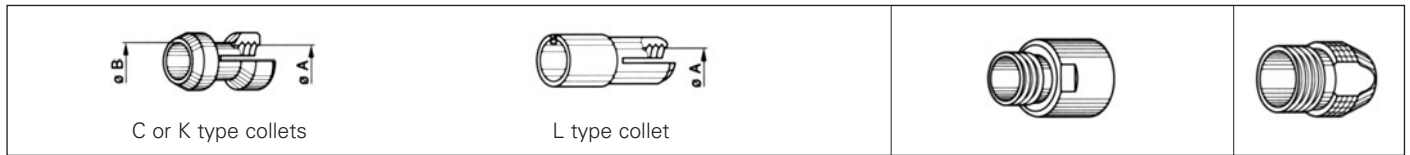

Reference		Serie	ø Collet (mm)		ø Cable (mm)		Part number of the collet ¹⁾	Part number of the oversize collet and of the split centre-pieces ³⁾	Part number of the collet nut ^{3) 5)}
Type	ø		ø A	ø B	max.	min.			
C	17	OS	1.7	–	1.6	1.3	FFA.OS.717.CN	–	FFA.OS.130.LC
C	22		2.2	–	2.1	1.7	FFA.OS.722.CN	–	FFA.OS.130.LC
C	27		2.7	–	2.6	2.2	FFA.OS.727.CN	–	FFA.OS.130.LC
C	32		3.2	–	3.1	2.7	FFA.OS.732.CN	–	FFA.OS.130.LC
C	37		3.7	–	3.6	3.0	FFA.OS.737.CN	–	FFA.OS.130.LC
C	42		4.2	3.7	4.1	3.3	FFA.OS.742.CN	–	FFA.OS.130.LC
C	44		4.4	3.7	4.3	3.5	FFA.OS.744.CN	–	FFA.OS.132.LC
K	47		4.7	–	4.6	3.8	FFA.1S.747.CN	FFA.OS.137.LCN	FFA.1S.130.LC
K	52		5.2	–	5.1	4.3	FFA.1S.752.CN	FFA.OS.137.LCN	FFA.1S.130.LC
K	57		5.7	–	5.6	4.8	FFA.1S.757.CN	FFA.OS.137.LCN	FFA.1S.130.LC
K	62		6.2	5.2	6.1	5.3	FFA.1S.762.CN	FFA.OS.137.LCN	FFA.1S.130.LC
K	66		6.6	5.4	6.5	5.9	FFA.1S.766.CN	FFA.OS.137.LCN	FFA.1S.131.LC
K	68		6.8	–	6.7	6.0	FFA.1S.768.CN	FFA.OS.137.LCN	FFA.1S.131.LC
C	17		1.7	–	1.6	1.3	FLA.OS.717.CN ⁴⁾	–	FFA.OS.130.LC
C	22		2.2	–	2.1	1.7	FLA.OS.722.CN ⁴⁾	–	FFA.OS.130.LC
C	27		2.7	–	2.6	2.2	FLA.OS.727.CN ⁴⁾	–	FFA.OS.130.LC
C	32		3.2	–	3.1	2.7	FLA.OS.732.CN ⁴⁾	–	FFA.OS.130.LC
C	37		3.7	–	3.6	3.0	FLA.OS.737.CN ⁴⁾	–	FFA.OS.130.LC
C	42		4.2	3.7	4.1	3.3	FLA.OS.742.CN ⁴⁾	–	FFA.OS.130.LC
C	44		4.4	3.7	4.3	3.5	FLA.OS.744.CN ⁴⁾	–	FFA.OS.132.LC
L	17		1.7	–	1.6	1.3	FFA.OS.717.LN	–	FFA.OS.130.LC
L	22		2.2	–	2.1	1.7	FFA.OS.722.LN	–	FFA.OS.130.LC
L	27		2.7	–	2.6	2.2	FFA.OS.727.LN	–	FFA.OS.130.LC
L	32		3.2	–	3.1	2.7	FFA.OS.732.LN	–	FFA.OS.130.LC
L	37	3.7	–	3.6	3.0	FFA.OS.737.LN	–	FFA.OS.130.LC	
L	42	4.2	–	4.1	3.3	FFA.OS.742.LN	–	FFA.OS.130.LC	
L	44	4.4	–	4.3	3.5	FFA.OS.744.LN	–	FFA.OS.132.LC	

Note: see following page for text of notes ¹⁾ through ⁵⁾.
All dimensions are in millimetres.



Part number example see page 3



SPANNZANGEN | COLLETS
SERIE S | SERIES S

C, K and L type collets



C or K type collets



L type collet

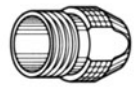
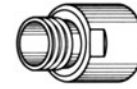

Reference		Serie	ø Collet (mm)		ø Cable (mm)		Part number of the collet ¹⁾	Part number of the oversize collet and of the split centre-pieces ³⁾	Part number of the collet nut ^{3) 5)}
Type	ø		ø A	ø B	max.	min.			
C	17	1S	1.7	–	1.6	1.3	FFA.1S.717.CN	–	FFA.1S.130.LC
C	22		2.2	–	2.1	1.7	FFA.1S.722.CN	–	FFA.1S.130.LC
C	27		2.7	–	2.6	2.2	FFA.1S.727.CN	–	FFA.1S.130.LC
C	32		3.2	–	3.1	2.6	FFA.1S.732.CN	–	FFA.1S.130.LC
C	37		3.7	–	3.6	2.7	FFA.1S.737.CN	–	FFA.1S.130.LC
C	42		4.2	–	4.1	3.3	FFA.1S.742.CN	–	FFA.1S.130.LC
C	47		4.7	–	4.6	3.8	FFA.1S.747.CN	–	FFA.1S.130.LC
C	52		5.2	–	5.1	4.3	FFA.1S.752.CN	–	FFA.1S.130.LC
C	57		5.7	–	5.6	4.8	FFA.1S.757.CN	–	FFA.1S.130.LC
C	62		6.2	5.2	6.1	5.3	FFA.1S.762.CN	–	FFA.1S.130.LC
C	66		6.6	5.4	6.5	5.9	FFA.1S.766.CN	–	FFA.1S.131.LC
C	68		6.8	–	6.7	6.0	FFA.1S.768.CN	–	FFA.1S.131.LC
K	72		7.2	6.7	7.0	6.1	FFA.2S.772.CN	FFA.1S.137.LCN	FFA.2S.130.LC
K	77		7.7	6.7	7.5	7.1	FFA.2S.777.CN	FFA.1S.137.LCN	FFA.2S.130.LC
K	82		8.2	6.7	8.0	7.6	FFA.2S.782.CN	FFA.1S.137.LCN	FFA.2S.130.LC
K	87		8.7	6.7	8.5	8.1	FFA.2S.787.CN	FFA.1S.137.LCN	FFA.2S.130.LC
C	17		1.7	–	1.6	1.3	FLA.1S.717.CN ⁴⁾	–	FFA.1S.130.LC
C	22		2.2	–	2.1	1.7	FLA.1S.722.CN ⁴⁾	–	FFA.1S.130.LC
C	27		2.7	–	2.6	2.2	FLA.1S.727.CN ⁴⁾	–	FFA.1S.130.LC
C	32		3.2	–	3.1	2.6	FLA.1S.732.CN ⁴⁾	–	FFA.1S.130.LC
C	37		3.7	–	3.6	2.7	FLA.1S.737.CN ⁴⁾	–	FFA.1S.130.LC
C	42		4.2	–	4.1	3.3	FLA.1S.742.CN ⁴⁾	–	FFA.1S.130.LC
C	47		4.7	–	4.6	3.8	FLA.1S.747.CN ⁴⁾	–	FFA.1S.130.LC
C	52		5.2	–	5.1	4.3	FLA.1S.752.CN ⁴⁾	–	FFA.1S.130.LC
C	57		5.7	–	5.6	4.8	FLA.1S.757.CN ⁴⁾	–	FFA.1S.130.LC
C	62		6.2	5.2	6.1	5.3	FLA.1S.762.CN ⁴⁾	–	FFA.1S.130.LC
C	66	6.6	5.4	6.5	5.9	FLA.1S.766.CN ⁴⁾	–	FFA.1S.131.LC	
C	68	6.8	5.5	6.7	6.0	FLA.1S.768.CN ⁴⁾	–	FFA.1S.131.LC	
L	17	1.7	–	1.6	1.3	FFA.1S.717.LN	–	FFA.1S.130.LC	
L	22	2.2	–	2.1	1.7	FFA.1S.722.LN	–	FFA.1S.130.LC	
L	27	2.7	–	2.6	2.2	FFA.1S.727.LN	–	FFA.1S.130.LC	
L	32	3.2	–	3.1	2.6	FFA.1S.732.LN	–	FFA.1S.130.LC	
L	37	3.7	–	3.6	2.7	FFA.1S.737.LN	–	FFA.1S.130.LC	
L	42	4.2	–	4.1	3.3	FFA.1S.742.LN	–	FFA.1S.130.LC	
L	47	4.7	–	4.6	3.8	FFA.1S.747.LN	–	FFA.1S.130.LC	
L	50	5.0	–	4.9	4.7	FFA.1S.750.LN	–	FFA.1S.130.LC	
L	52	5.2	–	5.1	4.3	FFA.1S.752.LN	–	FFA.1S.130.LC	
L	57	5.7	–	5.6	4.8	FFA.1S.757.LN	–	FFA.1S.130.LC	
L	62	6.2	–	6.1	5.3	FFA.1S.762.LN	–	FFA.1S.130.LC	
L	66	6.6	–	6.5	5.9	FFA.1S.766.LN	–	FFA.1S.131.LC	

Note:

- ¹⁾ for ordering collets separately.
 - ²⁾ these collets can only be used with the FLA model.
 - ³⁾ for ordering a K type collet separately, the oversize collet and the corresponding collet nut should also be ordered.
 - ⁴⁾ these collets should be used with FLA, FFP and PCP models.
 - ⁵⁾ for models with bend relief, the FFM.●●.130.LC collet nut should be ordered (see page 76).
- All dimensions are in millimetres.

SPANNZANGEN COLLETS
SERIE S | SERIES S

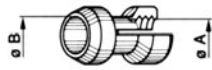
C, K and L type collets

C or K type collets



L type collet

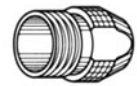
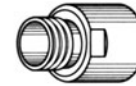

Reference		Serie	ø Collet (mm)		ø Cable (mm)		Part number of the collet ¹⁾	Part number of the oversize collet and of the split centre-pieces ³⁾	Part number of the collet nut ^{3) 5)}
Type	ø		ø A	ø B	max.	min.			
C	17	2S	1.7	–	1.6	1.3	FFA.2S.717.CN	–	FFA.2S.130.LC
C	27		2.7	–	2.5	1.7	FFA.2S.727.CN	–	FFA.2S.130.LC
C	32		3.2	–	3.0	2.5	FFA.2S.732.CN	–	FFA.2S.130.LC
C	42		4.2	–	4.0	3.1	FFA.2S.742.CN	–	FFA.2S.130.LC
C	52		5.2	–	5.0	4.1	FFA.2S.752.CN	–	FFA.2S.130.LC
C	62		6.2	–	6.0	5.1	FFA.2S.762.CN	–	FFA.2S.130.LC
C	72		7.2	6.7	7.0	6.1	FFA.2S.772.CN	–	FFA.2S.130.LC
C	77		7.7	6.7	7.5	7.1	FFA.2S.777.CN	–	FFA.2S.130.LC
C	82		8.2	6.7	8.0	7.6	FFA.2S.782.CN	–	FFA.2S.130.LC
C	87		8.7	6.7	8.5	8.1	FFA.2S.787.CN	–	FFA.2S.130.LC
K	92		9.2	8.7	9.0	8.1	FFA.3S.792.CN	FFA.2S.137.LCN	FFA.3S.130.LC
K	97		9.7	8.7	9.5	9.1	FFA.3S.797.CN	FFA.2S.137.LCN	FFA.3S.130.LC
K	10		10.2	8.7	10.0	9.6	FFA.3S.710.CN	FFA.2S.137.LCN	FFA.3S.130.LC
K	11		10.7	9.0	10.5	10.1	FFA.3S.711.CN	FFA.2S.137.LCN	FFA.3S.130.LC
C	17		1.7	–	1.6	1.3	FLA.2S.717.CN ⁴⁾	–	FFA.2S.130.LC
C	27		2.7	–	2.5	1.7	FLA.2S.727.CN ⁴⁾	–	FFA.2S.130.LC
C	32		3.2	–	3.0	2.5	FLA.2S.732.CN ⁴⁾	–	FFA.2S.130.LC
C	42		4.2	–	4.0	3.1	FLA.2S.742.CN ⁴⁾	–	FFA.2S.130.LC
C	52		5.2	–	5.0	4.1	FLA.2S.752.CN ⁴⁾	–	FFA.2S.130.LC
C	62		6.2	–	6.0	5.1	FLA.2S.762.CN ⁴⁾	–	FFA.2S.130.LC
C	72		7.2	6.7	7.0	6.1	FLA.2S.772.CN ⁴⁾	–	FFA.2S.130.LC
C	77		7.7	6.7	7.5	7.1	FLA.2S.777.CN ⁴⁾	–	FFA.2S.130.LC
C	82		8.2	6.7	8.0	7.6	FLA.2S.782.CN ⁴⁾	–	FFA.2S.130.LC
C	87		8.7	6.7	8.5	8.1	FLA.2S.787.CN ⁴⁾	–	FFA.2S.130.LC
L	27		2.7	–	2.5	1.7	FFA.2S.727.LN	–	FFA.2S.130.LC
L	32		3.2	–	3.0	2.5	FFA.2S.732.LN	–	FFA.2S.130.LC
L	42		4.2	–	4.0	3.1	FFA.2S.742.LN	–	FFA.2S.130.LC
L	52		5.2	–	5.0	4.1	FFA.2S.752.LN	–	FFA.2S.130.LC
L	62		6.2	–	6.0	5.1	FFA.2S.762.LN	–	FFA.2S.130.LC
L	72		7.2	–	7.0	6.1	FFA.2S.772.LN	–	FFA.2S.130.LC
L	77		7.9	–	7.5	7.1	FFA.2S.777.LN	–	FFA.2S.130.LC
L	82		8.2	–	8.0	7.6	FFA.2S.782.LN	–	FFA.2S.130.LC
L	87	8.7	–	8.5	8.1	FFA.2S.787.LN	–	FFA.2S.130.LC	

Note:
¹⁾ for ordering collets separately.

³⁾ for ordering a K type collet separately, the oversize collet and the corresponding collet nut should also be ordered.

⁴⁾ these collets should be used with FLA, FFP and PCP models.

⁵⁾ for models with bend relief, the FFM.●●.130.LC collet nut should be ordered (see page 76).

All dimensions are in millimetres.



Part number example see page 3



SPANNZANGEN | COLLETS
SERIE S | SERIES S

C, K and L type collets

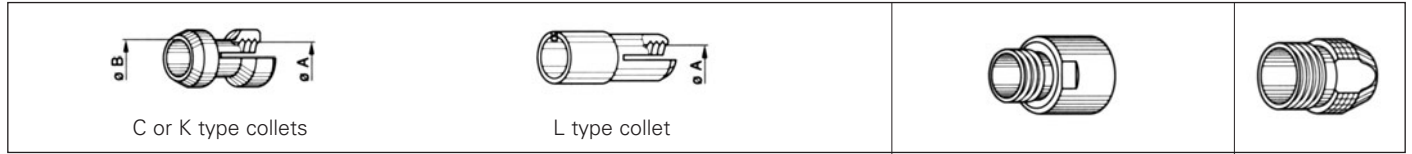

Reference		Serie	ø Collet (mm)		ø Cable (mm)		Part number of the collet ¹⁾	Part number of the oversize collet and of the split centre-pieces ³⁾	Part number of the collet nut ^{3) 5)}
Type	ø		ø A	ø B	max.	min.			
C	32	3S	3.2	–	3.0	2.5	FFA.3S.732.CN	–	FFA.3S.130.LC
C	42		4.2	–	4.0	3.1	FFA.3S.742.CN	–	FFA.3S.130.LC
C	52		5.2	–	5.0	4.1	FFA.3S.752.CN	–	FFA.3S.130.LC
C	62		6.2	–	6.0	5.1	FFA.3S.762.CN	–	FFA.3S.130.LC
C	72		7.2	–	7.0	6.1	FFA.3S.772.CN	–	FFA.3S.130.LC
C	82		8.2	–	8.0	7.1	FFA.3S.782.CN	–	FFA.3S.130.LC
C	92		9.2	8.7	9.0	8.1	FFA.3S.792.CN	–	FFA.3S.130.LC
C	97		9.7	8.7	9.5	9.1	FFA.3S.797.CN	–	FFA.3S.130.LC
C	10		10.2	8.7	10.0	9.6	FFA.3S.710.CN	–	FFA.3S.130.LC
C	11		10.7	9.0	10.5	10.1	FFA.3S.711.CN	–	FFA.3S.130.LC
K	12		12.2	–	12.0	11.1	FFA.4S.712.CN	FFA.3S.137.LCN	FFA.4S.130.LC
K	13		13.2	12.2	13.0	12.1	FFA.4S.713.CN	FFA.3S.137.LCN	FFA.4S.130.LC
C	32		3.2	–	3.0	2.5	FLA.3S.732.CN ⁴⁾	–	FFA.3S.130.LC
C	42		4.2	–	4.0	3.1	FLA.3S.742.CN ⁴⁾	–	FFA.3S.130.LC
C	52		5.2	–	5.0	4.1	FLA.3S.752.CN ⁴⁾	–	FFA.3S.130.LC
C	62		6.2	–	6.0	5.1	FLA.3S.762.CN ⁴⁾	–	FFA.3S.130.LC
C	72		7.2	–	7.0	6.1	FLA.3S.772.CN ⁴⁾	–	FFA.3S.130.LC
C	82		8.2	–	8.0	7.1	FLA.3S.782.CN ⁴⁾	–	FFA.3S.130.LC
C	92		9.2	8.7	9.0	8.1	FLA.3S.792.CN ⁴⁾	–	FFA.3S.130.LC
C	97		9.7	8.7	9.5	9.1	FLA.3S.797.CN ⁴⁾	–	FFA.3S.130.LC
C	10		10.7	8.7	10.5	9.8	FLA.3S.710.CN ⁴⁾	–	FFA.3S.130.LC
C	11		10.7	9.0	10.5	10.1	FLA.3S.711.CN ⁴⁾	–	FFA.3S.130.LC
L	42		4.2	–	4.0	3.1	FFA.3S.742.LN	–	FFA.3S.130.LC
L	52		5.2	–	5.0	4.1	FFA.3S.752.LN	–	FFA.3S.130.LC
L	62		6.2	–	6.0	5.1	FFA.3S.762.LN	–	FFA.3S.130.LC
L	72		7.2	–	7.0	6.1	FFA.3S.772.LN	–	FFA.3S.130.LC
L	82		8.2	–	8.0	7.1	FFA.3S.782.LN	–	FFA.3S.130.LC
L	92		9.2	–	9.0	8.1	FFA.3S.792.LN	–	FFA.3S.130.LC
L	97	9.7	–	9.5	9.1	FFA.3S.797.LN	–	FFA.3S.130.LC	
L	10	10.2	–	10.0	9.6	FFA.3S.710.LN	–	FFA.3S.130.LC	
L	11	10.7	–	10.5	10.1	FFA.3S.711.LN	–	FFA.3S.130.LC	

Note:

- ¹⁾ for ordering collets separately.
 - ³⁾ for ordering a K type collet separately, the oversize collet and the corresponding collet nut should also be ordered.
 - ⁴⁾ these collets should be used with FLA, FFP and PCP models.
 - ⁵⁾ for models with bend relief, the FFM.●●.130.LC collet nut should be ordered (see page 76).
- All dimensions are in millimetres.

SPANNZANGEN COLLETS

SERIE S SERIES S



C, K and L type collets

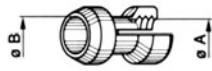

C or K type collet



L type collet

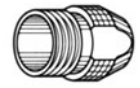
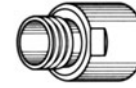

Reference		Serie	ø Collet (mm)		ø Cable (mm)		Part number of the collet ¹⁾	Part number of the oversize collet and of the split centre-pieces ³⁾	Part number of the collet nut ^{3) 5)}
Type	ø		ø A	ø B	max.	min.			
C	52	4S	5.2	-	5.0	4.1	FFA.4S.752.CN	-	FFA.4S.130.LC
C	62		6.2	-	6.0	5.1	FFA.4S.762.CN	-	FFA.4S.130.LC
C	72		7.2	-	7.0	6.1	FFA.4S.772.CN	-	FFA.4S.130.LC
C	82		8.2	-	8.0	7.1	FFA.4S.782.CN	-	FFA.4S.130.LC
C	92		9.2	-	9.0	8.1	FFA.4S.792.CN	-	FFA.4S.130.LC
C	10		10.2	-	10.0	9.1	FFA.4S.710.CN	-	FFA.4S.130.LC
C	11		11.2	-	11.0	10.1	FFA.4S.711.CN	-	FFA.4S.130.LC
C	12		12.2	-	12.0	11.1	FFA.4S.712.CN	-	FFA.4S.130.LC
C	13		13.2	12.2	13.0	12.6	FFA.4S.713.CN	-	FFA.4S.130.LC
K	14		14.2	-	14.0	13.1	FFA.5S.714.CN	FFA.4S.137.LCN	FFA.5S.130.LC
K	15		15.2	-	15.0	14.1	FFA.5S.715.CN	FFA.4S.137.LCN	FFA.5S.130.LC
K	16		16.2	-	16.0	15.1	FFA.5S.716.CN	FFA.4S.137.LCN	FFA.5S.130.LC
K	17		17.2	-	17.0	16.1	FFA.5S.717.CN	FFA.4S.137.LCN	FFA.5S.130.LC
K	18		18.2	-	18.0	17.1	FFA.5S.718.CN	FFA.4S.137.LCN	FFA.5S.130.LC
K	19		19.2	-	19.0	18.1	FFA.5S.719.CN	FFA.4S.137.LCN	FFA.5S.130.LC
K	20		20.2	19.7	20.0	19.1	FFA.5S.720.CN	FFA.4S.137.LCN	FFA.5S.130.LC
K	21		21.2	19.7	21.0	20.1	FFA.5S.721.CN	FFA.4S.137.LCN	FFA.5S.130.LC
K	22		22.2	19.7	22.0	21.1	FFA.5S.722.CN	FFA.4S.137.LCN	FFA.5S.130.LC
C	52		5.2	-	5.0	4.1	FLA.4S.752.CN ⁴⁾	-	FFA.4S.130.LC
C	62		6.2	-	6.0	5.1	FLA.4S.762.CN ⁴⁾	-	FFA.4S.130.LC
C	72		7.2	-	7.0	6.1	FLA.4S.772.CN ⁴⁾	-	FFA.4S.130.LC
C	82		8.2	-	8.0	7.1	FLA.4S.782.CN ⁴⁾	-	FFA.4S.130.LC
C	92		9.2	-	9.0	8.1	FLA.4S.792.CN ⁴⁾	-	FFA.4S.130.LC
C	10		10.2	-	10.0	9.1	FLA.4S.710.CN ⁴⁾	-	FFA.4S.130.LC
C	11		11.2	-	11.0	10.1	FLA.4S.711.CN ⁴⁾	-	FFA.4S.130.LC
C	12		12.2	-	12.0	11.1	FLA.4S.712.CN ⁴⁾	-	FFA.4S.130.LC
C	13		13.2	12.2	13.0	12.6	FLA.4S.713.CN ⁴⁾	-	FFA.4S.130.LC
L	52		5.2	-	5.0	4.1	FFA.4S.752.LN	-	FFA.4S.130.LC
L	62		6.2	-	6.0	5.1	FFA.4S.762.LN	-	FFA.4S.130.LC
L	72		7.2	-	7.0	6.1	FFA.4S.772.LN	-	FFA.4S.130.LC
L	82		8.2	-	8.0	7.1	FFA.4S.782.LN	-	FFA.4S.130.LC
L	92		9.2	-	9.0	8.1	FFA.4S.792.LN	-	FFA.4S.130.LC
L	10	10.2	-	10.0	9.1	FFA.4S.710.LN	-	FFA.4S.130.LC	
L	11	11.2	-	11.0	10.1	FFA.4S.711.LN	-	FFA.4S.130.LC	
L	12	12.2	-	12.0	11.1	FFA.4S.712.LN	-	FFA.4S.130.LC	
L	13	13.2	-	13.0	12.6	FFA.4S.713.LN	-	FFA.4S.130.LC	

Note:
¹⁾ for ordering collets separately.

³⁾ for ordering a K type collet separately, the oversize collet and the corresponding collet nut should also be ordered.

⁴⁾ these collets should be used with FLA, FFP and PCP models.

⁵⁾ for models with bend relief, the FFM.●●.130.LC collet nut should be ordered (see page 76).

All dimensions are in millimetres. These notes also apply to the following page.

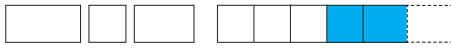

Part number example see page 3



SPANNZANGEN | COLLETS
SERIE S | SERIES S

C and K type collets

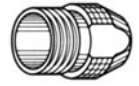
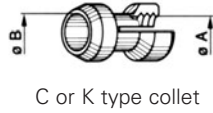

Reference		Serie	ø Collet (mm)		ø Cable (mm)		Part number of the collet ¹⁾	Part number of the oversize collet and of the split centre-pieces ³⁾	Part number of the collet nut ³⁾
Type	ø		ø A	ø B	max.	min.			
C	72	5S	7.2	–	7.0	6.1	FFA.5S.772.CN	–	FFA.5S.130.LC
C	82		8.2	–	8.0	7.1	FFA.5S.782.CN	–	FFA.5S.130.LC
C	92		9.2	–	9.0	8.1	FFA.5S.792.CN	–	FFA.5S.130.LC
C	10		10.2	–	10.0	9.1	FFA.5S.710.CN	–	FFA.5S.130.LC
C	11		11.2	–	11.0	10.1	FFA.5S.711.CN	–	FFA.5S.130.LC
C	12		12.2	–	12.0	11.1	FFA.5S.712.CN	–	FFA.5S.130.LC
C	13		13.2	–	13.0	12.1	FFA.5S.713.CN	–	FFA.5S.130.LC
C	14		14.2	–	14.0	13.1	FFA.5S.714.CN	–	FFA.5S.130.LC
C	15		15.2	–	15.0	14.1	FFA.5S.715.CN	–	FFA.5S.130.LC
C	16		16.2	–	16.0	15.1	FFA.5S.716.CN	–	FFA.5S.130.LC
C	17		17.2	–	17.0	16.1	FFA.5S.717.CN	–	FFA.5S.130.LC
C	18		18.2	–	18.0	17.1	FFA.5S.718.CN	–	FFA.5S.130.LC
C	19		19.2	–	19.0	18.1	FFA.5S.719.CN	–	FFA.5S.130.LC
C	20		20.2	19.7	20.0	19.1	FFA.5S.720.CN	–	FFA.5S.130.LC
C	21		21.2	19.7	21.0	20.1	FFA.5S.721.CN	–	FFA.5S.130.LC
C	22		22.2	19.7	22.0	21.1	FFA.5S.722.CN	–	FFA.5S.130.LC
K	23		23.2	–	23.0	22.1	FFA.6S.723.CN	FFA.5S.137.LCN	FFA.6S.130.LC
K	24		24.2	–	24.0	23.1	FFA.6S.724.CN	FFA.5S.137.LCN	FFA.6S.130.LC
K	25		25.2	–	25.0	24.1	FFA.6S.725.CN	FFA.5S.137.LCN	FFA.6S.130.LC
K	26		26.2	–	26.0	25.1	FFA.6S.726.CN	FFA.5S.137.LCN	FFA.6S.130.LC
K	27		27.2	–	27.0	26.1	FFA.6S.727.CN	FFA.5S.137.LCN	FFA.6S.130.LC
K	28		28.2	27.2	28.0	27.1	FFA.6S.728.CN	FFA.5S.137.LCN	FFA.6S.130.LC
K	29	29.2	27.2	29.0	28.1	FFA.6S.729.CN	FFA.5S.137.LCN	FFA.6S.130.LC	
K	30	30.2	27.2	30.0	29.1	FFA.6S.730.CN	FFA.5S.137.LCN	FFA.6S.130.LC	
C	72	7.2	–	7.0	6.1	FLA.5S.772.CN ²⁾	–	FFA.5S.130.LC	
C	82	8.2	–	8.0	7.1	FLA.5S.782.CN ²⁾	–	FFA.5S.130.LC	
C	92	9.2	–	9.0	8.1	FLA.5S.792.CN ²⁾	–	FFA.5S.130.LC	
C	10	10.2	–	10.0	9.1	FLA.5S.710.CN ²⁾	–	FFA.5S.130.LC	
C	11	11.2	–	11.0	10.1	FLA.5S.711.CN ²⁾	–	FFA.5S.130.LC	
C	12	12.2	–	12.0	11.1	FLA.5S.712.CN ²⁾	–	FFA.5S.130.LC	
C	13	13.2	–	13.0	12.1	FLA.5S.713.CN ²⁾	–	FFA.5S.130.LC	
C	14	14.2	–	14.0	13.1	FLA.5S.714.CN ²⁾	–	FFA.5S.130.LC	
C	15	15.2	–	15.0	14.1	FLA.5S.715.CN ²⁾	–	FFA.5S.130.LC	
C	16	16.2	–	16.0	15.1	FLA.5S.716.CN ²⁾	–	FFA.5S.130.LC	
C	17	17.2	–	17.0	16.1	FLA.5S.717.CN ²⁾	–	FFA.5S.130.LC	
C	18	18.2	–	18.0	17.1	FLA.5S.718.CN ²⁾	–	FFA.5S.130.LC	
C	19	19.2	–	19.0	18.1	FLA.5S.719.CN ²⁾	–	FFA.5S.130.LC	
C	20	20.2	19.7	20.0	19.1	FLA.5S.720.CN ²⁾	–	FFA.5S.130.LC	
C	21	21.2	19.7	21.0	20.1	FLA.5S.721.CN ²⁾	–	FFA.5S.130.LC	
C	22	22.2	19.7	22.0	21.1	FLA.5S.722.CN ²⁾	–	FFA.5S.130.LC	

Continuation on page 76

SPANNZANGEN COLLETS

SERIE S SERIES S



L type collet



L type collet

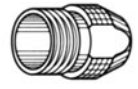

Reference		Serie	ø Collet (mm)		ø Cable (mm)		Part number of the collet ¹⁾	Part number of the oversize collet and of the split centre-pieces ³⁾	Part number of the collet nut ³⁾
Type	ø		ø A	ø B	max.	min.			
L	92	5S	9.2	–	9.0	8.1	FFA.5S.792.LN	–	FFA.5S.130.LC
L	10		10.2	–	10.0	9.1	FFA.5S.710.LN	–	FFA.5S.130.LC
L	11		11.2	–	11.0	10.1	FFA.5S.711.LN	–	FFA.5S.130.LC
L	12		12.2	–	12.0	11.1	FFA.5S.712.LN	–	FFA.5S.130.LC
L	13		13.2	–	13.0	12.1	FFA.5S.713.LN	–	FFA.5S.130.LC
L	14		14.2	–	14.0	13.1	FFA.5S.714.LN	–	FFA.5S.130.LC
L	15		15.2	–	15.0	14.1	FFA.5S.715.LN	–	FFA.5S.130.LC
L	16		16.2	–	16.0	15.1	FFA.5S.716.LN	–	FFA.5S.130.LC
L	17		17.2	–	17.0	16.1	FFA.5S.717.LN	–	FFA.5S.130.LC
L	18		18.2	–	18.0	17.1	FFA.5S.718.LN	–	FFA.5S.130.LC
L	19		19.2	–	19.0	18.1	FFA.5S.719.LN	–	FFA.5S.130.LC
L	20		20.2	–	20.0	19.1	FFA.5S.720.LN	–	FFA.5S.130.LC
L	21		21.2	–	21.0	20.1	FFA.5S.721.LN	–	FFA.5S.130.LC

Bend relief nut and bend relief

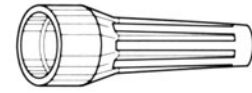
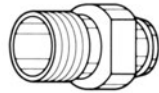

Reference		Serie	Part number of the collet nut	Bend relief to be used ¹⁾
Type	ø			
C	27 to 42	0S	FFM.0S.130.LC	GMA.0B.0••.D•
K	47 to 62		FFM.1S.130.LC	GMA.1B.0••.D•
L	27 to 42		FFM.0S.130.LC	GMA.0B.0••.D•
C	27 to 62	1S	FFM.1S.130.LC	GMA.1B.0••.D•
K	72 to 82		FFM.2S.130.LC	GMA.2B.0••.D•
L	27 to 62		FFM.1S.130.LC	GMA.1B.0••.D•
C	42 to 82	2S	FFM.2S.130.LC	GMA.2B.0••.D•
K	92 to 10		FFM.3S.130.LC	GMA.3B.0••.D•
L	42 to 82		FFM.2S.130.LC	GMA.2B.0••.D•
C	52 to 10	3S	FFM.3S.130.LC	GMA.3B.0••.D•
K	12 to 13		FFM.4S.130.LC	GMA.4B.0••.D•
L	52 to 10		FFM.3S.130.LC	GMA.3B.0••.D•
C	82 to 13	4S	FFM.4S.130.LC	GMA.4B.0••.D•
L	82 to 13		FFM.4S.130.LC	GMA.4B.0••.D•

Note:
¹⁾ the bend relief is to be ordered separately (see page 80).



Part number example see page 3



SPANNZANGEN | COLLETS
SERIE E | SERIES E

C and K type collets



Reference		Serie	ø Collet (mm)		ø Cable (mm)		Part number of the collet system ¹⁾	Part number of the oversize collet and of the split centre-pieces ²⁾	Part number of the collet nut ²⁾	
Type	ø		ø A	ø B	max.	min.				
C	10	0E	1.6	–	1.2	1.0	FFA.0E.710.CNS	–	FFA.00.130.LC	
C	15		1.6	–	1.5	1.3	FFA.0E.715.CNS	–	FFA.00.130.LC	
C	20		2.1	–	2.0	1.6	FFA.0E.720.CNS	–	FFA.00.130.LC	
C	25		3.1	–	2.5	2.1	FFA.0E.725.CNS	–	FFA.00.130.LC	
C	30		3.1	–	3.0	2.6	FFA.0E.730.CNS	–	FFA.00.130.LC	
C	35		4.2	4.2	3.5	3.1	FFA.0E.735.CNS	–	FFA.00.130.LC	
C	40		4.2	4.2	4.0	3.6	FFA.0E.740.CNS	–	FFA.00.130.LC	
C	45		5.2	5.2	4.5	4.1	FFA.0E.745.CNS	–	FFA.00.130.LC	
C	50		5.2	5.2	5.0	4.6	FFA.0E.750.CNS	–	FFA.00.130.LC	
C	15	1E	1.6	–	1.5	1.3	FFA.1E.715.CNS	–	FFA.1E.130.LC	
C	20		2.2	–	2.0	1.6	FFA.1E.720.CNS	–	FFA.1E.130.LC	
C	25		3.2	–	2.5	2.1	FFA.1E.725.CNS	–	FFA.1E.130.LC	
C	30		3.2	–	3.0	2.6	FFA.1E.730.CNS	–	FFA.1E.130.LC	
C	35		4.2	–	3.5	3.1	FFA.1E.735.CNS	–	FFA.1E.130.LC	
C	40		4.2	–	4.0	3.6	FFA.1E.740.CNS	–	FFA.1E.130.LC	
C	45		5.2	–	4.5	4.1	FFA.1E.745.CNS	–	FFA.1E.130.LC	
C	50		5.2	–	5.0	4.6	FFA.1E.750.CNS	–	FFA.1E.130.LC	
C	55		6.2	6.2	5.5	5.1	FFA.1E.755.CNS	–	FFA.1E.130.LC	
C	60		6.2	6.2	6.0	5.6	FFA.1E.760.CNS	–	FFA.1E.130.LC	
C	65		7.2	6.7	6.5	6.1	FFA.1E.765.CNS	–	FFA.1E.130.LC	
K	70		7.2	–	7.0	6.6	FFA.2E.770.CNS	FFA.1E.137.LCN	FFA.2E.130.LC	
K	75		8.2	8.2	7.5	7.1	FFA.2E.775.CNS	FFA.1E.137.LCN	FFA.2E.130.LC	
K	80		8.2	8.2	8.0	7.6	FFA.2E.780.CNS	FFA.1E.137.LCN	FFA.2E.130.LC	
K	85		9.2	8.6	8.5	8.1	FFA.2E.785.CNS	FFA.1E.137.LCN	FFA.2E.130.LC	
C	15		2E	2.2	–	1.5	1.3	FFA.2E.715.CNS	–	FFA.2E.130.LC
C	20			2.2	–	2.0	1.6	FFA.2E.720.CNS	–	FFA.2E.130.LC
C	25	3.2		–	2.5	2.1	FFA.2E.725.CNS	–	FFA.2E.130.LC	
C	30	3.2		–	3.0	2.6	FFA.2E.730.CNS	–	FFA.2E.130.LC	
C	35	4.2		–	3.5	3.1	FFA.2E.735.CNS	–	FFA.2E.130.LC	
C	40	4.2		–	4.0	3.6	FFA.2E.740.CNS	–	FFA.2E.130.LC	
C	45	5.2		–	4.5	4.1	FFA.2E.745.CNS	–	FFA.2E.130.LC	
C	50	5.2		–	5.0	4.6	FFA.2E.750.CNS	–	FFA.2E.130.LC	
C	55	6.2		–	5.5	5.1	FFA.2E.755.CNS	–	FFA.2E.130.LC	
C	60	6.2		–	6.0	5.6	FFA.2E.760.CNS	–	FFA.2E.130.LC	
C	65	7.2		–	6.5	6.1	FFA.2E.765.CNS	–	FFA.2E.130.LC	
C	70	7.2		–	7.0	6.6	FFA.2E.770.CNS	–	FFA.2E.130.LC	
C	75	8.2		8.2	7.5	7.1	FFA.2E.775.CNS	–	FFA.2E.130.LC	
C	80	8.2		8.2	8.0	7.6	FFA.2E.780.CNS	–	FFA.2E.130.LC	
C	85	9.2		8.6	8.5	8.1	FFA.2E.785.CNS	–	FFA.2E.130.LC	
K	90	9.2		–	9.0	8.6	FFA.3E.790.CNS	FFA.2E.137.LCN	FFA.3E.130.LC	
K	95	10.2		10.2	9.5	9.1	FFA.3E.795.CNS	FFA.2E.137.LCN	FFA.3E.130.LC	
K	10	10.2		10.2	10.0	9.6	FFA.3E.710.CNS	FFA.2E.137.LCN	FFA.3E.130.LC	
K	11	11.2		10.6	11.0	10.1	FFA.3E.711.CNS	FFA.2E.137.LCN	FFA.3E.130.LC	

Note:

¹⁾ for ordering the collet system separately.

²⁾ for ordering a K type collet separately, the oversize collet and the corresponding collet nut should also be ordered (see page 79).

All dimensions are in millimetres.

SPANNZANGEN COLLETS

SERIE E SERIES E



C and K type collets



Reference		Serie	ø Collet (mm)		ø Cable (mm)		Part number of the collet system ¹⁾	Part number of the oversize collet and of the split centre-pieces ²⁾	Part number of the collet nut ²⁾
Type	ø		ø A	ø B	max.	min.			
C	30	3E	3.2	-	3.0	2.6	FFA.3E.730.CNS	-	FFA.3E.130.LC
C	35		4.2	-	3.5	3.1	FFA.3E.735.CNS	-	FFA.3E.130.LC
C	40		4.2	-	4.0	3.6	FFA.3E.740.CNS	-	FFA.3E.130.LC
C	45		5.2	-	4.5	4.1	FFA.3E.745.CNS	-	FFA.3E.130.LC
C	50		5.2	-	5.0	4.6	FFA.3E.750.CNS	-	FFA.3E.130.LC
C	55		6.2	-	5.5	5.1	FFA.3E.755.CNS	-	FFA.3E.130.LC
C	60		6.2	-	6.0	5.6	FFA.3E.760.CNS	-	FFA.3E.130.LC
C	65		7.2	-	6.5	6.1	FFA.3E.765.CNS	-	FFA.3E.130.LC
C	70		7.2	-	7.0	6.6	FFA.3E.770.CNS	-	FFA.3E.130.LC
C	75		8.2	-	7.5	7.1	FFA.3E.775.CNS	-	FFA.3E.130.LC
C	80		8.2	-	8.0	7.6	FFA.3E.780.CNS	-	FFA.3E.130.LC
C	85		9.2	-	8.5	8.1	FFA.3E.785.CNS	-	FFA.3E.130.LC
C	90		9.2	-	9.0	8.6	FFA.3E.790.CNS	-	FFA.3E.130.LC
C	95		10.2	10.2	9.5	9.1	FFA.3E.795.CNS	-	FFA.3E.130.LC
C	10		10.2	10.2	10.0	9.6	FFA.3E.710.CNS	-	FFA.3E.130.LC
C	11		11.2	11.2	11.0	10.1	FFA.3E.711.CNS	-	FFA.3E.130.LC
K	11		12.3	-	12.0	10.6	FFA.4E.711.CNS	FFA.3E.137.LCN	FFA.4E.130.LC
K	12		13.8	13.8	12.8	12.1	FFA.4E.712.CNS	FFA.3E.137.LCN	FFA.4E.130.LC
K	13	13.8	13.8	13.5	12.9	FFA.4E.713.CNS	FFA.3E.137.LCN	FFA.4E.130.LC	
K	14	15.3	15.3	14.0	13.6	FFA.4E.714.CNS	FFA.3E.137.LCN	FFA.4E.130.LC	
K	15	15.3	15.3	15.0	14.1	FFA.4E.715.CNS	FFA.3E.137.LCN	FFA.4E.130.LC	
C	50	4E	6.3	-	5.0	4.6	FFA.4E.750.CNS	-	FFA.4E.130.LC
C	55		6.3	-	5.5	5.1	FFA.4E.755.CNS	-	FFA.4E.130.LC
C	60		6.3	-	6.0	5.6	FFA.4E.760.CNS	-	FFA.4E.130.LC
C	65		7.3	-	6.5	6.1	FFA.4E.765.CNS	-	FFA.4E.130.LC
C	70		7.3	-	7.0	6.6	FFA.4E.770.CNS	-	FFA.4E.130.LC
C	75		8.3	-	7.5	7.1	FFA.4E.775.CNS	-	FFA.4E.130.LC
C	80		8.3	-	8.0	7.6	FFA.4E.780.CNS	-	FFA.4E.130.LC
C	85		9.3	-	8.5	8.1	FFA.4E.785.CNS	-	FFA.4E.130.LC
C	90		9.3	-	9.0	8.6	FFA.4E.790.CNS	-	FFA.4E.130.LC
C	95		10.8	-	9.5	9.1	FFA.4E.795.CNS	-	FFA.4E.130.LC
C	10		10.8	-	10.5	9.6	FFA.4E.710.CNS	-	FFA.4E.130.LC
C	11		12.3	-	12.0	10.6	FFA.4E.711.CNS	-	FFA.4E.130.LC
C	12		13.8	13.8	12.8	12.1	FFA.4E.712.CNS	-	FFA.4E.130.LC
C	13		13.8	13.8	13.5	12.9	FFA.4E.713.CNS	-	FFA.4E.130.LC
C	14		15.3	15.3	14.0	13.6	FFA.4E.714.CNS	-	FFA.4E.130.LC
C	15		15.3	15.3	15.0	14.1	FFA.4E.715.CNS	-	FFA.4E.130.LC
K	16		17.8	-	16.5	15.6	FFA.4K.716.CNS	FFA.4E.137.LCN ³⁾	FFA.4K.136.LC
K	17		17.8	-	17.5	16.6	FFA.4K.717.CNS	FFA.4E.137.LCN	FFA.4K.136.LC
K	18		19.8	-	18.5	17.6	FFA.4K.718.CNS	FFA.4E.137.LCN	FFA.4K.136.LC
K	19		19.8	-	19.5	18.6	FFA.4K.719.CNS	FFA.4E.137.LCN	FFA.4K.136.LC
K	20		21.8	-	20.5	19.6	FFA.4K.720.CNS	FFA.4E.137.LCN	FFA.4K.136.LC
K	21		21.8	-	21.5	20.6	FFA.4K.721.CNS	FFA.4E.137.LCN	FFA.4K.136.LC
K	22		23.8	23.8	22.5	21.6	FFA.4K.722.CNS	FFA.4E.137.LCN	FFA.4K.136.LC
K	23	23.8	23.8	23.5	22.6	FFA.4K.723.CNS	FFA.4E.137.LCN	FFA.4K.136.LC	

Note: ¹⁾ for ordering the collet system separately.

²⁾ for ordering a K type collet separately, the oversize collet and the corresponding collet nut should also be ordered (see page 79).

³⁾ in 4E series, the centre-piece is made of one piece. All dimensions are in millimetres.



Part number example see page 3



SPANNZANGEN | COLLETS
SERIE E | SERIES E

C type collets

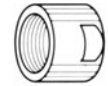

Reference		Serie	ø Collet (mm)		ø Cable (mm)		Part number of the collet system ¹⁾	Part number of the collet nut
Type	ø		ø A	ø B	max.	min.		
C	10	5E	11.8	–	10.5	9.6	FFA.5K.710.CNS	FFA.5K.130.LC
C	11		11.8	–	11.5	10.6	FFA.5K.711.CNS	FFA.5K.130.LC
C	12		13.8	–	12.5	11.6	FFA.5K.712.CNS	FFA.5K.130.LC
C	13		13.8	–	13.5	12.6	FFA.5K.713.CNS	FFA.5K.130.LC
C	14		15.8	–	14.5	13.6	FFA.5K.714.CNS	FFA.5K.130.LC
C	15		15.8	–	15.5	14.6	FFA.5K.715.CNS	FFA.5K.130.LC
C	16		17.8	–	16.5	15.6	FFA.5K.716.CNS	FFA.5K.130.LC
C	17		17.8	–	17.5	16.6	FFA.5K.717.CNS	FFA.5K.130.LC
C	18		19.8	–	18.5	17.6	FFA.5K.718.CNS	FFA.5K.130.LC
C	19		19.8	–	19.5	18.6	FFA.5K.719.CNS	FFA.5K.130.LC
C	20		21.8	–	20.5	19.6	FFA.5K.720.CNS	FFA.5K.130.LC
C	21		21.8	–	21.5	20.6	FFA.5K.721.CNS	FFA.5K.130.LC
C	22		23.8	23.8	22.5	21.6	FFA.5K.722.CNS	FFA.5K.130.LC
C	23		23.8	23.8	23.5	22.6	FFA.5K.723.CNS	FFA.5K.130.LC

Note:

¹⁾ for ordering the collet system separately.

Bend relief nut and bend relief

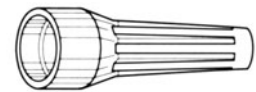
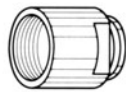

Reference		Serie	Part number of the collet nut	Bend relief to be used ¹⁾
Type	ø			
C	10 to 50	0E	FFM.0E.130.LC	GMA.0B.***.**
C	15 to 65	1E	FFM.1E.130.LC	GMA.1B.***.**
K	70 to 85		FFM.2E.130.LC	GMA.2B.***.**
C	15 to 85	2E	FFM.2E.130.LC	GMA.2B.***.**
K	90 to 11		FFM.3E.130.LC	GMA.3B.***.**
C	30 to 10	3E	FFM.3E.130.LC	GMA.3B.***.**
K	11 to 15		FFM.4E.130.LC	GMA.4B.***.**
C	50 to 15	4E	FFM.4E.130.LC	GMA.4B.***.**

Note:

¹⁾ the bend relief is to be ordered separately (see page 80).
All dimensions are in millimetres.



KATALOGÜBERSICHT CATALOG SUMMARY

Please request the appropriate catalog from our marketing department, or directly: www.lemo.de

Connectors

- F-Series – Harsh Environment Connectors
- Special cable and fibre optic cable
- Thermo Series – for the highest measure range in temperature
- Multifunctional connector combinations for the CAMAC-technology
- Connectors, Audio-Video
- P-Series (REDEL)
- Unipole & Multipole Connectors

Fibre optic connectors

Monomode and Multimode according to LEMO-Push-Pull-System

Coaxial Connectors

(COELVER)

Bitte fordern Sie Ihren entsprechenden Katalog von unserer Marketing-Abteilung an, oder direkt unter: www.lemo.de

Steckverbindungen

- F-Serie – Für harte Anwendungsgebiete
- Spezialkabel und LWL-Leitungen
- Serie Thermo für höchste Temperatur-Messbereiche
- Vielseitige Steckkombinationen in der CAMAC-Technik
- Connectors, Audio-Video
- P-Series (REDEL)
- Unipole & Multipole Connectors

Glasfaser-Steckverbindungen

Monomode und Multimode nach dem LEMO-Push-Pull-System

Koaxial Steckverbinder

(COELVER)



LEMO HEADQUARTERS

SWITZERLAND

LEMO SA

Chemin des Champs-Courbes 28 - P.O. Box 194 - CH-1024 Ecublens
Tel. (+41 21) 695 16 00 - Fax (+41 21) 695 16 02 - e-mail: info@lemo.com

LEMO SUBSIDIARIES

AUSTRIA

LEMO Elektronik GesmbH

Ameisgasse 49-51 / DG1
1140 Wien
Tel: (+43 1) 914 23 20 0
Fax: (+43 1) 911 70 90
sales@lemo.at

LEMO JAPAN Ltd

2-7-22, Mita,
Minato-ku, Tokyo
108-0073 JAPAN
81-3-5446-5510
81-3-5446-5511

LEMO Trading (Shanghai) Co., Ltd.

5th Floor, Block 6, City of ELITE,
1000 Jinhai Road
Shanghai, China 201206
(86 21) 5899 7721
(86 21) 5899 7727

LEMO Connectors Nederland BV

De Trompet 1060
1967 DA Heemskerk
(31) 251 25 78 20
(31) 251 25 78 21

DENMARK

LEMO Denmark A/S

Gammel Mosevej 46
2820 Gentofte
Tel: (+45) 45 20 44 00
Fax: (+45) 45 20 44 01
info-dk@lemo.com

NORWAY / ICELAND

LEMO Norway A/S

Stanseveien 6B
0975 Oslo
Tel: (+47) 22 91 70 40
Fax: (+47) 22 91 70 41
info-no@lemo.com

FRANCE

LEMO France Sàrl

165, avenue Jean Jaurès
94700 Maisons Alfort
Tel: (+33 1) 45 17 27 90
Fax: (+33 1) 45 17 27 99
info-fr@lemo.com

SPAIN / PORTUGAL

IBERLEMO S.A.

Brasil, 45, 08402 Granollers
Barcelona
Tel: (+34 93) 860 44 20
Fax: (+34 93) 879 10 77
info-es@lemo.com

GERMANY

LEMO Elektronik GmbH

Hanns-Schwindt-Str. 6
81829 München
Tel: (+49 89) 42 77 03
Fax: (+49 89) 420 21 92
info@lemo.de

SWEDEN / FINLAND

LEMO Nordic AB

Mariehällsvägen 39A
168 65 Bromma
Tel: (+46 8) 635 60 60
Fax: (+46 8) 635 60 61
info-se@lemo.com

HONG KONG

LEMO Hong Kong Ltd.

Room 33, 7th Floor
HITEC, 1 Trademart Drive
Kowloon Bay - Hong Kong
Tel: (+852) 21 74 04 68
Fax: (+852) 21 74 04 92
hk.sales@lemo.com

SWITZERLAND

LEMO Verkauf AG

Grundstrasse 22 B
6343 Rotkreuz
Tel: (+41 41) 790 49 40
Fax: (+41 41) 790 49 43
ch.sales@lemo.com

HUNGARY

REDEL Elektronika Kft

Vágóhíd u. 26
1201 Budapest XX.
Tel: (+36 1) 421 47 10
Fax: (+36 1) 421 47 57
info-hu@lemo.com

UNITED KINGDOM

LEMO UK Ltd

Unit 15 & 16
Hazelwood Trading Estate
Worthing
West Sussex, BN14 8NP
Tel: (+44 1903) 23 45 43
Fax: (+44 1903) 20 62 31
lemo-uk@lemo.com

ITALY

LEMO Italia srl

Viale Lunigiana 25
20125 Milano
Tel: (+39 02) 66 71 10 46
Fax: (+39 02) 66 71 10 66
sales.it@lemo.com

USA

LEMO USA Inc

P.O. Box 2408
Rohnert Park
CA 94927-2408
Tel: (+1 707) 578 88 11
(+1 800) 444 53 66
Fax: (+1 707) 578 03 69
info@lemousa.com

LEMO DISTRIBUTORS

AUSTRALIA, BRAZIL, CANADA, CZECH REPUBLIC, GREECE, INDIA, ISRAEL,
MALAYSIA, NEW ZEALAND, PHILIPPINES, POLAND, RUSSIA, SINGAPORE,
SOUTH AFRICA, SOUTH KOREA, TAIWAN, THAILAND, TURKEY, UKRAINE



Mouser Electronics

Authorized Distributor

Click to View Pricing, Inventory, Delivery & Lifecycle Information:

LEMO:

[FFA.1S.305.CLAC27](#) [FFA.1S.304.CLAZ](#) [FFA.4S.842.ZLA1](#) [FFA.1E.303.CLAC35](#) [ERA.1S.408.CLL](#)
[FFA.2C.314.CLAC80Z](#) [FFA.1S.305.CLAC66](#) [FFA.0E.250.CTAC30Z](#) [FFA.1S.304.CLAC52Z](#) [FFA.1E.302.CLAC50](#)
[FFA.1S.304.CLAC32](#) [FFA.00.250.NTAC29Z](#) [FFA.4S.313.ZLA](#) [FFA.1S.303.CLAL42](#) [FFA.0S.302.CLAK57](#)
[FFA.0S.303.CLAK52](#) [FFA.0S.304.CLAK52](#) [FFA.2S.310.CLAC52](#) [FFA.2E.702.CJAC70Z](#) [FFA.1S.303.CLAC47](#)
[FFA.00.250.CTAC27](#) [ERA.0S.403.CLL](#) [FFA.0E.730.CNS](#) [EGG.3B.718.CJL](#) [FFA.1E.302.CLAC65Z](#)
[FFA.2S.305.CLAC42](#) [FFA.1S.302.CLAC52](#) [FFA.1S.130.LC](#) [FFA.0S.137.LCN](#) [FFA.0S.302.CLAK68](#) [EGG.1B.731.CJL](#)
[EGG.1B.731.ZJL](#) [EGG.2B.704.CLL](#) [ERA.0S.403.CTL](#) [ERA.1Y.405.CTL](#) [ERA.1Y.410.CLL](#) [ERA.1Y.410.CTA](#)
[ERA.1Y.410.CTL](#) [ERA.1Y.416.CLL](#) [ERA.1Y.416.CLL37](#) [ERA.3E.734.CJL](#) [ERA.3Y.260.CZZ](#) [ERA.3Y.430.CTA](#)
[ERA.3Y.430.CTL](#) [ERA.3Y.430.CTLZ](#) [ERA.3Y.487.HT](#) [ERA.6Y.450.CLL](#) [ERD.3Y.415.CTLM](#) [FFA.00.010.CZZN22](#)
[FFA.00.110.CZZ](#) [FFA.00.110.KZZ](#) [FFA.00.110.NZZ](#) [FFA.00.113.CLAC22](#) [FFA.00.113.CLAC27](#) [FFA.00.113.CLAC29](#)
[FFA.00.113.CLAC31](#) [FFA.00.113.CLAK37Z](#) [FFA.00.113.CTAC22](#) [FFA.00.113.CTAC22Z](#) [FFA.00.113.CTAC27](#)
[FFA.00.113.CTAC27Z](#) [FFA.00.113.CTAC29](#) [FFA.00.113.CTAC29Z](#) [FFA.00.113.CTAC31](#) [FFA.00.113.CTAC31Z](#)
[FFA.00.113.ZLA](#) [FFA.00.113.ZNA](#) [FFA.00.113.ZTA](#) [FFA.00.130.LC](#) [FFA.00.130.LD](#) [FFA.00.130.LN](#) [FFA.00.137.LC](#)
[FFA.00.137.LCN](#) [FFA.00.151.LN](#) [FFA.00.152.LN](#) [FFA.00.250.CLAC22](#) [FFA.00.250.CLAC22Z](#)
[FFA.00.250.CLAC27Z](#) [FFA.00.250.CLAC31](#) [FFA.00.250.CLLC29](#) [FFA.00.250.CTAC22](#) [FFA.00.250.CTAC22Z](#)
[FFA.00.250.CTAC27Z](#) [FFA.00.250.CTAC31](#) [FFA.00.250.CTAC31Z](#) [FFA.00.250.CTAK37](#) [FFA.00.250.CTAK37Z](#)
[FFA.00.250.CTAK42](#) [FFA.00.250.CTAK42Z](#) [FFA.00.250.CTAZ](#) [FFA.00.250.CTAZZ](#) [FFA.00.250.CTLC22](#)
[FFA.00.250.CTLC22Z](#) [FFA.00.250.CTLC27](#) [FFA.00.250.CTLC27Z](#) [FFA.00.250.CTLC29](#) [FFA.00.250.CTLC29Z](#)
[FFA.00.250.DTAC15](#) [FFA.00.250.DTAC22](#) [FFA.00.250.DTAC22Z](#)



Компания «ЭлектроПласт» предлагает заключение долгосрочных отношений при поставках импортных электронных компонентов на взаимовыгодных условиях!

Наши преимущества:

- Оперативные поставки широкого спектра электронных компонентов отечественного и импортного производства напрямую от производителей и с крупнейших мировых складов;
- Поставка более 17-ти миллионов наименований электронных компонентов;
- Поставка сложных, дефицитных, либо снятых с производства позиций;
- Оперативные сроки поставки под заказ (от 5 рабочих дней);
- Экспресс доставка в любую точку России;
- Техническая поддержка проекта, помощь в подборе аналогов, поставка прототипов;
- Система менеджмента качества сертифицирована по Международному стандарту ISO 9001;
- Лицензия ФСБ на осуществление работ с использованием сведений, составляющих государственную тайну;
- Поставка специализированных компонентов (Xilinx, Altera, Analog Devices, Intersil, Interpoint, Microsemi, Aeroflex, Peregrine, Syfer, Eurofarad, Texas Instrument, Miteq, Cobham, E2V, MA-COM, Hittite, Mini-Circuits, General Dynamics и др.);

Помимо этого, одним из направлений компании «ЭлектроПласт» является направление «Источники питания». Мы предлагаем Вам помощь Конструкторского отдела:

- Подбор оптимального решения, техническое обоснование при выборе компонента;
- Подбор аналогов;
- Консультации по применению компонента;
- Поставка образцов и прототипов;
- Техническая поддержка проекта;
- Защита от снятия компонента с производства.



Как с нами связаться

Телефон: 8 (812) 309 58 32 (многоканальный)

Факс: 8 (812) 320-02-42

Электронная почта: org@eplast1.ru

Адрес: 198099, г. Санкт-Петербург, ул. Калинина, дом 2, корпус 4, литера А.