



# LUXEON CoB with CrispWhite Technology (Gen 2)

Fashion retail lighting that makes an impact, revealing the whitest whites

The second generation of LUXEON CoB with CrispWhite Technology creates the most impactful retail lighting ever available by revealing the whitest whites. LUXEON CoB with CrispWhite Technology delivers a natural crisp whiteness by activating Fluorescent Whitening Agents (FWAs) in paints and fabrics to attractively display merchandise in retail shops; ideal for CDM/CMH replacement.



## FEATURES AND BENEFITS

Lumen packages from 500 to 5,000 lumens for a range of options

Industry's smallest Light Emitting Surface (LES) for highest flux densities

Up to 4x lower thermal resistance than competitors, enabling smaller heatsinks and higher lumens

Contains violet LEDs and does NOT contain UV LEDs for minimal amount of damage, much lower than any traditional CDM shop lighting

Mouse bites for M2 and M3 make it easy to work with

## PRIMARY APPLICATIONS

Spotlights

Track Lights

Downlights

Retrofit Lamps

# Table of Contents

<b>General Product Information</b> .....	<b>2</b>
Product Test Conditions .....	2
Part Number Nomenclature .....	2
Lumen Maintenance .....	2
Environmental Compliance .....	2
<b>Performance Characteristics</b> .....	<b>3</b>
Product Selection Guide .....	3
Optical Characteristics .....	3
Electrical and Thermal Characteristics .....	4
<b>Absolute Maximum Ratings</b> .....	<b>4</b>
<b>Characteristic Curves</b> .....	<b>5</b>
Spectral Power Distribution Characteristics .....	5
Light Output Characteristics .....	5
Forward Current Characteristics .....	8
Radiation Pattern Characteristics .....	10
<b>Color Bin Definitions</b> .....	<b>11</b>
<b>Mechanical Dimensions</b> .....	<b>12</b>
<b>Packaging and Labeling Information</b> .....	<b>14</b>
Tube Dimensions .....	14
Inner Box .....	16
Outer Box .....	17

# General Product Information

## Product Test Conditions

LUXEON CoB with CrispWhite Technology (Gen 2) LEDs are tested and binned with a DC drive current specified below at a junction temperature,  $T_j$ , of 85°C:

- 200mA – LUXEON CoB 1202s
- 200mA – LUXEON CoB 1202
- 300mA – LUXEON CoB 1203
- 450mA – LUXEON CoB 1204
- 600mA – LUXEON CoB 1205
- 900mA – LUXEON CoB 1208
- 1200mA – LUXEON CoB 1211

## Part Number Nomenclature

Part numbers for LUXEON CoB with CrispWhite Technology (Gen 2) follow the convention below:

L 2 C 5 – **A A B B C C C C D E E C 0**

Where:

- A A** – designates nominal CCT (30=3000K)
- B B** – designates minimum CRI (90=90CRI, 95=95CRI)
- C C C C** – designates product configuration (1202, 1203, 1204, 1205, 1208, 1211)
- D** – designates options for product specification
- E E** – designates Light Emitting Surface (LES) size (06=6mm, 09=9mm, 13=13mm, 15=15mm, 19=19mm)

Therefore, the following part number is used for a LUXEON CoB 1203, 3000K 90CRI, with a 9mm LES:

L 2 C 5 – **3 0 9 0 1 2 0 3 E 0 9 C 0**

## Lumen Maintenance

Please contact your local Sales Representative or Lumileds Technical Solutions Manager for more information about the long-term performance of this product.

## Environmental Compliance

Lumileds LLC is committed to providing environmentally friendly products to the solid-state lighting market. The second generation of LUXEON CoB with CrispWhite Technology is compliant to the European Union directives on the restriction of hazardous substances in electronic equipment, namely the RoHS Directive 2011/65/EU and REACH Regulation (EC) 1907/2006. Lumileds LLC will not intentionally add the following restricted materials to its products: lead, mercury, cadmium, hexavalent chromium, polybrominated biphenyls (PBB) or polybrominated diphenyl ethers (PBDE).

# Performance Characteristics

## Product Selection Guide

Table 1. Product performance of LUXEON CoB with CrispWhite Technology (Gen 2) at specified test current,  $T_j=85^\circ\text{C}$ .

PRODUCT	NOMINAL CCT	MINIMUM CRI <sup>[1, 2]</sup>	LUMINOUS FLUX <sup>[1, 3]</sup> (lm)		TYPICAL LUMINOUS EFFICACY (lm/W)	TEST CURRENT (mA)	LES <sup>[4]</sup> (mm)	PART NUMBER
			MINIMUM	TYPICAL				
LUXEON CoB 1202s	3000K	90	586	651	93	200	6	L2C5-30901202E06C0
LUXEON CoB 1202	3000K	90	611	679	97	200	9	L2C5-30901202E09C0
LUXEON CoB 1203	3000K	90	905	1006	96	300	9	L2C5-30901203E09C0
		95	896	996	95			L2C5-30951203E09C0
LUXEON CoB 1204	3000K	90	1421	1579	99	450	13	L2C5-30901204E13C0
LUXEON CoB 1205	3000K	90	1845	2050	97	600	13	L2C5-30901205E13C0
		95	1827	2030	97			L2C5-30951205E13C0
LUXEON CoB 1208	3000K	90	2750	3056	97	900	15	L2C5-30901208E15C0
		95	2783	3092	98			L2C5-30951208E15C0
LUXEON CoB 1211	3000K	90	3794	4215	100	1200	19	L2C5-30901211E19C0
		95	3756	4173	99			L2C5-30951211E19C0

**Notes for Table 1:**

1. Lumileds maintains a tolerance of  $\pm 2$  on CRI and  $\pm 6.5\%$  on luminous flux measurements.
2. Typical CRI is approximately 2 points higher than the minimum CRI specified, but this is not guaranteed.
3. Maximum luminous flux is 10% above typical luminous flux.
4. Light Emitting Surface (LES) is the inner diameter (phosphor area) inside the dam.

## Optical Characteristics

Table 2. Optical characteristics for LUXEON CoB with CrispWhite Technology (Gen 2) at specified test current,  $T_j=85^\circ\text{C}$ .

PART NUMBER	TYPICAL TOTAL INCLUDED ANGLE <sup>[1]</sup>	TYPICAL VIEWING ANGLE <sup>[2]</sup>
L2C5-309x12xxExxC0	135°	115°

**Notes for Table 2:**

1. Total angle at which 90% of total luminous flux is captured.
2. Viewing angle is the off axis angle from the LED centerline where the luminous intensity is  $\frac{1}{2}$  of the peak value.

## Electrical and Thermal Characteristics

Table 3. Electrical and thermal characteristics for LUXEON CoB with CrispWhite Technology (Gen 2) at specified test current,  $T_j=85^\circ\text{C}$ .

PART NUMBER	FORWARD VOLTAGE <sup>[1]</sup> ( $V_f$ )			TYPICAL TEMPERATURE COEFFICIENT OF FORWARD VOLTAGE <sup>[2]</sup> (mV/ $^\circ\text{C}$ )	TYPICAL THERMAL RESISTANCE—JUNCTION TO CASE <sup>[3]</sup> ( $^\circ\text{C}/\text{W}$ )
	MINIMUM	TYPICAL	MAXIMUM		
L2C5-309x1202E06C0	33.0	35.0	38.0	-16	0.98
L2C5-309x1202E09C0	33.0	35.0	38.0	-16	0.91
L2C5-309x1203E09C0	33.0	35.0	38.0	-16	0.70
L2C5-309x1204E13C0	33.0	35.3	38.0	-16	0.53
L2C5-309x1205E13C0	33.0	35.3	38.0	-16	0.45
L2C5-309x1208E15C0	33.0	35.1	38.0	-16	0.29
L2C5-309x1211E19C0	33.0	35.2	38.0	-16	0.23

**Notes for Table 3:**

1. Lumileds maintains a tolerance of  $\pm 2\%$  on forward voltage measurements.
2. Measured between  $25^\circ\text{C}$  and  $85^\circ\text{C}$  for coefficient forward voltage.
3. Thermal resistance is measured between junction and the bottom of the LUXEON CoB substrate.

## Absolute Maximum Ratings

Table 4. Absolute maximum ratings for LUXEON CoB with CrispWhite Technology (Gen 2).

PARAMETER	MAXIMUM PERFORMANCE
DC Forward Current <sup>[1,2]</sup>	2x test current
LED Junction Temperature <sup>[1]</sup> (DC & Pulse)	$125^\circ\text{C}$
ESD Sensitivity (ANSI/ESDA/JEDEC JS-001-2012)	Class 3B
Operating Case Temperature <sup>[1]</sup>	$-40^\circ\text{C}$ to $105^\circ\text{C}$
LED Storage Temperature	$-40^\circ\text{C}$ to $120^\circ\text{C}$
Allowable Reflow Cycles	3
Reverse Voltage ( $V_{\text{reverse}}$ )	LUXEON LEDs are not designed to be driven in reverse bias

**Notes for Table 4:**

1. Proper current derating must be observed to maintain the junction temperature below the maximum allowable junction temperature.
2. Residual periodic variations due to power conversion from alternating current (AC) to direct current (DC), also called "ripple," are acceptable if the following conditions are met:
  - The frequency of the ripple current is 100Hz or higher
  - The average current for each cycle does not exceed the maximum allowable DC forward current
  - The maximum amplitude of the ripple does not exceed the maximum peak pulsed forward current
3. At 10% duty cycle with pulse width of 10ms.

# Characteristic Curves

## Spectral Power Distribution Characteristics

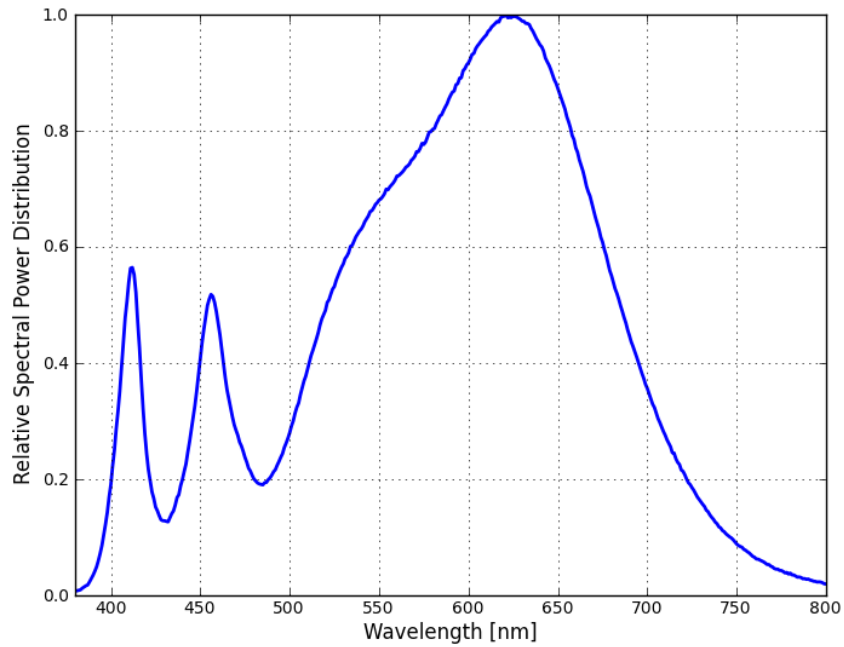

Figure 1. Typical normalized power vs. wavelength for LUXEON CoB with CrispWhite Technology (Gen 2) at specified test current,  $T_j=85^\circ\text{C}$ .

## Light Output Characteristics

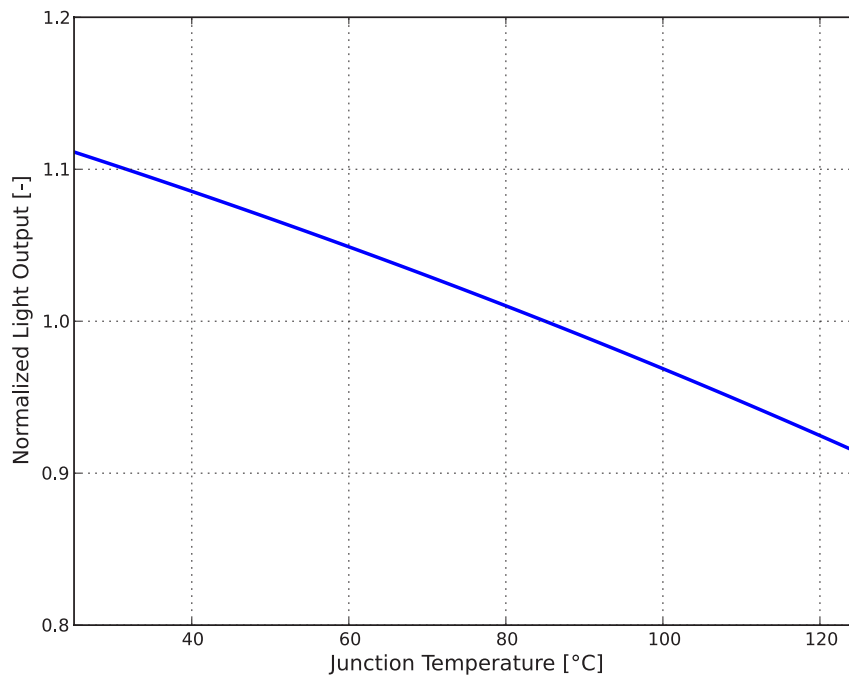
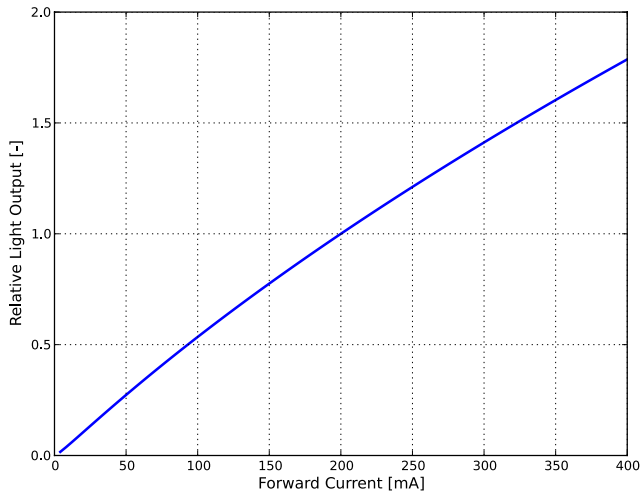
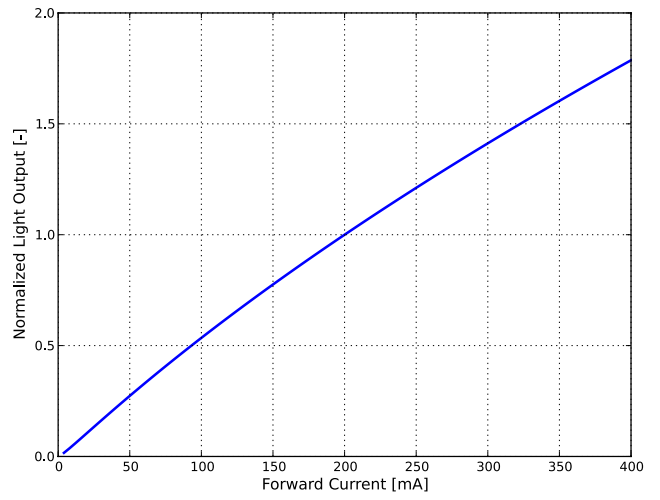

Figure 2. Typical normalized light output vs. junction temperature for LUXEON CoB with CrispWhite Technology (Gen 2) at specified test current.



L2C5-309x1202E06C0



L2C5-309x1202E09C0

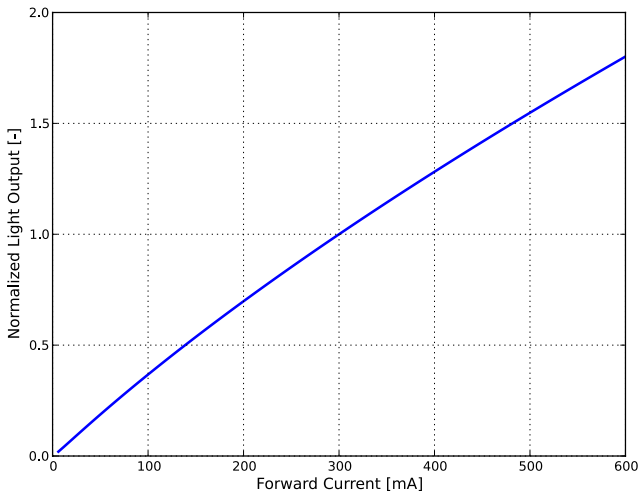

L2C5-309x1203E09C0

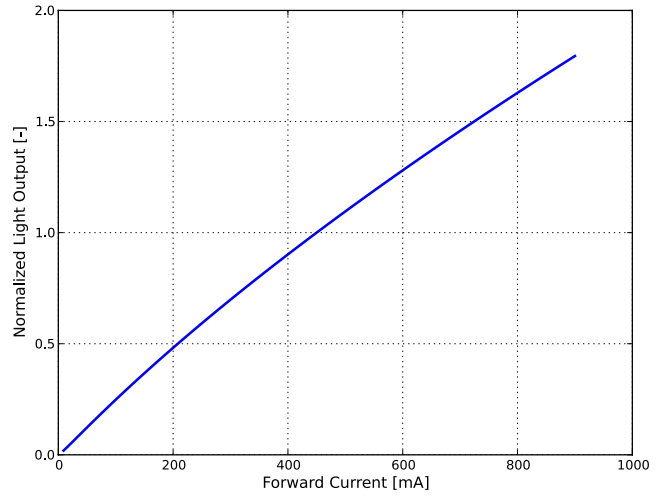

L2C5-309x1204E13C0

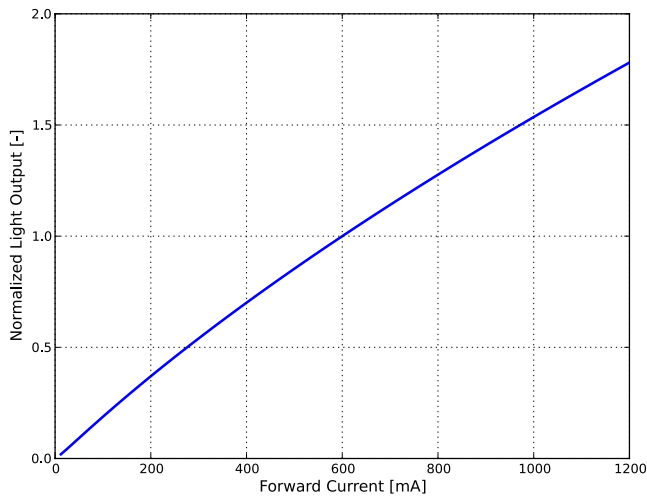

L2C5-309x1205E13C0

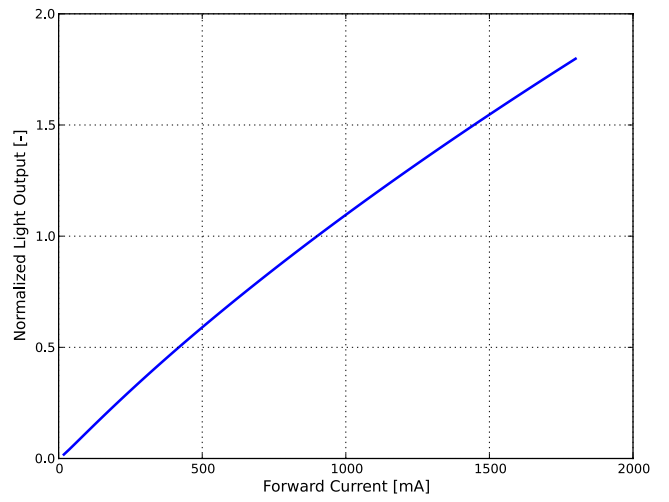

L2C5-309x1208E15C0

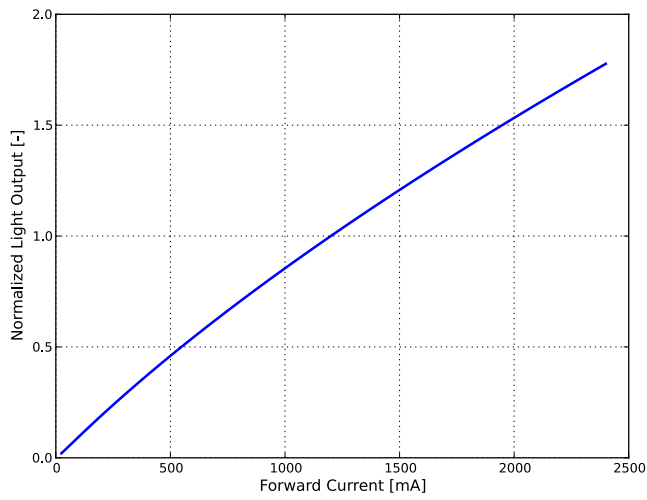

L2C5-309x1211E19C0

Figure 3. Typical normalized light output vs. forward current for LUXEON CoB with CrispWhite Technology (Gen 2) at  $T_j=85^\circ\text{C}$ .



# Forward Current Characteristics

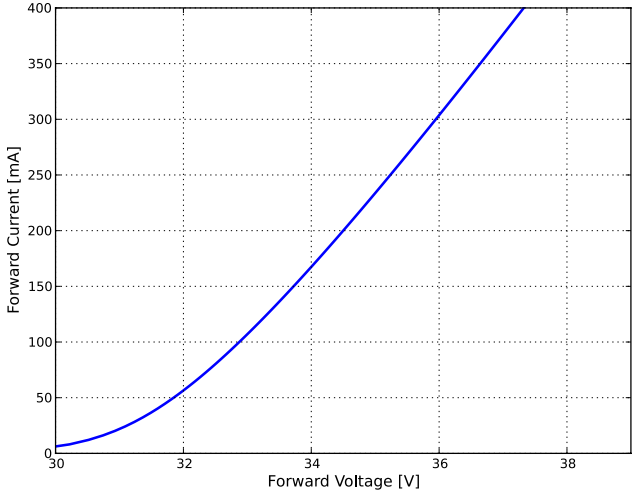

L2C5-309x1202E06C0

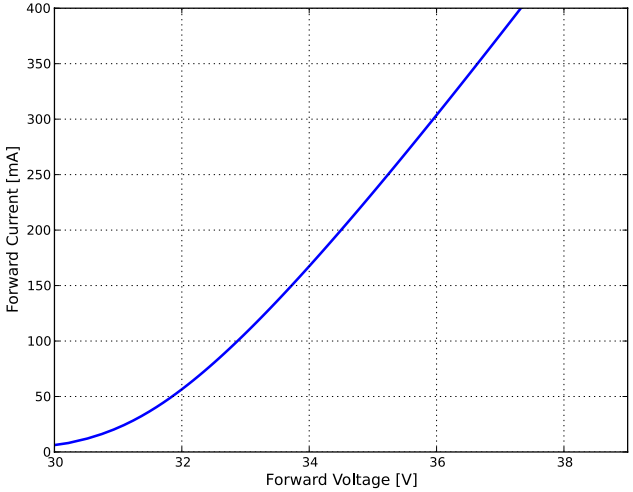

L2C5-309x1202E09C0

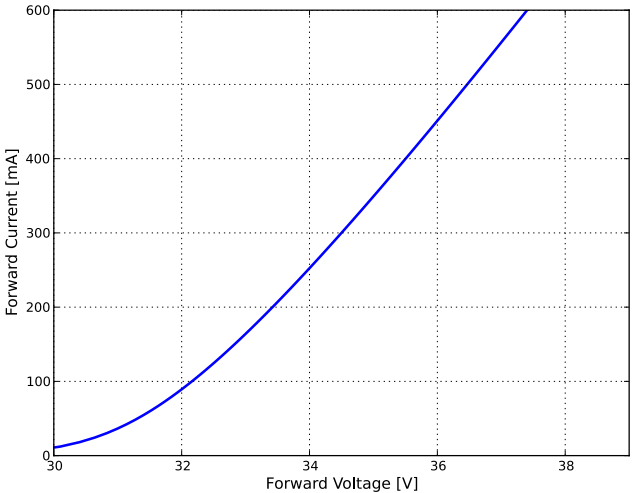

L2C5-309x1203E09C0

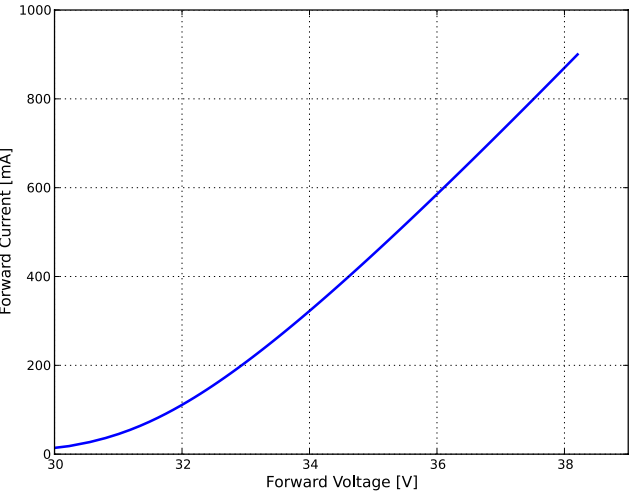

L2C5-309x1204E13C0

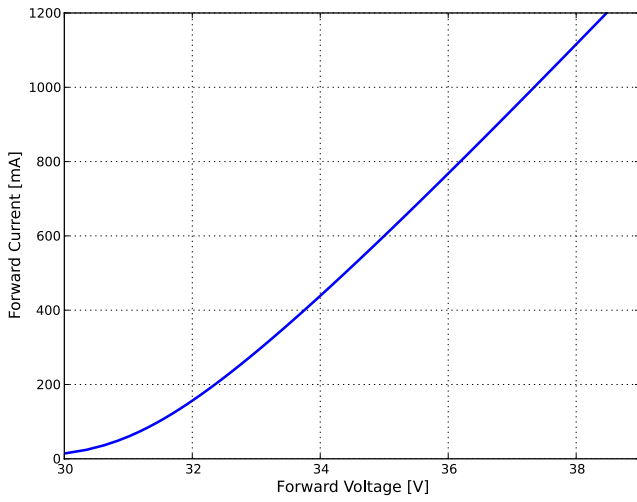

L2C5-309x1205E13C0

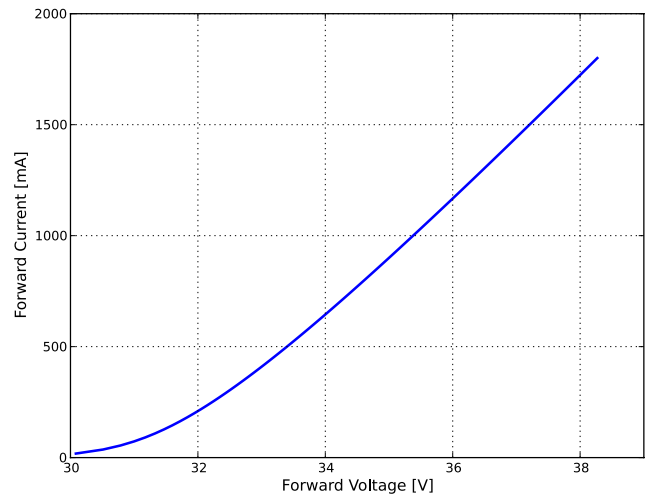

L2C5-309x1208E15C0

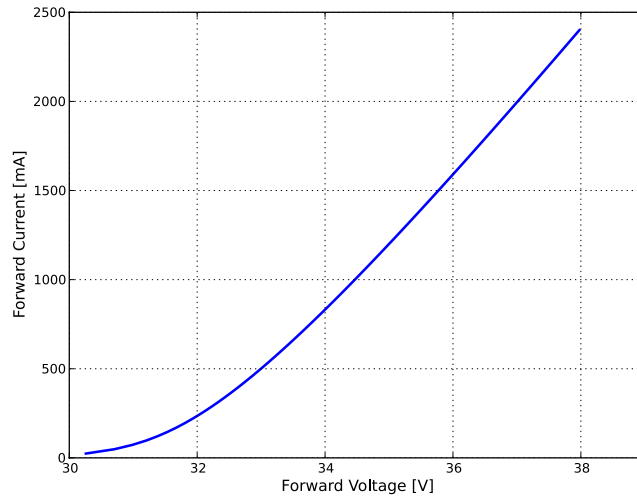

L2C5-309x1211E19C0

Figure 4. Typical forward current vs. forward voltage for LUXEON CoB with CrispWhite Technology (Gen 2) at  $T_j=85^\circ\text{C}$ .

# Radiation Pattern Characteristics

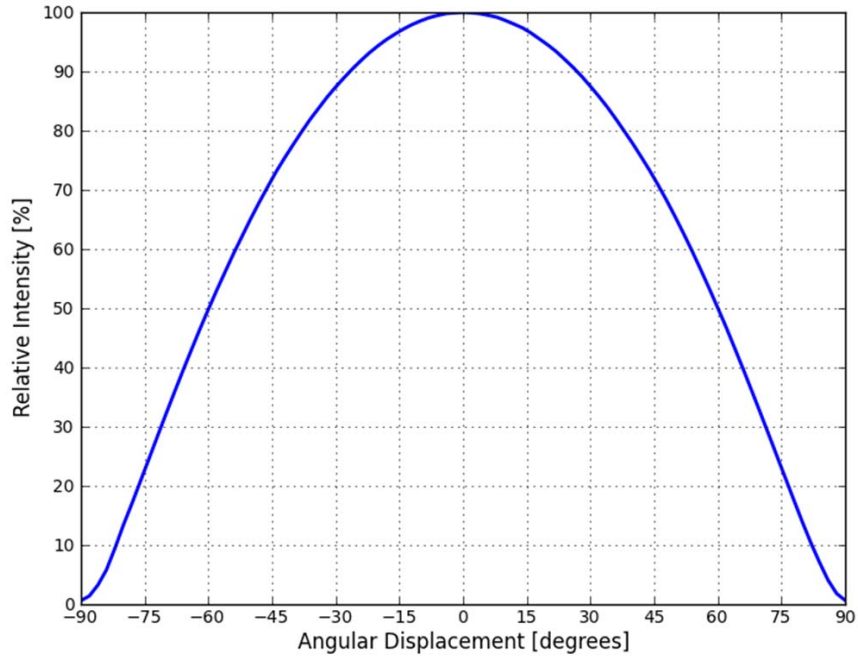

Figure 5. Typical radiation pattern for LUXEON CoB with CrispWhite Technology (Gen 2) at specified test current,  $T_j=85^{\circ}\text{C}$ .

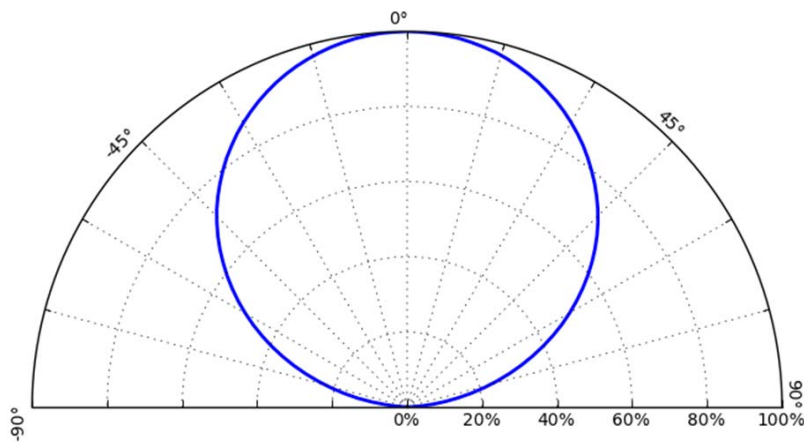

Figure 6. Typical polar radiation pattern for LUXEON CoB with CrispWhite Technology (Gen 2) at specified test current,  $T_j=85^{\circ}\text{C}$ .

# Color Bin Definitions

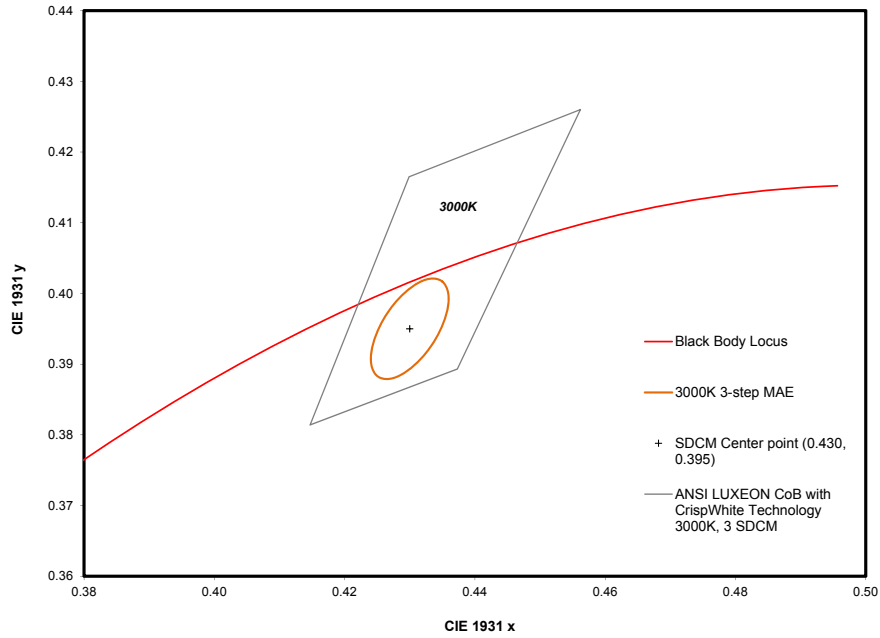

Figure 7. 3-step MacAdam ellipse illustration for Table 5.

Table 5. 3-step MacAdam ellipse color bin definitions for LUXEON CoB with CrispWhite Technology (Gen 2).

NOMINAL CCT	COLOR SPACE	CENTER POINT <sup>[1]</sup> (cx, cy)	MAJOR AXIS, a	MINOR AXIS, b	ELLIPSE ROTATION ANGLE, $\theta$
3000K	Single 3-step MacAdam ellipse	(0.430, 0.395)	0.00834	0.00408	53.20°

**Notes for Table 5:**

1. Lumileds maintains a tolerance of  $\pm 0.005$  on x and y coordinates in the CIE 1931 color space.



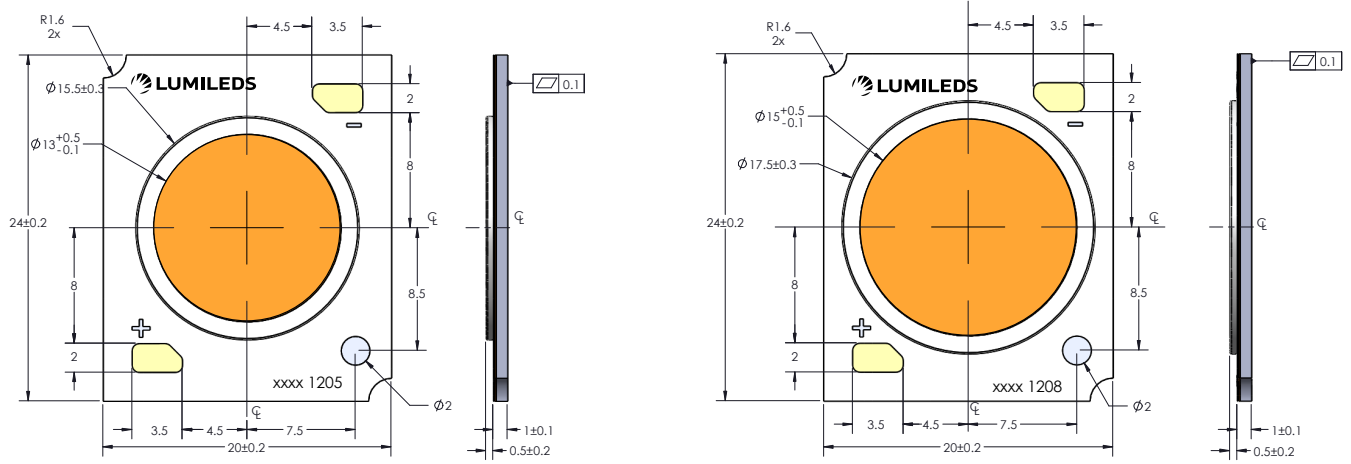

L2C5-309x1205E13C0

L2C5-309x1208E15C0

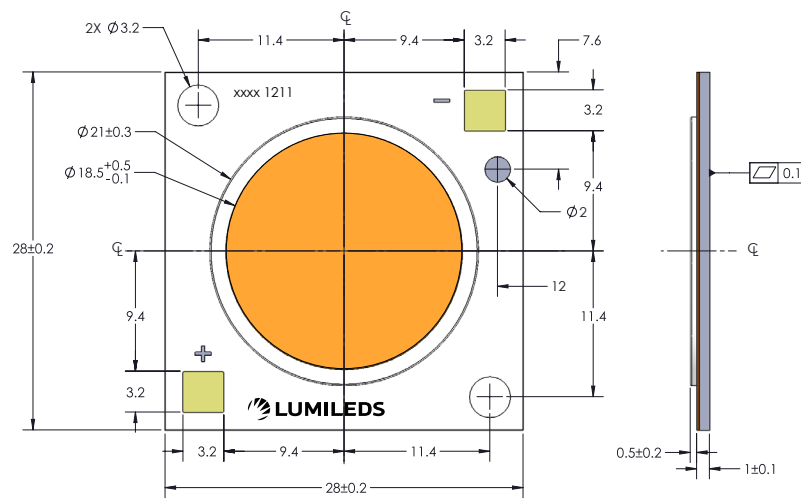

L2C5-309x1211E19C0

Figure 8. Mechanical dimensions for LUXEON CoB with CrispWhite Technology (Gen 2).

Notes for Figure 8:

1. Drawings not to scale.
2. All dimensions are in millimeters.

# Packaging and Labeling Information

The second generation of LUXEON CoB with CrispWhite Technology LEDs are packaged in tubes then in a carton box. Each tube contains a specified number of LEDs. The LEDs in each tube come from a single category code, ensuring they are all well-matched for light output, color, and forward voltage. Each tube contains a rubber stopper at one end. The tube label has both alphanumeric and bar code information. The carton boxes have printed information providing part numbers with CAT codes that indicate luminous flux, color and forward voltage bins.

**Table 6. Package information for LUXEON CoB with CrispWhite Technology (Gen 2).**

PART NUMBER	TOTAL UNITS PER TUBE	TOTAL TUBES PER INNER BOX	TOTAL UNITS PER INNER BOX
L2C5-309x1202E06C0	20	5	100
L2C5-309x1202E09C0	20	5	100
L2C5-309x1203E09C0	20	5	100
L2C5-309x1204E13C0	20	5	100
L2C5-309x1205E13C0	20	5	100
L2C5-309x1208E15C0	20	5	100
L2C5-309x1211E19C0	10	5	50

## Tube Dimensions

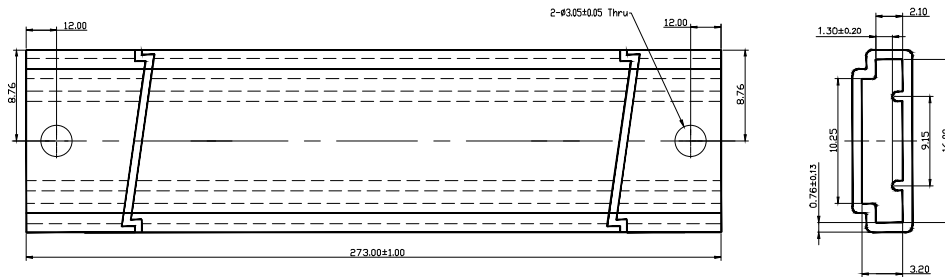

Figure 9a. Tube dimensions for L2C5-309x1202E06C0.

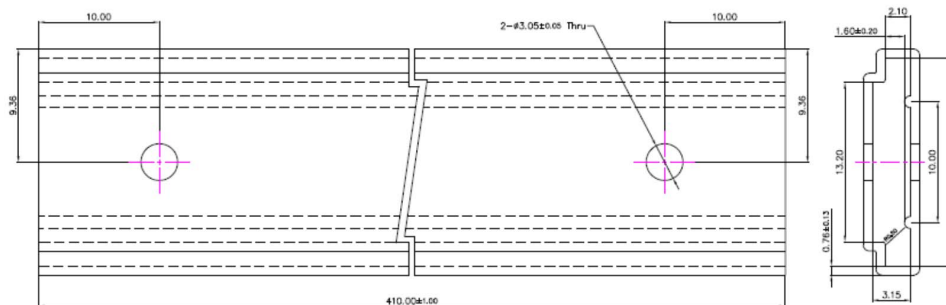

Figure 9b. Tube dimensions for L2C5-309x120xE09C0.

**Notes for Figures 9a and 9b:**

1. Drawings not to scale.
2. All dimensions are in millimeters.

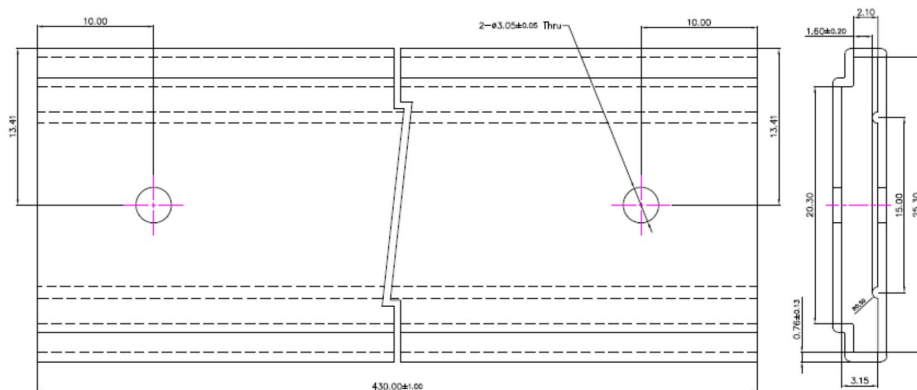

Figure 9c. Tube dimensions for L2C5-309x120xE13C0 and L2C5-309x1208E15C0.

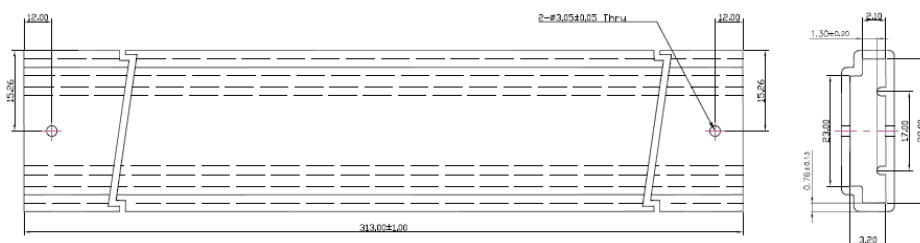

Figure 9d. Tube dimensions for L2C5-309x1211E19C0.

Notes for Figures 9c and 9d:

1. Drawings not to scale.
2. All dimensions are in millimeters.

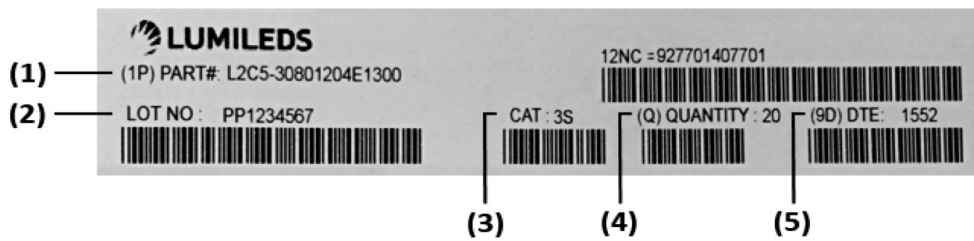

Figure 10. Example of a tube label for LUXEON CoB with CrispWhite Technology (Gen 2).

Notes for Figure 10 - Tube Label descriptions for customer use:

Field labels not described are for Lumileds internal use only.

1. Lumileds part number.
2. Unique production lot identification number. This number is required for traceability purpose.
3. Product category code.
4. Number of LED emitters in a tube.
5. LED test date in YYWW format.



## Inner Box

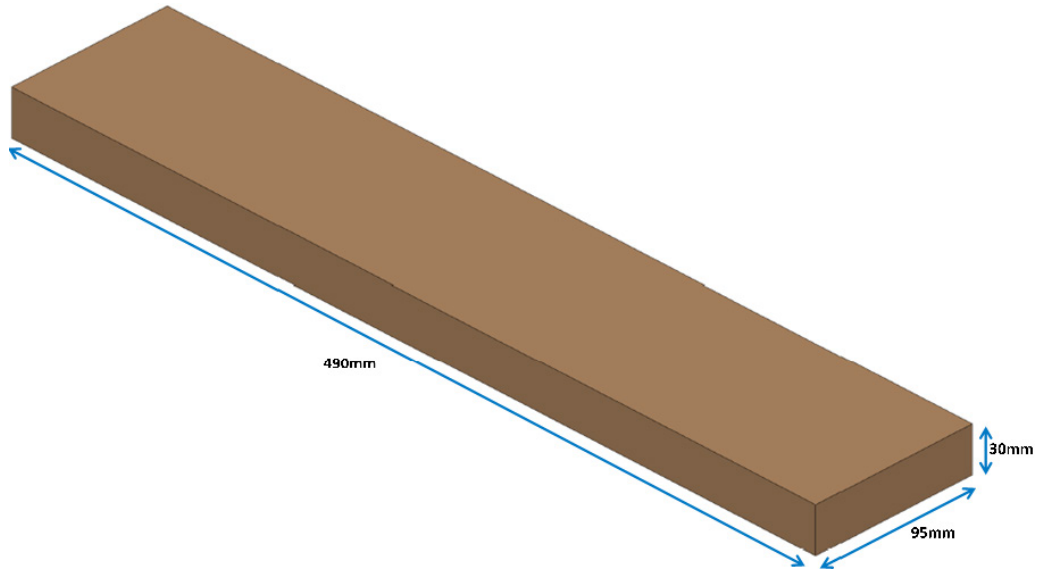

Figure 11. Dimensions for inner box packaging for LUXEON CoB with CrispWhite Technology (Gen 2).

Table 7. Inner box information for LUXEON CoB with CrispWhite Technology (Gen 2).

BOX TYPE	DIMENSIONS (mm)			AVERAGE WEIGHT (100PCS/BOX)	AVERAGE WEIGHT (50PCS/BOX)
	H	L	W		
Inner Box	30	490	95	0.340Kg	0.305Kg



Figure 12. Example of inner box label for LUXEON CoB with CrispWhite Technology (Gen 2).

Notes for Figure 12 - Tube Label descriptions for customer use:

Field labels not described are for Lumileds internal use only.

1. Lumileds part number.
2. Number of LED emitters in a box.
3. LED test date in YYWW format.
4. Customer part number for custom requests only.
5. Unique production lot identification number. This number is required for traceability purpose.
6. Product category code.

# Outer Box

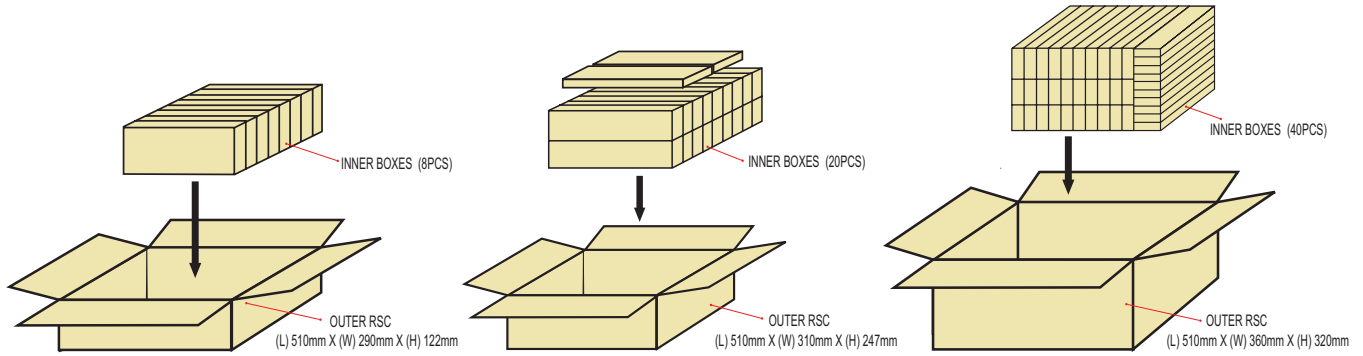

Figure 13. Dimensions for outer box packaging for LUXEON CoB with CrispWhite Technology (Gen 2).

Table 8. Outer box information for LUXEON CoB with CrispWhite Technology (Gen 2).

BOX TYPE	DIMENSIONS (mm)			MAXIMUM INNER BOXES PER OUTER BOX	MAXIMUM QUANTITY PER OUTER BOX	AVERAGE WEIGHT (100pcs/box)	AVERAGE WEIGHT (50pcs/box)
	H	L	W				
Outer Box 8 pcs	122	510	290	8	800	3.05kg	2.77kg
Outer Box 20 pcs	247	510	310	20	2000	7.55kg	6.85kg
Outer Box 40 pcs	320	510	360	40	4000	15.10kg	13.70kg

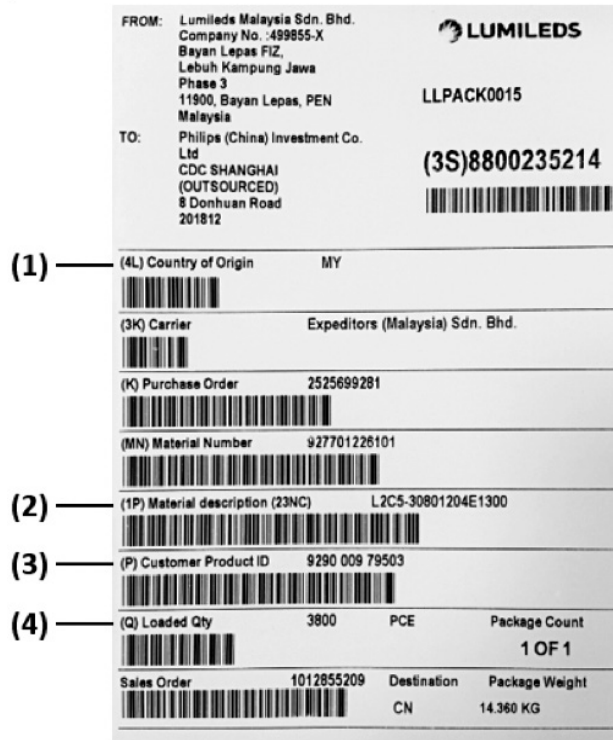

Figure 14. Example of outer box label for LUXEON CoB with CrispWhite Technology (Gen 2).

Notes for Figure 14 - Tube Label descriptions for customer use:

Field labels not described are for Lumileds internal use only.

1. Country code of origin of manufacturing of parts (e.g. MY for Malaysia, CN for China) according to ISO 3166-1 alpha-2 document.
2. Lumileds part number.
3. Customer part number for custom requests only.
4. Total number of LED emitters in a shipment box.

## About Lumileds

Companies developing automotive, mobile, IoT and illumination lighting applications need a partner who can collaborate with them to push the boundaries of light. With over 100 years of inventions and industry firsts, Lumileds is a global lighting solutions company that helps customers around the world deliver differentiated solutions to gain and maintain a competitive edge. As the inventor of Xenon technology, a pioneer in halogen lighting and the leader in high performance LEDs, Lumileds builds innovation, quality and reliability into its technology, products and every customer engagement. Together with its customers, Lumileds is making the world better, safer, more beautiful—with light.

To learn more about our lighting solutions, visit [lumileds.com](http://lumileds.com).



---

©2019 Lumileds Holding B.V. All rights reserved.  
LUXEON is a registered trademark of the Lumileds Holding B.V. in the United States and other countries.  
[lumileds.com](http://lumileds.com)

Neither Lumileds Holding B.V. nor its affiliates shall be liable for any kind of loss of data or any other damages, direct, indirect or consequential, resulting from the use of the provided information and data. Although Lumileds Holding B.V. and/or its affiliates have attempted to provide the most accurate information and data, the materials and services information and data are provided "as is," and neither Lumileds Holding B.V. nor its affiliates warrants or guarantees the contents and correctness of the provided information and data. Lumileds Holding B.V. and its affiliates reserve the right to make changes without notice. You as user agree to this disclaimer and user agreement with the download or use of the provided materials, information and data. A listing of Lumileds product/patent coverage may be accessed at [lumileds.com/patents](http://lumileds.com/patents).



Компания «ЭлектроПласт» предлагает заключение долгосрочных отношений при поставках импортных электронных компонентов на взаимовыгодных условиях!

Наши преимущества:

- Оперативные поставки широкого спектра электронных компонентов отечественного и импортного производства напрямую от производителей и с крупнейших мировых складов;
- Поставка более 17-ти миллионов наименований электронных компонентов;
- Поставка сложных, дефицитных, либо снятых с производства позиций;
- Оперативные сроки поставки под заказ (от 5 рабочих дней);
- Экспресс доставка в любую точку России;
- Техническая поддержка проекта, помощь в подборе аналогов, поставка прототипов;
- Система менеджмента качества сертифицирована по Международному стандарту ISO 9001;
- Лицензия ФСБ на осуществление работ с использованием сведений, составляющих государственную тайну;
- Поставка специализированных компонентов (Xilinx, Altera, Analog Devices, Intersil, Interpoint, Microsemi, Aeroflex, Peregrine, Syfer, Eurofarad, Texas Instrument, Miteq, Cobham, E2V, MA-COM, Hittite, Mini-Circuits, General Dynamics и др.);

Помимо этого, одним из направлений компании «ЭлектроПласт» является направление «Источники питания». Мы предлагаем Вам помощь Конструкторского отдела:

- Подбор оптимального решения, техническое обоснование при выборе компонента;
- Подбор аналогов;
- Консультации по применению компонента;
- Поставка образцов и прототипов;
- Техническая поддержка проекта;
- Защита от снятия компонента с производства.



#### Как с нами связаться

**Телефон:** 8 (812) 309 58 32 (многоканальный)

**Факс:** 8 (812) 320-02-42

**Электронная почта:** [org@eplast1.ru](mailto:org@eplast1.ru)

**Адрес:** 198099, г. Санкт-Петербург, ул. Калинина, дом 2, корпус 4, литера А.