

# SFH756 / SFH756V

## Plastic Fiber Optic Transmitter Diode

### Plastic Connector Housing



## Data Sheet

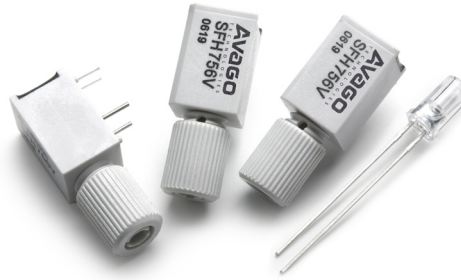

### Description

The SFH756 is a low-cost transmitter for simple optical data transmission with polymer optical fiber. The 650nm LED allows for speeds up to 10MBd.

The transparent plastic package has an aperture where the 2.2mm fiber-end can be inserted and fixed with glue. This easy coupling method is extremely cost-effective.

The V-housing allows easy coupling of unconnectorized 2.2mm plastic optical fiber by means of an axial locking screw.

### Ordering Information

Type	Ordering Code
SFH756	SP000063802
SFH756V	SP000063814

### Features

- 2.2 mm Aperture holds Standard 1000 Micron Plastic Fiber
- No Fiber Stripping Required
- Good Linearity (Forward current > 2 mA)
- Molded Microlens for Efficient Coupling

### Plastic Connector Housing

- Mounting Screw Attached to the Connector
- Interference Free Transmission from light-Tight Housing
- Transmitter and Receiver can be flexibly positioned
- No Cross Talk
- Auto insertable and Wave solderable
- Supplied in Tubes

### Applications

- Household Electronics
- Power Electronics
- Optical Networks
- Light Barriers

## Technical Data

### Absolute Maximum Ratings

Parameter	Symbol	Limit Values		Unit
		min.	max.	
Operating Temperature Range	T <sub>OP</sub>	-40	+85	°C
Storage Temperature Range	T <sub>STG</sub>	-40	+100	°C
Junction Temperature	T <sub>J</sub>		100	°C
Soldering Temperature (27mm from case bottom, t ≤ 5 s)	T <sub>S</sub>		260	°C
Reverse Voltage	V <sub>R</sub>		3	V
Forward Current	I <sub>F</sub>		50	mA
Surge Current (t ≤ 10 μs, D = 0)	I <sub>FSM</sub>		1	A
Power Dissipation	P <sub>TOT</sub>		120	mW
Thermal Resistance, Junction/Air	R <sub>thJA</sub>		450	K/W

### Characteristics (T<sub>A</sub> = 25°C)

Parameter	Symbol	Value	Unit
Peak Wavelength	λ <sub>Peak</sub>	660	nm
Spectral Bandwidth	Δλ	25	nm
Switching Times (R <sub>G</sub> = 50 Ω, I <sub>F(Low)</sub> = 0.1 mA, I <sub>F(High)</sub> = 50 mA)			μs
10% to 90%	t <sub>R</sub>	0.1	
90% to 10%	t <sub>F</sub>	0.1	
Capacitance (f = 1 MHz, V <sub>R</sub> = 0 V)	C <sub>0</sub>	30	pF
Forward Voltage (I <sub>F</sub> = 50 mA)	V <sub>F</sub>	2.1 (≤ 2.8)	V
Output Power Coupled Into Plastic Fiber (I <sub>F</sub> = 10 mA) [1]	Φ <sub>IN</sub>	200 (≥ 100)	μW
Temperature Coefficient Φ <sub>IN</sub>	T <sub>CΦ</sub>	-0.4	%/K
Temperature Coefficient V <sub>F</sub>	T <sub>CV</sub>	-3	mV/K
Temperature Coefficient λ <sub>Peak</sub>	T <sub>Cλ</sub>	0.16	nm/K

#### Notes:

1. The output power coupled into plastic fiber is measured with a large area detector after a short fiber (about 30 cm). This value must not be used for calculating the power budget for a fiber optic system with a long fiber because the numerical aperture of plastic fibers is decreasing on the first meters. Therefore the fiber seems to have compared with the specified value a higher attenuation on the first meters.

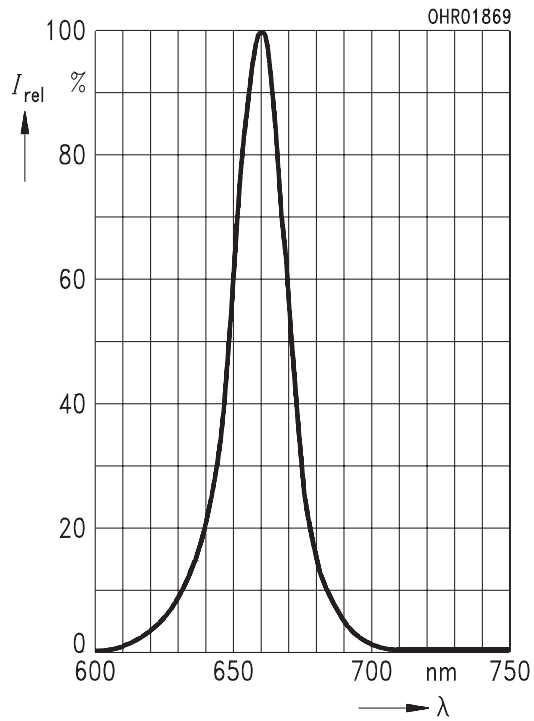

Figure 1. Relative Spectral Emission  $I_{rel} = f(\lambda)$

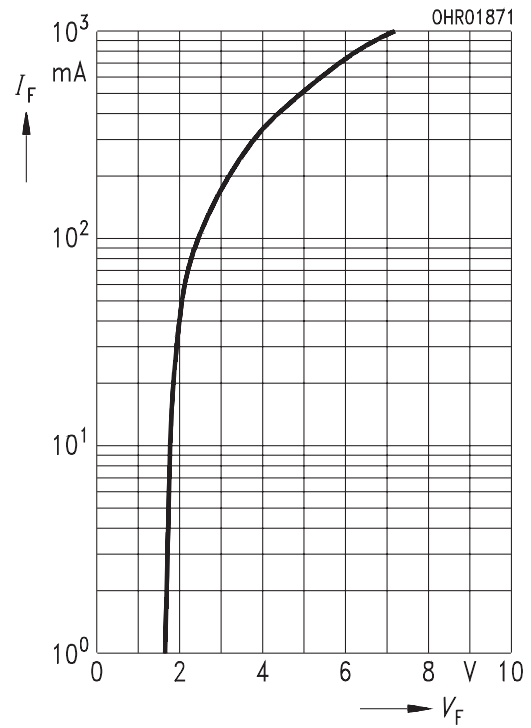

Figure 2. Forward Current  $I_F = f(V_F)$  single pulse, duration = 20  $\mu s$

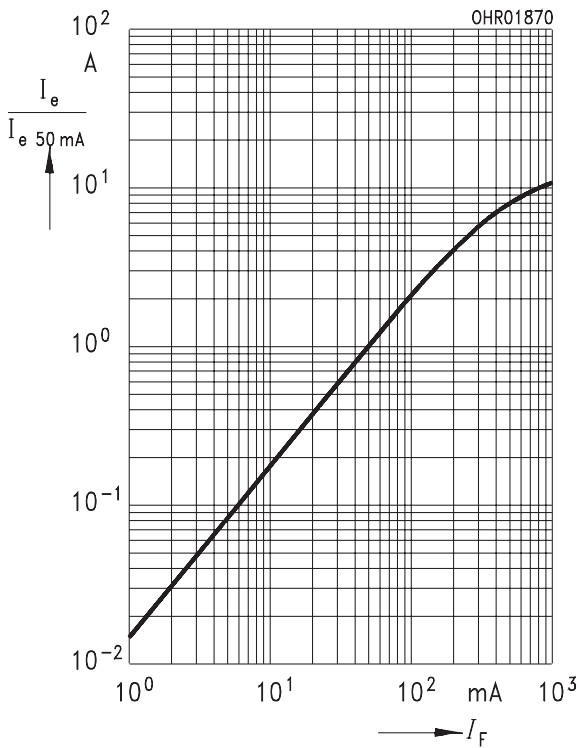

Figure 3. Relative Output Power,  $I_e/I_{e(50\text{ mA})} = f(I_F)$  single pulse, duration = 20  $\mu s$

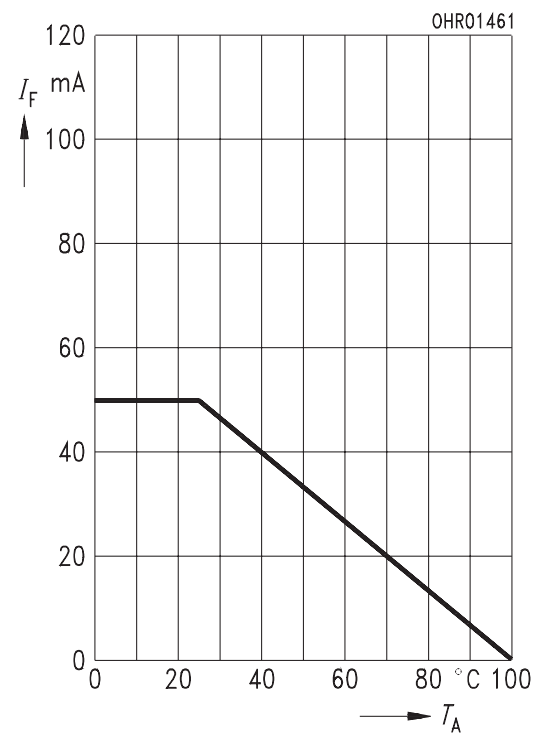
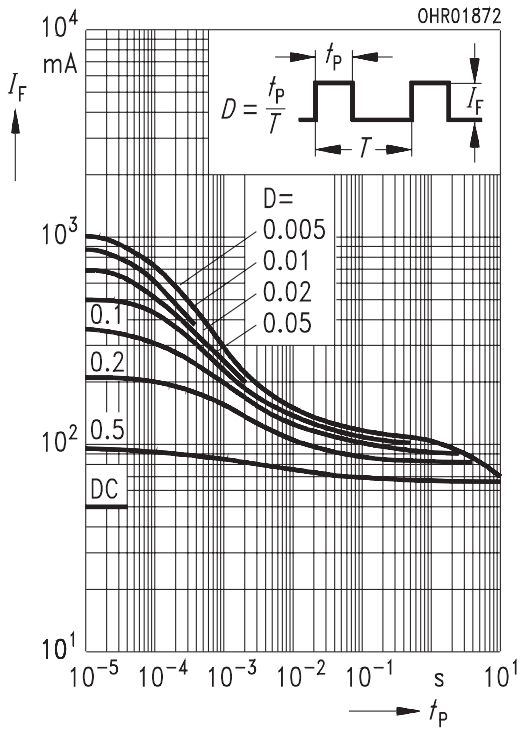
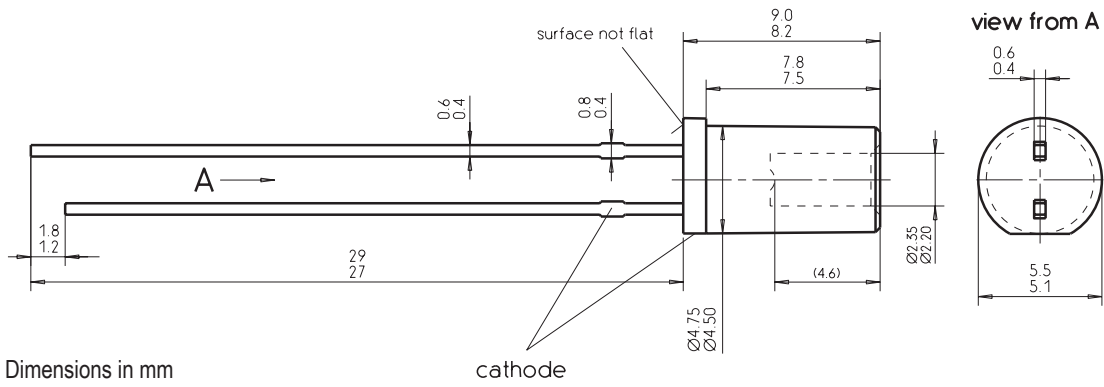

Figure 4. Maximum Permissible Forward Current,  $I_F = f(T_A)$ ,  $R_{thJA} = 450\text{ K/W}$



**Figure 5. Permissible Pulse Handling Capability,  $I_F = f(t_p)$ , duty cycle  $D =$  parameter,  $T_A = 25^\circ\text{C}$**

# Package Outlines



Dimensions in mm

Figure 6. SFH756

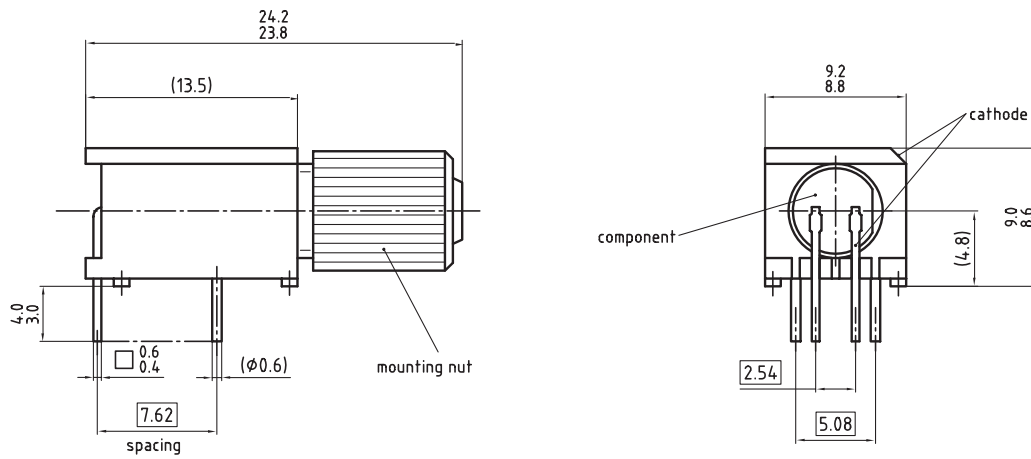

Dimensions in mm

Figure 7. SFH756V

## **Disclaimer**

The information herein is given to describe certain components and shall not be considered as a guarantee of characteristics.

Terms of delivery and rights to technical change reserved. We hereby disclaim any and all warranties, including but not limited to warranties of non-infringement, regarding circuits, descriptions and charts stated herein.

## **Warnings**

Due to technical requirements components may contain dangerous substances. For information on the types in question please contact your nearest Avago Technologies Office.

Avago Technologies Components may only be used in life-support devices or systems with the express written approval of Avago Technologies, if a failure of such components can reasonably be expected to cause the failure of that life-support device or system, or to affect the safety or effectiveness of that device or system. Life support devices or systems are intended to be implanted in the human body, or to support and/or maintain and sustain and/or protect human life. If they fail, it is reasonable to assume that the health of the user or other persons maybe endangered.

## **Information**

For further information on technology, delivery terms and conditions and prices please contact your nearest Avago Technologies Office ([www.avagotech.com](http://www.avagotech.com)).

For product information and a complete list of distributors, please go to our web site: [www.avagotech.com](http://www.avagotech.com)

Avago, Avago Technologies, and the A logo are trademarks of Avago Technologies, Limited in the United States and other countries.  
Data subject to change. Copyright © 2007 Avago Technologies Limited. All rights reserved.  
AV01-0715EN - June 30, 2007

**Avago**  
TECHNOLOGIES



Компания «ЭлектроПласт» предлагает заключение долгосрочных отношений при поставках импортных электронных компонентов на взаимовыгодных условиях!

Наши преимущества:

- Оперативные поставки широкого спектра электронных компонентов отечественного и импортного производства напрямую от производителей и с крупнейших мировых складов;
- Поставка более 17-ти миллионов наименований электронных компонентов;
- Поставка сложных, дефицитных, либо снятых с производства позиций;
- Оперативные сроки поставки под заказ (от 5 рабочих дней);
- Экспресс доставка в любую точку России;
- Техническая поддержка проекта, помощь в подборе аналогов, поставка прототипов;
- Система менеджмента качества сертифицирована по Международному стандарту ISO 9001;
- Лицензия ФСБ на осуществление работ с использованием сведений, составляющих государственную тайну;
- Поставка специализированных компонентов (Xilinx, Altera, Analog Devices, Intersil, Interpoint, Microsemi, Aeroflex, Peregrine, Syfer, Eurofarad, Texas Instrument, Miteq, Cobham, E2V, MA-COM, Hittite, Mini-Circuits, General Dynamics и др.);

Помимо этого, одним из направлений компании «ЭлектроПласт» является направление «Источники питания». Мы предлагаем Вам помощь Конструкторского отдела:

- Подбор оптимального решения, техническое обоснование при выборе компонента;
- Подбор аналогов;
- Консультации по применению компонента;
- Поставка образцов и прототипов;
- Техническая поддержка проекта;
- Защита от снятия компонента с производства.



#### Как с нами связаться

**Телефон:** 8 (812) 309 58 32 (многоканальный)

**Факс:** 8 (812) 320-02-42

**Электронная почта:** [org@eplast1.ru](mailto:org@eplast1.ru)

**Адрес:** 198099, г. Санкт-Петербург, ул. Калинина, дом 2, корпус 4, литера А.