

TIP35A, TIP35B, TIP35C (NPN); TIP36A, TIP36B, TIP36C (PNP)

Complementary Silicon High-Power Transistors

Designed for general-purpose power amplifier and switching applications.

Features

- 25 A Collector Current
- Low Leakage Current –
 $I_{CEO} = 1.0 \text{ mA @ } 30 \text{ and } 60 \text{ V}$
- Excellent DC Gain –
 $h_{FE} = 40 \text{ Typ @ } 15 \text{ A}$
- High Current Gain Bandwidth Product –
 $|h_{fe}| = 3.0 \text{ min @ } I_C$
 $= 1.0 \text{ A, } f = 1.0 \text{ MHz}$
- These are Pb-Free Devices*

MAXIMUM RATINGS

Rating	Symbol	TIP35A TIP36A	TIP35B TIP36B	TIP35C TIP36C	Unit
Collector – Emitter Voltage	V_{CEO}	60	80	100	Vdc
Collector – Base Voltage	V_{CB}	60	80	100	Vdc
Emitter – Base Voltage	V_{EB}	5.0			Vdc
Collector Current	I_C				Adc
– Continuous		25			
– Peak (Note 1)		40			
Base Current – Continuous	I_B	5.0			Adc
Total Power Dissipation @ $T_C = 25^\circ\text{C}$ Derate above 25°C	P_D	125			W W/ $^\circ\text{C}$
Operating and Storage Junction Temperature Range	T_J, T_{stg}	–65 to +150			$^\circ\text{C}$
Unclamped Inductive Load	E_{SB}	90			mJ

THERMAL CHARACTERISTICS

Characteristic	Symbol	Max	Unit
Thermal Resistance, Junction-to-Case	$R_{\theta JC}$	1.0	$^\circ\text{C/W}$
Junction-to-Free-Air Thermal Resistance	$R_{\theta JA}$	35.7	$^\circ\text{C/W}$

Stresses exceeding Maximum Ratings may damage the device. Maximum Ratings are stress ratings only. Functional operation above the Recommended Operating Conditions is not implied. Extended exposure to stresses above the Recommended Operating Conditions may affect device reliability.

1. Pulse Test: Pulse Width = 10 ms, Duty Cycle \leq 10%.

*For additional information on our Pb-Free strategy and soldering details, please download the ON Semiconductor Soldering and Mounting Techniques Reference Manual, SOLDERRM/D.



ON Semiconductor®

<http://onsemi.com>

25 AMPERE COMPLEMENTARY SILICON POWER TRANSISTORS 60–100 VOLTS, 125 WATTS

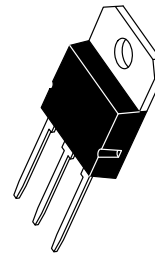

SOT-93 (TO-218)
CASE 340D
STYLE 1

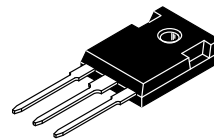

TO-247
CASE 340L
STYLE 3

NOTE: Effective June 2012 this device will be available only in the TO-247 package. Reference FPCN# 16827.

ORDERING INFORMATION

See detailed ordering and shipping information in the package dimensions section on page 2 of this data sheet.

TIP35A, TIP35B, TIP35C (NPN); TIP36A, TIP36B, TIP36C (PNP)

MARKING DIAGRAMS

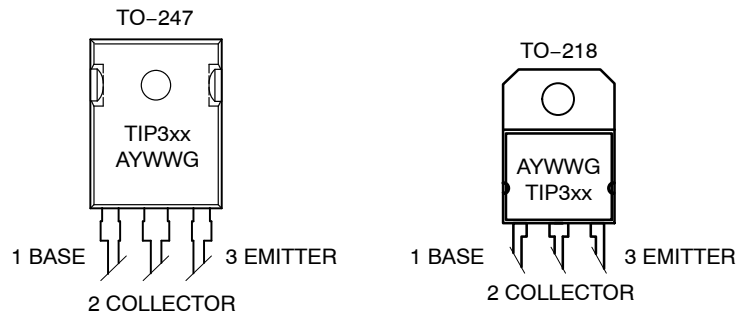

TIP3xx = Device Code
 A = Assembly Location
 Y = Year
 WW = Work Week
 G = Pb-Free Package

ORDERING INFORMATION

Device	Package	Shipping
TIP35AG	SOT-93 (TO-218) (Pb-Free)	30 Units / Rail
TIP35BG	SOT-93 (TO-218) (Pb-Free)	30 Units / Rail
TIP35CG	SOT-93 (TO-218) (Pb-Free)	30 Units / Rail
TIP36AG	SOT-93 (TO-218) (Pb-Free)	30 Units / Rail
TIP36BG	SOT-93 (TO-218) (Pb-Free)	30 Units / Rail
TIP36CG	SOT-93 (TO-218) (Pb-Free)	30 Units / Rail
TIP35AG	TO-247 (Pb-Free)	30 Units / Rail
TIP35BG	TO-247 (Pb-Free)	30 Units / Rail
TIP35CG	TO-247 (Pb-Free)	30 Units / Rail
TIP36AG	TO-247 (Pb-Free)	30 Units / Rail
TIP36BG	TO-247 (Pb-Free)	30 Units / Rail
TIP36CG	TO-247 (Pb-Free)	30 Units / Rail

TIP35A, TIP35B, TIP35C (NPN); TIP36A, TIP36B, TIP36C (PNP)

ELECTRICAL CHARACTERISTICS ($T_C = 25^\circ\text{C}$ unless otherwise noted)

Characteristic	Symbol	Min	Max	Unit
OFF CHARACTERISTICS				
Collector–Emitter Sustaining Voltage (Note 2) ($I_C = 30\text{ mA}$, $I_B = 0$)	$V_{CE(sus)}$	60 80 100	– – –	Vdc
Collector–Emitter Cutoff Current ($V_{CE} = 30\text{ V}$, $I_B = 0$) ($V_{CE} = 60\text{ V}$, $I_B = 0$)	I_{CEO}	– –	1.0 1.0	mA
Collector–Emitter Cutoff Current ($V_{CE} = \text{Rated } V_{CEO}$, $V_{EB} = 0$)	I_{CES}	–	0.7	mA
Emitter–Base Cutoff Current ($V_{EB} = 5.0\text{ V}$, $I_C = 0$)	I_{EBO}	–	1.0	mA
ON CHARACTERISTICS (Note 2)				
DC Current Gain ($I_C = 1.5\text{ A}$, $V_{CE} = 4.0\text{ V}$) ($I_C = 15\text{ A}$, $V_{CE} = 4.0\text{ V}$)	h_{FE}	25 15	– 75	–
Collector–Emitter Saturation Voltage ($I_C = 15\text{ A}$, $I_B = 1.5\text{ A}$) ($I_C = 25\text{ A}$, $I_B = 5.0\text{ A}$)	$V_{CE(sat)}$	– –	1.8 4.0	Vdc
Base–Emitter On Voltage ($I_C = 15\text{ A}$, $V_{CE} = 4.0\text{ V}$) ($I_C = 25\text{ A}$, $V_{CE} = 4.0\text{ V}$)	$V_{BE(on)}$	– –	2.0 4.0	Vdc
DYNAMIC CHARACTERISTICS				
Small–Signal Current Gain ($I_C = 1.0\text{ A}$, $V_{CE} = 10\text{ V}$, $f = 1.0\text{ kHz}$)	h_{fe}	25	–	–
Current–Gain — Bandwidth Product ($I_C = 1.0\text{ A}$, $V_{CE} = 10\text{ V}$, $f = 1.0\text{ MHz}$)	f_T	3.0	–	MHz

2. Pulse Test: Pulse Width = 300 μs , Duty Cycle $\leq 2.0\%$.

TIP35A, TIP35B, TIP35C (NPN); TIP36A, TIP36B, TIP36C (PNP)

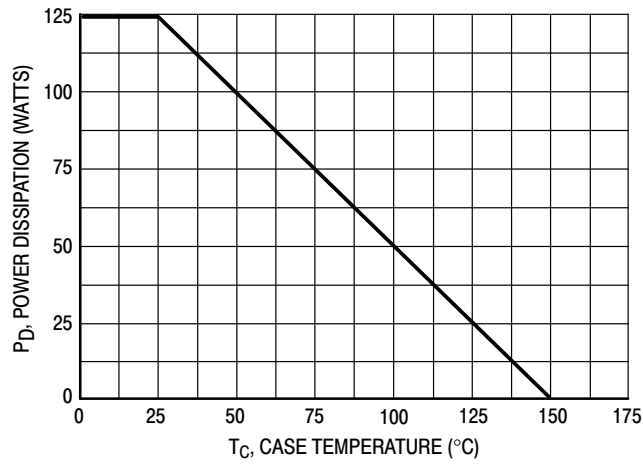
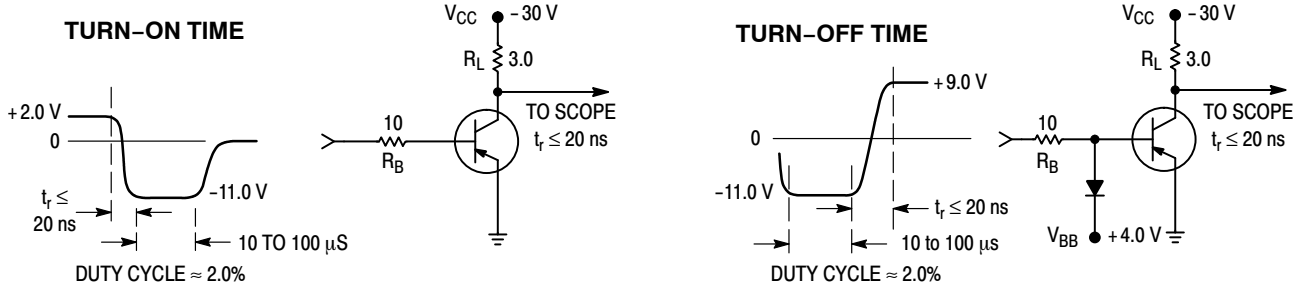

Figure 1. Power Derating



FOR CURVES OF FIGURES 3 & 4, R_B & R_L ARE VARIED.
 INPUT LEVELS ARE APPROXIMATELY AS SHOWN.
 FOR NPN, REVERSE ALL POLARITIES.

Figure 2. Switching Time Equivalent Test Circuits

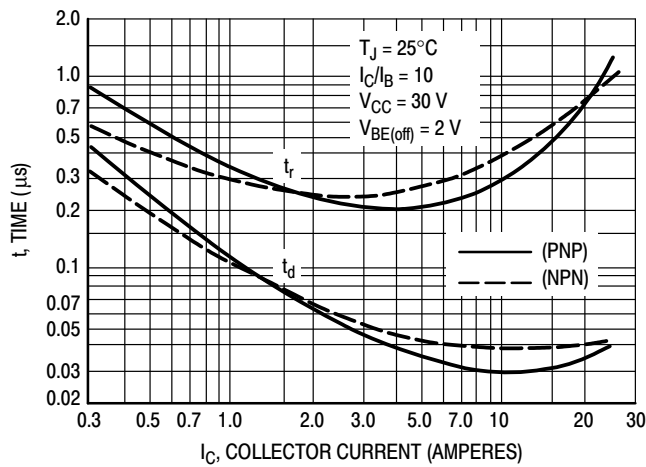

Figure 3. Turn-On Time

TIP35A, TIP35B, TIP35C (NPN); TIP36A, TIP36B, TIP36C (PNP)

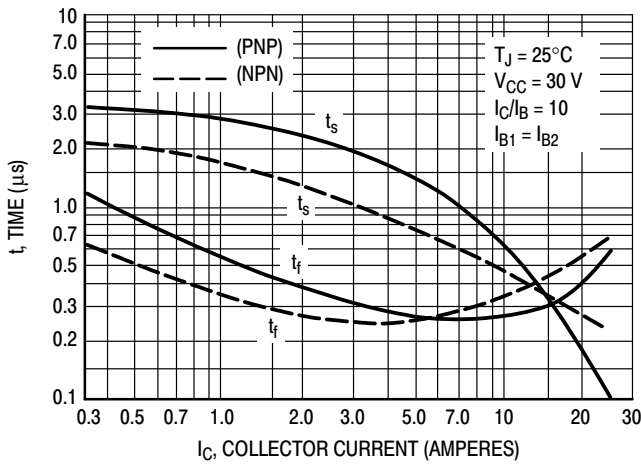

Figure 4. Turn-Off Time

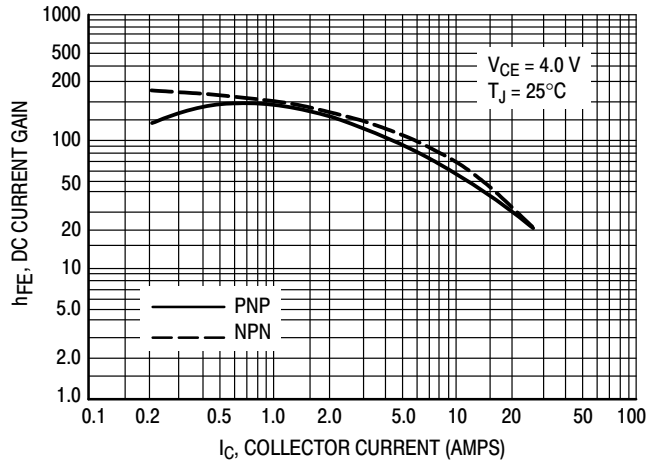

Figure 5. DC Current Gain

FORWARD BIAS

There are two limitations on the power handling ability of a transistor: average junction temperature and second breakdown. Safe operating area curves indicate $I_C - V_{CE}$ limits of the transistor that must be observed for reliable operation; i.e., the transistor must not be subjected to greater dissipation than the curves indicate.

The data of Figure 6 is based on $T_C = 25^\circ\text{C}$; $T_{J(pk)}$ is variable depending on power level. Second breakdown pulse limits are valid for duty cycles to 10% but must be derated when $T_C \geq 25^\circ\text{C}$. Second breakdown limitations do not derate the same as thermal limitations.

REVERSE BIAS

For inductive loads, high voltage and high current must be sustained simultaneously during turn-off, in most cases, with the base to emitter junction reverse biased. Under these conditions the collector voltage must be held to a safe level at or below a specific value of collector current. This can be accomplished by several means such as active clamping, RC snubbing, load line shaping, etc. The safe level for these devices is specified as Reverse Bias Safe Operating Area and represents the voltage-current conditions during reverse biased turn-off. This rating is verified under clamped conditions so that the device is never subjected to an avalanche mode. Figure 7 gives RBSOA characteristics.

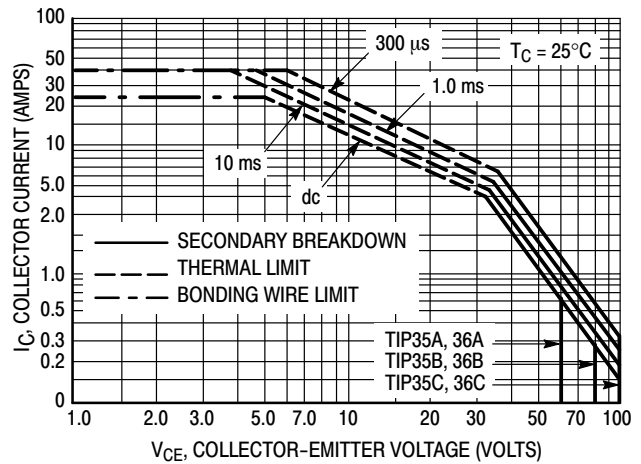

Figure 6. Maximum Rated Forward Bias Safe Operating Area

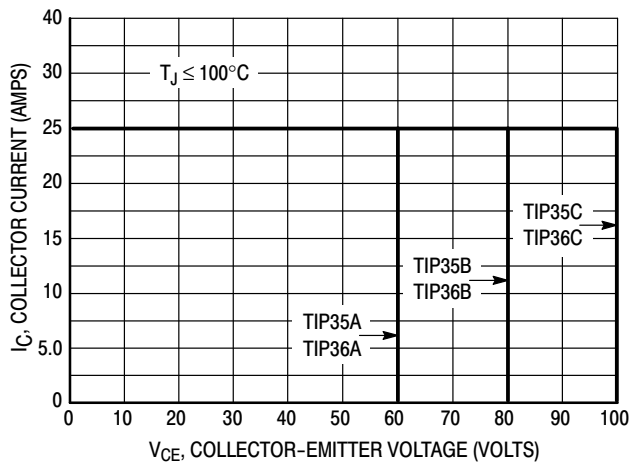
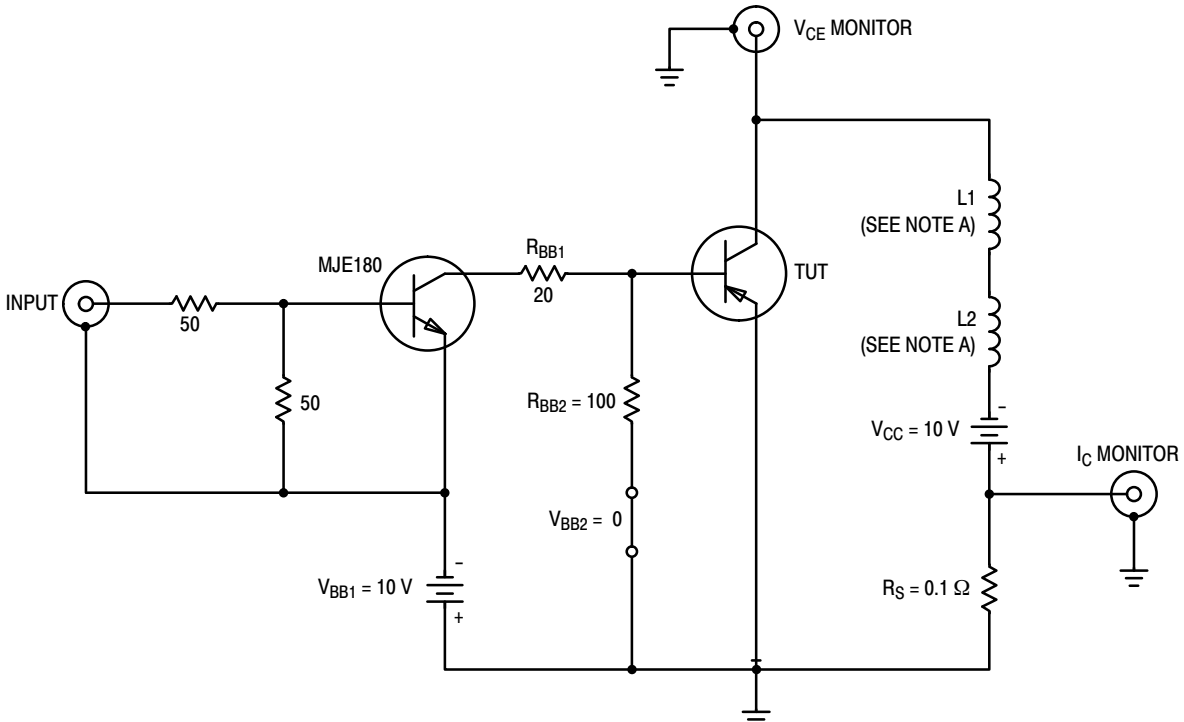

Figure 7. Maximum Rated Forward Bias Safe Operating Area

TIP35A, TIP35B, TIP35C (NPN); TIP36A, TIP36B, TIP36C (PNP)

TEST CIRCUIT



VOLTAGE AND CURRENT WAVEFORMS

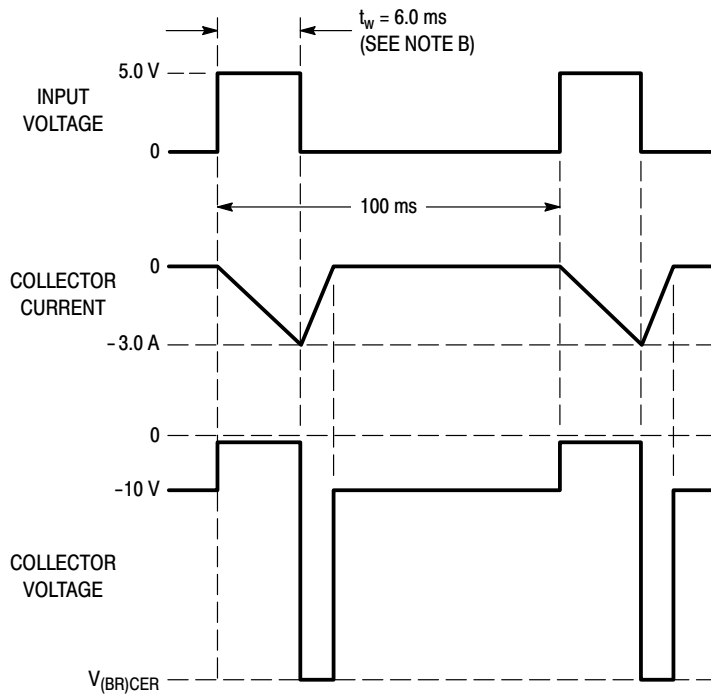

NOTES:

- A. L1 and L2 are 10 mH, 0.11 Ω , Chicago Standard Transformer Corporation C-2688, or equivalent.
- B. Input pulse width is increased until $I_{CM} = -3.0$ A.
- C. For NPN, reverse all polarities.

Figure 8. Inductive Load Switching

TIP35A, TIP35B, TIP35C (NPN); TIP36A, TIP36B, TIP36C (PNP)

PACKAGE DIMENSIONS

SOT-93 (TO-218) CASE 340D-02 ISSUE E

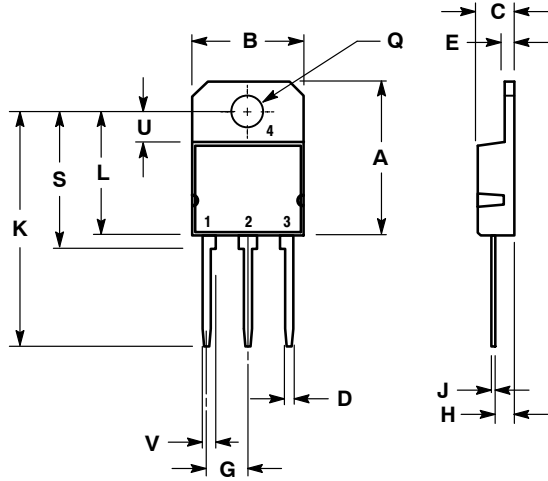

- NOTES:
1. DIMENSIONING AND TOLERANCING PER ANSI Y14.5M, 1982.
2. CONTROLLING DIMENSION: MILLIMETER.

DIM	MILLIMETERS		INCHES	
	MIN	MAX	MIN	MAX
A	---	20.35	---	0.801
B	14.70	15.20	0.579	0.598
C	4.70	4.90	0.185	0.193
D	1.10	1.30	0.043	0.051
E	1.17	1.37	0.046	0.054
G	5.40	5.55	0.213	0.219
H	2.00	3.00	0.079	0.118
J	0.50	0.78	0.020	0.031
K	31.00 REF		1.220 REF	
L	---	16.20	---	0.638
Q	4.00	4.10	0.158	0.161
S	17.80	18.20	0.701	0.717
U	4.00 REF		0.157 REF	
V	1.75 REF		0.069	

- STYLE 1:
PIN 1. BASE
2. COLLECTOR
3. EMITTER
4. COLLECTOR

TO-247 CASE 340L-02 ISSUE F

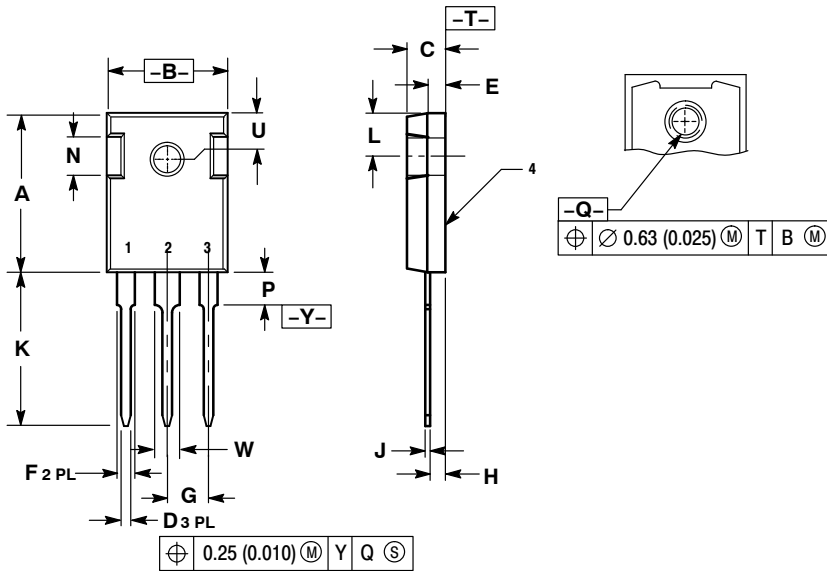

- NOTES:
1. DIMENSIONING AND TOLERANCING PER ANSI Y14.5M, 1982.
2. CONTROLLING DIMENSION: MILLIMETER.

DIM	MILLIMETERS		INCHES	
	MIN	MAX	MIN	MAX
A	20.32	21.08	0.800	0.830
B	15.75	16.26	0.620	0.640
C	4.70	5.30	0.185	0.209
D	1.00	1.40	0.040	0.055
E	1.90	2.60	0.075	0.102
F	1.65	2.13	0.065	0.084
G	5.45 BSC		0.215 BSC	
H	1.50	2.49	0.059	0.098
J	0.40	0.80	0.016	0.031
K	19.81	20.83	0.780	0.820
L	5.40	6.20	0.212	0.244
N	4.32	5.49	0.170	0.216
P	---	4.50	---	0.177
Q	3.55	3.65	0.140	0.144
U	6.15 BSC		0.242 BSC	
W	2.87	3.12	0.113	0.123

- STYLE 3:
PIN 1. BASE
2. COLLECTOR
3. EMITTER
4. COLLECTOR

TIP35A, TIP35B, TIP35C (NPN); TIP36A, TIP36B, TIP36C (PNP)

ON Semiconductor and  are registered trademarks of Semiconductor Components Industries, LLC (SCILLC). SCILLC reserves the right to make changes without further notice to any products herein. SCILLC makes no warranty, representation or guarantee regarding the suitability of its products for any particular purpose, nor does SCILLC assume any liability arising out of the application or use of any product or circuit, and specifically disclaims any and all liability, including without limitation special, consequential or incidental damages. "Typical" parameters which may be provided in SCILLC data sheets and/or specifications can and do vary in different applications and actual performance may vary over time. All operating parameters, including "Typicals" must be validated for each customer application by customer's technical experts. SCILLC does not convey any license under its patent rights nor the rights of others. SCILLC products are not designed, intended, or authorized for use as components in systems intended for surgical implant into the body, or other applications intended to support or sustain life, or for any other application in which the failure of the SCILLC product could create a situation where personal injury or death may occur. Should Buyer purchase or use SCILLC products for any such unintended or unauthorized application, Buyer shall indemnify and hold SCILLC and its officers, employees, subsidiaries, affiliates, and distributors harmless against all claims, costs, damages, and expenses, and reasonable attorney fees arising out of, directly or indirectly, any claim of personal injury or death associated with such unintended or unauthorized use, even if such claim alleges that SCILLC was negligent regarding the design or manufacture of the part. SCILLC is an Equal Opportunity/Affirmative Action Employer. This literature is subject to all applicable copyright laws and is not for resale in any manner.

PUBLICATION ORDERING INFORMATION

LITERATURE FULFILLMENT:

Literature Distribution Center for ON Semiconductor
P.O. Box 5163, Denver, Colorado 80217 USA
Phone: 303-675-2175 or 800-344-3860 Toll Free USA/Canada
Fax: 303-675-2176 or 800-344-3867 Toll Free USA/Canada
Email: orderlit@onsemi.com

N. American Technical Support: 800-282-9855 Toll Free
USA/Canada
Europe, Middle East and Africa Technical Support:
Phone: 421 33 790 2910
Japan Customer Focus Center
Phone: 81-3-5817-1050

ON Semiconductor Website: www.onsemi.com
Order Literature: <http://www.onsemi.com/orderlit>
For additional information, please contact your local
Sales Representative



Компания «ЭлектроПласт» предлагает заключение долгосрочных отношений при поставках импортных электронных компонентов на взаимовыгодных условиях!

Наши преимущества:

- Оперативные поставки широкого спектра электронных компонентов отечественного и импортного производства напрямую от производителей и с крупнейших мировых складов;
- Поставка более 17-ти миллионов наименований электронных компонентов;
- Поставка сложных, дефицитных, либо снятых с производства позиций;
- Оперативные сроки поставки под заказ (от 5 рабочих дней);
- Экспресс доставка в любую точку России;
- Техническая поддержка проекта, помощь в подборе аналогов, поставка прототипов;
- Система менеджмента качества сертифицирована по Международному стандарту ISO 9001;
- Лицензия ФСБ на осуществление работ с использованием сведений, составляющих государственную тайну;
- Поставка специализированных компонентов (Xilinx, Altera, Analog Devices, Intersil, Interpoint, Microsemi, Aeroflex, Peregrine, Syfer, Eurofarad, Texas Instrument, Miteq, Cobham, E2V, MA-COM, Hittite, Mini-Circuits, General Dynamics и др.);

Помимо этого, одним из направлений компании «ЭлектроПласт» является направление «Источники питания». Мы предлагаем Вам помощь Конструкторского отдела:

- Подбор оптимального решения, техническое обоснование при выборе компонента;
- Подбор аналогов;
- Консультации по применению компонента;
- Поставка образцов и прототипов;
- Техническая поддержка проекта;
- Защита от снятия компонента с производства.



Как с нами связаться

Телефон: 8 (812) 309 58 32 (многоканальный)

Факс: 8 (812) 320-02-42

Электронная почта: org@eplast1.ru

Адрес: 198099, г. Санкт-Петербург, ул. Калинина, дом 2, корпус 4, литера А.