

MT2A

Cable Actuated Sensor

Test Applications • Voltage Divider

Compact String Pot • Flight/Crash Test Applications
Dual Axis 360° Mounting Bracket
3, 9, 15, 30 and 50-inch Stroke Range Options
Aluminum & Polycarbonate Enclosure • GAM Certification

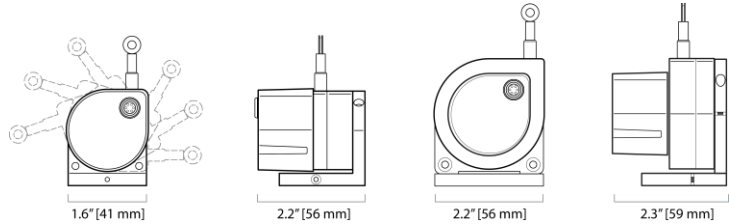

The MT2A is a member of our family of rugged, accurate miniature cable-extension position transducers designed specifically for test applications. One of the major benefits to this sensor is its 2-axis 360° rotating mounting bracket to allow for fast and simple installation in any direction.

The MT2A comes in 5 different measuring ranges: 0-3", 0-9", 0-15", 0-30", 0-50" and features a highly-tensioned heavy-duty measuring cable designed for the high-acceleration demands encountered in flight testing and automotive crash tests.

For extreme impact applications, a new rugged all aluminum sensor cover is now available!

Output Signal

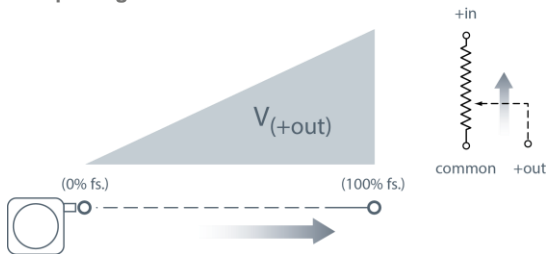

General

Full Stroke Range Options	0-3, 0-9, 0-15, 0-30, 0-50 inches, min.
Output Signal	voltage divider (potentiometer)
Accuracy	± 1.1% to 0.15% full stroke (see ordering information)
Repeatability	± 0.02% full stroke
Resolution	essentially infinite
Measuring Cable	Ø.019-in. nylon-coated stainless steel
Enclosure Material	anodized aluminum
Sensor Cover Options	aluminum or polycarbonate
Sensor	conductive plastic-hybrid potentiometer
Weight	0.5 lb. max.

Electrical

Input Resistance	10K ohms (± 10%)
Power Rating, Watts	2.0 at 158°F (70° C), derated to 0 @ 255°F (125°C)
Recommended Maximum Input Voltage	30V (AC or DC)
Electrical Stroke	94% ±4% of input voltage
Mating Plug	LEMO FGG.OB.304.CLAD52

Mechanical

Measuring Cable Tension Options	see ordering information
Maximum Measuring Cable Acceleration	136 g

Environmental

Operating Temperature	-65° to 255° F (-55° to 125°C)
------------------------------	---------------------------------

Outline Drawing (0-3 to 0-30 inch ranges)

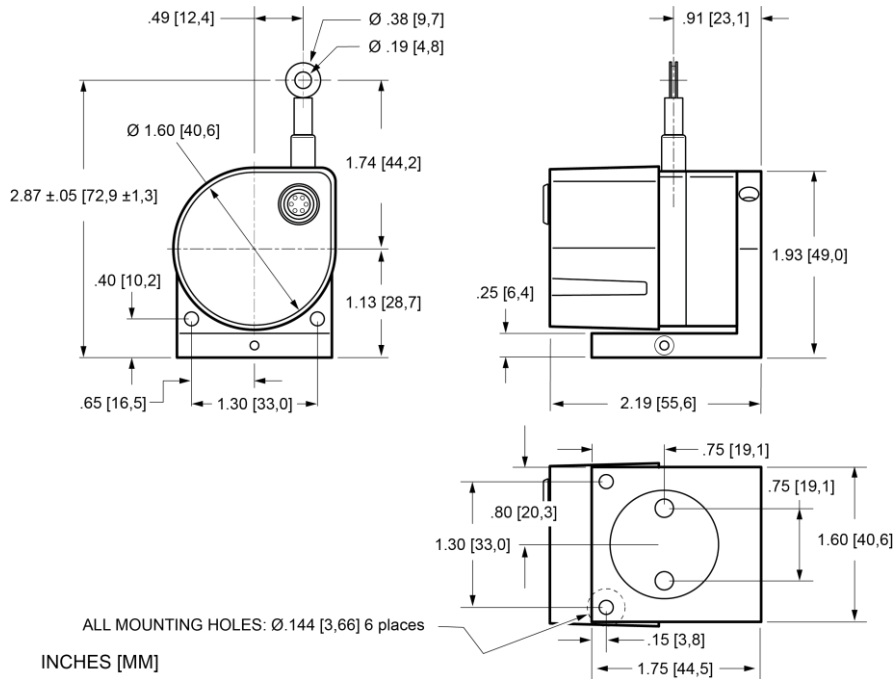

Outline Drawing (0-50 inch range)

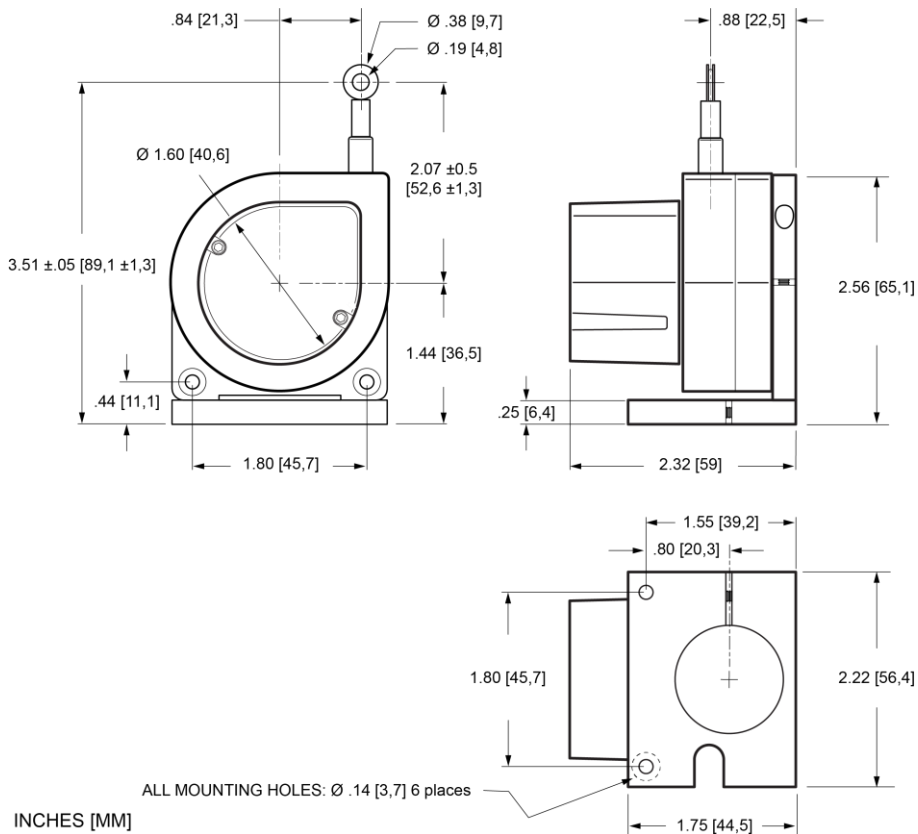

Ordering Information

Model Number:

MT2A - - - **10K** -
order code: **R** **A** **B** **C**

Sample Model Number:

MT2A - 9E - 33 - 10K - M1A

- R** range: 9 inches
- A** measuring cable termination: eyelet
- B** measuring cable tension: 33 oz. (±6 oz.)
- C** electrical connection: end-mounted connector w/ aluminum sensor cover

Full Stroke Range:

R <i>order code:</i>	3	9	15	30	50
full stroke range, min:	3 inches	9 inches	15 inches	30 inches	50 inches
potentiometer cycle-life:	2.5×10^6	8.3×10^5	5.0×10^5	2.5×10^5	2.5×10^5
accuracy (% of full stroke):	1.1 %	.25%	.20%	.15%	.15%

Measuring Cable Termination:

A *order code:* **E** **L**

Eyelet Leader Cable (24 in. long)

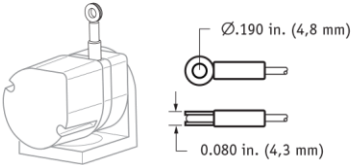

Ø.190 in. (4,8 mm)

0.080 in. (4,3 mm)

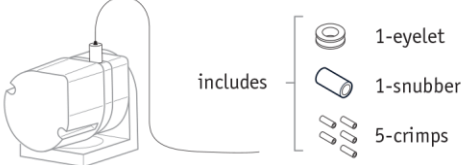





includes



- 1-eyelet
- 1-snubber
- 5-crimps

Measuring Cable Tension:

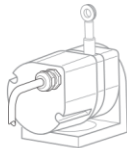
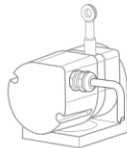
B <i>order code:</i>	9	14	33
3, 9, 15, 30-in. range options:	9 (±2) oz.	14 (±4) oz.	33 (±6) oz.
max. cable acceleration:	99 g	136 g	136 g
B <i>order code:</i>	9	22	
50-in. range options:	9 (±2) oz.	22 (±6) oz.	
max. cable acceleration:	46 g	68 g	

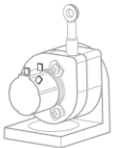
Electrical Connection/ Sensor Cover:

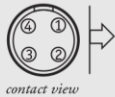
ⓐ	order code:	M1	M1A	M2	M2A	M3	M3A		
	sensor cover:	polycarbonate	aluminum	polycarbonate	aluminum	polycarbonate	aluminum		
	electrical connection:		end-mount connector*		side-mount connector*		top-mount connector*		
ⓑ	order code:	C1	C1A	C2	C2A	C3	C3A	S	
	sensor cover:	polycarbonate	aluminum	polycarbonate	aluminum	polycarbonate	aluminum	none**	
	electrical connection:		end-mount, instrumentation cable (15-ft. long, 24 ga., shielded)		side-mount, instrumentation cable (15-ft. long, 24 ga., shielded)		top-mount, instrumentation cable (15-ft. long, 24 ga., shielded)		solder terminals

	4-pin mating plug	pin#	signal		Instrumentation Cable	color	signal		Solder Terminals
contact view	Lemo FGG.OB.304.CLAD52	1	+in	24 ga., shielded		Red	+in	CW	+in
		2	common			Black	common	CCW	common
		3	+out			Green	+out	S	+out

*mating plug included **blank cover available, see **Accessories** on next page

Accessories



Part Number	Description
9603957-0015	15 ft. long cordset. Includes mating connector with 15 ft., 24 gauge, shielded multiconductor cable

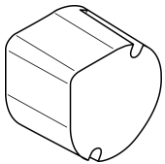

Additional blank sensor covers can be ordered separately. This cover comes without electrical wiring access holes so customer can drill to their requirements. Includes screws and gasket.

Part Number	Description
9604197-0000	Aluminum sensor cover
9603958-0000	Polycarbonate sensor cover

GAM EG 13 Certification (0-3 to 0-30 inch ranges only)**QUALIFICATION LEVEL FOR CLIMATIC AND THERMAL ENVIRONMENT**

External Overpressure, operating (GAM EG 13 Fasc.21)

5 cycles: 1...4.5 Bar in 3 min., 4.5 Bar for 12 hours,
4.5...1 Bar in 1 min.

1 cycle: 1...3.2 Bar in 7.5 min., 3.2 Bar for 2 min.,
3.2...8 Bar in 5 sec., 8 Bar for 2 hours,
8...1 Bar in 2 Bar/sec.

1 cycle: 1...4.5 Bar in 20 msec. 4.5 Bar for 5 sec,
4.5...1 Bar in 20 msec.

Thermal Vacuum Transitory, operating (GAM EG 13 Fasc.10)
Room pressure and temperature (1 Bar A; 20°C ±2°C)
1...10-3 mBar in 100 seconds
Vacuum (10-3 mBar) for 10 min.

Climatic Cycles (GAM EG 13 Fasc.8)

Dry heat: 24 hours @ 70°C ±2°C Relative Humidity < 50%
Wet heat: 24 hours @ 70°C ±2°C Relative Humidity = 50%
Cold: 24 hours @ -10°C ±2°C Relative Humidity < 50%
Wet heat: 24 hours @ 70°C ±2°C Relative Humidity = 100%

Dry Heat (Relative Humidity <50%)

Room temperature to 70°C in 30 mins
70°C for 5 hours, non-operating
70°C for 5 hours, operating
70°C to room temperature in 20 minutes

QUALIFICATION LEVEL FOR MECHANICAL ENVIRONMENT

Random Vibrations (GAM EG 13 Fasc.42 mod. Op1)
20...2000 Hz, 3 min. per axis, operating, 34 g.
20...2000 Hz, 20 sec. per axis, operating, 45 g.

Random Vibrations (GAM EG 13 Fasc.41 mod. Op3)
Compensated Levels, short duration
3...300 Hz @ .2 – .002 g²/ Hz.

Research Critical Frequency
Logarithmic Run, 1 octave / min., 1...2000 Hz.

Steady Acceleration, operating (GAM EG 13 Fas.45)
37 g, 3 min. per direction (2 directions per axis)

Sinusoidal Vibrations, operating (Gam EG 13 Fasc.41 mod. Op3)
Logarithmic run, 1 octave/min. on 3 axis
3...50 Hz. 9 hours per axis @0.6...1.25 g

Sinusoidal Vibrations, operating (Gam EG 13 Fasc.41 mod. Op3)
Logarithmic run, 1 octave/min. on 3 axis
5...2 KHz. 3 axis @12...25 g.

Average Shock (GAM EG 13 Fasc.43 Mode Op1)
1 shock, 1/2 sinusoidal, 100g. 6 msec. operating,
with longitudinal and back direction

Free Fall (GAM EG 13 Fasc.43 Mode Op4)
6 consecutive drops on wood table, height = 100mm

NORTH AMERICA

Measurement Specialties, Inc.,
a TE Connectivity company
20630 Plummer Street
Chatsworth, CA 91311
Tel +1 800 423 5483
Tel +1 818 701 2750
Fax +1 818 701 2799
Customercare.chtw@te.com

TE.com/sensorsolutions

Measurement Specialties, Inc., a TE Connectivity company.

Measurement Specialties, TE Connectivity, TE Connectivity (logo) and EVERY CONNECTION COUNTS are trademarks. All other logos, products and/or company names referred to herein might be trademarks of their respective owners.

The information given herein, including drawings, illustrations and schematics which are intended for illustration purposes only, is believed to be reliable. However, TE Connectivity makes no warranties as to its accuracy or completeness and disclaims any liability in connection with its use. TE Connectivity's obligations shall only be as set forth in TE Connectivity's Standard Terms and Conditions of Sale for this product and in no case will TE Connectivity be liable for any incidental, indirect or consequential damages arising out of the sale, resale, use or misuse of the product. Users of TE Connectivity products should make their own evaluation to determine the suitability of each such product for the specific application.

© 2015 TE Connectivity Ltd. family of companies All Rights Reserved.

MT2A 12/01/2015



Компания «ЭлектроПласт» предлагает заключение долгосрочных отношений при поставках импортных электронных компонентов на взаимовыгодных условиях!

Наши преимущества:

- Оперативные поставки широкого спектра электронных компонентов отечественного и импортного производства напрямую от производителей и с крупнейших мировых складов;
- Поставка более 17-ти миллионов наименований электронных компонентов;
- Поставка сложных, дефицитных, либо снятых с производства позиций;
- Оперативные сроки поставки под заказ (от 5 рабочих дней);
- Экспресс доставка в любую точку России;
- Техническая поддержка проекта, помощь в подборе аналогов, поставка прототипов;
- Система менеджмента качества сертифицирована по Международному стандарту ISO 9001;
- Лицензия ФСБ на осуществление работ с использованием сведений, составляющих государственную тайну;
- Поставка специализированных компонентов (Xilinx, Altera, Analog Devices, Intersil, Interpoint, Microsemi, Aeroflex, Peregrine, Syfer, Eurofarad, Texas Instrument, Miteq, Cobham, E2V, MA-COM, Hittite, Mini-Circuits, General Dynamics и др.);

Помимо этого, одним из направлений компании «ЭлектроПласт» является направление «Источники питания». Мы предлагаем Вам помощь Конструкторского отдела:

- Подбор оптимального решения, техническое обоснование при выборе компонента;
- Подбор аналогов;
- Консультации по применению компонента;
- Поставка образцов и прототипов;
- Техническая поддержка проекта;
- Защита от снятия компонента с производства.



Как с нами связаться

Телефон: 8 (812) 309 58 32 (многоканальный)

Факс: 8 (812) 320-02-42

Электронная почта: org@eplast1.ru

Адрес: 198099, г. Санкт-Петербург, ул. Калинина, дом 2, корпус 4, литера А.