

# Analog Devices Welcomes Hittite Microwave Corporation

NO CONTENT ON THE ATTACHED DOCUMENT HAS CHANGED



**THIS PAGE INTENTIONALLY LEFT BLANK**



## GaAs MMIC SP3T Non-REFLECTIVE SWITCH, DC - 3.5 GHz

### Typical Applications

The HMC245AQS16 / 245AQS16E is ideal for:

- Basestation Infrastructure
- CATV / DBS
- Wireless Local Loop
- Test Equipment

### Features

- Low Insertion Loss: 0.7 dB @ 2.0 GHz
- Non-Reflective Design
- Integrated 2:3 TTL Decoder
- "All Off" Isolation State
- Single Positive Supply: Vdd = +5V
- 16 Lead QSOP SMT Package

### Functional Diagram

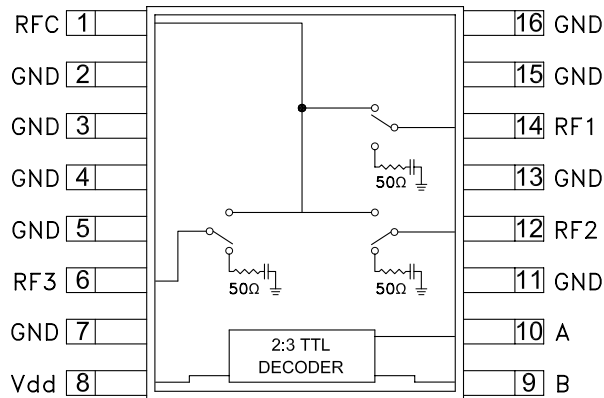

### General Description

The HMC245AQS16 & HMC245AQS16E are low cost non-reflective SP3T switches in 16-lead QSOP surface mount packages. Covering DC to 3.5 GHz, the switch offers 30 to 40 dB isolation and a low insertion loss of 0.7 dB. A 2:3 TTL/CMOS compatible decoder is integrated on the switch requiring only 2 control lines and a single +5V bias to select each path, replacing 6 control lines normally required by GaAs SP3T switches.

### Electrical Specifications,

$T_A = +25^\circ C$ , For TTL Control and Vdd = +5V in a 50 Ohm System

Parameter	Frequency	Min.	Typ.	Max.	Units
Insertion Loss	DC - 2.0 GHz		0.7	1.0	dB
	DC - 3.0 GHz		0.8	1.3	dB
	DC - 3.5 GHz		1.1	1.5	dB
Isolation	DC - 1.0 GHz	40	46		dB
	DC - 2.0 GHz	35	42		dB
	DC - 2.5 GHz	31	40		dB
	DC - 3.5 GHz	26	32		dB
Return Loss	"On State"	DC - 1.5 GHz	23		dB
		DC - 3.5 GHz	17		dB
Return Loss RF1 - 3	"Off State"	0.3 - 3.5 GHz	12		dB
		0.5 - 3.5 GHz	15		dB
Input Power for 1 dB Compression	0.3 - 2.5 GHz	26	29		dBm
	0.3 - 3.5 GHz	25	28		dBm
Input Third Order Intercept (Two-tone Input Power = +10 dBm each tone)	0.3 - 2.5 GHz	44	48		dBm
	0.3 - 3.5 GHz	40	44		dBm
Switching Characteristics	0.3 - 3.5 GHz	tRISE, tFALL (10/90% RF)	40		ns
		tON, tOFF (50% CTL to 10/90% RF)	150		ns

For price, delivery and to place orders: Hittite Microwave Corporation, 2 Elizabeth Drive, Chelmsford, MA 01824

Phone: 978-250-3343 Fax: 978-250-3373 Order On-line at [www.hittite.com](http://www.hittite.com)

Application Support: Phone: 978-250-3343 or [apps@hittite.com](mailto:apps@hittite.com)

### Insertion Loss vs. Temperature

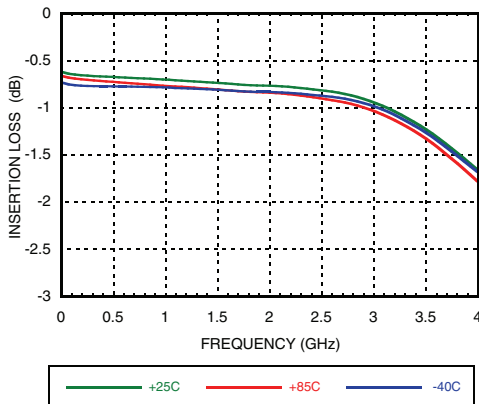

### Isolation

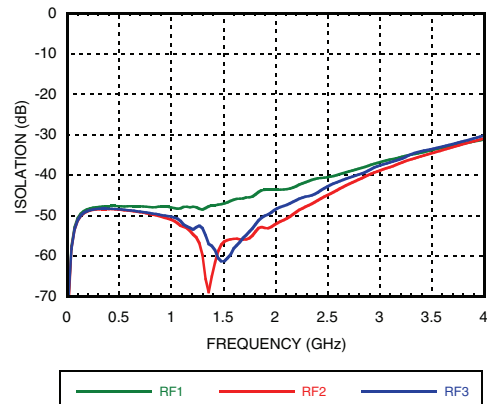

### Return Loss

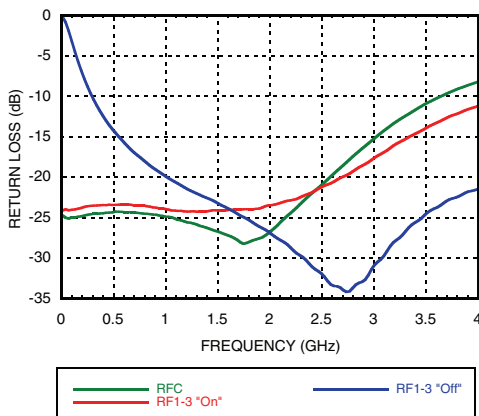

### Off State Isolation

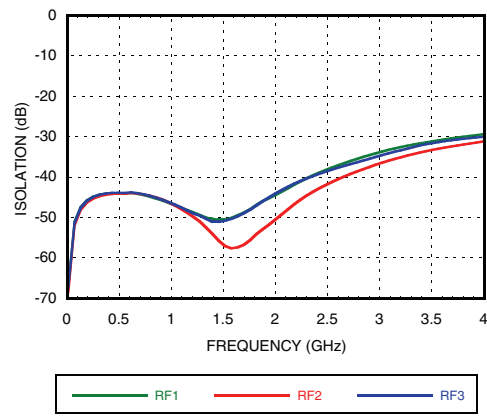

### 0.1 and 1 dB Input Compression Point

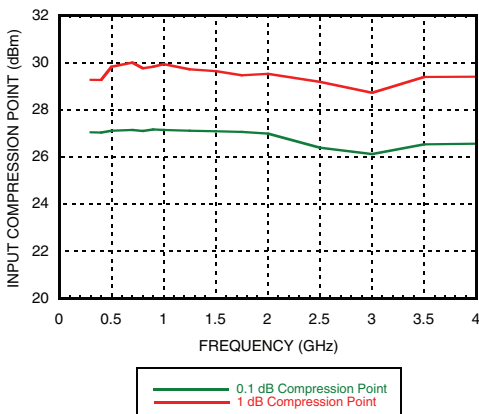

### Input Third Order Intercept Point

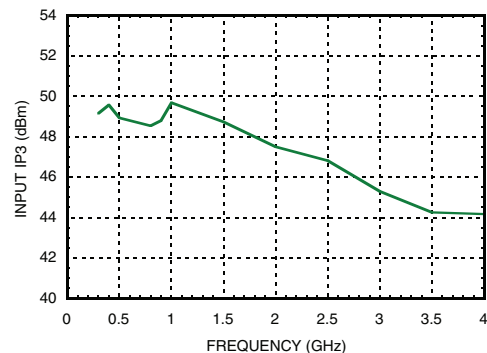



## GaAs MMIC SP3T Non-REFLECTIVE SWITCH, DC - 3.5 GHz

### Bias Voltage & Current

Vdd Range= +5 Vdc ±10%		
Vdd (Vdc)	Idd (Typ) (mA)	Idd (Max) (mA)
+5	2.2	6.0

### TTL/CMOS Control Voltages

State	Bias Condition
Low	0 to +0.8 Vdc @ 0.2 µA Typ.
High	+2.0 to +5 Vdc @ 35 µA Typ.

### Truth Table

Control Input		Signal Path State
A	B	RF COM to:
Low	Low	RF1
High	Low	RF2
Low	High	RF3
High	High	All Off

### Absolute Maximum Ratings

Bias Voltage Range (Port Vdd)	+7.0 Vdc
Control Voltage Range (A & B)	-0.5V to Vdd +1 Vdc
Channel Temperature	150 °C
Thermal Resistance	
Insertion Loss Path	150 °C/W
Terminated Path	297 °C/W
Storage Temperature	-65 to +150 °C
Operating Temperature	-40 to +85 °C
Maximum Input Power Vdd = +5 Vdc	
Insertion Loss Path	+28.5 dBm
Terminated Path	+23.4 dBm
ESD Sensitivity (HBM)	Class 1A



ELECTROSTATIC SENSITIVE DEVICE  
OBSERVE HANDLING PRECAUTIONS

### Outline Drawing

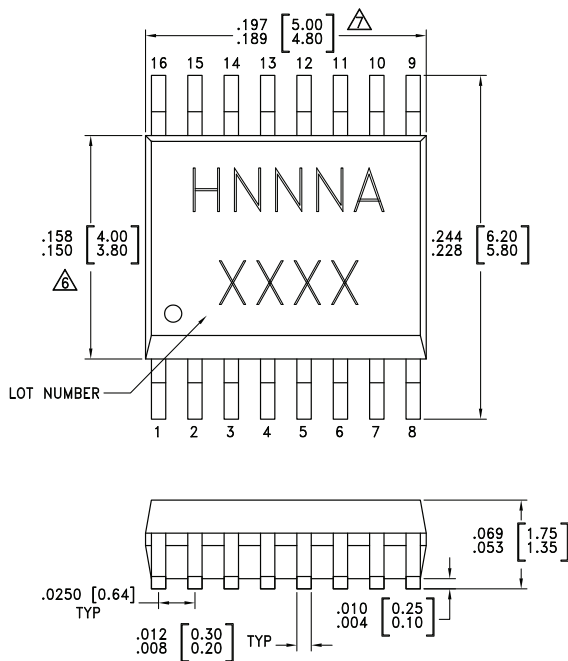

#### NOTES:

- LEADFRAME MATERIAL: COPPER ALLOY
- DIMENSIONS ARE IN INCHES [MILLIMETERS].
- $\triangle$  DIMENSION DOES NOT INCLUDE MOLDFLASH OF 0.15mm PER SIDE.
- $\triangle$  DIMENSION DOES NOT INCLUDE MOLDFLASH OF 0.25mm PER SIDE.
- ALL GROUND LEADS MUST BE SOLDERED TO PCB RF GROUND.

### Package Information

Part Number	Package Body Material	Leadframe Plating	MSL Rating	Package Marking <sup>[3]</sup>
HMC245AQS16	Low Stress Injection Molding Plastic Silica and Silicon Impregnated	Sn/Pb Solder	MSL1 <sup>[1]</sup>	HMC245A XXXX
HMC245AQS16E	RoHS-compliant Low Stress Injection Molding Plastic Silica and Silicon Impregnated	100% Matte Tin	MSL1 <sup>[2]</sup>	<u>HMC245A</u> XXXX

[1] Max peak reflow temperature of 235 °C

[2] Max peak reflow temperature of 260 °C

[3] 4-Digit lot number XXXX

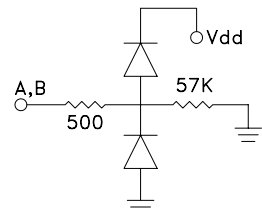

### Pin Descriptions

Pin Number	Function	Description	Interface Schematic
1, 6, 12, 14	RF3, RF2, RF1, RFC	This pin is DC coupled and matched to 50 Ohms. Blocking capacitors are required.	
2 - 5, 7, 11, 13, 15, 16	GND	This pin must be connected to PCB RF ground to maximize isolation.	
8	Vdd	Supply Voltage +5 Vdc ±10%	
9	B	See truth table and control voltage table.	
10	A	See truth table and control voltage table.	

### Evaluation PCB

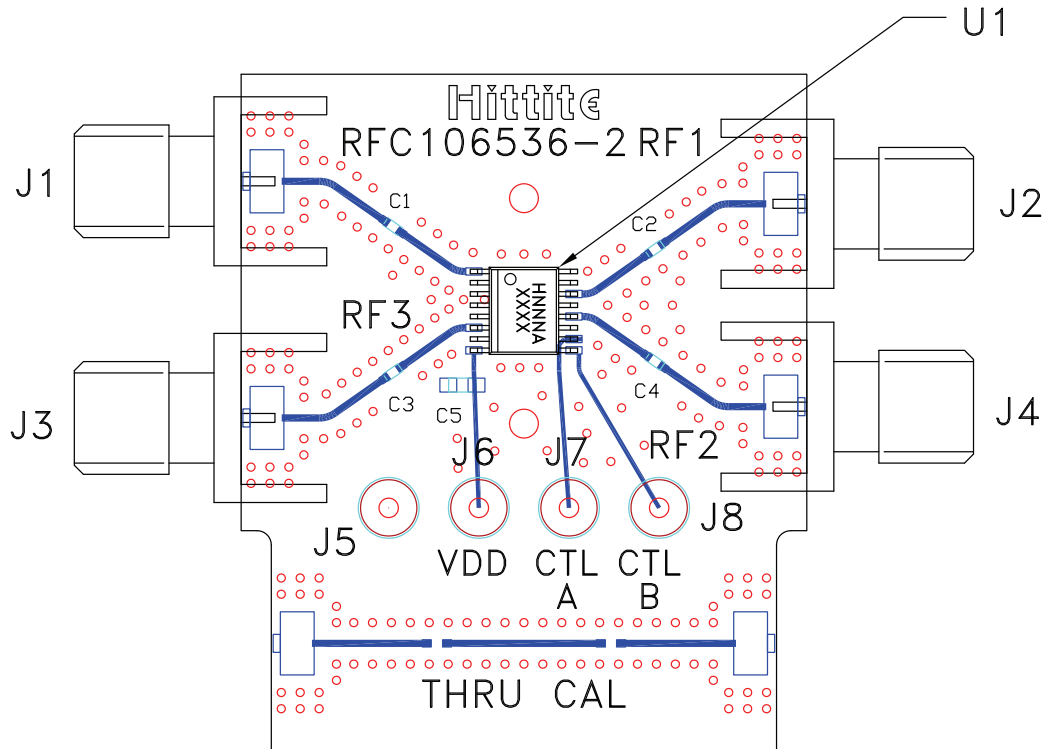

### List of Materials for Evaluation PCB EV1HMC245AQS16 [1]

Item	Description
J1 - J4	PCB Mount SMA RF Connector
J5 - J8	DC Pin
C1 - C4	100 pF Capacitor, 0402 Pkg.
C5	10k pF Capacitor, 0603 Pkg.
U1	HMC245AQS16 / 245AQS16E SP3T Switch
PCB [2]	106536 Evaluation PCB

[1] Reference this number when ordering complete evaluation PCB

[2] Circuit Board Material: Rogers 4350

The circuit board used in the application should be generated with proper RF circuit design techniques. Signal lines at the RF port should have 50 ohm impedance and the package ground leads should be connected directly to the ground plane similar to that shown above. The evaluation circuit board shown above is available from Hittite Microwave Corporation upon request.





Компания «ЭлектроПласт» предлагает заключение долгосрочных отношений при поставках импортных электронных компонентов на взаимовыгодных условиях!

Наши преимущества:

- Оперативные поставки широкого спектра электронных компонентов отечественного и импортного производства напрямую от производителей и с крупнейших мировых складов;
- Поставка более 17-ти миллионов наименований электронных компонентов;
- Поставка сложных, дефицитных, либо снятых с производства позиций;
- Оперативные сроки поставки под заказ (от 5 рабочих дней);
- Экспресс доставка в любую точку России;
- Техническая поддержка проекта, помощь в подборе аналогов, поставка прототипов;
- Система менеджмента качества сертифицирована по Международному стандарту ISO 9001;
- Лицензия ФСБ на осуществление работ с использованием сведений, составляющих государственную тайну;
- Поставка специализированных компонентов (Xilinx, Altera, Analog Devices, Intersil, Interpoint, Microsemi, Aeroflex, Peregrine, Syfer, Eurofarad, Texas Instrument, Miteq, Cobham, E2V, MA-COM, Hittite, Mini-Circuits, General Dynamics и др.);

Помимо этого, одним из направлений компании «ЭлектроПласт» является направление «Источники питания». Мы предлагаем Вам помощь Конструкторского отдела:

- Подбор оптимального решения, техническое обоснование при выборе компонента;
- Подбор аналогов;
- Консультации по применению компонента;
- Поставка образцов и прототипов;
- Техническая поддержка проекта;
- Защита от снятия компонента с производства.



#### Как с нами связаться

**Телефон:** 8 (812) 309 58 32 (многоканальный)

**Факс:** 8 (812) 320-02-42

**Электронная почта:** [org@eplast1.ru](mailto:org@eplast1.ru)

**Адрес:** 198099, г. Санкт-Петербург, ул. Калинина, дом 2, корпус 4, литера А.