

AC Line Filters

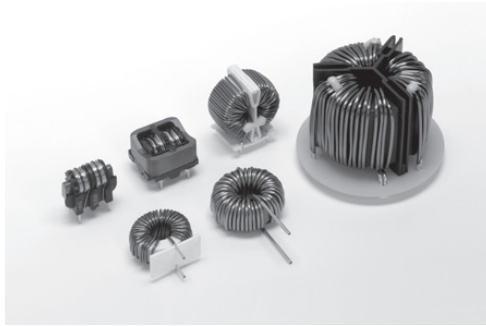

Vol. 17



- All specifications in this catalog and production status of products are subject to change without notice. Prior to the purchase, please contact TOKIN for updated product data.
- Please request for a specification sheet for detailed product data prior to the purchase.
- Before using the product in this catalog, please read "Precautions" and other safety precautions listed in the printed version catalog.

Contents

Tips on AC Line Filters Usages	4
Compatibility of the SS series with the SSR and SSRH series	5
New products	
SCR Coils SCR22 Type	6
SCR Coils SCR25 Type	7
SCR Coils SCR31 Type	8
SCR Coils Three-phase Type	9
SSRH24NH Series High Impedance Type	11
SSRH24NHS Series Wide Range Impedance Type	13
SSR10V/H Series High Impedance Type	15
SSR10VS/HS Series Wide Range Impedance Type	17
SSR21NV/NH Series High Impedance Type	19
SSR21NVS/NHS Series Wide Range Impedance Type	21
SSR21NV-M/NH-M Series High Impedance Type	23
SSR21NVS-M/NHS-M Series Wide Range Impedance Type	25
Normal Choke Coil HHBC Series (Fe-Si)	27
Normal Choke Coil SHBC Series (Fe-Si-Al)	31
Normal Choke Coil PHBC Series (Fe-Ni)	35
Earth inductors	
SNG series	39
Common mode	
SC Coils - Standard Type	41
SC Coils - Terminal Base Type SC-J Type	43
SC Coils - Terminal Base Type SC-GJ Type	45
SC Coils - Terminal Base Type SC-JS Type	46
SC Coils - Terminal Base Type SC-JH Type	47
SC Coils - Small Type SC-G/GS Type	48
SC Coils - Compact, High-Inductance Type SCF Type	50
SC Coils - High Frequency Type SC-D Type	51
SCR Coils Standard Type	52
SCR Coils SCR38 Type	53
SCR Coils SCR47 Type	54
SU Coils SU 7VC Type	55
SU Coils SU 9V/9H Type	56
SU Coils SU 9VF/9HF Type	58
SU Coils SU 10VFC-R Type	59
SU Coils - High Frequency Type SU 9VD Type	60
SU Coils - High Frequency Type SU 10VD Type	61
SU Coils - High Frequency Type SU 16VD Type	62
SS Coils SS11VL Type	63
SS Coils SSB11V-R/11H-R Type	65
SS Coils SS21V Type	66
SS Coils SS24V/H-CH Type	68
SS Coils SS26V Type	70
SS Coils SS28V/H-CH Type	72
SS Coils SS30V Type	74
SS Coils SS35V/35H Type	76
Normal mode	
SN Coils: Characteristics and Precautions	77
HHB Coils Hi μ and Low Core loss Type	79
SN Coils Small and Standard Type	83
SN Coils Terminal Base Type - J Type	86
SN Coils Terminal Base Type - JA Type	87
SN Coils Terminal Base Type - JB Type	88
SN Coils Terminal Base Type - P2 Type	89
High frequency type	
SHB Coils (Booster Coils for Active Filters)	90
Precautions	92



- All specifications in this catalog and production status of products are subject to change without notice. Prior to the purchase, please contact TOKIN for updated product data.
- Please request for a specification sheet for detailed product data prior to the purchase.
- Before using the product in this catalog, please read "Precautions" and other safety precautions listed in the printed version catalog.

AC Line Filters Vol.17



- All specifications in this catalog and production status of products are subject to change without notice. Prior to the purchase, please contact TOKIN for updated product data.
- Please request for a specification sheet for detailed product data prior to the purchase.
- Before using the product in this catalog, please read "Precautions" and other safety precautions listed in the printed version catalog.

Tips on AC Line Filters Usages

■ Suppression effect and effective band range, according to the magnetic permeability of each ferrite material

In noise reduction, it is important to select a material based on the target frequency band. In particular, an adopted ferrite material will be effective in a certain frequency band, depending on its magnetic permeability.

A schematic representation of the relationship between the magnetic permeability of each material and the corresponding effective band range is shown in Fig. 1.

Materials with higher magnetic permeability are effective in the lower frequency range, while those with lower magnetic permeability are effective in the higher frequency range. Accordingly, the Mn-Zn series is mainly used for reducing conduction noise, while the Ni-Zn series is mainly used for reducing radiation noise.

*S18H, S15H, 10H, 7H, 5H, 1400L, and 700L are ferrite material names of TOKIN. Materials other than the above are also available.

*The effective band range varies depending on core shape, size, and number of turns. This information regarding effective band range vs. magnetic permeability is provided for reference purposes only, and does not determine effectiveness. Please check the effectiveness on an actual device when using.

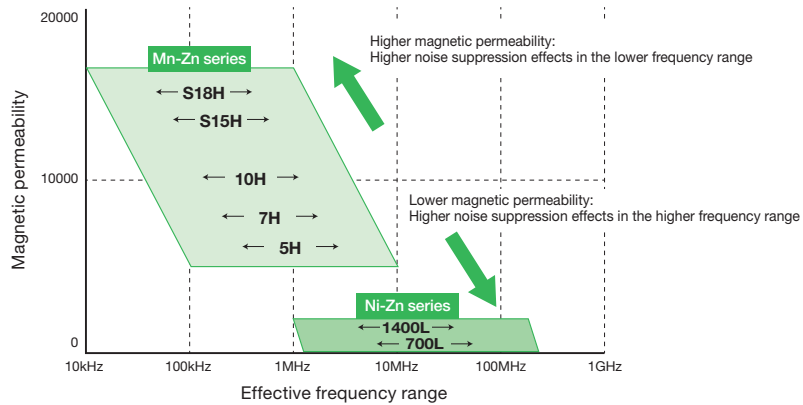

Fig. 1: Relationship between the magnetic permeability of each material and its effective band range



- All specifications in this catalog and production status of products are subject to change without notice. Prior to the purchase, please contact TOKIN for updated product data.
- Please request for a specification sheet for detailed product data prior to the purchase.
- Before using the product in this catalog, please read "Precautions" and other safety precautions listed in the printed version catalog.

Compatibility of the SS series with the SSR and SSRH series

The SSR and SSRH series are lighter and more compact, and achieve high inductance characteristics. They can be considered as replacements for the SS series.

The rated current and inductance ranges of the SS series products, along with the compatible products in the SSR and SSRH series to support replacement considerations, are shown in the list below.

SS Series		Current(A)	Inductance(mH)	SSR/SSRH Series	Page
	SS11VL Series	0.3~3	0.6~82		15~18
	SS21V Series	0.4~3	0.8~77		
	SS24V-CH Series	0.5~3	2.5~60		19~26
	SS24H-CH Series	0.5~3	2.5~60		
	SS26V Series	0.5~3	2.8~117		19~26
	SS28V-CH Series	0.8~2.5	4.5~60		
	SS28H-CH Series	0.8~2.5	4.5~60		11~14
	SS30V Series	1.0~4.5	1.3~53		

* The information provided in the above list does not guarantee compatibility.
 * Please contact TOKIN directly regarding detailed compatibility information for each specification.



- All specifications in this catalog and production status of products are subject to change without notice. Prior to the purchase, please contact TOKIN for updated product data.
- Please request for a specification sheet for detailed product data prior to the purchase.
- Before using the product in this catalog, please read "Precautions" and other safety precautions listed in the printed version catalog.

SCR Coils SCR22 Type

[RoHS Compliant]

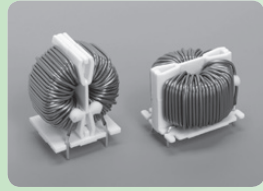

Features

- High impedance characteristics realized by using high permeability S15H material
- Enables saving space/reduction of part count

Applications

- Audio-visual equipment
- Home electric appliance
- Power supply devices

Model	Rated current (A)	Inductance (mH) min.	DC resistance (mΩ/line) max.	Temperature rise (K) max.	Wire size (mmφ)	Weight approx. (g)
SCR22-050-0R9A100J/JH	5	10	60	65	0.9	34
SCR22-060-1R0A075J/JH	6	7.5	42	70	1.0	34
SCR22-100-1R3A015J/JH	10	1.5	12	65	1.3	33

* Model names ending with "J": Vertical terminal type Model names ending with "JH": Horizontal terminal type
 ● Rated voltage: 250VAC/VDC ● Withstanding voltage: 2400VAC(2sec. between lines) ● Insulation resistance: at 500VDC, more than 100MΩ(between lines)
 ● Thermal class: E(120°C) ● Operating temperature: -25 to T(T=120-temperature rise) ● Inductance measurement condition: 10kHz

Shape and Dimensions

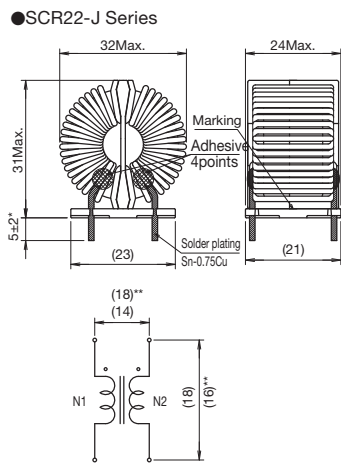

Impedance Characteristics

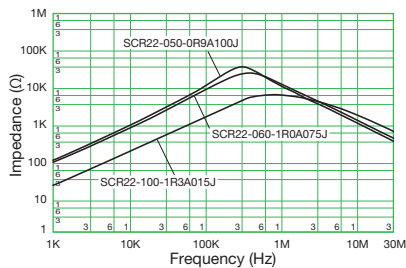

- All specifications in this catalog and production status of products are subject to change without notice. Prior to the purchase, please contact TOKIN for updated product data.
- Please request for a specification sheet for detailed product data prior to the purchase.
- Before using the product in this catalog, please read "Precautions" and other safety precautions listed in the printed version catalog.

SCR Coils SCR25 Type

[RoHS Compliant]

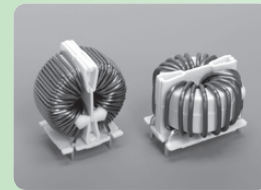

Features

- High impedance characteristics realized by using high permeability S15H material
- Enables saving space/reduction of part count

Applications

- Audio-visual equipment
- Home electric appliance
- Power supply devices

Model	Rated current (A)	Inductance (mH) min.	DC resistance (mΩ/line) max.	Temperature rise (K) max.	Wire size (mmφ)	Weight approx. (g)
SCR25-070-1R1A070J	7	7	34	80	1.1	48
SCR25B-105-1R3A035JH*	10.5	3.5	17	70	1.3	49
SCR25-200-1R7A008JH	20	0.8	4.7	66	1.7	45

* Model names ending with "J": Vertical terminal type Model names ending with "JH": Horizontal terminal type
 ● Rated voltage: 250VAC/VDC *500VAC/VDC ● Withstanding voltage: 2400VAC(2sec. between lines) ● Insulation resistance: at 500VDC, more than 100MΩ(between lines)
 ● Thermal class: E(120°C) ● Operating temperature: -25 to T(T=120-temperature rise) ● Inductance measurement condition: 10kHz

Shape and Dimensions

●SCR25-J Series

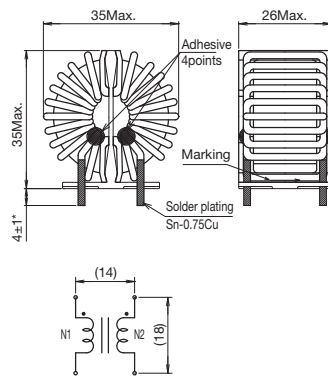

●SCR25-JH Series

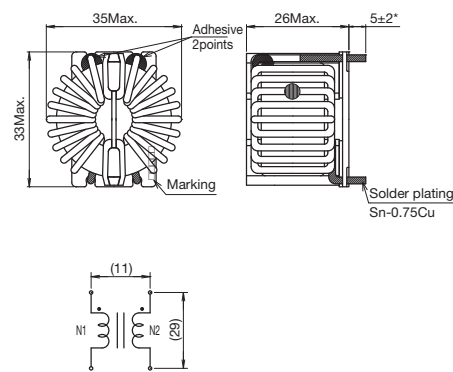

*Reference value.

[mm]

Impedance Characteristics

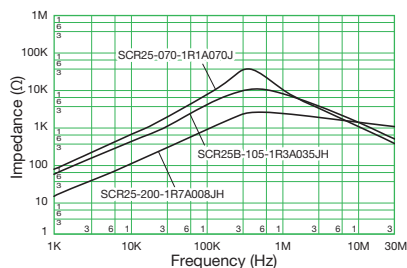

- All specifications in this catalog and production status of products are subject to change without notice. Prior to the purchase, please contact TOKIN for updated product data.
- Please request for a specification sheet for detailed product data prior to the purchase.
- Before using the product in this catalog, please read "Precautions" and other safety precautions listed in the printed version catalog.

SCR Coils SCR31 Type

[RoHS Compliant]



Features

- High impedance characteristics realized by using high permeability S15H material
- Enables saving space/reduction of part count

Applications

- Audio-visual equipment
- Home electric appliance
- Power supply devices

Model	Rated current (A)	Inductance (mH) min.	DC resistance (mΩ/line) max.	Temperature rise (K) max.	Wire size (mmφ)	Weight approx. (g)
SCR31B-105-1R4A055JH	10.5	5.5	22	80	1.4	84
SCR31B-200-1R9A017JH	20	1.7	6.3	79	1.9	87

- Rated voltage: 500VAC/VDC
- Withstanding voltage: 2400VAC(2sec. between lines)
- Insulation resistance: at 500VDC, more than 100MΩ(between lines)
- Thermal class: E(120°C)
- Operating temperature: -25 to T(T=120-temperature rise)
- Inductance measurement condition: 10kHz

Shape and Dimensions

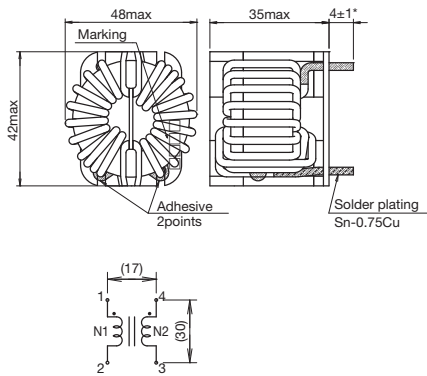

*Reference value.

[mm]

Impedance Characteristics

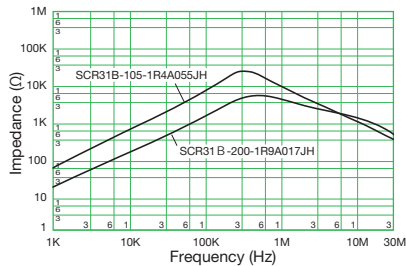

- All specifications in this catalog and production status of products are subject to change without notice. Prior to the purchase, please contact TOKIN for updated product data.
- Please request for a specification sheet for detailed product data prior to the purchase.
- Before using the product in this catalog, please read "Precautions" and other safety precautions listed in the printed version catalog.

SCR Coils Three-phase Type

[RoHS Compliant]



Features

- High impedance characteristics realized by using high permeability S15H material
- Enables saving space/reduction of part count

Applications

- Audio-visual equipment
- Home electric appliance
- Power supply devices

Model	Rated current (A)	Inductance (mH) min.	DC resistance (mΩ/line) max.	Temperature rise (K) max.	Wire size (mmφ)	Weight approx. (g)
SCR38C-130-S1R4A015JH	13	1.5	9.2	70	1.4	100
SCR47B-300-S1R7B020JH	30	2.0	4.8	87	1.7×2 Parallel	340
SCR47B-350-S2R0B010J	35	1.0	2.5	70	2.0×2 Parallel	340

* Model names ending with "J": Vertical terminal type Model names ending with "JH": Horizontal terminal type
 • Rated voltage: 500VAC/VDC • Withstanding voltage: 2400VAC(2sec. between lines) • Insulation resistance: at 500VDC, more than 100MΩ(between lines)
 • Thermal class: E(120°C) • Operating temperature: -25 to T(T=120-temperature rise) • Inductance measurement condition: 10kHz

Shape and Dimensions

●SCR38C-130-S1R4A015JH

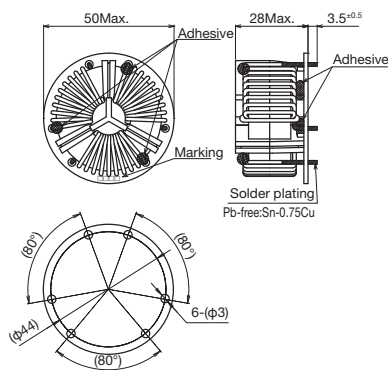

●SCR47B-300-S1R7B020JH

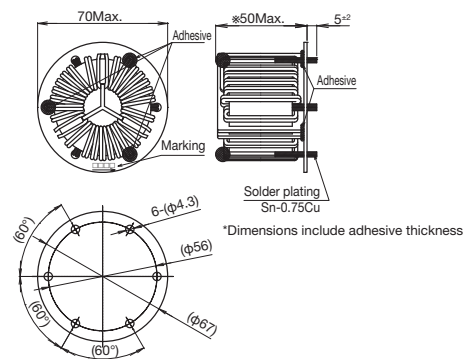

●SCR47B-350-S2R0B010J

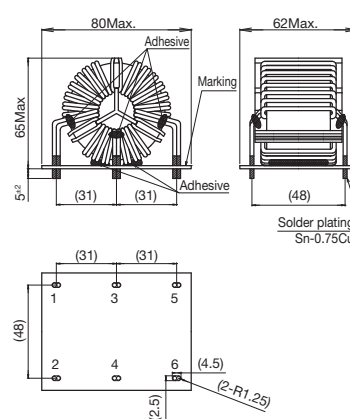

[mm]



- All specifications in this catalog and production status of products are subject to change without notice. Prior to the purchase, please contact TOKIN for updated product data.
- Please request for a specification sheet for detailed product data prior to the purchase.
- Before using the product in this catalog, please read "Precautions" and other safety precautions listed in the printed version catalog.

Impedance Characteristics

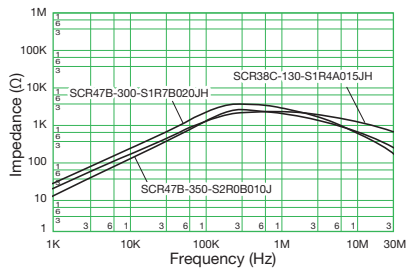

- All specifications in this catalog and production status of products are subject to change without notice. Prior to the purchase, please contact TOKIN for updated product data.
- Please request for a specification sheet for detailed product data prior to the purchase.
- Before using the product in this catalog, please read "Precautions" and other safety precautions listed in the printed version catalog.

SSRH24NH Series High Impedance Type

[RoHS Compliant]



Features

- Using high permeability S18H material, optimized core and structure
- Compact size and light weight (50% less volume than SS28H-CH)
- Expanded current range (SS28H-CH: up to 2.5A→New product: up to 5A)
- Realized high performance, low Rdc (Compared to SS28H-CH, Inductance: 2 times or more, Rdc: 3% or greater reduction)
- Non-split bobbin design for ultra-high impedance characteristics

Applications

- TV
- Office automation equipment
- Digital appliances
- Power supply devices

Model	Rated current (A)	Inductance (mH) min.	DC resistance (Ω/line) max.	Temperature rise (K) max.	Wire size (mmφ)	Weight approx. (g)
SSRH24NH-12655	1.2	65.5	0.475	65	0.4	22.5
SSRH24NH-16470	1.6	47	0.327	65	0.45	22.5
SSRH24NH-20310	2.0	31	0.214	65	0.5	22.5
SSRH24NH-25205	2.5	20.5	0.145	65	0.55	22.5
SSRH24NH-30145	3.0	14.5	0.102	65	0.6	22.5
SSRH24NH-35086	3.5	8.6	0.078	65	0.6	22.5
SSRH24NH-40069	4.0	6.9	0.057	65	0.65	22.5
SSRH24NH-45059	4.5	5.9	0.048	65	0.7	22.5
SSRH24NH-50041	5.0	4.1	0.035	65	0.75	22.5

- Rated voltage: 250VAC ● Withstanding voltage: 2400VAC (2sec. between lines)
- Insulation resistance: at 500VDC, more than 100MΩ (between lines) ● Thermal class: E (120°C)
- Operating temperature range (°C): -25 to T (T=120-temperature rise) ● Inductance measurement condition: 10kHz

Shape and Dimensions

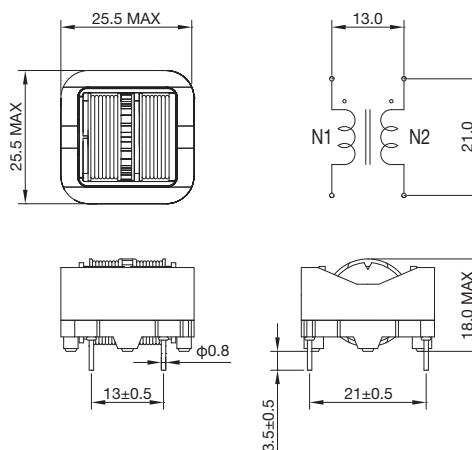

[mm]



- All specifications in this catalog and production status of products are subject to change without notice. Prior to the purchase, please contact TOKIN for updated product data.
- Please request for a specification sheet for detailed product data prior to the purchase.
- Before using the product in this catalog, please read "Precautions" and other safety precautions listed in the printed version catalog.

Impedance Characteristics

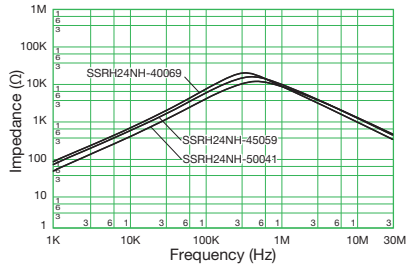
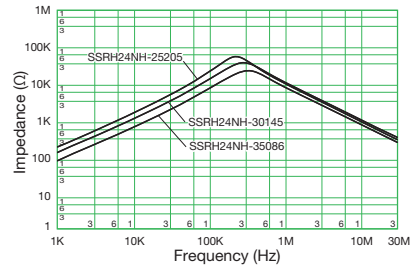
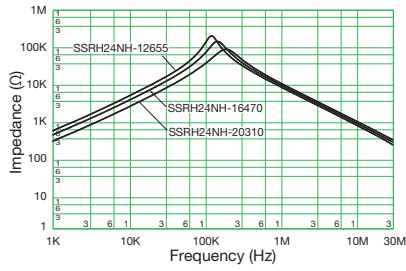

- All specifications in this catalog and production status of products are subject to change without notice. Prior to the purchase, please contact TOKIN for updated product data.
- Please request for a specification sheet for detailed product data prior to the purchase.
- Before using the product in this catalog, please read "Precautions" and other safety precautions listed in the printed version catalog.

SSRH24NHS Series Wide Range Impedance Type

[RoHS Compliant]



Features

- Using high permeability S18H material, optimized core and structure
- Compact size and light weight (50% less volume than SS28H-CH)
- Expanded current range (SS28H-CH: up to 2.5A→New product: up to 5A)
- Realized high performance, low Rdc (Compared to SS28H-CH, Inductance: 1.6 times or more, Rdc: 20% or greater reduction)
- Split bobbin design for wide band impedance characteristics

Applications

- TV
- Office automation equipment
- Digital appliances
- Power supply devices

Model	Rated current (A)	Inductance (mH) min.	DC resistance (Ω/line) max.	Temperature rise (K) max.	Wire size (mmφ)	Weight approx. (g)
SSRH24NHS-12500	1.2	50	0.430	65	0.4	22.5
SSRH24NHS-16320	1.6	32	0.265	65	0.45	22.5
SSRH24NHS-20215	2.0	21.5	0.177	65	0.5	22.5
SSRH24NHS-25130	2.5	13	0.111	65	0.55	22.5
SSRH24NHS-30092	3.0	9.2	0.079	65	0.6	22.5
SSRH24NHS-35080	3.5	8	0.074	65	0.6	22.5
SSRH24NHS-40059	4.0	5.9	0.055	65	0.65	22.5
SSRH24NHS-45041	4.5	4.1	0.041	65	0.7	22.5
SSRH24NHS-50026	5.0	2.6	0.027	65	0.75	22.5

- Rated voltage: 250VAC ● Withstanding voltage: 2400VAC (2sec. between lines)
- Insulation resistance: at 500VDC, more than 100MΩ (between lines) ● Thermal class: E (120°C)
- Operating temperature range (°C): -25 to T (T=120-temperature rise) ● Inductance measurement condition: 10kHz

Shape and Dimensions

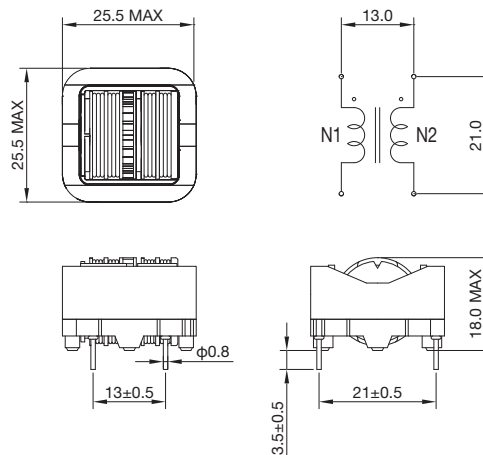

[mm]



- All specifications in this catalog and production status of products are subject to change without notice. Prior to the purchase, please contact TOKIN for updated product data.
- Please request for a specification sheet for detailed product data prior to the purchase.
- Before using the product in this catalog, please read "Precautions" and other safety precautions listed in the printed version catalog.

Impedance Characteristics

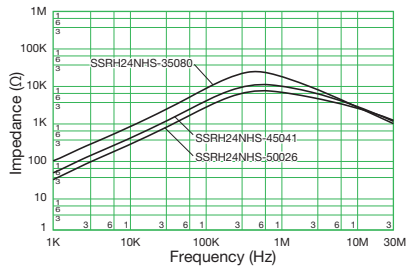
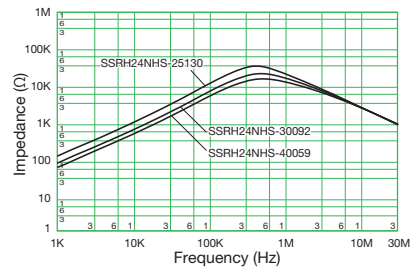
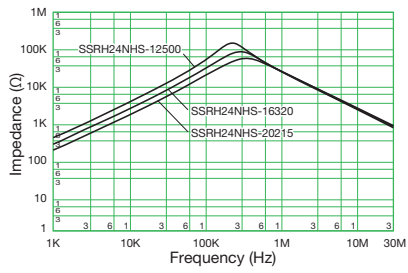

- All specifications in this catalog and production status of products are subject to change without notice. Prior to the purchase, please contact TOKIN for updated product data.
- Please request for a specification sheet for detailed product data prior to the purchase.
- Before using the product in this catalog, please read "Precautions" and other safety precautions listed in the printed version catalog.

SSR10V/H Series High Impedance Type

[RoHS Compliant]



Features

- Smallest standard common mode choke
- High degree of characterization realized by using high permeability S15H material
- Optimized design for compact size, low profile, and light weight
- High impedance and strong inductance characteristics realized by non-split bobbin design

Applications

- Audio-visual equipment
- Office automation equipment
- Digital appliances
- Power supply devices

Model	Rated current (A)	Inductance (mH) min.	DC resistance (Ω/line) max.	Temperature rise (K) max.	Wire size (mmø)	Weight approx. (g)
SSR10V-04910 SSR10H-04910	0.4	91	2.8	55	0.2	9
SSR10V-05595 SSR10H-05595	0.5	59.5	1.7	55	0.23	9
SSR10V-06475 SSR10H-06475	0.6	47.5	1.3	55	0.25	9
SSR10V-07330 SSR10H-07330	0.7	33	0.9	55	0.28	9
SSR10V-08220 SSR10H-08220	0.8	22	0.65	55	0.3	9
SSR10V-10170 SSR10H-10170	1	17	0.48	55	0.32	9
SSR10V-11140 SSR10H-11140	1.1	14	0.37	55	0.35	9
SSR10V-13097 SSR10H-13097	1.3	9.7	0.27	55	0.37	9
SSR10V-17058 SSR10H-17058	1.7	5.8	0.18	60	0.4	9
SSR10V-22034 SSR10H-22034	2.2	3.4	0.11	60	0.45	9
SSR10V-30016 SSR10H-30016	3	1.6	0.06	65	0.5	9

- Rated voltage: 250VAC ● Withstanding voltage: 2400VAC (2sec. between lines)
- Insulation resistance: at 500VDC, more than 100MΩ (between lines) ● Thermal class: E (120°C)
- Operating temperature range (°C): -25 to T (T=120-temperature rise) ● Inductance measurement condition: 10kHz

Shape and Dimensions

●SSR10V

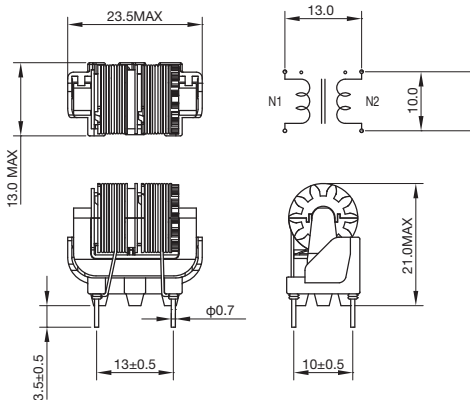

●SSR10H

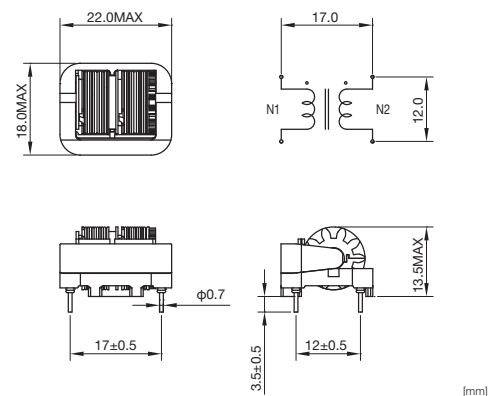

[mm]



- All specifications in this catalog and production status of products are subject to change without notice. Prior to the purchase, please contact TOKIN for updated product data.
- Please request for a specification sheet for detailed product data prior to the purchase.
- Before using the product in this catalog, please read "Precautions" and other safety precautions listed in the printed version catalog.

Impedance Characteristics

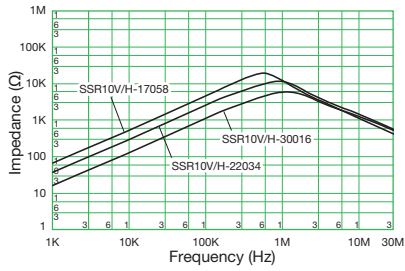
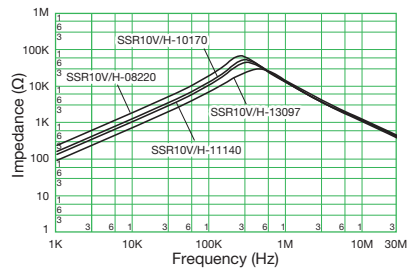
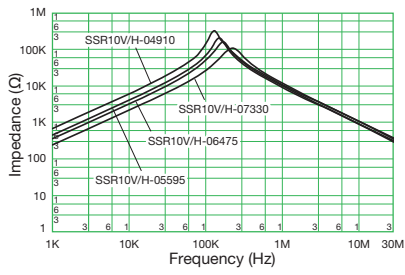

- All specifications in this catalog and production status of products are subject to change without notice. Prior to the purchase, please contact TOKIN for updated product data.
- Please request for a specification sheet for detailed product data prior to the purchase.
- Before using the product in this catalog, please read "Precautions" and other safety precautions listed in the printed version catalog.

SSR10VS/HS Series Wide Range Impedance Type

[RoHS Compliant]



Features

- Smallest standard common mode choke
- High degree of characterization realized by using high permeability S15H material
- Optimized design for compact size, low profile, and light weight
- High frequency characteristics and broad bandwidth realized by split bobbin design

Applications

- Audio-visual equipment
- Office automation equipment
- Digital appliances
- Power supply devices

Model	Rated current (A)	Inductance (mH) min.	DC resistance (Ω/line) max.	Temperature rise (K) max.	Wire size (mmφ)	Weight approx. (g)
SSR10VS-04745 SSR10HS-04745	0.4	74.5	2.5	50	0.2	9
SSR10VS-05495 SSR10HS-05495	0.5	49.5	1.6	50	0.23	9
SSR10VS-06385 SSR10HS-06385	0.6	38.5	1.2	50	0.25	9
SSR10VS-07265 SSR10HS-07265	0.7	26.5	0.85	50	0.28	9
SSR10VS-08180 SSR10HS-08180	0.8	18	0.6	50	0.3	9
SSR10VS-10135 SSR10HS-10135	1	13.5	0.43	50	0.32	9
SSR10VS-11110 SSR10HS-11110	1.1	11	0.33	50	0.35	9
SSR10VS-13075 SSR10HS-13075	1.3	7.5	0.24	50	0.37	9
SSR10VS-17048 SSR10HS-17048	1.7	4.8	0.17	55	0.4	9
SSR10VS-22026 SSR10HS-22026	2.2	2.6	0.1	55	0.45	9
SSR10VS-30013 SSR10HS-30013	3	1.3	0.06	60	0.5	9

- Rated voltage: 250VAC ● Withstanding voltage: 2400VAC (2sec. between lines)
- Insulation resistance: at 500VDC, more than 100MΩ (between lines) ● Thermal class: E (120°C)
- Operating temperature range (°C): -25 to T (T=120-temperature rise) ● Inductance measurement condition: 10kHz

Shape and Dimensions

●SSR10VS

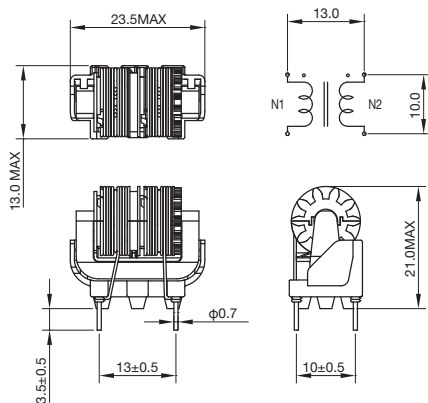

●SSR10HS

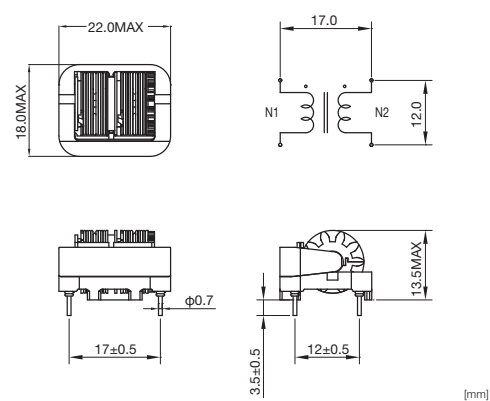

- All specifications in this catalog and production status of products are subject to change without notice. Prior to the purchase, please contact TOKIN for updated product data.
- Please request for a specification sheet for detailed product data prior to the purchase.
- Before using the product in this catalog, please read "Precautions" and other safety precautions listed in the printed version catalog.

Impedance Characteristics

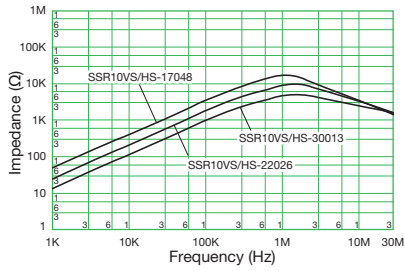
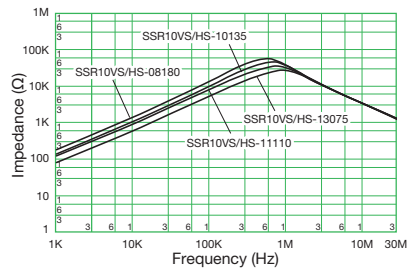
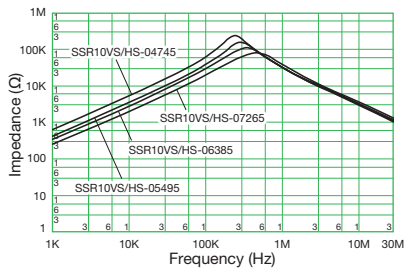

- All specifications in this catalog and production status of products are subject to change without notice. Prior to the purchase, please contact TOKIN for updated product data.
- Please request for a specification sheet for detailed product data prior to the purchase.
- Before using the product in this catalog, please read "Precautions" and other safety precautions listed in the printed version catalog.

SSR21NV/NH Series High Impedance Type

[RoHS Compliant]



Features

- Using high permeability S15H material, optimized core and structure
 - 1) Compact size and light weight (10% lighter compared with SSR21V/H series)
 - 2) High performance (Increased 15% L value compared with SSR21V/H series)
 - 3) Low DCR (10% lower Rdc compare with SSR21V/H series)
- High impedance and strong inductance characteristics realized by non-split bobbin design

Applications

- Audio-visual equipment
- Office automation equipment
- Digital appliances
- Power supply devices

Model	Rated current (A)	Inductance (mH) min.	DC resistance (Ω/line) max.	Temperature rise (K) max.	Wire size (mm)	Weight approx. (g)
SSR21NV-031810 SSR21NH-031810	0.3	181	2.85	45	0.2	14.5 13
SSR21NV-041290 SSR21NH-041290	0.4	129	1.85	45	0.23	14.5 13
SSR21NV-05795 SSR21NH-05795	0.5	79.5	1.2	45	0.25	14.5 13
SSR21NV-06500 SSR21NH-06500	0.6	50	0.76	45	0.28	14.5 13
SSR21NV-07405 SSR21NH-07405	0.7	40.5	0.61	45	0.3	14.5 13
SSR21NV-08325 SSR21NH-08325	0.8	32.5	0.47	45	0.32	14.5 13
SSR21NV-10250 SSR21NH-10250	1	25	0.36	45	0.35	14.5 13
SSR21NV-12175 SSR21NH-12175	1.2	17.5	0.27	45	0.37	14.5 13
SSR21NV-13140 SSR21NH-13140	1.3	14	0.21	45	0.4	14.5 13
SSR21NV-15097 SSR21NH-15097	1.5	9.7	0.14	45	0.45	14.5 13
SSR21NV-20064 SSR21NH-20064	2	6.4	0.09	45	0.5	14.5 13

- Rated voltage: 250VAC ● Withstanding voltage: 2400VAC (2sec. between lines)
- Insulation resistance: at 500VDC, more than 100MΩ (between lines) ● Thermal class: E (120°C)
- Operating temperature range (°C): -25 to T (T=120-temperature rise) ● Inductance measurement condition: 10kHz

Shape and Dimensions

● SSR21NV

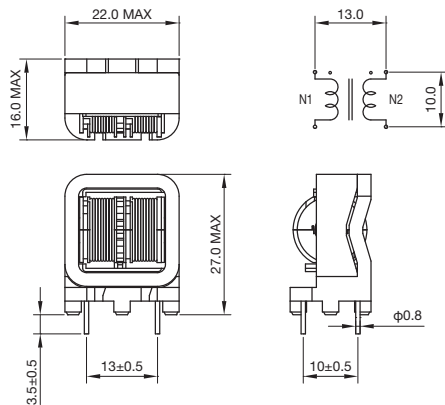

● SSR21NH

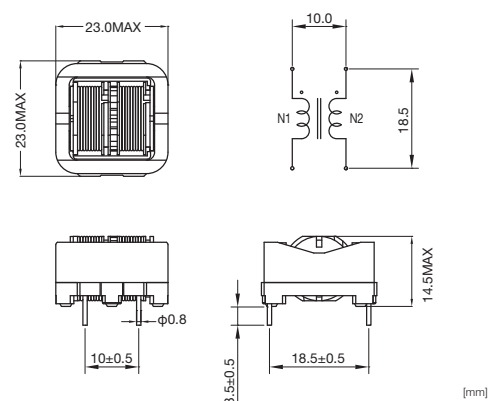

- All specifications in this catalog and production status of products are subject to change without notice. Prior to the purchase, please contact TOKIN for updated product data.
- Please request for a specification sheet for detailed product data prior to the purchase.
- Before using the product in this catalog, please read "Precautions" and other safety precautions listed in the printed version catalog.

Impedance Characteristics

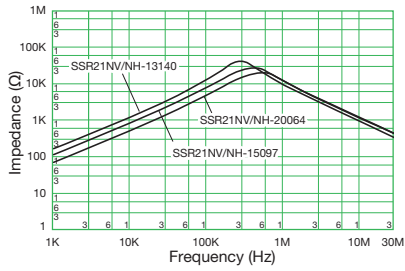
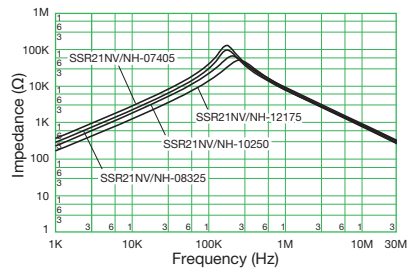
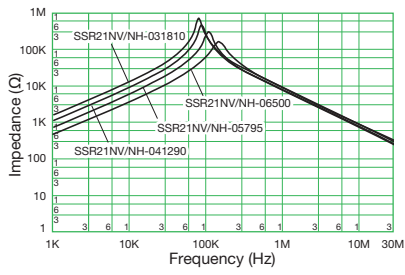

- All specifications in this catalog and production status of products are subject to change without notice. Prior to the purchase, please contact TOKIN for updated product data.
- Please request for a specification sheet for detailed product data prior to the purchase.
- Before using the product in this catalog, please read "Precautions" and other safety precautions listed in the printed version catalog.

SSR21NVS/NHS Series Wide Range Impedance Type

[RoHS Compliant]



Features

- Using high permeability S15H material, optimized core and structure
 - 1) Compact size and light weight (10% lighter compared with SSR21VS/HS series)
 - 2) High performance (Increased 15% L value compared with SSR21VS/HS series)
 - 3) Low DCR (10% lower Rdc compare with SSR21VS/HS series)
- High frequency characteristics and broad bandwidth realized by split bobbin design

Applications

- Audio-visual equipment
- Office automation equipment
- Digital appliances
- Power supply devices

Model	Rated current (A)	Inductance (mH) min.	DC resistance (Ω/line) max.	Temperature rise (K) max.	Wire size (mmφ)	Weight approx. (g)
SSR21NVS-031590 SSR21NHS-031590	0.3	159	2.85	45	0.2	14.5 13
SSR21NVS-041090 SSR21NHS-041090	0.4	109	1.8	45	0.23	14.5 13
SSR21NVS-05570 SSR21NHS-05570	0.5	57	1.06	45	0.25	14.5 13
SSR21NVS-06385 SSR21NHS-06385	0.6	38.5	0.71	45	0.28	14.5 13
SSR21NVS-07290 SSR21NHS-07290	0.7	29	0.53	45	0.3	14.5 13
SSR21NVS-08235 SSR21NHS-08235	0.8	23.5	0.42	45	0.32	14.5 13
SSR21NVS-10160 SSR21NHS-10160	1	16	0.29	45	0.35	14.5 13
SSR21NVS-12135 SSR21NHS-12135	1.2	13.5	0.24	45	0.37	14.5 13
SSR21NVS-13110 SSR21NHS-13110	1.3	11	0.19	45	0.4	14.5 13
SSR21NVS-15082 SSR21NHS-15082	1.5	8.2	0.13	45	0.45	14.5 13
SSR21NVS-20034 SSR21NHS-20034	2	3.4	0.07	45	0.5	14.5 13

- Rated voltage: 250VAC
- Withstanding voltage: 2400VAC (2sec. between lines)
- Insulation resistance: at 500VDC, more than 100MΩ (between lines)
- Thermal class: E (120°C)
- Operating temperature range (°C): -25 to T (T=120-temperature rise)
- Inductance measurement condition: 10kHz

Shape and Dimensions

●SSR21NVS

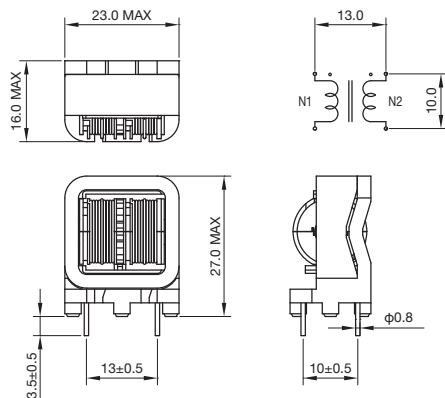

●SSR21NHS

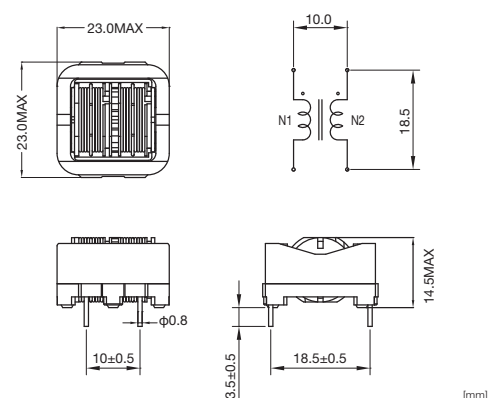

- All specifications in this catalog and production status of products are subject to change without notice. Prior to the purchase, please contact TOKIN for updated product data.
- Please request for a specification sheet for detailed product data prior to the purchase.
- Before using the product in this catalog, please read "Precautions" and other safety precautions listed in the printed version catalog.

Impedance Characteristics

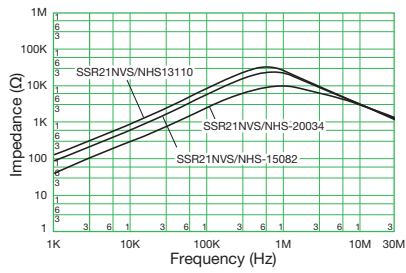
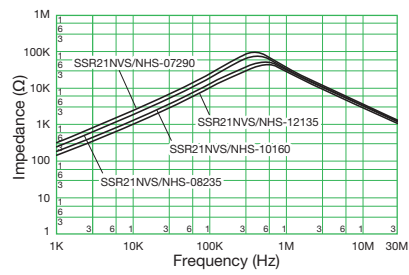
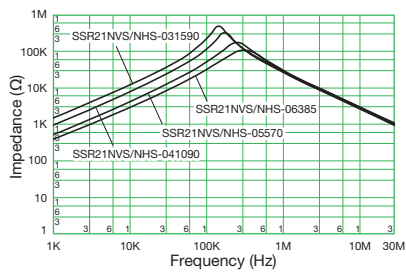

- All specifications in this catalog and production status of products are subject to change without notice. Prior to the purchase, please contact TOKIN for updated product data.
- Please request for a specification sheet for detailed product data prior to the purchase.
- Before using the product in this catalog, please read "Precautions" and other safety precautions listed in the printed version catalog.

SSR21NV-M/NH-M Series High Impedance Type

[RoHS Compliant]

NEW
PRODUCT



Features

- High performance type of SSR21NV/NH series
- High characteristics yet compact design enables to replace for SS26V type
- High impedance and strong inductance characteristics realized by non-split bobbin design

Applications

- Audio-visual equipment
- Office automation equipment
- Digital appliances
- Power supply devices

Model	Rated current (A)	Inductance (mH) min.	DC resistance (Ω/line) max.	Temperature rise (K) max.	Wire size (mmφ)	Weight approx. (g)
SSR21NV-M031900 SSR21NH-M031900	0.3	190	2.9	45	0.2	14.5 13
SSR21NV-M041500 SSR21NH-M041500	0.4	150	2	45	0.23	14.5 13
SSR21NV-M051350 SSR21NH-M051350	0.5	135	1.9	65	0.23	14.5 13
SSR21NV-M061200 SSR21NH-M061200	0.6	120	1.5	65	0.25	14.5 13
SSR21NV-M07890 SSR21NH-M07890	0.7	89	1.05	65	0.28	14.5 13
SSR21NV-M08680 SSR21NH-M08680	0.8	68	0.8	65	0.3	14.5 13
SSR21NV-M10475 SSR21NH-M10475	1	47.5	0.58	65	0.32	14.5 13
SSR21NV-M12345 SSR21NH-M12345	1.2	34.5	0.43	65	0.35	14.5 13
SSR21NV-M15220 SSR21NH-M15220	1.5	22	0.26	65	0.4	14.5 13
SSR21NV-M18164 SSR21NH-M18164	1.8	16.4	0.21	65	0.4	14.5 13
SSR21NV-M20125 SSR21NH-M20125	2	12.5	0.16	65	0.45	14.5 13
SSR21NV-M25103 SSR21NH-M25103	2.5	10.3	0.12	65	0.5	14.5 13
SSR21NV-M30064 SSR21NH-M30064	3	6.4	0.08	65	0.55	14.5 13

- Rated voltage: 250VAC
- Withstanding voltage: 2400VAC (2sec. between lines)
- Insulation resistance: at 500VDC, more than 100MΩ (between lines)
- Thermal class: E (120°C)
- Operating temperature range (°C): -25 to T (T=120-temperature rise)
- Inductance measurement condition: 10kHz

Shape and Dimensions

●SSR21NV-M

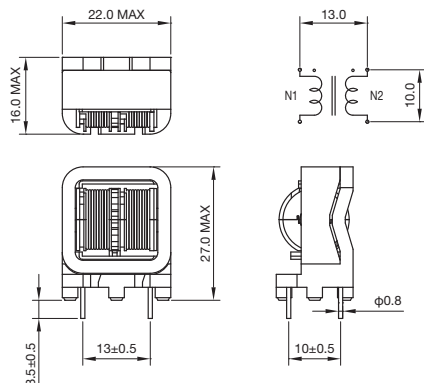

●SSR21NH-M

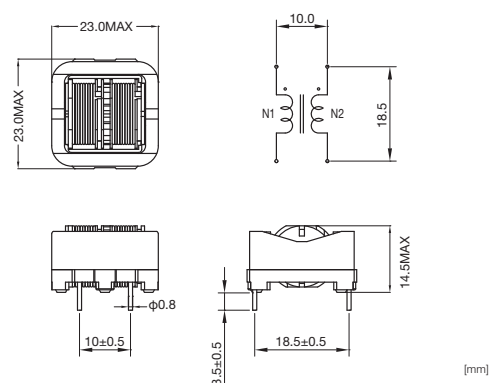

[mm]



- All specifications in this catalog and production status of products are subject to change without notice. Prior to the purchase, please contact TOKIN for updated product data.
- Please request for a specification sheet for detailed product data prior to the purchase.
- Before using the product in this catalog, please read "Precautions" and other safety precautions listed in the printed version catalog.

Impedance Characteristics

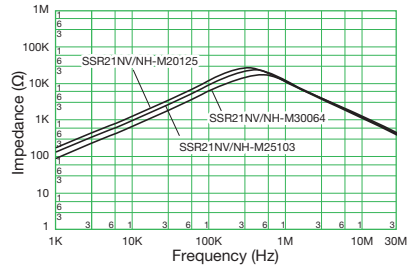
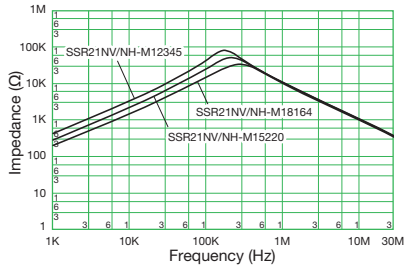
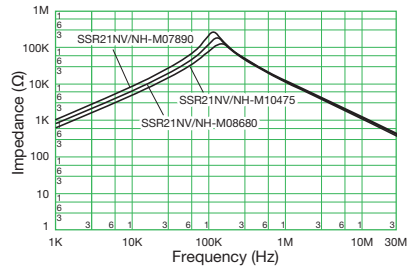
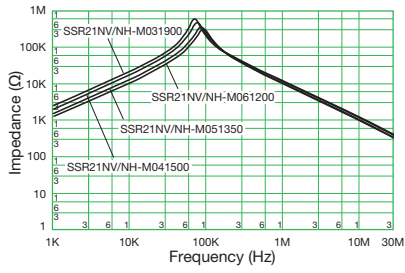

- All specifications in this catalog and production status of products are subject to change without notice. Prior to the purchase, please contact TOKIN for updated product data.
- Please request for a specification sheet for detailed product data prior to the purchase.
- Before using the product in this catalog, please read "Precautions" and other safety precautions listed in the printed version catalog.

SSR21NVS-M/NHS-M Series Wide Range Impedance Type

NEW
PRODUCT



[RoHS Compliant]

Features

- High performance type of SSR21NVS/NHS series
- High characteristics yet compact design enables to replace for SS26V type
- High frequency characteristics and broad bandwidth realized by split bobbin design

Applications

- Audio-visual equipment
- Office automation equipment
- Digital appliances
- Power supply devices

Model	Rated current (A)	Inductance (mH) min.	DC resistance (Ω/line) max.	Temperature rise (K) max.	Wire size (mmφ)	Weight approx. (g)
SSR21NVS-M031500 SSR21NHS-M031500	0.3	150	2.7	40	0.2	14.5 13
SSR21NVS-M041350 SSR21NHS-M041350	0.4	135	2	40	0.23	14.5 13
SSR21NVS-M051200 SSR21NHS-M051200	0.5	120	1.85	60	0.23	14.5 13
SSR21NVS-M06890 SSR21NHS-M06890	0.6	89	1.35	60	0.25	14.5 13
SSR21NVS-M07680 SSR21NHS-M07680	0.7	68	0.95	60	0.28	14.5 13
SSR21NVS-M08475 SSR21NHS-M08475	0.8	47.5	0.68	60	0.3	14.5 13
SSR21NVS-M10345 SSR21NHS-M10345	1	34.5	0.51	60	0.32	14.5 13
SSR21NVS-M12220 SSR21NHS-M12220	1.2	22	0.35	60	0.35	14.5 13
SSR21NVS-M15164 SSR21NHS-M15164	1.5	16.4	0.23	60	0.4	14.5 13
SSR21NVS-M18125 SSR21NHS-M18125	1.8	12.5	0.19	60	0.4	14.5 13
SSR21NVS-M20103 SSR21NHS-M20103	2	10.3	0.15	60	0.45	14.5 13
SSR21NVS-M25064 SSR21NHS-M25064	2.5	6.4	0.09	60	0.5	14.5 13
SSR21NVS-M30041 SSR21NHS-M30041	3	4.1	0.07	60	0.55	14.5 13

- Rated voltage: 250VAC
- Withstanding voltage: 2400VAC (2sec. between lines)
- Insulation resistance: at 500VDC, more than 100MΩ (between lines)
- Thermal class: E (120°C)
- Operating temperature range (°C): -25 to T (T=120-temperature rise)
- Inductance measurement condition: 10kHz

Shape and Dimensions

●SSR21NVS-M

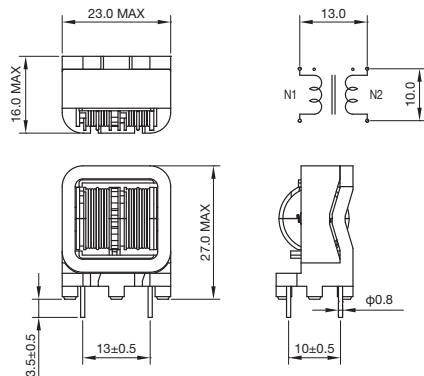

●SSR21NHS-M

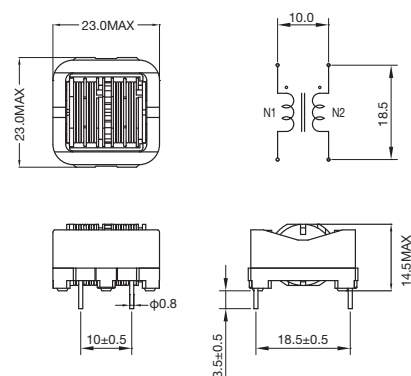

[mm]



- All specifications in this catalog and production status of products are subject to change without notice. Prior to the purchase, please contact TOKIN for updated product data.
- Please request for a specification sheet for detailed product data prior to the purchase.
- Before using the product in this catalog, please read "Precautions" and other safety precautions listed in the printed version catalog.

Impedance Characteristics

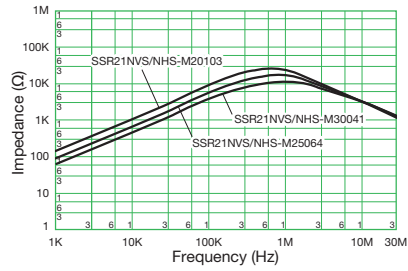
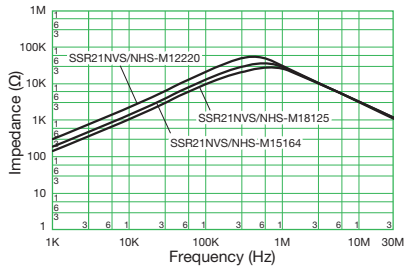
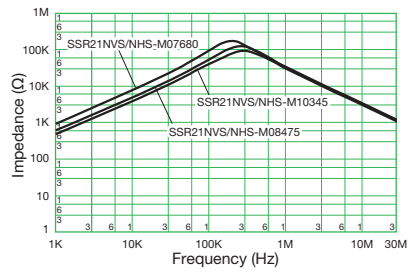
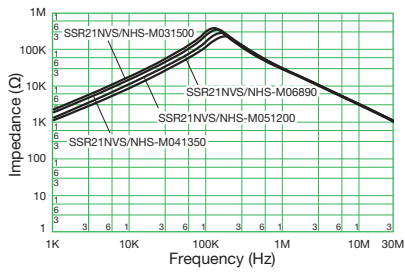

- All specifications in this catalog and production status of products are subject to change without notice. Prior to the purchase, please contact TOKIN for updated product data.
- Please request for a specification sheet for detailed product data prior to the purchase.
- Before using the product in this catalog, please read "Precautions" and other safety precautions listed in the printed version catalog.

Normal Choke Coil HHBC Series (Fe-Si)

[RoHS Compliant]



Features

- Available for a general use
(Core loss and DC superposition characteristics balance is good)

Applications

- Choke coils for switching power supply outlet
- Choke coils for DC-DC converter
- Choke coils for phase compensation
- Re-pressuring choke coils for active filter
- Choke coils for noise solution

Model	Rated current (A)	Inductance (μH)		DC resistance (mΩ/line) max.	Temperature rise (K) max.	Dimensions (mm)				Wire size (mmφ)	Weight approx. (g)
		0A ±20%	Rated current ±25%			D max.	W max.	H max.	P typ.		
HHBC8S-0R6A0024V	2	24	22.9	41.1	15	16.0	8.8	16.0	7.0	0.6	4
HHBC8S-0R6A0043V	2	43	41.1	54.1	20	17.0	9.1	17.0	7.0	0.6	4
HHBC8S-0R6A0067V	2	67	62.6	67.8	25	17.0	9.6	17.0	7.5	0.6	4
HHBC10-0R8A0038V	3	38	37.0	31.2	15	21.5	11.7	21.5	8.0	0.8	9
HHBC10-0R8A0068V	3	68	64.5	42.3	20	21.5	12.3	21.5	8.0	0.8	10
HHBC10-0R8A0107V	3	107	98.5	53.0	25	22.0	12.1	22.0	9.0	0.8	11
HHBC12-1R0A0028V	5	28	26.5	21.1	25	26.0	12.1	26.0	9.0	1.0	13
HHBC12-1R0A0051V	5	51	47.2	28.0	25	26.0	12.4	26.0	9.0	1.0	14
HHBC12-1R0A0080V	5	80	69.7	35.6	40	26.4	13.3	26.4	9.5	1.0	16
HHBC13-1R2A0045V	6	45	42.7	18.3	25	30.0	14.9	30.0	11.0	1.2	23
HHBC13-1R2A0081V	6	81	73.2	24.7	30	30.0	15.7	30.0	11.0	1.2	26
HHBC13-1R2A0127V	6	127	112.6	31.7	35	30.0	16.2	30.0	12.0	1.2	30
HHBC14-1R2A0067V	8	67	63.0	22.2	40	33.5	17.1	33.5	14.0	1.2	37
HHBC14-1R2A0120V	8	120	107.6	29.9	50	34.0	18.6	34.0	15.0	1.2	41
HHBC14-1R2A0187V	8	187	159.7	37.6	60	34.0	19.4	34.0	15.0	1.2	45
HHBC20-1R7A0054V	12	54	49.2	11.5	35	41.2	19.5	41.2	14.0	1.7	56
HHBC20-1R7A0097V	12	97	81.9	16.0	45	41.2	20.3	41.2	14.0	1.7	65
HHBC20-1R7A0152V	12	152	117.0	20.4	60	41.2	20.4	41.2	15.0	1.7	72
HHBC24N-2R0A0219V	15	219	173.0	19.5	65	50.5	26.5	50.5	19.0	2.0	149
HHBC24W-2R1A0311V	15	311	247.7	20.1	55	57.6	30.5	57.6	24.0	2.1	248
HHBC24N-2R3A0104V	20	104	85.7	10.4	55	49.5	25.8	49.5	22.0	2.3	143
HHBC24W-2R4A0174V	20	174	140.4	11.8	50	57.6	30.9	57.6	24.0	2.4	245
HHBC24N-2R1B0039V	30	39	33.1	6.8	50	50.1	25.7	50.1	20.0	2.1(2)	147
HHBC24W-2R1B0065V	30	65	53.9	6.2	50	57.6	31.2	57.6	23.0	2.1(2)	241

* As to customized products other than mentioned above (for car application, etc.), Please feel free contact us.
 ● Operating temperature range (°C): -40 to +125 (include self temperature rise) ● Wire type: 1UEW or 1PEW
 ● Inductance measurement condition: 100kHz, 1mA, KC547
 ● Values of dimension P listed above are for reference only. The actual dimension may differ.
 ● The temperature rise during mounting is affected by the mounted coil and the harmonic components of the electric current.
 ● When selecting a product, please make sure that the coil temperature will not exceed the listed operating temperature range under planned operating conditions.

Shape and Dimensions



- All specifications in this catalog and production status of products are subject to change without notice. Prior to the purchase, please contact TOKIN for updated product data.
- Please request for a specification sheet for detailed product data prior to the purchase.
- Before using the product in this catalog, please read "Precautions" and other safety precautions listed in the printed version catalog.

Numbering System

HHBC 8S - 0R6 A 0024 V
 ① ② ③ ④ ⑤ ⑥

- ① Core material
- ② Core size
- ③ Wire diameter (ø0.6: 0R6)
- ④ The number of wire (1: A, 2: B, 3: C)
- ⑤ Inductance (24μH: 0024)
- ⑥ Shape (Vertical: V, Horizontal: H)

DC-Superposed Characteristics

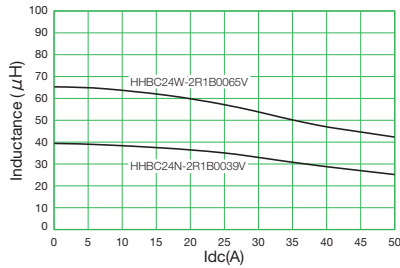
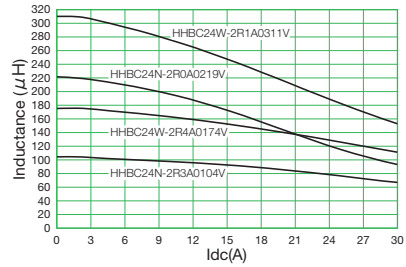
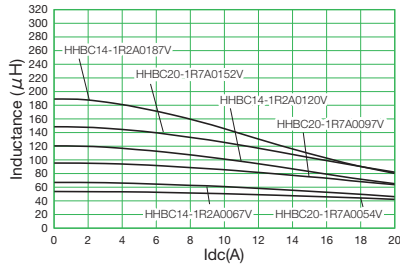
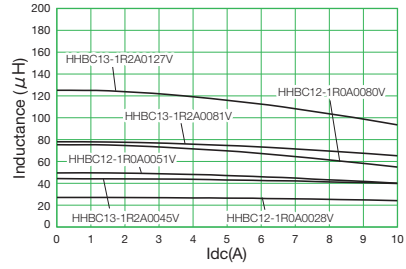
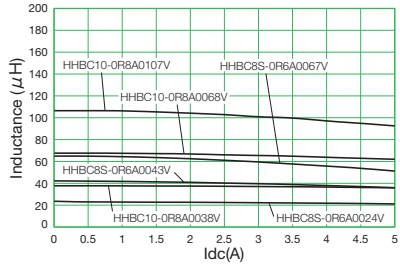

- All specifications in this catalog and production status of products are subject to change without notice. Prior to the purchase, please contact TOKIN for updated product data.
- Please request for a specification sheet for detailed product data prior to the purchase.
- Before using the product in this catalog, please read "Precautions" and other safety precautions listed in the printed version catalog.

Inductance Characteristics

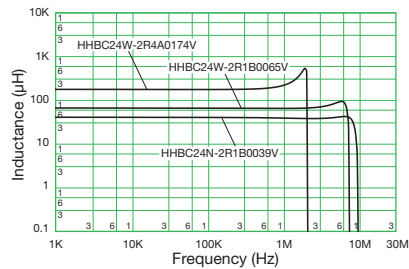
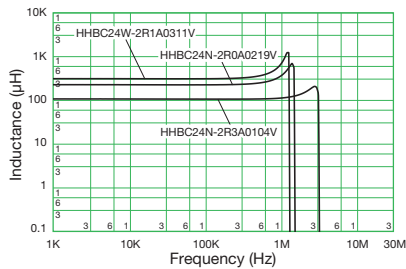
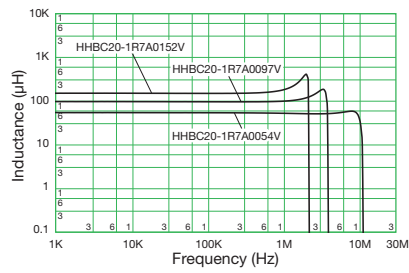
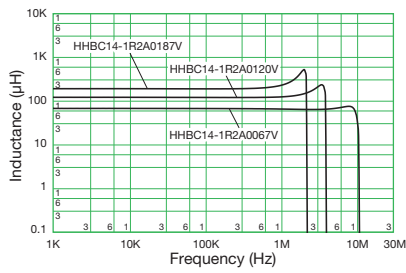
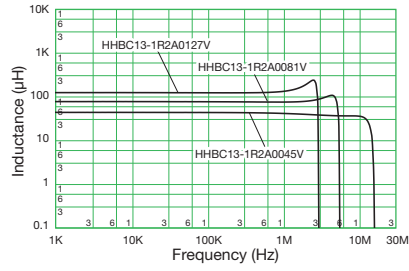
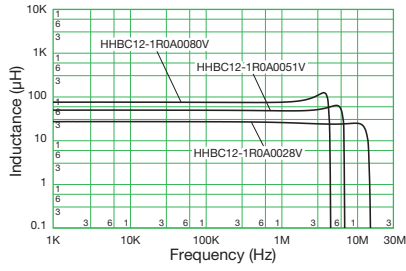
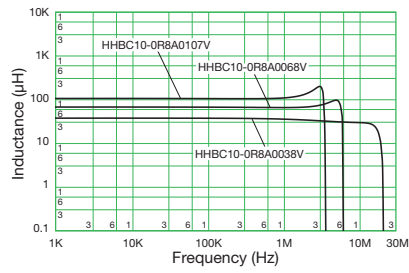
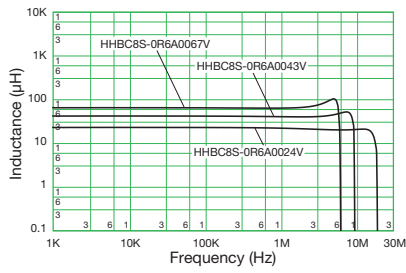

- All specifications in this catalog and production status of products are subject to change without notice. Prior to the purchase, please contact TOKIN for updated product data.
- Please request for a specification sheet for detailed product data prior to the purchase.
- Before using the product in this catalog, please read "Precautions" and other safety precautions listed in the printed version catalog.

Impedance Characteristics

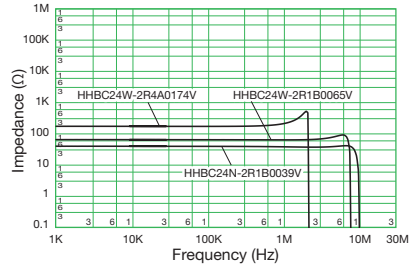
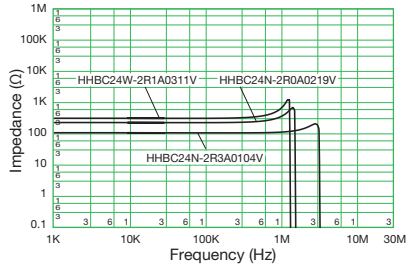
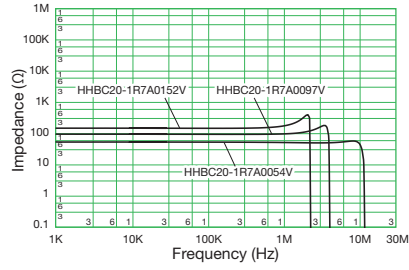
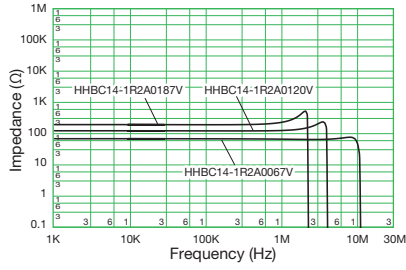
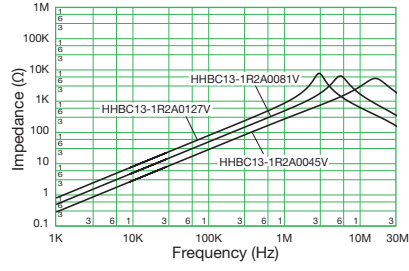
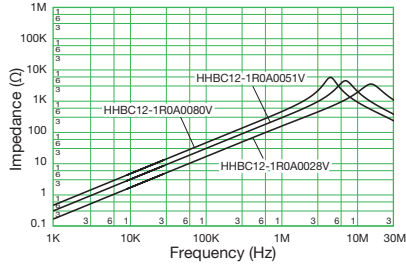
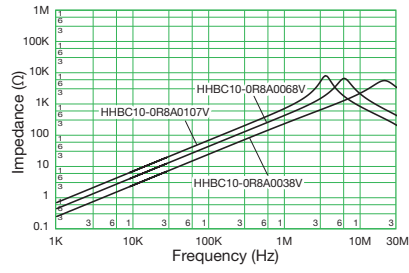
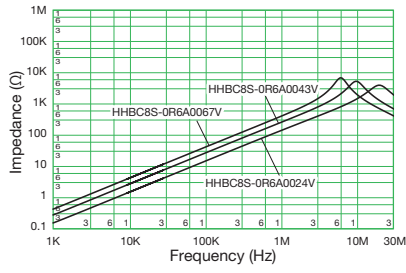

- All specifications in this catalog and production status of products are subject to change without notice. Prior to the purchase, please contact TOKIN for updated product data.
- Please request for a specification sheet for detailed product data prior to the purchase.
- Before using the product in this catalog, please read "Precautions" and other safety precautions listed in the printed version catalog.

Normal Choke Coil SHBC Series (Fe-Si-Al)

[RoHS Compliant]



Features

- Low core loss, high frequency drive (for smoothing, re-pressuring)

Applications

- Choke coils for switching power supply outlet
- Choke coils for DC-DC converter
- Choke coils for phase compensation
- Re-pressuring choke coils for active filter

Model	Rated current (A)	Inductance (μH)		DC resistance (mΩ/line) max.	Temperature rise (K) max.	Dimensions (mm)				Wire size (mmφ)	Weight approx. (g)
		0A ±20%	Rated current ±25%			D max.	W max.	H max.	P typ.		
SHBC8S-0R6A0024V	2	24	22.1	41.1	15	16.0	8.8	16.0	7.0	0.6	4
SHBC8S-0R6A0043V	2	43	36.9	54.1	20	17.0	9.1	17.0	7.0	0.6	4
SHBC8S-0R6A0067V	2	67	55.0	67.8	25	17.0	9.6	17.0	7.5	0.6	4
SHBC10-0R8A0038V	3	38	32.5	31.2	15	21.5	11.7	21.5	8.0	0.8	9
SHBC10-0R8A0068V	3	68	58.4	42.3	20	21.5	12.3	21.5	8.0	0.8	10
SHBC10-0R8A0107V	3	107	85.2	53.0	25	22.0	12.1	22.0	9.0	0.8	11
SHBC12-1R0A0028V	5	28	24.9	21.1	25	26.0	12.1	26.0	9.0	1.0	13
SHBC12-1R0A0051V	5	51	40.7	28.0	25	26.0	12.4	26.0	9.0	1.0	14
SHBC12-1R0A0080V	5	80	58.5	35.6	40	26.4	13.3	26.4	9.5	1.0	16
SHBC13-1R2A0045V	6	45	37.3	18.3	25	30.0	14.9	30.0	11.0	1.2	23
SHBC13-1R2A0081V	6	81	60.5	24.7	30	30.0	15.7	30.0	11.0	1.2	26
SHBC13-1R2A0127V	6	127	84.8	31.7	35	30.0	16.2	30.0	12.0	1.2	30
SHBC14-1R2A0067V	8	67	53.3	22.2	40	33.5	17.1	33.5	14.0	1.2	37
SHBC14-1R2A0120V	8	120	84.3	29.9	50	34.0	18.6	34.0	15.0	1.2	41
SHBC14-1R2A0187V	8	187	113.5	37.6	60	34.0	19.4	34.0	15.0	1.2	45
SHBC20-1R7A0054V	12	54	40.4	11.5	35	41.2	19.5	41.2	14.0	1.7	56
SHBC20-1R7A0097V	12	97	61.5	16.0	45	41.2	20.3	41.2	14.0	1.7	65
SHBC20-1R7A0152V	12	152	80.0	20.4	60	41.2	20.4	41.2	15.0	1.7	72
SHBC24N-2R0A0219V	15	219	102.6	19.5	65	50.5	26.5	50.5	19.0	2.0	137
SHBC24W-2R1A0311V	15	311	182.5	20.1	55	57.6	30.5	57.6	24.0	2.1	224
SHBC24N-2R3A0104V	20	104	53.4	10.4	55	49.5	25.8	49.5	22.0	2.3	133
SHBC24W-2R4A0174V	20	174	102.7	11.8	50	57.6	30.9	57.6	24.0	2.4	222
SHBC24N-2R1B0039V	30	39	21.2	6.8	50	50.1	25.7	50.1	20.0	2.1(2)	135
SHBC24W-2R1B0065V	30	65	40.7	6.2	50	57.6	31.2	57.6	23.0	2.1(2)	217

* As to customized products other than the mentioned above (for car application, etc.), Please feel free contact us.
 ● Operating temperature range (°C): -40 to +125 (include self temperature rise) ● Wire type: 1UEW or 1PEW
 ● Inductance measurement condition: 100kHz, 1mA, KC547
 ● Values of dimension P listed above are for reference only. The actual dimension may differ.
 ● The temperature rise during mounting is affected by the mounted coil and the harmonic components of the electric current.
 ● When selecting a product, please make sure that the coil temperature will not exceed the listed operating temperature range under planned operating conditions.

Shape and Dimensions

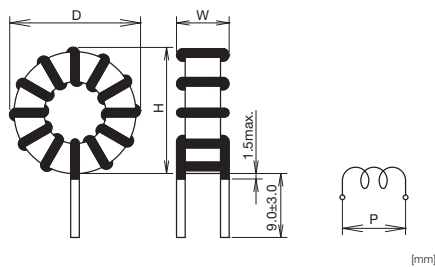

- All specifications in this catalog and production status of products are subject to change without notice. Prior to the purchase, please contact TOKIN for updated product data.
- Please request for a specification sheet for detailed product data prior to the purchase.
- Before using the product in this catalog, please read "Precautions" and other safety precautions listed in the printed version catalog.

Numbering System

SHBC 8S - 0R6 A 0024 V

① ② ③ ④ ⑤ ⑥

- ① Core material
- ② Core size
- ③ Wire diameter (ø0.6: 0R6)
- ④ The number of wire (1: A, 2: B, 3: C)
- ⑤ Inductance (24μH: 0024)
- ⑥ Shape (Vertical: V, Horizontal: H)

DC-Superposed Characteristics

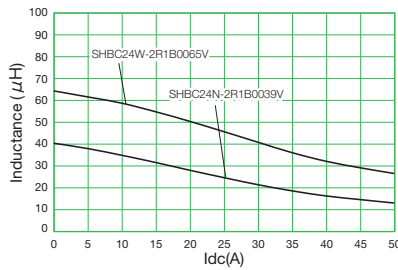
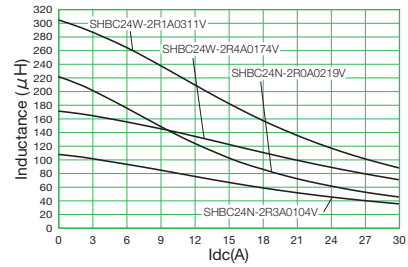
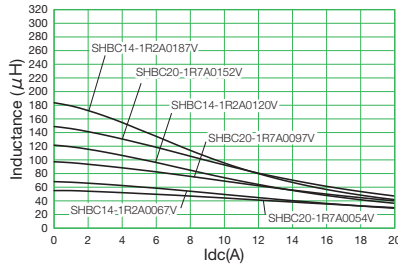
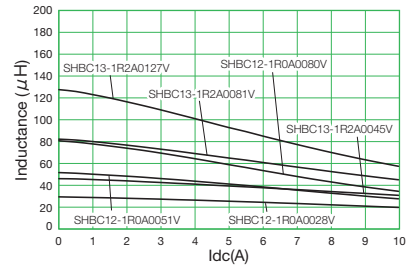
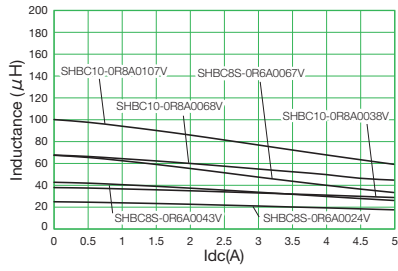

- All specifications in this catalog and production status of products are subject to change without notice. Prior to the purchase, please contact TOKIN for updated product data.
- Please request for a specification sheet for detailed product data prior to the purchase.
- Before using the product in this catalog, please read "Precautions" and other safety precautions listed in the printed version catalog.

Inductance Characteristics

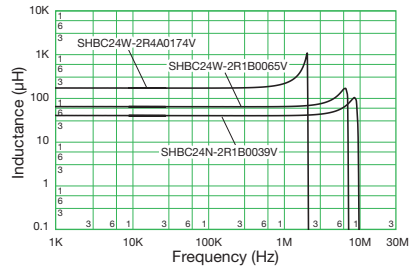
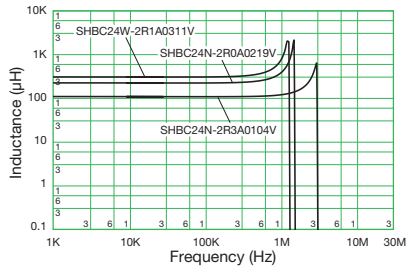
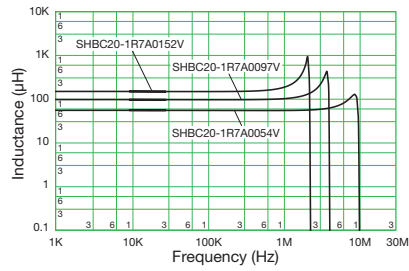
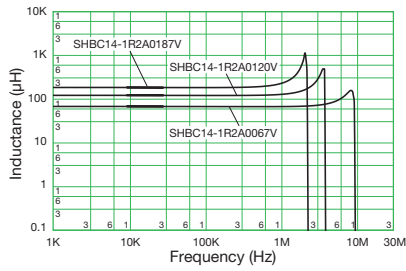
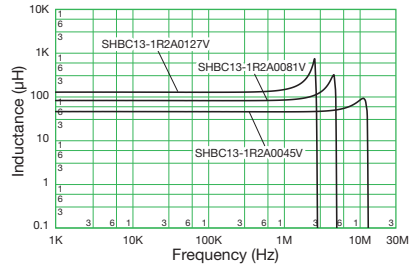
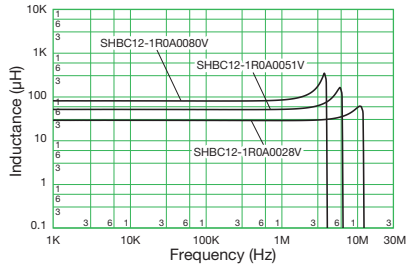
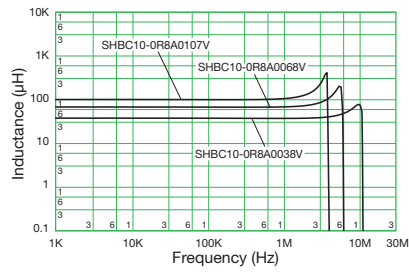
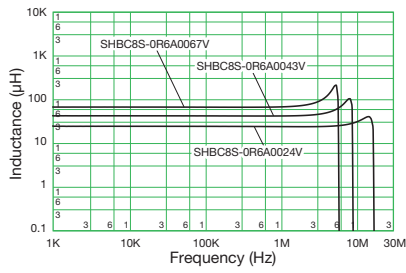

- All specifications in this catalog and production status of products are subject to change without notice. Prior to the purchase, please contact TOKIN for updated product data.
- Please request for a specification sheet for detailed product data prior to the purchase.
- Before using the product in this catalog, please read "Precautions" and other safety precautions listed in the printed version catalog.

Impedance Characteristics

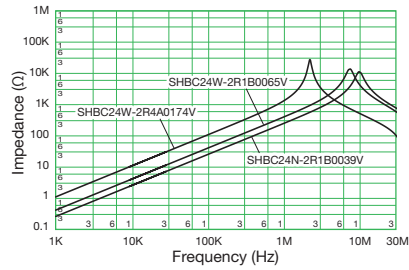
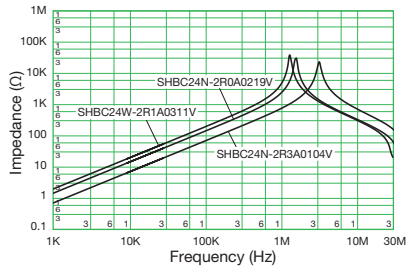
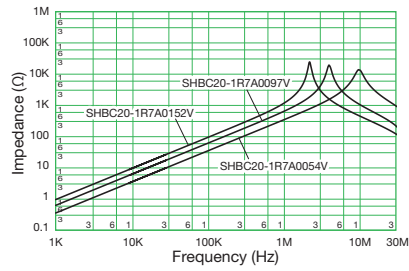
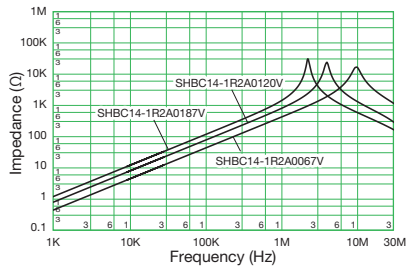
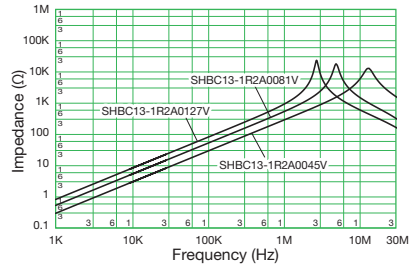
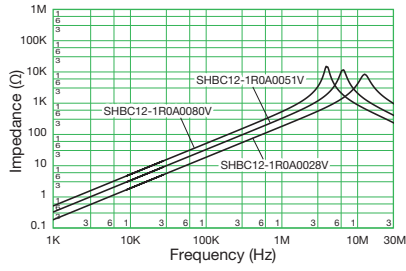
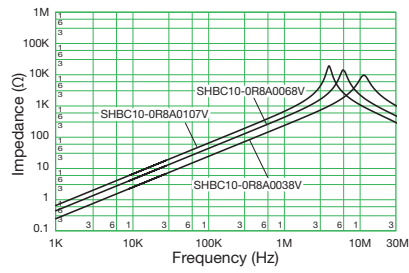
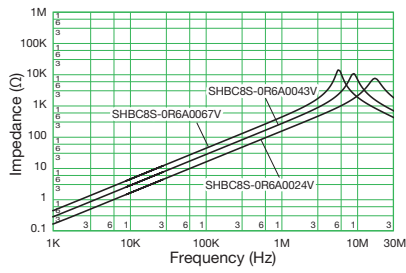

- All specifications in this catalog and production status of products are subject to change without notice. Prior to the purchase, please contact TOKIN for updated product data.
- Please request for a specification sheet for detailed product data prior to the purchase.
- Before using the product in this catalog, please read "Precautions" and other safety precautions listed in the printed version catalog.

Normal Choke Coil PHBC Series (Fe-Ni)

[RoHS Compliant]



Features

- Low core loss, high saturation magnetic flux density, good DC superposition characteristics
- The most suitable for big current applications

Applications

- Choke coils for switching power supply outlet
- Choke coils for DC-DC converter
- Choke coils for phase compensation
- Re-pressuring choke coils for active filter
- Choke coils for noise solution

Model	Rated current (A)	Inductance (μH)		DC resistance (mΩ/line) max.	Temperature rise (K) max.	Dimensions (mm)				Wire size (mmφ)	Weight approx. (g)
		0A ±20%	Rated current ±25%			D max.	W max.	H max.	P typ.		
PHBC8S-0R6A0024V	2	24	23.5	41.1	15	16.0	8.8	16.0	7.0	0.6	4
PHBC8S-0R6A0043V	2	43	41.8	54.1	20	17.0	9.1	17.0	7.0	0.6	5
PHBC8S-0R6A0067V	2	67	65.7	67.8	25	17.0	9.6	17.0	7.5	0.6	5
PHBC10-0R8A0038V	3	38	37.3	31.2	15	21.5	11.7	21.5	8.0	0.8	11
PHBC10-0R8A0068V	3	68	65.6	42.3	20	21.5	12.3	21.5	8.0	0.8	12
PHBC10-0R8A0107V	3	107	101.1	53.0	25	22.0	12.1	22.0	9.0	0.8	13
PHBC12-1R0A0028V	5	28	27.6	21.1	25	26.0	12.1	26.0	9.0	1.0	14
PHBC12-1R0A0051V	5	51	47.9	28.0	25	26.0	12.4	26.0	9.0	1.0	16
PHBC12-1R0A0080V	5	80	72.2	35.6	40	26.4	13.3	26.4	9.5	1.0	18
PHBC13-1R2A0045V	6	45	44.9	18.3	25	30.0	14.9	30.0	11.0	1.2	27
PHBC13-1R2A0081V	6	81	77.3	24.7	30	30.0	15.7	30.0	11.0	1.2	30
PHBC13-1R2A0127V	6	127	116.4	31.7	35	30.0	16.2	30.0	12.0	1.2	33
PHBC14-1R2A0067V	8	67	64.3	22.2	40	33.5	17.1	33.5	14.0	1.2	43
PHBC14-1R2A0120V	8	120	111.1	29.9	50	34.0	18.6	34.0	15.0	1.2	47
PHBC14-1R2A0187V	8	187	165.4	37.6	60	34.0	19.4	34.0	15.0	1.2	52
PHBC20-1R7A0054V	12	54	53.2	11.5	35	41.2	19.5	41.2	14.0	1.7	66
PHBC20-1R7A0097V	12	97	90.3	16.0	45	41.2	20.3	41.2	14.0	1.7	75
PHBC20-1R7A0152V	12	152	132.5	20.4	60	41.2	20.4	41.2	15.0	1.7	83
PHBC24N-2R0A0219V	15	219	172.4	19.5	65	50.5	26.5	50.5	19.0	2.0	149
PHBC24W-2R1A0311V	15	311	260.1	20.1	55	57.6	30.5	57.6	24.0	2.1	248
PHBC24N-2R3A0104V	20	104	85.6	10.4	55	49.5	25.8	49.5	22.0	2.3	143
PHBC24W-2R4A0174V	20	174	147.4	11.8	50	57.6	30.9	57.6	24.0	2.4	245
PHBC24N-2R1B0039V	30	39	32.4	6.8	50	50.1	25.7	50.1	20.0	2.1(2)	147
PHBC24W-2R1B0065V	30	65	56.4	6.2	50	57.6	31.2	57.6	23.0	2.1(2)	241

* As to customized products other than the mentioned above (for car application, etc.), Please feel free contact us.
 ● Operating temperature range (°C): -40 to +125 (include self temperature rise) ● Wire type: 1UEW or 1PEW
 ● Inductance measurement condition: 100kHz, 1mA, KC547
 ● Values of dimension P listed above are for reference only. The actual dimension may differ.
 ● The temperature rise during mounting is affected by the mounted coil and the harmonic components of the electric current.
 ● When selecting a product, please make sure that the coil temperature will not exceed the listed operating temperature range under planned operating conditions.

Shape and Dimensions



- All specifications in this catalog and production status of products are subject to change without notice. Prior to the purchase, please contact TOKIN for updated product data.
- Please request for a specification sheet for detailed product data prior to the purchase.
- Before using the product in this catalog, please read "Precautions" and other safety precautions listed in the printed version catalog.

Numbering System

PHBC 8S - 0R6 A 0024 V

① ② ③ ④ ⑤ ⑥

- ① Core material
- ② Core size
- ③ Wire diameter (ø0.6: 0R6)
- ④ The number of wire (1: A, 2: B, 3: C)
- ⑤ Inductance (24μH: 0024)
- ⑥ Shape (Vertical: V, Horizontal: H)

DC-Superposed Characteristics

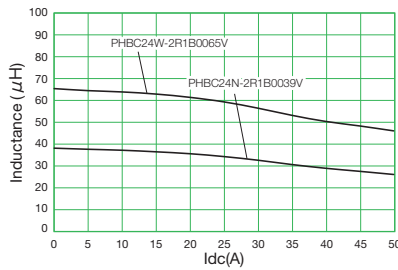
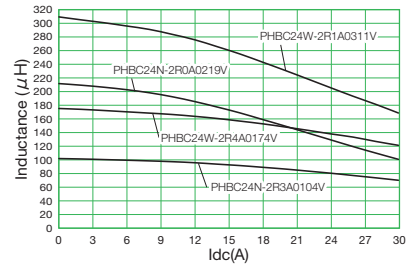
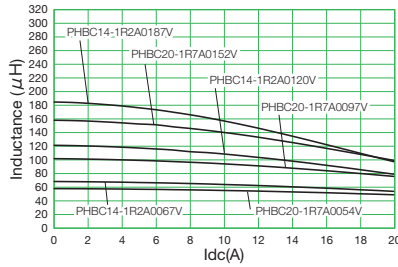
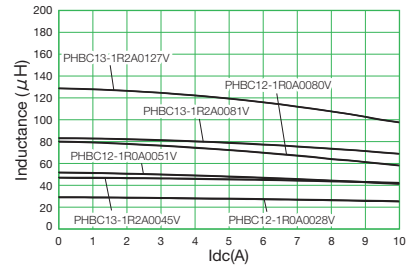
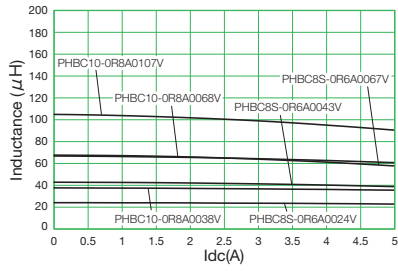

- All specifications in this catalog and production status of products are subject to change without notice. Prior to the purchase, please contact TOKIN for updated product data.
- Please request for a specification sheet for detailed product data prior to the purchase.
- Before using the product in this catalog, please read "Precautions" and other safety precautions listed in the printed version catalog.

Inductance Characteristics

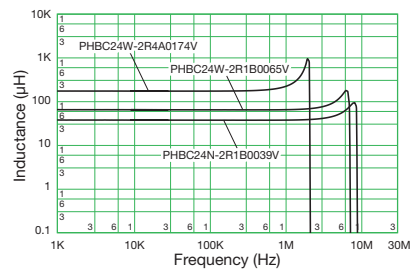
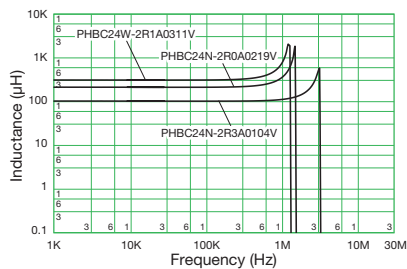
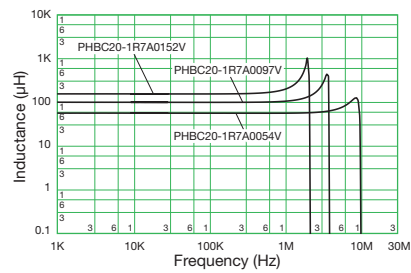
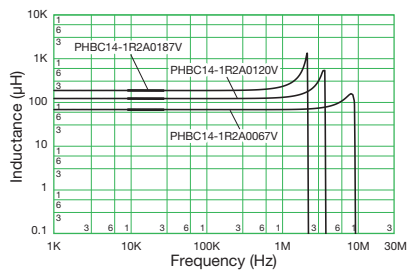
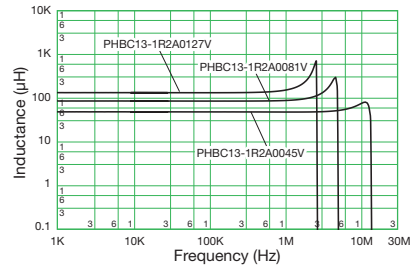
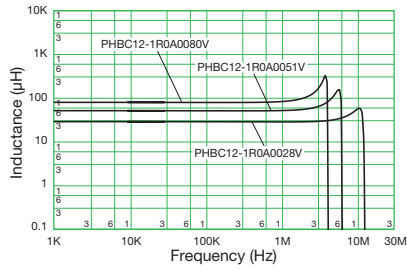
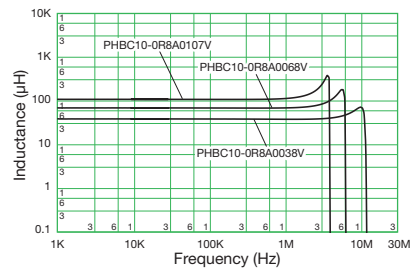
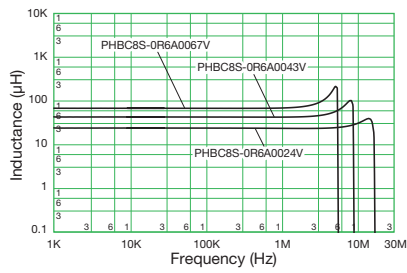

- All specifications in this catalog and production status of products are subject to change without notice. Prior to the purchase, please contact TOKIN for updated product data.
- Please request for a specification sheet for detailed product data prior to the purchase.
- Before using the product in this catalog, please read "Precautions" and other safety precautions listed in the printed version catalog.

Impedance Characteristics

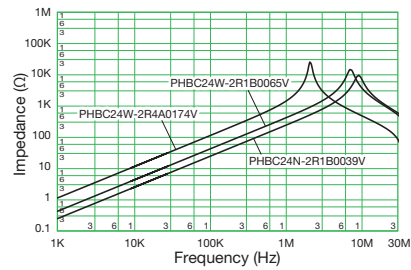
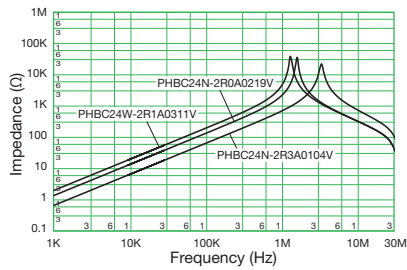
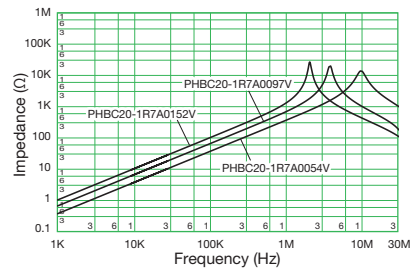
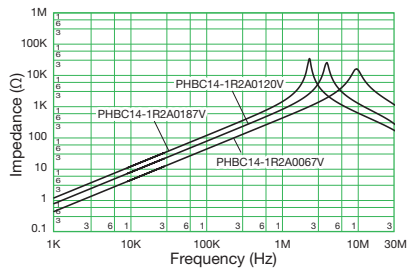
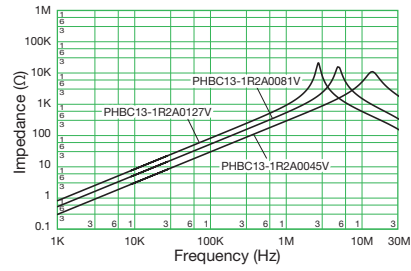
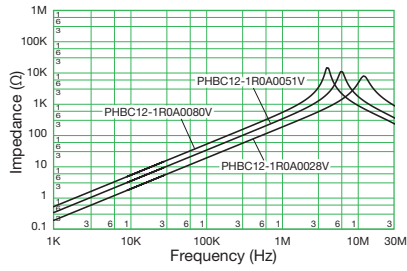
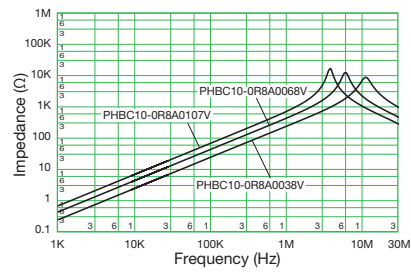
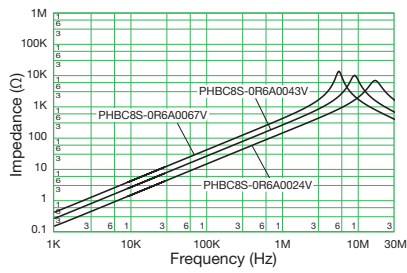

- All specifications in this catalog and production status of products are subject to change without notice. Prior to the purchase, please contact TOKIN for updated product data.
- Please request for a specification sheet for detailed product data prior to the purchase.
- Before using the product in this catalog, please read "Precautions" and other safety precautions listed in the printed version catalog.

SNG Series Earth Inductors

[RoHS Compliant]



Model	Rated voltage (V AC/DC)	Withstanding voltage (V AC)*	Insulation resistance (MΩ)**	Inductance (μH) +50% (160kHz) -30%	DC resistance max. (mΩ)	Operating temperature range(°C)	Recognized by:	Weight approx. (g)
SNG-19A-080	250	2500	≥20	80	10	-25~+60	TÜV	19
SNG-19B-080	250	2500	≥20	80	10	-25~+60	TÜV	19
SNG-25A-600	250	2500	≥20	600	20	-25~+60	TÜV	38
SNG-25B-600	250	2500	≥20	600	20	-25~+60	TÜV	38
SNG-19DA-014	250	2500	≥20	14	10	-25~+60	—	20
SNG-19DB-014	250	2500	≥20	14	10	-25~+60	—	20
SNG-25DA-086	250	2500	≥20	86	20	-25~+60	—	38
SNG-25DB-086	250	2500	≥20	86	20	-25~+60	—	38

* For one minute between insulating cap and terminal AC
 ** For one minute at 500VDC between insulating cap and terminal
 • Thermal class: A (105°C)

Shape and Dimensions

●SNG-19A-080, SNG-19DA-014

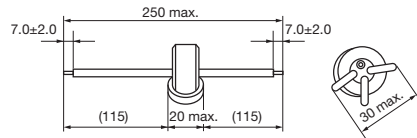

●SNG-25A-600, SNG-25DA-086

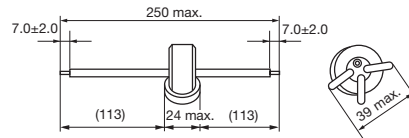

●SNG-19B-080, SNG-19DB-014

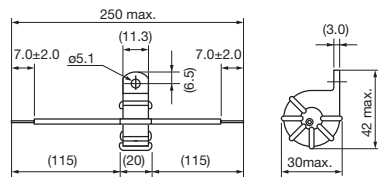

●SNG-25B-600, SNG-25DB-086

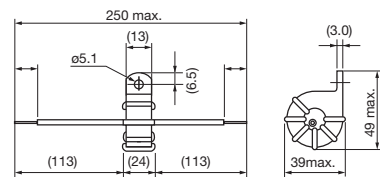

Wiring: AWG 16 UL 1015

[mm]

Applications

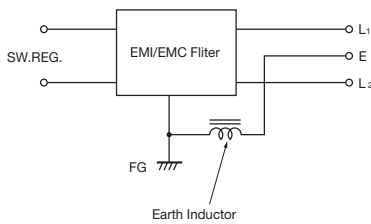

- All specifications in this catalog and production status of products are subject to change without notice. Prior to the purchase, please contact TOKIN for updated product data.
- Please request for a specification sheet for detailed product data prior to the purchase.
- Before using the product in this catalog, please read "Precautions" and other safety precautions listed in the printed version catalog.

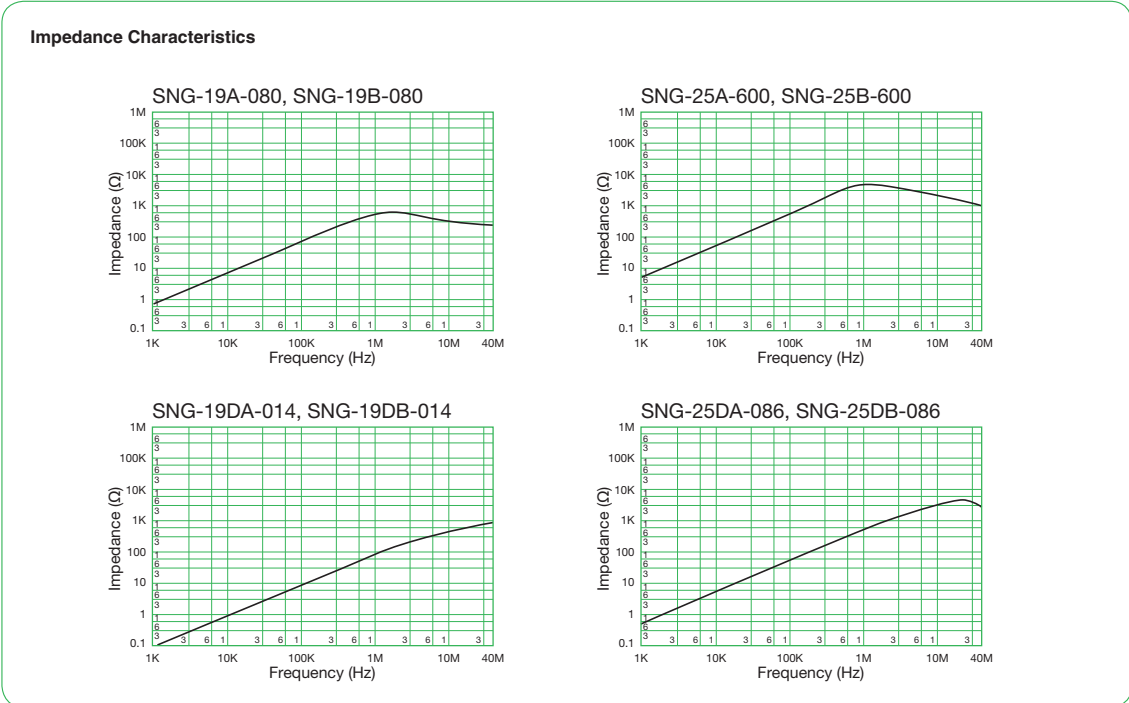
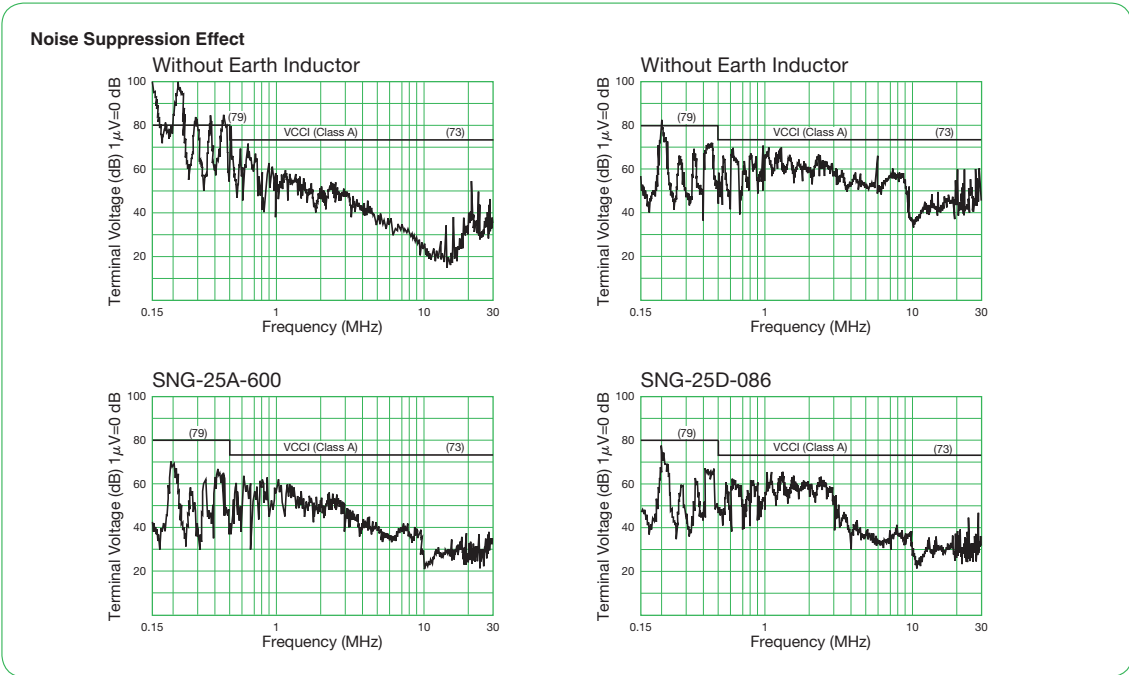

- All specifications in this catalog and production status of products are subject to change without notice. Prior to the purchase, please contact TOKIN for updated product data.
- Please request for a specification sheet for detailed product data prior to the purchase.
- Before using the product in this catalog, please read "Precautions" and other safety precautions listed in the printed version catalog.

SC Coils – Standard Type

[RoHS Compliant]



Model	Rated current (A)	Inductance (mH) min.	DC resistance (mΩ/line) max.	Temperature rise (K) max.	Finished dimensions (mm)		pin pitch (reference)		Wire size (mmø)	Weight approx. (g)
					OD (max.)	T (max.)	a	b		
SC-02-101	2	1	110	40	23.0	13.0	6	11	0.6	15
SC-02-100	2	1	100	40	23.0	18.5	6	17	0.6	15
SC-02-200	2	2	110	40	23.0	18.5	6	17	0.6	15
SC-02-300	2	3	100	40	27.0	20.0	6	17	0.6	16
SC-02-500	2	5	100	45	27.0	20.0	6	17	0.6	20
SC-02-800	2	8	150	40	34.0	23.0	7	20	0.6	25
SC-05-100	5	1	50	40	25.0	18.5	6	17	0.8	20
SC-05-200	5	2	70	40	32.0	22.0	7	21	0.8	25
SC-05-500	4	5	80	50	34.0	23.0	7	21	0.8	30
SC-05-800	4	8	85	60	34.0	23.0	7	21	0.8	40
SC-10-100	10	1	20	40	34.0	24.0	22	21	1.3	40
SC-10-200	10	2	28	40	47.0	27.0	30	30	1.3	80
SC-15-100	15	1	12	40	49.0	27.0	35	35	1.8	100
SC-15-200	15	2	12	45	50.0	28.0	35	35	1.8	110
SC-20-100	20	1	8	45	60.0	30.0	40	40	2.3	135
SC-30-100	30	1	6	40	62.0	35.0	55	20	2.6	190

- Rated voltage: 250VAC/VDC • Withstanding voltage: AC2400V (2sec. between lines)
- Insulation resistance: at 500VDC, more than 100MΩ (between lines) • Thermal class: A (105°C)
- Operating temperature range (°C): -25 to T (T=105-temperature rise) • Pin pitch listed above are reference only, not guaranteed values.
- Inductance measurement condition:100kHz, 1mA, KC547

Shape and Dimensions

● SC Coils vertical type (~5A)

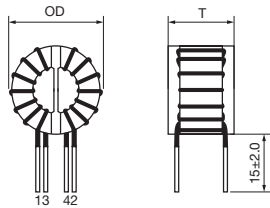

● SC Coils horizontal type (10A-)

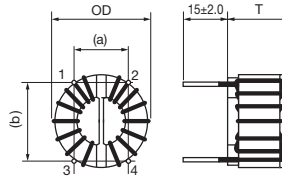

Mounting pitch

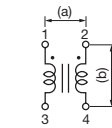

[mm]



- All specifications in this catalog and production status of products are subject to change without notice. Prior to the purchase, please contact TOKIN for updated product data.
- Please request for a specification sheet for detailed product data prior to the purchase.
- Before using the product in this catalog, please read "Precautions" and other safety precautions listed in the printed version catalog.

Impedance Characteristics

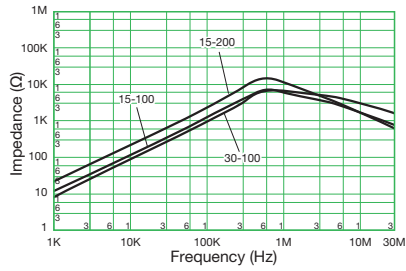
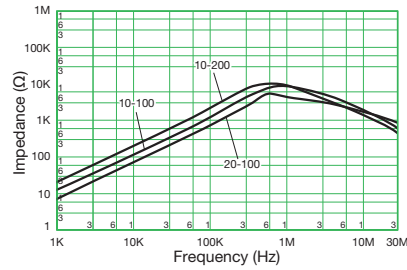
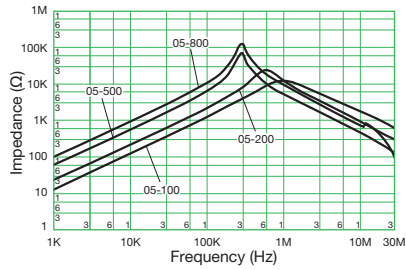
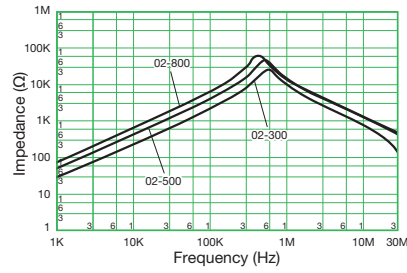
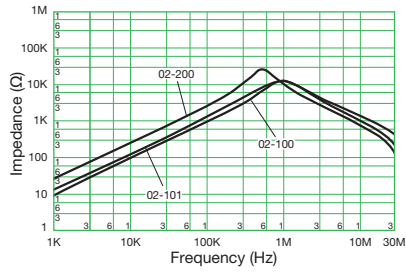

- All specifications in this catalog and production status of products are subject to change without notice. Prior to the purchase, please contact TOKIN for updated product data.
- Please request for a specification sheet for detailed product data prior to the purchase.
- Before using the product in this catalog, please read "Precautions" and other safety precautions listed in the printed version catalog.

SC Coils – Terminal Base Type SC-J Type

[RoHS Compliant]



Model	Rated current (A)	Inductance (mH) min.	DC resistance (mΩ/line) max.	Temperature rise (K) max.	Finished dimensions (mm)					Wire size (mmø)	Weight approx. (g)
					OD (max.)	T (max.)	H (max.)	a	b		
SC-02-10J *	2	1	100	40	25	20	27	10	15	0.6	15
SC-02-20J *	2	2	110	40	25	20	27	10	15	0.6	15
SC-02-30J *	2	3	110	40	25	20	27	10	15	0.6	16
SC-02-50J *	2	5	120	40	25	20	27	10	15	0.6	20
SC-05-10J *	5	1	50	40	25	20	27	10	15	0.8	20
SC-05-20J *	5	2	70	40	34	23	33	18	16	0.8	25
SC-05-30J *	5	3	70	55	34	23	33	18	16	0.8	30
SC-05-50J *	4	5	80	60	34	23	33	18	16	0.8	32
SC-05-80J *	4	8	90	60	34	23	33	18	16	0.8	42
SC-10-10J	10	1	20	40	34	23	33	12	17	1.3	42
SC-10-20J	10	2	22	50	42	29	44	18	22	1.4	70
SC-10-30J *	10	3	30	75	34	24	33	18	16	1.2	65
SC-12-15J	12	1.5	18	50	42	29	44	18	22	1.5	70
SC-15-05J *	15	0.5	8	60	34	23	33	18	16	1.5	40
SC-15-10J	15	1	12	55	44	30	44	18	22	1.7	75
SC-18-05J	18	0.5	7	50	44	30	44	18	22	1.8	60

- Rated voltage: 250VAC/VDC • Withstanding voltage: AC 2400V (2 sec between lines)
- Insulation resistance: at 500VDC, more than 100MΩ (between lines) • Thermal class: A (105°C) or *E (120°C)
- Operating temperature range (°C): -25 to T (T=105-temperature rise *T=120-temperature rise)
- Inductance measurement condition:100kHz, 1mA, KC547

Shape and Dimensions

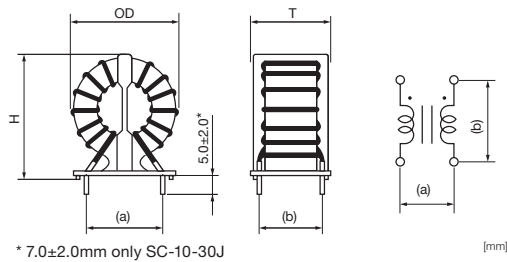

- All specifications in this catalog and production status of products are subject to change without notice. Prior to the purchase, please contact TOKIN for updated product data.
- Please request for a specification sheet for detailed product data prior to the purchase.
- Before using the product in this catalog, please read "Precautions" and other safety precautions listed in the printed version catalog.

Impedance Characteristics

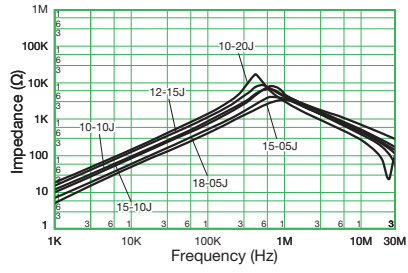
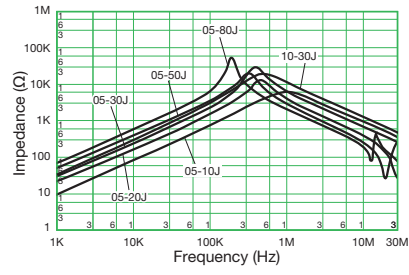
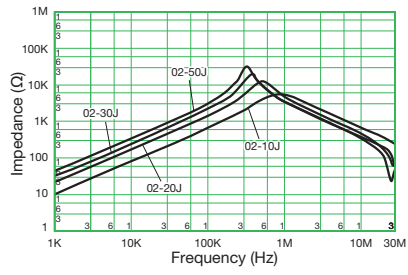

- All specifications in this catalog and production status of products are subject to change without notice. Prior to the purchase, please contact TOKIN for updated product data.
- Please request for a specification sheet for detailed product data prior to the purchase.
- Before using the product in this catalog, please read "Precautions" and other safety precautions listed in the printed version catalog.

SC Coils – Terminal Base Type SC-GJ Type

[RoHS Compliant]



Model	Rated current (A)	Inductance (mH) min.	DC resistance (mΩ/line) max.	Temperature rise (K) max.	Wire size (mmø)	Marking	Weight approx. (g)
SC-02-20GJ	2	2.0	80	40	0.5	220	9
SC-02-30GJ	2	3.0	100	40	0.5	230	10
SC-03-06GJ	3	0.6	35	40	0.6	306	8
SC-03-10GJ	3	1.0	40	40	0.6	310	9

- Rated voltage: 250VAC/VDC • Withstanding voltage: AC 2400V (2 sec between lines)
- Insulation resistance: at 500VDC, more than 100MΩ (between lines) • Thermal class: E (120°C)
- Operating temperature range (°C): -25 to T (T=120-temperature rise)
- Inductance measurement condition: 100kHz, 1mA, KC547

Shape and Dimensions

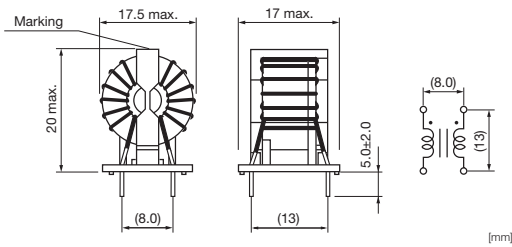

Impedance Characteristics

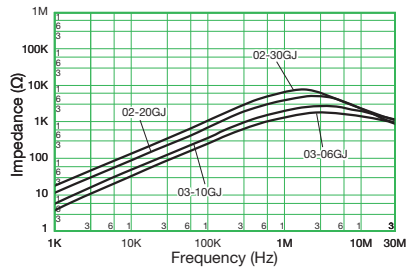

- All specifications in this catalog and production status of products are subject to change without notice. Prior to the purchase, please contact TOKIN for updated product data.
- Please request for a specification sheet for detailed product data prior to the purchase.
- Before using the product in this catalog, please read "Precautions" and other safety precautions listed in the printed version catalog.

SC Coils – Terminal Base Type SC-JS Type

[RoHS Compliant]



Model	Rated current (A)	Inductance (mH) min.	DC resistance (mΩ/line) max.	Temperature rise (K) max.	Wire size (mmφ)	Weight approx. (g)
SC-02-10JS	2	1.0	100	40	0.5	8.0
SC-02-15JS	2	1.5	120	40	0.5	8.5
SC-02-20JS	2	2.0	120	40	0.5	9.0
SC-03-08JS	3	0.8	60	40	0.6	9.0
SC-03-10JS	3	1.0	80	40	0.6	9.0

- Rated voltage: 250VAC/VDC • Withstanding voltage: AC 2400V (2 sec between lines)
- Insulation resistance: at 500VDC, more than 100MΩ (between lines, from line to tube) • Thermal class: A (105°C)
- Operating temperature range (°C): -25 to T (T=105-temperature rise)
- Inductance measurement condition: 1kHz, 0.3mA, KC547

Shape and Dimensions

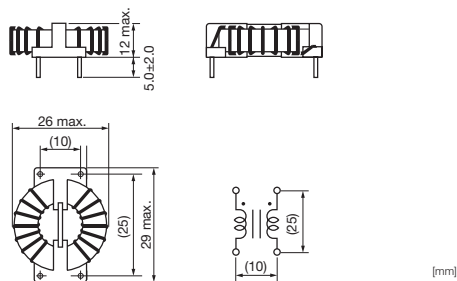

Impedance Characteristics

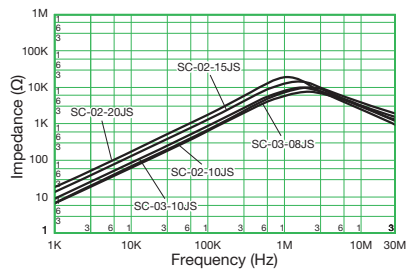

- All specifications in this catalog and production status of products are subject to change without notice. Prior to the purchase, please contact TOKIN for updated product data.
- Please request for a specification sheet for detailed product data prior to the purchase.
- Before using the product in this catalog, please read "Precautions" and other safety precautions listed in the printed version catalog.

SC Coils – Terminal Base Type SC-JH Type

[RoHS Compliant]



Model	Rated current (A)	Inductance (mH) min.	DC resistance (mΩ/line) max.	Temperature rise (K) max.	Finished dimensions (mm)					Wire size (mmφ)	Weight approx. (g)
					OD (max.)	H (max.)	T (max.)	a	b		
SC-10-20JH	10	2.0	22	45	42	30	41	17	30	1.4	72
SC-12-15JH	12	1.5	18	45	42	30	41	17	30	1.5	71
SC-15-10JH	15	1.0	12	50	44	32	41	17	30	1.7	73
SC-15-20JH	15	2.0	12	45	51	34	—	26	30	1.8	115
SC-18-15JH	18	1.5	10	55	51	34	—	26	30	1.9	117
SC-20-10JH	20	1.0	8	50	51	34	—	15	35	2.0	110

- Rated voltage: 250VAC/VDC • Withstanding voltage: 2400V (2 sec between lines)
- Insulation resistance: at 500VDC, more than 100MΩ (between lines) • Thermal class: A (105°C)
- Operating temperature range (°C): -25 to T (T=105-temperature rise)
- Inductance measurement condition: 100kHz, 1mA, KC547

Shape and Dimensions

● SC-15-20JH, SC-18-15JH, SC-20-10JH

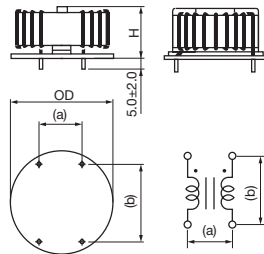

● SC-10-20JH, SC-12-15JH, SC-15-10JH

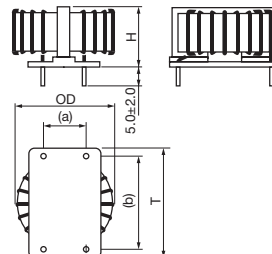

[mm]

Impedance Characteristics

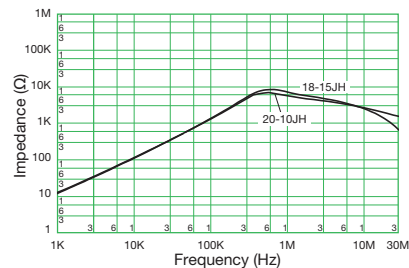
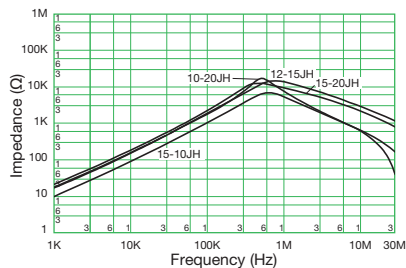

- All specifications in this catalog and production status of products are subject to change without notice. Prior to the purchase, please contact TOKIN for updated product data.
- Please request for a specification sheet for detailed product data prior to the purchase.
- Before using the product in this catalog, please read "Precautions" and other safety precautions listed in the printed version catalog.

SC Coils – Small Type SC-G/GS Type

[RoHS Compliant]



Model	Rated current (A)	Inductance (mH) min.	DC resistance (mΩ/line) max.	Temperature rise (K) max.	Wire size (mmø)	Marking	Weight approx. (g)
SC-01-06G	1	0.6	60	40	0.4	106	5
SC-01-10G	1	1.0	70	40	0.4	110	5
SC-01-20G	1	2.0	100	40	0.4	120	5
SC-01-30G	1	3.0	120	40	0.4	130	6
SC-01-50G	1	5.0	150	40	0.4	150	7
SC-01-80G	1	8.0	300	40	0.35	180	6
SC-01-E100G *1,*2	1	10.0	350	40	0.35	100	6
SC-01-E121G *1,*2	1	12.0	400	40	0.35	121	6
SC-01-E150G *1,*2	1	15.0	450	40	0.35	—	6
SC-02-06G	2	0.6	50	40	0.5	206	6
SC-02-10G	2	1.0	50	40	0.5	210	7
SC-02-20G	2	2.0	70	40	0.5	220	8
SC-02-30G	2	3.0	85	40	0.5	230	9
SC-03-06G	3	0.6	30	40	0.6	306	7
SC-03-10G	3	1.0	35	40	0.6	310	8
SC-01-10GS *2	1	1.0	130	40	0.3	—	2
SC-01-20GS *2	1	2.0	180	40	0.3	—	2
SC-02-10GS *2	2	1.0	80	40	0.4	—	3
SC-03-05GS *2	3	0.5	45	45	0.45	—	3

- Rated voltage: 250VAC/VDC • Withstanding voltage: AC 2400V (2 sec between lines)
- Insulation resistance: at 500VDC, more than 100MΩ (between lines) • Thermal class: A (105°C) or *1E (120°C)
- Operating temperature range (°C): -25 to T (T=105-temperature rise *1T=120-temperature rise)
- Inductance measurement condition:100kHz, 1mA, KC547 (*1kHz, 1mA, KC547)

Shape and Dimensions

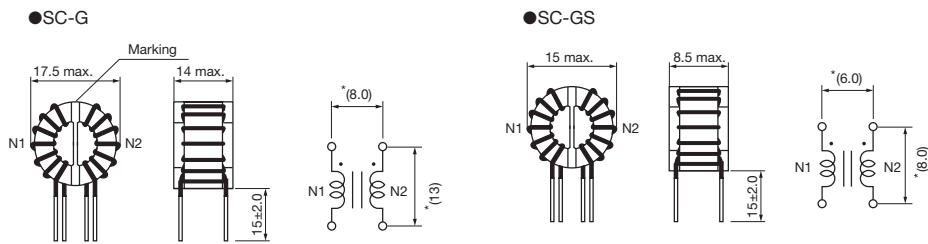

* Pin pitch are for reference only. Not guaranteed values.

[mm]



- All specifications in this catalog and production status of products are subject to change without notice. Prior to the purchase, please contact TOKIN for updated product data.
- Please request for a specification sheet for detailed product data prior to the purchase.
- Before using the product in this catalog, please read "Precautions" and other safety precautions listed in the printed version catalog.

Impedance Characteristics

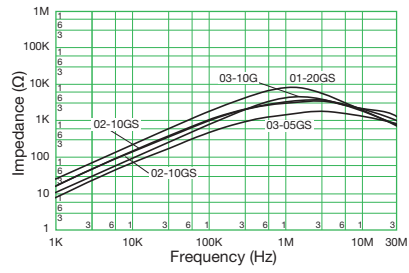
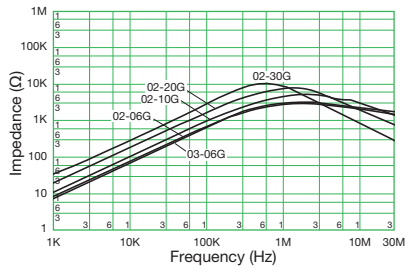
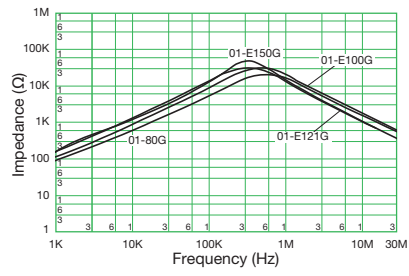
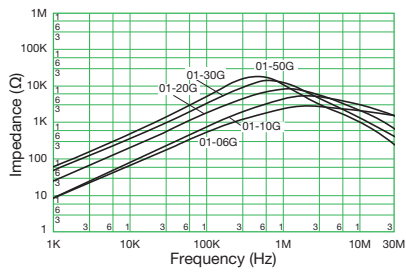

- All specifications in this catalog and production status of products are subject to change without notice. Prior to the purchase, please contact TOKIN for updated product data.
- Please request for a specification sheet for detailed product data prior to the purchase.
- Before using the product in this catalog, please read "Precautions" and other safety precautions listed in the printed version catalog.

SC Coils – Compact, High-Inductance Type SCF Type

[RoHS Compliant]



Model	Rated current (A)	Wire size (mmø)	Inductance (mH) min.	DC resistance (mΩ/line) max.	Temperature rise (K) max.	Finished dimensions (mm)			Weight approx. (g)	pin pitch (reference)	
						A (max.)	B (max.)	C		a	b
SCF-01-5000 *	1.0	0.35	50.0	390.0	60	15.0	12.0	15±2.0	5.0	—	—
SCF-02-1300 *	2.0	0.45	13.0	115.0	50	15.0	12.0	15±2.0	5.0	—	—
SCF-03-650 *	3.0	0.50	6.5	70.0	55	15.0	12.0	15±2.0	5.0	5	9
SCF-05-350 *	5.0	0.60	3.5	35.0	55	15.5	12.0	15±2.0	5.0	5	9
SCF20-05-550	5.0	0.80	5.5	28.0	50	25.0	15.5	20±2.5	11.4	14	12
SCF20-05-1100	5.0	0.80	11.0	39.0	70	25.0	15.5	20±2.5	13.5	14	12
SCF25-06-2000	6.0	1.10	20.0	26.0	45	32.0	23.0	10±2.5	41.5	13	20
SCF25-08-1300	8.0	1.20	13.0	18.0	50	32.0	23.0	10±2.5	41.0	13	20
SCF27-10-1300	10.0	1.30	13.0	15.0	55	35.0	24.0	15±3.0	47.0	24	20
SCF27-15-700	15.0	1.50	7.0	10.0	70	36.0	24.0	15±3.0	48.0	24	20

- Rated voltage: 250VAC/VDC (Models with *** have insulation distance designed value of equal or greater than 2.6mm)
- Withstanding voltage: AC 2400V (2 sec between lines) • Operating temperature range (°C): -25 to T (T=120-temperature rise)
- Thermal class: E (120°C) • Inductance measurement condition: 10kHz, 1mA, KC547
- Pin pitch are reference only. Not guaranteed values.

Shape and Dimensions

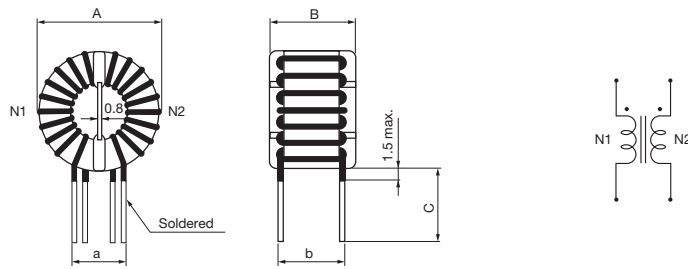

[mm]

Impedance Characteristics

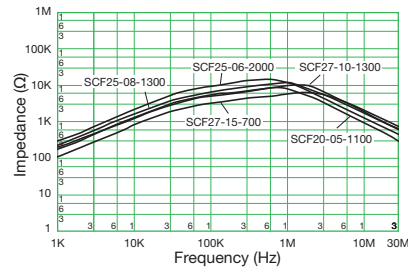
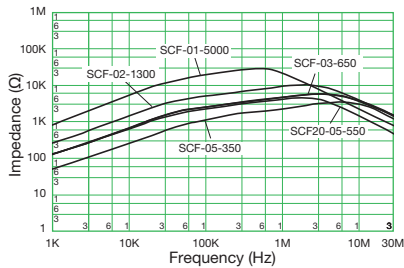

- All specifications in this catalog and production status of products are subject to change without notice. Prior to the purchase, please contact TOKIN for updated product data.
- Please request for a specification sheet for detailed product data prior to the purchase.
- Before using the product in this catalog, please read "Precautions" and other safety precautions listed in the printed version catalog.

SC Coils – High Frequency Type SC-D Type

[RoHS Compliant]



Model	Rated current (A)	Inductance (μH) min.	DC resistance (mΩ/line) max.	Temperature rise (K) max.	Finished dimensions (mm)		pin pitch (reference)		Wire size (mmø)	Weight approx. (g)
					OD (max.)	T (max.)	a	b		
SC-02-D100	2	100	70	40	23	13	10	13	0.5	7
SC-03-D050	3	50	40	40	23	13	10	13	0.6	8
SC-04-D050	4	50	25	40	25	19	10	19	0.7	14
SC-05-D030	5	30	20	40	25	19	10	19	0.8	14
SC-08-D060	8	60	30	45	34	23	22	21	1.0	30
SC-10-D050	10	50	16	45	34	23	22	21	1.2	34
SC-15-D030	15	30	12	50	34	23	22	21	1.4	34
SC-20-D010	20	10	8	50	34	23	22	21	1.7	33

- Rated voltage: 250VAC/VDC • Withstanding voltage: 2400V (2 sec between lines)
- Insulation resistance: at 500VDC, more than 100MΩ (between lines) • Thermal class: A (105°C)
- Operating temperature range (°C): -25 to T (T=105-temperature rise) • Inductance measurement condition:100kHz, 1mA, KC547
- Pin pitch are reference only. Not guaranteed values.

Shape and Dimensions

● SC-D vertical type (2A to 5A)

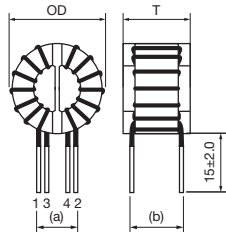

● SC-D horizontal type (8A to 20A)

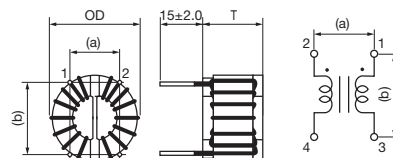

[mm]

Numbering System

SC - 02 - D 100

① ② ③

- ① 1 Rated current (A)
- ② Ni-Zn ferrite core
- ③ Inductance (μH)

Impedance Characteristics

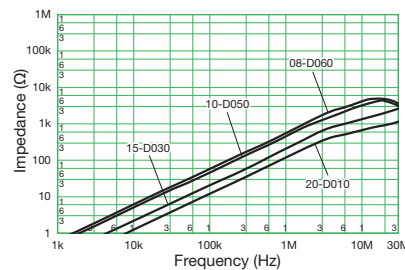
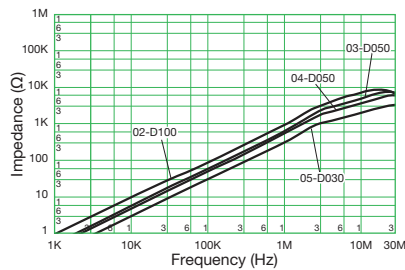

- All specifications in this catalog and production status of products are subject to change without notice. Prior to the purchase, please contact TOKIN for updated product data.
- Please request for a specification sheet for detailed product data prior to the purchase.
- Before using the product in this catalog, please read "Precautions" and other safety precautions listed in the printed version catalog.

SCR Coils Standard Type

[RoHS Compliant]



Features

- High impedance achieved by using high permeability S15H material
- 30% reduction in volume while maintaining the same properties (Enables saving space/reduction of part count)

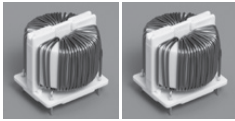

Conventional model with the same shape x2 (core O.D. 19mm)

Reduction of part count

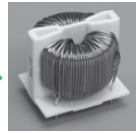

SCR Coil x1 (core O.D. 19mm)

Down of size



Conventional model with the same properties x1 (core O.D. 25mm)

Applications

- Audio-visual equipment
- Consumer electronics
- Power supply devices

Model	Rated current AC (A)	Inductance (mH) min.	DC resistance (mΩ/line) max.	Temperature rise (K) max.	Wire size (mmø)	Weight approx. (g)
SCR-020-0R55A250J/JH	2	25	200	55	0.55	23
SCR-030-0R6A170J/JH	3	15	138	70	0.6	23
SCR-040-0R8A100J/JH	4	10	66	62	0.8	27
SCR-050-0R9A070J/JH	5	7	47	70	0.9	27
SCR-060-0R9A040J/JH	6	4	32.6	65	0.9	24
SCR-070-1R0A030J/JH	7	3	23	60	1.0	25
SCR-080-1R1A020J/JH	8	2	15.9	55	1.1	25
SCR-090-1R2A015J/JH	9	1.5	11.9	55	1.2	25
SCR-100-1R2A010J/JH	10	1.0	9.6	55	1.2	25

- Model names ending with "J": Vertical terminal type Model names ending with "JH": Horizontal terminal type
- Rated voltage: 250VAC/VDC ● Withstanding voltage: 2400VAC (2sec. between lines)
- Insulation resistance: at 500VDC, more than 100MΩ (between lines) ● Thermal class: E (120°C)
- Operating temperature range (°C): -25 to T (T=120-temperature rise) ● Inductance measurement condition: 10kHz

Shape and Dimensions

●SCR-J

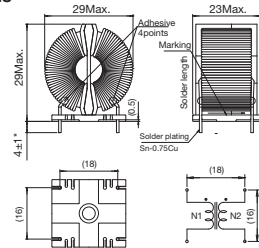

*Reference value.

●SCR-JH

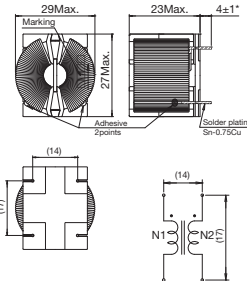

[mm]

Impedance Characteristics

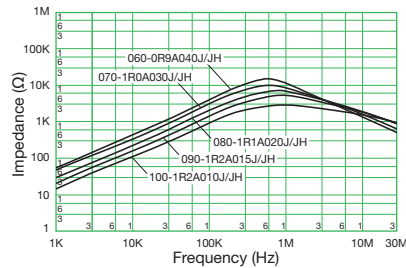
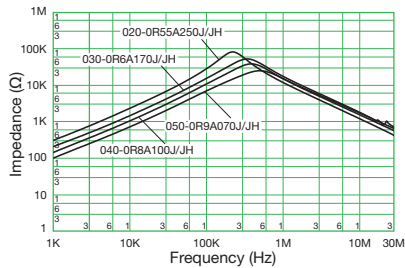

- All specifications in this catalog and production status of products are subject to change without notice. Prior to the purchase, please contact TOKIN for updated product data.
- Please request for a specification sheet for detailed product data prior to the purchase.
- Before using the product in this catalog, please read "Precautions" and other safety precautions listed in the printed version catalog.

SCR Coils SCR38 Type

[RoHS Compliant]



Features

- High inductance and high impedance characteristics for large currents are realized by using high permeability S15H material

Applications

- Power conditioner
- Air conditioner

Model	Rated current AC (A)	Inductance (mH) min.	DC resistance (mΩ/line) max.	Temperature rise (K) max.	Wire size (mmφ)	Weight approx. (g)
SCR38-200-2R3A010J	20	1.0	3.5	55	2.3	110
SCR38-350-1R8B008J	35	0.85	2.6	65	1.8×2P	120
SCR38-350-1R8B008JH	35	0.85	2.5	65	1.8×2P	120

- Rated voltage: 250VAC/VDC
- Withstanding voltage: 2400VAC (2sec. between lines)
- Insulation resistance: at500VDC, more than 100MQ (between lines)
- Thermal class: E (120°C)
- Operating temperature range (°C): -25 to T (T=120-temperature rise)
- Inductance measurement condition: 10kHz, 1mA

Shape and Dimensions

●J-TYPE

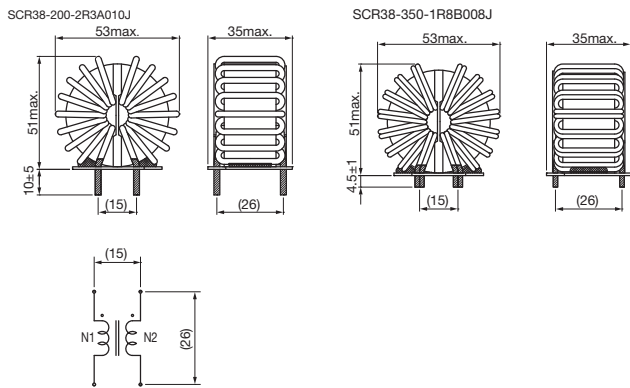

●JH-TYPE

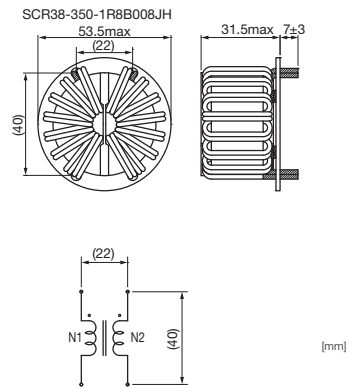

Impedance Characteristics

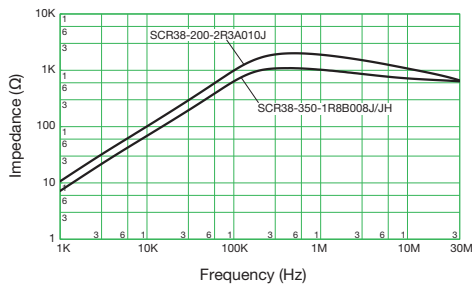

- All specifications in this catalog and production status of products are subject to change without notice. Prior to the purchase, please contact TOKIN for updated product data.
- Please request for a specification sheet for detailed product data prior to the purchase.
- Before using the product in this catalog, please read "Precautions" and other safety precautions listed in the printed version catalog.

SCR Coils SCR47 Type

[RoHS Compliant]



Features

- High inductance and high impedance characteristics for large currents are realized by using high permeability S15H material

Applications

- Power conditioner
- Air conditioner

Model	Rated current AC (A)	Inductance (mH) min.	DC resistance (mΩ/line) max.	Temperature rise (K) max.	Wire size (mmφ)	Weight approx. (g)
SCR47-350-1R6C016J	35	1.6	3.5	70	1.6×3P	200
SCR47-400-1R9C008JH	40	0.8	1.8	50	1.9×3P	230

- Rated voltage: 250VAC/VDC
- Withstanding voltage: 2400VAC (2sec. between lines)
- Insulation resistance: at500VDC, more than 100MΩ (between lines)
- Thermal class: E (120°C)
- Operating temperature range (°C): -25 to T (T=120-temperature rise)
- Inductance measurement condition: 10kHz, 1mA

Shape and Dimensions

● J-TYPE

SCR47-350-1R6C016J

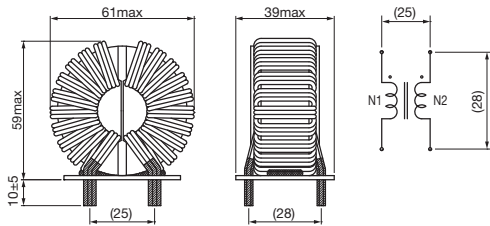

● JH-TYPE

SCR47-400-1R9C008JH

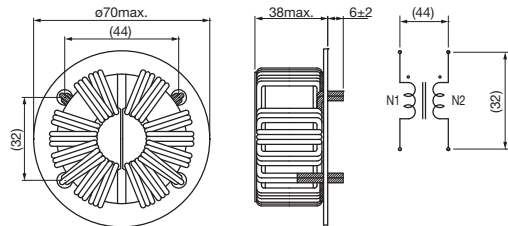

[mm]

Impedance Characteristics

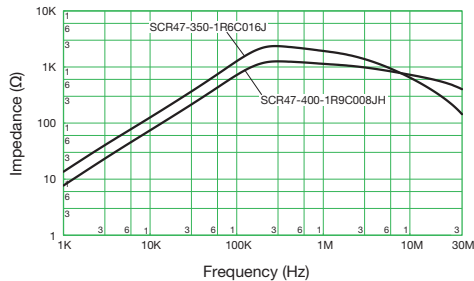

- All specifications in this catalog and production status of products are subject to change without notice. Prior to the purchase, please contact TOKIN for updated product data.
- Please request for a specification sheet for detailed product data prior to the purchase.
- Before using the product in this catalog, please read "Precautions" and other safety precautions listed in the printed version catalog.

SU Coils SU 7VC Type

[RoHS Compliant]



Model	Rated current (A)	Inductance (mH) min.	DC resistance (Ω/line) max.	Temperature rise (K) max.	Marking	Weight approx. (g)
SU7VC-02120	0.2	12.0	6.5	55	2 lot No.	1.7
SU7VC-05011	0.5	1.1	0.84	45	3 lot No.	1.6
SU7VC-07006	0.7	0.60	0.36	45	4 lot No.	1.7
SU7VC-08004	0.8	0.35	0.22	45	5 lot No.	1.7
SU7VC-10003	1.0	0.30	0.20	50	6 lot No.	1.7
SU7VC-12002	1.2	0.25	0.16	55	9 lot No.	1.7

- Rated voltage: 125VAC • Withstanding voltage: 2400V (2 sec between lines)
- Insulation resistance: at 500VDC, more than 100MΩ (between lines) • Thermal class: E (120°C)
- Operating temperature range (°C): -25 to T (T=120-temperature rise) • Inductance measurement condition: 1kHz, 1V, KC530

Shape and Dimensions

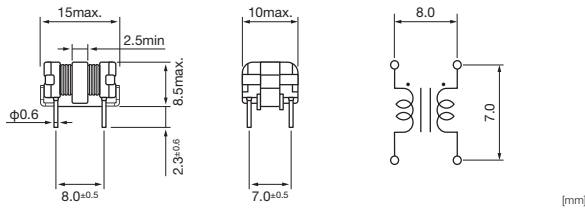

Impedance Characteristics

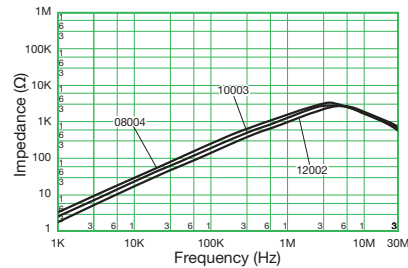
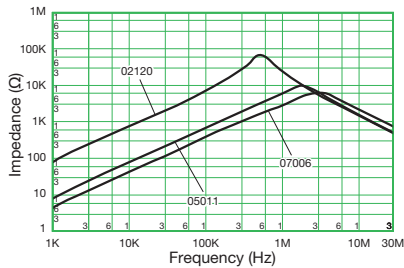

- All specifications in this catalog and production status of products are subject to change without notice. Prior to the purchase, please contact TOKIN for updated product data.
- Please request for a specification sheet for detailed product data prior to the purchase.
- Before using the product in this catalog, please read "Precautions" and other safety precautions listed in the printed version catalog.

SU Coils

SU 9V/9H Type

[RoHS Compliant]

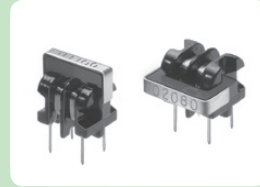

Model	Rated current (A)	Inductance (mH) min.	DC resistance (Ω/line) max.	Temperature rise (K) max.	Marking	Weight approx. (g)
SU9V/H-01100	0.1	10	8.0	40	01100	3.0
SU9V/H-02080	0.2	8.0	6.0	40	02080	3.2
SU9V/H-03050	0.3	5.0	3.0	40	03050	3.4
SU9V/H-05020	0.5	2.0	1.0	40	05020	3.5
SU9V/H-07010	0.7	1.0	0.6	40	07010	3.5
SU9V/H-10005	1.0	0.5	0.3	40	10005	3.4
SU9V/H-R01180	0.1	18	8.0	40	R 01180	3.0
SU9V/H-R02140	0.2	14	6.0	40	R 02140	3.2
SU9V/H-R03090	0.3	9.0	3.0	40	R 03090	3.4
SU9V/H-R05034	0.5	3.4	1.0	40	R 05034	3.5
SU9V/H-R07017	0.7	1.7	0.6	40	R 07017	3.5
SU9V/H-R10008	1.0	0.8	0.3	40	R 10008	3.4

- Rated voltage: 250VAC • Withstanding voltage: AC 2400V (2 sec between lines)
- Insulation resistance: at 500VDC, more than 100MΩ (between lines) • Thermal class: E (120°C)
- Operating temperature range (°C): -25 to T (T=120-temperature rise) • Inductance measurement condition: 1kHz, 1V, KC530

Shape and Dimensions

●SU9V

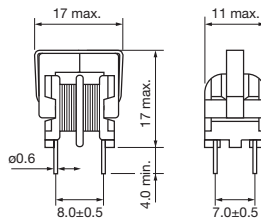

●SU9H

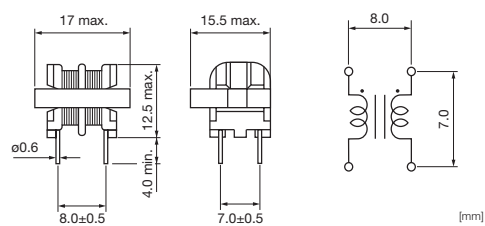

Numbering System

SU 9 V - 01 100

- ① ② ③ ④ ⑤ ⑥

- ① Series
- ② Core size
- ③ Core Type (V : vertical type, H : horizontal type)
- ④ Core Type (R : high permeability core)
- ⑤ Current rating(01 shows 0.1A)
- ⑥ Inductance (100 shows 10mH)



- All specifications in this catalog and production status of products are subject to change without notice. Prior to the purchase, please contact TOKIN for updated product data.
- Please request for a specification sheet for detailed product data prior to the purchase.
- Before using the product in this catalog, please read "Precautions" and other safety precautions listed in the printed version catalog.

Impedance Characteristics

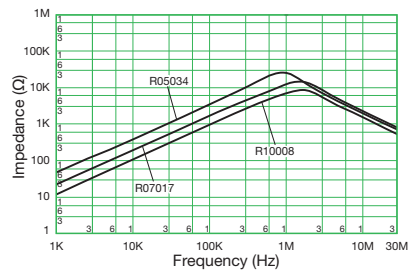
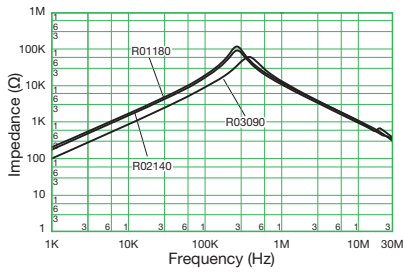
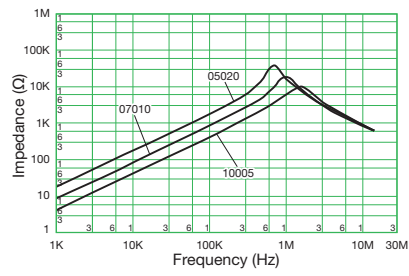
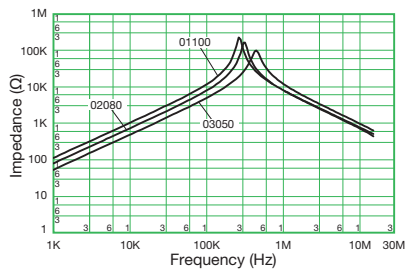

- All specifications in this catalog and production status of products are subject to change without notice. Prior to the purchase, please contact TOKIN for updated product data.
- Please request for a specification sheet for detailed product data prior to the purchase.
- Before using the product in this catalog, please read "Precautions" and other safety precautions listed in the printed version catalog.

SU Coils

SU 9VF/9HF Type

[RoHS Compliant]



Model	Rated current (A)	Inductance (mH) min.	DC resistance (Ω/line) max.	Temperature rise (K) max.	Marking	Weight approx. (g)
SU9VF/HF-02100	0.2	10	4.0	40	02100	3.1
SU9VF/HF-03060	0.3	6	2.0	40	03060	3.2
SU9VF/HF-05030	0.5	3	1.0	45	05030	3.2
SU9VF/HF-07015	0.7	1.5	0.44	40	07015	3.3

- Rated voltage: 250VAC • Withstanding voltage: AC 2400V (2 sec between lines)
- Insulation resistance: at 500VDC, more than 100MΩ (between lines) • Thermal class: E (120°C)
- Operating temperature range (°C): -25 to T (T=120-temperature rise) • Inductance measurement condition: 1kHz, 1V, KC530

Shape and Dimensions

●SU9VF

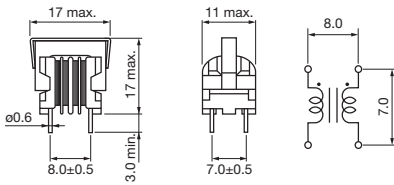

●SU9HF

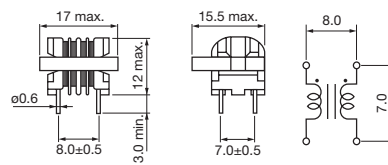

[mm]

Numbering System

SU 9 VF - 02 100

① ② ③ ④ ⑤

- Series
- Core size
- Type (VF: vertical, HF: horizontal)
- Rated current (02 stands for 0.2A)
- Inductance (100 stands for 10mH)

Impedance Characteristics

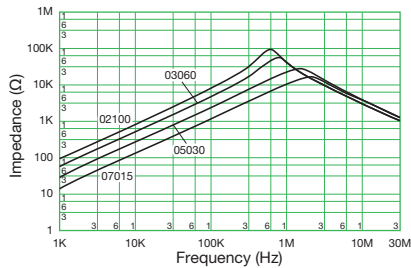

- All specifications in this catalog and production status of products are subject to change without notice. Prior to the purchase, please contact TOKIN for updated product data.
- Please request for a specification sheet for detailed product data prior to the purchase.
- Before using the product in this catalog, please read "Precautions" and other safety precautions listed in the printed version catalog.

SU Coils

SU 10VFC-R Type

[RoHS Compliant]



- <Features>
- Super low profile : 15.0mm max
 - High permeability core realizes high inductance
 - Best suites for internal power supply of compact / thin adaptor and other thin - cased devices.

Model	Rated current (A)	Inductance (mH) min.	DC resistance (Ω/line) max.	Temperature rise (K) max.	Marking	Weight approx. (g)
SU10VFC-R03370	0.3	37.0	4.2	45	R03 lot No.	6.5
SU10VFC-R04250	0.4	25.0	2.8	45	R04 lot No.	6.5
SU10VFC-R05140	0.5	14.0	1.6	45	R05 lot No.	6.4
SU10VFC-R07088	0.7	8.8	1.1	50	R07 lot No.	6.3
SU10VFC-R10045	1.0	4.5	0.55	50	R10 lot No.	6.4
SU10VFC-R13025	1.3	2.5	0.30	50	R13 lot No.	6.6
SU10VFC-R15019	1.5	1.9	0.24	50	R15 lot No.	6.5
SU10VFC-R17016	1.7	1.6	0.21	55	R17 lot No.	6.2
SU10VFC-R20010	2.0	1.0	0.15	55	R20 lot No.	6.2

- Rated voltage: 250VAC • Withstanding voltage: AC 2400V (2 sec between lines)
- Insulation resistance: at 500VDC, more than 100MΩ (between lines) • Thermal class: E (120°C)
- Operating temperature range (°C): -25 to T (T=120-temperature rise) • Inductance measurement condition: 1kHz, 1V, KC530

Shape and Dimensions

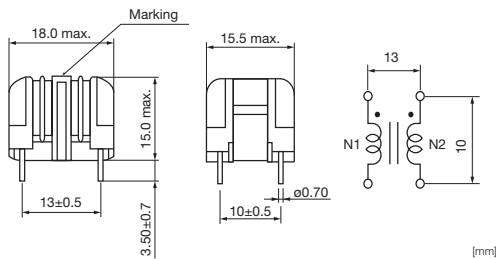

Numbering System

SU 10VFC - R 03 370

- ① Series
- ② Core size ; shape (V : vertical)
- ③ Core Type (R : High permeability core)
- ④ Rated current (03 stands for 0.3A)
- ⑤ Inductance (370 stands for 37.0mH)

Impedance Characteristics

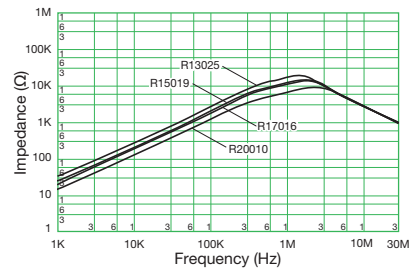
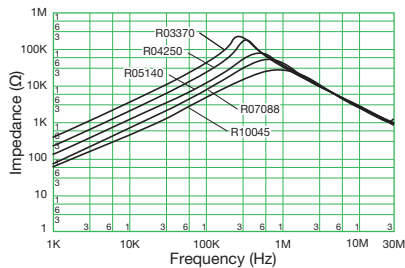

- All specifications in this catalog and production status of products are subject to change without notice. Prior to the purchase, please contact TOKIN for updated product data.
- Please request for a specification sheet for detailed product data prior to the purchase.
- Before using the product in this catalog, please read "Precautions" and other safety precautions listed in the printed version catalog.

SU Coils – High Frequency Type SU 9VD Type

[RoHS Compliant]

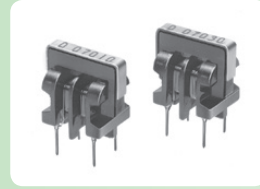

Model	Rated current (A)	Inductance (μH) min.	DC resistance (Ω/line) max.	Temperature rise (K) max.	Marking	Weight approx. (g)
SU9VD-07040	0.7	40	0.18	45	D07040	2.9
SU9VD-07030	0.7	30	0.15	45	D07030	2.9
SU9VD-07020	0.7	20	0.12	45	D07020	2.8
SU9VD-07010	0.7	10	0.10	45	D07010	2.7

- Rated voltage: 250VAC • Withstanding voltage: AC 2400V (2 sec between lines)
- Insulation resistance: at 500VDC, more than 100MΩ (between lines) • Thermal class: E (120°C)
- Operating temperature range (°C): -25 to T (T=120-temperature rise) • Inductance measurement condition: 1kHz, 1V, KC530

Shape and Dimensions

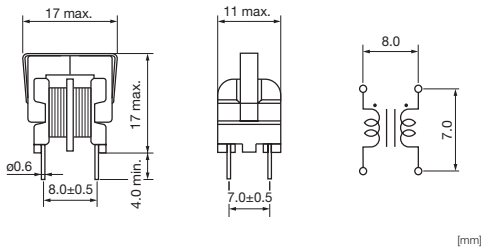

Numbering System

SU 9V D - 07 040

① ② ③ ④ ⑤

- ① Series
- ② Core size; shape (V: vertical)
- ③ Ni-Zn ferrite core
- ④ Rated current (07 stands for 0.7A)
- ⑤ Inductance (040 stands for 40μH)

Impedance Characteristics

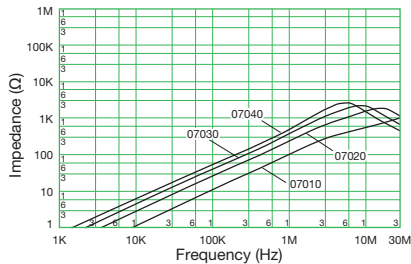

- All specifications in this catalog and production status of products are subject to change without notice. Prior to the purchase, please contact TOKIN for updated product data.
- Please request for a specification sheet for detailed product data prior to the purchase.
- Before using the product in this catalog, please read "Precautions" and other safety precautions listed in the printed version catalog.

SU Coils – High Frequency Type SU 10VD Type

[RoHS Compliant]

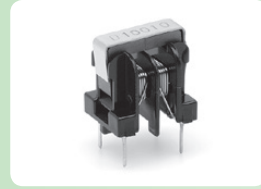

Model	Rated current (A)	Inductance (μH) min.	DC resistance (Ω/line) max.	Temperature rise (K) max.	Marking	Weight approx. (g)
SU10VD-10080	1	80	0.20	45	D10080	5.6
SU10VD-10050	1	50	0.20	45	D10050	5.5
SU10VD-10020	1	20	0.12	45	D10020	5.5
SU10VD-10010	1	10	0.10	45	D10010	5.7
SU10VD-20010	2	10	0.10	45	D20010	5.4

- Rated voltage: 250VAC • Withstanding voltage: AC 2400V (2 sec between lines)
- Insulation resistance: at 500VDC, more than 100MΩ (between lines) • Thermal class: E (120°C)
- Operating temperature range (°C): -25 to T (T=120-temperature rise) • Inductance measurement condition:1kHz, 1V, KC530

Shape and Dimensions

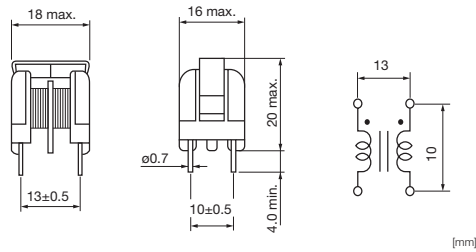

Numbering System

SU 10V D - 10 010

① ② ③ ④ ⑤

- ① Series
- ② Core size; shape (V: vertical)
- ③ Ni-Zn ferrite core
- ④ Rated current (10 stands for 1.0A)
- ⑤ Inductance (010 stands for 10μH)

Impedance Characteristics

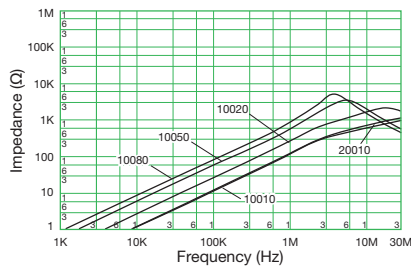

- All specifications in this catalog and production status of products are subject to change without notice. Prior to the purchase, please contact TOKIN for updated product data.
- Please request for a specification sheet for detailed product data prior to the purchase.
- Before using the product in this catalog, please read "Precautions" and other safety precautions listed in the printed version catalog.

SU Coils – High Frequency Type SU 16VD Type

[RoHS Compliant]



Model	Rated current (A)	Inductance (μH) min.	DC resistance (Ω/line) max.	Temperature rise (K) max.	Marking	Weight approx. (g)
SU16VD-30050	3.0	50	0.08	45	D30050	12.0
SU16VD-30040	3.0	40	0.07	45	D30040	11.9
SU16VD-30030	3.0	30	0.07	45	D30030	11.9
SU16VD-40020	4.0	20	0.05	45	D40020	11.8
SU16VD-40010	4.0	10	0.04	45	D40010	11.6

- Rated voltage: 250VAC • Withstanding voltage: AC 2400V (2 sec between lines)
- Insulation resistance: at 500VDC, more than 100MΩ (between lines) • Thermal class: E (120°C)
- Operating temperature range (°C): -25 to T (T=120-temperature rise) • Inductance measurement condition: 1kHz, 1V, KC530

Shape and Dimensions

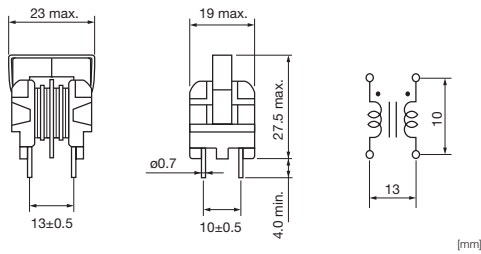

Numbering System

SU 16V D - 30 050

① ② ③ ④ ⑤

- ① Series
- ② Core size; shape (V: vertical)
- ③ Ni-Zn ferrite core
- ④ Rated current (30 stands for 3.0A)
- ⑤ Inductance (050 stands for 50μH)

Impedance Characteristics

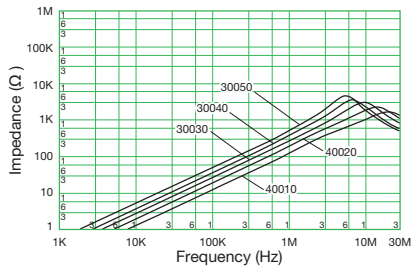

- All specifications in this catalog and production status of products are subject to change without notice. Prior to the purchase, please contact TOKIN for updated product data.
- Please request for a specification sheet for detailed product data prior to the purchase.
- Before using the product in this catalog, please read "Precautions" and other safety precautions listed in the printed version catalog.

SS Coils SS11VL Type

[RoHS Compliant]



- <Features>
- Super low profile : 20.5mm max. (19.5±1mm)
 - High permeability core realizes high inductance (SS11VL-R type)
 - Best suites for internal power supply of compact adaptor and other thin - cased devices.

Model	Rated current AC (A)	Inductance (mH) min.	DC resistance (Ω/line) max.	Temperature rise (K) max.	Marking	Weight approx. (g)
SS11VL-03550	0.3	55	4.1	45	03 LOT No.	10.5
SS11VL-04350	0.4	35	2.6	45	04 LOT No.	10.7
SS11VL-05230	0.5	23	1.8	45	05 LOT No.	10.5
SS11VL-06180	0.6	18	1.3	45	06 LOT No.	11.1
SS11VL-07120	0.7	12	0.90	45	07 LOT No.	10.8
SS11VL-08083	0.8	8.3	0.74	45	08 LOT No.	9.8
SS11VL-10062	1.0	6.2	0.44	45	10 LOT No.	11.1
SS11VL-11050	1.1	5.0	0.40	45	11 LOT No.	10.7
SS11VL-13035	1.3	3.5	0.28	45	13 LOT No.	10.5
SS11VL-17024	1.7	2.4	0.19	45	17 LOT No.	10.8
SS11VL-22013	2.2	1.3	0.12	45	22 LOT No.	10.4
SS11VL-30006	3.0	0.6	0.06	45	30 LOT No.	9.6
SS11VL-R03820	0.3	82	4.1	45	R03 LOT No.	10.5
SS11VL-R04520	0.4	52	2.6	45	R04 LOT No.	10.7
SS11VL-R05350	0.5	35	1.8	45	R05 LOT No.	10.5
SS11VL-R06270	0.6	27	1.3	45	R06 LOT No.	11.1
SS11VL-R07190	0.7	19	0.90	45	R07 LOT No.	10.8
SS11VL-R08125	0.8	12.5	0.74	45	R08 LOT No.	9.8
SS11VL-R10093	1.0	9.3	0.44	45	R10 LOT No.	11.1
SS11VL-R11076	1.1	7.6	0.40	45	R11 LOT No.	10.7
SS11VL-R13052	1.3	5.2	0.28	45	R13 LOT No.	10.5
SS11VL-R17036	1.7	3.6	0.19	45	R17 LOT No.	10.8
SS11VL-R22020	2.2	2.0	0.12	45	R22 LOT No.	10.4
SS11VL-R30009	3.0	0.9	0.06	45	R30 LOT No.	9.6

- Rated voltage: 250VAC • Withstanding voltage: AC 2400V (2 sec between lines)
- Insulation resistance: at 500VDC, more than 100MΩ (between lines) • Thermal class: E (120°C)
- Operating temperature range (°C): -25 to T (T=120-temperature rise) • Inductance measurement condition:1kHz, 1V, KC530

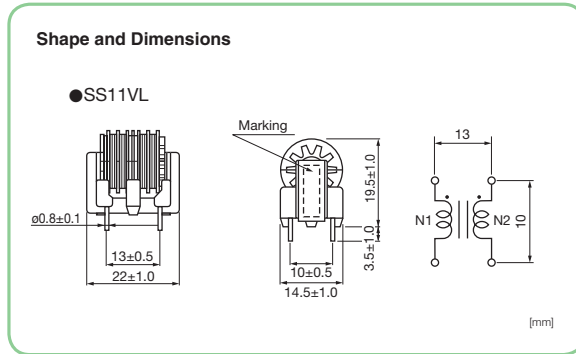

Numbering System

SS 11VL- 03 550

① ② ③ ④ ⑤ ⑥

- ① Series
- ② Core size
- ③ Type (VL : vertical)
- ④ Core Type (R : high permeability core)
- ⑤ Rated current (03 stands for 0.3A)
- ⑥ Inductance (550 stands for 55.0mH)



- All specifications in this catalog and production status of products are subject to change without notice. Prior to the purchase, please contact TOKIN for updated product data.
- Please request for a specification sheet for detailed product data prior to the purchase.
- Before using the product in this catalog, please read "Precautions" and other safety precautions listed in the printed version catalog.

Impedance Characteristics

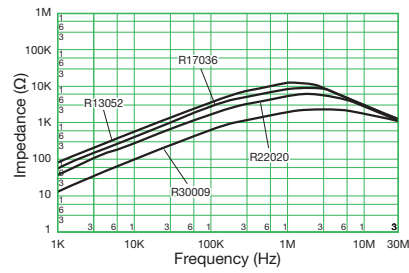
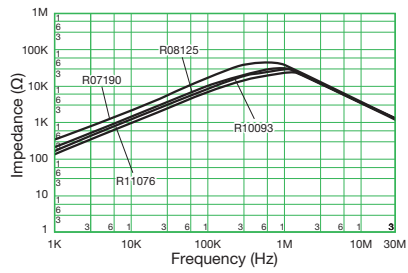
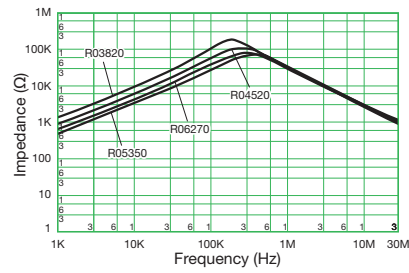
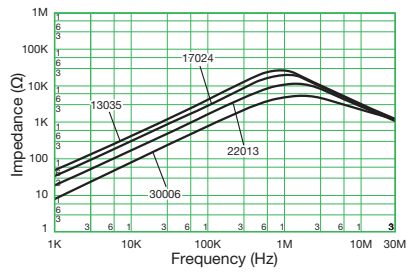
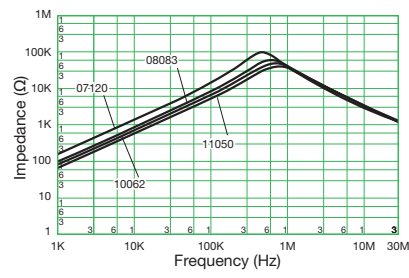
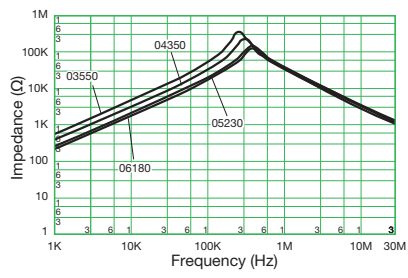

- All specifications in this catalog and production status of products are subject to change without notice. Prior to the purchase, please contact TOKIN for updated product data.
- Please request for a specification sheet for detailed product data prior to the purchase.
- Before using the product in this catalog, please read "Precautions" and other safety precautions listed in the printed version catalog.

SS Coils

SSB11V-R/11H-R Type

A common mode choke coil for class B

[RoHS Compliant]

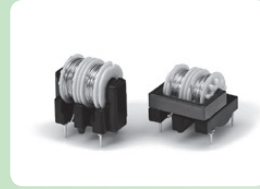

Model	Rated current (A)	Inductance (mH) min.	DC resistance (Ω/line) max.	Temperature rise (K) max.	Weight approx. (g)
SSB11V/H-R13090	1.3	9.0	0.38	60	11.0
SSB11V/H-R17043	1.7	4.3	0.18	40	11.0

- Rated voltage: 250VAC • Withstanding voltage: AC 2400V (2 sec between lines)
- Insulation resistance: at 500VDC, more than 100MΩ (between lines) • Thermal class: B (130°C)
- Operating temperature range (°C): -25 to T (T=130-temperature rise) • Inductance measurement condition: 1kHz, 1V, KC530

Shape and Dimensions

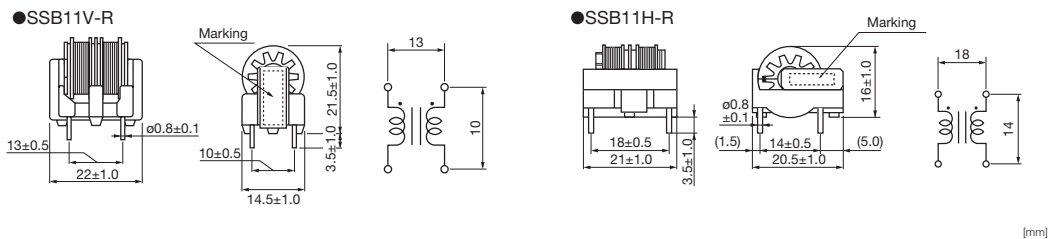

Numbering System

SSB 11 V-R - 13 090

- ① ② ③ ④ ⑤

- ① Series
- ② Core size
- ③ Type (V: vertical, H: horizontal)
- ④ Rated current (08 stands for 0.8A)
- ⑤ Inductance (125 stands for 12.5mH)

Impedance Characteristics

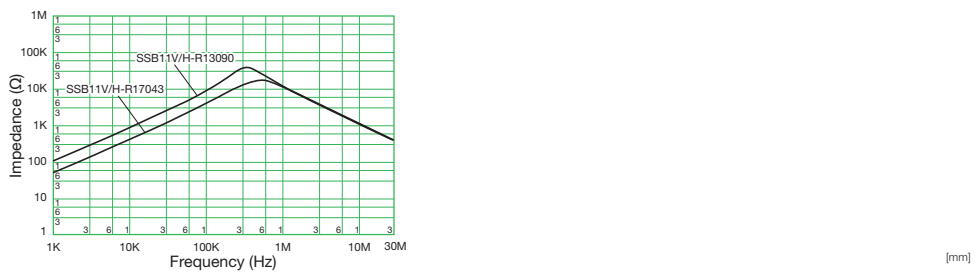

- All specifications in this catalog and production status of products are subject to change without notice. Prior to the purchase, please contact TOKIN for updated product data.
- Please request for a specification sheet for detailed product data prior to the purchase.
- Before using the product in this catalog, please read "Precautions" and other safety precautions listed in the printed version catalog.

SS Coils SS21V Type

[RoHS Compliant]

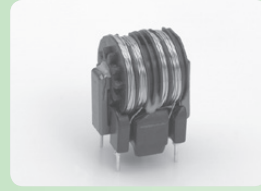

- <Features>
- High inductance yet compact design enables replacement for SS24V-type and SS11V-type
 - High permeability core realizes high inductance (R-types)
 - Approx. 38% reduced volume and covers approx. 70 to 98% inductance compared with SS24V type.
 - Approx. 21% volume increase when compared with SS11V-type; however, MAX inductance is approx. 70% increase.
 - Pin pitch is identical to SS24V-type and SS11V-type, thus making designing easy.
- * The comparison is with same rated current product's standard specification.

Model	Rated current AC (A)	Inductance (mH) min.	DC resistance (Ω/line) max.	Temperature rise (K) max.	Marking	Weight approx. (g)
SS21V-030930	0.3	93.0	5.9	50	03 LOT No.	12.3
SS21V-040520	0.4	52.0	5.4	50	04 LOT No.	12.2
SS21V-050360	0.5	36.0	2.4	50	05 LOT No.	12.2
SS21V-060220	0.6	22.0	1.5	45	06 LOT No.	12.9
SS21V-070179	0.7	17.9	1.1	50	07 LOT No.	13.2
SS21V-080136	0.8	13.6	0.8	45	08 LOT No.	13.4
SS21V-100098	1.0	9.8	0.6	50	10 LOT No.	13.1
SS21V-110067	1.1	6.7	0.45	45	11 LOT No.	12.8
SS21V-130044	1.3	4.4	0.35	50	13 LOT No.	11.5
SS21V-150038	1.5	3.8	0.30	50	15 LOT No.	12.4
SS21V-180029	1.8	2.9	0.20	45	18 LOT No.	13.3
SS21V-200024	2.0	2.4	0.15	50	20 LOT No.	12.6
SS21V-220017	2.2	1.7	0.13	45	22 LOT No.	12.7
SS21V-250015	2.5	1.5	0.10	50	25 LOT No.	12.3
SS21V-300008	3.0	0.8	0.07	50	30 LOT No.	11.7
SS21V-R031380	0.3	138.0	5.9	50	R03 LOT No.	12.3
SS21V-R040770	0.4	77.0	5.4	50	R04 LOT No.	12.2
SS21V-R050540	0.5	54.0	2.4	50	R05 LOT No.	12.2
SS21V-R060330	0.6	33.0	1.5	45	R06 LOT No.	12.9
SS21V-R070260	0.7	26.0	1.1	50	R07 LOT No.	13.2
SS21V-R080200	0.8	20.0	0.8	45	R08 LOT No.	13.4
SS21V-R100146	1.0	14.6	0.6	50	R10 LOT No.	13.1
SS21V-R110100	1.1	10.0	0.45	45	R11 LOT No.	12.8
SS21V-R130066	1.3	6.6	0.35	50	R13 LOT No.	11.5
SS21V-R150057	1.5	5.7	0.30	50	R15 LOT No.	12.4
SS21V-R180044	1.8	4.4	0.20	45	R18 LOT No.	13.3
SS21V-R200036	2.0	3.6	0.15	50	R20 LOT No.	12.6
SS21V-R220026	2.2	2.6	0.13	45	R22 LOT No.	12.7
SS21V-R250023	2.5	2.3	0.10	50	R25 LOT No.	12.3
SS21V-R300013	3.0	1.3	0.07	50	R30 LOT No.	11.7

- Rated voltage:250VAC • Withstanding voltage:2400VAC for 2 sec.(between lines)
- Insulation resistance: at 500VDC, more than 100MΩ (between lines) • Thermal class:E (120°C)
- Operating temperature range(°C):-25 to T (T=120-temperature rise) • Inductance measurement condition:1kHz, 1V, KC530

Shape and Dimensions

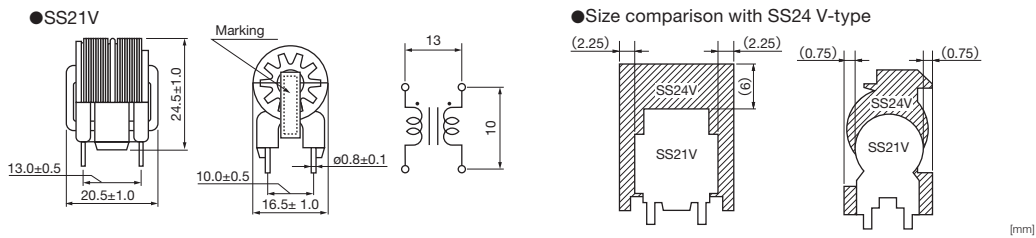

Numbering System

SS 21V - 03 0930

① ② ③ ④ ⑤

- ① Series
- ② Type (V: vertical, H: horizontal)
- ③ Core type (No marking : Standard core, R : high permeability core)
- ④ Rated current (0930 stands for 93.0A)
- ⑤ Inductance (0930 stands for 93.0mH)



- All specifications in this catalog and production status of products are subject to change without notice. Prior to the purchase, please contact TOKIN for updated product data.
- Please request for a specification sheet for detailed product data prior to the purchase.
- Before using the product in this catalog, please read "Precautions" and other safety precautions listed in the printed version catalog.

Impedance Characteristics

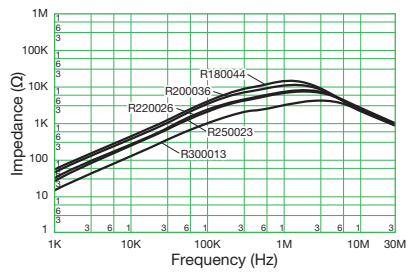
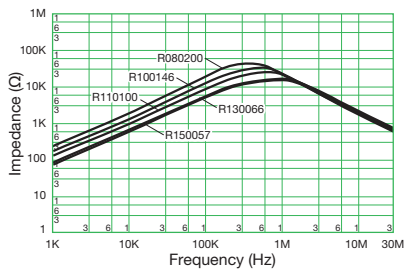
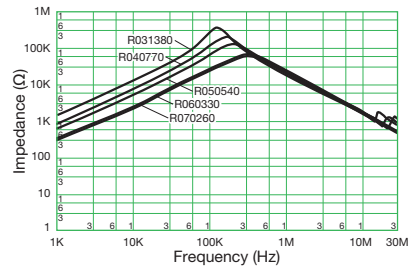
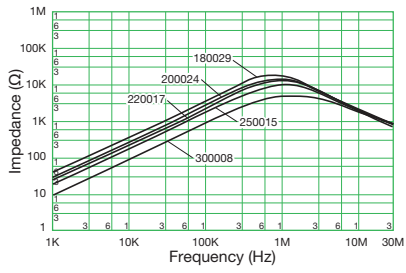
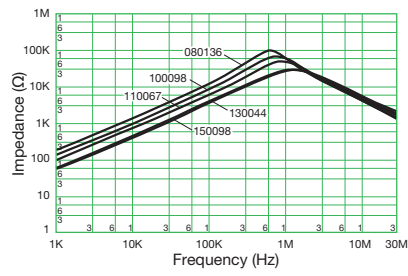
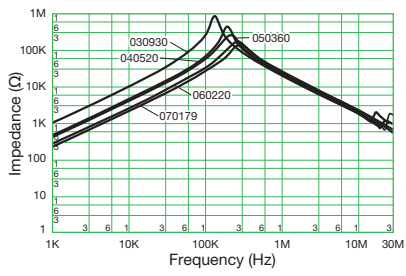

- All specifications in this catalog and production status of products are subject to change without notice. Prior to the purchase, please contact TOKIN for updated product data.
- Please request for a specification sheet for detailed product data prior to the purchase.
- Before using the product in this catalog, please read "Precautions" and other safety precautions listed in the printed version catalog.

SS Coils SS24V/H-CH Type

[RoHS Compliant]

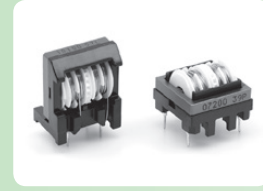

Model	Rated current AC (A)	Inductance (mH) min.	DC resistance (Ω/line) max.	Temperature rise (K) max.	Weight approx. (g)	
					V	H
SS24V/H-05350-CH	0.5	35	1.75	45	18.8	17.1
SS24V/H-08150-CH	0.8	15	0.75	50	18.8	17.1
SS24V/H-10100-CH	1.0	10	0.55	45	18.6	16.9
SS24V/H-15045-CH	1.5	4.5	0.24	45	19.0	17.3
SS24V/H-20025-CH	2.0	2.5	0.17	50	18.3	16.6
SS24V/H-K05570-CH	0.5	57.0	1.75	45	18.8	17.1
SS24V/H-K08240-CH	0.8	24.0	0.75	50	18.8	17.1
SS24V/H-K10165-CH	1.0	16.5	0.55	45	18.6	16.9
SS24V/H-K15070-CH	1.5	7.0	0.24	45	19.0	17.3
SS24V/H-K20040-CH	2.0	4.0	0.17	50	18.3	16.6
SS24V/H-R05600-CH	0.5	60	1.75	45	18.8	17.1
SS24V/H-R08250-CH	0.8	25	0.75	50	18.8	17.1
SS24V/H-R10170-CH	1.0	17	0.55	45	18.6	16.9
SS24V/H-R15080-CH	1.5	8.0	0.24	45	19.0	17.3
SS24V/H-R20045-CH	2.0	4.5	0.17	50	18.3	16.6

- Rated voltage:250VAC • Withstanding voltage: 2400VAC (2 sec between lines)
- Insulation resistance: at 500VDC, more than 100MΩ (between lines) • Thermal class: E (120°C)
- Operating temperature range (°C): -25 to T (T=120-temperature rise) • Inductance measurement condition: 1kHz, 1V, KC530

Shape and Dimensions

●SS24V

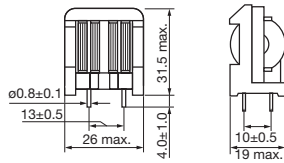

●SS24H

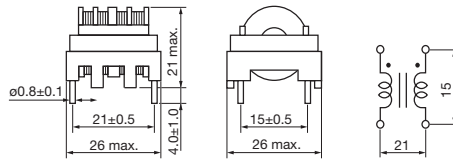

[mm]

Numbering System

SS 24 V - - 08 150 - CH
① ② ③ ④ ⑤ ⑥ ⑦

- ① Series
- ② Core size
- ③ Type (V: vertical, H: horizontal)
- ④ Core type (No marking: Standard core,R: High permeability core [μ=10000], K: High permeability core [μ=8000])
- ⑤ Rated current (08 stands for 0.8A)
- ⑥ Inductance (150 stands for 15mH)
- ⑦ Product type



- All specifications in this catalog and production status of products are subject to change without notice. Prior to the purchase, please contact TOKIN for updated product data.
- Please request for a specification sheet for detailed product data prior to the purchase.
- Before using the product in this catalog, please read "Precautions" and other safety precautions listed in the printed version catalog.

Impedance Characteristics

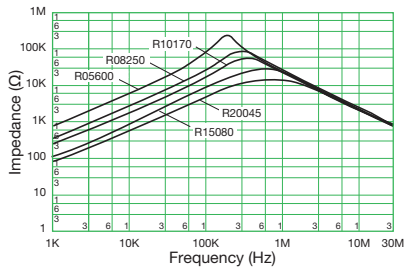
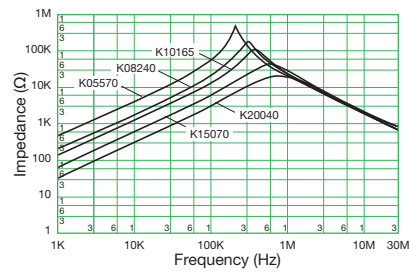
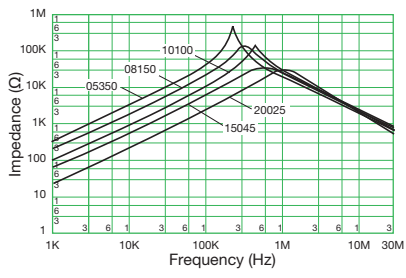

- All specifications in this catalog and production status of products are subject to change without notice. Prior to the purchase, please contact TOKIN for updated product data.
- Please request for a specification sheet for detailed product data prior to the purchase.
- Before using the product in this catalog, please read "Precautions" and other safety precautions listed in the printed version catalog.

SS Coils SS26V Type

[RoHS Compliant]



- <Features>
- High inductance yet compact design enables replacement for SS28V-type and SS24V-type.
 - Approx. 22% reduced volume and covers approx. 70 to 100% inductance compared with SS28V-type.
 - Approx. only 0.4% volume increase when compared with SS24V-type; however, MAX inductance is approx. 200% increase.
 - Pin pitch is identical to SS28V type and SS24V-type. thus making designing easy.
- * The comparison is with same rated current product's standard specification.

Model	Rated current AC (A)	Inductance (mH) min.	DC resistance (Ω/line) max.	Temperature rise (K) max.	Marking	Weight approx. (g)
SS26V-050880	0.5	88.0	2.4	45	05 LOT No.	25.3
SS26V-060640	0.6	64.0	1.8	45	06 LOT No.	25.4
SS26V-070510	0.7	51.0	1.4	50	07 LOT No.	25.2
SS26V-080350	0.8	35.0	1.0	45	08 LOT No.	25.0
SS26V-100250	1.0	25.0	0.7	45	10 LOT No.	25.8
SS26V-120169	1.2	16.9	0.55	50	12 LOT No.	22.6
SS26V-150121	1.5	12.1	0.40	50	15 LOT No.	23.5
SS26V-180092	1.8	9.2	0.30	50	18 LOT No.	24.3
SS26V-200076	2.0	7.6	0.25	50	20 LOT No.	25.9
SS26V-250046	2.5	4.6	0.15	50	25 LOT No.	24.3
SS26V-300028	3.0	2.8	0.10	50	30 LOT No.	23.0
SS26V-R051170	0.5	117.0	2.4	45	R05 LOT No.	25.3
SS26V-R060860	0.6	86.0	1.8	45	R06 LOT No.	25.4
SS26V-R070680	0.7	68.0	1.4	50	R07 LOT No.	25.2
SS26V-R080470	0.8	47.0	1.0	45	R08 LOT No.	25.0
SS26V-R100330	1.0	33.0	0.7	45	R10 LOT No.	25.8
SS26V-R120220	1.2	22.0	0.55	50	R12 LOT No.	22.6
SS26V-R150162	1.5	16.2	0.40	50	R15 LOT No.	23.5
SS26V-R180123	1.8	12.3	0.30	50	R18 LOT No.	24.3
SS26V-R200102	2.0	10.2	0.25	50	R20 LOT No.	25.9
SS26V-R250061	2.5	6.1	0.15	50	R25 LOT No.	24.3
SS26V-R300038	3.0	3.8	0.10	50	R30 LOT No.	23.0

- Rated voltage:250VAC • Withstanding voltage: 2400VAC (2 sec between lines)
- Insulation resistance: at 500VDC, more than 100MΩ (between lines) • Thermal class: E (120°C)
- Operating temperature range (°C): -25 to T (T=120-temperature rise) • Inductance measurement condition: 1kHz, 1V, KC530

Shape and Dimensions

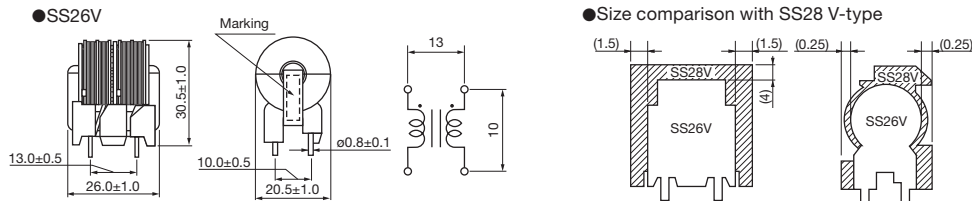

[mm]

Numbering System

SS 26V - R 05 0880

① ② ③ ④ ⑤

- ① Series
- ② Core size ; shape (V : vertical)
- ③ Core Type (no marking stands for standard type, R : high permeability core)
- ④ Rated current (05 stands for 0.5A)
- ⑤ Inductance (0880 stands for 88.0mH)



- All specifications in this catalog and production status of products are subject to change without notice. Prior to the purchase, please contact TOKIN for updated product data.
- Please request for a specification sheet for detailed product data prior to the purchase.
- Before using the product in this catalog, please read "Precautions" and other safety precautions listed in the printed version catalog.

Impedance Characteristics

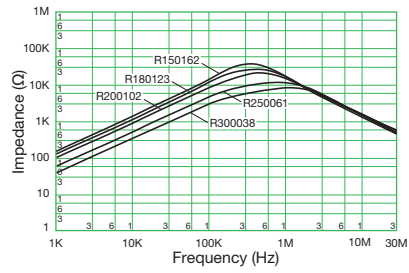
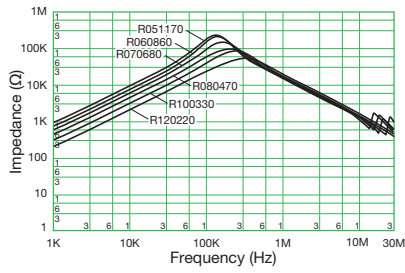
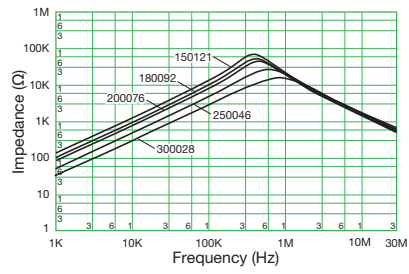
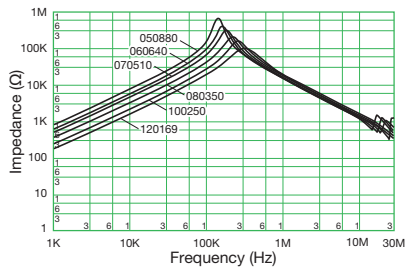

- All specifications in this catalog and production status of products are subject to change without notice. Prior to the purchase, please contact TOKIN for updated product data.
- Please request for a specification sheet for detailed product data prior to the purchase.
- Before using the product in this catalog, please read "Precautions" and other safety precautions listed in the printed version catalog.

SS Coils SS28V/H-CH Type

[RoHS Compliant]

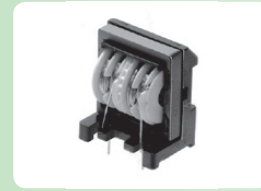

Model	Rated current AC (A)	Inductance (mH) min.	DC resistance (Ω/line) max.	Temperature rise (K) max.	Weight approx. (g)	
					V	H
SS28V/H-08350-CH	0.8	35	0.95	45	32.0	29.6
SS28V/H-10250-CH	1.0	25	0.65	45	33.4	31.0
SS28V/H-15100-CH	1.5	10	0.35	50	30.0	27.6
SS28V/H-20075-CH	2.0	7.5	0.22	45	32.7	30.3
SS28V/H-25045-CH	2.5	4.5	0.16	45	32.9	30.5
SS28V/H-K08530-CH	0.8	53	0.95	45	32.0	29.6
SS28V/H-K10410-CH	1.0	41	0.65	45	33.4	31.0
SS28V/H-K15155-CH	1.5	15.5	0.35	50	30.0	27.6
SS28V/H-K20115-CH	2.0	11.5	0.22	45	32.7	30.3
SS28V/H-K25075-CH	2.5	7.5	0.16	45	32.9	30.5
SS28V/H-R08600-CH	0.8	60	0.95	45	32.0	29.6
SS28V/H-R10450-CH	1.0	45	0.65	45	33.4	31.0
SS28V/H-R15170-CH	1.5	17	0.35	50	30.0	27.6
SS28V/H-R20130-CH	2.0	13	0.22	45	32.7	30.3
SS28V/H-R25080-CH	2.5	8.0	0.16	45	32.9	30.5

- Rated voltage:250VAC • Withstanding voltage: 2400VAC (2 sec between lines)
- Insulation resistance: at 500VDC, more than 100MΩ (between lines) • Thermal class: E (120°C)
- Operating temperature range (°C): -25 to T (T=120-temperature rise) • Inductance measurement condition: 1kHz, 1V, KC530

Shape and Dimensions

●SS28V

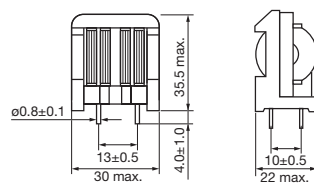

●SS28H

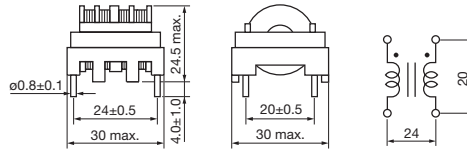

[mm]

Numbering System

SS 28V/H - 08 350 - CH
① ② ③ ④ ⑤ ⑥

- ① Series
- ② Core size ; shape (V : vertical)
- ③ Core Type (no marking stands for standard type)
- ④ Rated current (08 stands for 0.8A)
- ⑤ Inductance (350 stands for 35mH)
- ⑥ Product type



- All specifications in this catalog and production status of products are subject to change without notice. Prior to the purchase, please contact TOKIN for updated product data.
- Please request for a specification sheet for detailed product data prior to the purchase.
- Before using the product in this catalog, please read "Precautions" and other safety precautions listed in the printed version catalog.

Impedance Characteristics

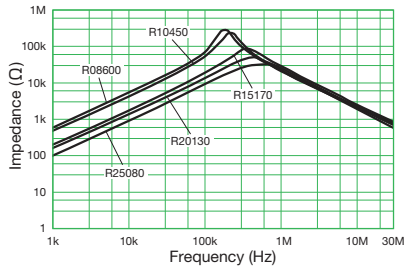
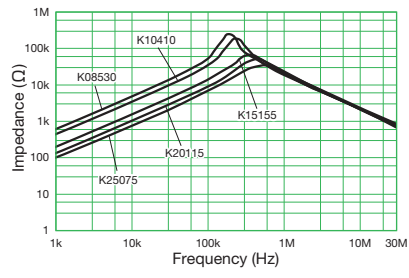
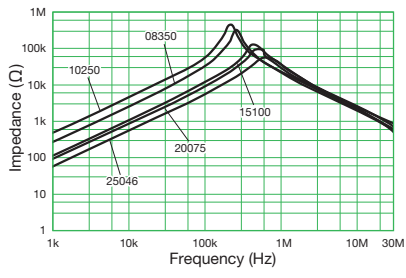

- All specifications in this catalog and production status of products are subject to change without notice. Prior to the purchase, please contact TOKIN for updated product data.
- Please request for a specification sheet for detailed product data prior to the purchase.
- Before using the product in this catalog, please read "Precautions" and other safety precautions listed in the printed version catalog.

SS Coils SS30V Type

[RoHS Compliant]

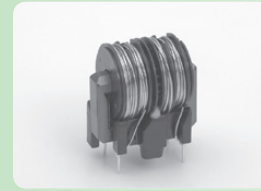

- <Features>
- High inductance yet compact design enables replacement for SS35V-type and SS28V-type
 - Approx. 36% reduced volume and covers approx. 60 to 100% inductance compared with SS35V-type.
 - Approx. only 0.2% volume increase when compared with SS28V-type; however, MAX inductance is approx. 60% increase.
 - Please be advised that the pin pitch is different from SS35V-type and SS28V-type
- * The comparison is with same rated current product's standard specification.

Model	Rated current AC (A)	Inductance (mH) min.	DC resistance (Ω/line) max.	Temperature rise (K) max.	Marking	Weight approx. (g)
SS30V-080730	0.8	73.0	1.5	50	08 LOT No.	35.1
SS30V-100530	1.0	53.0	1.1	50	10 LOT No.	36.8
SS30V-120290	1.2	29.0	0.6	45	12 LOT No.	35.0
SS30V-150200	1.5	20.0	0.5	45	15 LOT No.	35.3
SS30V-180145	1.8	14.5	0.23	50	18 LOT No.	35.2
SS30V-200100	2.0	10.0	0.21	45	20 LOT No.	34.9
SS30V-250070	2.5	7.0	0.16	45	25 LOT No.	34.1
SS30V-300054	3.0	5.4	0.12	45	30 LOT No.	34.6
SS30V-350036	3.5	3.6	0.10	50	35 LOT No.	30.6
SS30V-400021	4.0	2.1	0.07	50	40 LOT No.	29.0
SS30V-450013	4.5	1.3	0.06	50	45 LOT No.	26.1
SS30V-R080960	0.8	96.0	1.5	50	R08 LOT No.	35.1
SS30V-R100700	1.0	70.0	1.1	50	R10 LOT No.	36.8
SS30V-R120380	1.2	38.0	0.6	45	R12 LOT No.	35.0
SS30V-R150270	1.5	27.0	0.5	45	R15 LOT No.	35.3
SS30V-R180190	1.8	19.0	0.23	50	R18 LOT No.	35.2
SS30V-R200132	2.0	13.2	0.21	45	R20 LOT No.	34.9
SS30V-R250092	2.5	9.2	0.16	45	R25 LOT No.	34.1
SS30V-R300071	3.0	7.1	0.12	45	R30 LOT No.	34.6
SS30V-R350047	3.5	4.7	0.10	50	R35 LOT No.	30.6
SS30V-R400028	4.0	2.8	0.07	50	R40 LOT No.	29.0
SS30V-R450017	4.5	1.7	0.06	50	R45 LOT No.	26.1

- Rated voltage:250VAC • Withstanding voltage: 2400VAC (2 sec between lines)
- Insulation resistance: at 500VDC, more than 100MΩ (between lines) • Thermal class: E (120°C)
- Operating temperature range (°C): -25 to T (T=120-temperature rise) • Inductance measurement condition: 1kHz, 1V, KC530

Shape and Dimensions

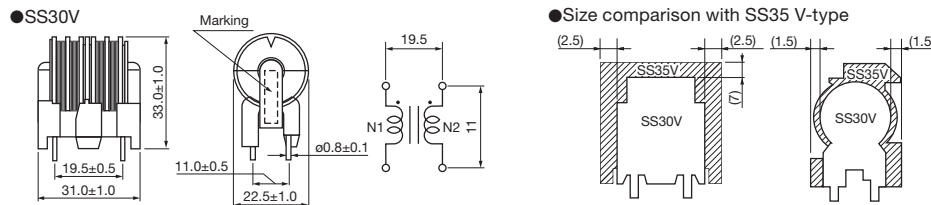

[mm]

Numbering System

SS 30V- 08 0730

- ① ② ③ ④ ⑤

- ① Series
- ② Core size ; shape (V : vertical)
- ③ Core Type (no marking stands for standard type)
- ④ Rated current (08 stands for 0.8A)
- ⑤ Inductance (0730 stands for 73.0mH)



- All specifications in this catalog and production status of products are subject to change without notice. Prior to the purchase, please contact TOKIN for updated product data.
- Please request for a specification sheet for detailed product data prior to the purchase.
- Before using the product in this catalog, please read "Precautions" and other safety precautions listed in the printed version catalog.

Impedance Characteristics

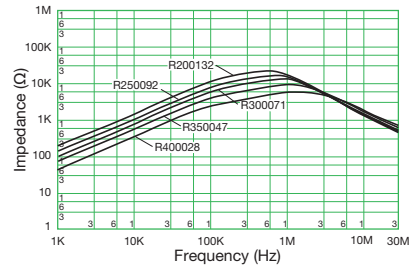
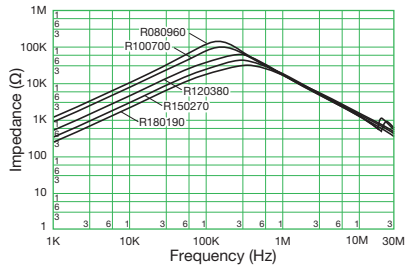
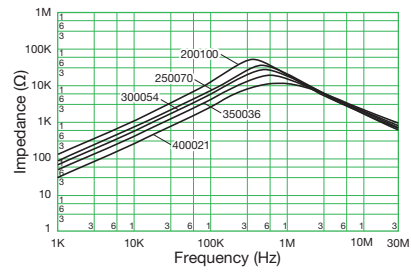
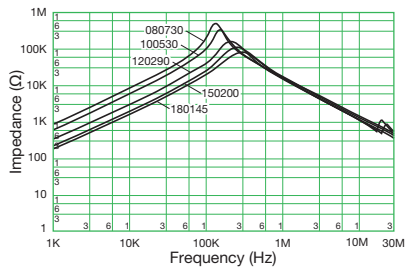

- All specifications in this catalog and production status of products are subject to change without notice. Prior to the purchase, please contact TOKIN for updated product data.
- Please request for a specification sheet for detailed product data prior to the purchase.
- Before using the product in this catalog, please read "Precautions" and other safety precautions listed in the printed version catalog.

SS Coils

SS35V/35H Type

[RoHS Compliant]

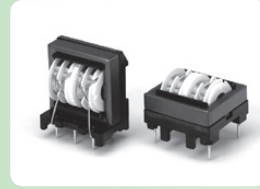

Model	Rated current AC (A)	Inductance (mH) min.	DC resistance (Ω/line) max.	Temperature rise (K) max.	Weight approx. (g)	
					V	H
SS35V/H-15300	1.5	30	0.48	45	60.0	57.0
SS35V/H-20170	2.0	17	0.28	45	61.0	58.0
SS35V/H-25090	2.5	9	0.20	45	59.0	56.0
SS35V/H-30082	3.0	8.2	0.15	45	59.0	56.0
SS35V/H-35047	3.5	4.7	0.10	45	57.0	54.0
SS35V/H-40033	4.0	3.3	0.08	50	55.0	52.0
SS35V/H-45022	4.5	2.2	0.06	50	53.0	50.0

- Rated voltage: 250VAC • Withstanding voltage: 2400VAC (2 sec between lines)
- Insulation resistance: at 500VDC, more than 100MΩ (between lines) • Thermal class: E (120°C)
- Operating temperature range (°C): -25 to T (T=120-temperature rise) • Inductance measurement condition: 1kHz, 1V, KC530

Shape and Dimensions

●SS35V

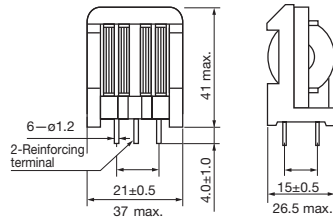

●SS35H

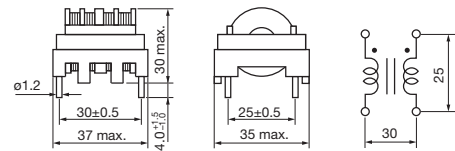

[mm]

Numbering System

SS 35 V - 15 300

① ② ③ ④ ⑤

- ① Series
- ② Core size
- ③ Type (V: vertical, H: horizontal)
- ④ Rated current (15 stands for 1.5A)
- ⑤ Inductance (300 stands for 30mH)

Impedance Characteristics

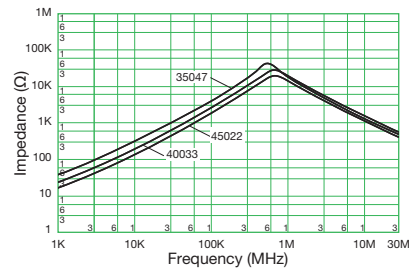
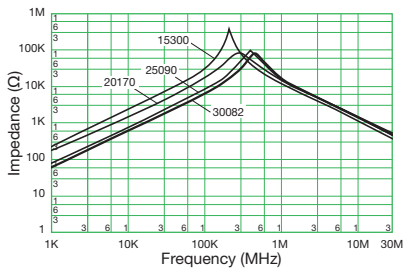

- All specifications in this catalog and production status of products are subject to change without notice. Prior to the purchase, please contact TOKIN for updated product data.
- Please request for a specification sheet for detailed product data prior to the purchase.
- Before using the product in this catalog, please read "Precautions" and other safety precautions listed in the printed version catalog.

SN Coils: Characteristics and Precautions

Material Characteristics of SN Cores

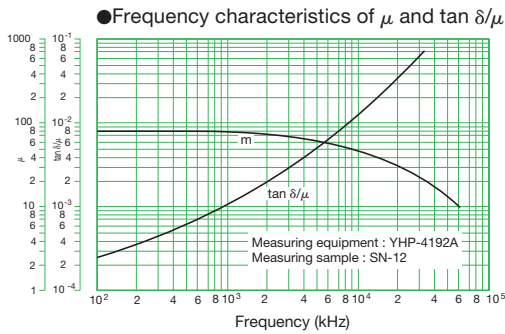

●B-H Curves at DC Magnetic Field

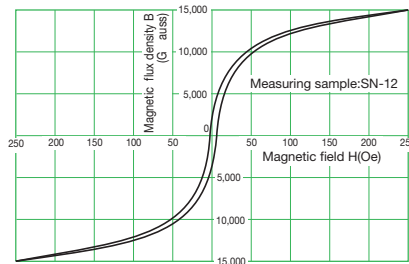

Circuit Design Precautions

Improper use of noise-prevention coils thyristor circuits may cause increased noise. When designing circuits, follow the instructions below.

●Correct insertion of SN Coils and capacitors

SN Coil

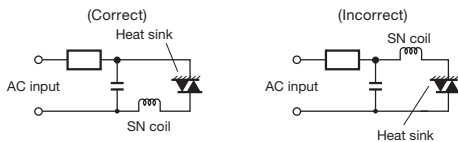

Capacitor

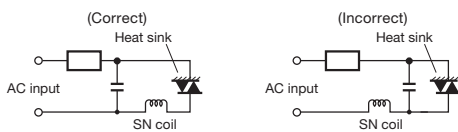

●Correct mounting of SN Coils

When attaching an SN Coil, do not use a long lead or attach it far from the noise emission source. Doing so results in increased aerial radiated noise.

●Circuit for turn-off prevention

When a thyristor control circuit is inserted, the thyristor element may not be able to ignite because the current turns off. To avoid this, inset C and R as shown in figures (A) and (B).

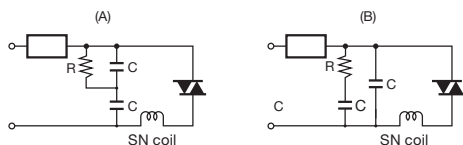

●Appropriate capacity

The appropriate capacity for the capacitor is from $0.1\mu F$ to $0.3\mu F$. If the capacity is too small, the SN Coil cannot perform as expected.

●Effect variation by capacity

As shown in the figure, noise-prevention performance varies with capacitor strength. Select the most appropriate value for your specification.

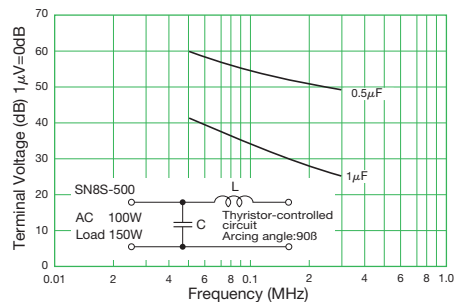

●Use as smoothing choke coils in switching power supplies

SN Coils have a large core loss; Do not use them as smoothing choke coils.

●Precautions

To avoid breaking wires, be sure to glue SN Coils to the board.



- All specifications in this catalog and production status of products are subject to change without notice. Prior to the purchase, please contact TOKIN for updated product data.
- Please request for a specification sheet for detailed product data prior to the purchase.
- Before using the product in this catalog, please read "Precautions" and other safety precautions listed in the printed version catalog.

●Frequency characteristics of μ and $\tan \delta/\mu$

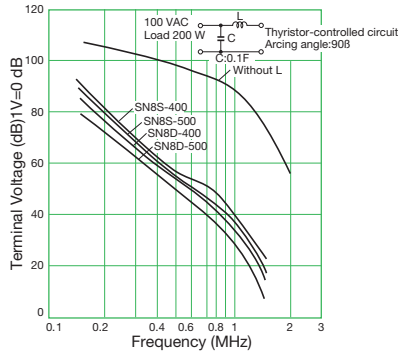

●B-H Curves at DC Magnetic Field

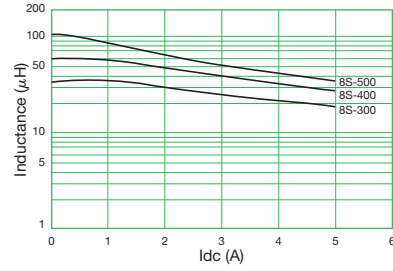

●Frequency characteristics of μ and $\tan \delta/\mu$

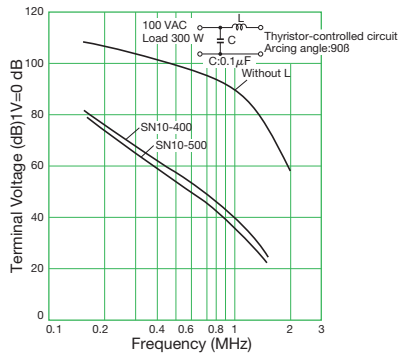

●DC-superposed Characteristics (2)

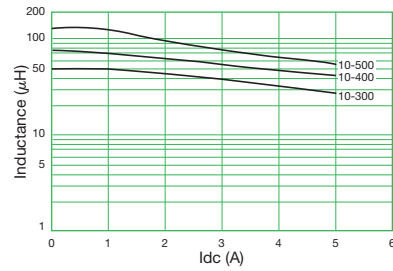

●Frequency characteristics of μ and $\tan \delta/\mu$

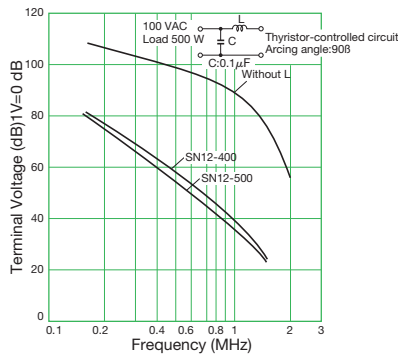

●DC-superposed Characteristics (3)

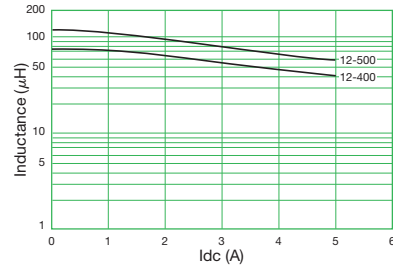

Measuring Circuit

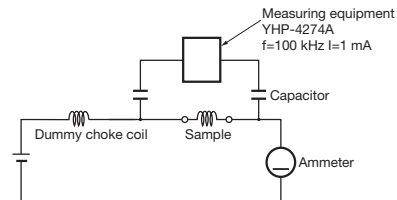

- All specifications in this catalog and production status of products are subject to change without notice. Prior to the purchase, please contact TOKIN for updated product data.
- Please request for a specification sheet for detailed product data prior to the purchase.
- Before using the product in this catalog, please read "Precautions" and other safety precautions listed in the printed version catalog.

HHB Coils

Hi μ and Low Core loss Type

[RoHS Compliant]



- <Features>
- Permeability: 150
 - High permeability realizes compact volume and small footprint.(10 to 50% less volume compared with conventional SN coil series.)
 - Low core loss

Model	Rated current AC (A)	Inductance (μ H) min.	DC resistance (m Ω) max.	Temperature rise (K) max.	Dimensions DxH (mm) max.	ϕ_1 (mm)	ϕ_2 (mm) max.	Wire size (mm ϕ)	Mounting pitch for reference (mm)	Weight approx. (g)
HHB5-0R45A115V	2	115	100	40	13.5x9.5	10 \pm 2	1.5	0.45	7	4
HHB8-0R7A100V	3.5	100	70	45	17x10	10 \pm 2	1.5	0.7	8	7
HHB10-0R7A550V	3	550	145	45	24x14	10 \pm 2	1.5	0.7	10	17
HHB10-0R8A170V	3	170	60	30	23x13	10 \pm 2	1.5	0.80	9	12
HHB12-1R2A170V	8	170	40	55	27x14	10 \pm 2	1.5	1.2	10.5	22

- Operating temperature range(°C): -25 to T (T=120-temperature rise)
- Wire type: 1 UEW or 1 PEW
- Inductance measurement condition: at 100kHz, 1mA, KC547
- Thermal class: E (120°C)
- Values of mounting pitch listed above are for reference only. The actual pitch may differ.

Shape and Dimensions



*Same type of shape as SN series are available.
(Horizontal type,with base and etc)

[mm]

Numbering System

HHB5 - 0R5A 70 V

① ② ③ ④

- ① Core size
- ② Wire size
- ③ Inductance
- ④ shape

Core loss comparison data

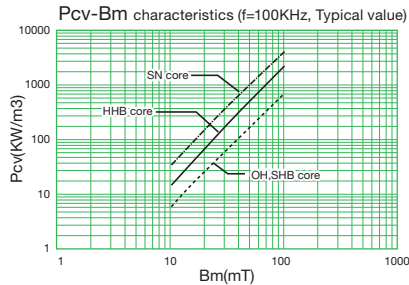

- All specifications in this catalog and production status of products are subject to change without notice. Prior to the purchase, please contact TOKIN for updated product data.
- Please request for a specification sheet for detailed product data prior to the purchase.
- Before using the product in this catalog, please read "Precautions" and other safety precautions listed in the printed version catalog.

Impedance Characteristics

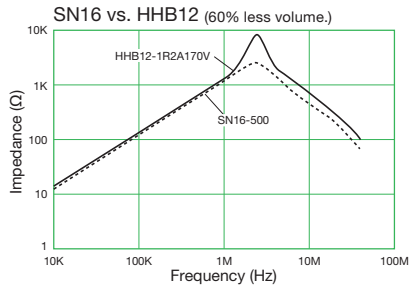
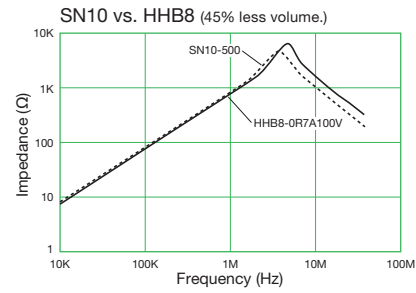
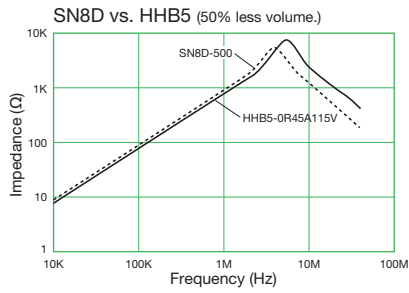

* Comparison of the volume stated in the graph is calculated from guaranteed values.



- All specifications in this catalog and production status of products are subject to change without notice. Prior to the purchase, please contact TOKIN for updated product data.
- Please request for a specification sheet for detailed product data prior to the purchase.
- Before using the product in this catalog, please read "Precautions" and other safety precautions listed in the printed version catalog.

Inductance Characteristics

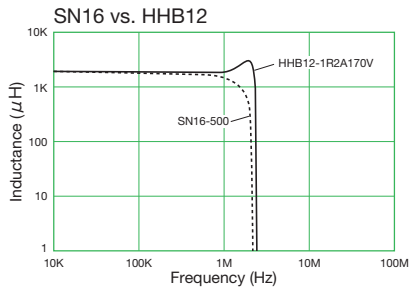
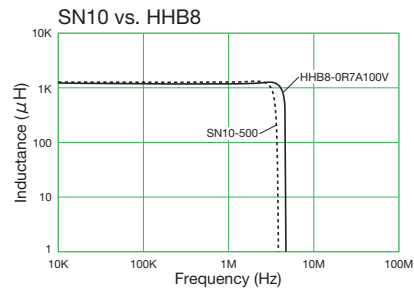
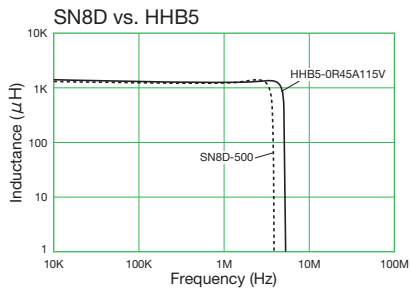

- All specifications in this catalog and production status of products are subject to change without notice. Prior to the purchase, please contact TOKIN for updated product data.
- Please request for a specification sheet for detailed product data prior to the purchase.
- Before using the product in this catalog, please read "Precautions" and other safety precautions listed in the printed version catalog.

DC-Superposed Characteristics

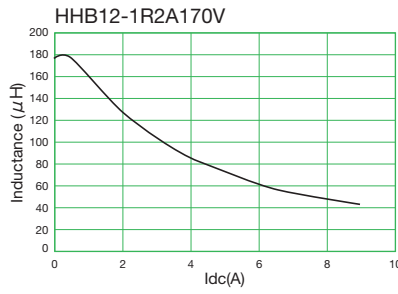
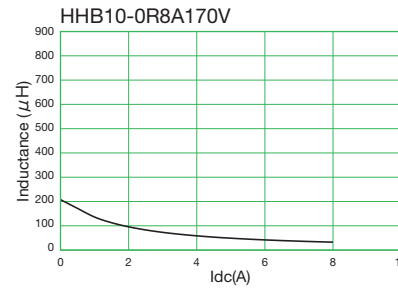
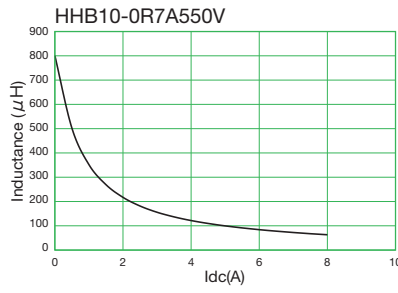
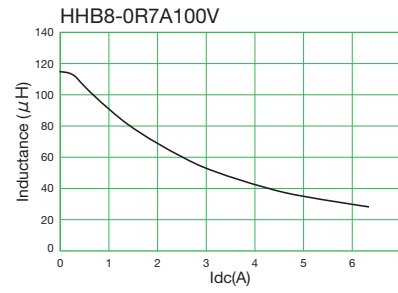
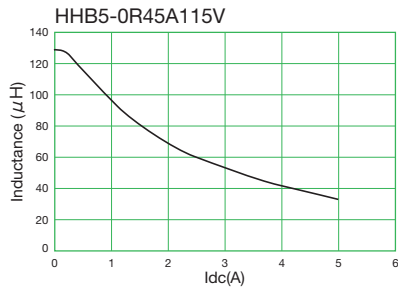

- All specifications in this catalog and production status of products are subject to change without notice. Prior to the purchase, please contact TOKIN for updated product data.
- Please request for a specification sheet for detailed product data prior to the purchase.
- Before using the product in this catalog, please read "Precautions" and other safety precautions listed in the printed version catalog.

SN Coils

Small and Standard Type

[RoHS Compliant]



Type	Model	Rated current (A)	Inductance (μH) min.	DC resistance (Ω) max.	Temperature rise (K) max.	Dimensions D×H (mm) max.	φ ₁ (mm)	φ ₂ (mm) max.	Wire size (mmφ)	Mounting pitch for reference (mm)	Weight approx. (g)
Small type	SN3-200	1	10	0.045	15	8.5×5.5	20±2	1.5	0.4	5	0.8
	SN5-300	2	25	0.042	18	13×7	20±2	1.5	0.55	6	2.6
	SN5-400	2	48	0.058	22	13×8	20±2	1.5	0.55	6	3
	SN8S-300	2	26	0.042	19	16×8	20±2	1.5	0.6	8	4.1
	SN8S-400	2	46	0.052	20	16×8	20±2	1.5	0.6	8	4.5
	SN8S-500	2	72	0.068	23	16×9	20±2	1.5	0.6	8.5	4.9
	SN8D-300	2	45	0.052	20	16×11	20±2	1.5	0.6	9.5	6.1
	SN8D-400	2	80	0.072	24	16×11	20±2	1.5	0.6	10	6.8
Standard type	SN8D-500	2	125	0.100	27	17×13	20±2	1.5	0.6	10.5	7.3
	SN10-300	3	40	0.035	18	21×11	20±2	1.5	0.8	9	10.2
	SN10-400	3	72	0.042	20	21×11	20±2	1.5	0.8	9	10.8
	SN10-500	3	110	0.052	26	21×12	20±2	1.5	0.8	10	11.8
	SN12-400	5	64	0.032	32	25×12	20±2	1.5	1.0	11	15.8
	SN12-500	5	100	0.040	34	26×12	20±2	1.5	1.0	12	18.2
	SN13-300	6	51	0.023	28	30×17	20±2	1.5	1.2	16	31.1
	SN13-400	6	92	0.030	33	30×18	20±2	1.5	1.2	16	35.1
	SN13-500	6	143	0.036	38	31×18	20±2	1.5	1.2	16.5	38.2
	SN16-300	8	60	0.021	21	34×19	20±2	1.5	1.5	15	39
	SN16-400	8	108	0.027	24	35×19	20±2	1.5	1.5	15	44.4
	SN16-500	8	168	0.031	36	35×21	20±2	1.5	1.5	16.5	51.2

- Operating temperature range(°C): -25 to T (T=105-temperature rise)
- Wire type: 1 PVF, 1 UEW or 1 PEW
- Inductance measurement condition: at 100kHz, 1mA, KC547 (SN13 and SN16 types: 1kHz, 1mA)
- Thermal class: A (105°C)

Shape and Dimensions

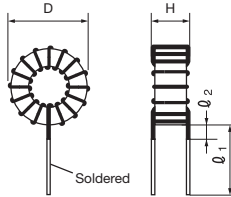

[mm]

Impedance Characteristics

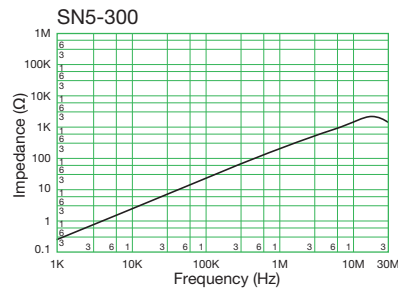
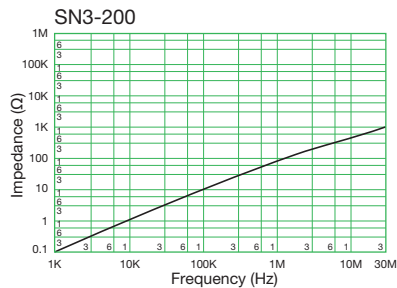

- All specifications in this catalog and production status of products are subject to change without notice. Prior to the purchase, please contact TOKIN for updated product data.
- Please request for a specification sheet for detailed product data prior to the purchase.
- Before using the product in this catalog, please read "Precautions" and other safety precautions listed in the printed version catalog.

Impedance Characteristics

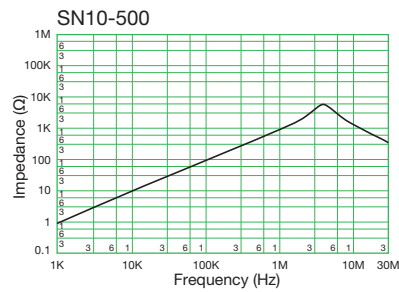
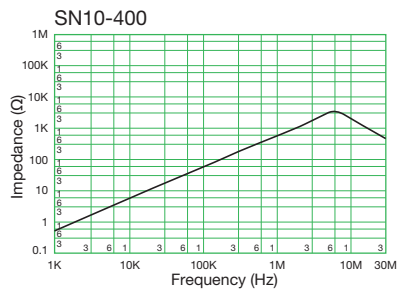
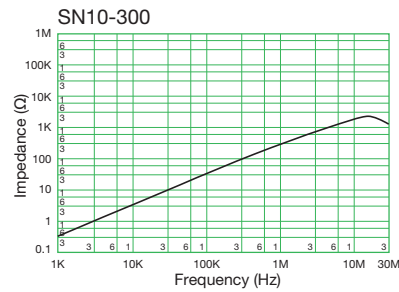
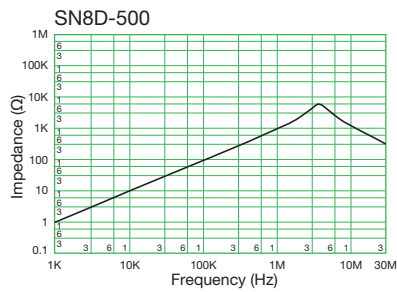
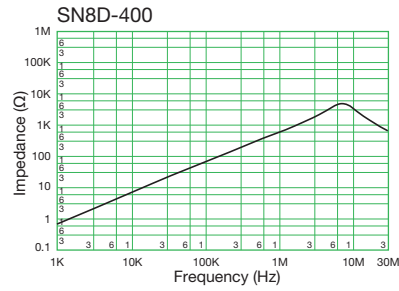
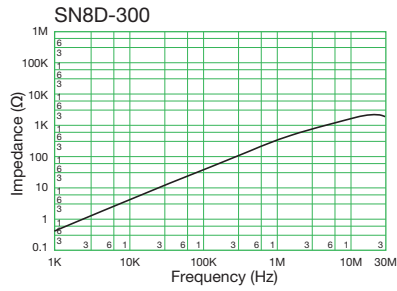
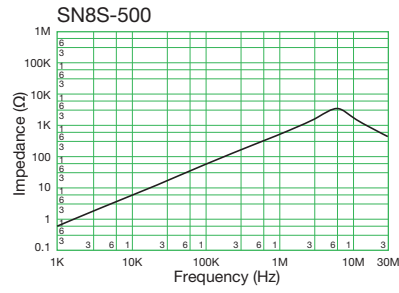
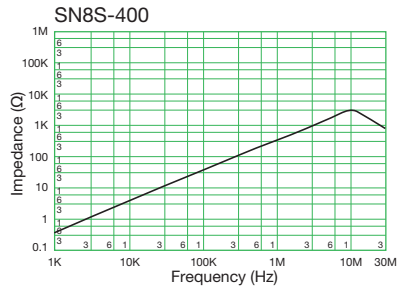
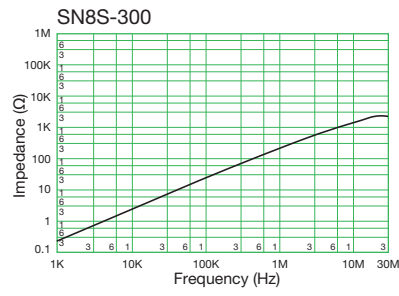
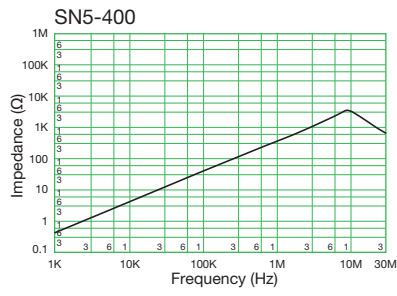

- All specifications in this catalog and production status of products are subject to change without notice. Prior to the purchase, please contact TOKIN for updated product data.
- Please request for a specification sheet for detailed product data prior to the purchase.
- Before using the product in this catalog, please read "Precautions" and other safety precautions listed in the printed version catalog.

Impedance Characteristics

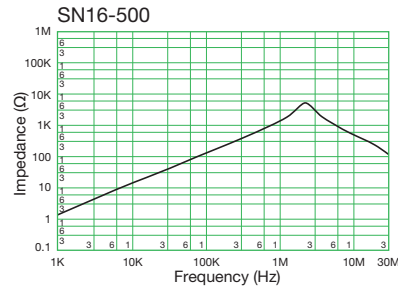
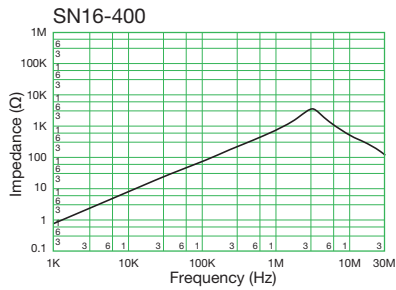
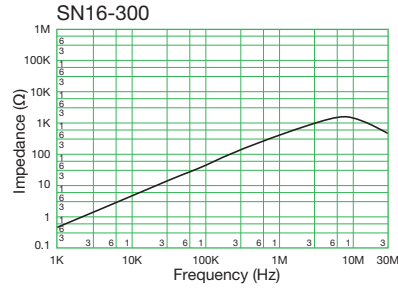
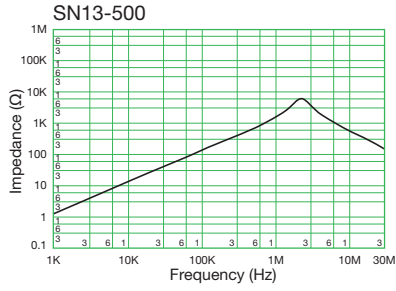
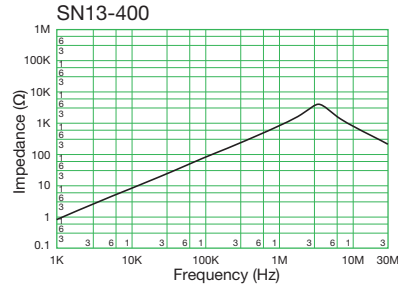
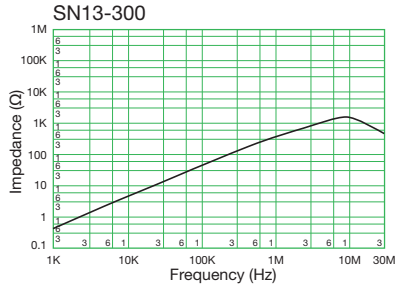
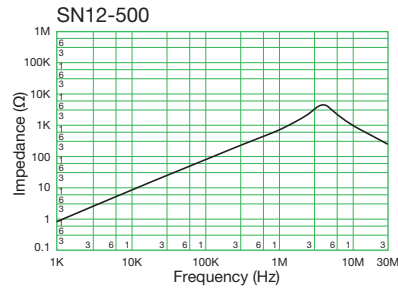
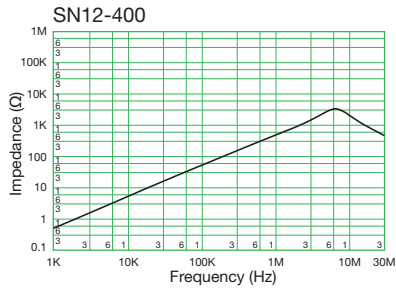

- All specifications in this catalog and production status of products are subject to change without notice. Prior to the purchase, please contact TOKIN for updated product data.
- Please request for a specification sheet for detailed product data prior to the purchase.
- Before using the product in this catalog, please read "Precautions" and other safety precautions listed in the printed version catalog.

SN Coils

Terminal Base Type – J Type

[RoHS Compliant]



Model	Rated current (A)	Inductance (μH) min.	DC resistance (Ω) max.	Temperature rise (K) max.	Finished dimensions (mm)			Wire size (mmø)	Weight approx. (g)
					A (max.)	B (max.)	C (max.)		
SN10-300J	3	40	0.041	23	23	16	26	0.8	12.5
SN10-400J	3	72	0.056	27	23	16	26	0.8	12.9
SN10-500J	3	110	0.071	30	23	16	26	0.8	14
SN12-400J	5	64	0.037	35	28	17	29	1.0	17.1
SN12-500J	5	100	0.045	38	28	17	29	1.0	20

- Operating temperature range(°C): -25 to T (T=105-temperature rise) • Wire type:1 PVF, 1 UEW or 1 PEW
- Inductance measurement condition: at 100kHz, 1mA, KC547 • Thermal class: A (105°C)

Shape and Dimensions

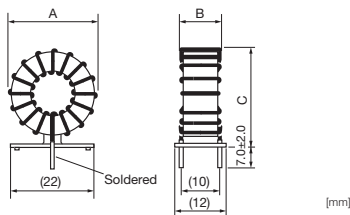

Impedance Characteristics

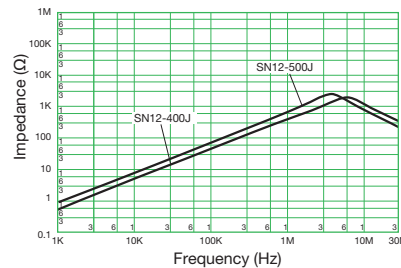
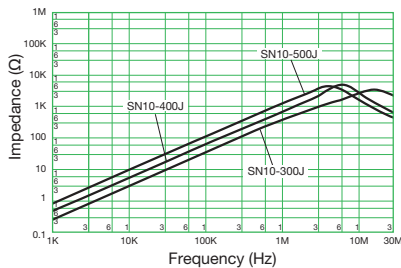

- All specifications in this catalog and production status of products are subject to change without notice. Prior to the purchase, please contact TOKIN for updated product data.
- Please request for a specification sheet for detailed product data prior to the purchase.
- Before using the product in this catalog, please read "Precautions" and other safety precautions listed in the printed version catalog.

SN Coils

Terminal Base Type – JA Type

[RoHS Compliant]



Model	Rated current (A)	Inductance (μH) min.	DC resistance (Ω) max.	Temperature rise (K) max.	Finished dimensions (mm)			Wire size (mmø)	Weight approx. (g)
					A (max.)	B (max.)	C (max.)		
SN8S-300JA	2	26	0.042	19	18.0	—	18.0	0.6	4.4
SN8S-400JA	2	46	0.052	20	18.0	—	18.0	0.6	5
SN16-300JA	8	60	0.021	21	35.0	19.0	39.0	1.5	40.6
SN16-400JA	8	108	0.027	24	35.0	20.0	39.0	1.5	45
SN16-500JA	8	168	0.031	36	35.0	21.0	39.0	1.5	53.6

- Operating temperature range(°C): -25 to T (T=105-temperature rise) • Wire type:1 PVF, 1 UEW or 1 PEW
- Inductance measurement condition: at 100kHz, 1mA, KC547 • Thermal class: A (105°C)

Shape and Dimensions

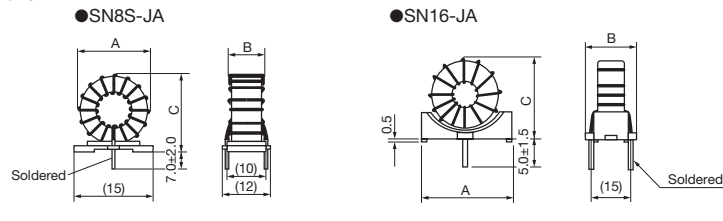

[mm]

Impedance Characteristics

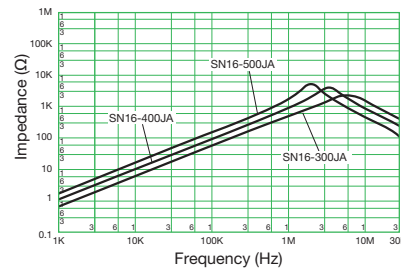
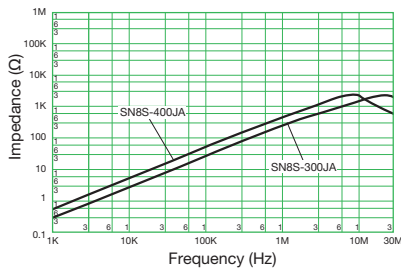

- All specifications in this catalog and production status of products are subject to change without notice. Prior to the purchase, please contact TOKIN for updated product data.
- Please request for a specification sheet for detailed product data prior to the purchase.
- Before using the product in this catalog, please read "Precautions" and other safety precautions listed in the printed version catalog.

SN Coils

Terminal Base Type – JB Type

[RoHS Compliant]



Model	Rated current (A)	Inductance (μH) min.	DC resistance (Ω) max.	Temperature rise (K) max.	Finished dimensions (mm)					Wire size (mmφ)	Weight approx. (g)
					A (max.)	B (max.)	C (max.)	D	E		
SN5-300JB	1	25	0.080	18	13.5	9.2	15.0	(7.5)	(10.0)	0.4	3
SN5-450JB	1	64	0.110	25	13.5	9.2	15.5	(7.5)	(10.0)	0.4	3
SN8S-300JB	2	26	0.055	19	18.0	12.5	18.0	(9.7)	(14.0)	0.6	4.8
SN8S-400JB	2	46	0.070	20	18.0	12.5	18.0	(9.7)	(14.0)	0.6	5.4
SN8S-500JB	2	72	0.085	23	18.0	12.5	18.0	(9.7)	(14.0)	0.6	5.9
SN8D-300JB	2	45	0.070	20	18.5	15.5	18.0	(13.0)	(14.0)	0.6	7.6
SN8D-400JB	2	80	0.085	24	18.5	15.5	18.0	(13.0)	(14.0)	0.6	8.4
SN8D-500JB	2	125	0.100	27	18.5	15.5	18.0	(13.0)	(14.0)	0.6	8.7

- Operating temperature range(°C): -25 to T (T=105–temperature rise) ● Wire type:1 PVF, 1 UEW or 1 PEW
- Inductance measurement condition: at 100kHz, 1mA, KC547 ● Thermal class: A (105°C)

Shape and Dimensions

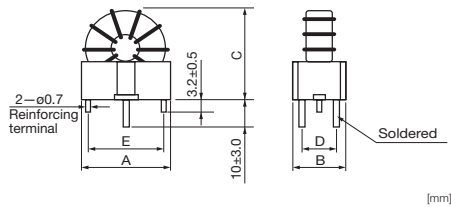

Impedance Characteristics

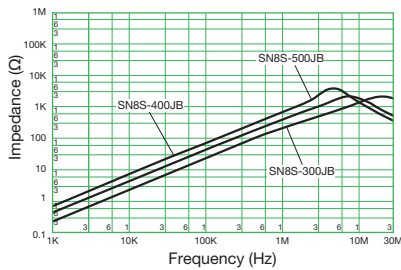
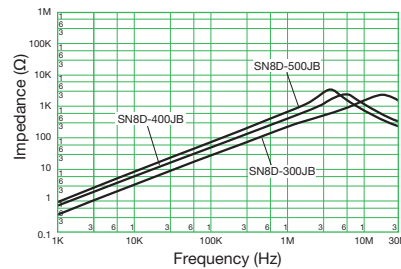
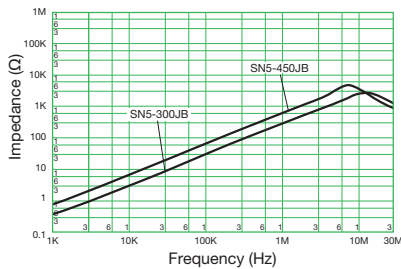

- All specifications in this catalog and production status of products are subject to change without notice. Prior to the purchase, please contact TOKIN for updated product data.
- Please request for a specification sheet for detailed product data prior to the purchase.
- Before using the product in this catalog, please read "Precautions" and other safety precautions listed in the printed version catalog.

SN Coils

Terminal Base Type – P2 Type

[RoHS Compliant]



Model	Rated current (A)	Inductance (μH) min.	DC resistance (Ω) max.	Temperature rise (K) max.	Finished dimensions (mm)				Wire size (mmφ)	Weight approx. (g)
					A (max.)	B (max.)	C (max.)	D (max.)		
SN5-30P2	2	25	0.046	18	17.0	14.0	9.0	12.7	0.55	3
SN5-40P2	2	48	0.065	22	17.0	14.0	9.0	12.7	0.55	3.5
SN8S-30P2	2	26	0.050	19	19.0	17.0	10.5	15.2	0.60	5
SN8S-40P2	2	46	0.060	20	19.0	17.0	10.5	15.2	0.60	5.2
SN8S-50P2	2	72	0.075	23	19.0	17.0	10.5	15.2	0.60	5.5

- Operating temperature range(°C): -25 to T (T=105-temperature rise) • Wire type:1 PVF, 1 UEW or 1 PEW
- Inductance measurement condition: at 100kHz, 1mA, KC547 • Thermal class: A (105°C)

Shape and Dimensions

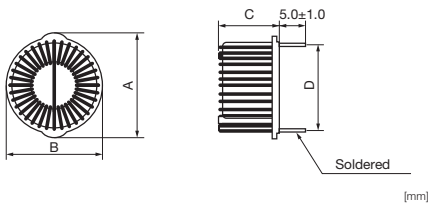

Impedance Characteristics

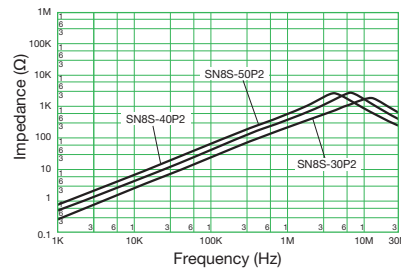
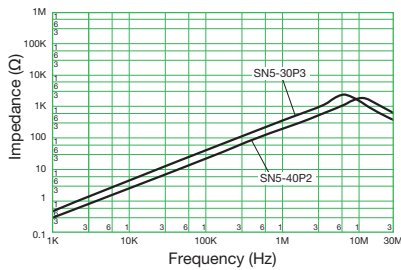

- All specifications in this catalog and production status of products are subject to change without notice. Prior to the purchase, please contact TOKIN for updated product data.
- Please request for a specification sheet for detailed product data prior to the purchase.
- Before using the product in this catalog, please read "Precautions" and other safety precautions listed in the printed version catalog.

SHB Coils (Booster Coils for Active Filters)

[RoHS Compliant]



Model	Rated current (A)	Inductance (μH)		DC resistance (mΩ) max.	Dimensions D×H (mm) max.	Wire size (mmφ)	Weight approx. (g)
		I = 0 ±20%	I = rated min.				
SHB-02-1000V	2	1640	750	450	35×20	0.6	40
SHB-03-500V	3	850	375	180	32×20	0.8	45
SHB-03-700V	3	1150	525	230	43×22	0.8	65
SHB-04-300V	4	600	225	123	35×20	0.9	45
SHB-04-500V	4	950	375	170	40×22	0.9	65
SHB-05-300V	5	680	225	98	43×22	1.1	70
SHB-05-650V	5	1330	488	150	53×30	1.1	120
SHB-08-150V	8	440	113	58	43×22	1.3	75
SHB-08-350V	8	930	263	100	53×30	1.3	125
SHB-08-650V	8	1170	488	104	56×33	1.3	205
SHB-10-200V	10	570	150	50	53×30	1.6	135
SHB-10-400V	10	700	300	50	56×33	1.6	215
SHB-15-100V	15	400	75	33	53×30	1.8	135
SHB-15-200V	15	400	150	35	57×33	1.8	210
SHB-20-35V	20	74	26	12	53×30	1.1×4	115
SHB-20-60V	20	105	45	15	60×33	1.1×4	195
SHB-30-17V	30	36	13	7	53×30	1.4×4	120
SHB-30-20V	30	44	15	7	60×33	1.4×4	200

- Operating temperature range(°C): -25 to T (T=120-temperature rise) • Wire type:1 PVF, 1 UEW or 1 PEW
- Inductance measurement condition: at 100kHz, 1mA, KC547 • Thermal class: E (120°C)

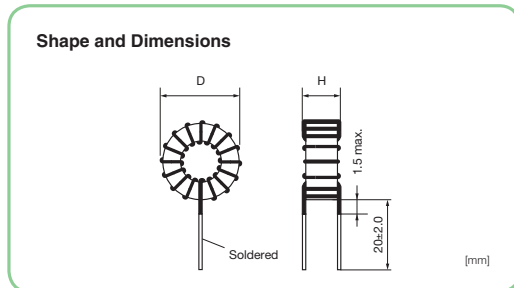

- All specifications in this catalog and production status of products are subject to change without notice. Prior to the purchase, please contact TOKIN for updated product data.
- Please request for a specification sheet for detailed product data prior to the purchase.
- Before using the product in this catalog, please read "Precautions" and other safety precautions listed in the printed version catalog.

DC-Superposed Characteristics

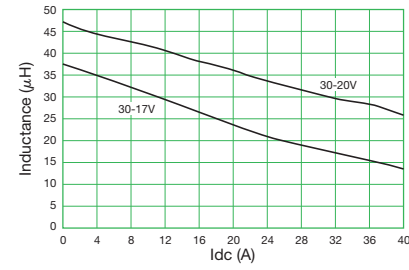
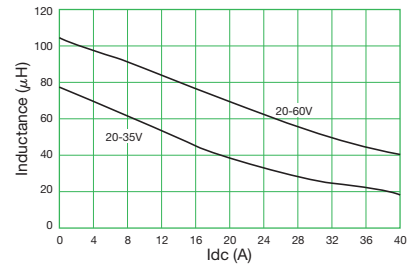
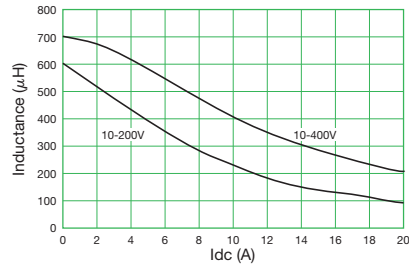
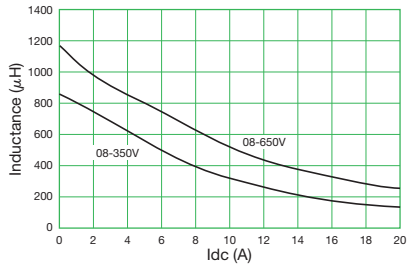
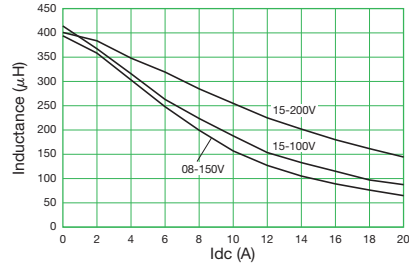
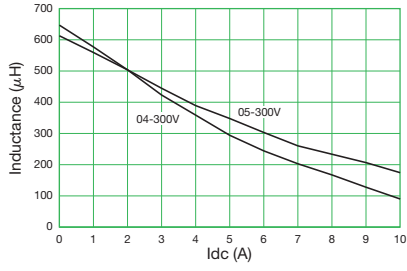
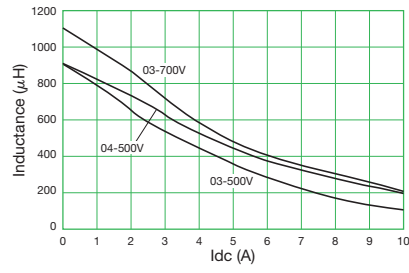
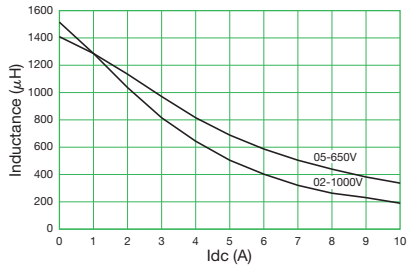

- All specifications in this catalog and production status of products are subject to change without notice. Prior to the purchase, please contact TOKIN for updated product data.
- Please request for a specification sheet for detailed product data prior to the purchase.
- Before using the product in this catalog, please read "Precautions" and other safety precautions listed in the printed version catalog.

Precautions

Shelf Life

The warranty period for unopened products is 6 months from the date of production. If use of the product is planned after this period, make sure to check to confirm that there are no problems with the solder wettability of the pins, before use.

Precautions for product storage

Storage condition

- Store at a temperature of 40°C or lower and humidity of 70% RH or lower
- Avoid storage in high temperature and high humidity environment as such condition may deteriorate the solderability of external electrode. And do not expose to direct sunlight.
- Avoid storage in atmosphere containing toxic gasses or acid (e.g. sulfur and chlorine) as such gas may deteriorate the solderability of external electrode.
- Avoid storage near strong magnetic field as such condition may magnetize the product.

Product temperature rise values

The values listed for temperature rise in this catalog are the result of self-heating in wires when the rated current (commercial frequency) is applied.

Check and evaluate the value of the core temperature rise under actual operating conditions when using.



- All specifications in this catalog and production status of products are subject to change without notice. Prior to the purchase, please contact TOKIN for updated product data.
- Please request for a specification sheet for detailed product data prior to the purchase.
- Before using the product in this catalog, please read "Precautions" and other safety precautions listed in the printed version catalog.

Precautions



- The names of the products and the specifications in this catalog are subject to change without notice for the sake of improvement. The manufacturer also reserves the right to discontinue any of these products. At the time of delivery, please ask for specifications sheets to check the contents in order to use the products properly and safely.
- Descriptions in this catalog regarding product characteristics and quality are based solely on discrete components. When using these components, be sure to check the specifications with the component in question mounted on the products.
- The manufacturer's warranty will not cover any disadvantage or damage caused by improper use of the products that deviates from the characteristics, specifications, or conditions for use described in this catalog.
- The products in this catalog are intended for use in ordinary electronic products. If any of these products are to be used in special applications requiring extremely high reliability, such as in aviation equipment and nuclear power controllers where product defects might pose a safety risk, please consult your TOKIN sales representatives.
- Though the manufacturer has taken all possible precautions to ensure the quality and reliability of its products, improper use of products may result in bodily injury, fire, or similar accident. If you have any questions regarding the use of the products in question, please consult your TOKIN sales representatives.
- Please be advised that the manufacturer accepts no responsibility for any infraction by users of the manufacturer's products on third party patents or industrial copyrights. The manufacturer is responsible only when such infractions are attributable to the structural design of the product and its manufacturing process.
- Export Control
For customers outside Japan
TOKIN products should not be used or sold for use in the development, production, stockpiling or utilization of any conventional weapons or mass-destructive weapons(nuclear weapons, chemical or biological weapons, or missiles), or any other weapons.
For customers in Japan
For products which are controlled items subject to the "Foreign Exchange and Foreign Trade Law" of Japan, the export license specified by the law is required for export.
- This catalog is current as of April 2017.



- All specifications in this catalog and production status of products are subject to change without notice. Prior to the purchase, please contact TOKIN for updated product data.
- Please request for a specification sheet for detailed product data prior to the purchase.
- Before using the product in this catalog, please read "Precautions" and other safety precautions listed in the printed version catalog.

Mouser Electronics

Authorized Distributor

Click to View Pricing, Inventory, Delivery & Lifecycle Information:

KEMET:

[SCR31B-105-1R4A055JH](#) [SCR31B-200-1R9A017JH](#) [SCR31HA-045-0R8A080JH-P](#) [SCR31H-225-2R0A014J](#)
[SCR31HA-120-1R3A012H](#) [SCR31HA-070-1R1A039JH-P](#)



Компания «ЭлектроПласт» предлагает заключение долгосрочных отношений при поставках импортных электронных компонентов на взаимовыгодных условиях!

Наши преимущества:

- Оперативные поставки широкого спектра электронных компонентов отечественного и импортного производства напрямую от производителей и с крупнейших мировых складов;
- Поставка более 17-ти миллионов наименований электронных компонентов;
- Поставка сложных, дефицитных, либо снятых с производства позиций;
- Оперативные сроки поставки под заказ (от 5 рабочих дней);
- Экспресс доставка в любую точку России;
- Техническая поддержка проекта, помощь в подборе аналогов, поставка прототипов;
- Система менеджмента качества сертифицирована по Международному стандарту ISO 9001;
- Лицензия ФСБ на осуществление работ с использованием сведений, составляющих государственную тайну;
- Поставка специализированных компонентов (Xilinx, Altera, Analog Devices, Intersil, Interpoint, Microsemi, Aeroflex, Peregrine, Syfer, Eurofarad, Texas Instrument, Miteq, Cobham, E2V, MA-COM, Hittite, Mini-Circuits, General Dynamics и др.);

Помимо этого, одним из направлений компании «ЭлектроПласт» является направление «Источники питания». Мы предлагаем Вам помощь Конструкторского отдела:

- Подбор оптимального решения, техническое обоснование при выборе компонента;
- Подбор аналогов;
- Консультации по применению компонента;
- Поставка образцов и прототипов;
- Техническая поддержка проекта;
- Защита от снятия компонента с производства.



Как с нами связаться

Телефон: 8 (812) 309 58 32 (многоканальный)

Факс: 8 (812) 320-02-42

Электронная почта: org@eplast1.ru

Адрес: 198099, г. Санкт-Петербург, ул. Калинина, дом 2, корпус 4, литера А.