

# DUAL OUTPUT STRATUM-III SMD TCXO & VCTCXO

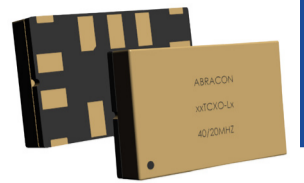

9.0 x 14.0 x 3.0mm

**Pb** RoHS/RoHS II Compliant

**ESD SENSITIVE**

MSL = 3

ABDFTCXO/ABDFVCTCXO SERIES

## FEATURES

- Phase and frequency coherent dual output
- F0 and F0÷2 with integrated precision fanout buffers
- Meets ±280ppb Stratum-III stability requirements
- Excellent ±1ppm aging with ±4.6ppm guaranteed lifetime accuracy
- 5 to 52MHz standard and custom frequencies available
- TCXO or VCTCXO functionality available
- ±5ppm minimum pull with 0.5% typ linearity (VCTCXO only)
- LVC MOS outputs
- 10pin package
- -40°C to 85°C operation

## APPLICATIONS

- Communications and Networking
- Synchronization
- PLL with Holdover
- Geolocation, RTLS, GPS
- Synchronous Ethernet
- IEEE1588
- Instrumentation, test and measurement
- Femtocells, picocells (BTS)
- Oil and gas exploration

## TYPICAL OPERATING CIRCUIT

### DIGITAL FPGA BASED PLL WITH PRECISION STRATUM-III HOLDOVER

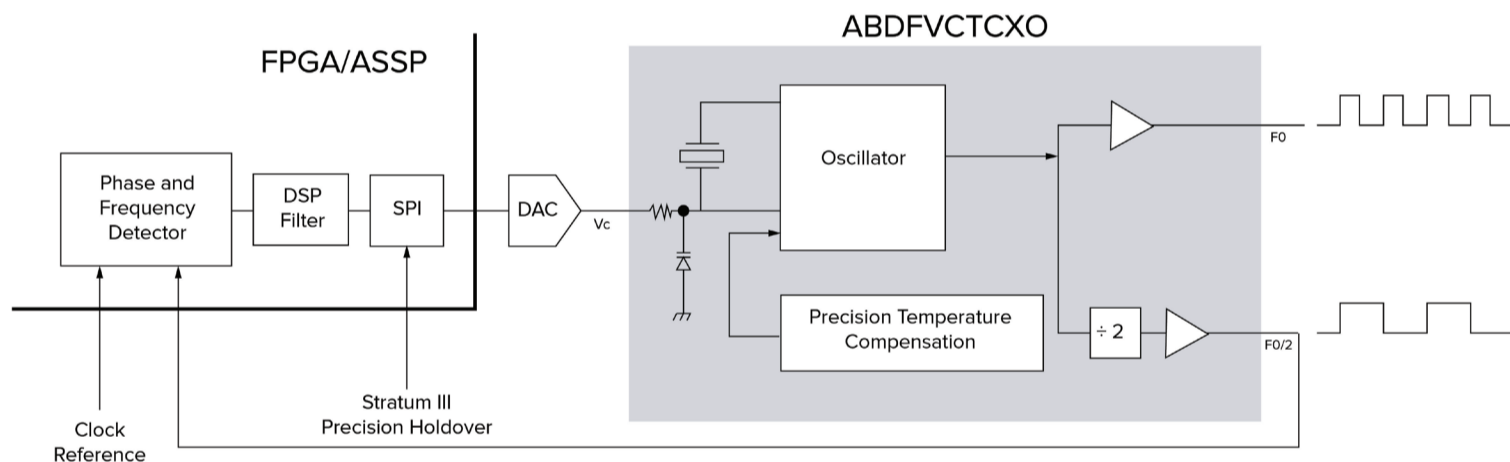

## OPTIONS AND PART IDENTIFICATION

ABDFTCXO OR ABDFVCTCXO - [ ] MHz - [ ] - [ ] - [ ]

**OUTPUT 1 (F<sub>0</sub>) IN MHZ**  
Please specify the frequency  
Output 1 (F0) in MHz e.g.  
16.384MHz

\*F0 > 40MHz, available in Q4-2017

**OPERATING TEMP. RANGE**  
E: -20°C to +70°C  
L: -40°C to +85°C

**FREQ. STABILITY**  
1: ±100ppb\*  
2: ±280ppb

\*Available Q4-2017

**PACKAGING**  
Blank: Bulk\*\*  
T5: 500 pcs/reel  
T2: 250 pcs/reel  
CT: Cut Tape\*\*\*

\*\*Bulk devices are not in MSL-3 compliant packaging

\*\*\*Cut Tape devices available in 25pc, 50pc, & 100pc quantities (MSL-3 compliant)



5101 Hidden Creek Ln Spicewood TX 78669  
Phone: 512-371-6159 | Fax: 512-351-8858  
For terms and conditions of sales, please visit:  
www.abracon.com

REVISED: 05.19.2017

ABRACON IS  
ISO9001-2008  
CERTIFIED

# DUAL OUTPUT STRATUM-III SMD TCXO & VCTCXO

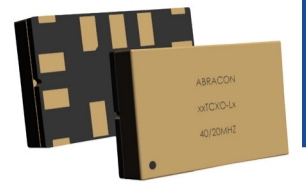

ABDFTCXO/ABDFVCTCXO SERIES

9.0 x 14.0 x 3.0mm

RoHS/RoHS II Compliant

ESD SENSITIVE

MSL = 3

## STANDARD SPECIFICATIONS

PARAMETERS	RATING
Storage Temperature Range (Ts)	-55°C to +125°C
Supply Voltage (Vdd)	-0.5V to 6V
Control Voltage (Vc)	0V to 3V
ESD, HBM/CDM/MM	4kV/2kV/200V

PARAMETERS	MINIMUM	TYPICAL	MAXIMUM	UNITS	NOTES
Frequency Range	5.000		52.000	MHz	
Standard Frequencies [Output 1(F <sub>0</sub> )/Output 2 (F <sub>0</sub> /2)]	10.000/5.000 16.384/8.192 20.000/10.000 26.000/13.000 38.400/19.200 50.000/25.000	12.800/6.400 19.200/9.600 24.576/12.288 30.000/15.000 38.880/19.440 52.000/26.000	16.000/8.000 19.440/9.720 25.000/12.500 30.720/15.360 40.000/20.000	MHz	Custom frequencies available upon request. Please contact Abracon. *Note 1
Supply Voltage (Vdd)	+3.135	+3.3	+3.465	V	
Supply Current (Icc) (into 15pF load )			20	mA	Carrier dependent
Initial Frequency Tolerance @ +25°C	-0.50		+0.50	ppm	As received, Relative to carrier
Operating Temperature	-20		+70	°C	Option "E"
	-40		+85		Option "L"
Frequency Stability vs. Operating Temperature ( ref. to +25°C )	-100		+100	ppb	Option "1" *Note 2
	-280		+280	ppb	Option "2"
Frequency Stability vs. Vdd Change	-100		+100	ppb	Vdd ±5%
Frequency Stability vs. Load Change	-200		+200	ppb	Load ±5%
Aging (1 <sup>st</sup> year @ +25°C)	-1.0		+1.0	ppm	
Aging (10 years @ +25°C)	-3.0		+3.0	ppm	
All-inclusive frequency stability over 10 years product life (Stratum-III Compliant)	-4.60		+4.60	ppm	
<b>LVC MOS Output (Square wave)</b>					
V <sub>OH</sub>	2.4			V	Load = 15pF
V <sub>OL</sub>			0.4	V	Load = 15pF
Load			15	pF	
Duty Cycle	45		55	%	@ (V <sub>OH</sub> - V <sub>OL</sub> )/2
Rise/Fall Time			6	ns	Load = 15pF
<b>Control Port (Applicable for VCTCXO only)</b>					
Center Control Voltage (Vc)		+1.50		V	
Control Voltage Range (Vc)	+0.50		+2.50	V	
Frequency Pull	±5.00		< ±13.00	ppm	Vc = 1.5V±1.0V
Tuning Slope		Positive			
Linearity Error		< 0.5	10	%	

\*Note 1: F<sub>0</sub> > 40MHz, available in Q4-2017 | \*Note 2: Available Q4-2017

# DUAL OUTPUT STRATUM-III SMD TCXO & VCTCXO

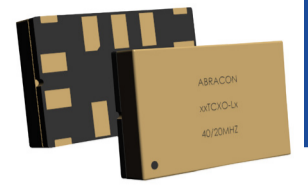

ABDFTCXO/ABDFVCTCXO SERIES

9.0 x 14.0 x 3.0mm

RoHS/RoHS II Compliant

ESD SENSITIVE

MSL = 3

## STANDARD SPECIFICATIONS (CONT.)

PARAMETERS	MINIMUM	TYPICAL	MAXIMUM	UNITS	NOTES
<b>RMS Jitter (12kHz ~ 20MHz BW) @ 25°C</b>					
16.384 MHz Carrier		650	1,300	fs	
20.000 MHz Carrier		525	1,300	fs	
10.000 MHz Carrier		650	1,300	fs	
26.000 MHz Carrier		450	1,300	fs	
13.000 MHz Carrier		775	1,300	fs	
40.000 MHz Carrier		325	1,300	fs	
20.000 MHz Carrier		450	1,300	fs	
<b>Phase Noise</b>					
F <sub>0</sub> @ 20.000 MHz		-85		dBc/Hz	Offset @10Hz
		-100			Offset @100Hz
		-135			Offset @1kHz
		-145			Offset @10kHz
		-150			Offset @100kHz
		-155			Offset @ 5MHz
F <sub>0</sub> /2 @ 10.000 MHz		-90		dBc/Hz	Offset @10Hz
		-100			Offset @100Hz
		-135			Offset @1kHz
		-145			Offset @10kHz
		-150			Offset @100kHz
		-155			Offset @ 5MHz
F <sub>0</sub> @ 26.000 MHz		-85		dBc/Hz	Offset @10Hz
		-100			Offset @100Hz
		-135			Offset @1kHz
		-145			Offset @10kHz
		-150			Offset @100kHz
		-150			Offset @ 5MHz
F <sub>0</sub> /2 @ 13.000 MHz		-75		dBc/Hz	Offset @10Hz
		-100			Offset @100Hz
		-135			Offset @1kHz
		-150			Offset @10kHz
		-150			Offset @100kHz
		-155			Offset @ 5MHz
F <sub>0</sub> @ 40.000 MHz		-80		dBc/Hz	Offset @10Hz
		-100			Offset @100Hz
		-125			Offset @1kHz
		-140			Offset @10kHz
		-150			Offset @100kHz
		-150			Offset @ 5MHz
F <sub>0</sub> /2 @ 20.000 MHz		-80		dBc/Hz	Offset @10Hz
		-100			Offset @100Hz
		-135			Offset @1kHz
		-140			Offset @10kHz
		-145			Offset @100kHz
		-155			Offset @ 5MHz



5101 Hidden Creek Ln Spicewood TX 78669  
 Phone: 512-371-6159 | Fax: 512-351-8858  
 For terms and conditions of sales, please visit:  
[www.abracon.com](http://www.abracon.com)

REVISED: 05.19.2017

ABRACON IS  
 ISO9001-2008  
 CERTIFIED

# DUAL OUTPUT STRATUM-III SMD TCXO & VCTCXO

ABDFTCXO/ABDFVCTCXO SERIES

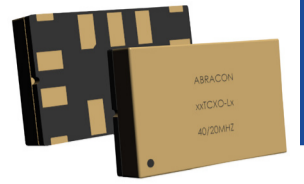

9.0 x 14.0 x 3.0mm

**Pb** RoHS/RoHS II Compliant

**ESD SENSITIVE**

MSL = 3

## TYPICAL PHASE NOISE & JITTER CHARACTERISTICS

**16.384MHz**  
[Output 1 (F0)]

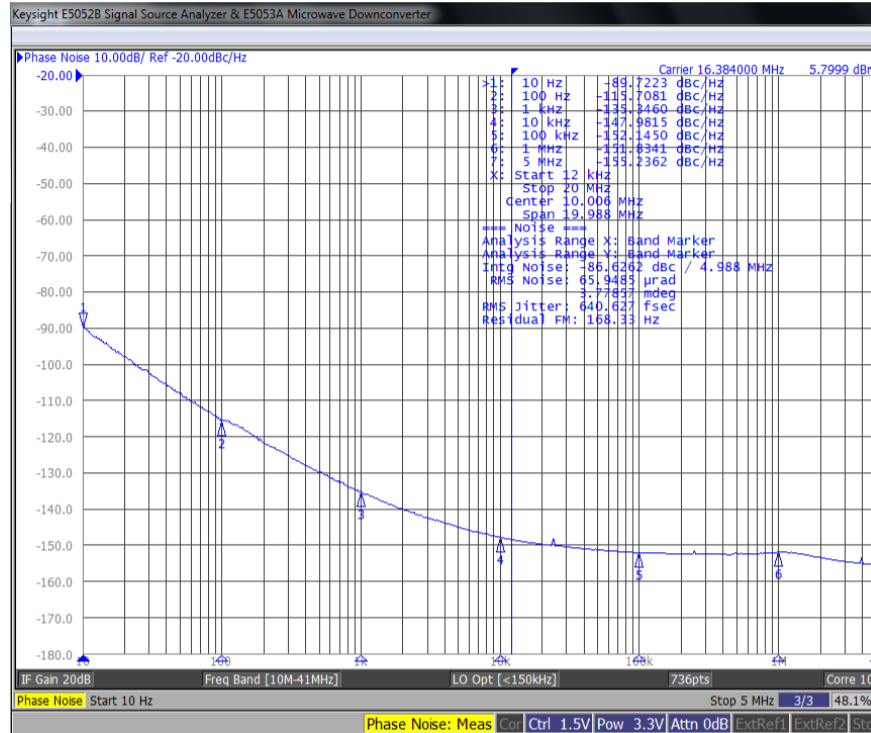

**20.000MHz / 10.000MHz**  
[Output 1 (F0) / Output 2 (F0/2)]

**20.000MHz**

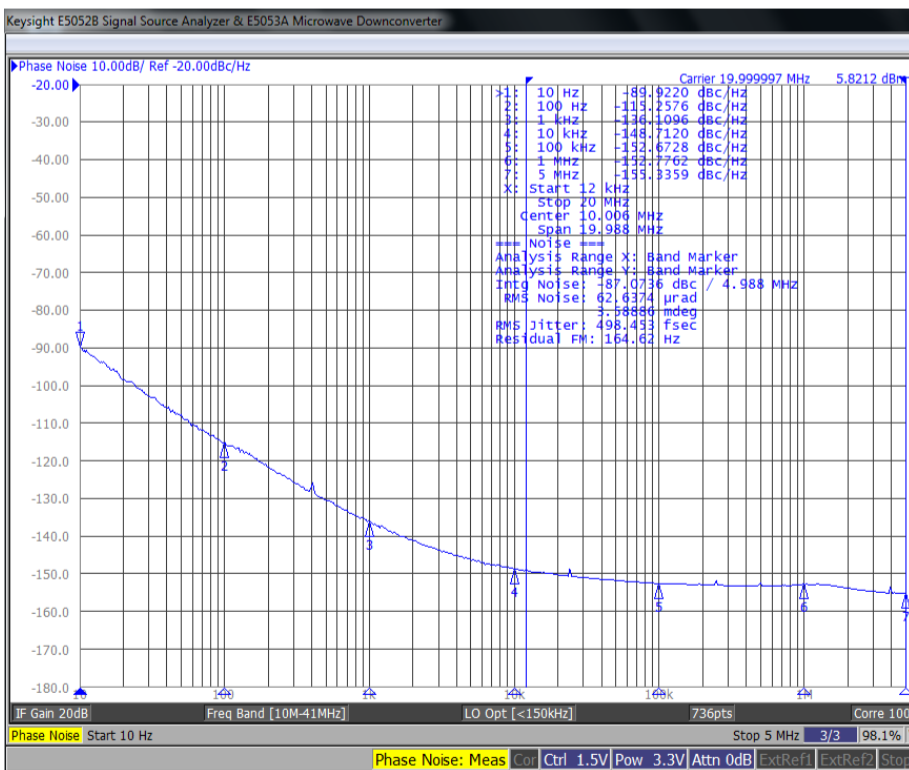

**10.000MHz**

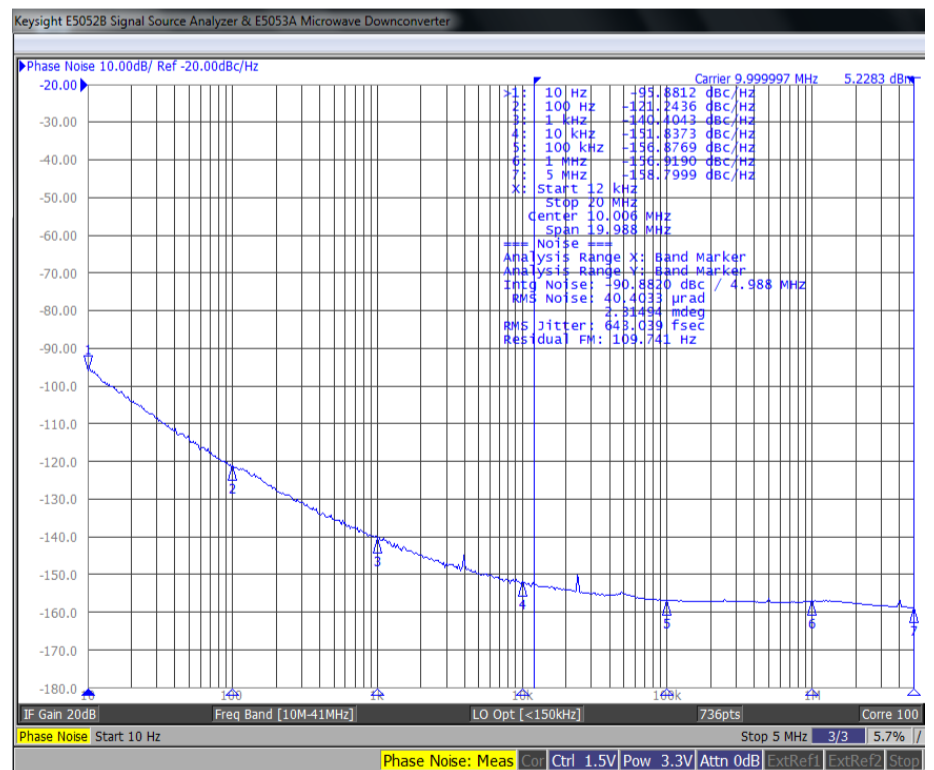

REVISED: 05.19.2017



5101 Hidden Creek Ln Spicewood TX 78669  
Phone: 512-371-6159 | Fax: 512-351-8858  
For terms and conditions of sales, please visit:  
[www.abracon.com](http://www.abracon.com)

ABRACON IS  
ISO9001-2008  
CERTIFIED

# DUAL OUTPUT STRATUM-III SMD TCXO & VCTCXO

ABDFTCXO/ABDFVCTCXO SERIES

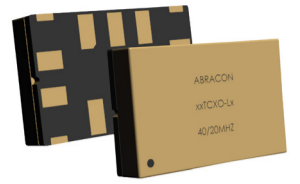

9.0 x 14.0 x 3.0mm

**Pb** RoHS/RoHS II Compliant

**ESD SENSITIVE**

MSL = 3

## TYPICAL PHASE NOISE & JITTER CHARACTERISTICS

**26.000MHz / 13.000MHz**  
 [Output 1 (F0) / Output 2 (F0/2)]

**26.000MHz**

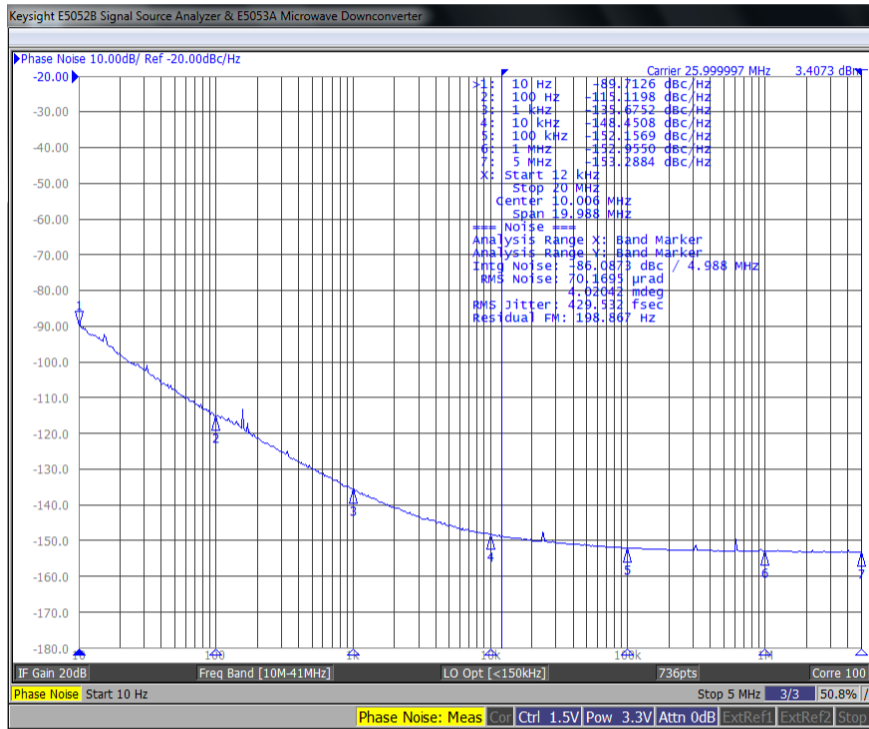

**13.000MHz**

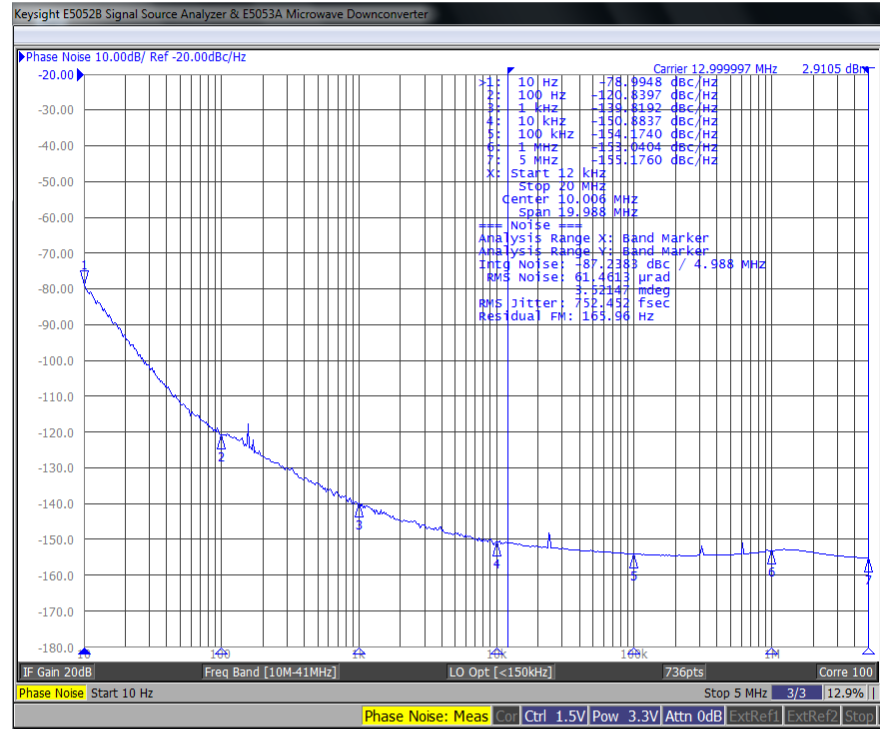

**40.000MHz**

**40.000MHz / 20.000MHz**  
 [Output 1 (F0) / Output 2 (F0/2)]

**20.000MHz**

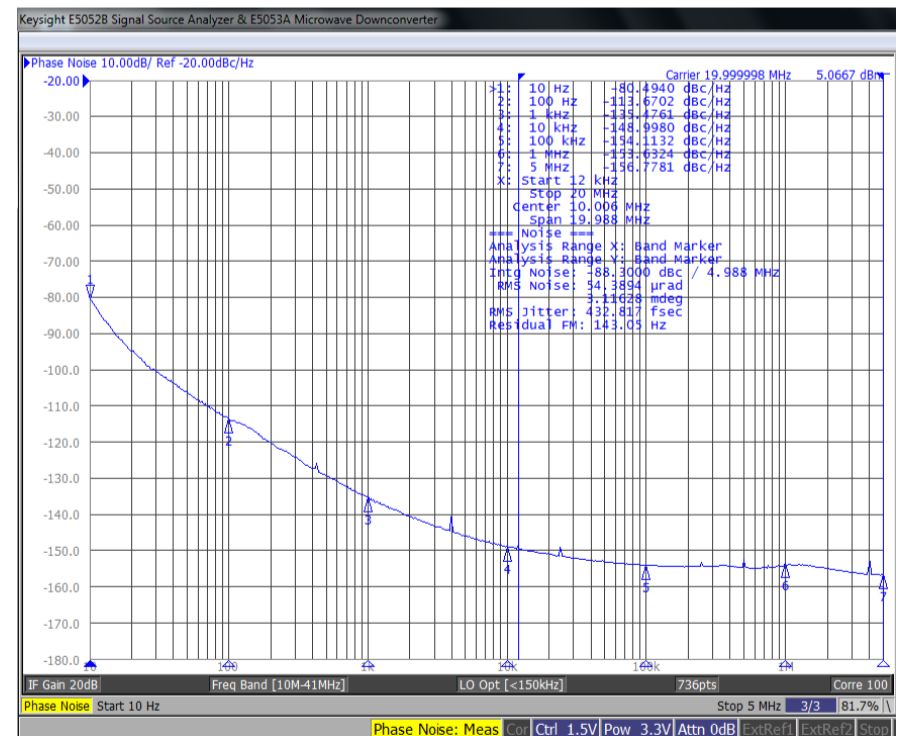
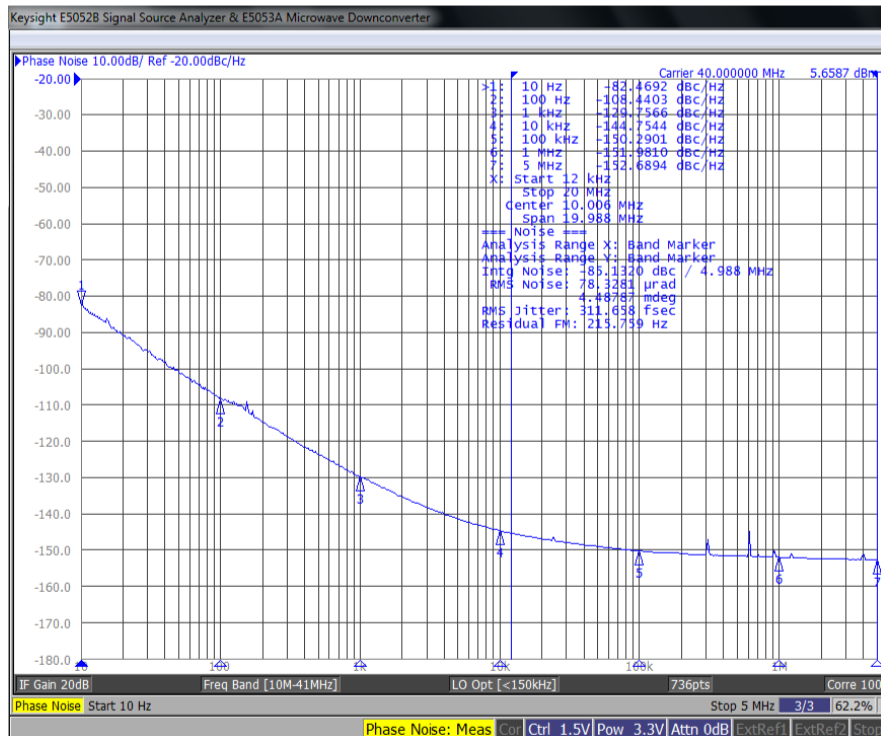

Frequency	16.384MHz	20MHz	10MHz	26MHz	13MHz	40MHz	20MHz
Typical rms Phase Jitter (12kHz to 20MHz BW)	640 fs	498 fs	643 fs	429 fs	752 fs	311 fs	432 fs

REVISED: 05.19.2017



5101 Hidden Creek Ln Spicewood TX 78669  
 Phone: 512-371-6159 | Fax: 512-351-8858  
 For terms and conditions of sales, please visit:  
[www.abracon.com](http://www.abracon.com)

ABRACON IS  
 ISO9001-2008  
 CERTIFIED

# DUAL OUTPUT STRATUM-III SMD TCXO & VCTCXO

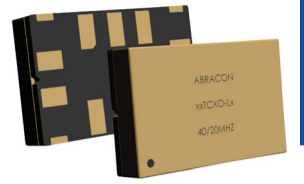

ABDFTCXO/ABDFVCTCXO SERIES

9.0 x 14.0 x 3.0mm

RoHS/RoHS II Compliant

ESD SENSITIVE

MSL = 3

## FREQUENCY STABILITY VS. TEMPERATURE

## FREQUENCY PULL VS. CONTROL VOLTAGE (VCTCXO MODE)

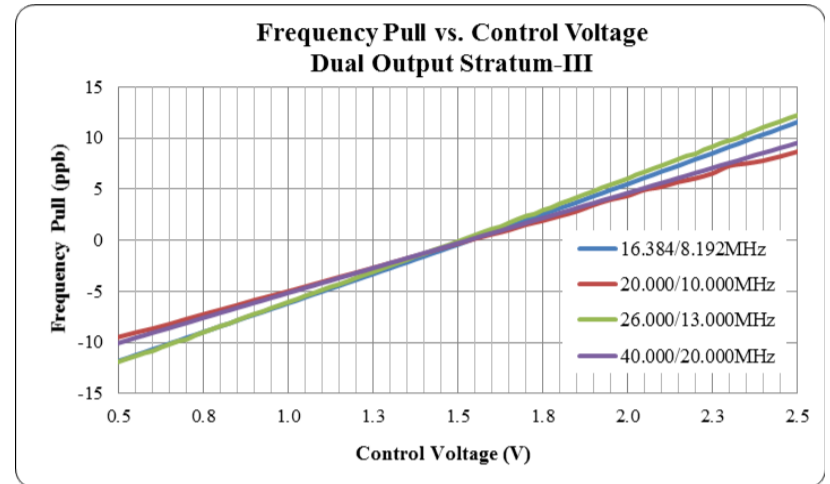
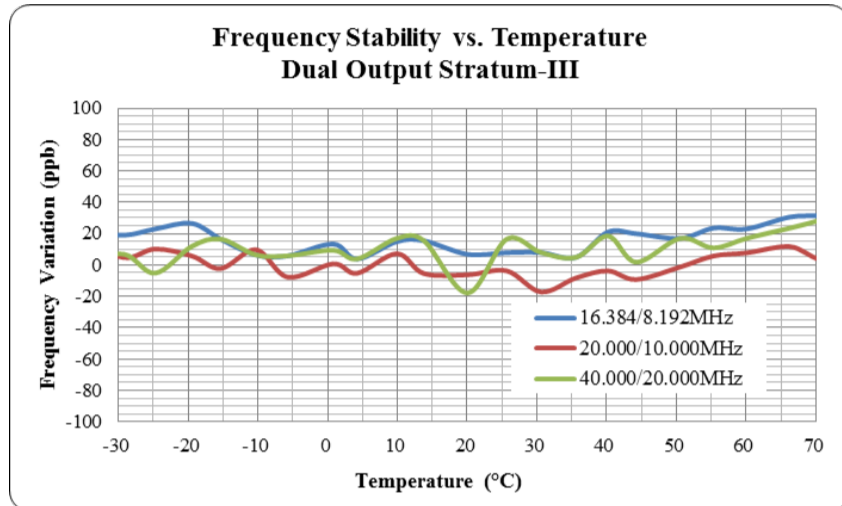

## AGING PROFILE (ACCELERATED AGING @ +85°C)

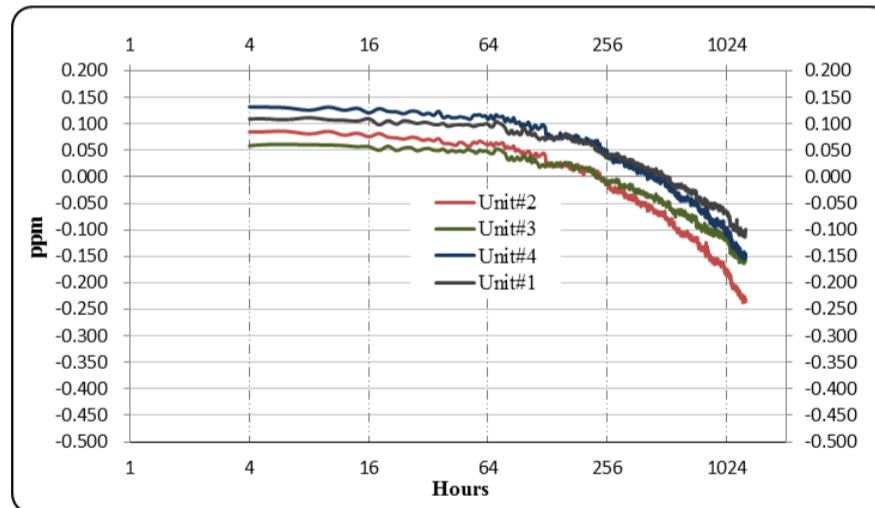

# DUAL OUTPUT STRATUM-III SMD TCXO & VCTCXO

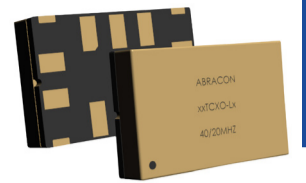

ABDFTCXO/ABDFVCTCXO SERIES

9.0 x 14.0 x 3.0mm

RoHS/RoHS II Compliant

ESD SENSITIVE

MSL = 3

## TYPICAL PHASE NOISE & JITTER CHARACTERISTICS

### RECOMMENDED LAND PATTERN

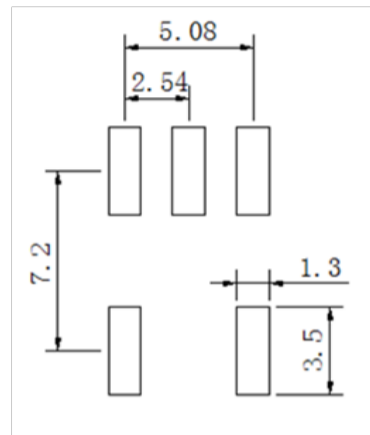
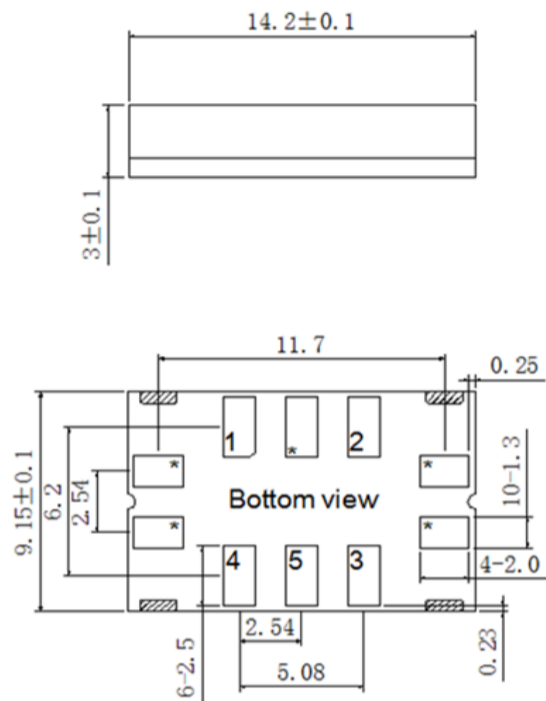

Pin	Function
1	NC (for TCXO) Vc (for VCTCXO)
2	GND
3	Output #1 (F0)
4	Vdd
5	Output #2 (F0/2)
*	For factory test only

Dimensions: mm

### REFLOW PROFILE

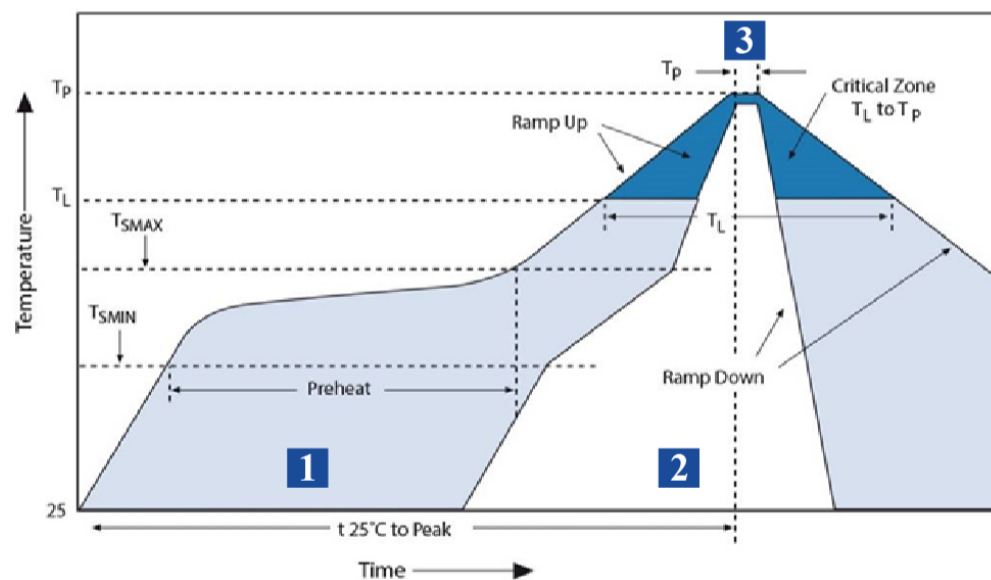

Zone	Description	Temperature	Time
1	Preheat	$T_{SMIN} \sim T_{SMAX}$ 150°C ~ 200°C	60 ~ 120 sec.
2	Reflow	$T_L$ 220°C	60 ~ 150 sec.
3	Peak Heat	$T_P$ 260°C	25 sec. MAX

# DUAL OUTPUT STRATUM-III SMD TCXO & VCTCXO

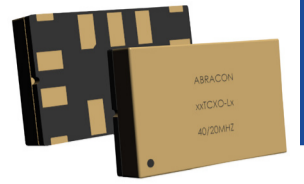

ABDFTCXO/ABDFVCTCXO SERIES

9.0 x 14.0 x 3.0mm

RoHS/RoHS II Compliant

ESD SENSITIVE

MSL = 3

## PACKAGING

T5: 500 pcs/reel

T2: 250 pcs/reel

MSL - 3 compliant packaging applies to MOQ=25 units (cut tape) & T5 and T2 options

MSL - 3 compliant packaging DOES NOT apply to bulk quantities

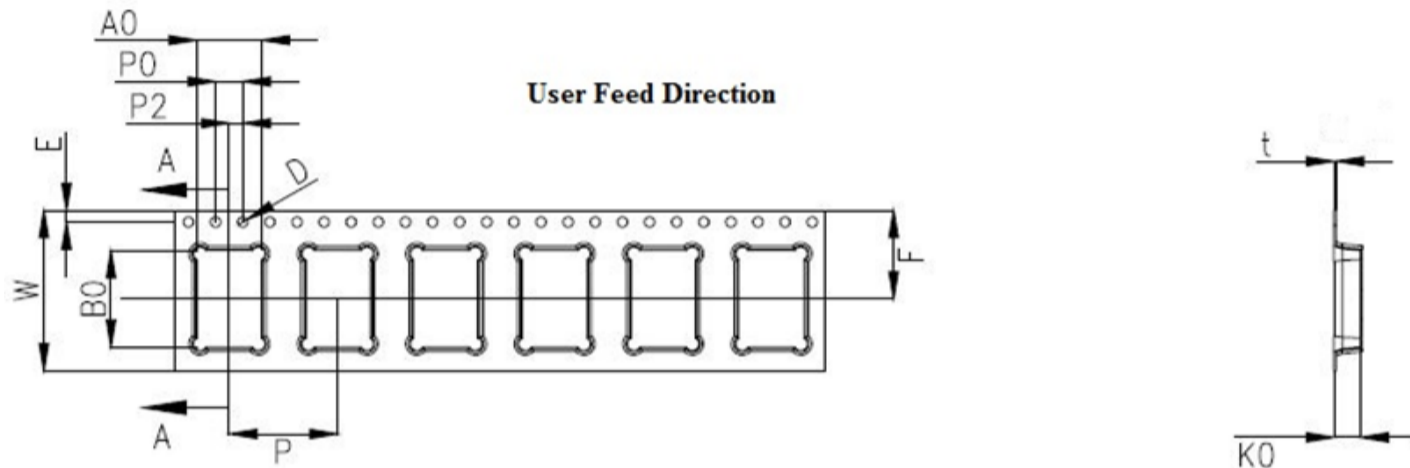

W	A0	B0	K0	P	
24.0±0.3	9.6±0.10	14.5±0.10	3.9±0.10	16.0±0.1	
F	E	D	P0	P2	T
13.25±0.1	1.75±0.1	1.5±0.1	4.0±0.1	2.0±0.1	0.3±0.05

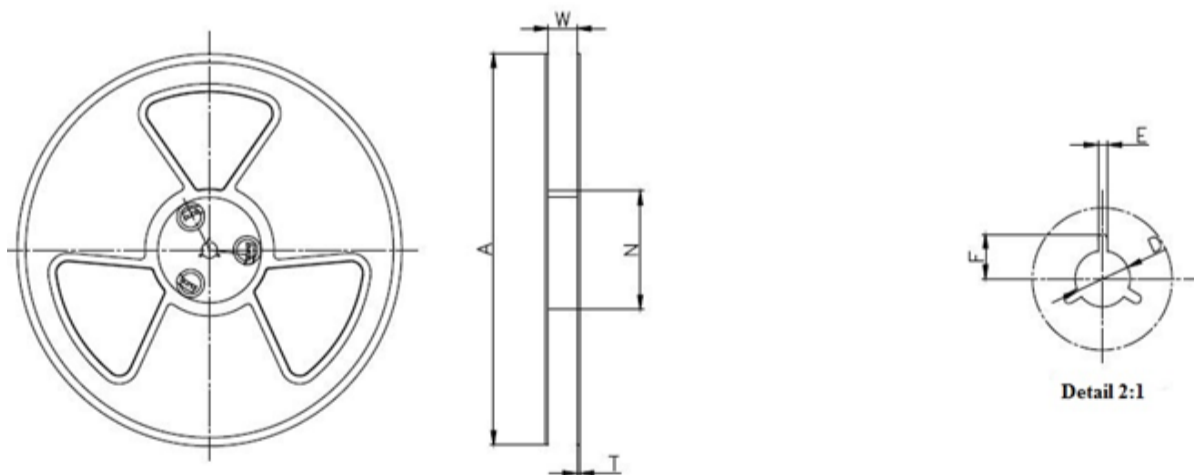

W	A	N	T	E	F	D
24.5±0.4	330±0.5	100±0.3	1.8±0.2	2.1±0.3	10.75±0.3	13.5+0.5/-0.2

Dimensions: mm



# Mouser Electronics

Authorized Distributor

Click to View Pricing, Inventory, Delivery & Lifecycle Information:

## ABRACON:

[ABDFTCXO-26.000MHz-L-2-CT](#) [ABDFTCXO-16.384MHz-E-2-T5](#) [ABDFTCXO-20.000MHz-E-2-T2](#) [ABDFTCXO-25.000MHz-L-2-T5](#) [ABDFTCXO-30.720MHz-E-2-T2](#) [ABDFVCTCXO-50.000MHz-L-2-T2](#) [ABDFVCTCXO-26.000MHz-L-2-T5](#) [ABDFVCTCXO-52.000MHz-E-2-CT](#) [ABDFTCXO-19.200MHz-L-2-T5](#) [ABDFVCTCXO-16.000MHz-L-2-T2](#) [ABDFVCTCXO-26.000MHz-E-2-T2](#) [ABDFTCXO-40.000MHz-L-2-CT](#) [ABDFTCXO-52.000MHz-E-2-T5](#) [ABDFVCTCXO-24.576MHz-E-2-T2](#) [ABDFTCXO-19.440MHz-L-2-CT](#) [ABDFVCTCXO-16.000MHz-L-2-T5](#) [ABDFVCTCXO-38.400MHz-L-2-T2](#) [ABDFTCXO-10.000MHz-E-2-T2](#) [ABDFVCTCXO-52.000MHz-E-2-T2](#) [ABDFVCTCXO-10.000MHz-L-2-CT](#) [ABDFVCTCXO-50.000MHz-E-2-T2](#) [ABDFTCXO-19.200MHz-E-2-T2](#) [ABDFTCXO-38.880MHz-E-2-T2](#) [ABDFTCXO-10.000MHz-E-2-T5](#) [ABDFTCXO-38.880MHz-L-2-CT](#) [ABDFTCXO-50.000MHz-L-2-T2](#) [ABDFTCXO-19.200MHz-L-2-CT](#) [ABDFTCXO-50.000MHz-E-2-CT](#) [ABDFVCTCXO-16.000MHz-E-2-T5](#) [ABDFVCTCXO-16.384MHz-E-2-T2](#) [ABDFTCXO-30.000MHz-L-2-T2](#) [ABDFTCXO-26.000MHz-L-2-T5](#) [ABDFVCTCXO-38.400MHz-E-2-T5](#) [ABDFTCXO-30.000MHz-L-2-T5](#) [ABDFVCTCXO-40.000MHz-E-2-CT](#) [ABDFTCXO-19.200MHz-L-2-T2](#) [ABDFVCTCXO-25.000MHz-L-2-T2](#) [ABDFVCTCXO-16.000MHz-E-2-CT](#) [ABDFTCXO-12.800MHz-L-2-T5](#) [ABDFVCTCXO-16.384MHz-E-2-CT](#) [ABDFVCTCXO-52.000MHz-L-2-T5](#) [ABDFVCTCXO-20.000MHz-L-2-T5](#) [ABDFTCXO-38.880MHz-E-2-CT](#) [ABDFTCXO-24.576MHz-E-2-T5](#) [ABDFVCTCXO-25.000MHz-L-2-CT](#) [ABDFTCXO-20.000MHz-E-2-CT](#) [ABDFTCXO-25.000MHz-L-2-T2](#) [ABDFTCXO-19.200MHz-E-2-T5](#) [ABDFVCTCXO-40.000MHz-L-2-T5](#) [ABDFTCXO-19.440MHz-L-2-T2](#) [ABDFTCXO-30.720MHz-L-2-CT](#) [ABDFVCTCXO-10.000MHz-E-2-T2](#) [ABDFTCXO-19.440MHz-E-2-T5](#) [ABDFVCTCXO-24.576MHz-L-2-T5](#) [ABDFTCXO-10.000MHz-L-2-T2](#) [ABDFVCTCXO-30.720MHz-E-2-T2](#) [ABDFTCXO-25.000MHz-E-2-T5](#) [ABDFTCXO-40.000MHz-E-2-CT](#) [ABDFVCTCXO-12.800MHz-E-2-T5](#) [ABDFVCTCXO-24.576MHz-L-2-T2](#) [ABDFVCTCXO-50.000MHz-E-2-T5](#) [ABDFTCXO-38.400MHz-E-2-CT](#) [ABDFVCTCXO-40.000MHz-E-2-T2](#) [ABDFTCXO-26.000MHz-L-2-T2](#) [ABDFVCTCXO-26.000MHz-E-2-T5](#) [ABDFVCTCXO-50.000MHz-E-2-CT](#) [ABDFVCTCXO-38.880MHz-L-2-T5](#) [ABDFVCTCXO-30.000MHz-L-2-T5](#) [ABDFTCXO-40.000MHz-L-2-T5](#) [ABDFVCTCXO-38.400MHz-E-2-T2](#) [ABDFVCTCXO-30.000MHz-L-2-T2](#) [ABDFVCTCXO-12.800MHz-L-2-T2](#) [ABDFTCXO-19.440MHz-E-2-T2](#) [ABDFTCXO-24.576MHz-E-2-T2](#) [ABDFTCXO-52.000MHz-L-2-T5](#) [ABDFTCXO-52.000MHz-E-2-CT](#) [ABDFTCXO-30.720MHz-E-2-T5](#) [ABDFTCXO-12.800MHz-E-2-T2](#) [ABDFTCXO-19.440MHz-L-2-T5](#) [ABDFTCXO-38.400MHz-E-2-T5](#) [ABDFVCTCXO-16.384MHz-L-2-T2](#) [ABDFVCTCXO-16.000MHz-L-2-CT](#) [ABDFVCTCXO-40.000MHz-L-2-T2](#) [ABDFVCTCXO-52.000MHz-L-2-T2](#) [ABDFTCXO-12.800MHz-E-2-T5](#) [ABDFTCXO-52.000MHz-E-2-T2](#) [ABDFTCXO-24.576MHz-L-2-CT](#) [ABDFTCXO-38.880MHz-E-2-T5](#) [ABDFVCTCXO-19.440MHz-E-2-CT](#) [ABDFVCTCXO-19.440MHz-L-2-T2](#) [ABDFVCTCXO-10.000MHz-E-2-CT](#) [ABDFVCTCXO-38.400MHz-L-2-T5](#) [ABDFVCTCXO-26.000MHz-E-2-CT](#) [ABDFVCTCXO-10.000MHz-L-2-T2](#) [ABDFVCTCXO-19.200MHz-L-2-CT](#) [ABDFTCXO-30.720MHz-E-2-CT](#)



Компания «ЭлектроПласт» предлагает заключение долгосрочных отношений при поставках импортных электронных компонентов на взаимовыгодных условиях!

Наши преимущества:

- Оперативные поставки широкого спектра электронных компонентов отечественного и импортного производства напрямую от производителей и с крупнейших мировых складов;
- Поставка более 17-ти миллионов наименований электронных компонентов;
- Поставка сложных, дефицитных, либо снятых с производства позиций;
- Оперативные сроки поставки под заказ (от 5 рабочих дней);
- Экспресс доставка в любую точку России;
- Техническая поддержка проекта, помощь в подборе аналогов, поставка прототипов;
- Система менеджмента качества сертифицирована по Международному стандарту ISO 9001;
- Лицензия ФСБ на осуществление работ с использованием сведений, составляющих государственную тайну;
- Поставка специализированных компонентов (Xilinx, Altera, Analog Devices, Intersil, Interpoint, Microsemi, Aeroflex, Peregrine, Syfer, Eurofarad, Texas Instrument, Miteq, Cobham, E2V, MA-COM, Hittite, Mini-Circuits, General Dynamics и др.);

Помимо этого, одним из направлений компании «ЭлектроПласт» является направление «Источники питания». Мы предлагаем Вам помощь Конструкторского отдела:

- Подбор оптимального решения, техническое обоснование при выборе компонента;
- Подбор аналогов;
- Консультации по применению компонента;
- Поставка образцов и прототипов;
- Техническая поддержка проекта;
- Защита от снятия компонента с производства.



#### Как с нами связаться

**Телефон:** 8 (812) 309 58 32 (многоканальный)

**Факс:** 8 (812) 320-02-42

**Электронная почта:** [org@eplast1.ru](mailto:org@eplast1.ru)

**Адрес:** 198099, г. Санкт-Петербург, ул. Калинина, дом 2, корпус 4, литера А.