

# DELPHI SERIES

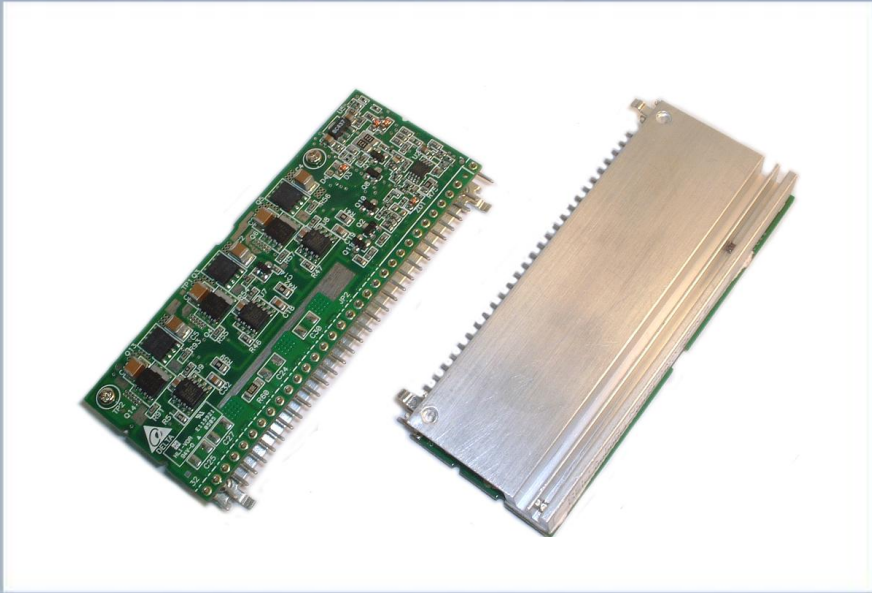

## Delphi NC Series Non-Isolated Point of Load DC/DC Power Modules: 12Vin, 0.9V-5Vout, 60A

The Delphi NC Series, 12V input, single output, non-isolated point of load DC/DC converters are the latest offering from a world leader in power systems technology and manufacturing — Delta Electronics, Inc. This product family provides up to 60A of power in a vertical or horizontal mounted through-hole package. The NC12S0A0V60 will provide up to 60A of output current and the output can be resistor- or voltage-trimmed from 0.9Vdc to 5.0Vdc. It provides a very cost effective point of load solution. With creative design technology and optimization of component placement, these converters possess outstanding electrical and thermal performance, as well as extremely high reliability under highly stressful operating conditions.

### FEATURES

- ♦ High Efficiency: 95% @ 12Vin, 5V/60A out
- ♦ Voltage and resistor-based trim
- ♦ No minimum load required
- ♦ Output voltage programmable from 0.9Vdc to 5.0Vdc via external resistors
- ♦ Fixed frequency operation
- ♦ Input UVLO, output OTP, OCP, SCP
- ♦ Remote ON/OFF (default: positive)
- ♦ ISO 9001, TL 9000, ISO 14001, QS9000, OHSAS 18001 certified manufacturing facility
- ♦ UL/cUL 60950 (US & Canada) Recognized, and TUV (EN60950) Certified
- ♦ CE mark meets 73/23/EEC and 93/68/EEC directives

### OPTIONS

- ♦ Negative On/Off logic
- ♦ Vertical or horizontal versions

### APPLICATIONS

- ♦ DataCom
- ♦ Distributed power architectures
- ♦ Servers and workstations
- ♦ LAN / WAN applications
- ♦ Data processing applications

# TECHNICAL SPECIFICATIONS (T<sub>A</sub>=25°C, airflow rate=400LFM, V<sub>in</sub>=12Vdc, nominal V<sub>out</sub> unless otherwise noted)

PARAMETER	NOTES and CONDITIONS	NC12S0A0V60			
		Min.	Typ.	Max.	Units
<b>ABSOLUTE MAXIMUM RATINGS</b>					
Input Voltage				12.6	Vdc
Operating Temperature		0		125	°C
Storage Temperature	Refer to Figure 36 for the measuring point	-40		125	°C
Input/Output Isolation Voltage	Non-isolated		NA		V
<b>INPUT CHARACTERISTICS</b>					
Operating Input Voltage		11.04	12	12.6	V
Input Under-Voltage Lockout					
Turn-On Voltage Threshold			9.4		V
Turn-Off Voltage Threshold			8.3		V
Lockout Hysteresis Voltage			1.1		V
Maximum Input Current	100% Load, 11.04V <sub>in</sub> , 5V <sub>out</sub>			32	A
No-Load Input Current			250		mA
Off Converter Input Current			40		mA
Input Reflected-Ripple Current	Refer to Figure 35		150		mA
Input Voltage Ripple Rejection	120 Hz		45		dB
Output Short-Circuit Input Current				1	A
<b>OUTPUT CHARACTERISTICS</b>					
Output Voltage Adjustment Range		0.9		5.0	V
Output Voltage Set Point	V <sub>in</sub> =12V, I <sub>o</sub> =I <sub>o,max</sub> , 1% trim resistors	-3.0		+3.0	%
Output Voltage Regulation					
Over Load	I <sub>o</sub> =I <sub>o,min</sub> to I <sub>o,max</sub>	-1.5		+1.5	%
Over Line	V <sub>in</sub> =V <sub>in,min</sub> to V <sub>in,max</sub>	-0.2		+0.2	%
Output Voltage Ripple and Noise	5Hz to 20MHz bandwidth				
Peak-to-Peak	Full Load, 0.1µF ceramic, 10µF tantalum			50	mV
RMS	Full Load, 0.1µF ceramic, 10µF tantalum			15	mV
Output Current Range		0		60	A
Output Voltage Over-shoot at Start-up	V <sub>in</sub> =12V, Turn ON			1	%
Output Voltage Under-shoot at Power-Off	V <sub>in</sub> =12V, Turn OFF			100	mV
Output DC Current-Limit Inception			94		A
<b>DYNAMIC CHARACTERISTICS</b>					
Out Dynamic Load Response	12V <sub>in</sub> , 10µF Tan & 1µF Ceramic load cap, 10A/µs				
Positive Step Change in Output Current	50% I <sub>o,max</sub> to 75% I <sub>o,max</sub>		75	100	mV
Negative Step Change in Output Current	75% I <sub>o,max</sub> to 50% I <sub>o,max</sub>		75	100	mV
Settling Time	Settling to be within regulation band (+/- 3.0%)			150	µs
Turn-On Transient	I <sub>o</sub> =I <sub>o,max</sub>				
Start-Up Time, From On/Off Control	V <sub>in</sub> =12V, V <sub>o</sub> =10% of V <sub>o,set</sub>			10	ms
Start-Up Time, From Input	V <sub>o</sub> =10% of V <sub>o,set</sub>			30	ms
Minimum Output Startup Capacitive Load	Ex: Four OSCON 6.3V/680µF (ESR 13mΩ max each)	2720			µF
Maximum Output Startup Capacitive Load	Full load			8160	µF
Minimum Input Capacitance	Ex: Three OSCON 16V/270µF (ESR 18mΩ max each)	810			µF
<b>EFFICIENCY</b>					
V <sub>o</sub> =0.9V	V <sub>in</sub> =12V, I <sub>o</sub> =60A		83		%
V <sub>o</sub> =1.2V	V <sub>in</sub> =12V, I <sub>o</sub> =60A		86		%
V <sub>o</sub> =1.5V	V <sub>in</sub> =12V, I <sub>o</sub> =60A		88		%
V <sub>o</sub> =1.8V	V <sub>in</sub> =12V, I <sub>o</sub> =60A		90		%
V <sub>o</sub> =2.5V	V <sub>in</sub> =12V, I <sub>o</sub> =60A		92		%
V <sub>o</sub> =3.3V	V <sub>in</sub> =12V, I <sub>o</sub> =60A		93		%
V <sub>o</sub> =5.0V	V <sub>in</sub> =12V, I <sub>o</sub> =60A		95		%
<b>FEATURE CHARACTERISTICS</b>					
Switching Frequency			300		KHz
ON/OFF Control	Positive logic (internally pulled high)				
Logic High	Module On (or leave the pin open)	2.4		5.5	V
Logic Low	Module Off	0		0.8	V
Remote Sense Range				400	mV
<b>GENERAL SPECIFICATIONS</b>					
Calculated MTBF	Telcordia SR-332 Issue1 Method1 Case3 at 50°C		1.29		M hours
Weight			47		grams
Over-Temperature Shutdown	Refer to Figure 36 for the measuring point		130		°C



# ELECTRICAL CHARACTERISTICS CURVES

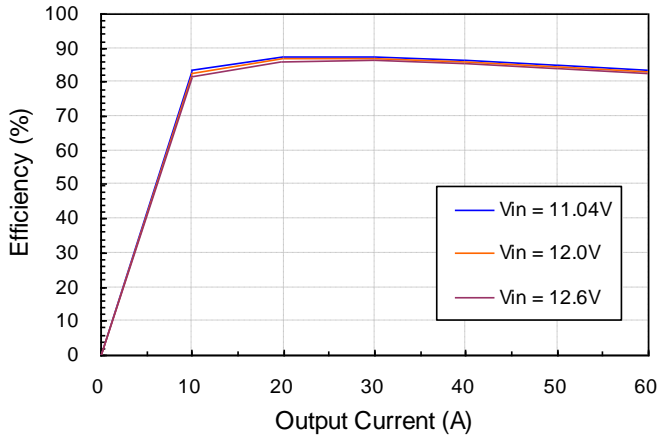

**Figure 1:** Converter efficiency vs. output current (0.9V output voltage)

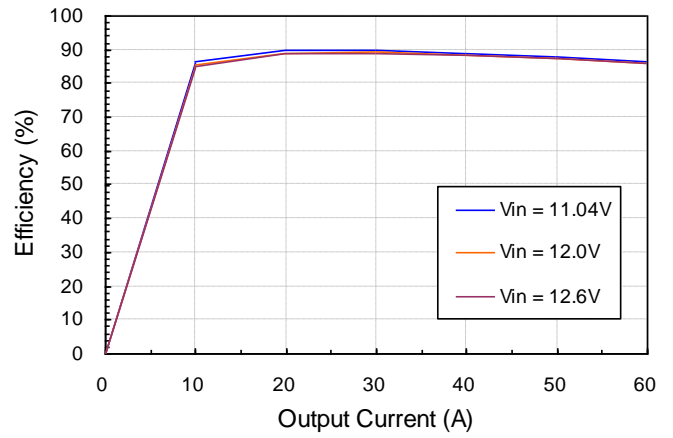

**Figure 2:** Converter efficiency vs. output current (1.2V output voltage)

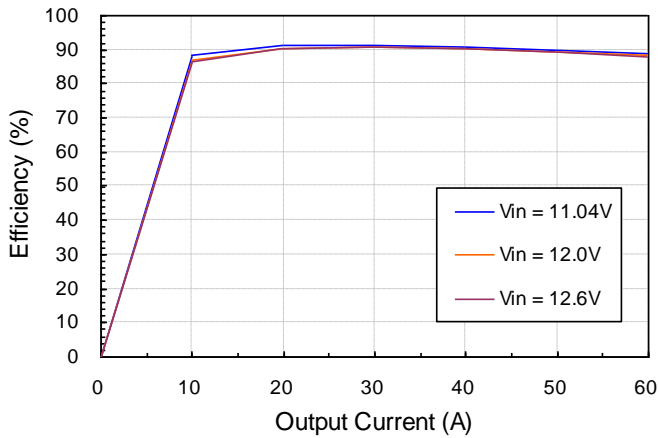

**Figure 3:** Converter efficiency vs. output current (1.5V output voltage)

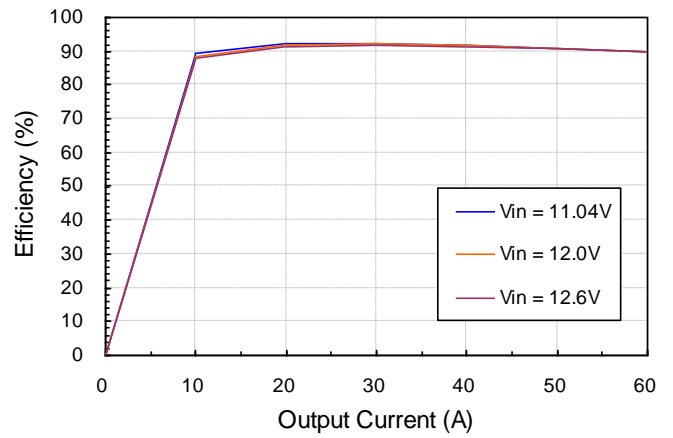

**Figure 4:** Converter efficiency vs. output current (1.8V output voltage)

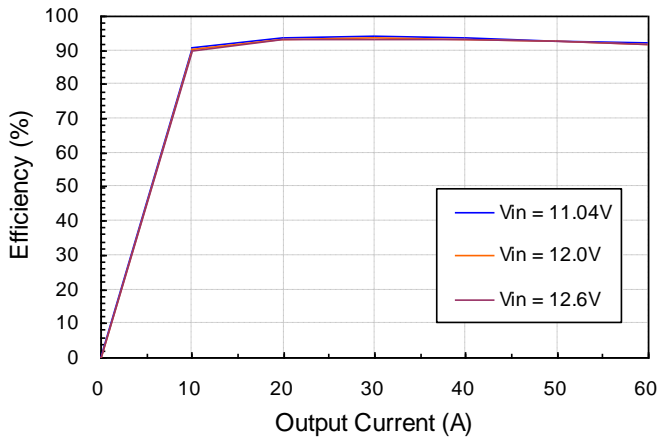

**Figure 5:** Converter efficiency vs. output current (2.5V output voltage)

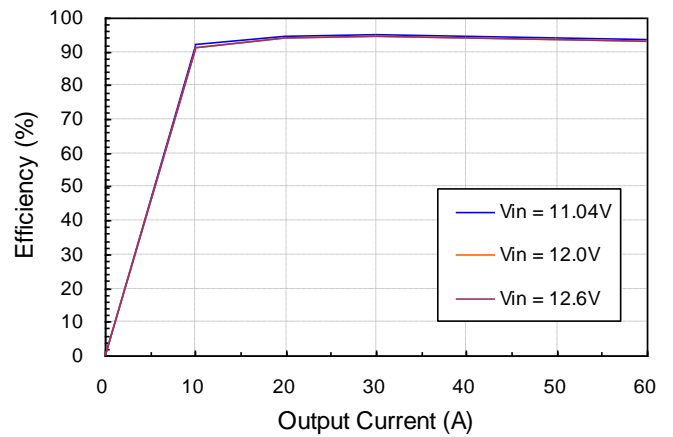

**Figure 6:** Converter efficiency vs. output current (3.3V output voltage)



# ELECTRICAL CHARACTERISTICS CURVES (CON.)

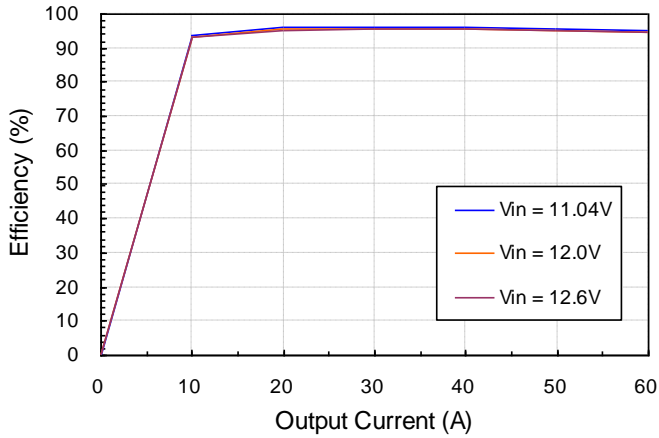

Figure 7: Converter efficiency vs. output current (5V output voltage)

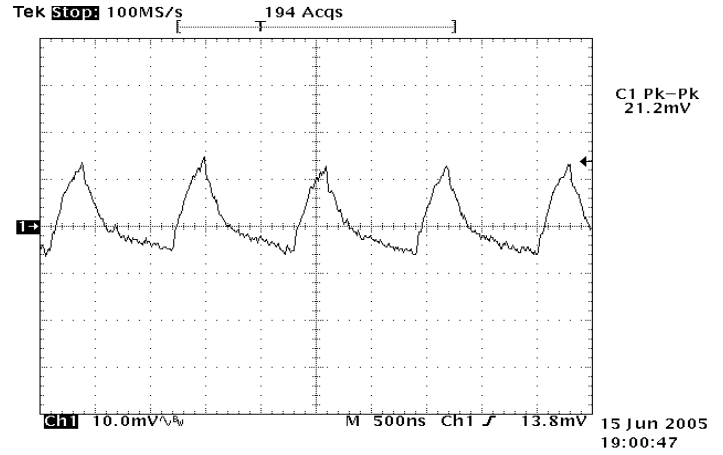

Figure 8: Output ripple & noise at 12Vin, 0.9V/60A out

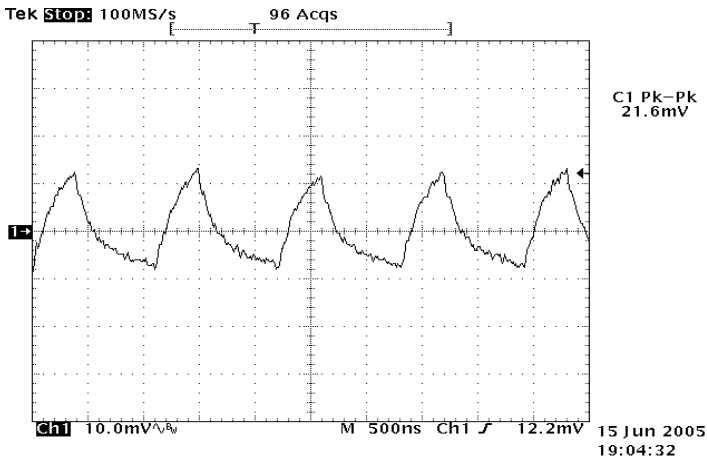

Figure 9: Output ripple & noise at 12Vin, 1.2V/60A out

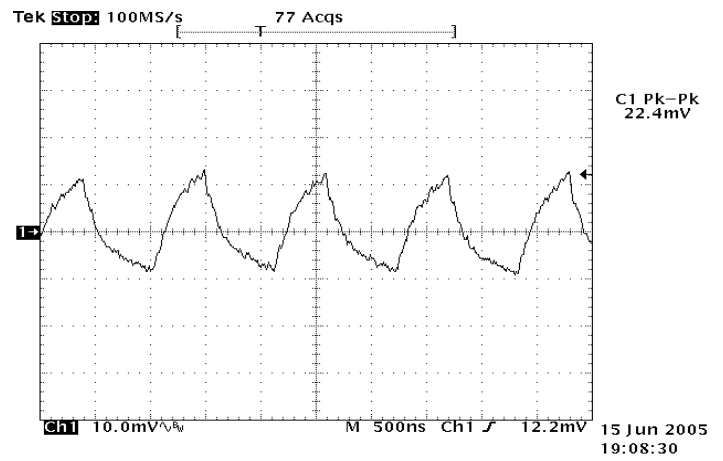

Figure 10: Output ripple & noise at 12Vin, 1.5V/60A out

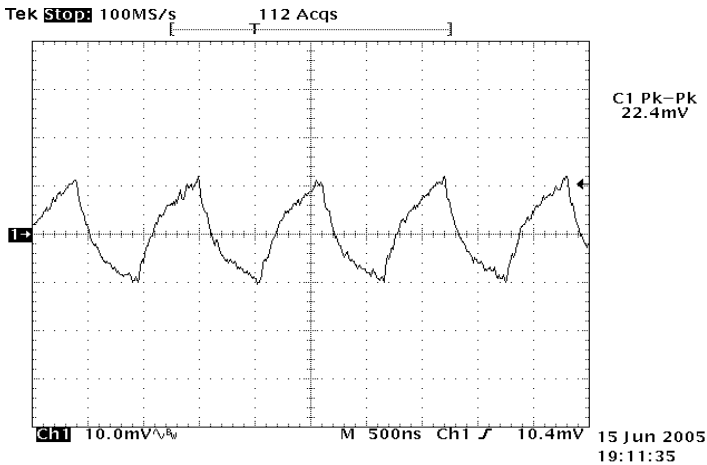

Figure 11: Output ripple & noise at 12Vin, 1.8V/60A out

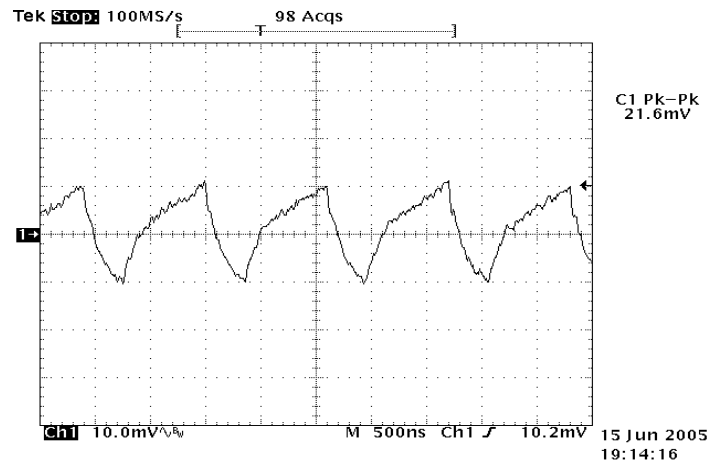

Figure 12: Output ripple & noise at 12Vin, 2.5V/60A out



# ELECTRICAL CHARACTERISTICS CURVES (CON.)

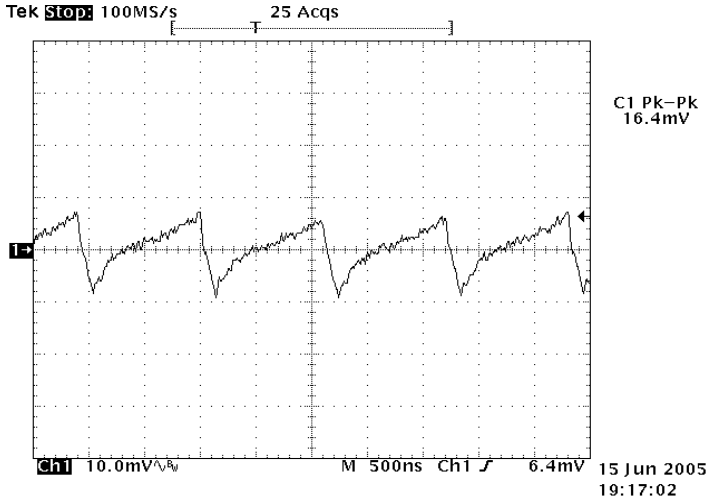

Figure 13: Output ripple & noise at 12Vin, 3.3V/60A out

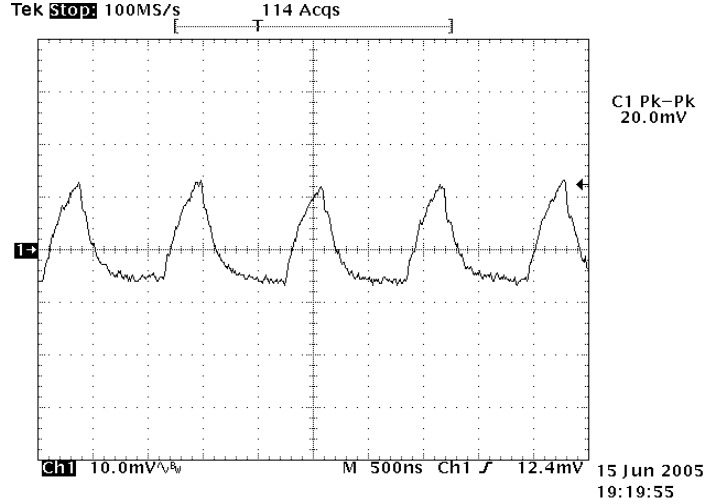

Figure 14: Output ripple & noise at 12Vin, 5V/60A out

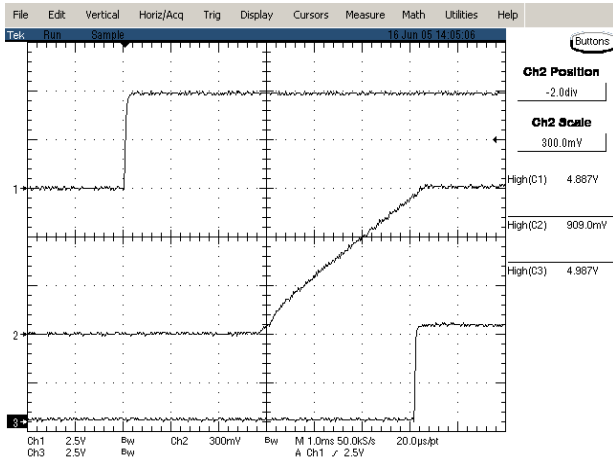

Figure 15: Turn on delay time at 12Vin, 0.9V/60A out  
Ch1:OUTEN Ch2:Vout Ch3:PWRGD

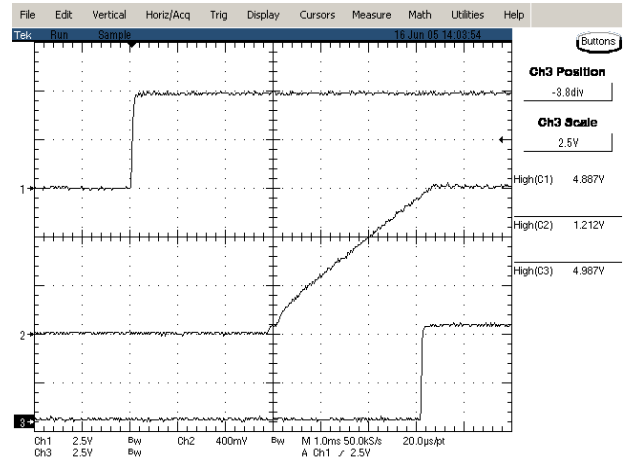

Figure 16: Turn on delay time Remote On/Off, 1.2V/60A out  
Ch1:OUTEN Ch2:Vout Ch3:PWRGD

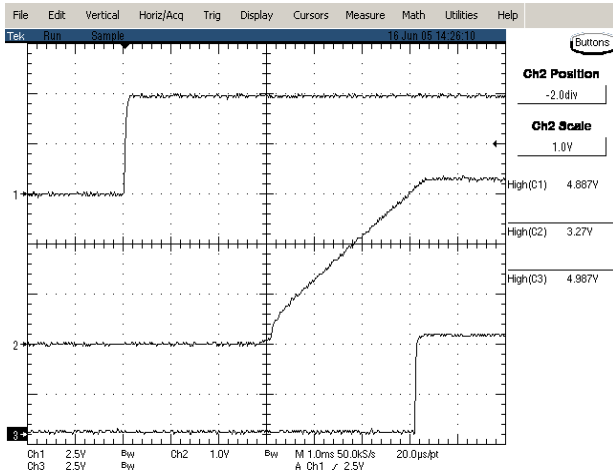

Figure 17: Turn on delay time at 12Vin, 3.3V/60A out  
Ch1:OUTEN Ch2:Vout Ch3:PWRGD

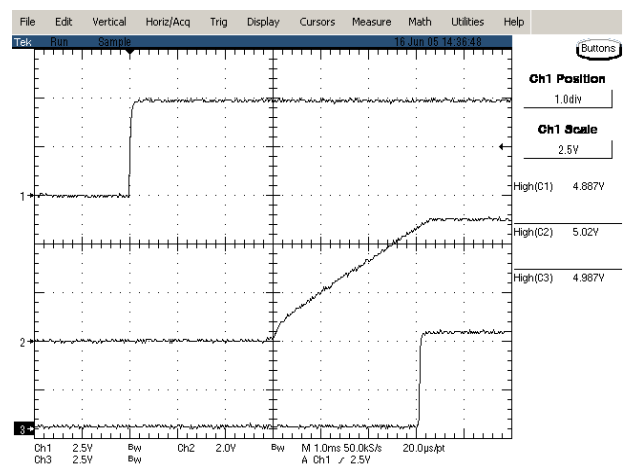
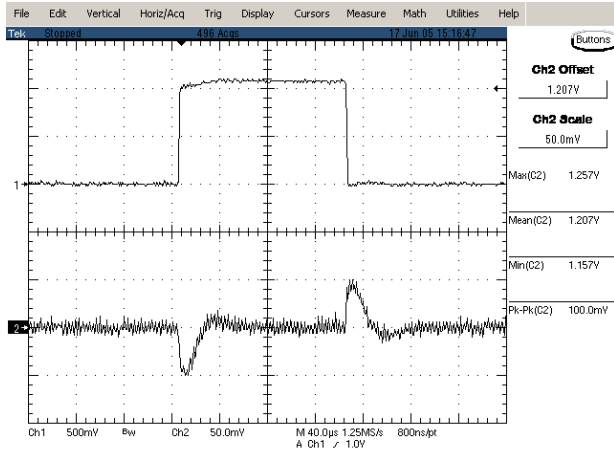
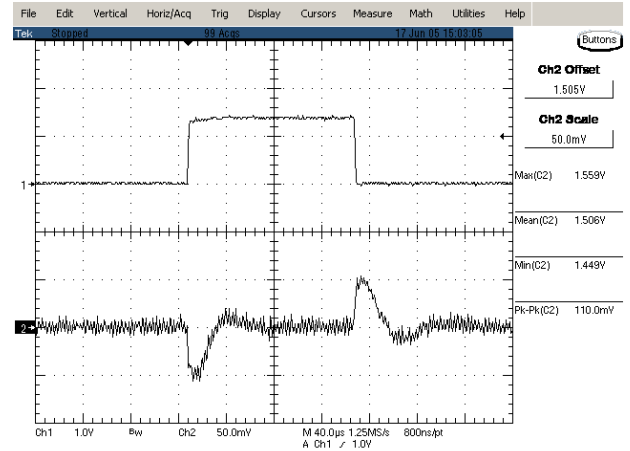

Figure 18: Turn on delay time Remote On/Off, 5V/60A out  
Ch1:OUTEN Ch2:Vout Ch3:PWRGD

# ELECTRICAL CHARACTERISTICS CURVES (CON.)



**Figure 19:** Typical transient response to step load change at  $10A/\mu s$  from 50% to 75% and 75% to 50% of  $I_o$ , max at  $12V_{in}$ , 1.2V out



**Figure 20:** Typical transient response to step load change at  $10A/\mu s$  from 50% to 75% and 75% to 50% of  $I_o$ , max at  $12V_{in}$ , 1.5V out

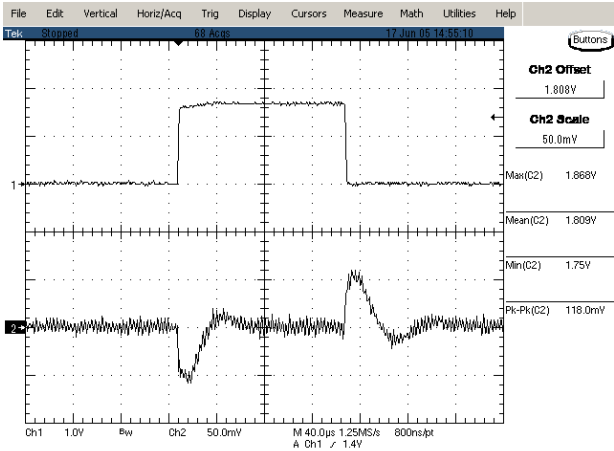

**Figure 21:** Typical transient response to step load change at  $10A/\mu s$  from 50% to 75% and 75% to 50% of  $I_o$ , max at  $12V_{in}$ , 1.8V out

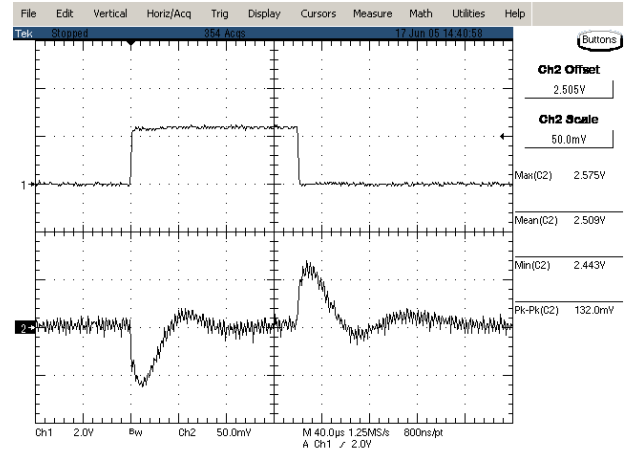

**Figure 22:** Typical transient response to step load change at  $10A/\mu s$  from 50% to 75% and 75% to 50% of  $I_o$ , max at  $12V_{in}$ , 2.5V out

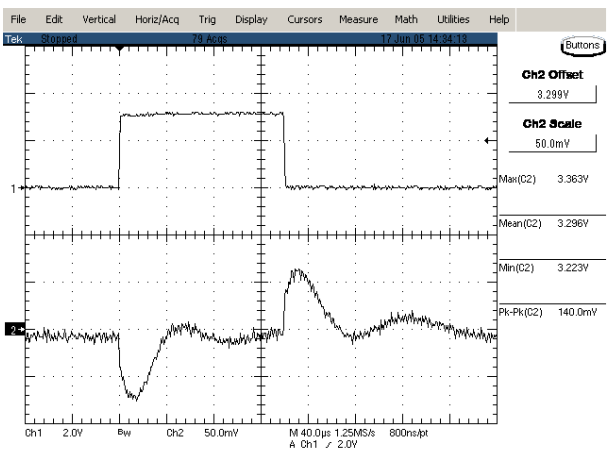

**Figure 23:** Typical transient response to step load change at  $10A/\mu s$  from 50% to 75% and 75% to 50% of  $I_o$ , max at  $12V_{in}$ , 3.3V out

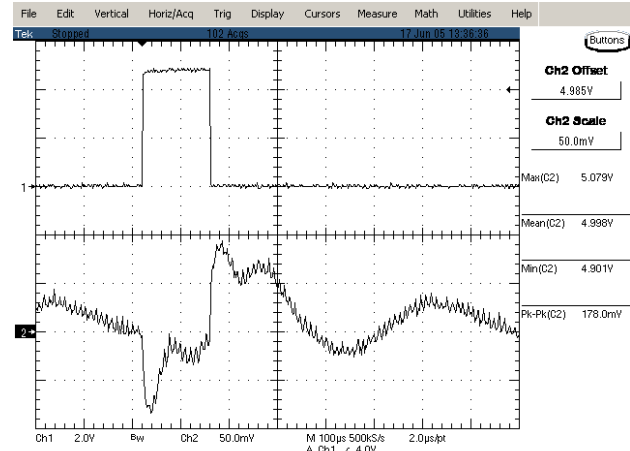

**Figure 24:** Typical transient response to step load change at  $10A/\mu s$  from 50% to 75% and 75% to 50% of  $I_o$ , max at  $12V_{in}$ , 5.0V out



## DESIGN CONSIDERATIONS

The NC60A is designed using three-phase synchronous buck topology. Block diagram of the converter is shown in Figure 25. The output can be trimmed in the range of 0.9V to 5.0V by a resistor from trim pin to ground. The remote sense is able to compensate for a drop from the output of converter to point of load.

The converter can be turned on/off by remote control. Positive OUTEN logic implies that the converter DC output is enabled when this signal is driven high (greater than 2.4V) or floating and disabled when low (below 0.8V). Negative OUTEN logic is an option.

The converter provides an open collector signal, Power Good. The power good signal is pulled low when output is not within  $\pm 10\%$  of  $V_{out}$  or when Enable is off.

The converter can protect itself into hiccup mode against over current and short circuit condition. Also, the converter will shut down due to over voltage protection is detected.

The converter has an over temperature protection which can protect itself by shutting down for an over temperature event. There is a thermal hysteresis of typically  $25^{\circ}\text{C}$

## Safety Considerations

It is recommended to add a fuse at input line. As to current rating of the fuse, it depends on the output voltage and current setting.

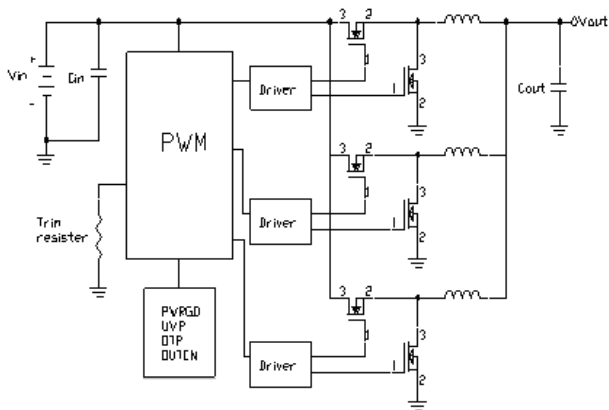

Figure 25: Block Diagram

## FEATURES DESCRIPTIONS

### Remote On/Off

The remote ON/OFF input allows external circuitry to put the NC converter into a sleep mode. Active-high remote on/off is available as standard.

Active-high units of the NC series are turned on if the remote ON/OFF pin is high (or floating). Pulling the pin low will turn off the unit. To guarantee turn-on the enable voltage must be above 2.4V and to turn off the enable voltage must be pulled below 0.8V

The remote ON/OFF input can be driven in a variety of ways as shown in Figures 26, 27, and 28. If the remote ON/OFF signal originates on the primary side, the remote ON/OFF input can be driven through a discrete device (e.g. a bipolar signal transistor) or directly from a logic gate output. The output of the logic gate may be an open-collector (or open-drain) device. If the drive signal originates from the opposite of an isolated side, the remote ON/OFF input can be isolated and driven through a

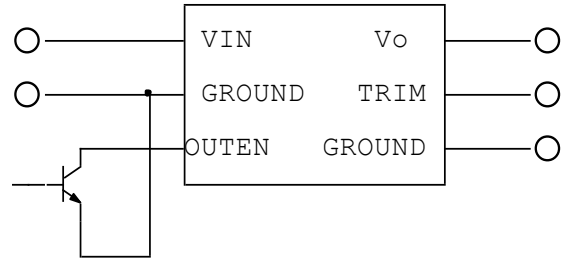

Figure 26: Remote ON/OFF Input Drive Circuit for Non-Isolated Bipolar

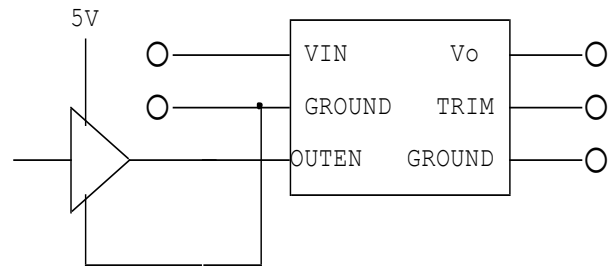
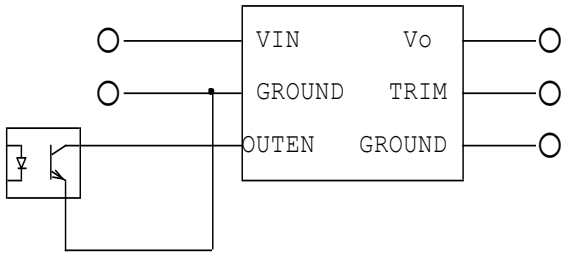

Figure 27: Remote ON/OFF Input Drive Circuit for Logic Driver

## FEATURES DESCRIPTIONS (CON.)

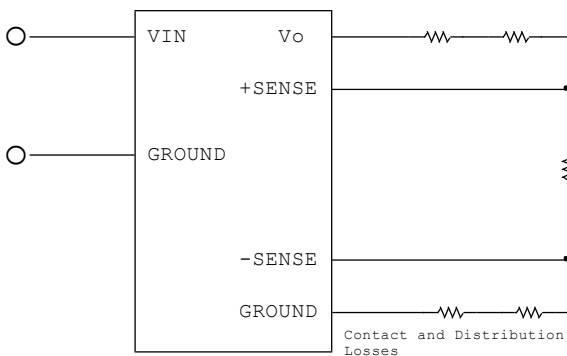

**Figure 28:** Remote ON/OFF Input Drive Circuit

### Remote Sense

Remote sense compensates for voltage drops on the output by sensing the actual output voltage at the point of load. The module will compensate for a maximum drop of 400mV. The remote sense connects as shown in Figures 29.

This limit includes any increase in voltage due to remote sense compensation and output voltage set point adjustment (trim).



**Figure 29:** Effective circuit configuration for remote sense operation

### Under Voltage Lockout

The undervoltage lockout prevents the converter from operating when the input voltage is too low. The lockout occurs between 8.3V to 9.4V. This allows more flexibility in designing and ensures operation on supply lines with large tolerances

### Over Current and Short-Circuit Protection

When over current condition occurs, the converter enters hiccup mode. Ambient temperature influences the current limit inception point since resistance of MOSFET rises with temperature. The unit will not be damaged in an over current condition because it will be protected by the over temperature protection.

### Over Temperature Protection (OTP)

The over temperature protection is non-latching and a temperature sensor monitors the temperature of the PCB near one the main MOSFETS. If temperature exceeds a threshold of 130°C (typ.) the converter will shut down. When the substrate temperature has decreased by 25°C the converter will automatically restart.

### Over Voltage Protection (OVP)

The converter will shut down when an output over voltage is detected. Once the OVP condition is detected, the controller will stop all PWM outputs and will turn on low-side MOSFET driver to prevent any damage to load.

### Current Sharing (optional)

The parallel operation of multiple converters is available with the NC60 (option code B). The converter will share to be within +/- 10% of load. Note the remote sense lines of the parallel units must be connected at the same point for proper operation in addition to the current share pins being connected. Also, units are intended to be turned on/enabled at the same time. Hot plugging is not recommended. The current share diagram show in Figure 30.



## FEATURES DESCRIPTIONS (CON.)

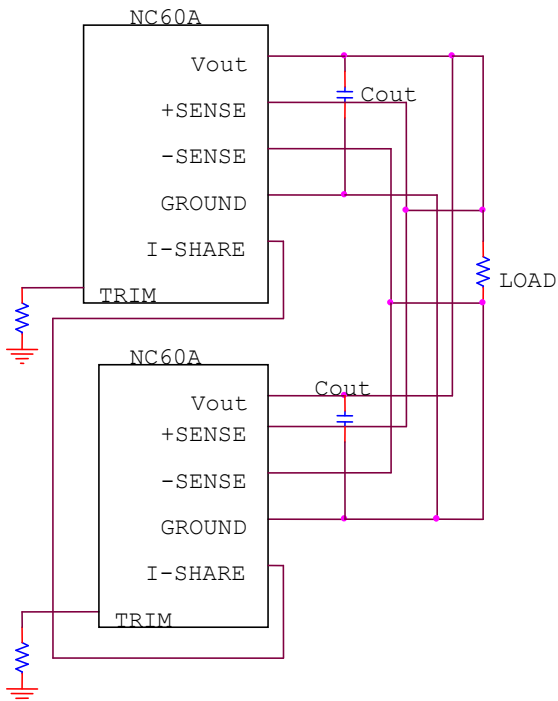

Figure 30: NC60A Current Share Diagram

### Output Voltage Programming

The output on the module is trimmable by connecting an external resistor between the TRIM pin (PIN1) and ground as per Figure 31 and the typical trim values are shown in Figure 32.

The NC60A module has a trim range of 0.9V to 5.0V. A plot of trim behavior is shown in Figure 33

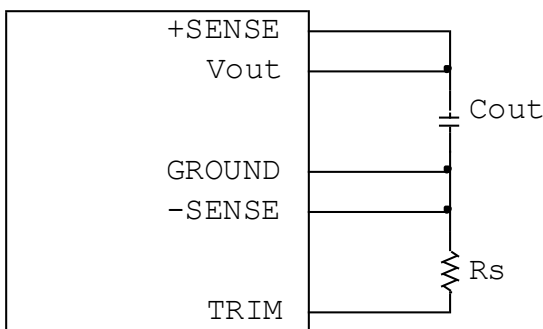

Figure 31: Trimming Output Voltage

The resistor trim equation for the NC is as follows:

$$R_{set} (k\Omega) = \frac{12.69 - V_{out}}{V_{out} - 0.9}$$

Where,

$V_{out}$  is the required voltage setpoint

$R_{set}$  is the resistance required between TRIM and Ground

$R_{set}$  values should not be less than 1.8 k $\Omega$

Output Voltage	Rs( $\Omega$ ) tol
+0.9 V	OPEN
+1.2 V	38.3K
+1.5 V	18.7K
+1.8 V	12.1K
+2.5 V	6.34K
+3.3 V	3.92K
+5 V	1.87K

Figure 32: Typical Trim Resistor Values

The voltage trim equation with example is as follows :

**Example :**

Set  $V_t = 1.25V$

$V_t = 1.25V$

$V_{out} = 2.5V$

$R_s = 1 k\Omega$

$$R_t = \frac{R_s(13.1V_t + V_{out} - 12.69)}{0.9R_s - V_{out}R_s - V_{out} + 12.69}$$

$R_t = 0.72 k\Omega$

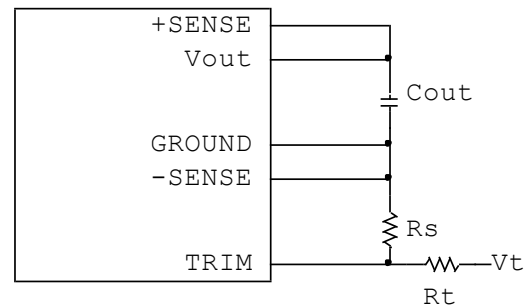

Figure 33: Trim Output Voltage – with Voltage Source

## Voltage Margin Adjusting

Output voltage margin adjusting can be implemented in the NC60A modules by connecting a resistor,  $R_{margin-up}$ , from the Trim pin to the ground pin for adjusting voltage a little bit higher. Also, the output voltage can be adjusted lower by connecting a resistor,  $R_{margin-down}$ , from the Trim pin to the output pin. Figure 34 shows the circuit configuration for output voltage margin adjusting.

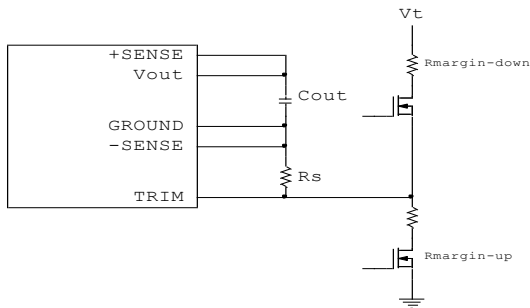

Figure 34: Circuit configuration for output voltage margining

## Output Capacitance

An external output capacitor is required for stable operation.

## Reflected Ripple Current and Output Ripple and Noise Measurement

The measurement set-up outlined in Test Configuration Figure 35 have been used for both input reflected/terminal ripple current and output voltage ripple and noise measurements on NC series converters.

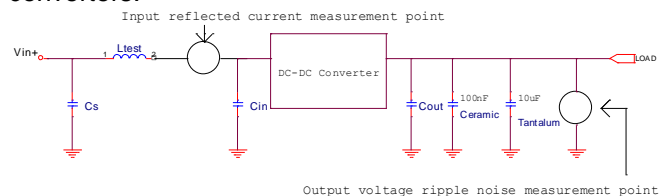

$$C_s = 270\mu F * 1 \quad L_{test} = 1.4\mu H \quad C_{in} = 270\mu F * 3 \quad C_{out} = 680\mu F * 4$$

Figure 35: Input Reflected Ripple/Capacitor Ripple Current and Output Voltage Ripple and Noise Measurement Set-Up for NC60A

## THERMAL CONSIDERATION

The electrical operating conditions of the NC, namely:

- Input voltage,  $V_{in}$
- Output voltage,  $V_o$
- Output current,  $I_o$

Determine how much power is dissipated within the converter. The following parameters further influence the thermal stresses experienced by the converter:

- Ambient temperature
- Air velocity
- Thermal efficiency of the end system application
- Parts mounted on system PCB that may block airflow
- Real airflow characteristics at the converter location

In order to simplify the thermal design, a number of thermal de-rating plots are provided. These de-rating graphs show the load current of the NC versus the ambient air temperature and air flow. However, since the thermal performance is heavily dependent upon the final system application, the user needs to ensure the thermal reference point temperatures are kept within the recommended temperature rating. It is recommended that the thermal reference point temperatures are measured using a thermocouple or an IR camera. In order to comply with stringent Delta de-rating criteria, the ambient temperature should never exceed  $85^{\circ}C$ . Please contact Delta for further support..

The maximum acceptable temperature measured at the thermal reference point is  $127^{\circ}C$ . This is shown in Figure 36.

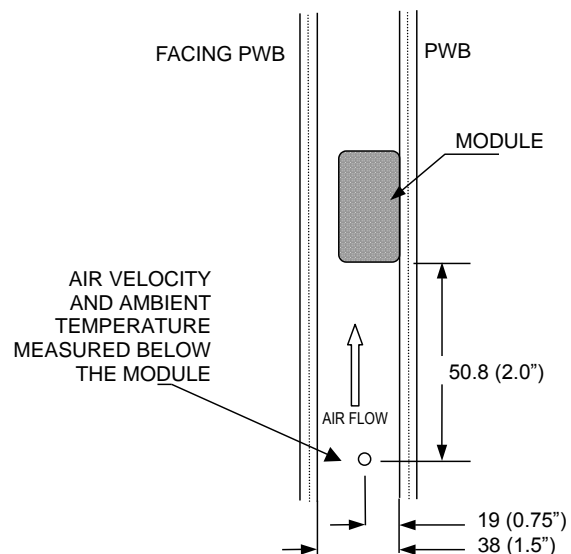

Note: Wind Tunnel Test Setup



# THERMAL CURVES (NC12S0A0V60)

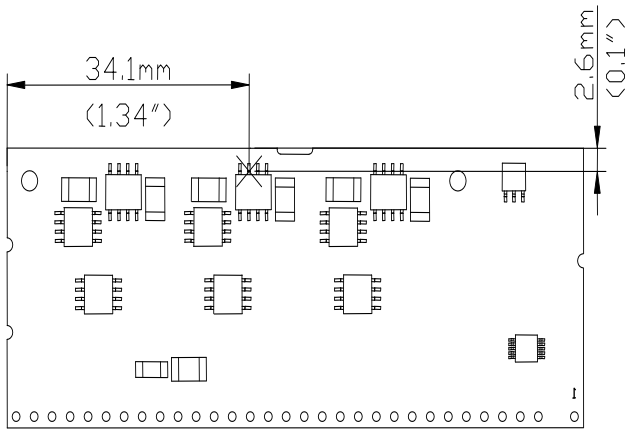

**Figure 36:** Temperature measurement location  
 \* The allowed maximum hot spot temperature is defined at 127°C

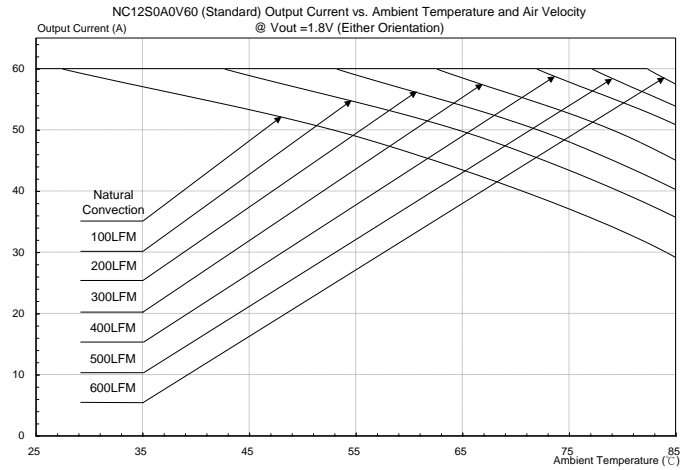

**Figure 39:** Output current vs. ambient temperature and air velocity @  $V_{out}=1.8V$  (Either Orientation)

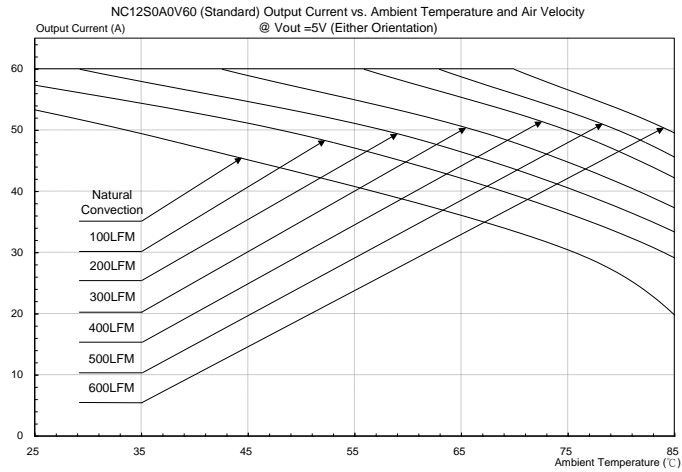

**Figure 37:** Output current vs. ambient temperature and air velocity @  $V_{out}=5V$  (Either Orientation)

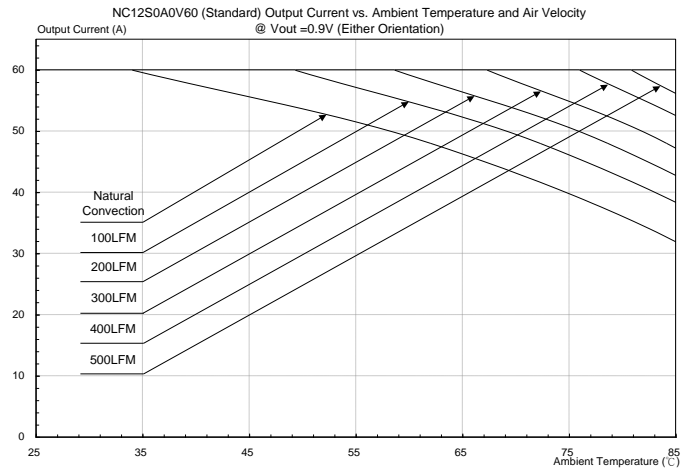

**Figure 40:** Output current vs. ambient temperature and air velocity @  $V_{out}=0.9V$  (Either Orientation)

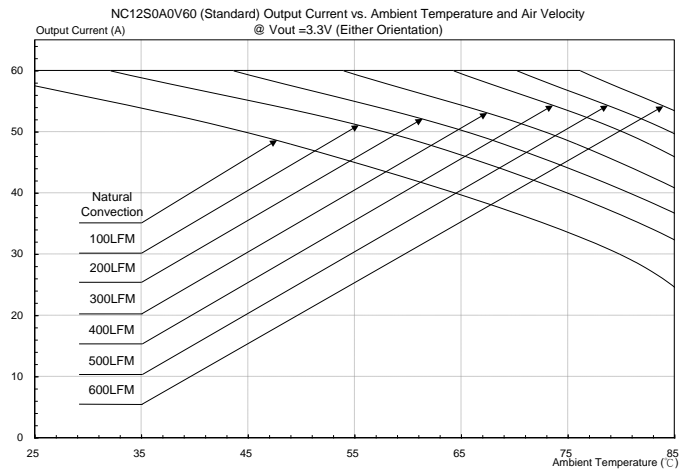

**Figure 38:** Output current vs. ambient temperature and air velocity @  $V_{out}=3.3V$  (Either Orientation)

# MECHANICAL DRAWING

## VERTICAL

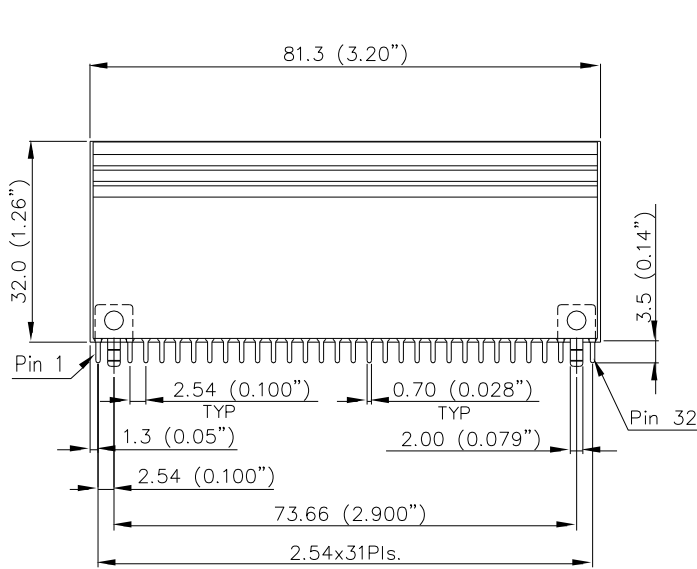

SUGGESTED PCB LAYOUT

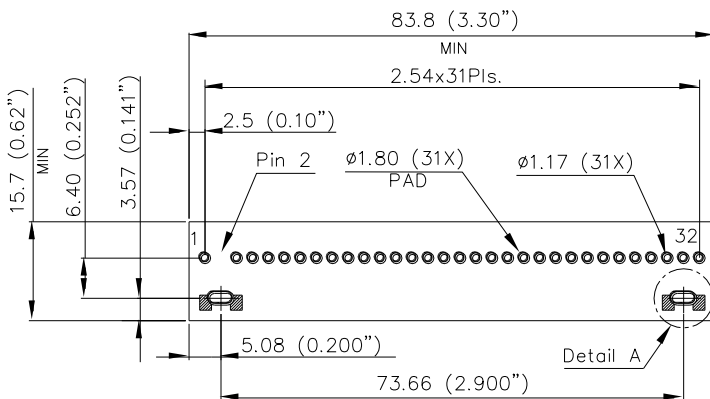

Detail A  
Scale 3:1

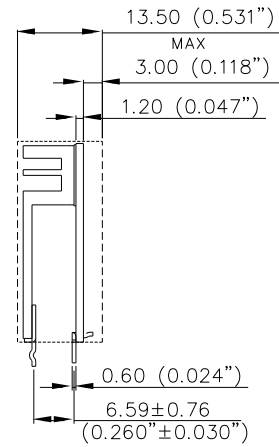
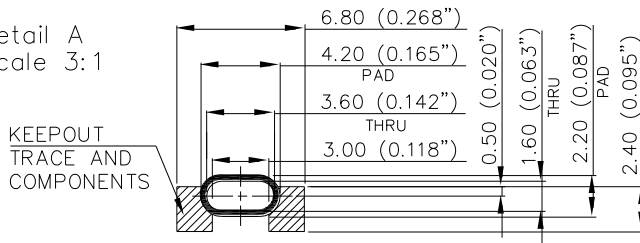

PIN ASSIGNMENT

PIN#	FUNCTION	PIN#	FUNCTION
1	+RS	17	GROUND
2	KEY	18	VOUT
3	GROUND	19	GROUND
4	PWRGD	20	VOUT
5	NC	21	GROUND
6	I-SHARE	22	VOUT
7	VSS	23	GROUND
8	VSS	24	VOUT
9	OUTEN	25	GROUND
10	-SENSE	26	VOUT
11	+SENSE	27	GROUND
12	12VIN	28	VOUT
13	12VIN	29	GROUND
14	12VIN	30	VOUT
15	VOUT	31	GROUND
16	VOUT	32	VOUT

UNIT : mm(inch)

NOTES:

DIMENSIONS ARE IN MILLIMETERS AND (INCHS)

TOLERANCE: X.X mm±0.5 mm(X.XX in.±0.02 in.)

X.XX mm±0.25 mm(X.XXX in.±0.010 in.)



## PART NUMBERING SYSTEM

NC	12	S	0A0	V	60	P	N	F	A
Product Series	Input Voltage	Number of outputs	Output Voltage	Mounting	Output Current	ON/OFF Logic	Pin Length		Option Code
NC-Non-isolated Converter	12-11.04~12.6V	S- Single output	0A0-programmable	V- Vertical H- Horizontal	60- 60A	P- Positive N- Negative	R- 0.118" N- 0.140"	F- RoHS 6/6 (Lead Free)	A- Standard Functions B- With current sharing (only for NC30/40/60A)

## MODEL LIST

Model Name	Packaging	Input Voltage	Output Voltage	Output Current	Efficiency 12Vin @ 100% load
NC12S0A0V60PNFA	Vertical	11.04~12.6Vdc	0.9 V~ 5.0Vdc	60A	95% (5.0V)
NC12S0A0V60PNFB	Vertical	11.04~12.6Vdc	0.9 V~ 5.0Vdc	60A	95% (5.0V)
NC12S0A0H60PNFB	Horizontal	11.04~12.6Vdc	0.9 V~ 5.0Vdc	60A	95% (5.0V)

### CONTACT: [www.deltaww.com/dcdc](http://www.deltaww.com/dcdc)

#### USA:

Telephone:  
East Coast: 978-656-3993  
West Coast: 510-668-5100  
Fax: (978) 656 3964  
Email: [DCDC@delta-corp.com](mailto:DCDC@delta-corp.com)

#### Europe:

Telephone: +31-20-655-0967  
Fax: +31-20-655-0999  
Email: [DCDC@delta-es.com](mailto:DCDC@delta-es.com)

#### Asia & the rest of world:

Telephone: +886 3 4526107 x6220~6224  
Fax: +886 3 4513485  
Email: [DCDC@delta.com.tw](mailto:DCDC@delta.com.tw)

## WARRANTY

Delta offers a two (2) year limited warranty. Complete warranty information is listed on our web site or is available upon request from Delta.

Information furnished by Delta is believed to be accurate and reliable. However, no responsibility is assumed by Delta for its use, nor for any infringements of patents or other rights of third parties, which may result from its use. No license is granted by implication or otherwise under any patent or patent rights of Delta. Delta reserves the right to revise these specifications at any time, without notice.



Компания «ЭлектроПласт» предлагает заключение долгосрочных отношений при поставках импортных электронных компонентов на взаимовыгодных условиях!

Наши преимущества:

- Оперативные поставки широкого спектра электронных компонентов отечественного и импортного производства напрямую от производителей и с крупнейших мировых складов;
- Поставка более 17-ти миллионов наименований электронных компонентов;
- Поставка сложных, дефицитных, либо снятых с производства позиций;
- Оперативные сроки поставки под заказ (от 5 рабочих дней);
- Экспресс доставка в любую точку России;
- Техническая поддержка проекта, помощь в подборе аналогов, поставка прототипов;
- Система менеджмента качества сертифицирована по Международному стандарту ISO 9001;
- Лицензия ФСБ на осуществление работ с использованием сведений, составляющих государственную тайну;
- Поставка специализированных компонентов (Xilinx, Altera, Analog Devices, Intersil, Interpoint, Microsemi, Aeroflex, Peregrine, Syfer, Eurofarad, Texas Instrument, Miteq, Cobham, E2V, MA-COM, Hittite, Mini-Circuits, General Dynamics и др.);

Помимо этого, одним из направлений компании «ЭлектроПласт» является направление «Источники питания». Мы предлагаем Вам помощь Конструкторского отдела:

- Подбор оптимального решения, техническое обоснование при выборе компонента;
- Подбор аналогов;
- Консультации по применению компонента;
- Поставка образцов и прототипов;
- Техническая поддержка проекта;
- Защита от снятия компонента с производства.



#### Как с нами связаться

**Телефон:** 8 (812) 309 58 32 (многоканальный)

**Факс:** 8 (812) 320-02-42

**Электронная почта:** [org@eplast1.ru](mailto:org@eplast1.ru)

**Адрес:** 198099, г. Санкт-Петербург, ул. Калинина, дом 2, корпус 4, литера А.