



Click on the logo above to go to [www.panduit.com](http://www.panduit.com) up to date product information find a local distributor technical information

## Section Index



### A. System Overview



### B. Bundle

1. Cable Ties
2. Cable Accessories
3. Stainless Steel Cable Ties and Accessories



### C. Route/Protect

1. Wiring Duct
2. Surface Raceway
3. Abrasion Protection
4. Cable Management



### D. Terminate

1. Terminals
2. Power Connectors
3. Grounding Connectors



### E. Identification and Safety Solutions

1. Labeling Systems
2. Labels
3. Pre-Printed and Write-On Markers
4. Permanent Identification
5. Lockout/Tagout and Safety Solutions



### F. Part Number Index

**CLICK on any of the tabs on this page to jump to that location within the catalog**

A.  
System  
Overview

B1.  
Cable Ties

B2.  
Cable  
Accessories

B3.  
Stainless  
Steel Ties

C1.  
Wiring  
Duct

C2.  
Surface  
Raceway

C3.  
Abrasion  
Protection

C4.  
Cable  
Management

D1.  
Terminals

D2.  
Power  
Connectors

D3.  
Grounding  
Connectors

E1.  
Labeling  
Systems

E2.  
Labels

E3.  
Pre-Printed  
& Write-On  
Markers

E4.  
Permanent  
Identification

E5.  
Lockout/  
Tagout  
& Safety  
Solutions

F.  
Index

A.  
System  
Overview

## Table of Contents

B1.  
Cable Ties

### System Overview

<b>System Overview</b> .....	A1.1
Solutions Overview .....	A1.2 – A1.3
Control Panel Solutions .....	A1.4
Harness Solutions .....	A1.5
Contractor Solutions .....	A1.6
MRO Solutions .....	A1.6
Harsh Environment Solutions .....	A1.7
Transportation Solutions .....	A1.7
Application Standards .....	A1.8 – A1.9
Programs .....	A1.10

C1.  
Wiring  
Duct

### Cable Ties

<b>Cable Ties</b> .....	B1.1
Cable Tie Selection Chart .....	B1.2 – B1.3
Cable Tie Styles Overview .....	B1.4 – B1.5
Features and Benefits – Pan-Ty® Cable Ties .....	B1.6
Selection Guide – Pan-Ty® Cable Ties .....	B1.7
Pan-Ty® Cable Ties – Nylon 6.6 .....	B1.8
Pan-Ty® Lashing Ties – Nylon 6.6 .....	B1.9
Pan-Ty® Cable Ties – Weather Resistant Nylon 6.6 .....	B1.10
Pan-Ty® Lashing Ties – Weather Resistant Nylon 6.6 .....	B1.11
Lashing Tie Mounting Clip .....	B1.11
Pan-Ty® Cable Ties – Heat Stabilized Nylon 6.6 .....	B1.12
Pan-Ty® Cable Ties – Heat Stabilized Weather Resistant Nylon 6.6 .....	B1.13
Pan-Ty® Cable Ties – Flame Retardant Nylon 6.6 .....	B1.14
Cable Tie Mounts – Flame Retardant Nylon 6.6 .....	B1.14
Pan-Ty® Cable Ties – Weather Resistant Nylon 12 .....	B1.15
Pan-Ty® Cable Ties – Polypropylene – Distinctive Green Color .....	B1.16
Pan-Ty® Cable Ties – Weather Resistant Polypropylene .....	B1.17
Pan-Ty® Cable Ties – HALAR▲ – Distinctive Maroon Color .....	B1.18
Pan-Ty® Cable Ties – TEFZEL■ – Distinctive Aqua Blue Color .....	B1.19
Cable Tie Mounts – TEFZEL■ .....	B1.19
Pan-Ty® Cable Ties – PEEK (Polyetheretherketone) .....	B1.20
★ Cable Tie Mounts – PEEK (Polyetheretherketone) .....	B1.20
Pan-Ty® Cable Ties – Metal Detectable Nylon 6.6 .....	B1.21
★ Cable Tie Mounts – Metal Detectable Nylon 6.6 and Polypropylene .....	B1.21
Pan-Ty® Releasable Cable Ties – Nylon 6.6 .....	B1.22
Pan-Ty® Releasable Lashing Ties – Nylon 6.6 .....	B1.22
Pan-Ty® Releasable Cable Ties – Weather Resistant and Heat Stabilized Nylon 6.6 .....	B1.23
Pan-Ty® Releasable Lashing Ties – Weather Resistant Nylon 6.6 .....	B1.24
Lashing Tie Mounting Clip – Weather Resistant Nylon 6.6 .....	B1.24
Pan-Ty® Releasable Lashing Ties – Weather Resistant Polypropylene .....	B1.25
Pan-Ty® Clamp Ties – Nylon 6.6 .....	B1.26
Pan-Ty® Clamp Ties – Weather Resistant and Heat Stabilized Nylon 6.6 .....	B1.27
Pan-Ty® Wing Push Mount Ties – Nylon 6.6 .....	B1.28
Pan-Ty® Wing Push Mount Ties – Weather Resistant and Heat Stabilized Nylon 6.6 .....	B1.29
Pan-Ty® Releasable Wing Push Mount Ties .....	B1.30
Pan-Ty® Center Mounted Wing Push Mount Ties – Heat Stabilized Nylon 6.6 .....	B1.31
Pan-Ty® Ladder Style Releasable Wing Push Mount Ties – Heat Stabilized Nylon 6.6 .....	B1.32
Pan-Ty® Umbrella Wing Push Mount Ties – Nylon and Heat Stabilized Nylon 6.6 .....	B1.32
Pan-Ty® Push Mount Ties .....	B1.33
Pan-Ty® Marker and Flag Ties .....	B1.34
Pan-Ty® Cable Ties Material and Color Chart .....	B1.35 – B1.37
Features and Benefits – Super-Grip® Cable Ties .....	B1.38
Selection Guide – Super-Grip® Cable Ties .....	B1.39
Super-Grip® Cable Ties – Nylon 6.6 .....	B1.40
Super-Grip® Cable Ties – Weather Resistant and Heat Stabilized Nylon 6.6 .....	B1.41
Super-Grip® Cable Ties and Mounts Material and Color Chart .....	B1.42
Features and Benefits – Dome-Top® Barb Ty Cable Ties .....	B1.43
Selection Guide – Dome-Top® Barb Ty and Dura-Ty™ Cable Ties .....	B1.44
Dome-Top® Barb Ty Cable Ties – Nylon 6.6 .....	B1.45
Dome-Top® Barb Ty Cable Ties – Weather Resistant Nylon 6.6 .....	B1.46
Dome-Top® Barb Ty Cable Ties – Heat Stabilized Nylon 6.6 .....	B1.47
Dome-Top® Barb Ty Clamp Ties – Nylon 6.6 .....	B1.48

▲HALAR is a registered trademark of Ausimont USA, Inc. ■TEFZEL is a registered trademark of E.I. du Pont de Nemours and Company.

★ Represents new product offering.

## Table of Contents

Dome-Top® Barb Ty Clamp Ties – Weather Resistant and Heat Stabilized Nylon 6.6	B1.49
Dome-Top® Barb Ty Wing Push Mount Ties – Nylon and Weather Resistant Nylon 6.6	B1.50
Dome-Top® Barb Ty Push Mount Ties – Weather Resistant Nylon 6.6	B1.51
Permanent Marking Pens	B1.51
Dome-Top® Barb Ty Marker and Flag Ties	B1.52
Dura-Ty™ Cable Ties – Weather Resistant Acetal – Heavy Cross Section	B1.53
Dura-Ty™ Cable Ties – Weather Resistant Acetal – Extra-Heavy Cross Section	B1.53
Stackable Aerial Cable Spacer – Weather Resistant Polypropylene	B1.54
Dome-Top® Barb Ty and Dura-Ty™ Cable Ties Material and Color Chart	B1.54 – B1.55
Features and Benefits – Parallel-Entry Cable Ties	B1.56
Selection Guide – Parallel-Entry Cable Ties	B1.57
Contour-Ty® Cable Ties – Nylon 6.6	B1.58
Contour-Ty® Cable Ties – Weather Resistant Nylon 6.6	B1.59
Contour-Ty® Cable Ties – Heat Stabilized and Flame Retardant Nylon 6.6	B1.60
Belt-Ty™ In-Line Cable Ties – Nylon and Weather Resistant Nylon 6.6	B1.61
Hyper-V™ In-Line Cable Ties – Weather Resistant Nylon 6.6	B1.62
Hyper-V™ Cable Tie Mounts	B1.62
IN-LINE Cable Ties – Weather Resistant Nylon 6.6	B1.63
Parallel-Entry Cable Ties Material and Color Chart	B1.64
Features and Benefits – Sta-Strap® Cable Ties	B1.65
Selection Guide – Sta-Strap® Cable Ties	B1.66
Sta-Strap® Cable Ties – Nylon 6.6	B1.67
Sta-Strap® Cable Ties – Weather Resistant Nylon 6.6	B1.68
Sta-Strap® Cable Ties – Heat Stabilized Nylon 6.6	B1.69
Sta-Strap® Clamp Ties	B1.70
Sta-Strap® Marker Ties – Nylon and Weather Resistant Nylon 6.6	B1.71
Sta-Strap® Cable Ties Material and Color Chart	B1.72
Selection Guide – Specialty Ties	B1.73
Pan-Ty® Stud Mounted Cable Ties – Heat Stabilized and Heat Stabilized Weather Resistant Nylon 6.6	B1.74
Pan-Ty® Ladder Style Stud Mounted Cable Tie – Heat Stabilized Nylon 6.6	B1.75
Pan-Ty® Double Loop Cable Ties	B1.76
Sta-Strap® Bow-Ty™ Cable Ties	B1.77
Pan-Ty® Triple Loop Cable Tie – Weather Resistant Nylon 6.6	B1.78
Double Hose Clamp – Weather Resistant Nylon 6.6	B1.78
Sta-Strap® Chassis/Panel Mount Tie – Heat Stabilized Weather Resistant Nylon 6.6	B1.79
Cable Marker Straps – Polyethylene	B1.80
Specialty Cable Ties Material and Color Chart	B1.81
Pan-Ty® Striped Cable Ties – Nylon 6.6	B1.82
Telephone Cable Identification Kits	B1.83
Cable Tie Kits in Steel Boxes	B1.83
Cable Tie Kits in Plastic Boxes and Bags	B1.84
Features and Benefits – Hook and Loop Cable Ties	B1.85
Selection Guide – Hook and Loop Cable Ties	B1.86
Tak-Ty® Hook & Loop Cable Ties	B1.87
Tak-Ty® Hook & Loop Cable Ties – Plenum-Rated	B1.88
Tak-Tape™ Hook & Loop Cable Tie Rolls	B1.88
Ultra-Cinch™ Hook & Loop Cable Ties	B1.89
Hook and Loop Cable Ties Color Chart	B1.90
★HLW Marker Hook and Loop Wrap Ties	B1.91
★Elastomeric Cable Ties – ERT	B1.91
★Cable Bundle Organizing Tool – CBOT	B1.92
Hot Stamping Service – Custom Printed Cable Ties	B1.93
Panduit Cable Tie Approvals	B1.94
Military Cross Reference	B1.95 – B1.97
Cable Tie Selection and Specification Guidelines	B1.98
Weathering	B1.99 – B1.100
Flammability	B1.101 – B1.102
Radiation/Moisture/Temperature/Tensile Strength	B1.103
Chemical Resistance Table	B1.104 – B1.107
<b>Manual Cable Tie Installation Tools</b>	B1.109
Selection Guide – Hand Tools, Accessories, and Kits	B1.110
Cable Tie Tools – Tool Controlled Tension and Cut-Off	B1.111
Cable Tie Tools – Installer Controlled Tension and Cut-Off	B1.112
Pneumatic Hand Tools – Tool Controlled Tension and Cut-Off	B1.113
Hand Tool Accessories	B1.113
Tool Tension Locking Kits	B1.114
Blade Replacement Kits	B1.114
Hand Tool Holster	B1.114

★ Represents new product offering.

A.  
System  
Overview

## Table of Contents

B1. Cable Ties	Cushion Sleeve Kits . . . . .	B1.114
	<b>Automatic Cable Tie Installation Systems</b> . . . . .	B1.115
	Selection Guide – Automatic Installation Systems and Reel-Fed Cable Ties . . . . .	B1.116
	Tool Head . . . . .	B1.117
B2. Cable Accessories	Dispenser . . . . .	B1.117
	Transfer Hose . . . . .	B1.118
	Dispenser Frame . . . . .	B1.118
	Filter/Regulator and Air Supply Hose . . . . .	B1.118
	Bench Mount . . . . .	B1.118
B3. Stainless Steel Ties	Data Interface Software and Ethernet Enabled Dispenser . . . . .	B1.119
	PAT/Robot Integration Kit . . . . .	B1.119
	BT-XMR Reel-Fed Cable Ties . . . . .	B1.120
	PLT-XMR Reel-Fed Cable Ties . . . . .	B1.121
C1. Wiring Duct	PLT-VMR Reel-Fed Cable Ties . . . . .	B1.122

## Cable Accessories

	<b>Cable Accessories</b> . . . . .	B2.1
C2. Surface Raceway	Cable Accessories Products Overview . . . . .	B2.2 – B2.3
	4-Way Adhesive Backed Cable Tie Mounts . . . . .	B2.4 – B2.5
	ABMQ Multiple Bridge Mounts . . . . .	B2.6
	Tak-Ty® Hook & Loop Cable Tie Mounts . . . . .	B2.6
C3. Abrasion Protection	Super-Grip® Adhesive Back Mounts . . . . .	B2.7
	Combination Adhesive Mount/Cable Ties . . . . .	B2.8
	Snap-In Cable Tie Mounts – Mechanically Applied . . . . .	B2.8
	Epoxy Applied Mounts . . . . .	B2.9
	Epoxy Applied Swivel Mount . . . . .	B2.9
C4. Cable Management	Epoxy Applied Cable Tie Mount Kits . . . . .	B2.9
	Tie Mounts – Applied with User Supplied Adhesives . . . . .	B2.10
	Low Profile Mounts – Screw Applied . . . . .	B2.10
	Cable Tie Mounts – Screw Applied . . . . .	B2.11
D1. Terminals	Extra-Heavy Cable Tie Mounts – Screw Applied . . . . .	B2.12
	Swivel Mounts . . . . .	B2.12
	4-Way Tie Anchor Mounts – Screw Applied . . . . .	B2.13
	Tie Anchor Mounts . . . . .	B2.13
D2. Power Connectors	Low Profile Mounts – Screw Applied . . . . .	B2.13
	Low Profile Mounts – Push Rivet Applied . . . . .	B2.14
	Cable Tie Plates . . . . .	B2.15
	Multiple Tie Plates . . . . .	B2.15 – B2.16
	Contour Multiple Tie Plates . . . . .	B2.16
D3. Grounding Connectors	Right Angle Mounts . . . . .	B2.17
	Lightening Hole Mounts . . . . .	B2.17
	Stud Tie Mounts . . . . .	B2.18
	Metal Clip-On Mounts . . . . .	B2.18
	Metal Screw-On Mount . . . . .	B2.19
E1. Labeling Systems	Push Barb Cable Tie Mounts . . . . .	B2.19
	Push Mounts . . . . .	B2.20
	Push Button Mount . . . . .	B2.20
	Masonry Push Mounts . . . . .	B2.21
E2. Labels	Wood Push Mount . . . . .	B2.21
	Fir Tree Push Mounts . . . . .	B2.22
	Fir Tree Push Mount Assemblies . . . . .	B2.22
	Control Panel Mounts . . . . .	B2.23
E3. Pre-Printed & Write-On Markers	Pan-Post™ Standoff . . . . .	B2.23
	Flat Pan-Post™ Standoffs . . . . .	B2.24
	Right Angle Bases . . . . .	B2.24
	Flat Cable Mounting System – FCB Base and FCPI Plate . . . . .	B2.25
	Closed Connector Rings . . . . .	B2.26
E4. Permanent Identification	Open Connector Ring . . . . .	B2.26
	Cable Spacers . . . . .	B2.26
	Cable Spacer Cross . . . . .	B2.27
	Stackable Aerial Cable Spacer . . . . .	B2.27
E5. Lockout/ Tagout & Safety Solutions	Aerial Support Ties – Weather Resistant Polypropylene . . . . .	B2.28
	Permanent Marking Pens . . . . .	B2.28
	Marker Plates – Loose Piece . . . . .	B2.29
	Cable and Wire Mounting Devices (used without cable ties) . . . . .	B2.30
	Adhesive Backed Mounting Devices . . . . .	B2.30
F. Index	Clincher™ Adjustable Releasable Clamp . . . . .	B2.30

★ Represents new product offering.

## Table of Contents

Adhesive Backed Cord Clips .....	B2.31
Push Mount Cord Clip .....	B2.31
“J” Clips .....	B2.32
A1C Type Clips .....	B2.32
A2C Type Clips .....	B2.33
Metal Adhesive Backed Cord Clips .....	B2.33
Latching Wire Clips .....	B2.34
Bevel Entry Clips .....	B2.35
Adhesive Backed Dual Cord Clip .....	B2.36
Adhesive Backed Mount Cord Clip .....	B2.36
Vertical Cord Clips .....	B2.36
Adhesive Backed Latching Clips .....	B2.37
Cable Holder – Adhesive Backed .....	B2.37
Low Profile Flat Cable Mounts .....	B2.37
Latching Flat Cable Mounts .....	B2.38
Latching Flat Cable Holders .....	B2.38
Flat Cable Clips .....	B2.39
Pan-Clamp™ Heavy Duty Fixed Diameter Clamps .....	B2.39
Fixed Diameter Cable Clamps .....	B2.40
Wire Retainers .....	B2.41
Siding Clips .....	B2.42
Wire Standoffs .....	B2.42
Snap-In Clips .....	B2.43
Wire Saddles .....	B2.43
★ Corrugated Tubing Holder with Push Mount .....	B2.44
Harness Clips .....	B2.44
Optical Fiber Network Saddles .....	B2.45
Nylon Edge Clips .....	B2.45
Wire Bundle Strap .....	B2.45
Circuit Board Posts .....	B2.46
Circuit Board Locking Supports .....	B2.46
<b>Harness Board Accessories</b> .....	B2.47
Elastic Retainers .....	B2.47
Elastic Retainers – ER Type .....	B2.47
Bundle Retainers .....	B2.48
Corner Posts .....	B2.48
T-Junction Fixture .....	B2.48
Wire End Holder .....	B2.49
Harness Board Nails .....	B2.49
Fanning Strip System .....	B2.50
Spring Wire Breakout System .....	B2.50
Tie Harness Mounts .....	B2.51
Harness Board Standoff Posts and Adapter .....	B2.51
★ Automatic Cable Tie Mounts .....	B2.52
★ Harness Board Fixtures .....	B2.52
Physical Properties and Colors of Cable Accessory Materials .....	B2.53
Application Chart .....	B2.53
Selection and Use of Adhesive Mounts .....	B2.54 – B2.55

## Stainless Steel Cable Ties and Accessories

<b>Pan-Steel® System</b> .....	B3.1
Pan-Steel® Products Overview .....	B3.2 – B3.3
Features and Benefits – Pan-Steel® Cable Ties .....	B3.4
Part Number System for Pan-Steel® Cable Ties .....	B3.5
Pan-Steel® Self-Locking Cable Ties – MLT Series .....	B3.5 – B3.7
Pan-Steel® Polyester Fully Coated Cable Ties – MLTFC Series .....	B3.8
Pan-Steel® Nylon 11 Selectively Coated Ties – MLTC Series .....	B3.9
Pan-Alum™ Aluminum Cable Ties – MLT Series .....	B3.10
Pan-Steel® Double Wrapped Cable Ties – MLTD Series .....	B3.11
Pan-Steel® Custom Length Banding – MBS, MBH, MBEH and MBSH Series .....	B3.12 – B3.13
Pan-Steel® Custom Length Banding Heads – MTH Series .....	B3.13
GS4MT Hand Operated Installation Tool .....	B3.14
Tool Tension Locking Kits .....	B3.14
ST2MT Installation Tool .....	B3.15
RT2HT and RT2HTN Installation Tools .....	B3.15
HTMT Installation Tool .....	B3.15
PPTMT Pneumatic Installation Tool .....	B3.16

★ Represents new product offering.

A.  
System  
Overview

## Table of Contents

B1.  
Cable Ties

★ PBTMT Battery Powered Installation Tools	B3.16
Features and Benefits – Pan-Steel® Retained Tension Ties – MRT/MRS Series	B3.17
Part Number System for Pan-Steel® Retained Tension Ties – MRT Series	B3.18

B2.  
Cable  
Accessories

★ Pan-Steel® Retained Tension Ties – MRT Series	B3.18
Part Number System for Pan-Steel® 360° Radial Seal Retained Tension Ties – MRS Series	B3.19
★ Pan-Steel® 360° Radial Seal Retained Tension Ties – MRS Series	B3.19
Retained Tension Installation Tools	B3.20
Features and Benefits – Pan-Steel® Strapping System	B3.21

B3.  
Stainless  
Steel Ties

★ The Panduit Method Reduces Installation Time	B3.22
Part Number System for Discrete Length Strapping	B3.22
★ Pan-Steel® Strapping – MS Series	B3.23
Pan-Steel® Nylon 11 Coated Strapping – MSC Series	B3.24
★ Pan-Steel® Custom Length Strapping	B3.25

C1.  
Wiring  
Duct

★ Pan-Steel® Buckles for Custom Length Strapping	B3.25
BT2HT Hand Operated Installation Tool for Strapping	B3.26
★ BT75SDT Hand Operated Installation Tool for MS75 Strapping	B3.26
PCS Cushion Sleeve	B3.26

C2.  
Surface  
Raceway

Stainless Steel Tie Mounts	B3.27
Stainless Steel Push Mount	B3.27
Stainless Steel Push Button Mount	B3.28
Stainless Steel 2-Way Tie Mount	B3.28
Stainless Steel Bulkhead Mount	B3.29

C3.  
Abrasion  
Protection

Stainless Steel Technical Information	B3.30
Panduit Stainless Steel Cable Tie and Strapping Approvals	B3.30
Chemical Resistance at 70°F (21°C) Temperature	B3.31
Rigorous Tests and Physical Properties of Stainless Steel	B3.32

C4.  
Cable  
Management

Military Cross Reference (AS23190)	B3.32
------------------------------------	-------

## Wiring Duct

<b>Wiring Duct</b>	C1.1
--------------------	------

D1.  
Terminals

Wiring Duct for Control Panel Applications	C1.2 – C1.3
Features and Benefits – Panduct® PanelMax™ DIN Rail Wiring Duct	C1.4

D2.  
Power  
Connectors

★ Panduct® PanelMax™ DIN Rail Wiring Duct	C1.5
Features and Benefits – Panduct® PanelMax™ Noise Shield	C1.6
★ Panduct® PanelMax™ Noise Shield	C1.7
Features and Benefits – Panduct® PanelMax™ Corner Wiring Duct	C1.8
PanelMax™ Corner Wiring Duct	C1.9

D3.  
Grounding  
Connectors

Features and Benefits – Panduct® Type H and HN Hinged Cover Wiring Duct	C1.10
Panduct® Type HN Hinged Cover Narrow Slot Wiring Duct	C1.11
Panduct® Type H Hinged Cover Wide Slot Wiring Duct	C1.11
Panduct® Type HS Hinged Cover Solid Wall Raceway	C1.11
Features and Benefits – Panduct® Type G Wide Slot Wiring Duct	C1.12
Panduct® Type G Wide Slot Wiring Duct	C1.13

E1.  
Labeling  
Systems

Features and Benefits – Panduct® Type F Narrow Slot Wiring Duct	C1.14
Panduct® Type F Narrow Slot Wiring Duct	C1.15
Features and Benefits – Panduct® Flush Cover Type D Round Hole Wiring Duct	C1.16
Panduct® Flush Cover Type D Round Hole Wiring Duct	C1.17
Features and Benefits – Panduct® Type MC Metric Narrow Slot Wiring Duct	C1.18

E2.  
Labels

Panduct® Type MC Metric Narrow Slot Wiring Duct	C1.19
Features and Benefits – Panduct® Type FS Solid Wall Raceway	C1.20
Panduct® Type FS Solid Wall Raceway	C1.21
Wiring Duct for Special Environments	C1.22 – C1.24

E3.  
Pre-Printed  
& Write-On  
Markers

Features and Benefits – Panduct® Type NNC Halogen-Free Metric Wiring Duct	C1.22
Panduct® Type NNC Halogen-Free Metric Wiring Duct	C1.23
Panduct® Type NNC Divider Wall	C1.23
Panduct® Type NE Halogen-Free Wiring Duct	C1.24

E4.  
Permanent  
Identification

<b>Wiring Duct Tools and Accessories</b>	C1.25
Panduct® Type FL Flexible Wiring Duct	C1.26
Panduct® Divider Wall	C1.26
Panduct® Type NNC Divider Wall	C1.27
Panduct® Type G and H Wiring Duct Wire Retainers	C1.28

E5.  
Lockout/  
Tagout  
& Safety  
Solutions

Panduct® Solid Wall Raceway Type FS and Type D Wiring Duct Wire Retainer	C1.28
Panduct® Type F, HN, and MC Duct Wire Retainers/Labeling Device	C1.29
Panduct® Duct Corner Strip with 1 Inch Bend Radius Control	C1.29
Panduct® Duct Corner Strips	C1.30
Panduct® Snap-Clip Mounting Brackets	C1.31

★ Represents new product offering.

## Table of Contents

Panduct® Snap-Clip Mounting Bracket – Type NE Wiring Duct	C1.31
Adhesive Tape for Wiring Duct	C1.32
Specifications for Factory Applied Tape	C1.32
Adhesive Tape Guide	C1.33
Panduct® Installation Tools	C1.34
Panduct® PanelMax™ DIN Rail Wiring Duct Dimensions	C1.35
Panduct® PanelMax™ Noise Shield Dimensions	C1.35
Panduct® PanelMax™ Corner Wiring Duct Dimensions	C1.35
Panduct® Type G and D Wiring Duct Dimensions	C1.36
Panduct® Type F Wiring Duct and FS Raceway Dimensions	C1.37
Panduct® Type MC Wiring Duct Dimensions	C1.38
Panduct® Type NNC Wiring Duct Dimensions	C1.39
Panduct® Type NE Wiring Duct Dimensions	C1.40
Panduct® Type H and HS Wiring Duct Dimensions	C1.41
Panduct® Type HN Wiring Duct Dimensions	C1.41
Panduct® Type FL Wiring Duct Dimensions	C1.42
Panduct® PanelMax™ DIN Rail Wiring Duct – Wirefill Capacity	C1.42
Panduct® PanelMax™ Corner Wiring Duct – Wirefill Capacity	C1.42
Panduct® Type H, HN and HS Wiring Duct – Wirefill Capacity	C1.42
Panduct® Type D, G, F and FS Wiring Duct – Wirefill Capacity	C1.43
Panduct® Type MC and NNC Wiring Duct – Wirefill Capacity	C1.44
Panduct® Type NE Wiring Duct – Wirefill Capacity	C1.45
Panduct® Type FL Wiring Duct – Wirefill Capacity	C1.45
Wirefill Formula	C1.46
Panduct® Wiring Duct and Raceway – Material Specifications	C1.47
Panduct® Wiring Duct and Raceway – Color and Size Selection	C1.48
Installation Tips	C1.49
Part Number System for Panduct® Wiring Duct	C1.49
Part Number System for Panduct® PanelMax™ DIN Rail Wiring Duct	C1.50
Part Number System for Panduct® PanelMax™ Corner Wiring Duct	C1.50
Panduct® Wiring Duct Approvals and Compliance	C1.51 – C1.52
<b>Fiber-Duct™ Routing System</b>	C1.53
2x2 and 4x4 Fiber-Duct™ Routing Systems Roadmap	C1.54 – C1.55
2x2 and 4x4 Fiber-Duct™ Routing Systems	C1.56
Fiber-Duct™ System Fittings	C1.56 – C1.57
Fiber-Duct™ Spillouts	C1.58
Fiber-Duct™ Bend Radius Control Trumpets	C1.59
Fiber-Duct™ Accessories	C1.59
Fiber-Duct™ Mounting Brackets	C1.60 – C1.61
Cable Fills 2x2 and 4x4 Fiber-Duct™ Cable Routing Systems	C1.62

## Surface Raceway

<b>Pan-Way® Metal Raceway</b>	C2.1
PMR40 Raceway Roadmap	C2.2 – C2.3
PMR40 Configurations	C2.4
Pan-Way® PMR40 Metal Raceway System	C2.5
Pan-Way® PMR40 Metal Raceway Fittings	C2.5 – C2.6
Cable Fill Capacities for PMR40 Metal Raceway	C2.7
PMR5/7 Raceway Roadmap	C2.8 – C2.9
PMR5/PMR7 Configurations	C2.10
Pan-Way® PMR5/PMR7 Metal Raceway System	C2.11
Pan-Way® PMR5/PMR7 Metal Raceway Fittings	C2.12
PMR5 and PMR7 Raceway Accessories	C2.13
Cable Fill Capacities for PMR5/PMR7 Metal Raceway	C2.14
Pan-Way® Metal Raceway Boxes	C2.15 – C2.16
Pan-Way® Metal Raceway Faceplates	C2.17
<b>Pan-Way® Non-Metallic Surface Raceway</b>	C2.18
<b>Pan-Way® TG-70 Non-Metallic Surface Raceway</b>	C2.19
TG-70 Raceway Roadmap	C2.20 – C2.21
TG-70 Configurations	C2.22 – C2.23
Pan-Way® TG-70 Surface Raceway System	C2.24
Pan-Way® TG-70 Raceway Fittings	C2.25
Pan-Way® TG-70 Raceway Accessories	C2.26
Cable Fill Capacities for TG-70 Raceway	C2.27
<b>Pan-Way® T-70 and Twin-70 Non-Metallic Surface Raceway</b>	C2.29
T-70 Raceway Roadmap	C2.30 – C2.31
T-70 Configurations	C2.32 – C2.33

★ Represents new product offering.

## Table of Contents

A.  
System  
Overview

B1.  
Cable Ties

B2.  
Cable  
Accessories

B3.  
Stainless  
Steel Ties

C1.  
Wiring  
Duct

C2.  
Surface  
Raceway

C3.  
Abrasion  
Protection

C4.  
Cable  
Management

D1.  
Terminals

D2.  
Power  
Connectors

D3.  
Grounding  
Connectors

E1.  
Labeling  
Systems

E2.  
Labels

E3.  
Pre-Printed  
& Write-On  
Markers

E4.  
Permanent  
Identification

E5.  
Lockout/  
Tagout  
& Safety  
Solutions

F.  
Index

Twin-70 Raceway Roadmap . . . . .	C2.34 – C2.35
Pan-Way® T-70 Surface Raceway System . . . . .	C2.36
Pan-Way® T-70 Raceway Fittings . . . . .	C2.36 – C2.37
Pan-Way® Twin-70 Surface Raceway System . . . . .	C2.38
Pan-Way® Twin-70 Raceway Fittings . . . . .	C2.39
Pan-Way® T-70 and Twin-70 Raceway Accessories . . . . .	C2.40
Cable Fill Capacities for T-70 Raceway . . . . .	C2.41
Cable Fill Capacities for Twin-70 Raceway . . . . .	C2.42
<b>Pan-Way® T-45 Non-Metallic Surface Raceway</b> . . . . .	C2.43
T-45 Raceway Roadmap . . . . .	C2.44 – C2.45
T-45 Configurations . . . . .	C2.46 – C2.47
Pan-Way® T-45 Surface Raceway System . . . . .	C2.48
Pan-Way® Type T-45 Raceway Fittings . . . . .	C2.49
Cable Fill Capacities for T-45 Raceway . . . . .	C2.50
<b>Pan-Way® Snap-On Faceplates and Surface Mount Outlet Boxes</b> . . . . .	C2.51
Pan-Way® Fast-Snap™ Surface Mount Outlet Boxes . . . . .	C2.52
Pan-Way® Classic Series Snap-On Faceplates for Use with Panduit® Mini-Com® Modules . . . . .	C2.52
Component Labels for Pan-Way® Classic Series Snap-On Faceplates for Use with Panduit® Mini-Com® Modules and Inserts . . . . .	C2.52
Pan-Way® Classic Series Snap-On Faceplates for Use with Panduit® Mini-Com® Inserts . . . . .	C2.53
Pan-Way® Classic Series Snap-On Faceplates for Communication/Power . . . . .	C2.53
Panduit® NetKey® Snap-On Sloped Keystone Faceplates . . . . .	C2.54
Panduit® NetKey® Snap-On Flush Universal Keystone Faceplates . . . . .	C2.54
Component Labels for Snap-On “Sloped” (Keystone) Faceplates and Snap-On “Flush” Universal (Keystone) Faceplates . . . . .	C2.54
Pan-Way® Snap-On Faceplates for SYSTIMAX® Communication Modules . . . . .	C2.55
Component Labels for Pan-Way® Snap-On Faceplates for use with SYSTIMAX® Communication Modules . . . . .	C2.55
Pan-Way® Snap-On Faceplates for Nordx/CDT** Communication Modules . . . . .	C2.56
Pan-Way® Low Voltage Surface Mount Outlet Boxes . . . . .	C2.57
Pan-Way® Power Rated Surface Mount Outlet Boxes . . . . .	C2.58 – C2.59
Pan-Way® Classic Series Faceplates for Power and Communication Applications . . . . .	C2.60
Component Labels for Pan-Way® Classic Series Faceplates for Power and Communication Applications . . . . .	C2.60
Pan-Way® Stainless Steel Faceplates . . . . .	C2.61
Pan-Way® Electrical Outlets . . . . .	C2.61
Pan-Way® Surface Mount Outlet Box with 20 A Electrical Outlet . . . . .	C2.61
Selection Chart for using Pan-Way® Surface Raceway with Pan-Way® Surface Mount Outlet Boxes . . . . .	C2.62
<b>Pan-Way® LD Profile Non-Metallic Surface Raceway</b> . . . . .	C2.63
LD2P10 Profile Raceway Roadmap . . . . .	C2.64 – C2.65
LD2P10 Configurations . . . . .	C2.66 – C2.67
LD Profile Raceway Roadmap . . . . .	C2.68 – C2.69
LD Configurations . . . . .	C2.70 – C2.71
LDPH Profile Raceway Roadmap . . . . .	C2.72 – C2.73
LDPH Configurations . . . . .	C2.74
Pan-Way® Type LD2P10 Multi-Channel Surface Raceway System . . . . .	C2.75
Multi-Channel Fittings for LD2P10 . . . . .	C2.75
Pan-Way® LD Surface Raceway System . . . . .	C2.76
Pan-Way® LDPH Surface Raceway System . . . . .	C2.77
Pan-Way® LDS Surface Raceway System . . . . .	C2.78
Method for Bending Type LDS Raceway (Low Voltage Applications) . . . . .	C2.78
Standard Fittings for Low Voltage Applications . . . . .	C2.79
One Inch Bend Radius Fittings for TIA/EIA Compliance . . . . .	C2.80
Power Rated Fittings for Power to 600 V – LDPH/LDS/LD2P Raceway Only . . . . .	C2.81
Raceway Adapters for LD Raceway . . . . .	C2.82
Cable Fill Capacities for LD Profile Raceway . . . . .	C2.82
★ Floor Guard . . . . .	C2.83
Pan-Way® Surface Raceway Cutting Tool . . . . .	C2.83
Foam Tape . . . . .	C2.84
<b>Pan-Way® Cove Raceway</b> . . . . .	C2.85
Cove Raceway Roadmap . . . . .	C2.86 – C2.87
Cove Configurations . . . . .	C2.88 – C2.89
Pan-Way® Cove Raceway System . . . . .	C2.90
Pan-Way® Cove Raceway Fittings . . . . .	C2.91
Cable Fill Capacities for Cove Raceway . . . . .	C2.92
<b>Pan-Way® Office Furniture Raceway</b> . . . . .	C2.93
Office Furniture Raceway Roadmap . . . . .	C2.94 – C2.95
Office Furniture Configurations . . . . .	C2.96 – C2.97

\*SYSTIMAX is a registered trademark of Commscope, Inc.

\*\*Nordx/CDT is a registered trademark of Nordx/CDT, Inc.

★ Represents new product offering.



## Table of Contents

Pan-Way® Office Furniture Raceway System .....	C2.98
Pan-Way® Office Furniture Raceway Fittings .....	C2.98 – C2.101
Cable Fill Capacities for Office Furniture Raceway .....	C2.102
<b>Pan-Pole™ Power and Communication Poles</b> .....	C2.103
Pan-Pole™ Power Pole .....	C2.104
Installation of Communication Outlets on Pan-Pole™ Power Pole .....	C2.105 – C2.106
Pan-Pole™ Communication Pole .....	C2.107
Installation of Communication Outlets on Pan-Pole™ Communication Pole .....	C2.108 – C2.109
Pan-Pole™ Extension Kits .....	C2.110
Pan-Pole™ Power Addition Kits and Standard Faceplate Bracket .....	C2.110
Pan-Pole™ Replacement Parts .....	C2.111
Cable Fill Capacities for Pan-Pole™ Power and Communication Poles .....	C2.112

## Abrasion Protection

<b>Abrasion Protection</b> .....	C3.1
Pan-Wrap™ Split Harness Wrap .....	C3.2
Pan-Wrap™ Installation Tools .....	C3.3
Part Number System for Spiral Wrap .....	C3.3
Spiral Wrap .....	C3.4 – C3.7
Part Number System for Grommet Edging .....	C3.8
Grommet Edging .....	C3.8 – C3.10
Part Number System for Corrugated Loom Tubing .....	C3.11
Corrugated Loom Tubing – Slit and Solid Wall .....	C3.11 – C3.13
Corrugated Loom Tubing Fittings .....	C3.14
Part Number System for Braided Expandable Sleeving .....	C3.14
Braided Expandable Sleeving – Polyethylene Terephthalate (PET) .....	C3.15
Braided Expandable Sleeving – Flame Retardant Polyethylene Terephthalate .....	C3.16
Tooling Head .....	C3.16
Fray Resistant Braided Expandable Sleeving .....	C3.17
Part Number System for Non-Shrink PVC Tubing .....	C3.18
Non-Shrink PVC Tubing .....	C3.18
Duct Seal – Sealing Compounds .....	C3.18
Flammability Tests and Materials Classification .....	C3.19
Abrasion Protection Materials Technical Data .....	C3.20 – C3.21
Panduit® Heat Shrink Tubing Selection Guide .....	C3.22
Part Number System for Thin Wall Heat Shrink .....	C3.23
HSTT Heat Shrink 4 Foot Pieces and Reels .....	C3.24 – C3.25
HSTT Heat Shrink on 25 Foot Reels .....	C3.25
Heat Shrink in 6 Inch Pieces; Black, Single Diameter .....	C3.26
Heat Shrink in 6 Inch Pieces; Multi-Color, Single Diameter .....	C3.26
Heat Shrink in 6 Inch Pieces; Black, Multiple Diameters .....	C3.27
Heat Shrink in 6 Inch Pieces; Yellow/Green Stripe, Multiple Diameters .....	C3.27
HSTTV Heat Shrink 4 Foot Pieces .....	C3.28
HSTTV Heat Shrink on 100 Foot Reels .....	C3.29
HSTTV Heat Shrink on Bulk Reels .....	C3.30
HSTTV Heat Shrink on 25 Foot Reels .....	C3.31
HSTTV Heat Shrink 6 Inch Pieces .....	C3.31
HSTTP PVC Heat Shrink .....	C3.32
HSTTPN Crystal Clear PVC Heat Shrink .....	C3.33
HSTTN Neoprene Heat Shrink .....	C3.33
TEFLON▲ Heat Shrink .....	C3.34
HSTTK KYNAR* Heat Shrink 4 Foot .....	C3.35
HSTTVA Heat Shrink 4 Foot Pieces and 6 Inch Pieces .....	C3.35 – C3.36
HSTTA Heat Shrink 4 Foot and 6 Inch Pieces .....	C3.36
HSTT4A Heat Shrink 4 Foot Pieces .....	C3.37
HSTTRA Heat Shrink 4 Foot Pieces .....	C3.37
Thick Wall Polyolefin Heat Shrink .....	C3.38
Heat Shrink End Caps .....	C3.39
Plastic Heat Shrink Tubing Kit Boxes – For Dry Locations .....	C3.40
Heat Shrink Tools and Accessories .....	C3.40
Heat Shrink Process Defined .....	C3.41
Heat Shrink Installation Instructions .....	C3.42
Recommended Tubing Size for Common Wire Types Based on Location .....	C3.43
Dry-Shrink™, Damp-Shrink™, and Wet-Shrink™ Heat Shrink Tubing Technical Data .....	C3.44

## Cable Management

▲TEFLON is a registered trademark of E.I. du Pont de Nemours and Company. \*KYNAR is a registered trademark of Atofina Chemicals, Inc.

★ Represents new product offering.

A.  
System  
Overview

## Table of Contents

B1. Cable Ties	<b>Cable Management</b> . . . . .	C4.1
	Cool Boot™ Raised Floor Assembly . . . . .	C4.2 – C4.3
	J-Pro™ Cable Support System . . . . .	C4.4 – C4.7
	J-Mod® Cable Support System . . . . .	C4.8
B2. Cable Accessories	★ Bridle Rings and Fastening Clip . . . . .	C4.9
	★ Low Voltage Mounting Brackets . . . . .	C4.9
	★ Metal Stud Accessories . . . . .	C4.10
	Conduit Waterfall . . . . .	C4.10
	Waterfall Accessories . . . . .	C4.11
B3. Stainless Steel Ties	Double Waterfall Accessory . . . . .	C4.11
	Stackable Cable Rack Spacers . . . . .	C4.12
	Threaded Rod Cover . . . . .	C4.12
	Vertical D-Rings . . . . .	C4.13
C1. Wiring Duct	Tak-Ty® Hook & Loop Cable Tie Mounts . . . . .	C4.13
	Flat Pan-Post™ Standoffs . . . . .	C4.14
	Communication Cable Management Kit for Cabinets . . . . .	C4.14

## Terminals

C2. Surface Raceway	<b>Pan-Term® Terminals</b> . . . . .	D1.1
	Features and Benefits – Pan-Term® Terminals . . . . .	D1.2
	Selection Guide – Pan-Term® Ring Terminals . . . . .	D1.3
C3. Abrasion Protection	Selection Guide – Pan-Term® Fork Terminals . . . . .	D1.4
	Part Number System for Pan-Term® Terminals . . . . .	D1.5
	Ring Terminal, Nylon Insulated . . . . .	D1.6
	Ring Terminal, Nylon Insulated – Funnel Entry . . . . .	D1.7
	Ring Terminal, Nylon Insulated – Expanded Insulation . . . . .	D1.8
C4. Cable Management	Multiple Stud Terminal, Nylon Insulated . . . . .	D1.8
	Ring Terminal, Vinyl Insulated – Funnel Entry . . . . .	D1.9
	Ring Terminal, Vinyl Expanded Insulation . . . . .	D1.10
	Multiple Stud Terminal, Vinyl Insulated – Funnel Entry . . . . .	D1.11
	Ring Terminal, KYNAR* Insulated . . . . .	D1.12
D1. Terminals	Heat Shrink, Ring Terminal . . . . .	D1.13
	Ring Terminal, Heavy Duty, Nylon Insulated . . . . .	D1.13
	Ring Terminal, Heavy Duty, Vinyl Insulated – Funnel Entry . . . . .	D1.14
	Ring Terminal, Large Wire, Vinyl Insulated . . . . .	D1.15
	Ring Terminal, Large Wire, Vinyl Expanded Insulation . . . . .	D1.16
D2. Power Connectors	Ring Terminal, Non-Insulated . . . . .	D1.17
	Multiple Stud Terminal, Non-Insulated . . . . .	D1.18
	Ring Terminal, Non-Insulated – High Temperature . . . . .	D1.19
	Ring Terminal, Heavy Duty Non-Insulated . . . . .	D1.20
D3. Grounding Connectors	Ring Terminal, Large Wire Non-Insulated . . . . .	D1.20
	Tubular Ring Terminal, Non-Insulated . . . . .	D1.21
	Fork Terminal, Nylon Insulated . . . . .	D1.22
	Fork Terminal, Nylon Insulated – Funnel Entry . . . . .	D1.22
	Fork Terminal, Vinyl Insulated – Funnel Entry . . . . .	D1.23
E1. Labeling Systems	Fork Terminal, Vinyl Insulated – Expanded Insulation . . . . .	D1.24
	Locking Fork Terminal, Nylon Insulated . . . . .	D1.24
	Locking Fork Terminal, Nylon Insulated – Funnel Entry . . . . .	D1.25
	Locking Fork Terminal, Vinyl Insulated – Funnel Entry . . . . .	D1.25
E2. Labels	Locking Fork Terminal, Vinyl Insulated – Expanded Insulation . . . . .	D1.26
	Short Locking Fork Terminal, Nylon Insulated . . . . .	D1.26
	Short Locking Fork Terminal, Nylon Insulated – Funnel Entry . . . . .	D1.27
	Short Locking Fork Terminal, Vinyl Insulated – Funnel Entry . . . . .	D1.27
E3. Pre-Printed & Write-On Markers	Flanged Fork Terminal, Nylon Insulated . . . . .	D1.28
	Flanged Fork Terminal, Vinyl Insulated – Funnel Entry . . . . .	D1.28
	Fork Terminal, Non-Insulated . . . . .	D1.29
	Flanged Fork Terminal, Non-Insulated . . . . .	D1.30
E4. Permanent Identification	Locking Fork Terminal, Non-Insulated . . . . .	D1.30
	Short Locking Fork Terminal, Non-Insulated . . . . .	D1.31
	Heat Shrink, Fork Terminal . . . . .	D1.31
	Features and Benefits – Pan-Term® Metric Terminals . . . . .	D1.32
	Part Number System for Pan-Term® Metric Terminals . . . . .	D1.33
E5. Lockout/ Tagout & Safety Solutions	Metric Ring Terminal, Nylon Insulated – Funnel Entry . . . . .	D1.33
	Metric Ring Terminal, Vinyl Insulated – Funnel Entry . . . . .	D1.34
	Metric Ring Terminal, Non-Insulated . . . . .	D1.34
	Metric Fork Terminal, Nylon Insulated – Funnel Entry . . . . .	D1.35
	Metric Fork Terminal, Vinyl Insulated – Funnel Entry . . . . .	D1.35
F. Index	Metric Fork Terminal, Non-Insulated . . . . .	D1.36

★ Represents new product offering.

\*KYNAR is a registered trademark of Atofina Chemicals, Inc.

## Table of Contents

Plastic Box Terminal Kits .....	D1.36
★ Fabric Terminal Kit .....	D1.36
Steel Kit Boxes .....	D1.37
Steel Slide Racks .....	D1.37
Industrial Maintenance Kits .....	D1.38
<b>Pan-Term® Disconnects</b> .....	D1.39
Features and Benefits – Pan-Term® Disconnects .....	D1.40 – D1.41
Selection Guide – Pan-Term® Disconnects .....	D1.42
Part Number System for Pan-Term® Disconnects .....	D1.43
Supra-Grip™ Female Disconnect, Nylon Fully Insulated – Funnel Entry .....	D1.43
Disco-Lok™ Female Disconnect, Nylon Fully Insulated – Funnel Entry .....	D1.44
Male/Female Coupler, Nylon Fully Insulated – Funnel Entry .....	D1.44
Female Disconnect Nylon Fully Insulated – Funnel Entry .....	D1.45
Female Disconnect, Nylon Fully Insulated – Funnel Entry, Metal Collar .....	D1.45
DiscoGrip™ Male Disconnect, Premium Nylon Fully Insulated – Funnel Entry .....	D1.46
DiscoGrip™ Female Disconnect, Premium Nylon Fully Insulated – Funnel Entry .....	D1.46
Heat Shrink Disconnects, Fully Insulated – Funnel Entry .....	D1.47
Female Disconnect, Nylon Barrel Insulated – Funnel Entry .....	D1.47
Female Disconnect, Vinyl Barrel Insulated – Funnel Entry .....	D1.48
Female Disconnect, Vinyl Barrel Insulated – Butted Seam .....	D1.48
Female Disconnect, Non-Insulated – Metal Sleeve .....	D1.49
Right Angle Female Disconnect, Nylon Fully Insulated – Funnel Entry .....	D1.49
Right Angle Female Disconnect, Nylon Insulated – Funnel Entry .....	D1.50
Right Angle Female Disconnect, Non-Insulated – Metal Sleeve .....	D1.50
Right Angle Female Disconnect Non-Insulated .....	D1.51
Piggyback Disconnect, Vinyl Insulated .....	D1.51
Disconnect Adapter, Non-Insulated .....	D1.51
Male Disconnect, Nylon Barrel Insulated – Funnel Entry .....	D1.52
Male Disconnect, Vinyl Barrel Insulated – Funnel Entry .....	D1.52
Male Disconnect, Non-Insulated – Butted Seam .....	D1.53
Selection Guide – Specialty Terminals .....	D1.54
Pin Terminal, Vinyl Insulated – Funnel Entry .....	D1.54
Pin Terminal, Non-Insulated .....	D1.54
Male Blade Adapter, Vinyl Insulated – Funnel Entry .....	D1.55
Male Blade Adapter, Non-Insulated .....	D1.55
Features and Benefits – Pan-Term® Metric Disconnects .....	D1.56
Part Number System for Pan-Term® Metric Disconnects .....	D1.57
Female Metric Disconnect, Fully Insulated Nylon – Funnel Entry .....	D1.57
Female Metric Disconnect, Nylon Barrel Insulated – Funnel Entry .....	D1.58
Female Metric Disconnect, Vinyl Barrel Insulated – Funnel Entry .....	D1.58
Female Metric Disconnect, Non-Insulated – Metal Sleeve .....	D1.58
Piggyback Metric Disconnect, Vinyl Barrel Insulated .....	D1.59
Male Metric Disconnect, Fully Insulated Nylon – Funnel Entry .....	D1.59
Male Metric Disconnect, Nylon Barrel Insulated – Funnel Entry .....	D1.59
Male Metric Disconnect, Non-Insulated – Butted Seam .....	D1.60
Metric Pin Terminal, Vinyl Insulated – Funnel Entry .....	D1.60
Metric Pin Terminal, Non-Insulated .....	D1.60
<b>Pan-Term® Splices</b> .....	D1.61
Features and Benefits – Pan-Term® Splices and Wire Joints .....	D1.62 – D1.63
Selection Guide – Pan-Term® Splices and Wire Joints .....	D1.64
Part Number System for Pan-Term® Splices .....	D1.64
Part Number System for Pan-Term® Wire Joints .....	D1.64
Butt Splice, Nylon Insulated .....	D1.65
Butt Splice, Vinyl Insulated .....	D1.65
Butt Splice, Non-Insulated .....	D1.66
Parallel Splice, Nylon Insulated .....	D1.66
Parallel Splice, Non-Insulated .....	D1.67
Wire Joint, Nylon Insulated .....	D1.67
Wire Joint, Non-Insulated .....	D1.68
Heat Shrink, Butt Splices .....	D1.68
Metric Butt Splice, Vinyl Insulated .....	D1.68
Metric Butt Splice, Non-Insulated .....	D1.69
Metric Wire Joints, Nylon Insulated .....	D1.69
<b>Pan-Term® Ferrules</b> .....	D1.70
Features and Benefits – Pan-Term® Ferrules .....	D1.71
Selection Guide – Pan-Term® Ferrules .....	D1.72
Part Number System for Pan-Term® Ferrules .....	D1.72
Insulated Ferrules – Single Wire DIN End Sleeve .....	D1.73
Insulated Ferrules – Single Wire French End Sleeve .....	D1.74
Insulated Ferrules – Twin Wire DIN End Sleeve .....	D1.75

★ Represents new product offering.

## Table of Contents

A.  
System  
Overview

B1.  
Cable Ties

B2.  
Cable  
Accessories

B3.  
Stainless  
Steel Ties

C1.  
Wiring  
Duct

C2.  
Surface  
Raceway

C3.  
Abrasion  
Protection

C4.  
Cable  
Management

D1.  
Terminals

D2.  
Power  
Connectors

D3.  
Grounding  
Connectors

E1.  
Labeling  
Systems

E2.  
Labels

E3.  
Pre-Printed  
& Write-On  
Markers

E4.  
Permanent  
Identification

E5.  
Lockout/  
Tagout  
& Safety  
Solutions

F.  
Index

Insulated Ferrules on Strips – Single Wire . . . . .	D1.75
Ferrules, Non-Insulated . . . . .	D1.76 – D1.77
Ferrule Assortment Kits . . . . .	D1.78
<b>Terminal Crimping Tools</b> . . . . .	D1.79
Crimping Guidelines for Panduit® Pan-Term® Terminals, Disconnects, Splices and Wire Joints . . . . .	D1.80 – D1.82
Hand Operated Plier Type Tools . . . . .	D1.83
Wire and Cable Stripping Tools . . . . .	D1.83
Contour Crimp™ Controlled Cycle Tools . . . . .	D1.84
Controlled Cycle Crimping Tools . . . . .	D1.85
Controlled Cycle Crimping Tools – Ferrule End Sleeve . . . . .	D1.85
Semiautomatic Ferrule Crimping Tool CT-1000 . . . . .	D1.86
Controlled Cycle Crimping Tools – In-Line . . . . .	D1.86
Pneumatic Crimping Tool . . . . .	D1.86
Die Type, Manual, Crimping Tool . . . . .	D1.87
CD-720 Crimping Dies . . . . .	D1.87
CT-2500 Battery Powered Crimping Tool . . . . .	D1.88
★ CT-2600 Battery Powered Hydraulic, 4 Ton, Crimping Tool . . . . .	D1.89
Tooling Selection Guide for Panduit Terminals, Splices, and Disconnects . . . . .	D1.90 – D1.92
Tooling Selection Guide for Panduit Tubular Ring Terminals . . . . .	D1.93
Tooling Selection Guide for Panduit Ferrules . . . . .	D1.94
Technical Specification and Selection Information . . . . .	D1.95
Panduit Terminal Approvals . . . . .	D1.95
Performance Requirements . . . . .	D1.96
Panduit® Pan-Term® Terminal Military Cross Reference . . . . .	D1.96
Stud Size Chart (Inches/mm) . . . . .	D1.97
Equivalent Tables . . . . .	D1.98
Common Conductor Size Chart (Stranded Wire) . . . . .	D1.98
Common Conductor Sizes and Strandings Reference Chart . . . . .	D1.99 – D1.100
<b>Reel Smart™ System</b> . . . . .	D1.101
Features and Benefits – Reel Smart™ Termination System . . . . .	D1.102
Reel Smart™ CA9 Ezair™ Universal Applicator . . . . .	D1.102
Nylon Insulated Terminals with Insulation Grip Sleeve (Funnel and Non-Funnel Entry Types) . . . . .	D1.102
Part Number System for Reel Smart™ Terminals . . . . .	D1.103
Ring Terminals, Nylon Insulated – Non-Funnel Entry . . . . .	D1.103
Ring Terminals, Nylon Insulated – Funnel Entry . . . . .	D1.104
Ring Terminals, Vinyl Insulated – Funnel Entry . . . . .	D1.105
Multiple Stud Ring Terminals, Vinyl Insulated – Funnel Entry . . . . .	D1.105
Ring Terminals, Nylon Insulated – Heavy Duty . . . . .	D1.106
Ring Terminals, Vinyl Insulated – Heavy Duty . . . . .	D1.106
Fork Terminals, Nylon Insulated – Non-Funnel Entry . . . . .	D1.107
Fork Terminals, Nylon Insulated – Funnel Entry . . . . .	D1.108
Fork Terminals, Vinyl Insulated – Funnel Entry . . . . .	D1.109
Locking Fork Terminals, Nylon Insulated – Non-Funnel Entry . . . . .	D1.110
Locking Fork Terminals, Nylon Insulated – Funnel Entry . . . . .	D1.110
Locking Fork Terminals, Vinyl Insulated – Funnel Entry . . . . .	D1.111
Short Locking Fork Terminals, Nylon Insulated – Non-Funnel Entry . . . . .	D1.112
Short Locking Fork Terminals, Nylon Insulated – Funnel Entry . . . . .	D1.112
Short Locking Fork Terminals, Vinyl Insulated – Funnel Entry . . . . .	D1.113
Flanged Fork Terminals, Nylon Insulated – Non-Funnel Entry . . . . .	D1.113
Flanged Fork Terminals, Nylon Insulated – Funnel Entry . . . . .	D1.114
Flanged Fork Terminals, Vinyl Insulated – Funnel Entry . . . . .	D1.114
Features and Benefits – Reel Smart™ Metric Terminals . . . . .	D1.115
Part Number System for Reel Smart™ Metric Terminals . . . . .	D1.115
Metric Ring Terminals, Nylon Insulated – Non-Funnel Entry . . . . .	D1.116
Metric Ring Terminals, Nylon Insulated – Funnel Entry . . . . .	D1.117
Metric Ring Terminals, Vinyl Insulated – Funnel Entry . . . . .	D1.118
Metric Fork Terminals, Nylon Insulated – Non-Funnel Entry . . . . .	D1.119
Metric Fork Terminals, Nylon Insulated – Funnel Entry . . . . .	D1.119
Metric Fork Terminals, Vinyl Insulated – Funnel Entry . . . . .	D1.120
Features and Benefits – Reel Smart™ Disconnects . . . . .	D1.121
Part Number System for Reel Smart™ Disconnects . . . . .	D1.122
Supra-Grip™ Female Disconnects, Nylon Fully Insulated – Funnel Entry . . . . .	D1.122
Disco-Lok™ Female Disconnects, Nylon Fully Insulated – Funnel Entry . . . . .	D1.123
Female Disconnects, Nylon Fully Insulated – Funnel Entry . . . . .	D1.123
Disco™ Female Disconnects, Nylon Fully Insulated – Expanded Wire Entry . . . . .	D1.124
Disco™ Female Disconnects, Nylon Fully Insulated – Right Angle . . . . .	D1.124
Disco™ Female Disconnects, Vinyl Barrel Insulated – Funnel Entry . . . . .	D1.125
DiscoGrip™ Female Disconnects, Fully Insulated . . . . .	D1.126
DiscoGrip™ Male Disconnects, Fully Insulated . . . . .	D1.127
Disco™ Male Disconnects, Nylon Fully Insulated – Funnel Entry . . . . .	D1.128

★ Represents new product offering.

## Table of Contents

Disco™ Male Disconnects, Nylon Fully Insulated – Expanded Wire Entry . . . . .	D1.128
Disco™ Male Disconnects, Nylon Barrel Insulated – Funnel Entry . . . . .	D1.129
Disco™ Male Disconnects, Vinyl Barrel Insulated – Funnel Entry . . . . .	D1.129
Pin Terminals, Vinyl Insulated – Funnel Entry . . . . .	D1.130
Male Blade Adapters, Vinyl Insulated – Funnel Entry . . . . .	D1.130
Butt Splices Nylon Insulated and Premium Grade Nylon . . . . .	D1.130
Features and Benefits – Reel Smart™ Metric Disconnects . . . . .	D1.131
Part Number System for Reel Smart™ Metric Disconnects . . . . .	D1.132
Metric Supra-Grip™ Female Disconnects, Nylon Fully Insulated – Funnel Entry . . . . .	D1.132
Metric Disco-Lok™ Female Disconnects, Nylon Fully Insulated – Funnel Entry . . . . .	D1.133
Metric Female Disconnects, Nylon Fully Insulated – Funnel Entry . . . . .	D1.133
Metric Disco™ Female Disconnects, Nylon Fully Insulated – Expanded Wire Entry . . . . .	D1.134
Metric Disco™ Female Disconnects, Nylon Fully Insulated – Right Angle . . . . .	D1.134
Metric Disco™ Female Disconnects, Vinyl Barrel Insulated – Funnel Entry . . . . .	D1.135
Metric DiscoGrip™ Female Disconnects, Fully Insulated – Funnel Entry . . . . .	D1.135
Metric DiscoGrip™ Male Disconnects, Fully Insulated – Funnel Entry . . . . .	D1.136
Metric Disco™ Male Disconnects, Nylon Fully Insulated – Funnel Entry . . . . .	D1.136
Metric Disco™ Male Disconnects, Nylon Fully Insulated – Expanded Wire Entry . . . . .	D1.137
Metric Disco™ Male Disconnects, Nylon Barrel Insulated – Funnel Entry . . . . .	D1.137
Metric Disco™ Male Disconnects, Vinyl Barrel Insulated – Funnel Entry . . . . .	D1.138
Metric Pin Terminals, Vinyl Insulated – Funnel Entry . . . . .	D1.138
Metric Male Blade Adapters, Vinyl Insulated – Funnel Entry . . . . .	D1.139
Metric Butt Splices, Nylon Insulated . . . . .	D1.139
Features and Benefits – Reel Smart™ Ferrules . . . . .	D1.140
Part Number System for Reel Smart™ Ferrules . . . . .	D1.140
Insulated Ferrules on Strips – Single Wire . . . . .	D1.141
Semiautomatic Ferrule Crimping Tool – CT-1000 . . . . .	D1.142
Insulated Ferrules on Reels – Single Wire . . . . .	D1.142
Reel Smart™ Ferrule Applicator – CA10 . . . . .	D1.143
CA9 Ezair™ and CA-800EZ Applicators . . . . .	D1.143
Electric Bench Press . . . . .	D1.144
Die Sharpening Kits . . . . .	D1.144
Die Information . . . . .	D1.145 – D1.146
CA10, CA9 Ezair™ and CA-800EZ Applicators Wire Processing Machine Manufacturer/Press Compatibility . . . . .	D1.147
Performance Requirements . . . . .	D1.148

## Power Connectors

Compression Connector Reference Information . . . . .	D2.0
<b>Pan-Lug™ Compression Connectors</b> . . . . .	D2.1
Features and Benefits – Pan-Lug™ Compression Connectors . . . . .	D2.2
Selection Guide – Pan-Lug™ Copper Compression Connectors for Copper Code Conductor . . . . .	D2.3
Selection Guide – Pan-Lug™ Copper Compression Connectors for Copper Code and/or Flex Conductor . . . . .	D2.4
Selection Guide – Pan-Lug™ Aluminum Compression Connectors for Aluminum or Copper Code Conductor . . . . .	D2.5
Part Number System for Pan-Lug™ Compression AWG Lugs . . . . .	D2.6
Code Conductor, One-Hole, Short Barrel with Window Lug . . . . .	D2.7 – D2.8
Code Conductor, One-Hole, Short Barrel with Window Lug, 45° Angle . . . . .	D2.9 – D2.10
Code Conductor, One-Hole, Short Barrel with Window Lug, 90° Angle . . . . .	D2.11 – D2.12
Code Conductor, One-Hole, Standard Barrel with Window Lug . . . . .	D2.13 – D2.14
Code Conductor, One-Hole, Standard Barrel with Window Lug, 45° Angle . . . . .	D2.15 – D2.16
Code Conductor, One-Hole, Standard Barrel with Window Lug, 90° Angle . . . . .	D2.17 – D2.18
Code Conductor, One-Hole, Standard Barrel with Window, Narrow Tongue Lug . . . . .	D2.19 – D2.20
Code Conductor, Short Blank Tongue, Standard Barrel with Window Lug . . . . .	D2.21
Code Conductor, One-Hole, Long Barrel Lug . . . . .	D2.22 – D2.23
Code Conductor, One-Hole, Long Barrel Lug, 45° Angle . . . . .	D2.24 – D2.25
Code Conductor, One-Hole, Long Barrel Lug, 90° Angle . . . . .	D2.26 – D2.27
Code Conductor, One-Hole, Long Barrel with Window Lug . . . . .	D2.28
Code Conductor, One-Hole, Long Barrel with Window Lug, 45° Angle . . . . .	D2.29
Code Conductor, One-Hole, Long Barrel with Window Lug, 90° Angle . . . . .	D2.29
Code Conductor, One-Hole, Long Barrel with Corona Relief Taper Lug . . . . .	D2.30
Code Conductor, Two-Hole, Standard Barrel with Window Lug . . . . .	D2.31 – D2.32
Code Conductor, Two-Hole, Standard Barrel with Window Lug, 45° Angle . . . . .	D2.33 – D2.34
Code Conductor, Two-Hole, Standard Barrel with Window Lug, 90° Angle . . . . .	D2.35 – D2.36
Code Conductor, Two-Hole, Standard Barrel with Window, Narrow Tongue Lug . . . . .	D2.37
Code Conductor, Two-Hole, Standard Barrel with Window, Narrow Tongue Lug, 45° . . . . .	D2.38
Code Conductor, Two-Hole, Standard Barrel with Window, Narrow Tongue Lug, 90° . . . . .	D2.39
Code Conductor, Long Blank Tongue, Standard Barrel with Window Lug . . . . .	D2.40
Code Conductor, Two-Hole, Long Barrel Lug . . . . .	D2.41 – D2.42
Code Conductor, Two-Hole, Long Barrel Lug, 45° Angle . . . . .	D2.43 – D2.44

★ Represents new product offering.

A. System Overview
B1. Cable Ties
B2. Cable Accessories
B3. Stainless Steel Ties
C1. Wiring Duct
C2. Surface Raceway
C3. Abrasion Protection
C4. Cable Management
D1. Terminals
D2. Power Connectors
D3. Grounding Connectors
E1. Labeling Systems
E2. Labels
E3. Pre-Printed & Write-On Markers
E4. Permanent Identification
E5. Lockout/ Tagout & Safety Solutions
F. Index

## Table of Contents

A.  
System  
Overview

B1.  
Cable Ties

B2.  
Cable  
Accessories

B3.  
Stainless  
Steel Ties

C1.  
Wiring  
Duct

C2.  
Surface  
Raceway

C3.  
Abrasion  
Protection

C4.  
Cable  
Management

D1.  
Terminals

D2.  
Power  
Connectors

D3.  
Grounding  
Connectors

E1.  
Labeling  
Systems

E2.  
Labels

E3.  
Pre-Printed  
& Write-On  
Markers

E4.  
Permanent  
Identification

E5.  
Lockout/  
Tagout  
& Safety  
Solutions

F.  
Index

Code Conductor, Two-Hole, Long Barrel Lug, 90° Angle	D2.45 – D2.46
Code Conductor, Two-Hole, Long Barrel with Window Lug	D2.47 – D2.49
Code Conductor, Two-Hole, Long Barrel with Window Lug, 45° Angle	D2.50 – D2.52
Code Conductor, Two-Hole, Long Barrel with Window Lug, 90° Angle	D2.53 – D2.55
Code Conductor, Two-Hole, Long Barrel with Window, Narrow Tongue Lug	D2.55
Code Conductor, Two-Hole, Long Barrel with Corona Relief Taper Lug	D2.56
Code Conductor, Blank Tongue, Long Barrel Lug	D2.57
Code Conductor, Blank Tongue, Long Barrel with Window Lug	D2.58
Code Conductor, Short Barrel, Butt Splice	D2.59
Code Conductor, Standard Barrel, Butt Splice	D2.60
Code Conductor, Long Barrel, Butt Splice	D2.61
Code Conductor, Long Barrel with Corona Relief Taper Splice	D2.62
Code Conductor, Long Barrel, T Splice	D2.63
Code Conductor, Color-Coded Parallel Splice	D2.64 – D2.65
Flex Conductor, One-Hole, Standard Barrel with Window Lug	D2.66 – D2.67
Flex Conductor, One-Hole, Standard Barrel with Window Lug, 45° Angle	D2.68 – D2.69
Flex Conductor, One-Hole, Standard Barrel with Window Lug, 90° Angle	D2.70 – D2.71
Flex Conductor, One-Hole, Standard Barrel with Window, Narrow Tongue Lug	D2.72
Flex Conductor, One-Hole, Standard Barrel with Window, Flared NEBS Lug	D2.73 – D2.74
Flex Conductor, One-Hole, Standard Barrel with Window, Flared NEBS Lug, 45° Angle	D2.75 – D2.76
Flex Conductor, One-Hole, Standard Barrel with Window, Flared NEBS Lug, 90° Angle	D2.77 – D2.78
Flex Conductor, One-Hole, Long Barrel with Window Lug	D2.79
Flex Conductor, One-Hole, Long Barrel with Window Lug, 45° Angle	D2.80
Flex Conductor, One-Hole, Long Barrel with Window Lug, 90° Angle	D2.81
Flex Conductor, Two-Hole, Standard Barrel with Window Lug	D2.82 – D2.83
Flex Conductor, Two-Hole, Standard Barrel with Window Lug, 45° Angle	D2.84 – D2.85
Flex Conductor, Two-Hole, Standard Barrel with Window Lug, 90° Angle	D2.86 – D2.87
Flex Conductor, Two-Hole, Standard Barrel with Window, Narrow Tongue Lug	D2.88
Flex Conductor, Two-Hole, Standard Barrel with Window, Narrow Tongue Lug, 45°	D2.89
Flex Conductor, Two-Hole, Standard Barrel with Window, Narrow Tongue Lug, 90°	D2.89
Flex Conductor, Two-Hole, Long Barrel with Window Lug	D2.90 – D2.91
Flex Conductor, Two-Hole, Long Barrel with Window Lug, 45° Angle	D2.92 – D2.93
Flex Conductor, Two-Hole, Long Barrel with Window Lug, 90° Angle	D2.94 – D2.95
★ Flex Conductor, Two-Hole, Long Barrel with Window, Narrow Tongue Lug	D2.95
Flex Conductor, Two-Hole, Long Barrel, Flared NEBS Lug	D2.96 – D2.97
Flex Conductor, Two-Hole, Long Barrel, Flared NEBS Lug, 45° Angle	D2.98 – D2.99
Flex Conductor, Two-Hole, Long Barrel, Flared NEBS Lug, 90° Angle	D2.100 – D2.101
Flex Conductor, Standard Barrel, Flared, NEBS Butt Splice	D2.102
Code/Flex Conductor, with Window, In-Line Reducing Splice Kit	D2.103 – D2.104
Code/Flex Conductor, with Window, In-Line Reducing Splice	D2.105 – D2.106
Part Number System for Metric Lugs	D2.107
Metric Conductor, One-Hole, Standard Barrel with Window Lug	D2.107 – D2.108
Metric Conductor, Two-Hole, Standard Barrel with Window Lug	D2.109 – D2.110
Metric Conductor, Standard Barrel, Butt Splice	D2.111
Code Conductor, One-Hole, Aluminum Lug	D2.112
Code Conductor, Two-Hole, Aluminum Lug	D2.113
Belleville Compression Washers	D2.114
Code Conductor, Aluminum Splice	D2.115
Code Conductor, Aluminum, Reducing Splice	D2.116
Code Conductor, Aluminum, Bi-Metallic Pin Connector	D2.117
Joint Compounds	D2.118
<b>Pan-Lug™ Mechanical Connectors</b>	D2.119
Features and Benefits – Pan-Lug™ Mechanical Connectors	D2.120
Selection Guide – Pan-Lug™ Mechanical Connectors, Cast Copper	D2.121
Selection Guide – Pan-Lug™ Mechanical Connectors, Stamped and Formed	D2.122
Selection Guide – Pan-Lug™ Mechanical Connectors, Aluminum	D2.123
Selection Guide – Pan-Lug™ Mechanical Connectors, Split Bolts and Multi-Taps	D2.124
Split Bolt, Copper	D2.125
Split Bolt, Copper, Tin-Plated	D2.126
Split Bolt, Aluminum	D2.127
Two-Bolt Connector, Bronze	D2.127
Two-Bolt Connector, Bronze, Tin-Plated	D2.128
One-Hole, Straight Tongue, Barrel Post Lug	D2.128
One-Hole, Straight Tongue, Tin-Plated, Barrel Post Lug	D2.129
One-Hole, Straight Tongue Lug	D2.129
One-Hole, Straight Tongue Lug with Internal Pressure Plate	D2.130
One-Hole, Straight Tongue, Flag Lug	D2.130
One-Hole, Straight Tongue, 90° Lug	D2.131
Two-Hole, Straight Tongue Lug	D2.131
Two-Hole, Straight Tongue Lug with Internal Pressure Plate	D2.132

★ Represents new product offering.

## Table of Contents

A.  
System  
Overview

B1.  
Cable Ties

B2.  
Cable  
Accessories

B3.  
Stainless  
Steel Ties

C1.  
Wiring  
Duct

C2.  
Surface  
Raceway

C3.  
Abrasion  
Protection

C4.  
Cable  
Management

D1.  
Terminals

D2.  
Power  
Connectors

D3.  
Grounding  
Connectors

E1.  
Labeling  
Systems

E2.  
Labels

E3.  
Pre-Printed  
& Write-On  
Markers

E4.  
Permanent  
Identification

E5.  
Lockout/  
Tagout  
& Safety  
Solutions

F.  
Index

Two-Hole, Straight Tongue Lug with NEMA Hole Sizes and Spacing .....	D2.133
Two-Hole, Straight Tongue, Tandem Set Screw Lug .....	D2.133
Two-Hole, Straight Tongue, Two-Barrel Lug .....	D2.134
Two-Hole, Straight Tongue, Two-Barrel, Tin-Plated Lug .....	D2.134
Two-Set Screw Splice .....	D2.135
Two-Set Screw Splice with Internal Pressure Plate .....	D2.135
One-Hole, Straight Fixed Tongue Lug .....	D2.136
One-Hole, Straight Fixed Tongue, Tin-Plated Lug .....	D2.136
One-Hole, Straight Floating Tongue Lug .....	D2.137
Two-Hole, Straight Floating Tongue Lug .....	D2.138
One-Hole, Offset Floating Tongue Lug .....	D2.139
Two-Hole, Offset Floating Tongue Lug .....	D2.140
One-Hole, Single Barrel Lug .....	D2.141
Two-Hole, Single Barrel Lug .....	D2.142
One-Hole, Two-Barrel Lug .....	D2.142
One-Hole, Vertical Two-Barrel Lug .....	D2.143
Two-Hole, Two-Barrel Lug .....	D2.143
Two-Hole, Vertical Two-Barrel Lug .....	D2.144
Two-Hole, Three-Barrel Lug .....	D2.144
Four-Hole, Three-Barrel Lug .....	D2.145
Two-Hole, Vertical Four-Barrel Lug .....	D2.146
Four-Hole, Four-Barrel Lug .....	D2.146
Transformer Lug Kit .....	D2.147
Splicer/Reducer .....	D2.148
Multi-Tap Connector with Clear Insulation, Single-Sided .....	D2.149
Multi-Tap Connector with Clear Insulation, Double-Sided .....	D2.150 – D2.151
In-Line Splicer/Reducer with Clear Insulation .....	D2.152
Multi-Tap Connector with Clear Insulation, Single-Sided, with Mounting Holes .....	D2.153
Multi-Tap Connector with Clear Insulation, Double-Sided, with Mounting Holes .....	D2.154
Belleville Compression Washers .....	D2.155
Joint Compounds .....	D2.155
Guidelines for Installing Aluminum Mechanical Connectors .....	D2.156
Panduit Power Connector Approvals .....	D2.157
Recommended Termination Hardware .....	D2.158
Conductor Sizes .....	D2.159 – D2.161
Common Conductor Sizes and Strandings Reference Chart .....	D2.162 – D2.163
Stud Size Chart (Inches/Millimeters) .....	D2.164
Equivalent Tables .....	D2.164

## Grounding Connectors

<b>StructuredGround™ Grounding Connectors</b> .....	D3.1
Features and Benefits – StructuredGround™ Compression Connectors .....	D3.2
StructuredGround™ Direct Burial Compression System Grounding Roadmap .....	D3.3
Service Entrance Grounding Roadmap .....	D3.4
★ Access Floor Grounding Clamp .....	D3.5
BICSI/J-STD-607-A Telecommunications Grounding Busbars .....	D3.6
Component Labels for BICSI/J-STD-607-A Telecommunications Grounding Busbars .....	D3.6
Telecommunications Grounding and Bonding Conductor Label Kit .....	D3.6
★ NEMA Hole Pattern Grounding Busbars .....	D3.7
★ Grounding Busbar 1" Hole Spacings .....	D3.7
★ Stainless Steel Hardware for Busbars .....	D3.7
★ E Style Grounding Connectors .....	D3.8
★ Grounding Cross Connectors .....	D3.9
★ Universal Beam Grounding Clamp .....	D3.10
★ Grounding Plate Connector .....	D3.10
Code Conductor, Thin Wall, CTAP .....	D3.11
Code Conductor, Heavy Duty, CTAP .....	D3.12
Clear Covers for HTCT HTAPs .....	D3.13
Black Covers for Copper HTAPs and CTAPs .....	D3.13
Code/Flex Conductor HTAP .....	D3.14
Code/Flex Conductor HTAP Kit .....	D3.15
Features and Benefits – StructuredGround™ Mechanical Connectors .....	D3.16
Selection Guide – StructuredGround™ Mechanical Connectors .....	D3.17 – D3.18
Panduit Grounding Connector Approvals .....	D3.19
Service Post Connector, Male Stud, Single Conductor, Bronze .....	D3.20
Service Post Connector, Male Stud, Two Conductor, Bronze .....	D3.21
Service Post Connector, Female Thread, Single Conductor, Bronze .....	D3.22
Service Post Connector, Female Thread, Two Conductor, Bronze .....	D3.23
★ One-Hole Aluminum Lay-In Lug .....	D3.24

★ Represents new product offering.

## Table of Contents

A. System Overview	
B1. Cable Ties	Joint Compounds .....D3.24 Grounding Clamp, U-Bolt, Bronze .....D3.25 Grounding Clamp, U-Bolt, for Two Cables, Bronze .....D3.26 Grounding Clamp for Water Pipes, Bronze .....D3.26 Grounding Clamp for Water Pipe with Copper Strap, Bronze .....D3.27
B2. Cable Accessories	Grounding Clamp for Conduit, Bronze .....D3.27 Grounding Clamp for Water Pipes, Aluminum .....D3.28 Grounding Rod Clamp, Bronze .....D3.28 Grounding Clamp with Spacer for Flat Surfaces, Bronze .....D3.29
B3. Stainless Steel Ties	Grounding Clamp for Flat Surfaces, Bronze .....D3.29 ★ Flat Braided Bonding Straps .....D3.30
C1. Wiring Duct	<b>Compression Connector Crimping Tools</b> .....D3.31 Crimping Guidelines for Panduit® Pan-Lug™ Compression Lugs and Splices .....D3.32 Crimping Guidelines for Panduit® StructuredGround™ Compression Connectors .....D3.33 Selection Guide – Compression Connector Tools .....D3.34 – D3.36 Die Type, Manual, Crimping Tool .....D3.37 CD-720 Crimping Dies .....D3.37 Die Type, Manual, Crimping Tool and Die Kits .....D3.38
C2. Surface Raceway	Cable Stripping Tool for Large Cable Sizes .....D3.38 Wire and Cable Stripping Tools .....D3.38 ★ Cable Cutting Tools .....D3.39 Die Type, Manual Hydraulic, 14 Ton, Crimping Tool .....D3.39 ★ Die Type, Lithium-Ion Powered Hydraulic, 6 Ton, In-Line Crimping Tools .....D3.40 ★ Die Type, Lithium-Ion Powered Hydraulic, 6 Ton, Crimping Tool with Open “C-Head” .....D3.41 CD-2001 Crimping Dies .....D3.42 ★ Die Type, Lithium-Ion Powered Hydraulic, 14 Ton, Crimping Tool .....D3.43 ★ Die Type, Lithium-Ion Powered Hydraulic, 15 Ton, Crimping Tool .....D3.44
C3. Abrasion Protection	Die Type, Remote Hydraulic, 14 Ton, Crimp Head .....D3.45 Die Type, Remote Hydraulic, 15 Ton, Crimp Head .....D3.46 Hydraulic Pump and Accessories, Electric, 10,000 PSI .....D3.47 Die Type, Remote Hydraulic, 10.5 Ton, Crimp Head .....D3.48 Hydraulic Pump and Accessories, Electric, 7,500 PSI .....D3.49
C4. Cable Management	CD-920 Crimping Dies .....D3.50 CD-940 Crimping Dies .....D3.51 Uni-Die™ Dieless, Manual Hydraulic, 6.2 Ton, Crimping Tool .....D3.52 ★ Uni-Die™ Dieless, Lithium-Ion Powered Hydraulic, 6.2 Ton, Crimping Tool .....D3.53 Uni-Die™ Dieless, Remote Hydraulic, 6.2 Ton, Crimp Head .....D3.54 Uni-Die™ Dieless, Remote Hydraulic, 4.7 Ton, Crimp Head .....D3.54 Pressure Gauges .....D3.55 ★ Accessories for Battery Powered Hydraulic Crimping Tools .....D3.55
D1. Terminals	Installation Tooling and Die Selections for: Types LCAS and SCSS .....D3.56 – D3.57 Installation Tooling and Die Selections for: Types LCA, LCAN, LCD, LCDN and SCS .....D3.58 – D3.61 Installation Tooling and Die Selections for: Types LCB, LCBN, LCC, LCCN and SCL .....D3.62 – D3.65 Installation Tooling and Die Selections for: Types LCBH, LCCH and SCH .....D3.66 – D3.67 Installation Tooling and Die Selections for: Type SCT .....D3.68 – D3.69 Installation Tooling and Die Selections for: Types LCAX, LCAXN, LCBX, LCDX, LCDXN and LCCX .....D3.70 – D3.73
D3. Grounding Connectors	Installation Tooling and Die Selections for: Types LCAF, LCCF and SCSF .....D3.74 – D3.75 Installation Tooling and Die Selections for: Type RSC In-Line Reducing Splice .....D3.76 – D3.81 Installation Tooling and Die Selections for: Type PSC .....D3.82 Installation Tooling and Die Selections for: Types LCMA, LCMD, and SCMS .....D3.83 Installation Tooling and Die Selections for: Types LAA, LAB and SA .....D3.84 – D3.85 Installation Tooling and Die Selections for: Type SAR .....D3.86 – D3.87 Installation Tooling and Die Selections for: Type BPC .....D3.88 – D3.89 Installation Tooling and Die Selections for: Types GCE, GCC, and GPC .....D3.90 Installation Tooling and Die Selections for: Type CTAP .....D3.91 Installation Tooling and Die Selections for: Type CTAPF .....D3.92 – D3.93 Installation Tooling and Die Selections for: Type HTCT .....D3.94
E1. Labeling Systems	
E2. Labels	
E3. Pre-Printed & Write-On Markers	

## Labeling Systems

E4. Permanent Identification	<b>Labeling Systems</b> .....E1.0 <b>Printers: Thermal Transfer Desktop and Hand-Held</b> .....E1.1 PanTher™ LS8E Hand-Held Thermal Transfer Printer and Accessories .....E1.2 Cougar™ LS9 Hand-Held Thermal Transfer Printer and Accessories .....E1.2 P1™ Self-Laminating Label Cassettes for PanTher™ LS8E Hand-Held Thermal Transfer Printer .....E1.3 – E1.4 P1™ Non-Laminated Label Cassettes .....E1.5 – E1.6
E5. Lockout/ Tagout & Safety Solutions	★ P1™ Turn-Tell™ Label Cassettes for PanTher™ LS8E Hand-Held Thermal Transfer Printer .....E1.6 ★ P1™ Marker Plate Label Cassettes for PanTher™ LS8E Hand-Held Thermal Transfer Printer .....E1.7 ★ P1™ Flag Label Cassettes for PanTher™ LS8E Hand-Held Thermal Transfer Printer .....E1.7

★ Represents new product offering.



## Table of Contents

P1™ Military Grade Continuous Heat Shrink Label Cassettes for PanTher™ LS8E or Cougar™ LS9 Hand-Held Thermal Transfer Printers	E1.8
P1™ Military Grade Die-Cut Heat Shrink Label Cassettes for PanTher™ LS8E Hand-Held Thermal Transfer Printer	E1.9
P1™ General Component Label Cassettes for PanTher™ LS8E Hand-Held Thermal Transfer Printers	E1.10
P1™ Continuous Tape Cassettes for PanTher™ LS8E and Cougar™ LS9 Hand-Held Thermal Transfer Printers	E1.11 – E1.12
★ P1™ Continuous Reflective Tape Cassettes for PanTher™ LS8E and Cougar™ LS9 Hand-Held Thermal Transfer Printers	E1.12
TDP43MY Thermal Transfer Desktop Printer and Accessories	E1.13
Ribbons for Use with the TDP43MY Thermal Transfer Desktop Printer	E1.13
TDP42HY, TDP43HY, TDP46HY Thermal Transfer Desktop Printers	E1.14
Ribbons for use with the TDP42HY, TDP43HY and TDP46HY Thermal Transfer Desktop Printers	E1.14
<b>Labeling Software</b>	E1.15
Easy-Mark™ Labeling Software	E1.16
CAD-Connect™ Labeling Software	E1.16

## Labels

<b>Labels: Laser, Ink Jet, and Thermal Transfer</b>	E2.1
Laser/Ink Jet Self-Laminating Labels	E2.2 – E2.3
Laser/Ink Jet Non-Laminated Labels	E2.4
Laser/Ink Jet Flag Style Labels	E2.5
Laser/Ink Jet Component Labels	E2.5 – E2.6
Part Number System for Component Labels	E2.5
Thermal Transfer Self-Laminating Labels	E2.7 – E2.9
★ Turn-Tell™ Labels	E2.10
Thermal Transfer Marker Plates	E2.10
Thermal Transfer Non-Laminated Labels	E2.11
Part Number System for Non-Laminated Labels	E2.11
Thermal Transfer Military Grade Heat Shrink Labels	E2.12 – E2.13
★ 2-Sided Military Grade Printable Heat Shrink Labels	E2.14 – E2.15
Heat Shrink Tools and Accessories	E2.15
Thermal Transfer Component Labels	E2.16 – E2.18
Thermal Transfer Tamper Evident Polyester Component Labels	E2.19
Thermal Transfer Raised Panel Labels	E2.19 – E2.20
Thermal Transfer Continuous Tapes	E2.21 – E2.22
Size Illustrations of Self-Laminating Labels	E2.23 – E2.24
Size Illustrations of Non-Laminated and Flag Style Labels	E2.25
Size Illustrations of Flattened Heat Shrink Labels	E2.26
Size Illustrations for Component Labels	E2.27 – E2.28

## Pre-Printed and Write-On Markers

<b>Pre-Printed and Write-On Markers</b>	E3.1
Pre-Printed Marker Books	E3.2
Blank Self-Laminating Write-On Cable Marker Books	E3.3
Pre-Printed Marker Cards PCM Type	E3.4 – E3.6
Wire Marker Card Number Combination Packs	E3.7
Pre-Printed Marker Cards	E3.7
Pre-Printed Marker Cards PPM Type	E3.8
Write-On Marker Cards – Self-Laminating	E3.9
Pre-Printed Marker Tape Dispenser	E3.9
Pre-Printed Marker Tape Refills	E3.10
Self-Laminating Wire Marker Dispenser	E3.11
Pre-Printed Clip-On Wire Markers	E3.11 – E3.12

## Permanent Identification

<b>Permanent Identification</b>	E4.1
Panduit Factory Custom Marking Service	E4.2
Stainless Steel and Brass Marker Plates and Tags	E4.3 – E4.4
Pan-Alum™ Aluminum Marker Plates	E4.5
Aluminum Marker Plates Pan-Alum™ MMP Series 1	E4.5
Metal Embossing Tool and Tape System	E4.5
Metal Indenting Machine	E4.6
★ Portable Embossing System	E4.6

★ Represents new product offering.

A. System Overview
B1. Cable Ties
B2. Cable Accessories
B3. Stainless Steel Ties
C1. Wiring Duct
C2. Surface Raceway
C3. Abrasion Protection
C4. Cable Management
D1. Terminals
D2. Power Connectors
D3. Grounding Connectors
E1. Labeling Systems
E2. Labels
E3. Pre-Printed & Write-On Markers
E4. Permanent Identification
E5. Lockout/ Tagout & Safety Solutions
F. Index

A.  
System  
Overview

## Table of Contents

B1.  
Cable Ties

### Lockout/Tagout and Safety Solutions

B2.  
Cable  
Accessories

B3.  
Stainless  
Steel Ties

C1.  
Wiring  
Duct

C2.  
Surface  
Raceway

C3.  
Abrasion  
Protection

C4.  
Cable  
Management

D1.  
Terminals

D2.  
Power  
Connectors

D3.  
Grounding  
Connectors

E1.  
Labeling  
Systems

E2.  
Labels

E3.  
Pre-Printed  
& Write-On  
Markers

E4.  
Permanent  
Identification

E5.  
Lockout/  
Tagout  
& Safety  
Solutions

F.  
Index

<b>Lockout/Tagout</b> .....	E5.1
OSHA Lockout/Tagout Compliance and Training Kit .....	E5.2
Group Lockout/Tagout Training Video .....	E5.2
Lockout/Tagout Steps/Calendar Wallet Card .....	E5.2
“No Tool” Circuit Breaker Lockout Devices .....	E5.3
Large Handle Circuit Breaker Lockout Device .....	E5.3
Circuit Breaker Lockout Devices .....	E5.3
Plug Lockout Device .....	E5.4
Cord Lockout Devices .....	E5.4
Receptacle Blockout Device .....	E5.4
Toggle Switch Lockout Device .....	E5.5
Toggle/Rocker Switch Lockout Device .....	E5.5
Gate Valve Lockout Devices .....	E5.5
Ball Valve Lockout Devices .....	E5.6
Multiple Lockout Device .....	E5.6
Pneumatic Energy Lockout Device .....	E5.6
Electrician Lockout Kit .....	E5.7
Contractor Lockout Kit .....	E5.7
MRO Lockout Kit .....	E5.7
Power and Panel Distribution Lockout Kit .....	E5.7
Metal Wall Mount Cabinet .....	E5.8
Lockout Stations .....	E5.8
Group Lock Box .....	E5.8
Warning Label .....	E5.9
Circuit Breaker Directory Sign .....	E5.9
Non-Conductive Lockout Padlocks .....	E5.10
High Security Padlocks .....	E5.10
Laminated Steel Padlocks .....	E5.11
Lockout Hasps .....	E5.11
Self-Laminating Padlock Labels .....	E5.12
Custom Lock Options .....	E5.12
Metal I.D. Tags and Collars .....	E5.13
Padlock Eyes .....	E5.13
Chain Attachment .....	E5.13
Write-On Safety Tags .....	E5.14 – E5.16
Bilingual Write-On Safety Tags .....	E5.17
ISO Symbol Safety Tags .....	E5.17
Do It Yourself Tags .....	E5.17
Self-Laminating Photo Tags .....	E5.18
Permanent Marking Pens .....	E5.18
Lockout/Tagout Safety Signs .....	E5.19
Jack Module Blockout Device .....	E5.20
RJ45 Plug Lock-In Device .....	E5.21
LC Duplex Adapter Blockout Device .....	E5.22
SC Adapter Blockout Device .....	E5.22
<b>Safety and Facility Identification</b> .....	E5.23
Electrical Hazard Safety Signs .....	E5.24
★ Short Circuit Warning Signs .....	E5.25
★ Photoluminescent Safety Signs .....	E5.25
Electrical Symbols on Cards .....	E5.25
Conductor Identification Labels .....	E5.26
ISO Warning Symbols .....	E5.27
Electrical Labels in Dispenser .....	E5.28
Write-On Labels on Cards .....	E5.29
Write-On Quality Labels in Dispenser .....	E5.30
Inspection Plates .....	E5.31
Inspection Arrows .....	E5.31
Voltage and Fiber Optic Markers .....	E5.32
Voltage and Safety Marker Books .....	E5.33
Hazard Tape .....	E5.33
Solid Color Adhesive Warning Tape .....	E5.33
Reflective Tapes .....	E5.34
Photoluminescent Tapes – Thermal Transfer Printable .....	E5.34
Underground Hazard Tape .....	E5.35
Barricade Tapes .....	E5.36
Vinyl Letters and Numbers .....	E5.36
Vinyl Cloth Letters and Numbers .....	E5.37 – E5.38
Reflective Letters and Numbers .....	E5.38
Sign Panels – Blank Space for Custom Messages .....	E5.39

★ Represents new product offering.

## Table of Contents

★ Thermal Transfer Printable Arc Flash Labels .....	E5.40
★ Laser Printable Adhesive Signs .....	E5.40
Self-Laminating Adhesive Sign Carriers .....	E5.41
Self-Laminating Cable Marker Holders for Large Cables or Cable Bundles .....	E5.41
Self-Laminating Fiber Optic Cable Marker Tags .....	E5.42
Ground Warning Tags .....	E5.42
Panduit Corp. Generic Padlock Order Form .....	E5.43
Panduit Corp. Generic PVT Vinyl Tag Order Form .....	E5.44
Panduit Corp. Generic Adhesive PPS Safety Sign Order Form .....	E5.45
Panduit Corp. Generic Semi-Rigid PRS Safety Sign Order Form .....	E5.46
Panduit Corp. Generic Conduit and Voltage Marker Order Form .....	E5.47
Panduit Corp. Generic Utility Tapes Order Form .....	E5.48
Panduit Corp. Generic Custom Engraved Marker Plate Order Form .....	E5.49
Wire Size Selection Guide .....	E5.50
Selection Guide by Wire/Cable Size .....	E5.51

## Index

<b>Part Number Index</b> .....	F1.1 – F1.40
--------------------------------	--------------

A.  
System  
Overview

B1.  
Cable Ties

B2.  
Cable  
Accessories

B3.  
Stainless  
Steel Ties

C1.  
Wiring  
Duct

C2.  
Surface  
Raceway

C3.  
Abrasion  
Protection

C4.  
Cable  
Management

D1.  
Terminals

D2.  
Power  
Connectors

D3.  
Grounding  
Connectors

E1.  
Labeling  
Systems

E2.  
Labels

E3.  
Pre-Printed  
& Write-On  
Markers

E4.  
Permanent  
Identification

E5.  
Lockout/  
Tagout  
& Safety  
Solutions

F.  
Index

★ Represents new product offering.

A.  
System  
Overview

B1.  
Cable Ties

B2.  
Cable  
Accessories

B3.  
Stainless  
Steel Ties

C1.  
Wiring  
Duct

C2.  
Surface  
Raceway

C3.  
Abrasion  
Protection

C4.  
Cable  
Management

D1.  
Terminals

D2.  
Power  
Connectors

D3.  
Grounding  
Connectors

E1.  
Labeling  
Systems

E2.  
Labels

E3.  
Pre-Printed  
& Write-On  
Markers

E4.  
Permanent  
Identification

E5.  
Lockout/  
Tagout  
& Safety  
Solutions

F.  
Index

# NOTES

## SYSTEM OVERVIEW

Panduit is a global leader in comprehensive physical infrastructure solutions. Issues such as convergence, interoperability, scalability and continuity need to be addressed to reduce risk across the IT, facilities, and manufacturing physical infrastructure. Our holistic approach enables business continuity through robust, leading-edge systems that optimize design and deployment of the physical infrastructure – delivering maximum reliability, availability, security, integration, and safety.

Comprehensive solutions include everything necessary to bundle, identify, route, protect, and terminate wires/cables. Supporting the most demanding application requirements customers trust Panduit for:

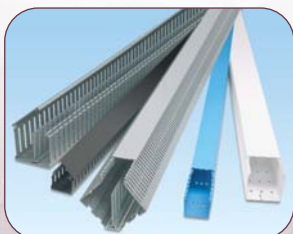

Panduit products are developed through continued focus on the needs of the customer and high level of investment in research and development. Solutions are designed for reliability, improved productivity, standards compliance, and lowest total cost of ownership.

- Comprehensive, end-to-end solutions
- World-class quality and reliability
- Innovative products and tools
- Unmatched global sales and technical support

A.  
System  
Overview

B1.  
Cable Ties

B2.  
Cable  
Accessories

B3.  
Stainless  
Steel Ties

C1.  
Wiring  
Duct

C2.  
Surface  
Raceway

C3.  
Abrasion  
Protection

C4.  
Cable  
Management

D1.  
Terminals

D2.  
Power  
Connectors

D3.  
Grounding  
Connectors

E1.  
Labeling  
Systems

E2.  
Labels

E3.  
Pre-Printed  
& Write-On  
Markers

E4.  
Permanent  
Identification

E5.  
Lockout/  
Tagout  
& Safety  
Solutions

F.  
Index

A.  
System  
Overview

## SOLUTIONS OVERVIEW

Panduit provides innovative solutions that offer maximum reliability at the lowest installed cost from the factory and manufacturing floor, to automation and control, to the office area.

B1.  
Cable Ties

B2.  
Cable  
Accessories

B3.  
Stainless  
Steel Ties

C1.  
Wiring  
Duct

C2.  
Surface  
Raceway

C3.  
Abrasion  
Protection

C4.  
Cable  
Management

D1.  
Terminals

D2.  
Power  
Connectors

D3.  
Grounding  
Connectors

E1.  
Labeling  
Systems

E2.  
Labels

E3.  
Pre-Printed  
& Write-On  
Markers

E4.  
Permanent  
Identification

E5.  
Lockout/  
Tagout/  
& Safety  
Solutions

F.  
Index





A.  
System  
Overview

B1.  
Cable Ties

B2.  
Cable  
Accessories

B3.  
Stainless  
Steel Ties

C1.  
Wiring  
Duct

C2.  
Surface  
Raceway

C3.  
Abrasion  
Protection

C4.  
Cable  
Management

D1.  
Terminals

D2.  
Power  
Connectors

D3.  
Grounding  
Connectors

E1.  
Labeling  
Systems

E2.  
Labels

E3.  
Pre-Printed  
& Write-On  
Markers

E4.  
Permanent  
Identification

E5.  
Lockout/  
Tagout  
& Safety  
Solutions

F.  
Index

## OEM



## Transportation



## Utilities



A.  
System  
Overview

## CONTROL PANEL SOLUTIONS

Panduit delivers innovative solutions that support evolving technologies in automation and control. Control panel solutions from Panduit reduce design and assembly time, save valuable panel space, ease installation and maintenance, and improve manageability and reliability, all contributing to lower cost of ownership.

B1.  
Cable Ties

B2.  
Cable  
Accessories

B3.  
Stainless  
Steel Ties

C1.  
Wiring  
Duct

C2.  
Surface  
Raceway

C3.  
Abrasion  
Protection

C4.  
Cable  
Management

D1.  
Terminals

D2.  
Power  
Connectors

D3.  
Grounding  
Connectors

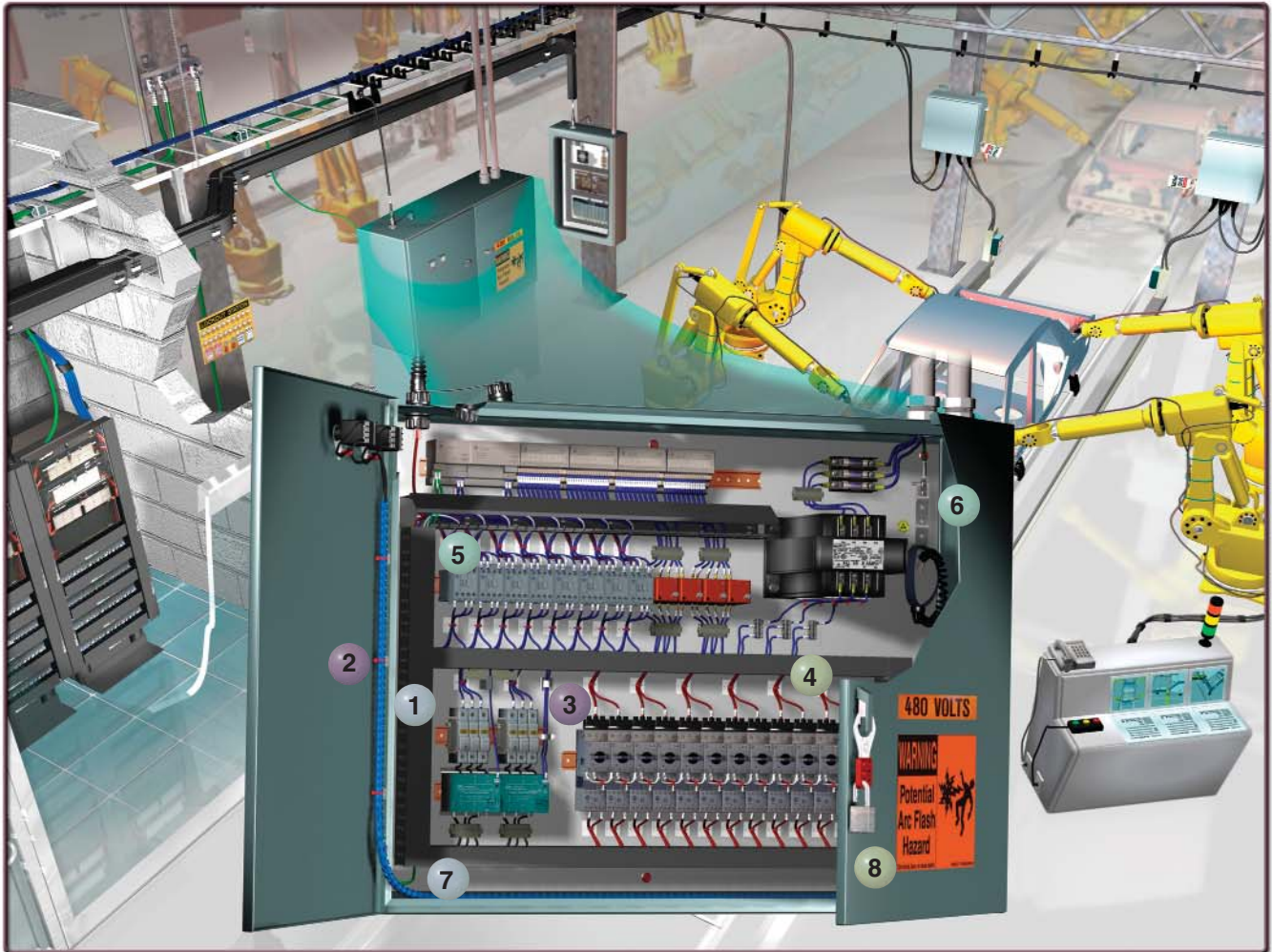

1 **Wiring Duct**



2 **Cable Ties**



3 **Cable Accessories**



4 **Labeling Systems**



5 **Terminals**



6 **Power and  
Grounding  
Connectors**



7 **Abrasion  
Protection**



8 **Lockout/  
Tagout**



For Industrial Automation Solutions, request SA-CPCB65 or visit [www.panduit.com](http://www.panduit.com).



## HARNESS SOLUTIONS

Panduit is a leading supplier of wire management solutions, helping OEM and CMs achieve their strategic objectives. From complete system solutions that provide the lowest installed cost to new product innovations that meet evolving application challenges, Panduit solutions meet a wide range of applications, volumes, and environments in white goods, gaming, vending, and transportation.

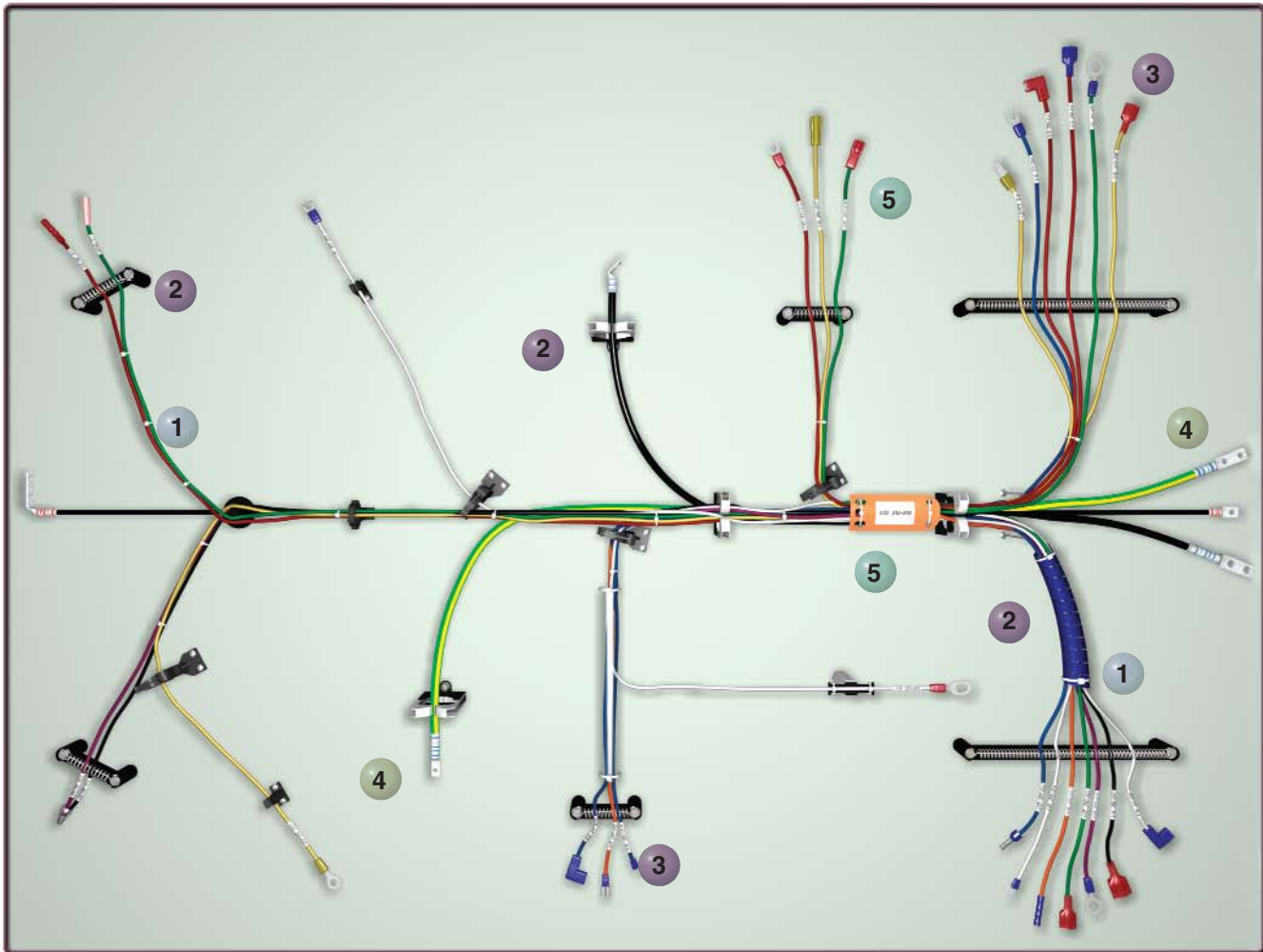

**1 Cable Tie Systems**



**2 Cable Accessories**



**3 Terminal Systems**



**4 Power Connector Systems**



**5 Identification Systems**



A.  
System  
Overview

B1.  
Cable Ties

B2.  
Cable  
Accessories

B3.  
Stainless  
Steel Ties

C1.  
Wiring  
Duct

C2.  
Surface  
Raceway

C3.  
Abrasion  
Protection

C4.  
Cable  
Management

D1.  
Terminals

D2.  
Power  
Connectors

D3.  
Grounding  
Connectors

E1.  
Labeling  
Systems

E2.  
Labels

E3.  
Pre-Printed  
& Write-On  
Markers

E4.  
Permanent  
Identification

E5.  
Lockout/  
Tagout  
& Safety  
Solutions

F.  
Index

A.  
System  
Overview

B1.  
Cable Ties

B2.  
Cable  
Accessories

B3.  
Stainless  
Steel Ties

C1.  
Wiring  
Duct

C2.  
Surface  
Raceway

C3.  
Abrasion  
Protection

C4.  
Cable  
Management

D1.  
Terminals

D2.  
Power  
Connectors

D3.  
Grounding  
Connectors

E1.  
Labeling  
Systems

E2.  
Labels

E3.  
Pre-Printed  
& Write-On  
Markers

E4.  
Permanent  
Identification

E5.  
Lockout/  
Tagout  
& Safety  
Solutions

F.  
Index



## CONTRACTOR SOLUTIONS

Panduit is committed to delivering innovative solutions that meet the needs of electrical and networking installations. Contractors rely on Panduit solutions for improved productivity, reliability, and safety with lower installed costs. A comprehensive range of products and tooling satisfies the most demanding applications and environments. Contractor programs further support your business needs and benefit the bottom line.



## MRO SOLUTIONS

Maximizing facility uptime while containing maintenance and repair costs is a big challenge facing industrial and manufacturing facilities. Electrical and control systems repair, reconfiguration, and preventative maintenance comprise a substantial portion of the total facility spend. Panduit solutions deliver best-in-class quality for maximum reliability and defect-free installations, minimizing rework and reducing downtime. The breadth of product lines and materials selection provides extensive application and environment-specific solutions for faster, easier, and more cost-effective maintenance and repair operations (MRO).



## HARSH ENVIRONMENT SOLUTIONS

When vibration, radiation, weathering, corrosion, and temperature extremes are a factor, you need a high quality, reliable, and durable solution. Panduit provides everything necessary to bundle, route, protect, terminate, and identify electrical and network cable in indoor and outdoor extreme conditions. These innovative solutions meet the needs of the most demanding harsh and industrial environment applications to deliver long life, increased productivity, and improved worker safety.



## TRANSPORTATION SOLUTIONS

Panduit develops high-quality products to meet the requirements of the transportation market while providing the lowest installed cost. Performance, reliability, efficiency, and availability are critical issues to success. Panduit solutions are designed to hold up under vibration, shock, and exposure to nature's elements while preventing corrosion, reducing weight, and speeding installation.

## UNIFIED PHYSICAL INFRASTRUCTURE<sup>SM</sup> APPROACH

The physical infrastructure is the basic foundation on which enterprise systems run, including voice and data communications, power, computing, control, and security systems. The need to provide real-time information, manage applications, and control functional systems through IP networking is also driving increased interdependence between these systems through several core enterprise areas.



Panduit offers Unified Physical Infrastructure (UPI)-based solutions that help customers optimize the physical infrastructure by intelligently converging physical and logical systems. These solutions leverage real-time information to:



- Manage systems more effectively
- Maximize performance and availability
- Satisfy regulatory compliance requirements
- Increase safety and security in the workplace



As the global leader in comprehensive electrical and network solutions, Panduit helps customers support and manage the physical infrastructure by leveraging robust product systems, technology leadership, global expertise and support, an extensive partner ecosystem, and world-renowned alliances.

Panduit systems optimize availability, reliability, security, integration, and safety throughout the physical infrastructure and combine to deliver industry and application solutions that enable business agility and lowest total cost of ownership. For more information visit:

[www.panduit.com/upi](http://www.panduit.com/upi).

### Unified Physical Infrastructure



communication    computing    control    power    security

A.  
System  
Overview

B1.  
Cable Ties

B2.  
Cable  
Accessories

B3.  
Stainless  
Steel Ties

C1.  
Wiring  
Duct

C2.  
Surface  
Raceway

C3.  
Abrasion  
Protection

C4.  
Cable  
Management

D1.  
Terminals

D2.  
Power  
Connectors

D3.  
Grounding  
Connectors

E1.  
Labeling  
Systems

E2.  
Labels

E3.  
Pre-Printed  
& Write-On  
Markers

E4.  
Permanent  
Identification

E5.  
Lockout/  
Tagout  
& Safety  
Solutions

F.  
Index

## APPLICATION STANDARDS

To help assure optimum quality, Panduit products are designed and manufactured to meet applicable environmental, safety, market industry and customer standards.

### Restriction of Hazardous Substances (RoHS)

#### RoHS

The European Union (EU) directive on the Restriction of use of certain Hazardous Substances bans the use of six substances in electrical and electronic equipment within the European Economic Community (EEC) after July 1, 2006. The RoHS status of Panduit Electrical Products, shown in this catalog, can be determined by accessing [www.panduit.com](http://www.panduit.com).

### Underwriters Laboratories, Inc



Underwriters Laboratories, Inc. (UL) is an independent, not-for-profit product-safety testing and certification organization based in the United States. Since its founding in 1894, UL is becoming one of the most recognized, reputable conformity assessment providers in the world. Today, services extend to helping companies achieve global acceptance, whether for an electrical device, a programmable system, or an organization's quality process. Further information on UL marks can be found at [www.ul.com/mark/](http://www.ul.com/mark/).

### Canadian Standards Association



The Canadian Standards Association is a not-for-profit membership based association serving business, industry, government and consumers in Canada and the global marketplace. CSA works in Canada and around the world to develop standards that enhance public safety and health. Additional information can be found at [www.csa.ca](http://www.csa.ca).

### Conformity European



CE marketing is required for certain products sold within the European Union (EU). EU Directives and Norms, specify the requirements for products. Applying the CE mark signifies compliance with those requirements.

### ISO 9001



The International Standards Organization (ISO) establishes worldwide standards for products and services in recognition of increasing globalization of markets. The ISO program establishes the requirements for quality assurance systems. All Panduit component manufacturing facilities are third party registered to ISO 9001. Registration certificates are available from Panduit, [www.panduit.com](http://www.panduit.com).

### ISO/TS16949

ISO/TS16949 is a recognized supplier quality standard for the automotive industry. The ISO community of accreditation bodies and registrars considers these additions automotive "interpretations" to the global ISO 9001 standard. Appropriate Panduit locations are third party registered to this standard. Registration certificates are available from Panduit, [www.panduit.com](http://www.panduit.com).

### ISO 14001



ISO14001 is a voluntary standard for Environmental Management Systems established by the International Organization for Standardization. The international standard provides a benchmark for continual improvement in environmental performance. Business partners can be confident that Panduit manufacturing facilities around the globe are engaged in an ongoing process to maximize value while minimizing the impact on natural resources.

### National Electrical Manufacturers Association (NEMA)

NEMA is the largest trade association in the U.S. representing electro-industry manufacturers. NEMA develops industry standards that are in the best interest of the industry and users of its products. NEMA standards for electrical power connector for substations covers uninsulated connectors and busbar supports which are made of metal and intended for use in substations. Included in the standard are manufacturing standards for bolt hole sizes and spacing for terminal connectors with single tangs. Panduit offers connectors that meet NEMA manufacturing standards and these are specially noted as listed within this catalog.

## APPLICATION STANDARDS (continued)

### Alliance for Telecommunications Industry Solutions (ATIS)



ATIS is a technical planning and standards development organization that is committed to rapidly developing and promoting technical and operations standards for the communications and related information technologies industry worldwide using a pragmatic, flexible, and open approach. Over 1,200 participants from more than 400 communications companies are active in ATIS' 22 industry committees, and its Incubator Solutions Program. Additional information can be found at [www.atis.org](http://www.atis.org).

J-STD-607-A-2002, Commercial Building Grounding (Earthing) and Bonding Requirements for Telecommunications is jointly developed by TIA/EIA and ATIS' technical committee T1E1. This document is available on the ATIS Document Center at [www.atis.org](http://www.atis.org).

Adhering to the grounding principles outlined in J-STD-607-A helps ensure that the telecommunications grounding and bonding system will perform acceptably regardless of the data and voice equipment installed. As stated in J-STD-607-A, the preferred means of connecting conductors to busbars is by using two-hole irreversible compression lugs listed by a nationally recognized testing laboratory (NRTL) such as UL. Panduit® Pan-Lug™ Copper Compression Connectors meet these requirements, in all barrel sizes specified by the 607 standard.

### Telecommunications Industry Association (TIA)



The Telecommunications Industry Association is a leading US non-profit trade association serving the communications and information technology industry. TIA represents providers of communications and information technology products and services for the global marketplace through its core competencies in standards development.

ANSI/TIA-942 Telecommunications Infrastructure Standard for Data Centers covers a wide range of facilities issues, including grounding and bonding. It states that electrical continuity is required throughout the rack materials. Adhering to these principles protects network equipment and maintains system performance.

### NEBS Level 3 Approval as Tested by Telcordia Technologies

Telcordia Technologies, formerly known as Bellcore, serves as the testing agency for the Regional Bell Operating Companies. Network Equipment-Building Systems (NEBS) was developed by Bellcore and is currently maintained by Telcordia Technologies. NEBS was developed to standardize requirements for Central Office Equipment and to develop criteria for personal safety, protection of property, and operational continuity.

NEBS Level 3 Criteria is the minimum level of environmental compatibility needed to provide maximum assurance of equipment operability within the network facility environment. The Level 3 criteria is the highest assurance of product operability. Products that meet NEBS Level 3 Criteria are suited for equipment applications which demand minimal service interruptions over the life span of the equipment. Panduit is the first in the industry to have a system of copper compression lugs and splices (#8 AWG – 1,000 kcmil) and crimping tools physically and rigorously tested by Telcordia Technologies to meet NEBS Level 3 compliance.

### American Bureau of Shipping (ABS)



ABS is a not-for-profit organization that promotes the security of life, property, and the natural environment primarily through the development and verification of standards for the design, construction, and operational maintenance of marine related facilities including: merchant and naval vessels, offshore drilling units, submersibles, FPSOs, etc. Panduit has ABS Type Approval for select copper compression lugs and splices and are in compliance with ABS 2005 Steel Vessel Rules and can be installed on ABS Type Approved steel vessel machinery, electrical systems, and electrical equipment. Panduit products that meet ABS Type Approval can be found listed on the ABS website at [www.typeapproval.org](http://www.typeapproval.org).

## PROGRAMS

Panduit maintains a dedicated global sales force of highly qualified industry experts to provide professional, consultative sales guidance. In addition, Panduit has partnered with best-in-class contractors and distributors to provide the services and support to deliver comprehensive, reliable solutions at the lowest installed cost.

### Contractor Loyalty Incentive Program (CLIP)

The CLIP program was developed to strengthen relationships and form alliances with valued contractors. Use Panduit as your preferred vendor for cable ties, terminals, power connectors, identification products, surface raceway, installation tooling and a host of related products, and earn credit towards Panduit tooling.

Benefits of being a CLIP participant include annual credit incentives, continuous training, potential project leads, and alliance with a global, world-class electrical manufacturer and exclusive promotions.

For more program details, go to [www.panduit.com/clip](http://www.panduit.com/clip) or contact Panduit Customer Service at 800-777-3300.

### Tooling Partnership Program

The tooling Partnership Program is designed to make low-cost or no cost tooling available to the customer based on qualification and commitment to termination product purchases.

For more program details, go to [www.panduit.com/tpp](http://www.panduit.com/tpp) or contact Panduit Customer Service at 800-777-3300.

### PC Express Program

PC Express offers the ultimate level of service for your power connector needs. PC Express is offered through select authorized Panduit distributors. The PC Express Program provides customers with the ability to receive power connector orders, via second day delivery, at no additional charge.

The customer can place an order of any size, up to a 300 lb. maximum weight, through an authorized Panduit distributor and Panduit will absorb the second day freight charges. All orders will be shipped directly to the customer. Orders received by Panduit Customer Service before 3:00 P.M. CST will be shipped on the same day, via second day delivery. Orders received after 3:00 P.M. CST will be shipped the next business day, via second day delivery.

For more program details, go to [www.panduit.com/pcexpress](http://www.panduit.com/pcexpress) or contact Panduit Customer Service at 800-777-3300.

Note: All programs and benefits are subject to terms and conditions.

## CABLE TIES



Panduit offers the most complete selection of cable tie styles, sizes, materials and colors to meet our customers' needs. Panduit cable ties bundle, mount, and identify in countless indoor, outdoor, and harsh environment applications. Panduit cable ties, wiring accessories, and installation tools allow our customers to achieve the lowest total installed cost of managing wire and cable.



- Panduit continues to provide innovative new cable tie designs to meet our customers' application challenges
- Panduit cable ties and wiring accessories can be used in a variety of applications and environments, providing the optimal wire management solution
- Panduit offers a large selection of ergonomic cable tie installation tools – all with consistent, and reliable performance

Panduit leads the industry in the breadth and depth of available cable tie designs created from customer feedback on their application requirements. As with all Panduit products, quality in design and production along with customer service excellence are assured.



A.  
System  
Overview

B1.  
Cable Ties

B2.  
Cable  
Accessories

B3.  
Stainless  
Steel Ties

C1.  
Wiring  
Duct

C2.  
Surface  
Raceway

C3.  
Abrasion  
Protection

C4.  
Cable  
Management

D1.  
Terminals

D2.  
Power  
Connectors

D3.  
Grounding  
Connectors

E1.  
Labeling  
Systems

E2.  
Labels

E3.  
Pre-Printed  
& Write-On  
Markers

E4.  
Permanent  
Identification

E5.  
Lockout/  
Tagout  
& Safety  
Solutions

F.  
Index

A. System Overview

## Cable Tie Selection Chart

Follow this step-by-step process to find the cable ties that best suit your application:

B1. Cable Ties

### Cable Tie Function

- 1) Select the main function of the cable tie you need:  
 Bundle = Standard Cable Ties  
 Re-use = Nylon Releasable Ties\*  
 Identify = Marker and Flag Ties  
 Mount = Clamp Ties, Push Mount Ties, and Stud Mount Ties

### Material Properties

- 2) Determine the appropriate material for your application:  
 Mechanical  
 Chemical  
 Thermal

### Cable Tie Family

- 3) Select the cable tie family that meets your overall needs

B2. Cable Accessories

B3. Stainless Steel Ties

C1. Wiring Duct

C2. Surface Raceway

C3. Abrasion Protection

C4. Cable Management

D1. Terminals

D2. Power Connectors

D3. Grounding Connectors

E1. Labeling Systems

E2. Labels

E3. Pre-Printed & Write-On Markers

E4. Permanent Identification

E5. Lockout/Tagout & Safety Solutions

F. Index

	Cable Tie Function		Bundle, Re-use, Identify, Mount	Bundle, Re-use, Identify, Mount	Bundle, Re-use, Mount	Bundle, Re-use, Mount	Bundle	Bundle
	Material	Test Method	Nylon 6.6	Weather Resistant Nylon 6.6	Impact Modified Weather Resistant Nylon 6.6	Heat Stabilized Nylon 6.6	Heat Stabilized Nylon 6.6	Heat Stabilized Weather Resistant Nylon 6.6
	Color	—	Natural	Black	Black	Black	Natural	Black
	Part Number Suffix (Material Designation)	—	No Suffix	0	0	30	39	300
	Tensile @ Yield @ 73°F (psi)	ISO 527	12,000	12,000	9,700	12,000	12,000	12,000
	Water Absorption (24 Hours)	ASTM D570	1.2%	1.2%	1.2%	1.2%	1.2%	1.2%
	Radiation Resistance (Rads)	—	1 x 10 <sup>5</sup>	1 x 10 <sup>5</sup>	1 x 10 <sup>5</sup>	1 x 10 <sup>5</sup>	1 x 10 <sup>5</sup>	1 x 10 <sup>5</sup>
	Weathering Life Expectancy (Years)/UV Resistance	—	1 – 2	7 – 9	7 – 9	4 – 5	1 – 2	7 – 9
	Impact Resistance	—	○	○	●	○	○	○
	Salts	—	●	●	●	●	●	●
	Hydrocarbons (Gas, Oil, Lubricants)	—	●	●	●	●	●	●
	Chlorinated Hydrocarbons	—	●	●	●	●	●	●
	Acids	—	●	●	●	●	●	●
	Bases	—	●	●	●	●	●	●
	Acid Rain	—	●	●	●	●	●	●
	Max. Continuous Use Temperature (Note 1)	UL 746B	185°F 85°C	185°F 85°C	185°F 85°C	239°F 115°C	239°F 115°C	212°F 100°C (Note 2)
	Min. Application Use Temperature	EN 50146	-76°F -60°C	-76°F -60°C	-76°F -60°C	-76°F -60°C	-76°F -60°C	-76°F -60°C
	Flammability Rating (Note 4)	UL 94	V-2	V-2	HB	V-2	V-2	V-2
	Low Smoke	ASTM E662	PASS	PASS	PASS	PASS	PASS	PASS
	Oxygen Index	BS ISO 4589	28	28	—	28	28	28
	Halogen-Free	IEC 60754-2	Yes	Yes	Yes	Yes	Yes	Yes
	Burning Fume Toxicity	BSS-7239	PASS	PASS	PASS	PASS	PASS	PASS
	Heat Deflection Temperature @ 1.8 Mpa	ASTM D648 ISO 75 -1/-2	158°F 70°C	158°F 70°C	145°F 63°C	158°F 70°C	158°F 70°C	158°F 70°C
	Relative Price	—	Low	Low	Low	Low	Low	Med

Product Line		Cross Sections				
Pan-Ty® (B1.6 - Note 5)	✓	SM, M, I, S	LH, H, EH	✓	✓	✓
Super-Grip® (B1.38)	✓	M, I, S, LH	H	✓		
Dome-Top® Barb Ty (B1.43)	✓	M, I, S	LH	✓	✓	✓
Dura-Ty™ (B1.53)						
Parallel-Entry (B1.56)	✓	M, I, S, HS	LH		✓	
Sta-Strap® (B1.65)	✓	M, I, S, LH, H		✓		
Specialty Ties (B1.73)	✓		H	✓		✓

Check mark indicates material availability in that product line.

Cross Sections: SM = Subminiature, M = Miniature, I = Intermediate, S = Standard, HS = Heavy-Standard, LH = Light-Heavy, H = Heavy, EH = Extra-Heavy.

\*For information on re-usable Hook and Loop Cable Ties, see page B1.85.



A.  
System  
Overview

B1.  
Cable Ties

B2.  
Cable  
Accessories

B3.  
Stainless  
Steel Ties

C1.  
Wiring  
Duct

C2.  
Surface  
Raceway

C3.  
Abrasion  
Protection

C4.  
Cable  
Management

D1.  
Terminals

D2.  
Power  
Connectors

D3.  
Grounding  
Connectors

E1.  
Labeling  
Systems

E2.  
Labels

E3.  
Pre-Printed  
& Write-On  
Markers

E4.  
Permanent  
Identification

E5.  
Lockout/  
Tagout  
& Safety  
Solutions

F.  
Index

Recommendation Legend	Highest	High	Acceptable	Low	Lowest
	●	◐	○	◑	●

Bundle	Bundle, Identify	Bundle	Bundle	Bundle, Re-use	Bundle	Bundle	Bundle	Bundle	Bundle	Bundle
Flame Retardant Nylon 6.6	Flame Retardant Nylon 6.6	Weather Resistant Nylon 12	Polypropylene	Weather Resistant Polypropylene	TEFZEL <sup>■</sup>	HALAR <sup>▲</sup>	PEEK	Metal Detectable Nylon 6.6	Metal Detectable Polypropylene	Weather Resistant Acetal
Black	Natural Ivory	Black	Green	Black	Aqua Blue	Maroon	Brown	Blue	Blue	Black
60	69	120	109	100	76	702Y	71	86	186	N/A
11,000	11,000	6,700	4,100	4,100	7,500	7,000	15,200	—	—	6,500
1.1%	1.1%	0.3%	0.1%	0.1%	<0.03%	<0.05%	0.5%	1.2%	0.1%	<0.45%
1 x 10 <sup>5</sup>	1 x 10 <sup>5</sup>	3.5 x 10 <sup>6</sup>	1 x 10 <sup>6</sup>	1 x 10 <sup>6</sup>	2 x 10 <sup>8</sup>	2 x 10 <sup>8</sup>	1 x 10 <sup>9</sup>	—	1 x 10 <sup>6</sup>	6 x 10 <sup>5</sup>
1 – 2	1 – 2	12 – 15	1	7 – 9	>15	>15	—	—	1	>20
◑	◑	○	◐	◐	●	●	●	○	◐	◐
◑	◑	◐	●	●	●	●	●	●	●	○
●	●	●	○	○	●	●	●	●	○	●
◐	◐	◐	○	○	●	●	●	◐	○	◐
●	●	●	●	●	●	●	○	●	●	●
◐	◐	◐	●	●	●	●	●	◐	●	●
○	○	◐	●	●	●	●	◐	○	●	○
212°F 100°C	212°F 100°C	194°F 90°C	239°F 115°C	239°F 115°C	338°F 170°C	302°F 150°C	500°F 260°C (Note 3)	185°F 85°C	239°F 115°C	185°F 85°C
-40°F -40°C	-76°F -60°C	-76°F -60°C	-76°F -60°C	-76°F -60°C	-76°F -60°C	-76°F -60°C	-76°F -60°C	-76°F -60°C	-76°F -60°C	-76°F -60°C
V-0	V-0	HB	HB	HB	V-0	V-0	V-0	HB	HB	HB
PASS	PASS	—	—	—	—	—	PASS	—	—	PASS
34	34	—	—	—	30	52	35	—	—	—
Yes	Yes	Yes	Yes	Yes	No	No	Yes	Yes	Yes	Yes
PASS	PASS	—	—	—	—	—	—	—	—	—
154°F 68°C	154°F 68°C	122°F 50°C	122°F 50°C	122°F 50°C	—	149°F 65°C	313°F 156°C	145°F 63°C	122°F 50°C	239°F 115°C
Med	Med	Med	Med	Med	High	High	High	Low	Med	Med

✓	✓	✓	✓	✓	✓	✓	✓	✓	✓	✓
	✓									
	✓									✓

**Note 1:** Also known as Relative Thermal Index (RTI), see Temperature (page B1.103)

**Note 2:** Estimated  
**Note 3:** Based on the UL RTI for electrical properties

**Note 4:** See Table B (page B1.102)  
**Note 5:** Also available in 00 material (meets Mil Spec)

■ TEFZEL is a registered trademark of E.I. du Pont de Nemours and Company.

▲ HALAR is a registered trademark of Ausimont USA, Inc.

A.  
System  
Overview

## Cable Tie Styles Overview

B1.  
Cable Ties

### Pan-Ty® Cable Ties

Pages B1.6 – B1.37

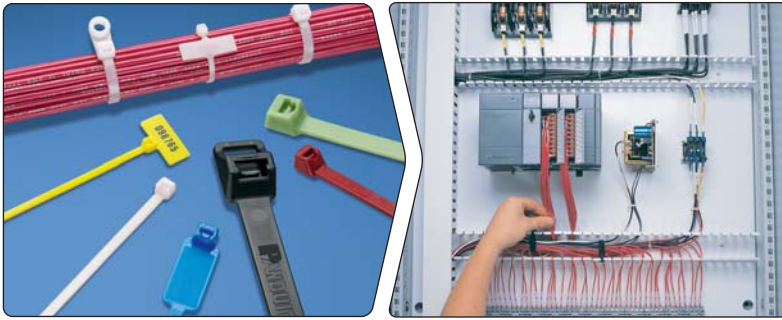

- Designed for use in numerous applications to meet a variety of needs in the OEM, MRO, and construction markets
- Largest selection of styles, materials, and sizes
- One-piece construction for consistent performance and reliability
- Lowest threading force of any one-piece cable tie in the industry

B2.  
Cable  
Accessories

B3.  
Stainless  
Steel Ties

C1.  
Wiring  
Duct

### Super-Grip® Cable Ties

Pages B1.38 – B1.42



- Designed for the strength requirements of the MRO and construction markets
- Thin, wide strap body – flexible, conforms to bundles
- Strong – withstands rough installation practices
- Grips wires tightly and resists lateral movement

C2.  
Surface  
Raceway

C3.  
Abrasion  
Protection

C4.  
Cable  
Management

D1.  
Terminals

### Dome-Top® Barb Ty Cable Ties

Pages B1.43 – B1.55



- Approved for the demanding MRO and construction requirements as typified in the oil and gas markets
- Stainless steel barb provides consistent performance and reliability
- Infinitely adjustable for tight bundles throughout entire bundle range
- Dome-top head features unique patented design with smooth, round edges

D2.  
Power  
Connectors

D3.  
Grounding  
Connectors

E1.  
Labeling  
Systems

E2.  
Labels

### Parallel-Entry Cable Ties

Pages B1.56 – B1.64



- Designed for use in the OEM and transportation markets
- All parallel-entry ties provide a low profile head which avoids snags and reduces overall bundle size
- No protrusion of tie cut-off – protects workers' arms/hands
- Contour-Ty® Cable Ties have outside teeth and smooth, round edges to protect cable jacket – perfect for high vibration applications

E3.  
Pre-Printed  
& Write-On  
Markers

E4.  
Permanent  
Identification

E5.  
Lockout/  
Tagout  
& Safety  
Solutions

F.  
Index

## Sta-Strap® Cable Ties

Pages B1.65 – B1.72

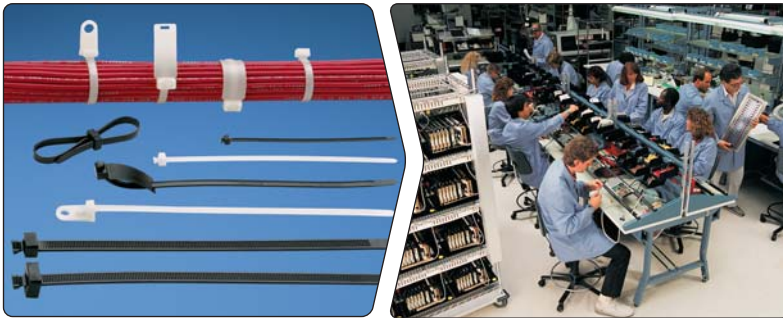

- Convenient and easy to use in OEM manual assembly operations
- Exclusive, two-piece design provides lowest threading force in the industry
- Use for normal bundling and through-panel applications
- Releasable prior to final tensioning and cut-off

## Network Cable Ties

Pages B1.85 – B1.92



- Ideal for the telecommunications, financial, education, and government markets
- Adjustable, releasable, and re-usable
- No risk of over-tensioning or damaging high performance network cables
- Variety of styles, sizes, and colors

## Manual Cable Tie Installation Tools

Pages B1.109 – B1.114

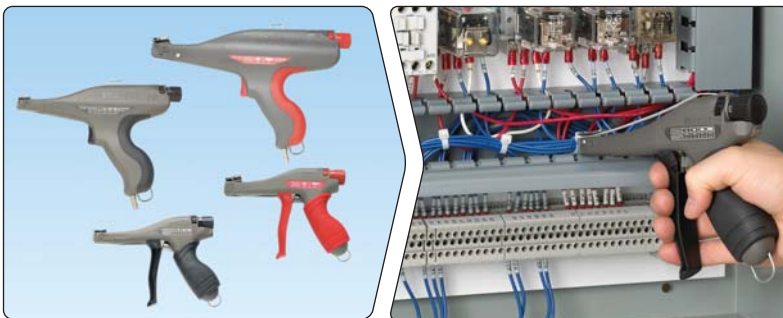

- Used in production, maintenance, and construction applications
- Designed for ease of use and to reduce repetitive stress injuries
- Full line of lightweight, ergonomic hand tools – Panduit leads the industry in reliability and performance
- Flush cut-off of cable tie limits exposure to sharp edges

## Automatic Cable Tie Installation Tools

Pages B1.115 – B1.122



- An efficient solution for high volume OEM harness, assembly, fastening and packaging applications
- High-speed tools lower installed cost and reduce operator fatigue
- Wrap, tension, and cut-off cable ties in less than a second
- Reel-fed systems for miniature and standard cross section cable ties

A.  
System  
Overview

## Features and Benefits – Pan-Ty® Cable Ties

One-piece design for consistent performance and reliability.

Available in lengths from 2.8 to 43.3 inches and a variety of styles, materials, and colors for specific applications.

B1.  
Cable Ties

B2.  
Cable  
Accessories

B3.  
Stainless  
Steel Ties

C1.  
Wiring  
Duct

C2.  
Surface  
Raceway

C3.  
Abrasion  
Protection

C4.  
Cable  
Management

D1.  
Terminals

D2.  
Power  
Connectors

D3.  
Grounding  
Connectors

E1.  
Labeling  
Systems

E2.  
Labels

E3.  
Pre-Printed  
& Write-On  
Markers

E4.  
Permanent  
Identification

E5.  
Lockout/  
Tagout  
& Safety  
Solutions

F.  
Index

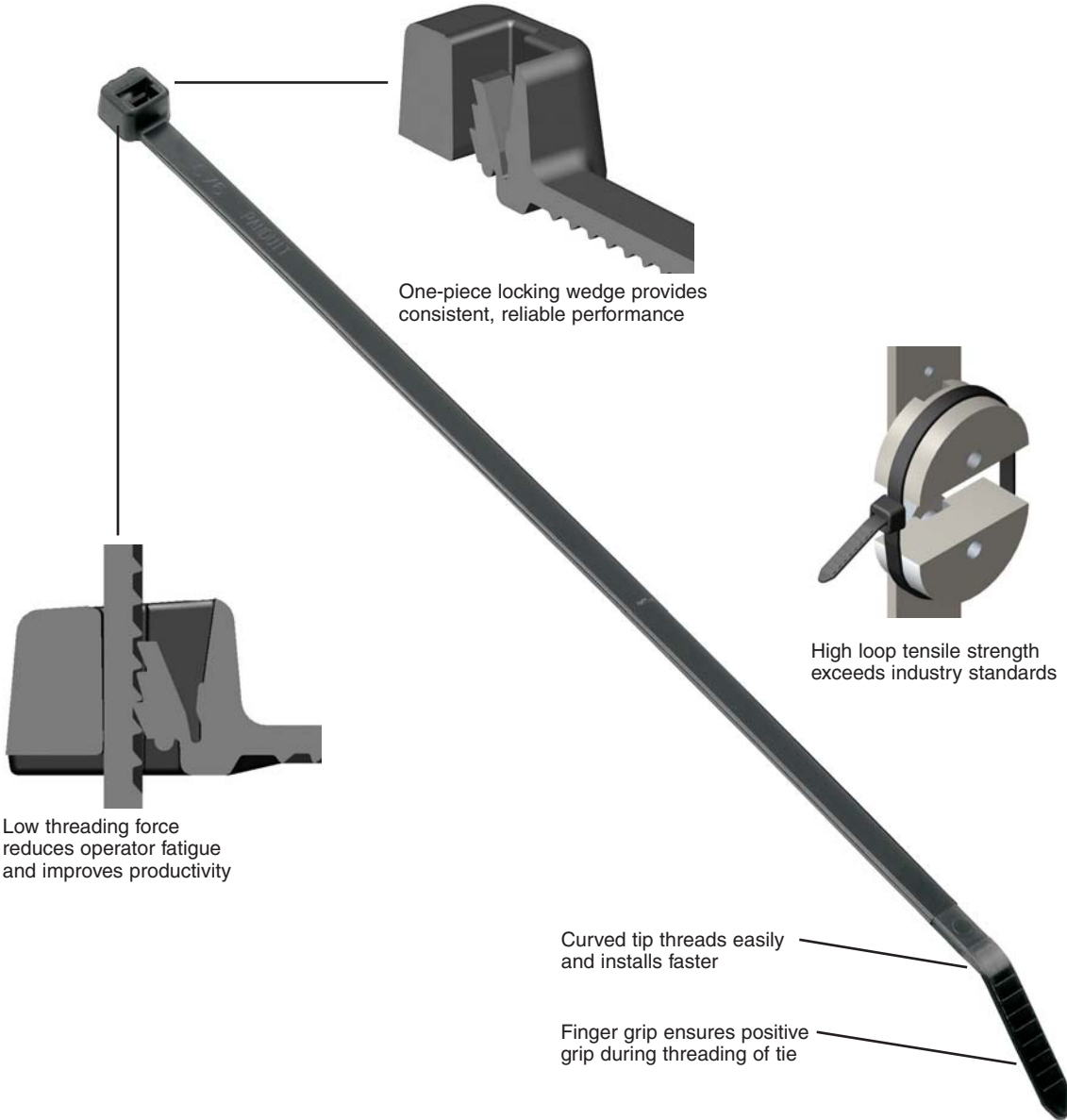

Cable tie tools speed installation and reduce total installed cost. See pages B1.109 – B1.114.



Cable tie accessories are used to speed and simplify the mounting of wires, cables, and tubing. See pages B2.1 – B2.29.

## Selection Guide – Pan-Ty® Cable Ties



Material, Color (Suffix)	Style/Function	Part Number Prefix	Catalog Page
Nylon 6.6, Natural (No Suffix)	Locking Ties/Bundle	PLT	B1.8,9
	Releasable Ties/Re-usable	PRT	B1.22
	Clamp Ties/Mount	PLC	B1.26
	Push Mount Ties/Mount	PLWP, PRWP, PLUP, PLP	B1.28,30,33
	Marker Ties/Identify	PLF, PLM	B1.34
Weather Resistant Nylon 6.6, Black (0)	Locking Ties/Bundle	PLT	B1.10,11
	Releasable Ties/Re-usable	PRT	B1.23,24
	Clamp Ties/Mount	PLC	B1.27
	Push Mount Ties/Mount	PLWP, PRWP, PLUP, PLP	B1.29 – B1.33
	Marker Ties/Identify	PLF, PLM	B1.34
Heat Stabilized Nylon 6.6, Black (30)	Locking Ties/Bundle	PLT	B1.12
	Releasable Ties/Re-usable	PRT	B1.23,24
	Clamp Ties/Mount	PLC	B1.27
	Push Mount Ties/Mount	PLWP, PRLWP, PRWP, PLUP, PLP	B1.29 – B1.33
Heat Stabilized Weather Resistant Nylon 6.6, Black (300)	Locking Ties/Bundle	PLT	B1.13
Heat Stabilized Nylon 6.6, Natural (39)	Locking Ties/Bundle	PLT	B1.12
Flame Retardant Nylon 6.6, Black (60)	Locking Ties/Bundle	PLT	B1.14
Flame Retardant Nylon 6.6, Ivory (69)	Locking Ties/Bundle	PLT	B1.14
	Marker Ties/Identify	PLF, PLM	B1.34
Weather Resistant Nylon 12, Black (120)	Locking Ties/Bundle	PLT	B1.15
Polypropylene, Green (109)	Locking Ties/Bundle	PLT	B1.16
Weather Resistant Polypropylene, Black (100)	Locking Ties/Bundle	PLT	B1.17
	Releasable Ties/Re-usable	PRT	B1.25
HALAR <sup>▲</sup> , Maroon (702)	Locking Ties/Bundle	PLT	B1.18,19
TEFZEL <sup>■</sup> , Aqua Blue (76)			
PEEK, Translucent Brown (71)	Locking Ties/Bundle	PLT	B1.20
Metal Detectable, Blue (86, 186)	Locking Ties/Bundle	PLT	B1.21

▲HALAR is a registered trademark of Ausimont USA, Inc.    ■TEFZEL is a registered trademark of E.I. du Pont de Nemours and Company.

### Part Number System for Pan-Ty® Cable Ties

PLT	2	S	—	C	—
Type	Size	Cross Section	Screw Hole Size	Package Size	Material/Color
PLT = Locking Tie	Approx.	SM = Subminiature	(Clamp Ties Only)	Q = 25	See Page B1.35
PRT = Releasable Tie	Maximum	M = Miniature	-S4 = #4 (M2.5)	L = 50	
PLC = Locking Clamp	Bundle	I = Intermediate	-S6 = #6 (M3)	C = 100	
PLF = Locking Flag	Dia. (In.)	S = Standard	-S8 = #8 (M4)	TL = 250	
PLM = Locking Marker		LH = Light-Heavy	-S10 = #10 (M5)	D = 500	
PLP = Locking Push Mount		H = Heavy	-S25 = 1/4 (M6)	M = 1000	
PLWP = Locking Wing Push Mount		EH = Extra-Heavy		VMR = 2 reels/2500 ea.	
PRLWP = Releasable Ladder Wing Push Mount				XMR = 2 reels/5000 ea.	
PRWP = Releasable Wing Push Mount					
PLUP = Locking Umbrella Push Mount					

A. System Overview

**UL US** **UL LISTED** **SF US** **Pan-Ty® Cable Ties – Nylon 6.6**

B1. Cable Ties

- For indoor use
- Versatile cable ties can be used in countless applications
- One-piece construction for consistent performance and reliability
- Lowest threading force of any one-piece cable tie in the industry

- Curved tip is easy to pick up from flat surfaces and allows faster initial threading to speed installation
- A variety of materials and colors available for specific applications
- UL Listed for use in plenum or air handling spaces per NEC except PLT.6SM and PLT5H/6H/8H/13H

B2. Cable Accessories

B3. Stainless Steel Ties

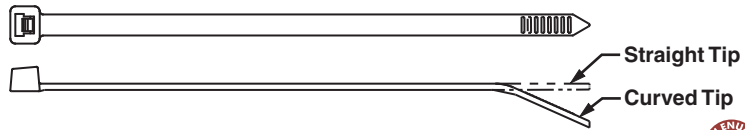
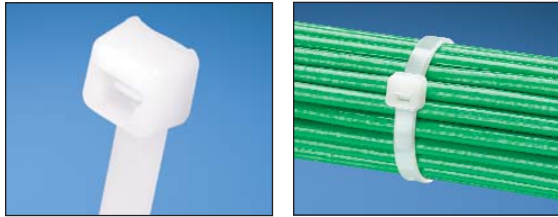

C1. Wiring Duct

C2. Surface Raceway

Part Number	Length		Width		Thickness		Max. Bundle Dia.		Min. Loop Tensile Str.		Recommended Installation Tool	Std. Pkg. Qty.	Std. Ctn. Qty.
	In.	mm	In.	mm	In.	mm	In.	mm	Lbs.	N			

**Subminiature Cross Section**

<b>PLT.6SM-C</b>	2.8	71	.070	1.8	.030	.8	.60	15	8	36	GTS, GTSL, PTS	100	1000
------------------	-----	----	------	-----	------	----	-----	----	---	----	----------------	-----	------

**Miniature Cross Section – Plenum-Rated**

<b>PLT.7M-C</b>	3.1	79	.090	2.3	.032	.8	.68	17	18	80	GTS, GTSL, GS2B, PTS, PPTS, STS2	100	1000
<b>PLT1M-C</b>	3.9	99	.098	2.5	.043	1.1	.87	22	18	80		100	1000
<b>PLT1.5M-C</b>	5.6	142	.098	2.5	.043	1.1	1.25	32	18	80		100	1000
<b>PLT2M-C</b>	8.0	203	.098	2.5	.043	1.1	2.00	51	18	80		100	1000

**Intermediate Cross Section – Plenum-Rated**

<b>PLT1.5I-C</b>	5.6	142	.142	3.6	.045	1.1	1.38	35	40	178	GTS, GTSL, GS2B, PTS, PPTS, STS2	100	1000
<b>PLT2I-C</b>	8.0	203	.142	3.6	.045	1.1	2.00	51	40	178		100	1000
<b>PLT2.5I-C</b>	9.7	246	.145	3.7	.052	1.3	2.50	64	40	178		100	1000
<b>PLT3I-C</b>	11.4	290	.145	3.7	.052	1.3	3.00	76	40	178		100	1000
<b>PLT4I-C</b>	14.5	368	.145	3.7	.052	1.3	4.00	102	40	178		100	1000

**Standard Cross Section – Plenum-Rated**

<b>PLT1S-C</b>	4.8	122	.190	4.8	.052	1.3	1.00	25	50	222	GTS, GTSL, GS2B, GTH, GS4H, PTS, PPTS, PTH, STS2, STH2	100	1000
<b>PLT1.5S-C</b>	6.2	157	.190	4.8	.052	1.3	1.50	38	50	222		100	1000
<b>PLT2S-C</b>	7.4	188	.190	4.8	.052	1.3	1.88	48	50	222		100	1000
<b>PLT2.5S-C</b>	9.8	249	.190	4.8	.052	1.3	2.50	64	50	222		100	1000
<b>PLT3S-C</b>	11.5	292	.190	4.8	.052	1.3	3.00	76	50	222		100	1000
<b>PLT4S-C</b>	14.5	368	.190	4.8	.052	1.3	4.00	102	50	222		100	1000
<b>PLT4.5S-C</b>	15.5	394	.190	4.8	.052	1.3	4.50	114	50	222		100	1000
<b>PLT5S-C</b>	17.5	445	.190	4.8	.052	1.3	5.00	127	50	222		100	500

**Light-Heavy Cross Section (Straight Tip) – Plenum-Rated**

<b>PLT2H-L</b>	8.1	206	.300	7.6	.075	1.9	2.00	51	120	534	GTH, GS4H, GS4EH, PTH, STH2, ST3EH	50	500
<b>PLT2.5H-L</b>	9.8	251	.300	7.6	.075	1.9	2.50	64	120	534		50	500
<b>PLT3H-L</b>	11.4	290	.300	7.6	.075	1.9	3.00	76	120	534		50	500
<b>PLT4H-L</b>	14.5	368	.300	7.6	.075	1.9	4.00	102	120	534		50	500
<b>PLT6LH-L</b>	21.9	556	.300	7.6	.075	1.9	6.00	152	120	534		50	500
<b>PLT7LH-L</b>	24.7	627	.300	7.6	.075	1.9	7.00	178	120	534		50	500
<b>PLT8LH-L</b>	27.6	701	.300	7.6	.075	1.9	8.00	203	120	534		50	500
<b>PLT9LH-L*</b>	30.5	775	.300	7.6	.075	1.9	9.00	229	120	534		50	500
<b>PLT10LH-L*</b>	34.3	871	.300	7.6	.075	1.9	10.31	262	120	534		50	1000

**Heavy Cross Section (Straight Tip)**

<b>PLT5H-L*</b>	17.7	450	.350	8.9	.078	2.0	5.00	127	175	778	GTH, GS4H, GS4EH, PTH, STH2, ST3EH	50	500
<b>PLT6H-L*</b>	20.9	530	.350	8.9	.078	2.0	6.00	152	175	778		50	500
<b>PLT8H-L*</b>	30.6	779	.350	8.9	.078	2.0	9.00	229	175	778		50	500
<b>PLT13H-Q*</b>	43.3	1100	.350	8.9	.078	2.0	13.00	330	175	778		25	500

\*UL Listed – meets the requirements of UL 181B-C, for securing UL Listed non-metallic air ducts and air connectors.

C3. Abrasion Protection

C4. Cable Management

D1. Terminals

D2. Power Connectors

D3. Grounding Connectors

E1. Labeling Systems

E2. Labels

E3. Pre-Printed & Write-On Markers

E4. Permanent Identification

E5. Lockout/Tagout & Safety Solutions

F. Index

## Pan-Ty® Lashing Ties – Nylon 6.6

- For indoor use
- Typically used for heavy duty applications
- Strongest Pan-Ty® Cable Tie available
- Can be used with MCEH mounting clip, see page B1.24

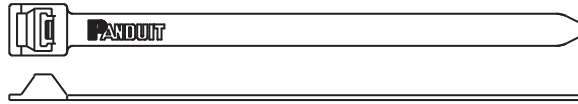

Part Number	Length		Width		Thickness		Max. Bundle Dia.		Min. Loop Tensile Str.		Recommended Installation Tool	Std. Pkg. Qty.	Std. Ctn. Qty.
	In.	mm	In.	mm	In.	mm	In.	mm	Lbs.	N			
<b>Extra-Heavy Cross Section</b>													
PLT2EH-C	9.0	229	.500	12.7	.075	1.9	2.00	51	250	1112	GS4EH, ST3EH	100	1000
PLT5EH-Q	20.1	511	.500	12.7	.075	1.9	5.00	127	250	1112		25	250
PLT6EH-Q	22.2	564	.500	12.7	.075	1.9	6.00	152	250	1112		25	250
PLT8EH-C	28.3	719	.500	12.7	.085	2.2	8.00	203	250	1112		100	1000
PLT10EH-C	34.2	869	.500	12.7	.085	2.2	10.00	254	250	1112		100	500
PLT12EH-C	40.1	1019	.500	12.7	.085	2.2	12.00	305	250	1112		100	500

A.  
System  
Overview

B1.  
Cable Ties

B2.  
Cable  
Accessories

B3.  
Stainless  
Steel Ties

C1.  
Wiring  
Duct

C2.  
Surface  
Raceway

C3.  
Abrasion  
Protection

C4.  
Cable  
Management

D1.  
Terminals

D2.  
Power  
Connectors

D3.  
Grounding  
Connectors

E1.  
Labeling  
Systems

E2.  
Labels

E3.  
Pre-Printed  
& Write-On  
Markers

E4.  
Permanent  
Identification

E5.  
Lockout/  
Tagout  
& Safety  
Solutions

F.  
Index

A. System Overview



## Pan-Ty® Cable Ties – Weather Resistant Nylon 6.6

B1. Cable Ties

- Greater resistance to damage caused by ultraviolet light – indoor or outdoor use
- Versatile cable ties can be used in countless applications
- One-piece construction for consistent performance and reliability
- Lowest threading force of any one-piece cable tie in the industry
- Curved tip is easy to pick up from flat surfaces and allows faster initial threading to speed installation

B2. Cable Accessories



B3. Stainless Steel Ties

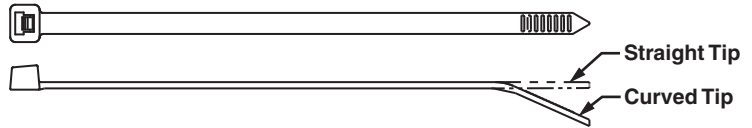

C1. Wiring Duct

C2. Surface Raceway

Part Number	Length		Width		Thickness		Max. Bundle Dia.		Min. Loop Tensile Str.		Recommended Installation Tool	Std. Pkg. Qty.	Std. Ctn. Qty.
	In.	mm	In.	mm	In.	mm	In.	mm	Lbs.	N			

### Subminiature Cross Section

<b>PLT.6SM-C0</b>	2.8	71	.070	1.8	.030	.8	.60	15	8	36	GTS, GTSL, PTS	100	1000
-------------------	-----	----	------	-----	------	----	-----	----	---	----	----------------	-----	------

### Miniature Cross Section

<b>PLT.7M-M0</b>	3.1	79	.090	2.3	.032	.8	.68	17	18	80	GTS, GTSL, GS2B, PTS, PPTS, STS2	1000	50000
<b>PLT1M-C0</b>	3.9	99	.098	2.5	.043	1.1	.87	22	18	80		100	1000
<b>PLT1.5M-C0</b>	5.6	142	.098	2.5	.043	1.1	1.25	32	18	80		100	1000
<b>PLT2M-C0</b>	8.0	203	.098	2.5	.043	1.1	2.00	51	18	80		100	1000

### Intermediate Cross Section

<b>PLT1.5I-C0</b>	5.6	142	.142	3.6	.045	1.1	1.38	35	40	178	GTS, GTSL, GS2B, PTS, PPTS, STS2	100	1000
<b>PLT2I-C0</b>	8.0	203	.142	3.6	.045	1.1	2.00	51	40	178		100	1000
<b>PLT2.5I-C0</b>	9.7	246	.145	3.7	.052	1.3	2.50	64	40	178		100	1000
<b>PLT3I-C0</b>	11.4	290	.145	3.7	.052	1.3	3.00	76	40	178		100	1000
<b>PLT4I-C0</b>	14.5	368	.145	3.7	.052	1.3	4.00	102	40	178		100	1000

### Standard Cross Section

<b>PLT1S-C0</b>	4.8	122	.190	4.8	.052	1.3	1.00	25	50	222	GTS, GTSL, GS2B, GTH, GS4H, PTS, PTH, PPTS, STS2, STH2	100	1000
<b>PLT1.5S-C0</b>	6.2	157	.190	4.8	.052	1.3	1.50	38	50	222		100	1000
<b>PLT2S-C0</b>	7.4	188	.190	4.8	.052	1.3	1.88	48	50	222		100	1000
<b>PLT2.5S-C0</b>	9.8	249	.190	4.8	.052	1.3	2.50	64	50	222		100	1000
<b>PLT3S-C0</b>	11.5	292	.190	4.8	.052	1.3	3.00	76	50	222		100	1000
<b>PLT4S-C0</b>	14.5	368	.190	4.8	.052	1.3	4.00	102	50	222		100	1000
<b>PLT4.5S-C0</b>	15.5	394	.190	4.8	.052	1.3	4.50	114	50	222		100	1000
<b>PLT5S-C0</b>	17.5	445	.190	4.8	.052	1.3	5.00	127	50	222		100	500

### Light-Heavy Cross Section (Straight Tip)

<b>PLT2H-L0</b>	8.1	206	.300	7.6	.075	1.9	2.00	51	120	534	GTH, GS4H, GS4EH, PTH, STH2, ST3EH	50	500
<b>PLT2.5H-L0</b>	9.8	251	.300	7.6	.075	1.9	2.50	64	120	534		50	500
<b>PLT3H-L0</b>	11.4	290	.300	7.6	.075	1.9	3.00	76	120	534		50	500
<b>PLT4H-L0</b>	14.5	368	.300	7.6	.075	1.9	4.00	102	120	534		50	500
<b>PLT6LH-L0</b>	21.9	556	.300	7.6	.075	1.9	6.00	152	120	534		50	500
<b>PLT7LH-L0</b>	24.7	627	.300	7.6	.075	1.9	7.00	178	120	534		50	500
<b>PLT8LH-L0</b>	27.6	701	.300	7.6	.075	1.9	8.00	203	120	534		50	500
<b>PLT9LH-L0</b>	30.5	775	.300	7.6	.075	1.9	9.00	229	120	534		50	500

### Heavy Cross Section (Straight Tip)

<b>PLT5H-L0</b>	17.7	450	.350	8.9	.078	2.0	5.00	127	175	778	GTH, GS4H, GS4EH, PTH, STH2, ST3EH	50	500
<b>PLT6H-L0</b>	20.9	530	.350	8.9	.078	2.0	6.00	152	175	778		50	500
<b>PLT8H-L0</b>	30.6	779	.350	8.9	.078	2.0	9.00	229	175	778		50	500
<b>PLT13H-Q0</b>	43.3	1100	.350	8.9	.078	2.0	13.00	330	175	778		25	500

Note: UL Listed and UL Recognized except PLT.6SM and PLT2H/2.5H/3H/4H/5H/6H/8H/13H; CSA Certified except LH and H cross sections.

F. Index



## Pan-Ty® Lashing Ties – Weather Resistant Nylon 6.6

- Greater resistance to damage caused by ultraviolet light – indoor or outdoor use
- Typically used for heavy duty applications
- Strongest Pan-Ty® Cable Tie available
- Can be used with MCEH mounting clip, shown below



Lashing Tie



No Buckle Design

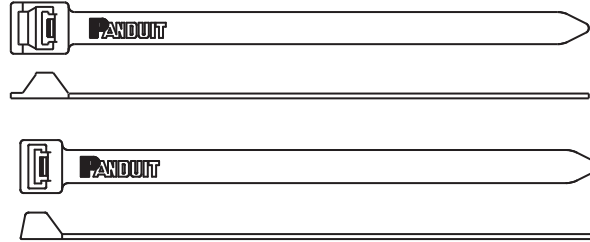

Part Number	Length		Width		Thickness		Max. Bundle Dia.		Min. Loop Tensile Str.		Recommended Installation Tool	Std. Pkg. Qty.	Std. Ctn. Qty.
	In.	mm	In.	mm	In.	mm	In.	mm	Lbs.	N			
<b>Extra-Heavy Cross Section</b>													
PLT2EH-Q0	9.0	229	.500	12.7	.075	1.9	2.00	51	250	1112	GS4EH, ST3EH	25	250
PLT5EH-Q0	20.1	511	.500	12.7	.075	1.9	5.00	127	250	1112		25	250
PLT6EH-Q0	22.2	564	.500	12.7	.075	1.9	6.00	152	250	1112		25	250
PLT8EH-Q0	28.3	719	.500	12.7	.085	2.2	8.00	203	250	1112		25	250
PLT10EH-Q0	34.2	869	.500	12.7	.085	2.2	10.00	254	250	1112		25	250
PLT12EH-Q0	40.1	1019	.500	12.7	.085	2.2	12.00	305	250	1112		25	250
<b>Extra-Heavy Cross Section (No Buckle Design)</b>													
PLT3EH-NB-C0	12.2	310	.500	12.7	.075	1.9	3.30	84	250	1112	GS4EH, ST3EH	100	1000
PLT5EH-NB-C0	19.8	503	.500	12.7	.075	1.9	5.00	127	250	1112		100	1000
PLT6EH-NB-C0	21.8	554	.500	12.7	.075	1.9	6.00	152	250	1112		100	1000

## MCEH® Lashing Tie Mounting Clip – Weather Resistant Nylon 6.6

- Greater resistance to damage caused by ultraviolet light – indoor or outdoor use
- Converts Panduit lashing ties into clamps
- Easily snaps in place for a secure clamp
- Use with lashing ties shown on pages B1.9, B1.11, B1.22, B1.24 and B1.25

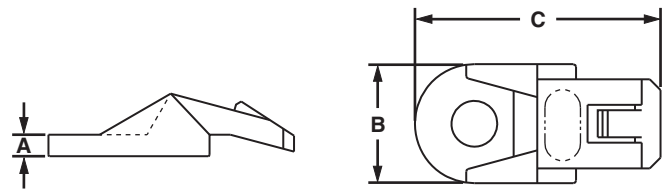

Part Number	Height A		Width B		Length C		Mounting Method	Std. Pkg. Qty.	Std. Ctn. Qty.
	In.	mm	In.	mm	In.	mm			
MCEH-S25-C0	.13	3.3	.67	17.0	1.38	35	1/4" (M6) screw (not flathead)	100	1000

A. System Overview

**Pan-Ty® Cable Ties – Heat Stabilized Nylon 6.6**

B1. Cable Ties

- For high temperature applications up to 239°F (115°C) – indoor use
- One-piece construction for consistent performance and reliability

- Lowest threading force of any one-piece cable tie in the industry
- Curved tip is easy to pick up from flat surfaces and allows faster initial threading to speed installation

B2. Cable Accessories



B3. Stainless Steel Ties

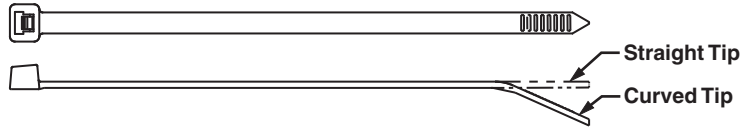

C1. Wiring Duct

C2. Surface Raceway

Part Number	Length		Width		Thickness		Max. Bundle Dia.		Min. Loop Tensile Str.		Recommended Installation Tool	Std. Pkg. Qty.	Std. Ctn. Qty.
	In.	mm	In.	mm	In.	mm	In.	mm	Lbs.	N			

**Subminiature Cross Section**

<b>PLT.6SM-M30</b>	2.8	71	.070	1.8	.030	.8	.60	15	8	36	GTS, GTSL, PTS	1000	50000
--------------------	-----	----	------	-----	------	----	-----	----	---	----	----------------	------	-------

**Miniature Cross Section**

<b>PLT.7M-M30</b>	3.1	79	.090	2.3	.032	.8	.68	17	18	80	GTS, GTSL, GS2B, PTS, PPTS, STS2	1000	50000
<b>PLT1M-C30</b>	3.9	99	.098	2.5	.043	1.1	.87	22	18	80		100	1000
<b>PLT1.5M-M30</b>	5.6	142	.098	2.5	.043	1.1	1.25	32	18	80		1000	50000
<b>PLT2M-M30</b>	8.0	203	.098	2.5	.043	1.1	2.00	51	18	80		1000	25000

**Intermediate Cross Section**

<b>PLT1.5I-C30</b>	5.6	142	.142	3.6	.045	1.1	1.38	35	40	178	GTS, GTSL, GS2B, PTS, PPTS, STS2	100	1000
<b>PLT2I-C30</b>	8.0	203	.142	3.6	.045	1.1	2.00	51	40	178		100	1000
<b>PLT3I-M30</b>	11.4	290	.145	3.7	.052	1.3	3.00	76	40	178		1000	10000
<b>PLT4I-M30</b>	14.5	368	.145	3.7	.052	1.3	4.00	102	40	178		1000	10000

**Standard Cross Section**

<b>PLT1S-M30</b>	4.8	122	.190	4.8	.052	1.3	1.00	25	50	222	GTS, GTSL, GS2B, GTH, GS4H, PTS, PTH, PPTS, STS2, STH2	1000	10000
<b>PLT1.5S-M30</b>	6.2	157	.190	4.8	.052	1.3	1.50	38	50	222		1000	10000
<b>PLT2S-C30</b>	7.4	188	.190	4.8	.052	1.3	1.88	48	50	222		100	1000
<b>PLT2S-M39*</b>	7.4	188	.190	4.8	.052	1.3	1.88	48	50	222		1000	10000
<b>PLT2.5S-M30</b>	9.8	249	.190	4.8	.052	1.3	2.50	64	50	222		1000	10000
<b>PLT3S-C30</b>	11.5	292	.190	4.8	.052	1.3	3.00	76	50	222		100	1000
<b>PLT4S-C30</b>	14.5	368	.190	4.8	.052	1.3	4.00	102	50	222		100	1000
<b>PLT5S-M30</b>	17.5	445	.190	4.8	.052	1.3	5.00	127	50	222		1000	5000

**Light-Heavy Cross Section (Straight Tip)**

<b>PLT2H-TL30</b>	8.1	206	.300	7.6	.075	1.9	2.00	51	120	534	GTH, GS4H, GS4EH, PTH, STH2, ST3EH	250	2500
<b>PLT3H-TL30</b>	11.4	290	.300	7.6	.075	1.9	3.00	76	120	534		250	2500
<b>PLT4H-TL30</b>	14.5	368	.300	7.6	.075	1.9	4.00	102	120	534		250	2500
<b>PLT7LH-C30</b>	24.7	627	.300	7.6	.075	1.9	7.00	178	120	534		100	2000
<b>PLT9LH-C30</b>	30.5	775	.300	7.6	.075	1.9	9.00	229	120	534		100	1000

**Heavy Cross Section (Straight Tip)**

<b>PLT5H-C30</b>	17.7	450	.350	8.9	.078	2.0	5.00	127	175	778	GTH, GS4H, GS4EH, PTH, STH2, ST3EH	100	2000
<b>PLT6H-C30</b>	20.9	530	.350	8.9	.078	2.0	6.00	152	175	778		100	2000
<b>PLT8H-C30</b>	30.6	779	.350	8.9	.078	2.0	9.00	229	175	778		100	1500

\*Natural heat stabilized material (39).  
Note: UL Listed except PLT.6SM and PLT5H/6H/8H.

E5. Lockout/Tagout & Safety Solutions

F. Index



## Pan-Ty® Cable Ties – Heat Stabilized Weather Resistant Nylon 6.6

- Greater resistance to damage caused by ultraviolet light and for high temperature applications up to 212°F (100°C) – indoor or outdoor use
- One-piece construction for consistent performance and reliability

- Lowest threading force of any one-piece cable tie in the industry
- Curved tip is easy to pick up from flat surfaces and allows faster initial threading to speed installation



Part Number	Length		Width		Thickness		Max. Bundle Dia.		Min. Loop Tensile Str.		Recommended Installation Tool	Std. Pkg. Qty.	Std. Ctn. Qty.
	In.	mm	In.	mm	In.	mm	In.	mm	Lbs.	N			
<b>Miniature Cross Section</b>													
<b>PLT1M-M300</b>	3.9	99	.098	2.5	.035	.9	.87	22	18	80	GTS, GTSL, GS2B, PTS, PPTS, STS2	1000	50000
<b>Intermediate Cross Section</b>													
<b>PLT1.5I-M300</b>	5.6	142	.142	3.6	.045	1.1	1.38	35	40	178	GTS, GTSL, GS2B, PTS, PPTS, STS2	1000	25000
<b>PLT2I-M300</b>	8.0	203	.142	3.6	.045	1.1	2.00	51	40	178		1000	25000
<b>Standard Cross Section</b>													
<b>PLT1S-M300</b>	4.8	122	.190	4.8	.052	1.3	1.00	25	50	222	GTS, GTSL, GS2B, GTH, GS4H, PTS, PTH, PPTS, STS2, STH2	1000	10000
<b>PLT2S-M300</b>	7.4	188	.190	4.8	.052	1.3	1.88	48	50	222		1000	10000
<b>PLT4S-M300</b>	14.5	368	.190	4.8	.052	1.3	4.00	102	50	222		1000	5000
<b>Light-Heavy Cross Section (Straight Tip)</b>													
<b>PLT2H-TL300</b>	8.4	213	.300	7.6	.075	1.9	2.00	51	120	534	GTH, GS4H, GS4EH, PTH, STH2, ST3EH	250	2500
<b>PLT4H-TL300</b>	14.5	368	.300	7.6	.075	1.9	4.00	102	120	534		250	2500

A. System Overview

B1. Cable Ties

B2. Cable Accessories

B3. Stainless Steel Ties

C1. Wiring Duct

C2. Surface Raceway

C3. Abrasion Protection

C4. Cable Management

D1. Terminals

D2. Power Connectors

D3. Grounding Connectors

E1. Labeling Systems

E2. Labels

E3. Pre-Printed & Write-On Markers

E4. Permanent Identification

E5. Lockout/Tagout & Safety Solutions

F. Index

A. System Overview

## UL US c SP US Pan-Ty® Cable Ties – Flame Retardant Nylon 6.6

B1. Cable Ties

- Flammability rating of UL 94V-0 – indoor use
- One-piece construction for consistent performance and reliability
- Lowest threading force of any one-piece cable tie in the industry
- Curved tip is easy to pick up from flat surfaces and allows faster initial threading to speed installation

B2. Cable Accessories



B3. Stainless Steel Ties

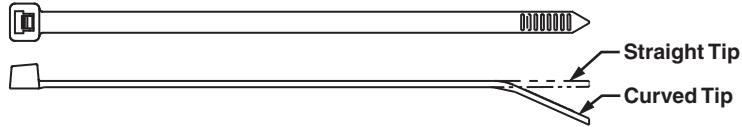

C1. Wiring Duct

Part Number	Length		Width		Thickness		Max. Bundle Dia.		Min. Loop Tensile Str.		Recommended Installation Tool	Std. Pkg. Qty.	Std. Ctn. Qty.
	In.	mm	In.	mm	In.	mm	In.	mm	Lbs.	N			

C2. Surface Raceway

### Miniature Cross Section

<b>PLT1M-M60*</b>	4.0	102	.098	2.5	.043	1.1	.87	22	18	80	GTS, GTSL, GS2B, PTS, PPTS, STS2	1000	25000
<b>PLT1M-M69</b>	4.0	102	.098	2.5	.043	1.1	.87	22	18	80		1000	25000
<b>PLT2M-M69</b>	8.0	203	.098	2.5	.043	1.1	2.00	51	18	80		1000	25000

C3. Abrasion Protection

### Intermediate Cross Section

<b>PLT1.5I-M69</b>	5.6	142	.142	3.6	.044	1.1	1.38	35	40	178	GTS, GTSL, GS2B, PTS, PPTS, STS2	1000	25000
<b>PLT2I-M69</b>	8.0	203	.142	3.6	.044	1.1	2.00	51	40	178		1000	25000

C4. Cable Management

### Standard Cross Section

<b>PLT2S-M60*</b>	7.4	188	.190	4.8	.052	1.3	1.88	48	50	222	GTS, GTSL, GS2B, GTH, GS4H, PTS, PTH, PPTS, STS2, STH2	1000	10000
<b>PLT2S-M69</b>	7.4	188	.190	4.8	.052	1.3	1.88	48	50	222		1000	10000
<b>PLT4S-M69</b>	14.5	368	.190	4.8	.052	1.3	4.00	102	50	222		1000	5000

D1. Terminals

### Light-Heavy Cross Section (Straight Tip)

<b>PLT4H-TL69</b>	14.6	371	.300	7.6	.075	1.9	4.00	102	120	534	GTH, GS4H, GS4EH, PTH, STH2, ST3EH	250	2500
-------------------	------	-----	------	-----	------	-----	------	-----	-----	-----	------------------------------------	-----	------

D2. Power Connectors

\*Black flame retardant material (60).  
Note: UL Recognized and CSA Certified except 60 material.

D3. Grounding Connectors

## Cable Tie Mounts – Flame Retardant Nylon 6.6

- Flammability rating of UL 94V-0 – indoor use
- Unique cradle design provides maximum stability for the cable bundle
- Low profile design keeps bundle close to mounting surface

E1. Labeling Systems



E2. Labels

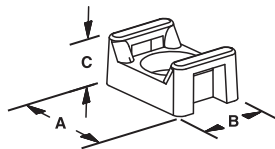

E3. Pre-Printed & Write-On Markers

Part Number	Used with Cable Ties*	Length A		Width B		Height C		Counterbore Diameter		Mounting Method	Std. Pkg. Qty.	Std. Ctn. Qty.
		In.	mm	In.	mm	In.	mm	In.	mm			
<b>TM1S4-M69</b>	M	0.51	13.0	0.32	8.0	0.23	5.8	0.23	5.7	#4 (M2.5) Screw	1000	5000
<b>TM1S6-M69</b>		0.51	13.0	0.32	8.0	0.23	5.8	0.28	7.0	#6 (M3) Screw	1000	5000
<b>TM2S6-M69</b>	M, I, S	0.63	16.0	0.43	10.8	0.28	7.0	0.29	7.1	#6 (M3) Screw	1000	5000
<b>TM2S8-M69</b>		0.63	16.0	0.43	10.8	0.28	7.0	0.33	8.4	#8 (M4) Screw	1000	5000
<b>TM3S8-C69</b>	M, I, S, LH	0.86	21.9	0.61	15.5	0.37	9.4	0.32	8.1	#8 (M4) Screw	100	500
<b>TM3S10-M69</b>		0.86	21.9	0.61	15.8	0.37	9.4	0.38	9.7	#10 (M5) Screw	1000	5000

E4. Permanent Identification

E5. Lockout/Tagout & Safety Solutions

\*Cable tie cross section sizes: M = Miniature, I = Intermediate, S = Standard and LH = Light-Heavy.

F. Index

## Pan-Ty® Cable Ties – Weather Resistant Nylon 12

- For high moisture, corrosive (zinc chloride and dilute acids), and low temperature indoor or outdoor applications
- Cable tie of choice for making attachments to galvanized surfaces
- One-piece construction for consistent performance and reliability
- Lowest threading force of any one-piece cable tie in the industry
- Curved tip is easy to pick up from flat surfaces and allows faster initial threading to speed installation

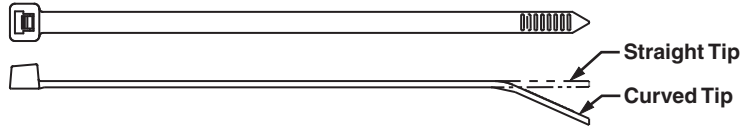

Part Number	Length		Width		Thickness		Max. Bundle Dia.		Min. Loop Tensile Str.		Recommended Installation Tool	Std. Pkg. Qty.	Std. Ctn. Qty.
	In.	mm	In.	mm	In.	mm	In.	mm	Lbs.	N			
<b>Intermediate Cross Section</b>													
<b>PLT1.5I-M120</b>	5.6	142	.142	3.6	.045	1.1	1.38	35	25	111	GTS, GTSL, GS2B, PTS, PPTS, STS2	1000	25000
<b>Standard Cross Section</b>													
<b>PLT2S-M120</b>	7.4	188	.190	4.8	.052	1.3	1.88	48	40	178	GTS, GTSL, GS2B, GTH, GS4H, PTS, PTH, PPTS, STS2, STH2	1000	10000
<b>PLT4S-M120</b>	14.5	368	.190	4.8	.052	1.3	4.00	102	40	178		1000	5000
<b>Light-Heavy Cross Section (Straight Tip)</b>													
<b>PLT4H-TL120</b>	14.5	368	.300	7.6	.075	1.9	4.00	102	90	400	GTH, GTSL, GS4H, GS4EH, PTH, STH2, ST3EH	250	2500
<b>PLT8LH-C120</b>	27.6	701	.300	7.6	.075	1.9	8.00	203	90	400		100	2000

A.  
System  
Overview

B1.  
Cable Ties

B2.  
Cable  
Accessories

B3.  
Stainless  
Steel Ties

C1.  
Wiring  
Duct

C2.  
Surface  
Raceway

C3.  
Abrasion  
Protection

C4.  
Cable  
Management

D1.  
Terminals

D2.  
Power  
Connectors

D3.  
Grounding  
Connectors

E1.  
Labeling  
Systems

E2.  
Labels

E3.  
Pre-Printed  
& Write-On  
Markers

E4.  
Permanent  
Identification

E5.  
Lockout/  
Tagout  
& Safety  
Solutions

F.  
Index

A. System Overview

## Pan-Ty® Cable Ties – Polypropylene – Distinctive Green Color

B1. Cable Ties

- For chemical resistance where high loop tensile strength is not required especially in the presence of hydrochloric acid, salts, and bases
- For indoor use
- Material requires lowering the tool setting (see table below)
- One-piece construction for consistent performance and reliability
- Lowest threading force of any one-piece cable tie in the industry
- Curved tip is easy to pick up from flat surfaces and allows faster initial threading to speed installation

B2. Cable Accessories



B3. Stainless Steel Ties

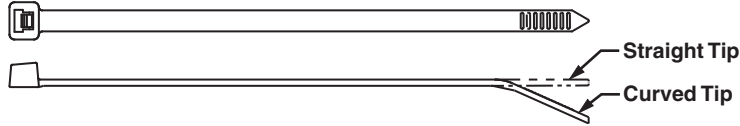

C1. Wiring Duct

C2. Surface Raceway

C3. Abrasion Protection

C4. Cable Management

D1. Terminals

D2. Power Connectors

D3. Grounding Connectors

E1. Labeling Systems

E2. Labels

E3. Pre-Printed & Write-On Markers

E4. Permanent Identification

E5. Lockout/Tagout & Safety Solutions

F. Index

Part Number	Length		Width		Thickness		Max. Bundle Dia.		Min. Loop Tensile Str.		Recommended Installation Tool	Tool Setting	Std. Pkg. Qty.	Std. Ctn. Qty.
	In.	mm	In.	mm	In.	mm	In.	mm	Lbs.	N				
<b>Miniature Cross Section</b>														
<b>PLT1M-M109</b>	3.9	99	.098	2.5	.043	1.1	.87	22	11	49	GTS, GTSL, GS2B, PTS, PPTS, STS2	2	1000	50000
<b>Intermediate Cross Section</b>														
<b>PLT1.5I-M109</b>	5.6	142	.142	3.6	.045	1.1	1.38	35	18	80	GTS, GTSL, GS2B, PTS, PPTS, STS2	3	1000	25000
<b>Standard Cross Section</b>														
<b>PLT2S-M109</b>	7.4	188	.190	4.8	.052	1.3	1.88	48	30	133	GTS, GTSL, GS2B, GTH, GS4H, PTS, PTH, PPTS, STS2, STH2	5 (GTS, GS2B, PTS, PPTS) 2 (GTH, GS4H)	1000	10000
<b>PLT3S-M109</b>	11.5	292	.190	4.8	.052	1.3	3.00	76	30	133			1000	10000
<b>PLT4S-M109</b>	14.5	368	.190	4.8	.052	1.3	4.00	102	30	133			1000	5000
<b>Light-Heavy Cross Section (Straight Tip)</b>														
<b>PLT2H-TL109</b>	8.1	206	.300	7.6	.075	1.9	2.00	51	50	222	GTH, GS4H, GS4EH, PTH, STH2, ST3EH	5	250	2500
<b>PLT3H-TL109</b>	11.4	290	.300	7.6	.075	1.9	3.00	76	50	222		5	250	2500
<b>PLT4H-TL109</b>	14.5	368	.300	7.6	.075	1.9	4.00	102	50	222		5	250	2500

## Pan-Ty® Cable Ties – Weather Resistant Polypropylene

- For chemical resistance where high loop tensile strength is not required especially in the presence of hydrochloric acid, salts, and bases
- Greater resistance to damage caused by ultraviolet light – indoor or outdoor use
- Material requires lowering the tool setting (see table below)
- One-piece construction for consistent performance and reliability
- Lowest threading force of any one-piece cable tie in the industry
- Curved tip is easy to pick up from flat surfaces and allows faster initial threading to speed installation

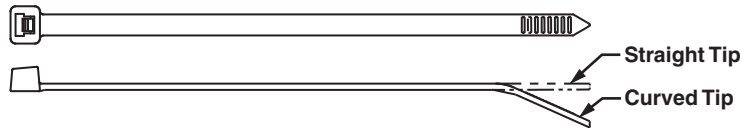

Part Number	Length		Width		Thickness		Max. Bundle Dia.		Min. Loop Tensile Str.		Recommended Installation Tool	Tool Setting	Std. Pkg. Qty.	Std. Ctn. Qty.	
	In.	mm	In.	mm	In.	mm	In.	mm	Lbs.	N					
<b>Miniature Cross Section</b>															
<b>PLT1M-M100</b>	3.9	99	.098	2.5	.043	1.1	.87	22	11	49	GTS, GTSL, GS2B, PTS, PPTS, STS2	2	1000	50000	
<b>Intermediate Cross Section</b>															
<b>PLT1.5I-M100</b>	5.6	142	.142	3.6	.045	1.1	1.38	35	18	80	GTS, GTSL, GS2B, PTS, PPTS, STS2	3	1000	25000	
<b>Standard Cross Section</b>															
<b>PLT2S-M100</b>	7.4	188	.190	4.8	.052	1.3	1.88	48	30	133	GTS, GTSL, GS2B, GTH, GS4H, PTS, PPTS, STS2, STH2	5 (GTS, GS2B, PTS, PPTS) 2 (GTH, GS4H)	1000	10000	
<b>PLT3S-M100</b>	11.5	292	.190	4.8	.052	1.3	3.00	76	30	133			1000	10000	
<b>PLT4S-M100</b>	14.5	368	.190	4.8	.052	1.3	4.00	102	30	133			1000	5000	
<b>Light-Heavy Cross Section (Straight Tip)</b>															
<b>PLT2H-TL100</b>	8.1	206	.300	7.6	.075	1.9	2.00	51	50	222	GTH, GS4H, GS4EH, PTH, STH2, ST3EH	5	250	2500	
<b>PLT3H-TL100</b>	11.4	290	.300	7.6	.075	1.9	3.00	76	50	222		5	250	2500	
<b>PLT4H-TL100</b>	14.5	368	.300	7.6	.075	1.9	4.00	102	50	222		5	250	2500	

A.  
System  
Overview

B1.  
Cable Ties

B2.  
Cable  
Accessories

B3.  
Stainless  
Steel Ties

C1.  
Wiring  
Duct

C2.  
Surface  
Raceway

C3.  
Abrasion  
Protection

C4.  
Cable  
Management

D1.  
Terminals

D2.  
Power  
Connectors

D3.  
Grounding  
Connectors

E1.  
Labeling  
Systems

E2.  
Labels

E3.  
Pre-Printed  
& Write-On  
Markers

E4.  
Permanent  
Identification

E5.  
Lockout/  
Tagout  
& Safety  
Solutions

F.  
Index

A. System Overview

**UL US LISTED cUL US LISTED cSP US** Pan-Ty® Cable Ties – HALAR® – Distinctive Maroon Color

B1. Cable Ties

- UL Listed for use in plenum or air handling spaces per NEC, Section 300-22 (C) and (D)
- Low smoke density and excellent flammability rating of UL 94V-0
- Commonly accepted solution for bundling qualified cable without conduit in air handling space applications

- Greater resistance to damage caused by ultraviolet light – indoor or outdoor use
- One-piece construction for consistent performance and reliability
- Lowest threading force of any one-piece cable tie in the industry
- Curved tip is easy to pick up from flat surfaces and allows faster initial threading to speed installation

B2. Cable Accessories

B3. Stainless Steel Ties

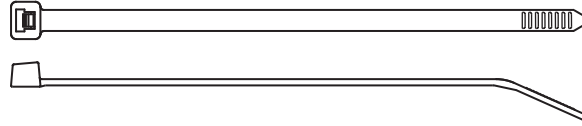

C1. Wiring Duct

C2. Surface Raceway

Part Number	Length		Width		Thickness		Max. Bundle Dia.		Min. Loop Tensile Str.		Recommended Installation Tool	Std. Pkg. Qty.	Std. Ctn. Qty.
	In.	mm	In.	mm	In.	mm	In.	mm	Lbs.	N			
<b>Miniature Cross Section – Plenum-Rated</b>													
<b>PLT1M-C702Y</b>	4.0	102	.098	2.5	.043	1.1	.87	22	18	80	GTS, GTSL, GS2B, PTS, PPTS, STS2	100	1000
<b>Standard Cross Section – Plenum-Rated</b>													
<b>PLT2S-C702Y</b>	7.4	188	.190	4.8	.055	1.4	1.88	48	50	222	GTS, GTSL, GS2B, GTH, GS4H, PTS, PTH, PPTS, STS2, STH2	100	1000
<b>PLT3S-C702Y</b>	11.6	295	.190	4.8	.055	1.4	3.00	76	50	222		100	1000

C3. Abrasion Protection

C4. Cable Management

D1. Terminals

\*HALAR is a registered trademark of Ausimont USA, Inc.

D2. Power Connectors

D3. Grounding Connectors

E1. Labeling Systems

E2. Labels

E3. Pre-Printed & Write-On Markers

E4. Permanent Identification

E5. Lockout/Tagout & Safety Solutions

F. Index





## Pan-Ty® Cable Ties – TEFZEL® – Distinctive Aqua Blue Color

- Ideal for applications requiring resistance to environmental stresses such as chemical attack, gamma radiation, ultraviolet radiation and extreme high and low temperatures
- Ideal for use in nuclear power facilities and chemical processing plants and meets the requirements of IEEE 383
- Low smoke density and excellent flammability rating of UL 94V-0

- One-piece construction for consistent performance and reliability
- Lowest threading force of any one-piece cable tie in the industry
- Curved tip is easy to pick up from flat surfaces and allows faster initial threading to speed installation
- For indoor or outdoor use

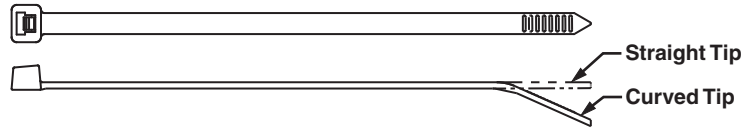
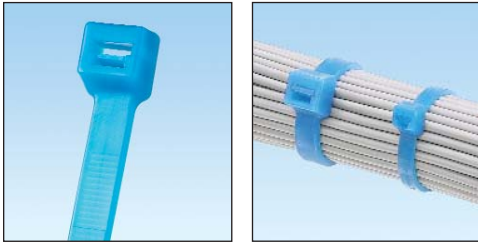

Part Number	Length		Width		Thickness		Max. Bundle Dia.		Min. Loop Tensile Str.		Recommended Installation Tool	Std. Pkg. Qty.	Std. Ctn. Qty.
	In.	mm	In.	mm	In.	mm	In.	mm	Lbs.	N			
<b>Miniature Cross Section</b>													
<b>PLT1M-C76</b>	4.0	102	.098	2.5	.043	1.1	.87	22	18	80	GTS, GTSL, GS2B, PTS, PPTS, STS2	100	1000
<b>Intermediate Cross Section</b>													
<b>PLT2I-C76</b>	8.0	203	.135	3.4	.045	1.1	2.00	51	25	111	GTS, GTSL, GS2B, PTS, PPTS, STS2	100	1000
<b>Standard Cross Section</b>													
<b>PLT2S-C76</b>	7.4	188	.190	4.8	.055	1.4	1.88	48	50	222	GTS, GTSL, GS2B, GTH, GS4H, PTH, PPTS, STS2, STH2	100	1000
<b>PLT3S-C76</b>	11.6	295	.190	4.8	.059	1.5	3.00	76	50	222		100	1000
<b>PLT4S-C76</b>	14.6	371	.190	4.8	.059	1.5	4.00	102	50	222		100	1000
<b>Light-Heavy Cross Section (Straight Tip)</b>													
<b>PLT3H-L76</b>	11.5	292	.300	7.6	.075	1.9	3.00	78	120	534	GTH, GS4H, GS4EH, PTH, STH2, ST3EH	50	500
<b>PLT4H-L76</b>	14.6	371	.300	7.6	.075	1.9	4.00	102	120	534		50	500

\*TEFZEL is a registered trademark of E. I. du Pont de Nemours and Company.

## Panduit Cable Tie Mounts – TEFZEL®

- Flammability rating of UL 94V-0 – indoor use
- Unique cradle design provides maximum stability for the cable bundle

- Low profile design keeps bundle close to mounting surface

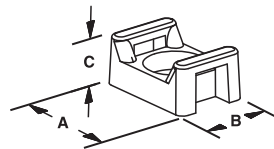

Part Number	Used with Cable Ties*	Length A		Width B		Height C		Counterbore Diameter		Mounting Method	Std. Pkg. Qty.	Std. Ctn. Qty.
		In.	mm	In.	mm	In.	mm	In.	mm			
<b>TM2S8-C76</b>	M, I, S	.63	16.0	.43	10.8	.28	7.0	.30	7.6	#8 (M4) screw	100	500
<b>TM3S8-C76</b>	S, LH	.86	21.7	.62	15.5	.38	9.5	.37	9.4	#8 (M4) screw	100	500
<b>TM3S10-C76</b>		.86	21.7	.62	15.8	.38	9.5	.37	9.4	#10 (M5) screw	100	500

\*Cable tie cross section sizes: M = Miniature, I = Intermediate, S = Standard, LH = Light-Heavy.

\*TEFZEL is a registered trademark of E. I. du Pont de Nemours and Company.

A. System Overview

## Pan-Ty® Cable Ties – PEEK (Polyetheretherketone)

B1. Cable Ties

- Ideal for harsh environments where a cable tie material is required to hold up to chemical or radiation exposure
- Non-conductive material that is excellent for high temperature applications up to 500°F (260°C)
- High strength properties over a wide range of temperatures
- Flammability rating of UL 94V-0 with low smoke and toxicity; halogen-free
- PEEK material meets MIL specification MIL-P-46183, and is approved for use by the Department of Defense
- One-piece construction for consistent performance and reliability
- Lowest threading force of any one-piece cable tie in the industry

B2. Cable Accessories

B3. Stainless Steel Ties

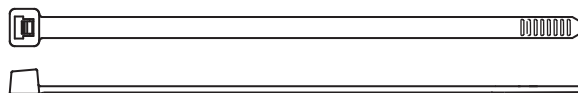

C1. Wiring Duct

C2. Surface Raceway

Part Number	Length		Width		Thickness		Max. Bundle Dia.		Min. Loop Tensile Str.		Recommended Installation Tool	Std. Pkg. Qty.	Std. Ctn. Qty.
	In.	mm	In.	mm	In.	mm	In.	mm	Lbs.	N			

C3. Abrasion Protection

### Miniature Cross Section

PLT1M-C71	3.9	99	0.098	2.5	0.048	1.2	0.87	22	35	156	GTS, GTSL, PTS	100	1000
PLT1.5M-C71	5.8	147	0.098	2.5	0.048	1.2	1.38	35	35	156	GTS, GTSL, PTS	100	1000

C4. Cable Management

### Standard Cross Section

PLT2S-C71	7.4	188	0.190	4.8	0.055	1.4	1.88	48	150	668	GTS, GTSL, GS2B, GTH, GS4H, PTS, PTH, PPTS, STS2, STH2	100	1000
-----------	-----	-----	-------	-----	-------	-----	------	----	-----	-----	--	-----	------

D1. Terminals

D2. Power Connectors

D3. Grounding Connectors

## Cable Tie Mounts – (Polyetheretherketone)

- Unique cradle design provides maximum stability for cable bundle
- Low profile design keeps bundle close to mounting surface where overhead space is limited

E1. Labeling Systems

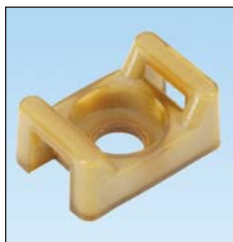

E2. Labels

E3. Pre-Printed & Write-On Markers

E4. Permanent Identification

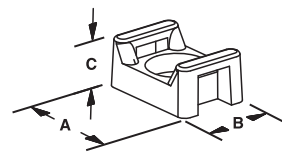

E5. Lockout/Tagout & Safety Solutions

Part Number	Used with Cable Ties	A Length In. (mm)	B Width In. (mm)	C Height In. (mm)	Counterbore Diameter In. (mm)	Mounting Method	Std. Pkg. Qty.	Std. Ctn. Qty.
TM2S8-C71	Min., Std.	.636 (16.2)	.427 (10.8)	.278 (7.1)	.335 (8.5)	#8 (M4) screw	100	500

F. Index

## Pan-Ty® Cable Ties – Metal Detectable Nylon 6.6 and Polypropylene

- Metal impregnated material allows identification by metal detectors or x-ray inspection equipment to help meet food, beverage, and pharmaceutical safety standards, to help reduce product contamination, loss, and recall
- Nylon material for general purpose maintenance and repair applications; ideal for use in control panels and overhead cable runs
- Polypropylene material provides excellent chemical resistance for use in processing and packaging areas where aggressive acid and alkaline chemicals are used to clean the equipment
- One-piece construction for consistent performance and reliability
- Lowest threading force of any one-piece cable tie in the industry
- Curved tip is easy to pick up from flat surfaces and allows faster initial threading to speed installation

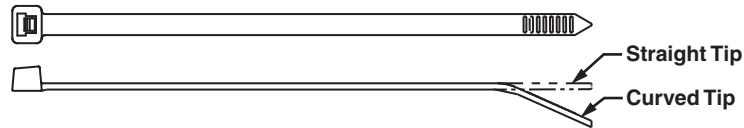

Part Number	Length		Width		Thickness		Max. Bundle Dia.		Min. Loop Tensile Str.		Recommended Installation Tool	Material	Std. Pkg. Qty.	Std. Ctn. Qty.
	In.	mm	In.	mm	In.	mm	In.	mm	Lbs.	N				

### Nylon 6.6

#### Miniature Cross Section

PLT1M-C86	3.9	100	.098	2.5	.044	1.1	.87	22	18	80	GTS, GTSL, GS2B, STS2	Nylon 6.6	100	1000
-----------	-----	-----	------	-----	------	-----	-----	----	----	----	-----------------------	-----------	-----	------

#### Intermediate Cross Section

PLT2I-C86	8.0	203	.135	3.4	.047	1.2	2.00	51	40	178	GTS, GTSL, GS2B, STS2	Nylon 6.6	100	1000
-----------	-----	-----	------	-----	------	-----	------	----	----	-----	-----------------------	-----------	-----	------

#### Standard Cross Section

PLT2S-C86	7.3	186	.190	4.8	.057	1.4	1.85	47	50	222	GTS, GTSL, GS2B, GTH, GS4H, STS2, STH2	Nylon 6.6	100	1000
PLT3S-C86	11.5	291	.190	4.8	.057	1.4	3.00	76	50	222		Nylon 6.6	100	1000
PLT4S-C86	14.4	366	.190	4.8	.057	1.4	4.00	102	50	222		Nylon 6.6	100	1000

#### Light-Heavy Cross Section (Straight Tip)

PLT3H-L86	11.1	282	.300	7.6	.075	1.9	3.00	76	120	120	GTH, GS4H, GS4EH, STH2, ST3EH	Nylon 6.6	50	500
PLT4H-L86	14.4	366	.300	7.6	.075	1.9	4.00	102	120	120		Nylon 6.6	50	500

### Polypropylene

#### Miniature Cross Section

**NEW!**

PLT1M-C186	3.9	100	0.098	2.5	0.044	1.1	0.87	22	15	67	GTS, GTSL, GS2B, STS2	Polypropylene	100	1000
------------	-----	-----	-------	-----	-------	-----	------	----	----	----	-----------------------	---------------	-----	------

#### Intermediate Cross Section

PLT2I-C186	8.0	203	.135	3.4	.047	1.2	2.00	51	24	107	GTS, GTSL, GS2B, STS2	Polypropylene	100	1000
------------	-----	-----	------	-----	------	-----	------	----	----	-----	-----------------------	---------------	-----	------

#### Standard Cross Section

PLT2S-C186	7.3	186	.190	4.8	.057	1.4	1.85	47	30	133	GTS, GTSL, GS2B, GTH, GS4H, STS2, STH2	Polypropylene	100	1000
PLT3S-C186	11.5	291	.190	4.8	.057	1.4	3.00	76	30	133		Polypropylene	100	1000
PLT4S-C186	14.4	366	.190	4.8	.057	1.4	4.00	102	30	133		Polypropylene	100	1000

#### Light-Heavy Cross Section (Straight Tip)

PLT3H-L186	11.1	282	.300	7.6	.075	1.9	3.00	76	60	267	GTH, GS4H, GS4EH, STH2, ST3EH	Polypropylene	50	500
PLT4H-L186	14.4	366	.300	7.6	.075	1.9	4.00	102	60	267		Polypropylene	50	500

Part Number	Material	Used with Cable Ties	A Length In. (mm)	B Width In. (mm)	C Height In. (mm)	Counterbore Diameter In. (mm)	Mounting Method	Std. Pkg. Qty.	Std. Ctn. Qty.
-------------	----------	----------------------	-------------------	------------------	-------------------	-------------------------------	-----------------	----------------	----------------

**NEW!**

#### Cable Tie Mounts

TM2S8-C86	Nylon 6.6	Min., Int., Std.	.630 (16.0)	.422 (10.7)	.275 (7.0)	.325 (8.3)	#8 (M4) screw	100	500
TM3S8-C86		Std., Lt. Hvy.	.867 (22.0)	.614 (15.6)	.373 (9.5)	.325 (8.3)	#8 (M4) screw	100	500
TM3S10-C86							#10 (M5) screw	100	500
TM2S8-C186	Polypropylene	Min., Int., Std.	.630 (16.0)	.422 (10.7)	.275 (7.0)	.325 (8.3)	#8 (M4) screw	100	500
TM3S8-C186		Std., Lt. Hvy.	.867 (22.0)	.614 (15.6)	.373 (9.5)	.325 (8.3)	#8 (M4) screw	100	500
TM3S10-C186							#10 (M5) screw	100	500

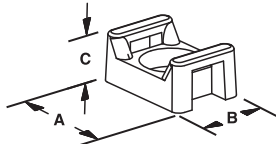

A. System Overview



## Pan-Ty® Releasable Cable Ties – Nylon 6.6

B1. Cable Ties

- For indoor use
- Extended release tab permits easy release and re-use where changes are anticipated during development, production, or servicing in the field

- One-piece construction for consistent performance and reliability
- Curved tip is easy to pick up from flat surfaces and allows faster initial threading to speed installation
- UL Listed for use in plenum or air handling spaces per NEC except PR2H/3H/4H

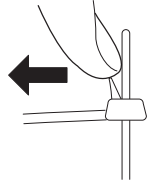

To release, grasp the head of the cable tie, deflect release tab, and pull the cable tie away from the bundle.

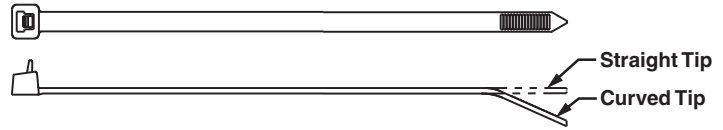

C1. Wiring Duct

C2. Surface Raceway

Part Number	Length		Width		Thickness		Max. Bundle Dia.		Min. Loop Tensile Str.		Recommended Installation Tool	Std. Pkg. Qty.	Std. Ctn. Qty.
	In.	mm	In.	mm	In.	mm	In.	mm	Lbs.	N			
<b>Standard Cross Section – Plenum-Rated</b>													
<b>PRT1S-C</b>	4.8	122	.190	4.8	.052	1.3	1.00	25	50	222	Hand install only	100	1000
<b>PRT1.5S-C</b>	6.3	160	.190	4.8	.052	1.3	1.50	38	50	222		100	1000
<b>PRT2S-C</b>	7.4	188	.190	4.8	.052	1.3	1.88	48	50	222		100	1000
<b>PRT3S-C</b>	11.5	292	.190	4.8	.052	1.3	3.00	76	50	222		100	1000
<b>PRT4S-C</b>	14.5	368	.190	4.8	.052	1.3	4.00	102	50	222		100	1000
<b>Light-Heavy Cross Section (Straight Tip)</b>													
<b>PRT2H-L</b>	8.4	213	.300	7.6	.075	1.9	2.00	51	80	356	Hand install only	50	500
<b>PRT3H-L</b>	11.4	290	.300	7.6	.075	1.9	3.00	76	80	356		50	500
<b>PRT4H-L</b>	14.5	368	.300	7.6	.075	1.9	4.00	102	80	356		50	500

C3. Abrasion Protection

C4. Cable Management

D1. Terminals

D2. Power Connectors

D3. Grounding Connectors

E1. Labeling Systems

E2. Labels

E3. Pre-Printed & Write-On Markers

E4. Permanent Identification

E5. Lockout/Tagout & Safety Solutions

F. Index

## Pan-Ty® Releasable Lashing Ties – Nylon 6.6

- For indoor use
- Release tab permits easy release and re-use where changes are anticipated during development, production, or servicing in the field
- Typically used for heavy duty applications
- Strongest Pan-Ty® Cable Tie available
- Can be used with MCEH mounting clip, see page B1.24

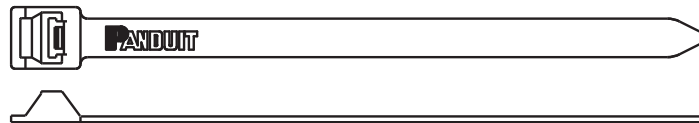

Part Number	Length		Width		Thickness		Max. Bundle Dia.		Min. Loop Tensile Str.		Recommended Installation Tool	Std. Pkg. Qty.	Std. Ctn. Qty.
	In.	mm	In.	mm	In.	mm	In.	mm	Lbs.	N			
<b>Extra-Heavy Cross Section</b>													
<b>PRT2EH-C</b>	9.0	229	.500	12.7	.075	1.9	2.00	51	250	1112	Hand install only	100	1000
<b>PRT5EH-Q</b>	20.1	511	.500	12.7	.075	1.9	5.00	127	250	1112		25	250
<b>PRT6EH-Q</b>	22.2	564	.500	12.7	.075	1.9	6.00	152	250	1112		25	250
<b>PRT8EH-C</b>	28.3	719	.500	12.7	.085	2.2	8.00	203	250	1112		100	1000
<b>PRT10EH-C</b>	34.2	869	.500	12.7	.085	2.2	10.00	254	250	1112		100	500
<b>PRT12EH-C</b>	40.1	1019	.500	12.7	.085	2.2	12.00	305	250	1112		100	500



## Pan-Ty® Releasable Cable Ties – Weather Resistant and Heat Stabilized Nylon 6.6

- Weather resistant material has greater resistance to damage caused by ultraviolet light – indoor or outdoor use
- Heat stabilized material for high temperature applications up to 239°F (115°C) – indoor use

- Extended release tab permits easy release and re-use where changes are anticipated during development, production, or servicing in the field
- One-piece construction for consistent performance and reliability
- Curved tip is easy to pick up from flat surfaces and allows faster initial threading to speed installation

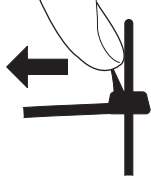

To release, grasp the head of the cable tie, deflect release tab, and pull the cable tie away from the bundle.

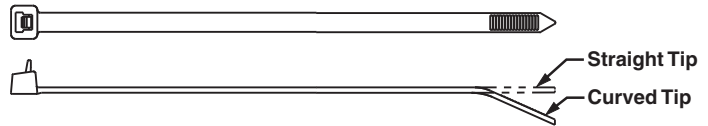

Part Number	Length		Width		Thickness		Max. Bundle Dia.		Min. Loop Tensile Str.		Recommended Installation Tool	Std. Pkg. Qty.	Std. Ctn. Qty.
	In.	mm	In.	mm	In.	mm	In.	mm	Lbs.	N			

### Weather Resistant Nylon 6.6

#### Standard Cross Section

PRT1S-C0	4.8	122	.190	4.8	.052	1.3	1.00	25	50	222	Hand install only	100	1000
PRT1.5S-C0	6.3	160	.190	4.8	.052	1.3	1.50	38	50	222		100	1000
PRT2S-C0	7.4	188	.190	4.8	.052	1.3	1.88	48	50	222		100	1000
PRT3S-C0	11.5	292	.190	4.8	.052	1.3	3.00	76	50	222		100	1000
PRT4S-C0	14.5	368	.190	4.8	.052	1.3	4.00	102	50	222		100	1000

#### Light-Heavy Cross Section (Straight Tip)

PRT2H-L0	8.4	213	.300	7.6	.075	1.9	2.00	51	80	356	Hand install only	50	500
PRT3H-L0	11.4	290	.300	7.6	.075	1.9	3.00	76	80	356		50	500
PRT4H-L0	14.5	368	.300	7.6	.075	1.9	4.00	102	80	356		50	500

### Heat Stabilized Nylon 6.6

#### Standard Cross Section

PRT1.5S-M30	6.3	160	.190	4.8	.052	1.3	1.50	38	50	222	Hand install only	1000	10000
-------------	-----	-----	------	-----	------	-----	------	----	----	-----	-------------------	------	-------

Note: UL Listed, UL Recognized, and CSA Certified, except PRT2H/3H/4H.

A. System Overview

B1. Cable Ties

B2. Cable Accessories

B3. Stainless Steel Ties

C1. Wiring Duct

C2. Surface Raceway

C3. Abrasion Protection

C4. Cable Management

D1. Terminals

D2. Power Connectors

D3. Grounding Connectors

E1. Labeling Systems

E2. Labels

E3. Pre-Printed & Write-On Markers

E4. Permanent Identification

E5. Lockout/Tagout & Safety Solutions

F. Index

A. System Overview

## Pan-Ty® Releasable Lashing Ties – Weather Resistant and Heat Stabilized Nylon 6.6

B1. Cable Ties

- Weather resistant material has greater resistance to damage caused by ultraviolet light – indoor or outdoor use
- Heat stabilized material for high temperature applications up to 239°F (115°C) – indoor use
- Release tab permits easy release and re-use where changes are anticipated during development, production, or servicing in the field
- Typically used for heavy duty applications
- Strongest Pan-Ty® Cable Tie available
- Can be used with MCEH mounting clip shown below

B2. Cable Accessories

B3. Stainless Steel Ties



C1. Wiring Duct

C2. Surface Raceway

Part Number	Length		Width		Thickness		Max. Bundle Dia.		Min. Loop Tensile Str.		Recommended Installation Tool	Std. Pkg. Qty.	Std. Ctn. Qty.
	In.	mm	In.	mm	In.	mm	In.	mm	Lbs.	N			

C3. Abrasion Protection

### Weather Resistant Nylon 6.6

#### Extra-Heavy Cross Section

<b>PRT2EH-Q0</b>	9.0	229	0.500	12.7	0.075	1.9	2.00	51	250	1112	Hand install only	25	250
<b>PRT5EH-Q0</b>	20.1	511	0.500	12.7	0.075	1.9	5.00	127	250	1112		25	250
<b>PRT6EH-Q0</b>	22.2	564	0.500	12.7	0.075	1.9	6.00	152	250	1112		25	250
<b>PRT8EH-Q0</b>	28.3	719	0.500	12.7	0.085	2.2	8.00	203	250	1112		25	250
<b>PRT10EH-Q0</b>	34.2	869	0.500	12.7	0.085	2.2	10.00	254	250	1112		25	250
<b>PRT12EH-Q0</b>	40.1	1019	0.500	12.7	0.085	2.2	12.00	305	250	1112		25	250

C4. Cable Management

D1. Terminals

### Heat Stabilized Nylon 6.6

#### Extra-Heavy Cross Section

<b>PRT5EH-C30</b>	20.1	511	0.500	12.7	0.075	1.9	5.00	127	250	1112	Hand install only	100	1000
-------------------	------	-----	-------	------	-------	-----	------	-----	-----	------	-------------------	-----	------

D2. Power Connectors

D3. Grounding Connectors

## Lashing Tie Mounting Clip – Weather Resistant Nylon 6.6

E1. Labeling Systems

- Greater resistance to damage caused by ultraviolet light – indoor or outdoor use
- Converts Panduit lashing ties into clamps
- Easily snaps in place for a secure clamp
- Use with lashing ties shown on pages B1.9, B1.11, B1.22, B1.24 and B1.25

E2. Labels



E3. Pre-Printed & Write-On Markers

E4. Permanent Identification

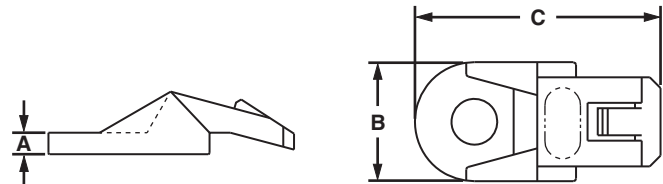

E5. Lockout/Tagout & Safety Solutions

Part Number	Height A		Width B		Length C		Mounting Method	Std. Pkg. Qty.	Std. Ctn. Qty.
	In.	mm	In.	mm	In.	mm			
<b>MCEH-S25-C0</b>	.13	3.3	.67	17.0	1.38	35	1/4" (M6) screw (not flathead)	100	1000

F. Index

## Pan-Ty® Releasable Lashing Ties – Weather Resistant Polypropylene

- For chemical resistance where high loop tensile strength is not required especially in the presence of hydrochloric acid, salts, and bases
- Greater resistance to damage caused by ultraviolet light – indoor or outdoor use
- Release tab permits easy release and re-use where changes are anticipated during development, production, or servicing in the field
- Typically used for heavy duty applications
- Can be used with MCEH mounting clip, see page B1.24



Part Number	Length		Width		Thickness		Max. Bundle Dia.		Min. Loop Tensile Str.		Recommended Installation Tool	Std. Pkg. Qty.	Std. Ctn. Qty.
	In.	mm	In.	mm	In.	mm	In.	mm	Lbs.	N			
<b>Extra-Heavy Cross Section</b>													
<b>PRT2EH-C100</b>	9.0	229	.500	12.7	.075	1.9	2.00	51	90	400	Hand install only	100	1000
<b>PRT5EH-C100</b>	20.1	511	.500	12.7	.075	1.9	5.00	127	90	400		100	1000
<b>PRT6EH-C100</b>	22.2	564	.500	12.7	.075	1.9	6.00	152	90	400		100	1000
<b>PRT8EH-C100</b>	28.3	719	.500	12.7	.085	2.2	8.00	203	90	400		100	1000

A.  
System  
Overview

B1.  
Cable Ties

B2.  
Cable  
Accessories

B3.  
Stainless  
Steel Ties

C1.  
Wiring  
Duct

C2.  
Surface  
Raceway

C3.  
Abrasion  
Protection

C4.  
Cable  
Management

D1.  
Terminals

D2.  
Power  
Connectors

D3.  
Grounding  
Connectors

E1.  
Labeling  
Systems

E2.  
Labels

E3.  
Pre-Printed  
& Write-On  
Markers

E4.  
Permanent  
Identification

E5.  
Lockout/  
Tagout  
& Safety  
Solutions

F.  
Index

A. System Overview

**UL** **UL** **SP** **Pan-Ty® Clamp Ties – Nylon 6.6**

B1. Cable Ties

- For indoor use
- Used to secure a cable bundle to another surface such as a control panel, communication rack, wall or ceiling
- Design allows for bundling before or after screwing clamp in place

- One-piece construction for consistent performance and reliability
- Curved tip is easy to pick up from flat surfaces and allows faster initial threading to speed installation
- UL Listed for use in plenum or air handling spaces per NEC

B2. Cable Accessories

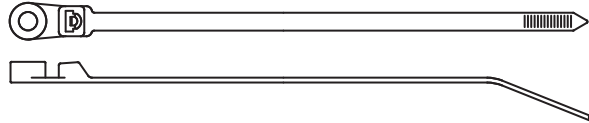

B3. Stainless Steel Ties

C1. Wiring Duct



C2. Surface Raceway

Part Number	Length		Width		Thickness		Nominal Hole Dia.		Screw Size	Metric Screw Size	Max. Bundle Dia.		Min. Loop Tensile Str.		Recommended Installation Tool	Std. Pkg. Qty.	Std. Ctn. Qty.
	In.	mm	In.	mm	In.	mm	In.	mm			In.	mm	Lbs.	N			

**Miniature Cross Section – Plenum-Rated**

<b>PLC1M-S4-C</b>	4.3	109	.100	2.5	.045	1.1	.122	3.1	#4	M2.5	.75	19	18	80	GTS, GTSL, GS2B, PTS, PPTS, STS2	100	1000
-------------------	-----	-----	------	-----	------	-----	------	-----	----	------	-----	----	----	----	----------------------------------	-----	------

**Intermediate Cross Section – Plenum-Rated**

<b>PLC1.5I-S8-C</b>	6.1	155	.135	3.4	.045	1.1	.174	4.4	#8	M4	1.25	32	40	178	GTS, GTSL, GS2B, PTS, PPTS, STS2	100	1000
---------------------	-----	-----	------	-----	------	-----	------	-----	----	----	------	----	----	-----	----------------------------------	-----	------

**Standard Cross Section – Plenum-Rated**

<b>PLC2S-S6-C</b>	7.9	201	.190	4.8	.047	1.2	.148	3.8	#6	M3	1.84	47	50	222	GTS, GTSL, GS2B, GTH, GS4H, PTS, PTH, PPTS, STS2, STH2	100	1000
<b>PLC2S-S10-C</b>	7.9	201	.190	4.8	.047	1.2	.200	5.1	#10	M5	1.84	47	50	222		100	1000
<b>PLC3S-S10-C</b>	12.0	305	.190	4.8	.047	1.2	.200	5.1	#10	M5	3.00	76	50	222		100	1000
<b>PLC4S-S10-C</b>	15.0	381	.190	4.8	.052	1.3	.200	5.1	#10	M5	4.00	102	50	222		100	1000

**Light-Heavy Cross Section – Plenum-Rated**

<b>PLC2H-S25-L</b>	9.0	229	.300	7.6	.075	1.9	.260	6.6	1/4	M6	2.00	51	120	534	GTH, GS4H, GS4EH, PTH, STH2, ST3EH	50	500
<b>PLC4H-S25-L</b>	15.1	384	.300	7.6	.075	1.9	.260	6.6	1/4	M6	4.00	102	120	534		50	500

D1. Terminals

D2. Power Connectors

D3. Grounding Connectors

E1. Labeling Systems

E2. Labels

E3. Pre-Printed & Write-On Markers

E4. Permanent Identification

E5. Lockout/Tagout & Safety Solutions

F. Index



## UL<sup>®</sup> US<sup>®</sup> CS<sup>®</sup> Pan-Ty<sup>®</sup> Clamp Ties – Weather Resistant and Heat Stabilized Nylon 6.6

- Weather resistant material has greater resistance to damage caused by ultraviolet light – indoor or outdoor use
- Heat stabilized material for high temperature applications up to 239°F (115°C) – indoor use
- Used to secure a cable bundle to another surface such as a control panel, communication rack, wall or ceiling

- Design allows for bundling before or after screwing clamp in place
- One-piece construction for consistent performance and reliability
- Curved tip is easy to pick up from flat surfaces and allows faster initial threading to speed installation



Part Number	Length		Width		Thickness		Nominal Hole Dia.		Screw Size	Metric Screw Size	Max. Bundle Dia.		Min. Loop Tensile Str.		Recommended Installation Tool	Std. Pkg. Qty.	Std. Ctn. Qty.
	In.	mm	In.	mm	In.	mm	In.	mm			In.	mm	Lbs.	N			

### Weather Resistant Nylon 6.6

#### Miniature Cross Section

PLC1M-S4-C0	4.3	109	.100	2.5	.045	1.1	.122	3.1	#4	M2.5	.75	19	18	80	GTS, GTSL, GS2B, PTS, PPTS, STS2	100	1000
-------------	-----	-----	------	-----	------	-----	------	-----	----	------	-----	----	----	----	----------------------------------	-----	------

#### Intermediate Cross Section

PLC1.5I-S8-C0	6.1	155	.135	3.4	.045	1.1	.174	4.4	#8	M4	1.25	32	40	178	GTS, GTSL, GS2B, PTS, PPTS, STS2	100	1000
---------------	-----	-----	------	-----	------	-----	------	-----	----	----	------	----	----	-----	----------------------------------	-----	------

#### Standard Cross Section

PLC2S-S6-C0	7.9	201	.190	4.8	.047	1.2	.148	3.8	#6	M3	1.84	47	50	222	GTS, GTSL, GS2B, GTH, GS4H, PTS, PTH, PPTS, STS2, STH2	100	1000
PLC2S-S10-C0	7.9	201	.190	4.8	.047	1.2	.200	5.1	#10	M5	1.84	47	50	222		100	1000
PLC3S-S10-C0	12.0	305	.190	4.8	.052	1.3	.200	5.1	#10	M5	3.00	76	50	222		100	1000
PLC4S-S10-C0	15.0	381	.190	4.8	.052	1.3	.200	5.1	#10	M5	4.00	102	50	222		100	1000

#### Light-Heavy Cross Section

PLC2H-S25-TL0	9.0	229	.300	7.6	.075	1.9	.260	6.6	1/4	M6	2.00	51	120	534	GTH, GS4H, GS4EH, PTH, STH2, ST3EH	250	2500
PLC4H-S25-L0	15.1	384	.300	7.6	.075	1.9	.260	6.6	1/4	M6	4.00	102	120	534		50	500

### Heat Stabilized Nylon 6.6

#### Miniature Cross Section

PLC1M-S4-M30	4.3	109	.100	2.5	.045	1.1	.122	3.1	#4	M2.5	.75	19	18	80	GTS, GTSL, GS2B, PTS, PPTS, STS2	1000	50000
--------------	-----	-----	------	-----	------	-----	------	-----	----	------	-----	----	----	----	----------------------------------	------	-------

#### Intermediate Cross Section

PLC1.5I-S8-M30	6.1	155	.135	3.4	.045	1.1	.174	4.4	#8	M4	1.25	32	40	178	GTS, GTSL, GS2B, PTS, PPTS, STS2	1000	25000
----------------	-----	-----	------	-----	------	-----	------	-----	----	----	------	----	----	-----	----------------------------------	------	-------

#### Standard Cross Section

PLC2S-S10-M30	7.9	201	.190	4.8	.047	1.2	.200	5.1	#10	M5	1.84	47	50	222	GTS, GTSL, GS2B, GTH, GS4H, PTS, PTH, PPTS, STS2, STH2	1000	10000
PLC4S-S10-M30	15.0	381	.190	4.8	.052	1.3	.200	5.1	#10	M5	4.00	102	50	222		1000	5000

#### Light-Heavy Cross Section

PLC2H-S25-TL30	9.0	229	.300	7.6	.075	1.9	.260	6.6	1/4	M6	2.00	51	120	534	GTH, GS4H, GS4EH, PTH, STH2, ST3EH	250	2500
PLC4H-S25-TL30	15.1	384	.300	7.6	.075	1.9	.260	6.6	1/4	M6	4.00	102	120	534		250	2500

Note: UL Recognized and CSA Certified except PLC2H/4H in Weather Resistant material (0).

A.  
System  
Overview

B1.  
Cable Ties

B2.  
Cable  
Accessories

B3.  
Stainless  
Steel Ties

C1.  
Wiring  
Duct

C2.  
Surface  
Raceway

C3.  
Abrasion  
Protection

C4.  
Cable  
Management

D1.  
Terminals

D2.  
Power  
Connectors

D3.  
Grounding  
Connectors

E1.  
Labeling  
Systems

E2.  
Labels

E3.  
Pre-Printed  
& Write-On  
Markers

E4.  
Permanent  
Identification

E5.  
Lockout/  
Tagout  
& Safety  
Solutions

F.  
Index

A. System Overview

## UL<sup>®</sup> CS<sup>®</sup> Pan-Ty<sup>®</sup> Wing Push Mount Ties – Nylon 6.6

B1. Cable Ties

- For indoor use
- Cable tie, mount, and fastener in a single part
- Used to attach bundles to another surface such as a flat panel
- Anchor is easily pressed into a pre-formed hole and locks in place

- Wings provide constant tension for a stable, secure, and rattle-free installation
- Curved tip is easy to pick up from flat surfaces and allows faster initial threading to speed installation

B2. Cable Accessories



B3. Stainless Steel Ties

C1. Wiring Duct

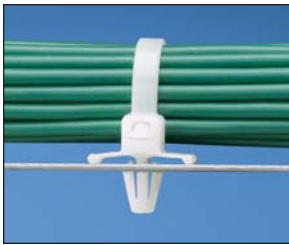

C2. Surface Raceway

C3. Abrasion Protection

C4. Cable Management

D1. Terminals

D2. Power Connectors

D3. Grounding Connectors

E1. Labeling Systems

E2. Labels

E3. Pre-Printed & Write-On Markers

E4. Permanent Identification

E5. Lockout/Tagout & Safety Solutions

F. Index

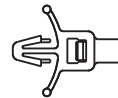
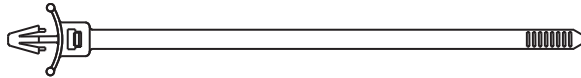

**PLWP\_SA Head Design**



**PLWP\_SB Head Design**

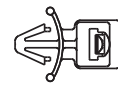
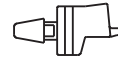

**PLWP\_H Head Design**



Part Number	Length		Width		Thickness		Nominal Hole Dia.		Max. Panel Thickness		Max. Bundle Dia.		Min. Loop Tensile Str.		Recommended Installation Tool	Std. Pkg. Qty.	Std. Ctn. Qty.
	In.	mm	In.	mm	In.	mm	In.	mm	In.	mm	In.	mm	Lbs.	N			
<b>Miniature Cross Section</b>																	
<b>PLWP1M-C</b>	4.3	109	.098	2.5	.044	1.1	.187	4.7	.093	2.4	.87	22	18	80	GTS, GTSL, GS2B, PTS, PPTS, STS2	100	1000
<b>Intermediate Cross Section</b>																	
<b>PLWP1.5I-C</b>	6.0	152	.135	3.4	.045	1.2	.187	4.7	.093	2.4	1.25	32	40	178	GTS, GTSL, GS2B, PTS, PPTS, STS2	100	1000
<b>Standard Cross Section</b>																	
<b>PLWP1S-C</b>	5.2	132	.190	4.8	.052	1.3	.250	6.4	.105	2.7	1.00	25	50	222	GTS, GTSL, GS2B, GTH, GS4H, PTS, PTH, PPTS, STS2, STH2	100	1000
<b>PLWP1SA-D</b>	5.1	130	.190	4.8	.052	1.3	.187	4.7	.093	2.4	1.00	25	50	222		500	5000
<b>PLWP1SB-D</b>	5.2	132	.190	4.8	.052	1.3	.187	4.7	.157	4.0	1.00	25	50	222		500	5000
<b>PLWP1.5S-D</b>	6.8	173	.190	4.8	.052	1.3	.250	6.4	.105	2.7	1.50	38	50	222		500	5000
<b>PLWP1.5SA-D</b>	6.7	170	.190	4.8	.052	1.3	.187	4.7	.093	2.4	1.50	38	50	222		500	5000
<b>PLWP2S-C</b>	7.8	198	.190	4.8	.052	1.3	.250	6.4	.105	2.7	1.75	45	50	222		100	1000
<b>PLWP2SA-D</b>	7.7	196	.190	4.8	.052	1.3	.187	4.7	.093	2.4	1.75	45	50	222		500	5000
<b>PLWP2SB-D</b>	7.8	198	.190	4.8	.052	1.3	.187	4.7	.157	4.0	1.75	45	50	222		500	5000
<b>Light-Heavy Cross Section</b>																	
<b>PLWP2H-TL</b>	8.9	226	.300	7.6	.075	1.9	.266	6.8	.105	2.7	2.00	51	120	534	GTH, GS4H, GS4EH, PTH, STH2, ST3EH	250	2500
<b>PLWP3H-TL</b>	12.0	305	.300	7.6	.075	1.9	.266	6.8	.105	2.7	3.00	76	120	534		250	2500

Note: UL Recognized and CSA Certified except PLWP2H/3H.



## Pan-Ty® Wing Push Mount Ties – Weather Resistant and Heat Stabilized Nylon 6.6

- Weather resistant material has greater resistance to damage caused by ultraviolet light – indoor or outdoor use
- Heat stabilized material for high temperature applications up to 239°F (115°C) – indoor use
- Cable tie, mount, and fastener in a single part
- Used to attach bundles to another surface such as a flat panel

- Anchor is easily pressed into a pre-formed hole and locks in place
- Wings provide constant tension for a stable, secure, and rattle-free installation
- Curved tip is easy to pick up from flat surfaces and allows faster initial threading to speed installation

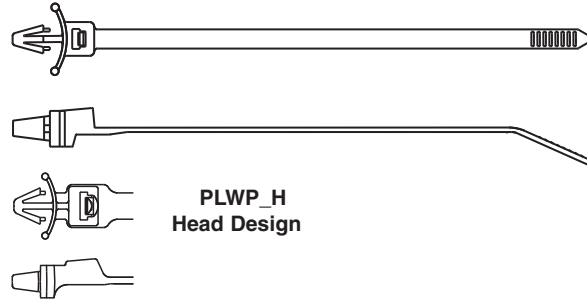

Part Number	Length		Width		Thickness		Nominal Hole Dia.		Max. Panel Thickness		Max. Bundle Dia.		Min. Loop Tensile Str.		Recommended Installation Tool	Std. Pkg. Qty.	Std. Ctn. Qty.
	In.	mm	In.	mm	In.	mm	In.	mm	In.	mm	In.	mm	Lbs.	N			

### Weather Resistant Nylon 6.6

#### Miniature Cross Section

<b>PLWP1M-D0</b>	4.3	109	.098	2.5	.044	1.1	.187	4.7	.093	2.4	.87	22	18	80	GTS, GTSL, GS2B, PTS, PPTS, STS2	500	5000
------------------	-----	-----	------	-----	------	-----	------	-----	------	-----	-----	----	----	----	----------------------------------	-----	------

#### Standard Cross Section

<b>PLWP1S-C0</b>	5.2	132	.190	4.8	.052	1.3	.250	6.4	.105	2.7	1.00	25	50	222	GTS, GTSL, GS2B, GTH, GS4H, PTS, PTH, PPTS, STS2, STH2	100	1000
<b>PLWP2S-C0</b>	7.8	198	.190	4.8	.052	1.3	.250	6.4	.105	2.7	1.75	45	50	222		100	1000

#### Light-Heavy Cross Section

<b>PLWP2H-TL0</b>	8.9	226	.300	7.6	.075	1.9	.266	6.8	.105	2.7	2.00	51	120	534	GTH, GS4H, GS4EH, PTH, STH2, ST3EH	250	2500
<b>PLWP3H-TL0</b>	12.0	305	.300	7.6	.075	1.9	.266	6.8	.105	2.7	3.00	76	120	534		250	2500

### Heat Stabilized Nylon 6.6

#### Miniature Cross Section

<b>PLWP1M-D30</b>	4.3	109	.098	2.5	.044	1.1	.187	4.7	.093	2.4	.87	22	18	80	GTS, GTSL, GS2B, PTS, PPTS, STS2	500	5000
-------------------	-----	-----	------	-----	------	-----	------	-----	------	-----	-----	----	----	----	----------------------------------	-----	------

#### Intermediate Cross Section

<b>PLWP1.5I-D30</b>	6.0	152	.135	3.4	.045	1.2	.187	4.7	.093	2.4	1.25	32	40	178	GTS, GTSL, GS2B, PTS, PPTS, STS2	500	5000
---------------------	-----	-----	------	-----	------	-----	------	-----	------	-----	------	----	----	-----	----------------------------------	-----	------

#### Standard Cross Section

<b>PLWP1S-D30</b>	5.2	132	.190	4.8	.052	1.3	.250	6.4	.105	2.7	1.00	25	50	222	GTS, GTSL, GS2B, GTH, GS4H, PTS, PTH, PPTS, STS2, STH2	500	5000
<b>PLWP1.5S-D30</b>	6.8	173	.190	4.8	.052	1.3	.250	6.4	.105	2.7	1.50	38	50	222		500	5000
<b>PLWP2S-D30</b>	7.8	198	.190	4.8	.052	1.3	.250	6.4	.105	2.7	1.75	45	50	222		500	5000

#### Light-Heavy Cross Section

<b>PLWP2H-TL30</b>	8.9	226	.300	7.6	.075	1.9	.266	6.8	.105	2.7	2.00	51	120	534	GTH, GS4H, GS4EH, PTH, STH2, ST3EH	250	2500
--------------------	-----	-----	------	-----	------	-----	------	-----	------	-----	------	----	-----	-----	------------------------------------	-----	------

Note: UL Recognized and CSA Certified except PLWP2H/3H.

A.  
System  
Overview

B1.  
Cable Ties

B2.  
Cable  
Accessories

B3.  
Stainless  
Steel Ties

C1.  
Wiring  
Duct

C2.  
Surface  
Raceway

C3.  
Abrasion  
Protection

C4.  
Cable  
Management

D1.  
Terminals

D2.  
Power  
Connectors

D3.  
Grounding  
Connectors

E1.  
Labeling  
Systems

E2.  
Labels

E3.  
Pre-Printed  
& Write-On  
Markers

E4.  
Permanent  
Identification

E5.  
Lockout/  
Tagout  
& Safety  
Solutions

F.  
Index

A. System Overview

## cUL<sup>us</sup> cCSA<sup>us</sup> Pan-Ty® Releasable Wing Push Mount Ties

B1. Cable Ties

- Natural nylon material for indoor use
- Weather resistant material has greater resistance to damage caused by ultraviolet light – indoor or outdoor use
- Heat stabilized material for high temperature applications up to 239°F (115°C) – indoor use
- Cable tie, mount, and fastener in a single part
- Used to attach bundles to another surface such as a flat panel

- Anchor is easily pressed into a pre-formed hole and locks in place
- Wings provide constant tension for a stable, secure, and rattle-free installation
- Extended release tab permits easy release and re-use where changes are anticipated during development, production, or servicing in the field
- Curved tip is easy to pick up from flat surfaces and allows faster initial threading to speed installation

B2. Cable Accessories

B3. Stainless Steel Ties



PRWP2S-D

PRWP2S-D0

C1. Wiring Duct

C2. Surface Raceway

C3. Abrasion Protection

C4. Cable Management



D1. Terminals

D2. Power Connectors

D3. Grounding Connectors

E1. Labeling Systems

E2. Labels

E3. Pre-Printed & Write-On Markers

E4. Permanent Identification

E5. Lockout/Tagout & Safety Solutions

F. Index

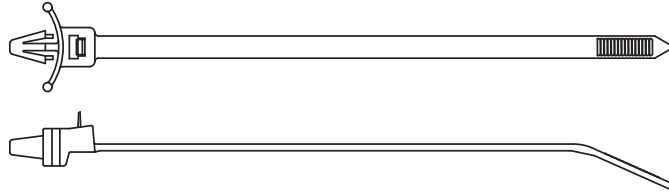

PRWP\_SA Head Design

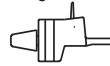

PRWP\_SB Head Design

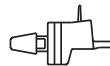

PRWP\_H Head Design

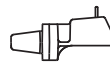

Part Number	Length		Width		Thickness		Nominal Hole Dia.		Max. Panel Thickness		Max. Bundle Dia.		Min. Loop Tensile Str.		Recommended Installation Tool	Std. Pkg. Qty.	Std. Ctn. Qty.
	In.	mm	In.	mm	In.	mm	In.	mm	In.	mm	In.	mm	Lbs.	N			

### Nylon 6.6

#### Standard Cross Section

PRWP1S-C	5.2	132	.190	4.8	.052	1.3	.250	6.4	.105	2.7	1.00	25	50	222	Hand install only	100	1000
PRWP1SA-D	5.1	130	.190	4.8	.052	1.3	.187	4.7	.093	2.4	1.00	25	50	222		500	5000
PRWP1SB-D	5.2	132	.190	4.8	.052	1.3	.187	4.7	.157	4.0	1.00	25	50	222		500	5000
<b>PRWP1.5S-D</b>	6.8	173	.190	4.8	.052	1.3	.250	6.4	.105	2.7	1.50	38	50	222		500	5000
PRWP2S-D	7.8	198	.190	4.8	.052	1.3	.250	6.4	.105	2.7	1.75	45	50	222		500	5000

#### Light-Heavy Cross Section

PRWP2H-TL	8.9	226	.300	7.6	.075	1.9	.266	6.8	.105	2.7	2.00	51	120	534	Hand install only	250	2500
-----------	-----	-----	------	-----	------	-----	------	-----	------	-----	------	----	-----	-----	-------------------	-----	------

### Weather Resistant Nylon 6.6

#### Standard Cross Section

<b>PRWP1S-D0</b>	5.2	132	.190	4.8	.052	1.3	.250	6.4	.105	2.7	1.00	25	50	222	Hand install only	500	5000
<b>PRWP1.5S-D0</b>	6.8	173	.190	4.8	.052	1.3	.250	6.4	.105	2.7	1.50	38	50	222		500	5000
PRWP2S-D0	7.8	198	.190	4.8	.052	1.3	.250	6.4	.105	2.7	1.75	45	50	222		500	5000

### Heat Stabilized Nylon 6.6

#### Standard Cross Section

PRWP1.5S-D30	6.8	173	.190	4.8	.052	1.3	.250	6.4	.105	2.7	1.50	38	50	222	Hand install only	500	5000
--------------	-----	-----	------	-----	------	-----	------	-----	------	-----	------	----	----	-----	-------------------	-----	------

Note: UL Recognized and CSA Certified except PRWP2H.



## Pan-Ty® Center Mounted Wing Push Mount Ties – Heat Stabilized Nylon 6.6

- For high temperature applications up to 239°F (115°C) – indoor use
- Used to center the bundle over the mount on all bundle diameters
- Cable tie, mount, and fastener in a single part
- Anchor is easily pressed into a pre-formed hole and locks in place

- Wings provide constant tension for a stable, secure, and rattle-free installation
- Curved tip is easy to pick up from flat surfaces and allows faster initial threading to speed installation



**PLWP-SC** – Designed for normal wire bundles.

**PLWP-SD** – Designed for corrugated loom tubing. Bump prevents lateral and axial movement.

**PLWP-SE** – Designed for corrugated loom tubing, see page C3.11. Bump prevents lateral movement.

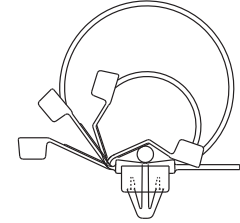

**Bundle diameters from .12" to 1.97" (3mm to 50mm)**

Part Number	Length		Width		Thickness		Nominal Hole Dia.		Max. Panel Thickness		Max. Bundle Dia.		Min. Loop Tensile Str.		Recommended Installation Tool	Std. Pkg. Qty.	Std. Ctn. Qty.	
	In.	mm	In.	mm	In.	mm	In.	mm	In.	mm	In.	mm	Lbs.	N				
<b>Standard Cross Section</b>																		
<b>PLWP30SC-D30</b>	5.8	147	.190	4.8	.050	1.3	.266	6.8	.118	3.0	1.18	30	50	222	GTS, GTSL, GS2B, GTH, GS4H, PTS, PTH, PPTS, STS2, STH2	500	5000	
<b>PLWP40SC-D30</b>	7.0	178	.190	4.8	.050	1.3	.266	6.8	.118	3.0	1.58	40	50	222		500	5000	
<b>PLWP40SD-D30</b>	7.0	178	.190	4.8	.050	1.3	.266	6.8	.118	3.0	1.58	40	50	222		500	5000	
<b>PLWP50SC-D30</b>	8.2	208	.190	4.8	.050	1.3	.266	6.8	.118	3.0	1.97	50	50	222		500	5000	
<b>PLWP50SE-D30</b>	8.2	208	.190	4.8	.050	1.3	.266	6.8	.118	3.0	1.97	50	50	222		500	5000	

A. System Overview

B1. Cable Ties

B2. Cable Accessories

B3. Stainless Steel Ties

C1. Wiring Duct

C2. Surface Raceway

C3. Abrasion Protection

C4. Cable Management

D1. Terminals

D2. Power Connectors

D3. Grounding Connectors

E1. Labeling Systems

E2. Labels

E3. Pre-Printed & Write-On Markers

E4. Permanent Identification

E5. Lockout/Tagout & Safety Solutions

F. Index

A. System Overview



## Pan-Ty® Ladder Style Releasable Wing Push Mount Ties – Heat Stabilized Nylon 6.6

B1. Cable Ties

- For high temperature applications up to 239°F (115°C) – indoor use
- Unique releasable ladder design eliminates the need for multiple clamp sizes
- Cable tie, mount, and fastener in a single part

- Used to attach bundles to another surface such as a flat panel
- Anchor is easily pressed into a pre-formed hole and locks in place
- Wings provide constant tension for a stable, secure, and rattle-free installation
- Curved tip is easy to pick up from flat surfaces and allows faster initial threading to speed installation

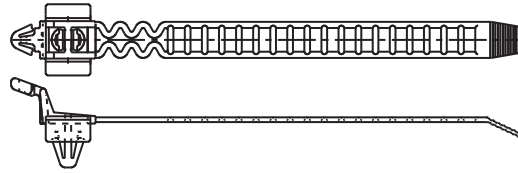
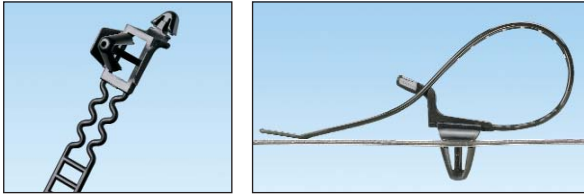

B3. Stainless Steel Ties

C1. Wiring Duct

C2. Surface Raceway

Part Number	Length		Width		Thickness		Nominal Hole Dia.		Max. Panel Thickness		Max. Bundle Dia.		Min. Loop Tensile Str.		Recommended Installation Tool	Std. Pkg. Qty.	Std. Ctn. Qty.
	In.	mm	In.	mm	In.	mm	In.	mm	In.	mm	In.	mm	Lbs.	N			
<b>Standard Cross Section</b>																	
<b>PRLWP30S-D30</b>	4.7	119	.380	9.7	.050	1.3	.266	6.8	.118	3.0	1.43	36	35	156	Hand install only	500	5000
<b>PRLWP50S-D30</b>	7.1	180	.380	9.7	.050	1.3	.266	6.8	.118	3.0	2.18	55	35	156		500	5000

C3. Abrasion Protection

C4. Cable Management

## Pan-Ty® Umbrella Wing Push Mount Ties – Nylon and Heat Stabilized Nylon 6.6

- Natural nylon material for indoor use
- Heat stabilized material for high temperature applications up to 239°F (115°C) – indoor use
- Quick, secure way to fasten to clearance holes in panel
- Anchor is easily pressed into a pre-formed hole in a light gauge metal or plastic and locks in place

- Umbrella shaped disk provides constant tension for a stable, secure, and rattle-free installation
- Disk forms a dust-tight and semi-liquid tight seal to the panel surface
- PLUP40SE style is for use with corrugated loom tubing, see page C3.11
- Curved tip is easy to pick up from flat surfaces and allows faster initial threading to speed installation

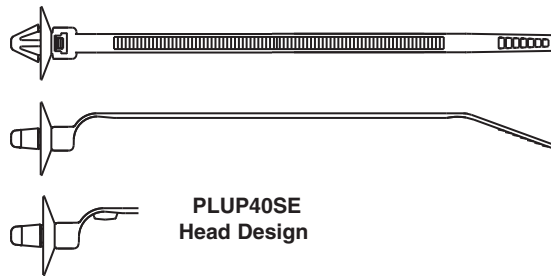

D1. Terminals

D2. Power Connectors

D3. Grounding Connectors

E1. Labeling Systems

E2. Labels

E3. Pre-Printed & Write-On Markers

E4. Permanent Identification

E5. Lockout/Tagout & Safety Solutions

F. Index

Part Number	Length		Width		Thickness		Nominal Hole Dia.		Max. Panel Thickness		Max. Bundle Dia.		Min. Loop Tensile Str.		Recommended Installation Tool	Std. Pkg. Qty.	Std. Ctn. Qty.
	In.	mm	In.	mm	In.	mm	In.	mm	In.	mm	In.	mm	Lbs.	N			
<b>Standard Cross Section</b>																	
<b>PLUP40S-D30*</b>	7.0	177	.190	4.8	.047	1.2	.266	6.8	.050	1.3	1.57	40	50	222	GTS, GTSL, GS2B, GTH, GS4H, PTS, PTH, PPTS, STS2, STH2	500	5000
<b>PLUP40SE-D</b>	7.0	177	.190	4.8	.047	1.2	.266	6.8	.050	1.3	1.57	40	50	222		500	5000
<b>PLUP40SE-D30*</b>	7.0	177	.190	4.8	.047	1.2	.266	6.8	.050	1.3	1.57	40	50	222		500	5000

\*Heat stabilized material (30).

## Pan-Ty® Push Mount Ties

- Natural nylon material for indoor use
- Weather resistant material has greater resistance to damage caused by ultraviolet light – indoor or outdoor use
- Heat stabilized material for high temperature applications up to 239°F (115°C) – indoor use
- *Wingless* design allows tie to be used in confined spaces

- Cable tie, mount, and fastener in a single part
- Economical push mount ties are used to attach bundles to another surface such as a flat panel
- Anchor is easily pressed into a pre-formed hole and locks in place
- Curved tip is easy to pick up from flat surfaces and allows faster initial threading to speed installation

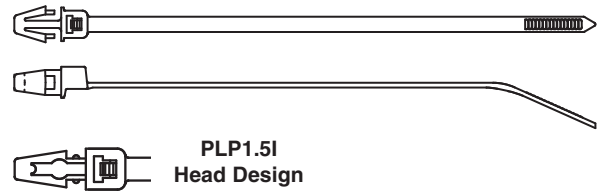
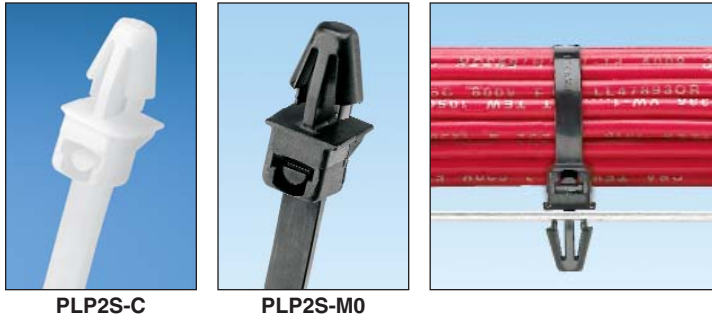

Part Number	Length		Width		Thickness		Nominal Hole Dia.		Max. Panel Thickness		Max. Bundle Dia.		Min. Loop Tensile Str.		Recommended Installation Tool	Std. Pkg. Qty.	Std. Ctn. Qty.
	In.	mm	In.	mm	In.	mm	In.	mm	In.	mm	In.	mm	Lbs.	N			

### Nylon 6.6

#### Intermediate Cross Section

PLP1.5I-C	6.1	156	.135	3.4	.045	1.1	.187	4.7	.093	2.4	1.25	32	40	178	GTS, GTSL, GS2B, PTS, PPTS, STS2	100	1000
-----------	-----	-----	------	-----	------	-----	------	-----	------	-----	------	----	----	-----	----------------------------------	-----	------

#### Standard Cross Section

<b>PLP1S-M</b>	5.3	135	.180	4.6	.050	1.3	.250	6.4	.125	3.2	1.00	25	50	222	GTS, GTSL, GS2B, GTH, GS4H, PTS, PTH, PPTS, STS2, STH2	1000	10000
PLP1.5S-M	6.7	170	.180	4.6	.050	1.3	.250	6.4	.125	3.2	1.50	38	50	222		1000	10000
PLP2S-C	7.9	200	.180	4.6	.050	1.3	.250	6.4	.125	3.2	1.75	45	50	222		100	1000

### Weather Resistant Nylon 6.6

#### Intermediate Cross Section

PLP1.5I-M0	6.1	156	.135	3.4	.045	1.1	.187	4.7	.093	2.4	1.25	32	40	178	GTS, GTSL, GS2B, PTS, PPTS, STS2	1000	25000
------------	-----	-----	------	-----	------	-----	------	-----	------	-----	------	----	----	-----	----------------------------------	------	-------

#### Standard Cross Section

PLP1S-M0	5.3	135	.180	4.6	.050	1.3	.250	6.4	.125	3.2	1.00	25	50	222	GTS, GTSL, GS2B, GTH, GS4H, PTS, PTH, PPTS, STS2, STH2	1000	10000
<b>PLP2S-M0</b>	7.9	200	.180	4.6	.050	1.3	.250	6.4	.125	3.2	1.75	45	50	222		1000	10000

### Heat Stabilized Nylon 6.6

#### Intermediate Cross Section

PLP1.5I-M30	6.1	156	.135	3.4	.045	1.1	.187	4.7	.093	2.4	1.25	32	40	178	GTS, GTSL, GS2B, PTS, PPTS, STS2	1000	25000
-------------	-----	-----	------	-----	------	-----	------	-----	------	-----	------	----	----	-----	----------------------------------	------	-------

#### Standard Cross Section

PLP1S-M30	5.3	135	.180	4.6	.050	1.3	.250	6.4	.125	3.2	1.00	25	50	222	GTS, GTSL, GS2B, GTH, GS4H, PTS, PTH, PPTS, STS2, STH2	1000	10000
PLP2S-M30	7.9	200	.180	4.6	.050	1.3	.250	6.4	.125	3.2	1.75	45	50	222		1000	10000

A.  
System  
Overview

B1.  
Cable Ties

B2.  
Cable  
Accessories

B3.  
Stainless  
Steel Ties

C1.  
Wiring  
Duct

C2.  
Surface  
Raceway

C3.  
Abrasion  
Protection

C4.  
Cable  
Management

D1.  
Terminals

D2.  
Power  
Connectors

D3.  
Grounding  
Connectors

E1.  
Labeling  
Systems

E2.  
Labels

E3.  
Pre-Printed  
& Write-On  
Markers

E4.  
Permanent  
Identification

E5.  
Lockout/  
Tagout  
& Safety  
Solutions

F.  
Index

A. System Overview



## Pan-Ty® Marker and Flag Ties

- Natural nylon material for indoor use
- Weather resistant material has greater resistance to damage caused by ultraviolet light – indoor or outdoor use
- Flame retardant material has a flammability rating of UL 94V-0 – for indoor use
- Used to fasten and identify bundles at the same time
- One-piece construction for consistent performance and reliability

- Can be marked with Panduit marker pens on page B1.51 or computer printable labels
- Custom imprinting with text, symbols, or trademarks available using Panduit Custom Hot Stamping Service, see page B1.93
- Curved tip is easy to pick up from flat surfaces and allows faster initial threading to speed installation

B1. Cable Ties

B2. Cable Accessories

B3. Stainless Steel Ties

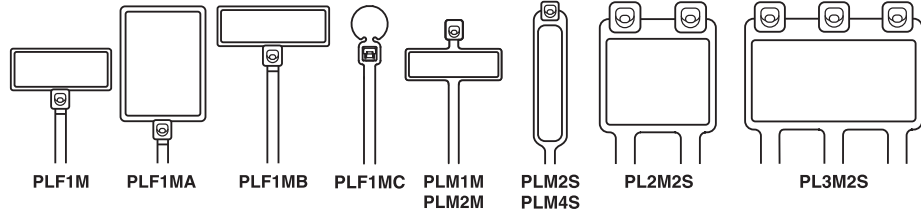
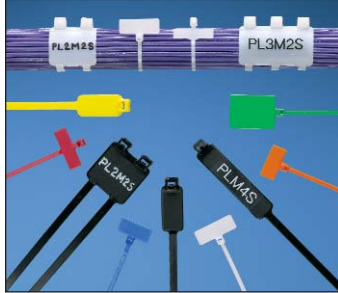

C1. Wiring Duct

C2. Surface Raceway

C3. Abrasion Protection

C4. Cable Management

D1. Terminals

D2. Power Connectors

D3. Grounding Connectors

E1. Labeling Systems

E2. Labels

E3. Pre-Printed & Write-On Markers

E4. Permanent Identification

E5. Lockout/Tagout & Safety Solutions

F. Index

Part Number	Marker Type	Length		Width		Thickness		Marker Write-On Area		Max. Bundle Dia.		Min. Loop Tensile Str.		Recommended Installation Tool	Std. Pkg. Qty.	Std. Ctn. Qty.
		In.	mm	In.	mm	In.	mm	In.	mm	In.	mm	Lbs.	N			

### Nylon 6.6

#### Miniature Cross Section

<b>PLF1M-C</b>	Flag	4.3	109	.098	2.5	.045	1.1	.31 x .75	7.9 x 19.1	.87	22	18	80	GTS, GTSL, GS2B, PTS, PPTS, STS2	100	1000
<b>PLF1MA-C</b>	Flag	5.1	130	.098	2.5	.045	1.1	.76 x 1.04	19.1 x 26.4	.87	22	18	80		100	1000
<b>PLF1MB-C</b>	Flag	4.0	101	.098	2.5	.045	1.1	.31 x .92	7.9 x 23.4	.75	19	18	80		100	1000
<b>PLF1MC-M</b>	Flag	4.3	109	.098	2.5	.045	1.1	.29 x .32	7.4 x 8.0	.87	22	18	80		1000	25000
<b>PLM1M-C</b>	Wrap	3.9	99	.098	2.5	.035	.9	.26 x .95	6.6 x 24.1	.75	19	18	80		100	1000
<b>PLM2M-C</b>	Wrap	8.0	203	.098	2.5	.035	.9	.26 x .95	6.6 x 24.1	2.00	51	18	80		100	1000

#### Standard Cross Section

<b>PLM2S-C</b>	Wrap	7.4	188	.185	4.7	.052	1.3	.44 x .87	11.1 x 22.1	1.75	45	50	222	GTS, GTSL, GS2B, GTH, GS4H, PTS, PTH, PPTS, STS2, STH2	100	1000
<b>PLM4S-C</b>	Wrap	14.6	371	.185	4.7	.052	1.3	.44 x 2.00	11.1 x 50.8	4.00	102	50	222		100	1000
<b>PL2M2S-L</b>	Wrap	7.4	188	.185	4.7	.052	1.3	.87 x 1.07	22.1 x 27.2	1.75	45	50	222		50	500
<b>PL3M2S-L</b>	Wrap	7.4	188	.185	4.7	.052	1.3	.87 x 1.79	22.1 x 45.5	1.75	45	50	222		50	500

### Weather Resistant Nylon 6.6

#### Miniature Cross Section

<b>PLF1M-C0</b>	Flag	4.3	109	.098	2.5	.045	1.1	.31 x .75	7.9 x 19.1	.87	22	18	80	GTS, GTSL, GS2B, PTS, PPTS, STS2	100	1000
<b>PLF1MA-M0</b>	Flag	5.1	130	.098	2.5	.045	1.1	.76 x 1.04	19.1 x 26.4	.87	22	18	80		1000	10000
<b>PLM1M-C0</b>	Wrap	3.9	99	.098	2.5	.035	.9	.26 x .95	6.6 x 24.1	.75	19	18	80		100	1000
<b>PLM2M-M0</b>	Wrap	8.0	203	.098	2.5	.035	.9	.26 x .95	6.6 x 24.1	2.00	51	18	80		1000	25000

#### Standard Cross Section

<b>PLM2S-C0</b>	Wrap	7.4	188	.185	4.7	.052	1.3	.44 x .87	11.1 x 22.1	1.75	45	50	222	GTS, GTSL, GS2B, GTH, GS4H, PTS, PTH, PPTS, STS2, STH2	100	1000
<b>PLM4S-D0</b>	Wrap	14.6	371	.185	4.7	.052	1.3	.44 x 2.00	11.1 x 50.8	4.00	102	50	222		500	5000
<b>PL2M2S-L0</b>	Wrap	7.4	188	.185	4.7	.052	1.3	.87 x 1.07	22.1 x 27.2	1.75	45	50	222		50	500
<b>PL3M2S-D0</b>	Wrap	7.4	188	.185	4.7	.052	1.3	.87 x 1.79	22.1 x 45.5	1.75	45	50	222		500	2500

### Flame Retardant Nylon 6.6

#### Miniature Cross Section

<b>PLF1M-M69</b>	Flag	4.3	109	.098	2.5	.045	1.1	.31 x .75	7.9 x 19.1	.87	22	18	80	GTS, GTSL, GS2B, PTS, PPTS, STS2	1000	25000
<b>PLM1M-M69</b>	Wrap	3.9	99	.098	2.5	.035	.9	.26 x .95	6.6 x 24.1	.75	19	18	80		1000	25000



## Pan-Ty® Cable Ties

### Material and Color Chart

Material	Color	Panduit Suffix
Nylon 6.6	Natural	✓
Weather Resistant Nylon 6.6	Black	0
Weather Resistant Nylon 6.6 (meets Mil. Spec.)	Black	00
Nylon 6.6	Brown	1
Nylon 6.6	Red	2
Nylon 6.6	Orange	3
Nylon 6.6	Yellow	4Y
Nylon 6.6	Green	5
Nylon 6.6	Blue	6
Nylon 6.6	Purple	7
Nylon 6.6	Gray	8
Nylon 6.6	White	10
Nylon 6.6	Telephone Gray	14
Nylon 6.6	Black	20
Heat Stabilized Nylon 6.6	Black	30

Material	Color	Panduit Suffix
Heat Stabilized Nylon 6.6	Natural	39
Nylon 6.6	Fluorescent Orange	53
Nylon 6.6	Fluorescent Yellow	54
Nylon 6.6	Fluorescent Green	55
Nylon 6.6	Fluorescent Pink	59
Flame Retardant Nylon 6.6	Black	60
Flame Retardant Nylon 6.6	Natural (Ivory)	69
PEEK (Polyetheretherketone)	Translucent Brown	71
TEFZEL <sup>■</sup>	Aqua Blue	76
Metal Detectable, Nylon	Blue	86
Metal Detectable, Polypropylene	Blue	186
Weather Resistant Polypropylene	Black	100
Polypropylene	Green	109
Nylon 12	Black	120
Heat Stabilized Weather Resistant Nylon 6.6	Black	300
HALAR <sup>▲</sup>	Maroon	702Y

✓Denotes Panduit Natural Nylon 6.6 (no suffix).

■TEFZEL is a registered trademark of E.I. du Pont de Nemours and Company.

▲HALAR is a registered trademark of Ausimont USA, Inc.

### Part Number Availability List

Standard Packaging			Bulk Packaging		
Part Number	Natural Nylon 6.6	Material/Color Suffix	Part Number	Natural Nylon 6.6	Material/Color Suffix
PLC1M-S4-C	✓	0	PLC1M-S4-M	✓	0,30
PLC1.5I-S8-C	✓	0	PLC1.5I-S8-M	✓	0,30
PLC2S-S6-C	✓	0	PLC2S-S6-M	✓	0
PLC2S-S10-C	✓	0,14	PLC2S-S10-M	✓	0,20,30
PLC3S-S10-C	✓	0	PLC3S-S10-M	✓	0
PLC4S-S10-C	✓	0	PLC4S-S10-M	✓	0,30
PLC2H-S25-L	✓		PLC2H-S25-TL	✓	0,30
PLC4H-S25-L	✓	0	PLC4H-S25-TL	✓	0,30
PLF1M-C	✓	0	PLF1M-M	✓	0,2,3,4Y,6,10,69
PLF1MA-C	✓	3,4Y	PLF1MA-M	✓	0,2,3,4Y,5,6,10
PLF1MB-C	✓		PLF1MB-M	✓	
			PLF1MC-M		3
PLM1M-C	✓	0	PLM1M-M	✓	0,1,2,3,4Y,5,6,7,8,10,69
PLM2M-C	✓		PLM2M-M	✓	0,4Y,6
PLM2S-C	✓	0,4Y	PLM2S-D	✓	0,2,3,4Y,5,6,8
PLM4S-C	✓		PLM4S-D	✓	0,2,4Y,6

List continues on page B1.36

A. System Overview

## Pan-Ty® Cable Ties (continued)

B1. Cable Ties

B2. Cable Accessories

B3. Stainless Steel Ties

C1. Wiring Duct

C2. Surface Raceway

C3. Abrasion Protection

C4. Cable Management

D1. Terminals

D2. Power Connectors

D3. Grounding Connectors

E1. Labeling Systems

E2. Labels

E3. Pre-Printed & Write-On Markers

E4. Permanent Identification

E5. Lockout/Tagout & Safety Solutions

F. Index

Standard Packaging			Bulk Packaging		
Part Number	Natural Nylon 6.6	Material/Color Suffix	Part Number	Natural Nylon 6.6	Material/Color Suffix
PL2M2S-L	✓	0	PL2M2S-D	✓	0,4Y,10
PL3M2S-L	✓		PL3M2S-D	✓	0,4Y
PLP1.5I-C	✓		PLP1.5I-M	✓	0,30
			PLP1S-M	✓	0,30
			PLP1.5S-M	✓	
PLP2S-C	✓		PLP2S-M	✓	0,30
PLT.6SM-C	✓	0	PLT.6SM-M	✓	0,30
PLT.7M-C	✓		PLT.7M-M	✓	0,30
PLT1M-C	✓	0,00,1,2,3,4Y,5,6,7,8,10,14,30,71,76,86,186,702Y	PLT1M-M	✓	0,00,1,2,3,4Y,5,6,7,8,10,14,20,30,53,54,55,59,60,69,76,100,109,300,702Y
			PLT1M-XMR	✓	0,1,2,3,4Y,5,6,7,8,10,30
PLT1.5M-C	✓	0	PLT1.5M-M	✓	0,00,1,2,3,4Y,5,6,7,8,10,14,20,30
			PLT1.5M-XMR	✓	0,00,30
PLT2M-C	✓	0	PLT2M-M	✓	0,1,2,3,4Y,5,6,7,8,10,20,30,69
PLT1.5I-C	✓	0,1,2,3,4Y,5,6,7,8,10,20,30	PLT1.5I-M	✓	0,00,1,2,3,4Y,5,6,7,8,10,20,30,69,100,109,120,300
PLT2I-C	✓	0,14,30,76,86,186	PLT2I-M	✓	0,00,1,2,3,4Y,5,6,7,8,10,14,20,30,53,54,55,59,69,76,300
PLT2.5I-C	✓	0	PLT2.5I-M	✓	0,20
PLT3I-C	✓	0,14	PLT3I-M	✓	0,2,3,4Y,5,6,8,10,14,20,30
PLT4I-C	✓	0,14	PLT4I-M	✓	0,2,5,6,14,20,30
PLT1S-C	✓	0	PLT1S-M	✓	0,30,38,300
PLT1.5S-C	✓	0	PLT1.5S-M	✓	0,30
PLT2S-C	✓	0,00,1,2,3,4Y,5,6,7,8,10,20,30,71,76,86,186,702Y	PLT2S-M	✓	0,00,1,2,3,4Y,5,6,7,8,10,20,30,38,39,53,54,55,59,60,69,71,76,100,109,120,300,702Y
			PLT2S-VMR	✓	0,30
PLT2.5S-C	✓	0	PLT2.5S-M	✓	0,30
PLT3S-C	✓	0,00,2,20,30,76,86,186,702Y	PLT3S-M	✓	0,00,1,2,3,4Y,5,6,7,8,10,20,30,53,54,55,59,76,100,109,702Y
PLT4S-C	✓	0,00,2,3,4Y,5,6,8,20,30,76,86,186	PLT4S-M	✓	0,00,1,2,3,4Y,5,6,7,8,10,14,20,30,69,76,100,109,120,300
PLT4.5S-C	✓	0	PLT4.5S-M	✓	0
PLT5S-C	✓	0	PLT5S-M	✓	0,2,3,4Y,5,6,8,30
PLT6LH-L	✓	0	PLT6LH-C	✓	0
PLT7LH-L	✓	0	PLT7LH-C	✓	0,30
PLT8LH-L	✓	0	PLT8LH-C	✓	0,120
PLT8LH-Q		0			
PLT9LH-L	✓	0	PLT9LH-C	✓	0,30
PLT10LH-L	✓		PLT10LH-C	✓	
PLT2H-L	✓	0	PLT2H-TL	✓	0,2,4Y,6,30,100,109,300
PLT2.5H-L	✓	0	PLT2.5H-TL	✓	0
PLT3H-L	✓	0,76,86,186	PLT3H-TL	✓	0,30,76,100,109
PLT4H-L	✓	0,00,76,86,186	PLT4H-TL	✓	0,00,1,2,3,4Y,5,6,10,20,30,69,76,100,109,120,300
PLT4H-C	✓	0			
PLT5H-L	✓	0	PLT5H-C	✓	0,30
PLT6H-L	✓	0	PLT6H-C	✓	0,30
PLT8H-L	✓	0	PLT8H-C	✓	0,00,30
PLT8H-L	✓	0			
PLT13H-Q	✓	0	PLT13H-C	✓	0,3

Standard Packaging			Bulk Packaging		
Part Number	Natural Nylon 6.6	Material/Color Suffix	Part Number	Natural Nylon 6.6	Material/Color Suffix
PLT2EH-Q		0	PLT2EH-C	✓	0
			PLT3EH-NB-C		0
PLT5EH-Q	✓	0	PLT5EH-C	✓	0
			PLT5EH-NB-C		0
PLT6EH-Q	✓	0	PLT6EH-C	✓	0
			PLT6EH-NB-C		0
PLT8EH-Q		0	PLT8EH-C	✓	0
PLT10EH-Q		0	PLT10EH-C	✓	0
PLT12EH-Q		0	PLT12EH-C	✓	0
			PLUP40S-D		30
			PLUP40SE-D	✓	30
PLWP1M-C	✓		PLWP1M-D	✓	0,30
PLWP1.5I-C	✓		PLWP1.5I-D	✓	30
PLWP1S-C	✓	0	PLWP1S-D	✓	0,20,30
			PLWP1SA-D	✓	
			PLWP1SB-D	✓	
			PLWP1.5S-D	✓	30
			PLWP1.5SA-D	✓	
PLWP2S-C	✓	0	PLWP2S-D	✓	0,30
			PLWP2SA-D	✓	
			PLWP2SB-D	✓	
			PLWP2H-TL	✓	0,30
			PLWP3H-TL	✓	0
			PLWP30SC-D		30
			PLWP40SC-D		30
			PLWP40SD-D		30
			PLWP50SC-D		30
			PLWP50SE-D		30
			PRLWP30S-D		30
			PRLWP50S-D		30
PRT1S-C	✓	0	PRT1S-M	✓	0
PRT1.5S-C	✓	0	PRT1.5S-M	✓	0,30
PRT2S-C	✓	0	PRT2S-M	✓	0,2,3,4Y,6,7
PRT3S-C	✓	0	PRT3S-M	✓	0
PRT4S-C	✓	0	PRT4S-M	✓	0,2,3,4Y,6
PRT2H-L	✓	0	PRT2H-TL	✓	0
PRT3H-L	✓	0	PRT3H-TL	✓	0
PRT4H-L	✓	0	PRT4H-TL	✓	0
PRT2EH-Q		0	PRT2EH-C	✓	0,100
PRT5EH-Q	✓	0	PRT5EH-C	✓	0,100
PRT6EH-Q	✓	0	PRT6EH-C	✓	0,100
PRT8EH-Q		0	PRT8EH-C	✓	0,100
PRT10EH-Q		0	PRT10EH-C	✓	0
PRT12EH-Q		0	PRT12EH-C	✓	0
PRWP1S-C	✓		PRWP1S-D	✓	0
			PRWP1SA-D	✓	
			PRWP1SB-D	✓	
			PRWP1.5S-D	✓	0,20,30
			PRWP2S-D	✓	0
			PRWP2H-TL	✓	

A.  
System  
Overview

B1.  
Cable  
Ties

B2.  
Cable  
Accessories

B3.  
Stainless  
Steel Ties

C1.  
Wiring  
Duct

C2.  
Surface  
Raceway

C3.  
Abrasion  
Protection

C4.  
Cable  
Management

D1.  
Terminals

D2.  
Power  
Connectors

D3.  
Grounding  
Connectors

E1.  
Labeling  
Systems

E2.  
Labels

E3.  
Pre-Printed  
& Write-On  
Markers

E4.  
Permanent  
Identification

E5.  
Lockout/  
Tagout  
& Safety  
Solutions

F.  
Index

A. System Overview

## Features and Benefits – Super-Grip® Cable Ties

One-piece design with a thin, wide strap body for improved flexibility.

B1. Cable Ties

Dome shaped head and smooth, round strap body protect the cable insulation

B2. Cable Accessories

B3. Stainless Steel Ties

C1. Wiring Duct

C2. Surface Raceway

C3. Abrasion Protection

C4. Cable Management

D1. Terminals

D2. Power Connectors

D3. Grounding Connectors

E1. Labeling Systems

E2. Labels

E3. Pre-Printed & Write-On Markers

E4. Permanent Identification

E5. Lockout/Tagout & Safety Solutions

F. Index

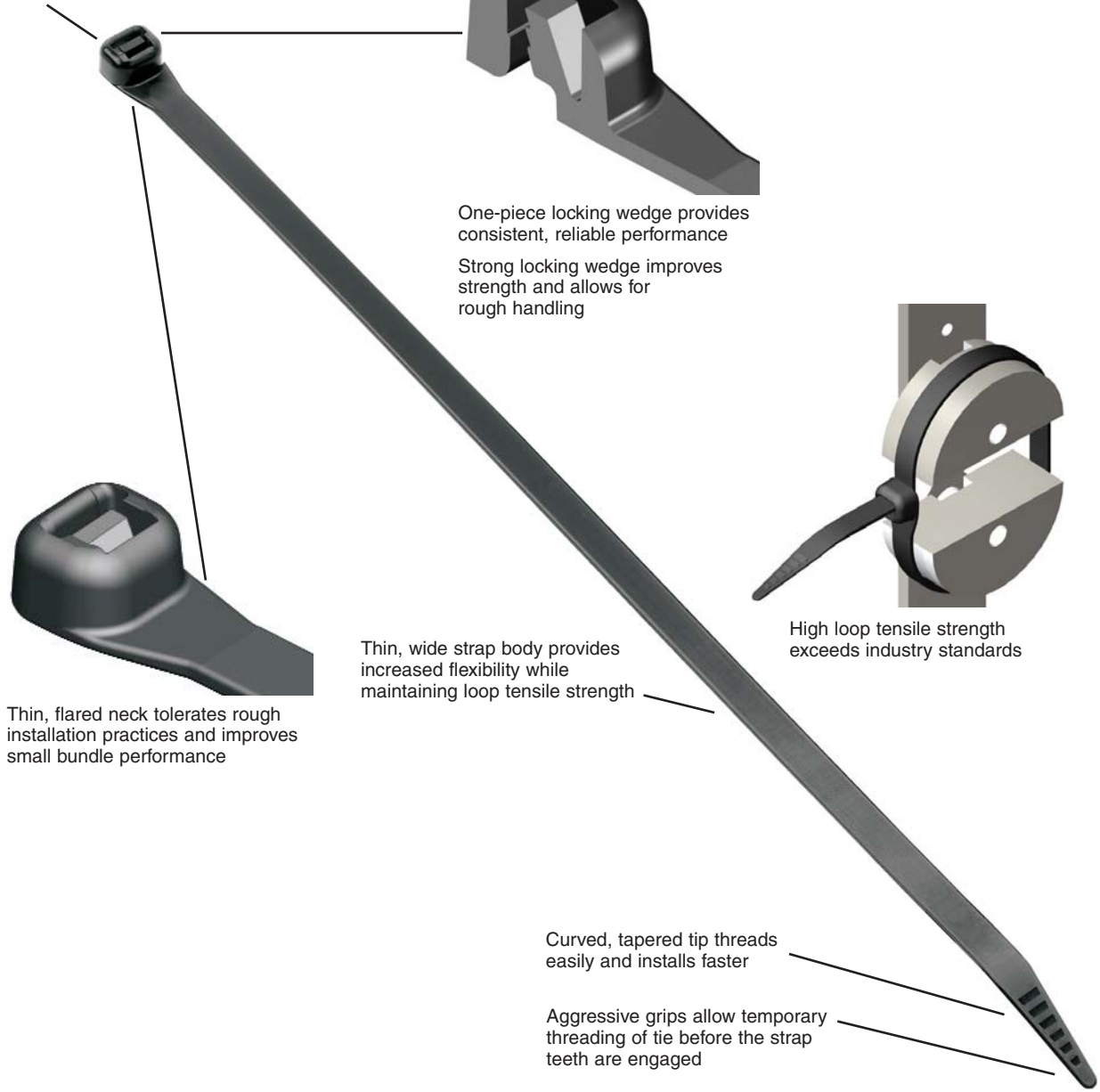

Cable tie tools speed installation and reduce total installed cost. See pages B1.107 – B1.112.



Cable tie accessories are used to speed and simplify the mounting of wires, cables, and tubing. See pages B2.7, B2.11, B2.13, B2.21.

## Selection Guide – Super-Grip® Cable Ties



Material, Color (Suffix)	Style/Function	Part Number Prefix	Catalog Page
Nylon 6.6, Natural (No Suffix)	Locking Ties/Bundle	SG	B1.40
Weather Resistant Nylon 6.6, Black (0)	Locking Ties/Bundle	SG	B1.41
Heat Stabilized Nylon 6.6, Black (30)	Locking Ties/Bundle	SG	B1.41

## Part Number System for Super-Grip® Cable Ties

**SG**

Type

SG = Locking Tie

**200**

Length

Approx. Length (mm)

**S**

Cross Section

M = Miniature  
I = Intermediate  
S = Standard  
LH = Light-Heavy  
H = Heavy

—

**C**

Package Size

L = 50  
C = 100  
TL = 250  
M = 1000

**T**

Material/Color

See Page B1.42

A. System Overview

B1. Cable Ties

B2. Cable Accessories

B3. Stainless Steel Ties

C1. Wiring Duct

C2. Surface Raceway

C3. Abrasion Protection

C4. Cable Management

D1. Terminals

D2. Power Connectors

D3. Grounding Connectors

E1. Labeling Systems

E2. Labels

E3. Pre-Printed & Write-On Markers

E4. Permanent Identification

E5. Lockout/Tagout & Safety Solutions

F. Index

A.  
System  
Overview



## Super-Grip® Cable Ties – Nylon 6.6

B1.  
Cable Ties

- For indoor use
- Designed to grip the bundle tightly to resist lateral movement of the tie once installed
- High strength allows the tie to withstand rough installation practices that occur in MRO and construction environments
- Thin, wide strap body provides flexibility enabling it to conform to bundle while maintaining tensile strength

- Curved tip is easy to pick up from flat surfaces and allows faster initial threading to speed installation
- UL Listed for use in plenum or air handling spaces per NEC
- Complementary mounts available, see pages B2.7, B2.11, B2.13 and B2.21

B2.  
Cable  
Accessories

B3.  
Stainless  
Steel Ties

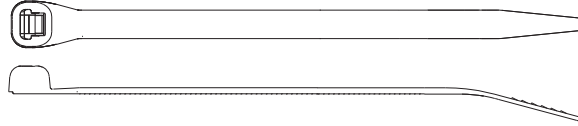

C1.  
Wiring  
Duct

C2.  
Surface  
Raceway

C3.  
Abrasion  
Protection

C4.  
Cable  
Management

D1.  
Terminals

D2.  
Power  
Connectors

D3.  
Grounding  
Connectors

E1.  
Labeling  
Systems

E2.  
Labels

E3.  
Pre-Printed  
& Write-On  
Markers

E4.  
Permanent  
Identification

E5.  
Lockout/  
Tagout/  
& Safety  
Solutions

F.  
Index

Part Number	Length		Width		Thickness		Max. Bundle Dia.		Min. Loop Tensile Str.		Recommended Installation Tool	Std. Pkg. Qty.	Std. Ctn. Qty.
	In.	mm	In.	mm	In.	mm	In.	mm	Lbs.	N			
<b>Miniature Cross Section – Plenum-Rated</b>													
<b>SG100M-C</b>	4.2	106	.118	3.0	.038	1.0	.90	23	18	80	GTS, GTSL, GS2B, PTS, PPTS, STS2	100	1000
<b>Intermediate Cross Section – Plenum-Rated</b>													
<b>SG150I-C</b>	6.2	157	.168	4.3	.040	1.0	1.50	38	40	178	GTS, GTSL, GS2B, PTS, PPTS, STS2	100	1000
<b>Standard Cross Section – Plenum-Rated</b>													
<b>SG200S-C</b>	8.3	211	.225	5.7	.046	1.2	2.00	51	50	222	GTS, GTSL, GS2B, GTH, GS4H, PTS, PTH, PPTS, STS2, STH2	100	1000
<b>SG250S-C</b>	10.4	264	.225	5.7	.050	1.3	2.60	66	75	334		100	1000
<b>SG300S-C</b>	12.4	315	.225	5.7	.050	1.3	3.20	81	75	334		100	1000
<b>SG370S-C</b>	15.3	389	.225	5.7	.052	1.3	4.20	107	75	334		100	1000
<b>Light-Heavy Cross Section – Plenum-Rated</b>													
<b>SG350LH-L</b>	15.3	389	.330	8.4	.064	1.6	4.13	105	120	534	GTH, GS4H, GS4EH, PTH, STH2, ST3EH	50	500
<b>Heavy Cross Section – Plenum-Rated</b>													
<b>SG450H-L</b>	18.6	471	.380	9.7	.068	1.7	5.20	132	175	778	GTH, GS4H, GS4EH, PTH, STH2, ST3EH	50	500



## Super-Grip® Cable Ties – Weather Resistant and Heat Stabilized Nylon 6.6

- Weather resistant material has greater resistance to damage caused by ultraviolet light – indoor or outdoor use
- Heat stabilized material for high temperature applications up to 239°F (115°C) – indoor use
- Designed to grip the bundle tightly to resist lateral movement of the tie once installed

- High strength allows the tie to withstand rough installation practices that occur in MRO and construction environments
- Thin, wide strap body provides flexibility enabling it to conform to bundle while maintaining tensile strength
- Curved tip is easy to pick up from flat surfaces and allows faster initial threading to speed installation
- Complementary mounts available, see pages B2.7, B2.11, B2.13 and B2.21

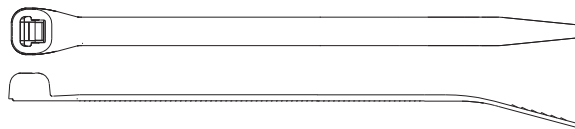

Part Number	Length		Width		Thickness		Max. Bundle Dia.		Min. Loop Tensile Str.		Recommended Installation Tool	Std. Pkg. Qty.	Std. Ctn. Qty.
	In.	mm	In.	mm	In.	mm	In.	mm	Lbs.	N			

### Weather Resistant Nylon 6.6

#### Miniature Cross Section

<b>SG100M-C0</b>	4.2	106	.118	3.0	.038	1.0	.90	23	18	80	GTS, GTSL, GS2B, PTS, PPTS, STS2	100	1000
------------------	-----	-----	------	-----	------	-----	-----	----	----	----	----------------------------------	-----	------

#### Intermediate Cross Section

<b>SG150I-C0</b>	6.2	157	.168	4.3	.040	1.0	1.50	38	40	178	GTS, GTSL, GS2B, PTS, PPTS, STS2	100	1000
------------------	-----	-----	------	-----	------	-----	------	----	----	-----	----------------------------------	-----	------

#### Standard Cross Section

<b>SG200S-C0</b>	8.3	211	.225	5.7	.046	1.2	2.00	51	50	222	GTS, GTSL, GS2B, GTH, GS4H, PTS, PTH, PPTS, STS2, STH2	100	1000
<b>SG250S-C0</b>	10.4	264	.225	5.7	.050	1.3	2.60	66	75	334		100	1000
<b>SG300S-C0</b>	12.4	315	.225	5.7	.050	1.3	3.20	81	75	334		100	1000
<b>SG370S-C0</b>	15.3	389	.225	5.7	.052	1.3	4.20	107	75	334		100	1000

#### Light-Heavy Cross Section

<b>SG350LH-L0</b>	15.3	389	.330	8.4	.064	1.6	4.13	105	120	534	GTH, GS4H, GS4EH, PTH, STH2, ST3EH	50	500
-------------------	------	-----	------	-----	------	-----	------	-----	-----	-----	------------------------------------	----	-----

#### Heavy Cross Section

<b>SG450H-L0</b>	18.6	471	.380	9.7	.068	1.7	5.20	132	175	778	GTH, GS4H, GS4EH, PTH, STH2, ST3EH	50	500
------------------	------	-----	------	-----	------	-----	------	-----	-----	-----	------------------------------------	----	-----

### Heat Stabilized Nylon 6.6

#### Standard Cross Section

<b>SG200S-M30</b>	8.3	211	.225	5.7	.046	1.2	2.00	51	50	222	GTS, GTSL, GS2B, GTH, GS4H, PTS, PTH, PPTS, STS2, STH2	1000	10000
<b>SG300S-M30</b>	12.4	315	.225	5.7	.050	1.3	3.20	81	70	311		1000	10000

#### Light-Heavy Cross Section

<b>SG350LH-TL30</b>	15.3	389	.330	8.4	.064	1.6	4.13	105	120	534	GTH, GS4H, GS4EH, PTH, STH2, ST3EH	250	2500
---------------------	------	-----	------	-----	------	-----	------	-----	-----	-----	------------------------------------	-----	------

Note: UL Listed and CSA Certified except SG450H-L0 and heat stabilized material (30).

A.  
System  
Overview

B1.  
Cable  
Ties

B2.  
Cable  
Accessories

B3.  
Stainless  
Steel Ties

C1.  
Wiring  
Duct

C2.  
Surface  
Raceway

C3.  
Abrasion  
Protection

C4.  
Cable  
Management

D1.  
Terminals

D2.  
Power  
Connectors

D3.  
Grounding  
Connectors

E1.  
Labeling  
Systems

E2.  
Labels

E3.  
Pre-Printed  
& Write-On  
Markers

E4.  
Permanent  
Identification

E5.  
Lockout/  
Tagout/  
& Safety  
Solutions

F.  
Index

A.  
System  
Overview

## Super-Grip® Cable Ties and Mounts

B1.  
Cable Ties

### Material and Color Chart

Material	Color	Panduit Suffix
Nylon 6.6	Natural	✓
Weather Resistant Nylon 6.6	Black	0
Heat Stabilized Nylon 6.6	Black	30

✓Denotes Panduit Natural Nylon 6.6 (no suffix).

B2.  
Cable  
Accessories

B3.  
Stainless  
Steel Ties

### Part Number Availability List

Part Number	Standard Packaging		Part Number	Bulk Packaging	
	Natural Nylon 6.6	Material/Color Suffix		Natural Nylon 6.6	Material/Color Suffix
SG100M-C	✓	0	SG100M-M	✓	0
SG150I-C	✓	0	SG150I-M	✓	0
SG200S-C	✓	0	SG200S-M	✓	0,30
SG250S-C	✓	0			
SG300S-C	✓	0	SG300S-M	✓	0,30
SG370S-C	✓	0	SG370S-M	✓	0
SG350LH-L	✓	0	SG350LH-TL	✓	0,30
SG450H-L	✓	0	SG450H-C	✓	0

C1.  
Wiring  
Duct

C2.  
Surface  
Raceway

C3.  
Abrasion  
Protection

C4.  
Cable  
Management

D1.  
Terminals

D2.  
Power  
Connectors

D3.  
Grounding  
Connectors

E1.  
Labeling  
Systems

E2.  
Labels

E3.  
Pre-Printed  
& Write-On  
Markers

E4.  
Permanent  
Identification

E5.  
Lockout/  
Tagout  
& Safety  
Solutions

F.  
Index



## Features and Benefits – Dome-Top® Barb Ty Cable Ties

Two-piece design incorporates a stainless steel locking barb in a nylon cable tie.

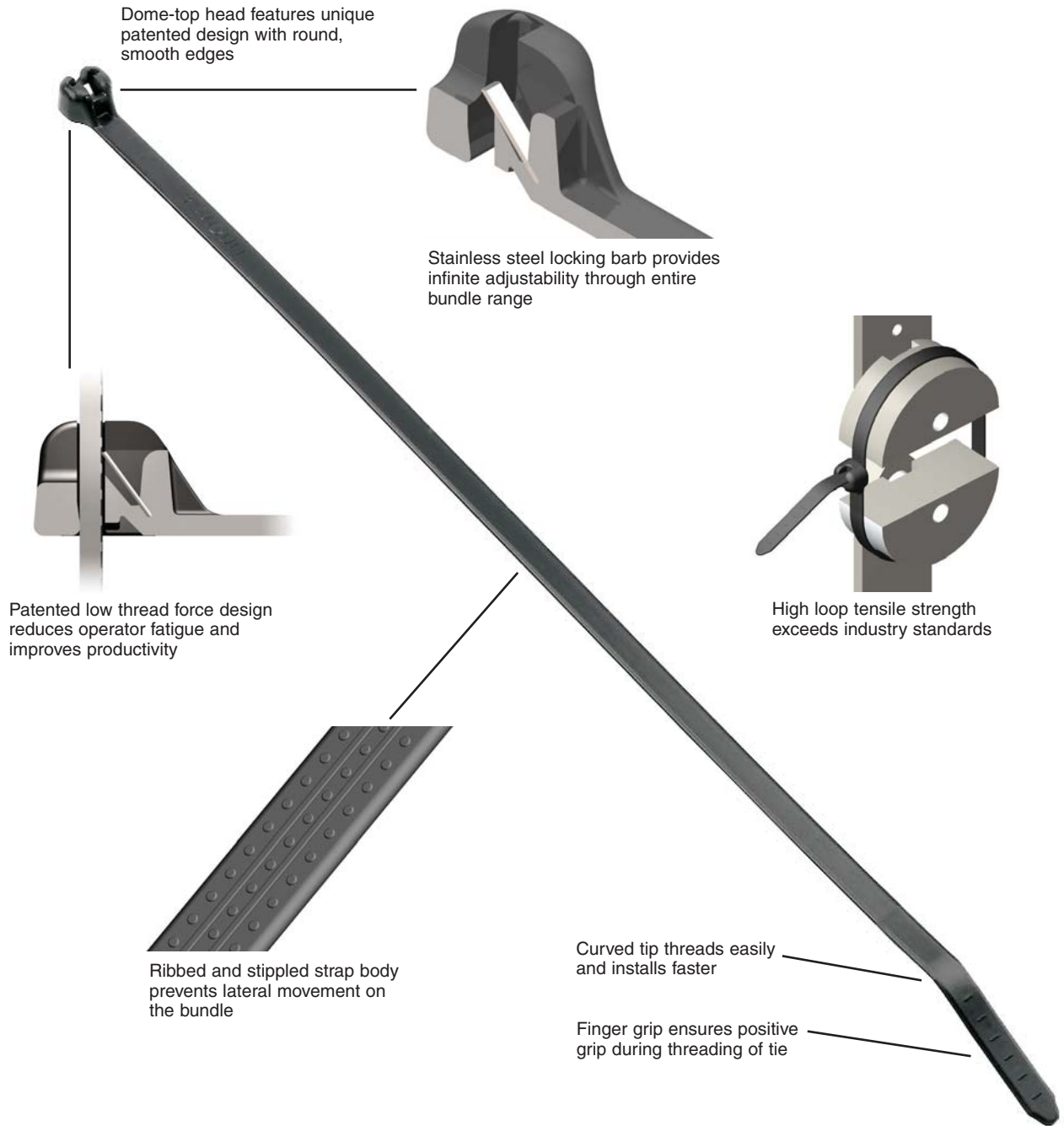

Dome-top head features unique patented design with round, smooth edges



Stainless steel locking barb provides infinite adjustability through entire bundle range

Patented low thread force design reduces operator fatigue and improves productivity

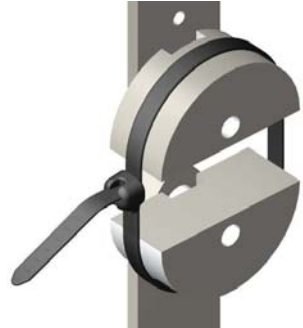
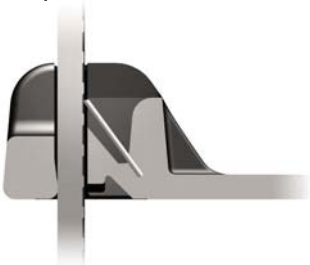

High loop tensile strength exceeds industry standards

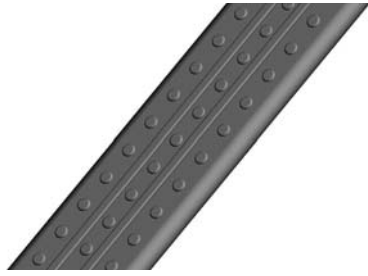

Ribbed and stippled strap body prevents lateral movement on the bundle

Curved tip threads easily and installs faster

Finger grip ensures positive grip during threading of tie



Cable tie tools speed installation and reduce total installed cost. See pages B1.109 – B1.114.



Cable tie accessories are used to speed and simplify the mounting of wires, cables, and tubing. See pages B2.1 – B2.29.

A. System Overview

B1. Cable Ties

B2. Cable Accessories

B3. Stainless Steel Ties

C1. Wiring Duct

C2. Surface Raceway

C3. Abrasion Protection

C4. Cable Management

D1. Terminals

D2. Power Connectors

D3. Grounding Connectors

E1. Labeling Systems

E2. Labels

E3. Pre-Printed & Write-On Markers

E4. Permanent Identification

E5. Lockout/Tagout & Safety Solutions

F. Index

A. System Overview

## Selection Guide – Dome-Top® Barb Ty and Dura-Ty™ Cable Ties

B1. Cable Ties



B2. Cable Accessories

B3. Stainless Steel Ties

C1. Wiring Duct

C2. Surface Raceway

C3. Abrasion Protection

C4. Cable Management

D1. Terminals

D2. Power Connectors

D3. Grounding Connectors

E1. Labeling Systems

E2. Labels

E3. Pre-Printed & Write-On Markers

E4. Permanent Identification

E5. Lockout/Tagout & Safety Solutions

F. Index

### Dome-Top® Barb Ty Cable Ties

Material, Color (Suffix)	Style/Function	Part Number Prefix	Catalog Page
Nylon 6.6, Natural (No Suffix)	Locking Ties/Bundle	BT	B1.45
	Clamp Ties/Mount	BC	B1.48
	Push Mount Ties/Mount	BW	B1.50
	Marker Ties/Identify	BF, BM, B2M, B3M, B4M	B1.52
Weather Resistant Nylon 6.6, Black (0)	Locking Ties/Bundle	BT	B1.46
	Clamp Ties/Mount	BC	B1.49
	Push Mount Ties/Mount	BW, BP	B1.50,51
	Marker Ties/Identify	BF, BM, B2M, B3M, B4M	B1.52
Heat Stabilized Nylon 6.6, Black (30)	Locking Ties/Bundle	BT	B1.47
	Clamp Ties/Mount	BC	B1.49
Heat Stabilized Nylon 6.6, Natural (39)	Locking Ties/Bundle	BT	B1.47

### Dura-Ty™ Cable Ties, Strapping, and Kits

Weather Resistant Acetal, Black	Locking Ties/Bundle	DT	B1.53
---------------------------------	---------------------	----	-------

## Part Number System for Dome-Top® Barb Ty and Dura-Ty™ Cable Ties

<b>BT</b>	<b>2</b>	<b>S</b>	<b>—</b>	<b>C</b>	<b>T</b>
Type	Size	Cross Section	Screw Hole Size	Package Size	Material/Color
BT = Locking Tie BC = Clamp Tie BF = Flag Tie BM = Marker Tie BP = Push Mount Tie BW = Wing Push Mount Tie DT = Locking Tie	Approx. Maximum Bundle Dia. (In.)	M = Miniature I = Intermediate S = Standard LH = Light-Heavy H = Heavy EH = Extra-Heavy	(Clamp Ties Only) -S4 = #4 (M2.5) -S6 = #6 (M3) -S8 = #8 (M4) -S10 = #10 (M5) -S25 = 1/4 (M6)	Q = 25 L = 50 C = 100 TL = 250 D = 500 M = 1000 LR = 50' Reel	See Page B1.54



## Dome-Top® Barb Ty Cable Ties – Nylon 6.6

- For indoor use
- Dome-top head features unique patented design with round, smooth edges
- Stainless steel locking barb provides consistent performance, reliability, and infinite adjustability through entire bundle range

- High strength and low thread force
- A variety of materials and colors are available for specific applications
- Curved tip is easy to pick up from flat surfaces and allows faster initial threading to speed installation
- UL Listed for use in plenum or air handling spaces per NEC

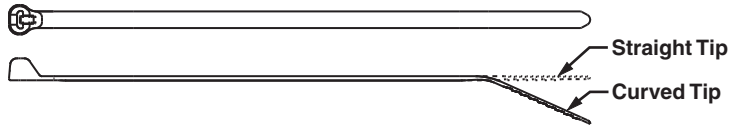

Part Number	Length		Width		Thickness		Max. Bundle Dia.		Min. Loop Tensile Str.		Recommended Installation Tool	Std. Pkg. Qty.	Std. Ctn. Qty.
	In.	mm	In.	mm	In.	mm	In.	mm	Lbs.	N			

### Miniature Cross Section – Plenum-Rated

<b>BT1M-C</b>	4.0	102	.095	2.4	.036	.9	.90	23	18	80	GTS, GTSL, GS2B, PTS, PPTS, STS2	100	1000
<b>BT1.5M-C</b>	6.3	160	.095	2.4	.046	1.2	1.50	38	18	80		100	1000
<b>BT2M-C</b>	7.9	201	.095	2.4	.046	1.2	2.00	51	18	80		100	1000
<b>BT4M-C</b>	14.2	361	.095	2.4	.046	1.2	4.00	102	18	80		100	1000

### Intermediate Cross Section – Plenum-Rated

<b>BT1.5I-C</b>	6.1	155	.141	3.6	.041	1.0	1.50	38	40	178	GTS, GTSL, GS2B, PTS, PPTS, STS2	100	1000
<b>BT2I-C</b>	8.0	203	.141	3.6	.041	1.0	2.00	51	40	178		100	1000
<b>BT3I-C</b>	11.3	287	.141	3.6	.049	1.2	3.00	76	40	178		100	1000
<b>BT4I-C</b>	14.3	363	.141	3.6	.049	1.2	4.00	102	40	178		100	1000

### Standard Cross Section – Plenum-Rated

<b>BT2S-C</b>	8.0	203	.185	4.7	.045	1.1	2.00	51	50	222	GTS, GTSL, GS2B, GTH, GS4H, PTS, PTH, PPTS, STS2, STH2	100	1000
<b>BT3S-C</b>	12.0	305	.185	4.7	.052	1.3	3.00	76	50	222		100	1000
<b>BT4S-C</b>	15.1	384	.185	4.7	.052	1.3	4.00	102	50	222		100	1000

### Light-Heavy Cross Section (Straight Tip) – Plenum-Rated

<b>BT2LH-L</b>	8.7	221	.275	7.0	.065	1.7	2.00	51	120	534	GTH, GS4H, GS4EH, PTH, STH2, ST3EH	50	500
<b>BT3LH-L</b>	11.8	300	.275	7.0	.065	1.7	3.00	76	120	534		50	500
<b>BT4LH-L</b>	14.9	378	.275	7.0	.065	1.7	4.00	102	120	534		50	500
<b>BT5LH-L</b>	18.1	460	.275	7.0	.065	1.7	5.00	127	120	534		50	500
<b>BT6LH-L</b>	21.2	538	.275	7.0	.065	1.7	6.00	152	120	534		50	500
<b>BT7LH-L</b>	24.4	620	.275	7.0	.065	1.7	7.00	178	120	534		50	500
<b>BT8LH-L</b>	27.5	699	.275	7.0	.065	1.7	8.00	203	120	534		50	500
<b>BT9LH-L</b>	30.7	780	.275	7.0	.065	1.7	9.00	229	120	534		50	500

A. System Overview

**UL** **UL** **CSA** **Dome-Top® Barb Ty Cable Ties – Weather Resistant Nylon 6.6**

B1. Cable Ties

- Greater resistance to damage caused by ultraviolet light – indoor or outdoor use
- Dome-top head features unique patented design with round, smooth edges

- Stainless steel locking barb provides consistent performance, reliability, and infinite adjustability through entire bundle range
- High strength and low thread force
- Curved tip is easy to pick up from flat surfaces and allows faster initial threading to speed installation

B2. Cable Accessories



B3. Stainless Steel Ties



C1. Wiring Duct

C2. Surface Raceway

Part Number	Length		Width		Thickness		Max. Bundle Dia.		Min. Loop Tensile Str.		Recommended Installation Tool	Std. Pkg. Qty.	Std. Ctn. Qty.
	In.	mm	In.	mm	In.	mm	In.	mm	Lbs.	N			

C3. Abrasion Protection

Miniature Cross Section													
<b>BT1M-C0</b>	4.0	102	.095	2.4	.036	.9	.90	23	18	80	GTS, GTSL, GS2B, PTS, PPTS, STS2	100	1000
<b>BT1.5M-C0</b>	6.3	160	.095	2.4	.046	1.2	1.50	38	18	80		100	1000
<b>BT2M-C0</b>	7.9	201	.095	2.4	.046	1.2	2.00	51	18	80		100	1000
<b>BT4M-C0</b>	14.2	361	.095	2.4	.046	1.2	4.00	102	18	80		100	1000

C4. Cable Management

Intermediate Cross Section													
<b>BT1.5I-C0</b>	6.1	155	.141	3.6	.041	1.0	1.50	38	40	178	GTS, GTSL, GS2B, PTS, PPTS, STS2	100	1000
<b>BT2I-C0</b>	8.0	203	.141	3.6	.041	1.0	2.00	51	40	178		100	1000
<b>BT3I-C0</b>	11.3	287	.141	3.6	.049	1.2	3.00	76	40	178		100	1000
<b>BT4I-C0</b>	14.3	363	.141	3.6	.049	1.2	4.00	102	40	178		100	1000

D1. Terminals

Standard Cross Section													
<b>BT2S-C0</b>	8.0	203	.185	4.7	.045	1.1	2.00	51	50	222	GTS, GTSL, GS2B, GTH, GS4H, PTS, PTH, PPTS, STS2, STH2	100	1000
<b>BT3S-C0</b>	12.0	305	.185	4.7	.052	1.3	3.00	76	50	222		100	1000
<b>BT4S-C0</b>	15.1	384	.185	4.7	.052	1.3	4.00	102	50	222		100	1000

D2. Power Connectors

D3. Grounding Connectors

Light-Heavy Cross Section (Straight Tip)													
<b>BT2LH-L0</b>	8.7	221	.275	7.0	.065	1.7	2.00	51	120	534	GTH, GS4H, GS4EH, PTH, STH2, ST3EH	50	500
<b>BT3LH-L0</b>	11.8	300	.275	7.0	.065	1.7	3.00	76	120	534		50	500
<b>BT4LH-L0</b>	14.9	378	.275	7.0	.065	1.7	4.00	102	120	534		50	500
<b>BT5LH-L0</b>	18.1	460	.275	7.0	.065	1.7	5.00	127	120	534		50	500
<b>BT6LH-L0</b>	21.2	538	.275	7.0	.065	1.7	6.00	152	120	534		50	500
<b>BT7LH-L0</b>	24.4	620	.275	7.0	.065	1.7	7.00	178	120	534		50	500
<b>BT8LH-L0</b>	27.5	699	.275	7.0	.065	1.7	8.00	203	120	534		50	500
<b>BT9LH-L0</b>	30.7	780	.275	7.0	.065	1.7	9.00	229	120	534		50	500

E1. Labeling Systems

E2. Labels

E3. Pre-Printed & Write-On Markers

E4. Permanent Identification

E5. Lockout/Tagout & Safety Solutions

F. Index

Note: UL Recognized, UL Listed, and CSA Certified, except LH cross section.



## Dome-Top® Barb Ty Cable Ties – Heat Stabilized Nylon 6.6

- For high temperature applications up to 239°F (115°C) – indoor use
- Dome-top head features unique patented design with round, smooth edges

- Stainless steel locking barb provides consistent performance, reliability, and infinite adjustability through entire bundle range
- Curved tip is easy to pick up from flat surfaces and allows faster initial threading to speed installation



BT2S-M30



BT2S-M39

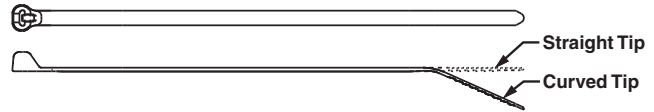

Part Number	Length		Width		Thickness		Max. Bundle Dia.		Min. Loop Tensile Str.		Recommended Installation Tool	Std. Pkg. Qty.	Std. Ctn. Qty.
	In.	mm	In.	mm	In.	mm	In.	mm	Lbs.	N			

### Heat Stabilized Nylon 6.6 – Black

#### Miniature Cross Section

BT1M-C30	4.0	102	.095	2.4	.036	.9	.90	23	18	80	GTS, GTSL, GS2B, PTS, PPTS, STS2	100	1000
BT1.5M-M30	6.3	160	.095	2.4	.046	1.2	1.50	38	18	80		1000	50000
BT2M-M30	7.9	201	.095	2.4	.046	1.2	2.00	51	18	80		1000	25000

#### Intermediate Cross Section

BT1.5I-M30	6.1	155	.141	3.6	.041	1.0	1.50	38	40	178	GTS, GTSL, GS2B, PTS, PPTS, STS2	1000	25000
BT2I-M30	8.0	203	.141	3.6	.041	1.0	2.00	51	40	178		1000	25000
BT3I-M30	11.3	287	.141	3.6	.049	1.2	3.00	76	40	178		1000	10000

#### Standard Cross Section

BT2S-M30	8.0	203	.185	4.7	.045	1.1	2.00	51	50	222	GTS, GTSL, GS2B, GTS, GS4H, PTS, PTH, PPTS, STS2, STH2	1000	10000
BT3S-M30	12.0	305	.185	4.7	.052	1.3	3.00	76	50	222		1000	10000
BT4S-M30	15.1	384	.185	4.7	.052	1.3	4.00	102	50	222		1000	5000

#### Light-Heavy Cross Section (Straight Tip)

BT4LH-TL30	14.9	378	.275	7.0	.065	1.7	4.00	102	120	534	GTH, GS4H, GS4EH, PTH, STH2, ST3EH	250	2500
------------	------	-----	------	-----	------	-----	------	-----	-----	-----	------------------------------------	-----	------

### Heat Stabilized Nylon 6.6 – Natural

#### Miniature Cross Section

BT1M-M39	4.0	102	.095	2.4	.036	.9	.90	23	18	80	GTS, GTSL, GS2B, PTS, PPTS, STS2	1000	50000
----------	-----	-----	------	-----	------	----	-----	----	----	----	----------------------------------	------	-------

#### Intermediate Cross Section

BT1.5I-M39	6.1	155	.141	3.6	.041	1.0	1.50	38	40	178	GTS, GTSL, GS2B, PTS, PPTS, STS2	1000	25000
------------	-----	-----	------	-----	------	-----	------	----	----	-----	----------------------------------	------	-------

#### Standard Cross Section

BT2S-M39	8.0	203	.185	4.7	.045	1.1	2.00	51	50	222	GTS, GTSL, GS2B, GTS, GS4H, PTS, PTH, PPTS, STS2, STH2	1000	10000
BT3S-M39	12.0	305	.185	4.7	.052	1.3	3.00	76	50	222		1000	10000
BT4S-M39	15.1	384	.185	4.7	.052	1.3	4.00	102	50	222		1000	5000

#### Light-Heavy Cross Section (Straight Tip)

BT4LH-TL39	14.9	378	.275	7.0	.065	1.7	4.00	102	120	534	GTH, GS4H, GS4EH, PTH, STH2, ST3EH	250	2500
------------	------	-----	------	-----	------	-----	------	-----	-----	-----	------------------------------------	-----	------

A. System Overview

B1. Cable Ties

B2. Cable Accessories

B3. Stainless Steel Ties

C1. Wiring Duct

C2. Surface Raceway

C3. Abrasion Protection

C4. Cable Management

D1. Terminals

D2. Power Connectors

D3. Grounding Connectors

E1. Labeling Systems

E2. Labels

E3. Pre-Printed & Write-On Markers

E4. Permanent Identification

E5. Lockout/Tagout & Safety Solutions

F. Index

A. System Overview



## Dome-Top® Barb Ty Clamp Ties – Nylon 6.6

B1. Cable Ties

- For indoor use
- Used to secure a cable bundle to another surface such as a control panel, communication rack, wall or ceiling
- Design allows for bundling before or after screwing clamp in place

- Stainless steel locking barb provides consistent performance, reliability, and infinite adjustability through entire bundle range
- Curved tip is easy to pick up from flat surfaces and allows faster initial threading to speed installation
- UL Listed for use in plenum or air handling spaces per NEC

B2. Cable Accessories

B3. Stainless Steel Ties

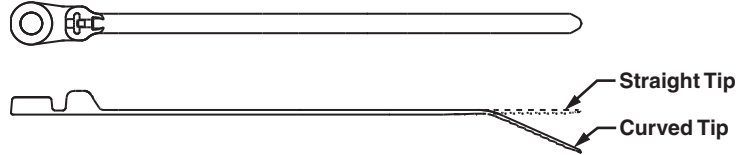
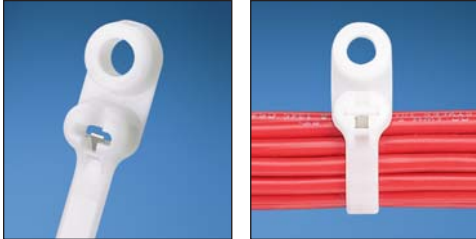

C1. Wiring Duct

C2. Surface Raceway

Part Number	Length		Width		Thickness		Nominal Hole Dia.		Screw Size	Metric Screw Size	Max. Bundle Dia.		Min. Loop Tensile Str.		Recommended Installation Tool	Std. Pkg. Qty.	Std. Ctn. Qty.
	In.	mm	In.	mm	In.	mm	In.	mm			In.	mm	Lbs.	N			

C3. Abrasion Protection

### Miniature Cross Section – Plenum-Rated

<b>BC1M-S4-M</b>	4.6	117	.095	2.4	.046	1.2	.122	3.1	#4	M2.5	.90	23	18	80	GTS, GTSL, GS2B, PTS, PPTS, STS2	1000	50000
<b>BC2M-S4-M</b>	8.3	211	.095	2.4	.046	1.2	.122	3.1	#4	M2.5	2.00	51	18	80		1000	25000

C4. Cable Management

### Intermediate Cross Section – Plenum-Rated

<b>BC1.5I-S8-M</b>	6.6	168	.141	3.6	.041	1.0	.174	4.4	#8	M4	1.50	38	40	178	GTS, GTSL, GS2B, PTS, PPTS, STS2	1000	25000
--------------------	-----	-----	------	-----	------	-----	------	-----	----	----	------	----	----	-----	----------------------------------	------	-------

D1. Terminals

### Standard Cross Section – Plenum-Rated

<b>BC2S-S10-C</b>	8.5	216	.185	4.7	.052	1.3	.200	5.1	#10	M5	2.00	51	50	222	GTS, GTSL, GS2B, GTH, GS4H, PTS, PTH, PPTS, STS2, STH2	100	1000
<b>BC3S-S10-D</b>	12.5	318	.185	4.7	.052	1.3	.200	5.1	#10	M5	3.00	76	50	222		500	5000
<b>BC4S-S10-C</b>	15.6	396	.185	4.7	.052	1.3	.200	5.1	#10	M5	4.00	102	50	222		100	1000

D2. Power Connectors

### Light-Heavy Cross Section (Straight Tip) – Plenum-Rated

<b>BC4LH-S25-L</b>	15.5	394	.275	7.0	.065	1.7	.260	6.6	1/4	M6	4.00	102	120	534	GTH, GS4H, GS4EH, PTH, STH2, ST3EH	50	500
--------------------	------	-----	------	-----	------	-----	------	-----	-----	----	------	-----	-----	-----	------------------------------------	----	-----

D3. Grounding Connectors

E1. Labeling Systems

E2. Labels

E3. Pre-Printed & Write-On Markers

E4. Permanent Identification

E5. Lockout/Tagout & Safety Solutions

F. Index



## Dome-Top® Barb Ty Clamp Ties – Weather Resistant and Heat Stabilized Nylon 6.6

- Weather Resistant material has greater resistance to damage caused by ultraviolet light – indoor or outdoor use
- Heat stabilized material for high temperature applications up to 239°F (115°C) – indoor use
- Used to secure a cable bundle to another surface such as a control panel, communication rack, wall or ceiling

- Design allows for bundling before or after screwing clamp in place
- Stainless steel locking barb provides consistent performance, reliability, and infinite adjustability through entire bundle range
- Curved tip is easy to pick up from flat surfaces and allows faster initial threading to speed installation

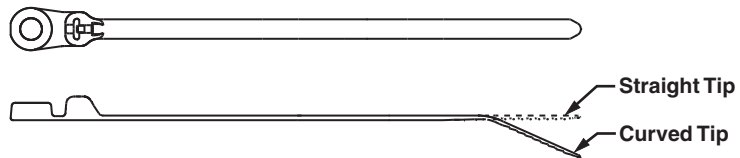

Part Number	Length		Width		Thickness		Nominal Hole Dia.		Screw Size	Metric Screw Size	Max. Bundle Dia.		Min. Loop Tensile Str.		Recommended Installation Tool	Std. Pkg. Qty.	Std. Ctn. Qty.
	In.	mm	In.	mm	In.	mm	In.	mm			In.	mm	Lbs.	N			

### Weather Resistant Nylon 6.6

#### Miniature Cross Section

BC1M-S4-M0	4.6	117	.095	2.4	.046	1.2	.122	3.1	#4	M2.5	.90	23	18	80	GTS, GTSL, GS2B, PTS, PPTS, STS2	1000	50000
BC2M-S4-M0	8.3	211	.095	2.4	.046	1.2	.122	3.1	#4	M2.5	2.00	51	18	80		1000	25000

#### Intermediate Cross Section

BC1.5I-S8-M0	6.6	168	.141	3.6	.041	1.0	.174	4.4	#8	M4	1.50	38	40	178	GTS, GTSL, GS2B, PTS, PPTS, STS2	1000	25000
--------------	-----	-----	------	-----	------	-----	------	-----	----	----	------	----	----	-----	----------------------------------	------	-------

#### Standard Cross Section

BC2S-S10-C0	8.5	216	.185	4.7	.052	1.3	.200	5.1	#10	M5	2.00	51	50	222	GTS, GTSL, GS2B, GTH, GS4H, PTS, PTH, PPTS, STS2, STH2	100	1000
BC3S-S10-D0	12.5	318	.185	4.7	.052	1.3	.200	5.1	#10	M5	3.00	76	50	222		500	5000
BC4S-S10-C0	15.6	396	.185	4.7	.052	1.3	.200	5.1	#10	M5	4.00	102	50	222		100	1000

#### Light-Heavy Cross Section (Straight Tip)

BC4LH-S25-L0	15.5	394	.275	7.0	.065	1.7	.260	6.6	1/4	M6	4.00	102	120	534	GTH, GS4H, GS4EH, PTH, STH2, ST3EH	50	500
--------------	------	-----	------	-----	------	-----	------	-----	-----	----	------	-----	-----	-----	------------------------------------	----	-----

### Heat Stabilized Nylon 6.6

#### Standard Cross Section

BC4S-S10-D30	15.6	396	.185	4.7	.052	1.3	.200	5.1	#10	M5	4.00	102	50	222	GTS, GTSL, GS2B, GTH, GS4H, PTS, PTH, PPTS, STH2, STS2	500	5000
--------------	------	-----	------	-----	------	-----	------	-----	-----	----	------	-----	----	-----	--	-----	------

Note: UL Recognized and CSA Certified except BC4LH-S25-L0.

A.  
System  
Overview

B1.  
Cable Ties

B2.  
Cable  
Accessories

B3.  
Stainless  
Steel Ties

C1.  
Wiring  
Duct

C2.  
Surface  
Raceway

C3.  
Abrasion  
Protection

C4.  
Cable  
Management

D1.  
Terminals

D2.  
Power  
Connectors

D3.  
Grounding  
Connectors

E1.  
Labeling  
Systems

E2.  
Labels

E3.  
Pre-Printed  
& Write-On  
Markers

E4.  
Permanent  
Identification

E5.  
Lockout/  
Tagout  
& Safety  
Solutions

F.  
Index

A. System Overview



## Dome-Top® Barb Ty Wing Push Mount Ties – Nylon and Weather Resistant Nylon 6.6

B1. Cable Ties

- Natural nylon material for indoor use
- Weather resistant material has greater resistance to damage caused by ultraviolet light – indoor or outdoor use
- Combine cable tie, mount, and fastener into a single part
- Used to attach bundles to another surface such as a flat panel
- Anchor is easily pressed into a pre-formed hole and locks in place

- Wings provide constant tension for a stable, secure, and rattle-free installation
- Stainless steel locking barb provides consistent performance, reliability, and infinite adjustability through entire bundle range
- Curved tip is easy to pick up from flat surfaces and allows faster initial threading to speed installation

B2. Cable Accessories

B3. Stainless Steel Ties



BW2S-D

BW2S-D0

C1. Wiring Duct

C2. Surface Raceway

C3. Abrasion Protection

C4. Cable Management

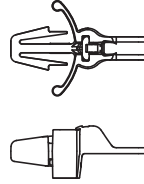
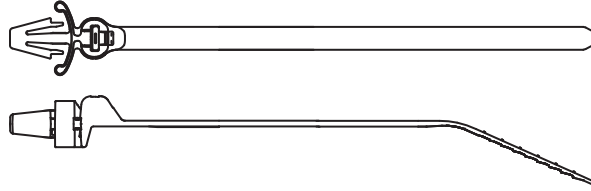
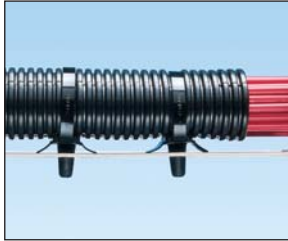

BW2S Head Design

D1. Terminals

D2. Power Connectors

D3. Grounding Connectors

E1. Labeling Systems

E2. Labels

E3. Pre-Printed & Write-On Markers

E4. Permanent Identification

E5. Lockout/Tagout & Safety Solutions

F. Index

Part Number	Length		Width		Thickness		Nominal Hole Dia.		Max. Panel Thickness		Max. Bundle Dia.		Min. Loop Tensile Str.		Recommended Installation Tool	Std. Pkg. Qty.	Std. Ctn. Qty.
	In.	mm	In.	mm	In.	mm	In.	mm	In.	mm	In.	mm	Lbs.	N			

### Nylon 6.6

#### Intermediate Cross Section

<b>BW1.5I-D</b>	6.6	168	.141	3.6	.041	1.0	.187	4.7	.093	2.4	1.50	38	40	178	GTS, GTSL, GS2B, PTS, PPTS, STS2	500	5000
-----------------	-----	-----	------	-----	------	-----	------	-----	------	-----	------	----	----	-----	----------------------------------	-----	------

#### Standard Cross Section

<b>BW2S-D</b>	8.5	216	.185	4.7	.052	1.3	.250	6.4	.156	4.0	2.00	51	50	222	GTS, GTSL, GS2B, GTH, GS4H, PTS, PTH, PPTS, STS2, STH2	500	5000
<b>BW3S-D</b>	12.5	318	.185	4.7	.052	1.3	.250	6.4	.156	4.0	3.00	76	50	222		500	5000

### Weather Resistant Nylon 6.6

#### Standard Cross Section

<b>BW2S-D0</b>	8.5	216	.185	4.7	.052	1.3	.250	6.4	.156	4.0	2.00	51	50	222	GTS, GTSL, GS2B, GTH, GS4H, PTS, PTH, PPTS, STS2, STH2	500	5000
<b>BW3S-D0</b>	12.5	318	.185	4.7	.052	1.3	.250	6.4	.156	4.0	3.00	76	50	222		500	5000



## UL US CS Dome-Top® Barb Ty Push Mount Ties – Weather Resistant Nylon 6.6

- Greater resistance to damage caused by ultraviolet light – indoor or outdoor use
- Used to attach bundles to another surface such as a flat panel
- Cable tie, mount, and fastener in a single part
- Anchor is easily pressed into a pre-formed hole and locks in place

- *Wingless* design allows tie to be used in confined spaces
- Stainless steel locking barb provides consistent performance, reliability, and infinite adjustability through entire bundle range
- Curved tip is easy to pick up from flat surfaces and allows faster initial threading to speed installation

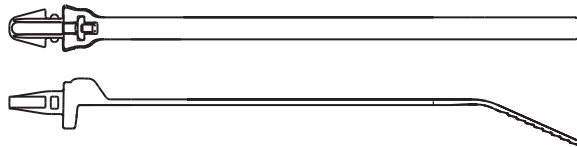
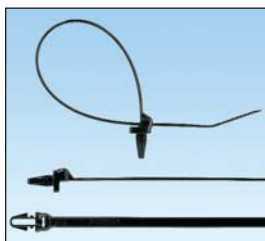

Part Number	Length		Width		Thickness		Nominal Hole Dia.		Max. Panel Thickness		Max. Bundle Dia.		Min. Loop Tensile Str.		Recommended Installation Tool	Std. Pkg. Qty.	Std. Ctn. Qty.
	In.	mm	In.	mm	In.	mm	In.	mm	In.	mm	In.	mm	Lbs.	N			
<b>Standard Cross Section</b>																	
BP2S-D0	8.5	216	.185	4.7	.052	1.3	.255	6.5	.125	3.2	2.00	51	50	222	GTS, GTSL, GS2B, GTH, GS4H, PTS, PTH, PPTS, STS2, STH2	500	5000

## Permanent Marking Pens

- Fast drying, permanent ink for identification on marker ties (pages B1.34, B1.52, and B1.71), marker plates (page B2.29), or cable marker straps (page B1.80)
- May be used with any label shown in the catalog when a printer is not available



PX-0  
PX-2



PFX-0  
PFX-2



PX-10

Part Number	Color	Description	Std. Pkg. Qty.	Std. Ctn. Qty.
PX-0	Black	Permanent marking pen – regular tip.	12	144
PX-2	Red	Permanent marking pen – regular tip.	12	144
PFX-0	Black	Permanent marking pen – fine tip.	12	144
PFX-2	Red	Permanent marking pen – fine tip.	12	144
PX-10	White	Marking pen for black or other dark colored parts – regular tip.	12	300

A.  
System  
Overview

B1.  
Cable Ties

B2.  
Cable  
Accessories

B3.  
Stainless  
Steel Ties

C1.  
Wiring  
Duct

C2.  
Surface  
Raceway

C3.  
Abrasion  
Protection

C4.  
Cable  
Management

D1.  
Terminals

D2.  
Power  
Connectors

D3.  
Grounding  
Connectors

E1.  
Labeling  
Systems

E2.  
Labels

E3.  
Pre-Printed  
& Write-On  
Markers

E4.  
Permanent  
Identification

E5.  
Lockout/  
Tagout/  
& Safety  
Solutions

F.  
Index

A. System Overview

## UL® US CS® Dome-Top® Barb Ty Marker and Flag Ties

- Natural nylon material for indoor use
- Weather resistant material has greater resistance to damage caused by ultraviolet light – indoor or outdoor use
- Used to fasten and identify bundles at the same time
- Stainless steel locking barb provides consistent performance, reliability, and infinite adjustability through entire bundle range
- Can be marked with Panduit marker pens on the previous page or computer printable labels
- Custom imprinting with text, symbols, or trademarks available using Panduit Custom Hot Stamping Service, see page B1.93
- Curved tip is easy to pick up from flat surfaces and allows faster initial threading to speed installation

B1. Cable Ties

B2. Cable Accessories

B3. Stainless Steel Ties

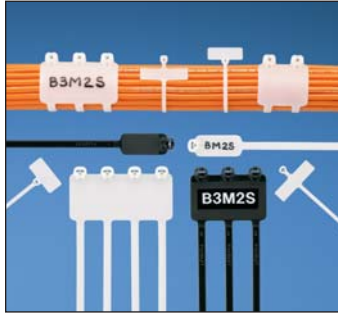

C1. Wiring Duct

C2. Surface Raceway

C3. Abrasion Protection

Part Number	Marker Type	Length		Width		Thickness		Marker Write-On Area		Max. Bundle Dia.		Min. Loop Tensile Str.		Recommended Installation Tool	Std. Pkg. Qty.	Std. Ctn. Qty.
		In.	mm	In.	mm	In.	mm	In.	mm	In.	mm	Lbs.	N			

C4. Cable Management

### Nylon 6.6

#### Miniature Cross Section

<b>BF1M-C</b>	Flag	4.6	117	.095	2.4	.046	1.2	.36 x .81	9.1 x 20.6	.90	23	18	80	GTS, GTSL, GS2B, PTS, PPTS, STS2	100	1000
<b>BF2M-C</b>	Flag	8.3	211	.095	2.4	.046	1.2	.36 x .81	9.1 x 20.6	2.00	51	18	80		100	1000
<b>BM1M-C</b>	Wrap	4.2	107	.095	2.4	.046	1.2	.29 x 1.09	7.4 x 27.7	.90	23	18	80		100	1000
<b>BM2M-C</b>	Wrap	7.9	201	.095	2.4	.046	1.2	.29 x 1.09	7.4 x 27.7	2.00	51	18	80		100	1000

D1. Terminals

#### Standard Cross Section

<b>BM2S-C</b>	Wrap	8.0	203	.185	4.7	.045	1.2	.49 x .91	12.4 x 23.1	2.00	51	50	222	GTS, GTSL, GS2B, GTH, GS4H, PTS, PTH, PPTS, STS2, STH2	100	1000
<b>BM4S-C</b>	Wrap	15.1	384	.185	4.7	.052	1.3	.50 x 2.13	12.7 x 54.1	4.00	102	50	222		100	1000
<b>B2M2S-D</b>	Wrap	8.0	203	.185	4.7	.045	1.2	1.15 x .91	29.2 x 23.1	2.00	51	50	222		500	2500
<b>B3M2S-TL</b>	Wrap	8.0	203	.185	4.7	.045	1.2	1.81 x .91	46.0 x 23.1	2.00	51	50	222		250	2500
<b>B4M2S-TL</b>	Wrap	8.0	203	.185	4.7	.045	1.2	2.47 x .91	62.7 x 23.1	2.00	51	50	222		250	2500

D2. Power Connectors

D3. Grounding Connectors

### Weather Resistant Nylon 6.6

#### Miniature Cross Section

<b>BF1M-M0</b>	Flag	4.6	117	.095	2.4	.046	1.2	.36 x .81	9.1 x 20.6	.90	23	18	80	GTS, GTSL, GS2B, PTS, PPTS, STS2	1000	25000
<b>BF2M-M0</b>	Flag	8.3	211	.095	2.4	.046	1.2	.36 x .81	9.1 x 20.6	2.00	51	18	80		1000	25000
<b>BM1M-M0</b>	Wrap	4.2	107	.095	2.4	.046	1.2	.29 x 1.09	7.4 x 27.7	.90	23	18	80		1000	25000
<b>BM2M-M0</b>	Wrap	7.9	201	.095	2.4	.046	1.2	.29 x 1.09	7.4 x 27.7	2.00	51	18	80		1000	25000

E1. Labeling Systems

E2. Labels

#### Standard Cross Section

<b>BM2S-D0</b>	Wrap	8.0	203	.185	4.7	.045	1.2	.49 x .91	12.4 x 23.1	2.00	51	50	222	GTS, GTSL, GS2B, GTH, GS4H, PTS, PTH, PPTS, STS2, STH2	500	10000
<b>BM4S-D0</b>	Wrap	15.1	384	.185	4.7	.052	1.3	.50 x 2.13	12.7 x 54.1	4.00	102	50	222		500	5000
<b>B2M2S-D0</b>	Wrap	8.0	203	.185	4.7	.045	1.2	1.15 x .91	29.2 x 23.1	2.00	51	50	222		500	2500
<b>B3M2S-TL0</b>	Wrap	8.0	203	.185	4.7	.045	1.2	1.81 x .91	46.0 x 23.1	2.00	51	50	222		250	2500
<b>B4M2S-TL0</b>	Wrap	8.0	203	.185	4.7	.045	1.2	2.47 x .91	62.7 x 23.1	2.00	51	50	222		250	2500

E3. Pre-Printed & Write-On Markers

E4. Permanent Identification

E5. Lockout/Tagout & Safety Solutions

F. Index



## Dura-Ty™ Cable Ties – Weather Resistant Acetal – Heavy Cross Section

- Black acetal strap and head material provide 20+ years outdoor life and high impact resistance
- Excellent ultraviolet light, chemical, and moisture resistance

- Double stainless steel locking barbs provide consistent and predictable holding values
- Textured strap provides better gripping surface to prevent tie from moving laterally along the length of the bundle for tight, consistent bundles
- Robust head design allows tie to be tightened over a wide range of angles
- Convenient reel dispenser pack allows installer to cut-to-size for customized field applications; recyclable box has through-hole for attaching to belt, plus storage area for bag of heads
- Ideal for securing cables in outdoor messenger strand applications
- May be used with stackable aerial cable spacer on the next page



Part Number	Description	Strap Length		Strap Width		Min. Loop Tensile Str.		Head Height		Head Width		Recommended Installation Tool	Std. Pkg. Qty.	Std. Ctn. Qty.
		Ft.	m	In.	mm	Lbs.	N	In.	mm	In.	mm			
<b>Strapping, Heads, and Kit – Allows user to customize strap length</b>														
DTRH-LR0	50' reel of strapping.	50.0	15.2	.331	8.40	200	890	—	—	—	—	GTH, GS4EH, STH2, STHV, ST3EH	1	20
DTHH-Q0	25 cable tie heads.	—	—	—	—	—	—	.393	9.98	.557	14.15	—	25	500
DTKH-0	Kit: Strapping (50'), Heads (25)	50.0	15.2	.331	8.40	200	890	.393	9.98	.557	14.15	GTH, GS4EH, STH2, STHV, ST3EH	1	20

## Dura-Ty™ Cable Ties – Weather Resistant Acetal – Extra-Heavy Cross Section

- Black acetal strap and head material provide 20+ years outdoor life and high impact resistance
- Excellent ultraviolet light, chemical, and moisture resistance
- Double stainless steel locking barbs provide consistent and predictable holding values
- Ideal for securing cables in outdoor messenger strand applications
- Meets Telcordia TR-TSY-000789 industry guidelines for lashed cable supports

- Convenient reel dispenser pack allows installer to cut-to-size for customized field applications; recyclable box has through-hole for attaching to belt, plus storage area for bag of heads
- Several pre-cut sizes have lead-in style angled tips on pre-assembled straps for easy installation, even with gloved hands, to speed installation
- May be used with stackable aerial cable spacer on the next page



**Formula to determine amount of strapping required:**  
 Diameter (inches) x 3.14 + 4.5 inches  
 Diameter (mm) x 3.14 + 114mm

Part Number	Description	Strap Length		Strap Width		Min. Loop Tensile Str.		Head Height		Head Width		Recommended Installation Tool	Std. Pkg. Qty.	Std. Ctn. Qty.
		Ft.	m	In.	mm	Lbs.	N	In.	mm	In.	mm			
<b>Strapping, Heads, and Kit – Allows user to customize strap length</b>														
DTREH-LR0	50' reel of strapping.	50.0	15.2	.500	12.70	250	1112	—	—	—	—	GS4EH, ST3EH	1	20
DTHEH-Q0	25 cable tie heads.	—	—	—	—	—	—	.490	12.45	.718	18.24	—	25	500
DTKEH-0	Kit: Strapping (50'), Heads (25)	50.0	15.2	.500	12.70	250	1112	.490	12.45	.718	18.24	GS4EH, ST3EH	1	20

Part Number	Length		Width		Thickness	Head Height		Head Width		Max. Bundle Dia.		Min. Loop Tensile Strength		Recommended Installation Tool	Std. Pkg. Qty.	Std. Ctn. Qty.	
	In.	mm	In.	mm	In.	mm	In.	mm	In.	mm	Lbs.	N					
<b>Discrete Lengths – Speed installation</b>																	
DT4EH-L0	13.5	343	.500	12.70	.059	1.50	.490	12.45	.718	18.24	3.8	98	250	1112	GS4EH, ST3EH	50	1000
DT8EH-Q0	27.0	686	.500	12.70	.059	1.50	.490	12.45	.718	18.24	8.0	203	250	1112		25	500
DT14EH-L0	48.0	1219	.500	12.70	.059	1.50	.490	12.45	.718	18.24	14.0	355	250	1112		50	250
DT15EH-L0	53.0	1346	.500	12.70	.059	1.50	.490	12.45	.718	18.24	15.0	381	250	1112		50	250
DT28EH-C0	96.0	2438	.500	12.70	.059	1.50	.490	12.45	.718	18.24	28.0	711	250	1112		100	—
DT44EH-C0	144.0	3658	.500	12.70	.059	1.50	.490	12.45	.718	18.24	44.0	1117	250	1112		100	—

A.  
System  
Overview

## Stackable Aerial Cable Spacer – Weather Resistant Polypropylene

B1.  
Cable Ties

- Greater resistance to damage caused by ultraviolet light – indoor or outdoor use
- Each spacer snaps into another to increase spacer heights by 1/2" increments
- Designed for use in parallel or perpendicular applications
- For use with Dura-Ty™ Cable Ties shown on the previous page

B2.  
Cable  
Accessories

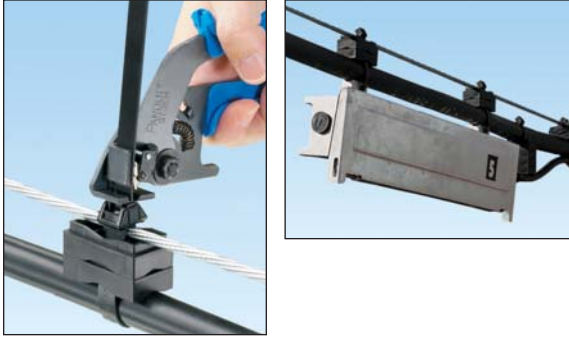

B3.  
Stainless  
Steel Ties

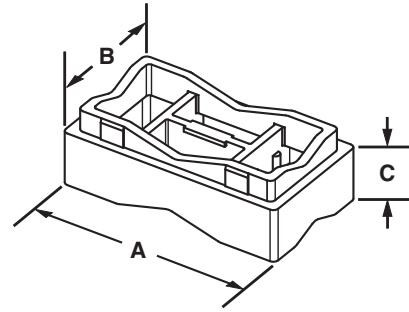

C1.  
Wiring  
Duct

C2.  
Surface  
Raceway

Part Number	Length A		Width B		Height C		Used with Cable Ties*	Std. Pkg. Qty.	Std. Ctn. Qty.
	In.	mm	In.	mm	In.	mm			
SACS50-T100	2.08	52.8	1.16	29.5	0.71	18.0	LH, H, EH	200	2000

\*Cable tie cross section sizes: LH = Light-Heavy, H = Heavy, and EH = Extra-Heavy.

C4.  
Cable  
Management

D1.  
Terminals

## Dome-Top® Barb Ty and Dura-Ty™ Cable Ties

D2.  
Power  
Connectors

### Material and Color Chart

D3.  
Grounding  
Connectors

Material	Color	Panduit Suffix
Nylon 6.6	Natural	✓
Weather Resistant Nylon 6.6	Black	0
Nylon 6.6	Brown	1
Nylon 6.6	Red	2
Nylon 6.6	Orange	3
Nylon 6.6	Yellow	4Y
Nylon 6.6	Green	5
Nylon 6.6	Blue	6

Material	Color	Panduit Suffix
Nylon 6.6	Purple	7
Nylon 6.6	Gray	8
Nylon 6.6	White	10
Nylon 6.6	Telephone Gray	14
Nylon 6.6	Black	20
Heat Stabilized Nylon 6.6	Black	30
Heat Stabilized Nylon 6.6	Natural	39
Flame Retardant Nylon 6.6	Natural (Ivory)	69
Weather Resistant Acetal	Black	*

✓ Denotes Panduit Natural Nylon 6.6 (no suffix).

\*Denotes Dura-Ty™ Weather Resistant Acetal material (no suffix).

E1.  
Labeling  
Systems

E2.  
Labels

E3.  
Pre-Printed  
& Write-On  
Markers

E4.  
Permanent  
Identification

E5.  
Lockout/  
Tagout/  
& Safety  
Solutions

F.  
Index

## Part Number Availability List

Standard Packaging			Bulk Packaging		
Part Number	Natural Nylon 6.6	Material/Color Suffix	Part Number	Natural Nylon 6.6	Material/Color Suffix
			BC1M-S4-M	✓	0
			BC2M-S4-M	✓	0
			BC1.5I-S8-M	✓	0
BC2S-S10-C	✓	0	BC2S-S10-D	✓	0
			BC3S-S10-D	✓	0
BC4S-S10-C	✓	0	BC4S-S10-D	✓	0,30
BC4LH-S25-L	✓	0	BC4LH-S25-TL	✓	0
BF1M-C	✓		BF1M-M	✓	0
BF2M-C	✓		BF2M-M	✓	0
BM1M-C	✓		BM1M-M	✓	0
BM2M-C	✓		BM2M-M	✓	0
BM2S-C	✓		BM2S-D	✓	0
BM4S-C	✓		BM4S-D	✓	0
			BP2S-D		0
BT1M-C	✓	0,30	BT1M-M	✓	0,1,2,3,4Y,5,6,7,8,10,30,39
			BT1M-XMR	✓	0,30
BT1.5M-C	✓	0	BT1.5M-M	✓	0,30
			BT1.5M-XMR	✓	0,30,69
BT2M-C	✓	0	BT2M-M	✓	0,2,3,4Y,5,6,8,30
BT4M-C	✓	0	BT4M-M	✓	0
BT1.5I-C	✓	0	BT1.5I-M	✓	0,1,2,3,4Y,5,6,7,8,10,30,39
BT2I-C	✓	0	BT2I-M	✓	0,30
BT3I-C	✓	0	BT3I-M	✓	0,14,30
BT4I-C	✓	0	BT4I-M	✓	0,14
BT2S-C	✓	0	BT2S-M	✓	0,1,2,3,4Y,5,6,7,8,10,20,30,39
BT3S-C	✓	0,2	BT3S-M	✓	0,30,39
BT4S-C	✓	0	BT4S-M	✓	0,2,3,4Y,5,6,7,8,10,30,39
BT2LH-L	✓	0	BT2LH-TL	✓	0
BT3LH-L	✓	0	BT3LH-TL	✓	0
BT4LH-L	✓	0	BT4LH-TL	✓	0,30,39
BT5LH-L	✓	0	BT5LH-C	✓	0
BT6LH-L	✓	0	BT6LH-C	✓	0
BT7LH-L	✓	0	BT7LH-C	✓	0
BT8LH-L	✓	0	BT8LH-C	✓	0
BT9LH-L	✓	0	BT9LH-C	✓	0
			BW1.5I-D	✓	
			BW2S-D	✓	0
			BW3S-D	✓	0
			B2M2S-D	✓	0
			B3M2S-TL	✓	0
			B4M2S-TL	✓	0

### Dura-Ty™ Cable Ties and Strapping

DTHEH-Q0, DTHH-Q0	*			
DTKEH-0, DTKH-0	*			
DTREH-LR0	*			
DTRH-LR0	*			
DT4EH-L0	*			
DT8EH-Q0	*			
DT14EH-L0	*		DT14EH-C0	*
DT15EH-L0	*			
DT28EH-C0	*			
DT44EH-C0	*			

\*Denotes Dura-Ty™ Weather Resistant Acetal material (no suffix).

A. System Overview

## Features and Benefits – Parallel-Entry Cable Ties

Parallel-entry cable ties limit exposure to sharp edges and protect workers' arms/hands. The ties are designed with a low profile head to avoid snags and reduce overall bundle size.

B1. Cable Ties

### Contour-Ty® Cable Ties

Fully enclosed head for consistent strength

Fully rounded edges on head and strap

Outside teeth and smooth round edges protect cable jacket – ideal for high vibration applications

Curved tip threads easily and installs faster

Rounded tip and aggressive grip for faster initial threading



### Hyper-V™ Cable Ties

Design provides for an optional threading position that allows releasable, temporary bundling

Fixed and flexible 2-wedge locking design

Tip bending serrations and threading hole facilitate installations in confined spaces



C1. Wiring Duct

C2. Surface Raceway

C3. Abrasion Protection

C4. Cable Management

D1. Terminals

D2. Power Connectors

D3. Grounding Connectors

E1. Labeling Systems

E2. Labels

E3. Pre-Printed & Write-On Markers

E4. Permanent Identification

E5. Lockout/Tagout & Safety Solutions

F. Index

### Belt-Ty™ In-Line Cable Ties



"Finger grip" shaped head assures positive grip while threading tie

Parallel-entry limits exposure to sharp edges and protects workers' arms/hands



### IN-LINE Cable Ties

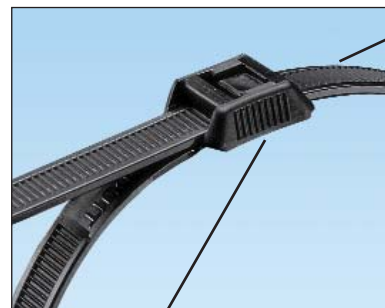

Outside teeth protect cable jacket and wire insulation

"Finger grip" shaped head with serrations assures positive grip while threading tie



Cable tie tools speed installation and reduce total installed cost. See pages B1.109 – B1.114.



Cable tie accessories are used to speed and simplify the mounting of wires, cables, and tubing. See pages B2.1 – B2.29.

## Selection Guide – Parallel-Entry Cable Ties

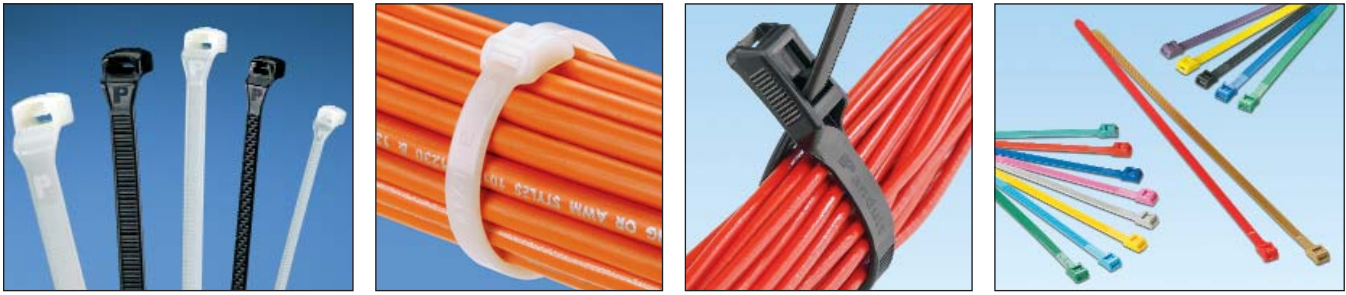

	Material, Color (Suffix)	Style/Function	Part Number Prefix	Catalog Page
<b>Contour-Ty® Cable Ties</b>	Nylon 6.6, Natural (No Suffix)	Locking Ties/Bundle	CBR	B1.58
	Weather Resistant Nylon 6.6, Black (0)	Locking Ties/Bundle	CBR	B1.59
	Heat Stabilized Nylon 6.6, Black (30)	Locking Ties/Bundle	CBR	B1.60
	Heat Stabilized Nylon 6.6, Natural (39)	Locking Ties/Bundle	CBR	B1.60
	Flame Retardant Nylon 6.6, Ivory (69)	Locking Ties/Bundle	CBR	B1.60
<b>Belt-Ty™ In-Line Cable Ties</b>	Nylon 6.6, Natural (No Suffix)	Locking Ties/Bundle	ILT	B1.61
	Weather Resistant Nylon 6.6, Black (0)	Locking Ties/Bundle	ILT	B1.61
<b>Hyper-V™ Cable Ties</b>	Weather Resistant Nylon 6.6, Black (0)	Locking Ties/Bundle	HV	B1.62
<b>IN-LINE Cable Ties</b>	Weather Resistant Nylon 6.6, Black (0 and colors)	Locking Ties/Bundle	IT	B1.63

### Part Number System for Contour-Ty® and Belt-Ty™ Cable Ties

<b>CBR</b>	<b>2</b>	<b>S</b>	—	<b>M</b>	—
Type	Size	Cross Section		Package Size	Material/Color
CBR = Locking Tie ILT = Locking Tie	Approx. Maximum Bundle Dia. (In.)	M = Miniature I = Intermediate S = Standard HS = Heavy-Standard LH = Light-Heavy		C = 100 TL = 250 D = 500 M = 1000	See page B1.64

### Part Number System for Hyper-V™ and IN-LINE Cable Ties

<b>HV</b>	<b>9</b>	<b>100</b>	—	<b>C</b>	—
Type	Width	Size		Package Size	Material/Color
HV= Locking Tie IT = Locking Tie	Approx. Width (mm)	Approx. Maximum Bundle Dia. (mm)		C = 100	See page B1.64

A. System Overview



## Contour-Ty® Cable Ties – Nylon 6.6

B1. Cable Ties

- For indoor use
- Unique design prevents wire and cable damage
- Low profile head avoids snags and reduces overall bundle size
- Outside teeth and smooth round edges protect cable jacket – ideal for high vibration applications
- Parallel-entry limits exposure to sharp edges and protects workers' arms/hands
- Fully enclosed head for consistent strength

- Curved tip is easy to pick up from flat surfaces and allows faster initial threading to speed installation
- UL Listed for use in plenum or air handling spaces per NEC

Note: Nylon 6.6 cable ties in natural and colors meet the testing requirements of the U.S. Military Aerospace Standard SAE-AS23190A and the dimensional requirements of Aerospace Standard SAE-AS33671

B2. Cable Accessories

B3. Stainless Steel Ties

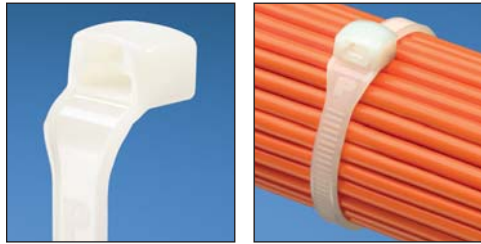

C1. Wiring Duct

C2. Surface Raceway

C3. Abrasion Protection

C4. Cable Management

D1. Terminals

D2. Power Connectors

D3. Grounding Connectors

E1. Labeling Systems

E2. Labels

E3. Pre-Printed & Write-On Markers

E4. Permanent Identification

E5. Lockout/Tagout & Safety Solutions

F. Index



Part Number	Length		Width		Thickness		Max. Bundle Dia.		Min. Loop Tensile Str.		Recommended Installation Tool	Std. Pkg. Qty.	Std. Ctn. Qty.
	In.	mm	In.	mm	In.	mm	In.	mm	Lbs.	N			
<b>Miniature Cross Section – Plenum-Rated</b>													
<b>CBR1M-M</b>	4.1	104	.098	2.5	.038	1.0	1.00	25	18	80	GTS, GTSL, GS2B, PTS, PPTS, STS2	1000	50000
<b>CBR1.5M-M</b>	5.6	142	.098	2.5	.042	1.1	1.50	38	18	80		1000	50000
<b>CBR2M-M</b>	7.2	183	.098	2.5	.042	1.1	2.00	51	18	80		1000	25000
<b>Intermediate Cross Section – Plenum-Rated</b>													
<b>CBR1.5I-M</b>	5.9	150	.140	3.6	.040	1.0	1.50	38	40	178	GTS, GTSL, GS2B, PTS, PPTS, STS2	1000	25000
<b>CBR3I-M</b>	10.4	264	.140	3.6	.052	1.3	3.00	76	40	178		1000	10000
<b>CBR4I-M</b>	13.6	345	.140	3.6	.052	1.3	4.00	102	40	178		1000	10000
<b>Standard Cross Section – Plenum-Rated</b>													
<b>CBR2S-M</b>	7.6	193	.190	4.8	.044	1.1	2.00	51	50	222	GTS, GTSL, GS2B, GTH, GS4H, PTS, PTH, PPTS, STS2, STH2	1000	10000
<b>CBR3S-M</b>	10.8	274	.190	4.8	.052	1.3	3.00	76	50	222		1000	5000
<b>CBR4S-M</b>	14.0	356	.190	4.8	.052	1.3	4.00	102	50	222		1000	5000
<b>Heavy-Standard Cross Section – Plenum-Rated</b>													
<b>CBR2HS-D</b>	8.0	203	.250	6.4	.058	1.4	2.00	51	85	378	GTH, GS4H, GS4EH, PTH, STH2, ST3EH	500	5000
<b>Light-Heavy Cross Section – Plenum-Rated</b>													
<b>CBR4LH-TL</b>	14.6	371	.300	7.6	.070	1.8	4.00	102	120	534	GTH, GS4H, GS4EH, PTH, STH2, ST3EH	250	2500
<b>CBR6LH-C</b>	20.9	531	.300	7.6	.070	1.8	6.00	152	120	534		100	2000





## Contour-Ty® Cable Ties – Weather Resistant Nylon 6.6

- Greater resistance to damage caused by ultraviolet light – indoor or outdoor use
- Unique design prevents wire and cable damage
- Low profile head avoids snags and reduces overall bundle size
- Outside teeth and smooth round edges protect cable jacket – ideal for high vibration applications

- Parallel-entry limits exposure to sharp edges and protects workers' arms/hands
- Fully enclosed head for consistent strength
- Curved tip is easy to pick up from flat surfaces and allows faster initial threading to speed installation

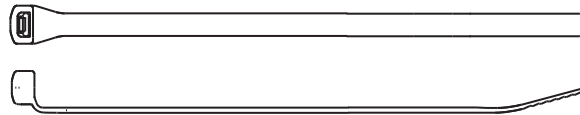

Part Number	Length		Width		Thickness		Max. Bundle Dia.		Min. Loop Tensile Str.		Recommended Installation Tool	Std. Pkg. Qty.	Std. Ctn. Qty.
	In.	mm	In.	mm	In.	mm	In.	mm	Lbs.	N			
<b>Miniature Cross Section</b>													
<b>CBR1M-M0</b>	4.1	104	.098	2.5	.038	1.0	1.00	25	18	80	GTS, GTSL, GS2B, PTS, PPTS, STS2	1000	50000
<b>CBR1.5M-M0</b>	5.6	142	.098	2.5	.042	1.1	1.50	38	18	80		1000	50000
<b>CBR2M-M0</b>	7.2	183	.098	2.5	.042	1.1	2.00	51	18	80		1000	25000
<b>Intermediate Cross Section</b>													
<b>CBR1.5I-M0</b>	5.9	150	.140	3.6	.040	1.0	1.50	38	40	178	GTS, GTSL, GS2B, PTS, PPTS, STS2	1000	25000
<b>CBR3I-M0</b>	10.4	264	.140	3.6	.052	1.3	3.00	76	40	178		1000	10000
<b>CBR4I-M0</b>	13.6	345	.140	3.6	.052	1.3	4.00	102	40	178		1000	10000
<b>Standard Cross Section</b>													
<b>CBR2S-M0</b>	7.6	193	.190	4.8	.044	1.1	2.00	51	50	222	GTS, GTSL, GS2B, GTH, GS4H, PTS, PTH, PPTS, STS2, STH2	1000	10000
<b>CBR3S-M0</b>	10.8	274	.190	4.8	.052	1.3	3.00	76	50	222		1000	5000
<b>CBR4S-M0</b>	14.0	356	.190	4.8	.052	1.3	4.00	102	50	222		1000	5000
<b>Heavy-Standard Cross Section</b>													
<b>CBR2HS-D0</b>	8.0	203	.250	6.4	.058	1.4	2.00	51	85	378	GTH, GS4H, GS4EH, PTH, STH2, ST3EH	500	5000
<b>Light-Heavy Cross Section</b>													
<b>CBR4LH-TL0</b>	14.6	371	.300	7.6	.070	1.8	4.00	102	120	534	GTH, GS4H, GS4EH, PTH, STH2, ST3EH	250	2500
<b>CBR6LH-C0</b>	20.9	531	.300	7.6	.070	1.8	6.00	152	120	534		100	2000

A. System Overview



## Contour-Ty® Cable Ties – Heat Stabilized and Flame Retardant Nylon 6.6

B1. Cable Ties

- Heat stabilized material for high temperature applications up to 239°F (115°C) – indoor use
- Flame retardant material has a flammability rating of UL 94V-0 – indoor use
- Unique design prevents wire and cable damage
- Low profile head avoids snags and reduces overall bundle size
- Outside teeth and smooth round edges protect cable jacket – ideal for high vibration applications
- Parallel-entry limits exposure to sharp edges and protects workers' arms/hands
- Fully enclosed head for consistent strength
- Curved tip is easy to pick up from flat surfaces and allows faster initial threading to speed installation

B2. Cable Accessories

B3. Stainless Steel Ties



CBR2S-M30



CBR2S-M39



CBR3S-M69

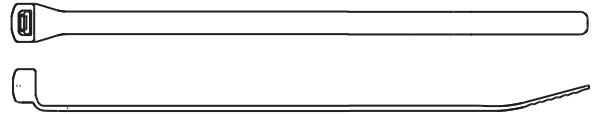

C1. Wiring Duct

C2. Surface Raceway

C3. Abrasion Protection

C4. Cable Management

D1. Terminals

D2. Power Connectors

D3. Grounding Connectors

E1. Labeling Systems

E2. Labels

E3. Pre-Printed & Write-On Markers

E4. Permanent Identification

E5. Lockout/Tagout & Safety Solutions

F. Index

Part Number	Length		Width		Thickness		Max. Bundle Dia.		Min. Loop Tensile Str.		Recommended Installation Tool	Std. Pkg. Qty.	Std. Ctn. Qty.
	In.	mm.	In.	mm	In.	mm	In.	mm	Lbs.	N			

### Heat Stabilized Nylon 6.6 – Black

#### Miniature Cross Section

<b>CBR1M-M30</b>	4.1	104	.098	2.5	.038	1.0	1.00	25	18	80	GTS, GTSL, GS2B, PTS, PPTS, STS2	1000	50000
------------------	-----	-----	------	-----	------	-----	------	----	----	----	----------------------------------	------	-------

#### Intermediate Cross Section

<b>CBR1.5I-M30</b>	5.9	150	.140	3.6	.040	1.0	1.50	38	40	178	GTS, GTSL, GS2B, PTS, PPTS, STS2	1000	25000
--------------------	-----	-----	------	-----	------	-----	------	----	----	-----	----------------------------------	------	-------

#### Standard Cross Section

<b>CBR2S-M30</b>	7.6	193	.190	4.8	.044	1.1	2.00	51	50	222	GTS, GTSL, GS2B, GTH, GS4H, PTS, PTH, PPTS, STS2, STH2	1000	10000
<b>CBR3S-M30</b>	10.8	274	.190	4.8	.052	1.3	3.00	76	50	222		1000	5000
<b>CBR4S-M30</b>	14.0	356	.190	4.8	.052	1.3	4.00	102	50	222		1000	5000

#### Light-Heavy Cross Section

<b>CBR4LH-TL30</b>	14.6	371	.300	7.6	.070	1.8	4.00	102	120	534	GTH, GS4H, GS4EH, PTH, STH2, ST3EH	250	2500
<b>CBR6LH-C30</b>	20.9	531	.300	7.6	.070	1.8	6.00	152	120	534		100	2000

### Heat Stabilized Nylon 6.6 – Natural

#### Standard Cross Section

<b>CBR2S-M39</b>	7.6	193	.190	4.8	.044	1.1	2.00	51	50	222	GTS, GTSL, GS2B, GTH, GS4H, PTS, PTH, PPTS, STS2, STH2	1000	10000
------------------	-----	-----	------	-----	------	-----	------	----	----	-----	--	------	-------

### Flame Retardant Nylon 6.6 – Natural Ivory

#### Standard Cross Section

<b>CBR3S-M69</b>	10.8	274	.190	4.8	.052	1.3	3.00	76	50	222	GTS, GTSL, GS2B, GTH, GS4H, PTS, PTH, PPTS, STS2, STH2	1000	5000
------------------	------	-----	------	-----	------	-----	------	----	----	-----	--	------	------

Note: UL Recognized, UL Listed, and CSA Certified, except CBR3S-M69.



## Belt-Ty™ In-Line Cable Ties – Nylon and Weather Resistant Nylon 6.6

- Natural nylon material for indoor use
- Weather resistant material has greater resistance to damage caused by ultraviolet light – indoor or outdoor use
- Parallel-entry cable tie that threads like a belt (180° entry)
- Low profile head avoids snags and reduces overall bundle size
- 35% lower head height than conventional 90° ties

- Parallel-entry limits exposure to sharp edges and protects workers' arms/hands
- Curved tip is easy to pick up from flat surfaces and allows faster initial threading to speed installation
- Nylon 6.6 cable ties are UL Listed for use in plenum or air handling spaces per NEC



ILT2S-C



ILT2S-C0

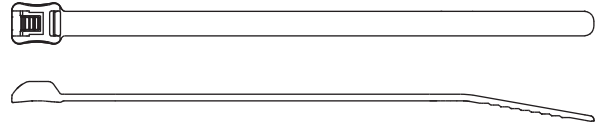

Part Number	Length		Width		Thickness		Max. Bundle Dia.		Min. Loop Tensile Str.		Recommended Installation Tool	Std. Pkg. Qty.	Std. Ctn. Qty.
	In.	mm	In.	mm	In.	mm	In.	mm	Lbs.	N			

### Nylon 6.6

#### Standard Cross Section – Plenum-Rated

ILT2S-C	8.3	211	.190	4.8	.052	1.3	1.88	48	50	222	GTS, GTSL, GS2B, GTH, GS4H, PTS, PTH, PPTS, STS2, STH2	100	1000
ILT3S-C	11.5	292	.190	4.8	.052	1.3	3.00	76	50	222		100	1000
ILT4S-C	14.7	373	.190	4.8	.052	1.3	4.00	102	50	222		100	1000

#### Light-Heavy Cross Section – Plenum-Rated

ILT4LH-TL	14.8	376	.300	7.6	.075	1.9	4.00	102	120	534	GTH, GS4H, GS4EH, PTH, STH2, ST3EH	250	2500
ILT6LH-C	21.2	538	.300	7.6	.075	1.9	6.00	152	120	534		100	2000

### Weather Resistant Nylon 6.6

#### Standard Cross Section

ILT2S-C0	8.3	211	.190	4.8	.052	1.3	1.88	48	50	222	GTS, GTSL, GS2B, GTH, GS4H, PTS, PTH, PPTS, STS2, STH2	100	1000
ILT3S-C0	11.5	292	.190	4.8	.052	1.3	3.00	76	50	222		100	1000
ILT4S-C0	14.7	373	.190	4.8	.052	1.3	4.00	102	50	222		100	1000

#### Light-Heavy Cross Section

ILT4LH-TL0	14.8	376	.300	7.6	.075	1.9	4.00	102	120	534	GTH, GS4H, GS4EH, PTH, STH2, ST3EH	250	2500
ILT6LH-C0	21.2	538	.300	7.6	.075	1.9	6.00	152	120	534		100	2000

Weather resistant nylon 6.6 cable ties are UL Recognized, UL Listed, and CSA Certified, except ILT4LH/6LH.

A. System Overview

B1. Cable Ties

B2. Cable Accessories

B3. Stainless Steel Ties

C1. Wiring Duct

C2. Surface Raceway

C3. Abrasion Protection

C4. Cable Management

D1. Terminals

D2. Power Connectors

D3. Grounding Connectors

E1. Labeling Systems

E2. Labels

E3. Pre-Printed & Write-On Markers

E4. Permanent Identification

E5. Lockout/Tagout & Safety Solutions

F. Index

A. System Overview

## Hyper-V™ In-Line Cable Ties – Weather Resistant Nylon 6.6

B1. Cable Ties

- Fixed and flexible two-wedge locking design provides a low threading force
- Teeth on both sides of cable tie body provide additional locking strength and improved flexibility to conform to irregular bundle shapes such as securing cables to cable tray systems
- Releasable head position for temporary bundling of cables prior to final locking; no need to replace ties when adding cables/wires to the bundle
- Teeth on full length of body support a wide range of bundle diameters
- Bending serrations on the tip of the tie allow the tip to be easily formed into an arc, enabling installer to “fish” the tie around the bundle in a confined space
- Threading hole in the tip of the tie allows an installer to hook the tip with a simple device to pull the tie through spaces with limited access
- In-Line tie design for parallel-entry of the tie into head resulting in a lower profile on cable bundles
- Complementary mounts shown below

B2. Cable Accessories

B3. Stainless Steel Ties

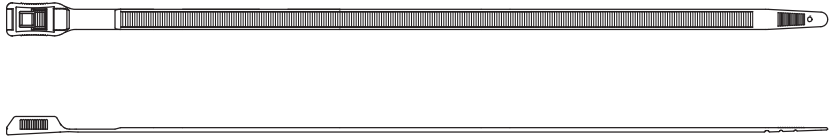

C1. Wiring Duct

C2. Surface Raceway

C3. Abrasion Protection

C4. Cable Management

Part Number	Length		Width		Thickness		Max. Bundle Dia.		Min. Loop Tensile Str.		Recommended Installation Tool	Std. Pkg. Qty.	Std. Ctn. Qty.
	In.	mm	In.	mm	In.	mm	In.	mm	Lbs.	N			
<b>HV965-C0</b>	10.4	265	.350	8.9	.076	1.9	2.60	65	160	710	GTH, GS4H, GS4EH, PTH, STH2, ST3EH, STHV	100	1000
<b>HV9100-C0</b>	14.4	367	.350	8.9	.076	1.9	3.90	100	160	710		100	1000
<b>HV9150-C0</b>	20.7	525	.350	8.9	.076	1.9	5.90	150	160	710		100	1000
<b>HV9250-C0</b>	33.1	841	.350	8.9	.076	1.9	9.80	250	160	710		100	1000

D1. Terminals

D2. Power Connectors

D3. Grounding Connectors

E1. Labeling Systems

E2. Labels

## Hyper-V™ Cable Tie Mounts

- Tie mount has retaining tab within window to hold cable tie in position when pre-installed in the mount; low profile design keeps bundle close to mounting surface
- Masonry mounts are used to secure wire, cable, or tubing to masonry surfaces
- For outdoor use



HVTM

HVMPM

E3. Pre-Printed & Write-On Markers

E4. Permanent Identification

E5. Lockout/Tagout & Safety Solutions

F. Index

Part Number	Material	Color	Mounting Method	Std. Pkg. Qty.	Std. Ctn. Qty.
<b>Tie Mounts</b>					
<b>HVTM3S10-C0</b>	Weather Resistant Nylon 6.6	Black	#10 (6mm) screw	100	500
<b>Masonry Mounts</b>					
<b>HVMPM32-C0</b>	Impact Modified Weather Resistant Nylon 6.6	Black	Tree barb for .31" (7.9mm) hole diameter	100	500

Note: UL Recognized except HVTM mount.

## IN-LINE Cable Ties – Weather Resistant Nylon 6.6

- Greater resistance to damage caused by ultraviolet light – indoor or outdoor use
- Parallel-entry cable tie that threads like a belt (180° entry)
- Wide tie body provides high tensile strength
- 50% lower head height than conventional 90° ties
- Parallel-entry limits exposure to sharp edges and protects workers' arms/hands
- Outside teeth protect cable jacket and wire insulation
- "Finger grip" shaped head with serrations assures positive grip while threading tie
- Install by hand or use Panduit GTH installation tool, see page B1.111
- Flexible – easy to handle and install
- Available in UV weather resistant colors for color coordination and UV stability

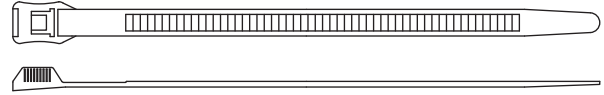

Part Number	Color	Length		Width		Thickness		Max. Bundle Dia.		Min. Loop Tensile Str.		Std. Pkg. Qty	Std. Ctn. Qty.
		In.	mm	In.	mm	In.	mm	In.	mm	Lbs.	N		
<b>Black Cable Ties</b>													
IT940-C0	UV Black	6.8	173	.350	8.9	.065	1.7	1.57	40	124	552	100	1000
IT965-C0	UV Black	10.1	257	.350	8.9	.065	1.7	2.56	65	124	552	100	1000
<b>IT9100-C0</b>	UV Black	14.1	358	.350	8.9	.065	1.7	3.94	100	124	552	100	1000
IT9115-C0	UV Black	15.3	389	.350	8.9	.065	1.7	4.53	115	124	552	100	1000
<b>Colored Cable Ties</b>													
IT9100-CUV2	UV Red	14.1	358	.350	8.9	.065	1.7	3.94	100	124	552	100	1000
IT9100-CUV4Y	UV Yellow	14.1	358	.350	8.9	.065	1.7	3.94	100	124	552	100	1000
IT9100-CUV6	UV Dark Blue	14.1	358	.350	8.9	.065	1.7	3.94	100	124	552	100	1000
IT9100-CUV6A	UV Light Blue	14.1	358	.350	8.9	.065	1.7	3.94	100	124	552	100	1000
IT9100-CUV7A	UV Purple	14.1	358	.350	8.9	.065	1.7	3.94	100	124	552	100	1000
IT9100-CUV8	UV Silver	14.1	358	.350	8.9	.065	1.7	3.94	100	124	552	100	1000
IT9100-CUV16B	UV Magenta	14.1	358	.350	8.9	.065	1.7	3.94	100	124	552	100	1000
IT9115-CUV2	UV Red	15.3	389	.350	8.9	.065	1.7	4.53	115	124	552	100	1000
IT9115-CUV2A	UV Bright Red	15.3	389	.350	8.9	.065	1.7	4.53	115	124	552	100	1000
IT9115-CUV4Y	UV Yellow	15.3	389	.350	8.9	.065	1.7	4.53	115	124	552	100	1000
IT9115-CUV4A	UV Butterscotch	15.3	389	.350	8.9	.065	1.7	4.53	115	124	552	100	1000
IT9115-CUV5A	UV Green	15.3	389	.350	8.9	.065	1.7	4.53	115	124	552	100	1000
IT9115-CUV5B	UV Hunter Green	15.3	389	.350	8.9	.065	1.7	4.53	115	124	552	100	1000
IT9115-CUV6	UV Dark Blue	15.3	389	.350	8.9	.065	1.7	4.53	115	124	552	100	1000
IT9115-CUV6A	UV Light Blue	15.3	389	.350	8.9	.065	1.7	4.53	115	124	552	100	1000
IT9115-CUV6B	UV Cobalt Blue	15.3	389	.350	8.9	.065	1.7	4.53	115	124	552	100	1000
IT9115-CUV7A	UV Purple	15.3	389	.350	8.9	.065	1.7	4.53	115	124	552	100	1000
IT9115-CUV8	UV Gray	15.3	389	.350	8.9	.065	1.7	4.53	115	124	552	100	1000
IT9115-CUV11	UV Teal	15.3	389	.350	8.9	.065	1.7	4.53	115	124	552	100	1000
IT9115-CUV16B	UV Magenta	15.3	389	.350	8.9	.065	1.7	4.53	115	124	552	100	1000
IT9115-CUV18	UV Tan	15.3	389	.350	8.9	.065	1.7	4.53	115	124	552	100	1000

A.  
System  
Overview

## Parallel-Entry Cable Ties

B1.  
Cable Ties

### Material and Color Chart

B2.  
Cable  
Accessories

B3.  
Stainless  
Steel Ties

C1.  
Wiring  
Duct

C2.  
Surface  
Raceway

C3.  
Abrasion  
Protection

C4.  
Cable  
Management

D1.  
Terminals

D2.  
Power  
Connectors

D3.  
Grounding  
Connectors

E1.  
Labeling  
Systems

E2.  
Labels

E3.  
Pre-Printed  
& Write-On  
Markers

E4.  
Permanent  
Identification

E5.  
Lockout/  
Tagout  
& Safety  
Solutions

F.  
Index

Material	Color	Panduit Suffix
Nylon 6.6	Natural	✓
Weather Resistant Nylon 6.6	Black	0
Nylon 6.6	Brown	1
Nylon 6.6	Red	2
Nylon 6.6	Orange	3
Nylon 6.6	Yellow	4Y
Nylon 6.6	Green	5
Nylon 6.6	Blue	6
Nylon 6.6	Purple	7
Nylon 6.6	Gray	8
Nylon 6.6	White	10
Heat Stabilized Nylon 6.6	Black	30
Heat Stabilized Nylon 6.6	Natural	39
Flame Retardant Nylon 6.6	Natural (Ivory)	69

Material	Color	Panduit Suffix
Nylon 6.6	Ultraviolet Red	UV2
Nylon 6.6	Ultraviolet Bright Red	UV2A
Nylon 6.6	Ultraviolet Yellow	UV4Y
Nylon 6.6	Ultraviolet Butterscotch	UV4A
Nylon 6.6	Ultraviolet Green	UV5A
Nylon 6.6	Ultraviolet Hunter Green	UV5B
Nylon 6.6	Ultraviolet Dark Blue	UV6
Nylon 6.6	Ultraviolet Light Blue	UV6A
Nylon 6.6	Ultraviolet Cobalt Blue	UV6B
Nylon 6.6	Ultraviolet Purple	UV7A
Nylon 6.6	Ultraviolet Gray	UV8
Nylon 6.6	Ultraviolet Teal	UV11
Nylon 6.6	Ultraviolet Magenta	UV16B
Nylon 6.6	Ultraviolet Tan	UV18

✓Denotes Panduit Natural Nylon 6.6 (no suffix).

### Part Number Availability List

Part Number	Standard Packaging		Part Number	Bulk Packaging	
	Natural Nylon 6.6	Material/Color (Suffix)		Natural Nylon 6.6	Material/Color (Suffix)
			CBR1M-M	✓	0,30
			CBR1.5M-M	✓	0
			CBR2M-M	✓	0,1,2,3,4Y,5,6,7
			CBR1.5I-M	✓	0,30
			CBR3I-M	✓	0,1,2,3,4Y,5,6,7,8,10
			CBR4I-M	✓	0
			CBR2S-M	✓	0,30,39
			CBR3S-M	✓	0,30,69
			CBR4S-M	✓	0,30
			CBR2HS-D	✓	0
			CBR4LH-TL	✓	0,30
			CBR6LH-C	✓	0,30
			HV965-C		0
			HV9100-C		0
			HV9150-C		0
			HV9250-C		0
ILT2S-C	✓	0	ILT2S-M	✓	0
ILT3S-C	✓	0	ILT3S-M	✓	0
ILT4S-C	✓	0	ILT4S-M	✓	0
			ILT4LH-TL	✓	0
			ILT6LH-C	✓	0
			IT940-C		0
			IT965-C		0
			IT9100-C		0,UV2,UV4Y,UV6,UV6A,UV7A,UV8,UV16B
			IT9115-C		0,UV2,UV2A,UV4Y,UV4A,UV5A,UV5B,UV6,UV6A,UV6B,UV7A,UV8,UV11,UV16B,UV18

## Features and Benefits – Sta-Strap® Cable Ties

Two-piece design incorporates a separate nylon head and strap.



Free floating head design results in tight bundles and low installed head height

High loop tensile strength exceeds industry standards

Two-piece design results in extremely low thread force

Thin tapered tip for easy installation

Design may be released prior to final tensioning



Cable tie tools speed installation and reduce total installed cost. See pages B1.109 – B1.114.



Cable tie accessories are used to speed and simplify the mounting of wires, cables, and tubing. See pages B2.1 – B2.29.

A. System Overview

B1. Cable Ties

B2. Cable Accessories

B3. Stainless Steel Ties

C1. Wiring Duct

C2. Surface Raceway

C3. Abrasion Protection

C4. Cable Management

D1. Terminals

D2. Power Connectors

D3. Grounding Connectors

E1. Labeling Systems

E2. Labels

E3. Pre-Printed & Write-On Markers

E4. Permanent Identification

E5. Lockout/Tagout & Safety Solutions

F. Index

A. System Overview

## Selection Guide – Sta-Strap® Cable Ties

B1. Cable Ties



B2. Cable Accessories

B3. Stainless Steel Ties

C1. Wiring Duct

Material, Color (Suffix)	Style/Function	Part Number Prefix	Catalog Page
Nylon 6.6, Natural (No Suffix)	Locking Ties/Bundle	SST	B1.67
	Clamp Ties/Mount	SSC	B1.70
	Marker Ties/Identify	SSM	B1.71

C2. Surface Raceway

C3. Abrasion Protection

Weather Resistant Nylon 6.6, Black (0)	Locking Ties/Bundle	SST	B1.68
	Clamp Ties/Mount	SSC	B1.70
	Marker Ties/Identify	SSM	B1.71

C4. Cable Management

Heat Stabilized Nylon 6.6, Black (30)	Locking Ties/Bundle	SST	B1.69
	Clamp Ties/Mount	SSC	B1.70

D1. Terminals

D2. Power Connectors

D3. Grounding Connectors

E1. Labeling Systems

E2. Labels

### Part Number System for Sta-Strap® Cable Ties

E3. Pre-Printed & Write-On Markers

**SST**

**1**

**M**

—

**C**

—

Type

Size

Cross Section

Screw Hole Size

Package Size

Material/Color

E4. Permanent Identification

SST = Locking Tie  
SSC = Clamp Tie  
SSM = Marker Tie

Approx. Maximum Bundle Dia. (In.)

M = Miniature  
I = Intermediate  
S = Standard  
H = Heavy  
HH = Heavy Head

(Clamp Ties Only)  
-S6 = #6 (M3)  
-S10 = #10 (M5)  
-S25 = 1/4 (M6)

L = 50  
C = 100  
D = 500  
M = 1000

See Page B1.72

E5. Lockout/Tagout & Safety Solutions

F. Index



## UL® US C SP® Sta-Strap® Cable Ties – Nylon 6.6

- For indoor use
- Used for normal bundling and through-panel applications
- Small head height allows more efficient use of space in compact areas

- Exclusive two-piece design offers the lowest threading force in the industry
- Average 14% lighter than one-piece cable ties
- Releasable prior to final tensioning for bundle modifications



Part Number	Length		Width		Thickness		Max. Bundle Dia.		Min. Loop Tensile Str.		Recommended Installation Tool	Std. Pkg. Qty.	Std. Ctn. Qty.
	In.	mm	In.	mm	In.	mm	In.	mm	Lbs.	N			
<b>Miniature Cross Section</b>													
<b>SST1M-C</b>	4.0	102	.095	2.4	.035	.9	.78	20	18	80	GTS, GTSL, GS2B, PTS, PPTS, STS2	100	1000
<b>SST1.5M-C</b>	5.5	140	.095	2.4	.037	.9	1.25	32	18	80		100	1000
<b>Intermediate Cross Section</b>													
<b>SST1.5I-C</b>	5.3	137	.135	3.4	.037	.9	1.25	32	40	178	GTS, GTSL, GS2B, PTS, PPTS, STS2	100	1000
<b>SST2I-C</b>	8.1	206	.135	3.4	.040	1.0	2.00	51	40	178		100	1000
<b>SST3I-C</b>	11.0	279	.135	3.4	.040	1.0	3.00	76	40	178		100	1000
<b>SST4I-C</b>	14.7	375	.135	3.4	.040	1.0	4.00	102	40	178		100	1000
<b>Standard Cross Section</b>													
<b>SST1.5S-M</b>	5.7	146	.180	4.6	.045	1.2	1.25	32	50	222	GTS, GTSL, GS2B, GTH, GS4H, PTS, PTH, PPTS, STS2, STH2	1000	25000
<b>SST2S-C</b>	6.7	172	.180	4.6	.045	1.2	1.75	45	50	222		100	1000
<b>SST3S-C</b>	11.0	279	.180	4.6	.048	1.2	3.00	76	50	222		100	1000
<b>SST4S-C</b>	15.0	381	.180	4.6	.048	1.2	4.00	102	50	222		100	1000
<b>Light-Heavy Cross Section</b>													
<b>SST2H-D</b>	8.0	203	.300	7.6	.062	1.6	2.00	51	120	534	GTH, GS4H, GS4EH, PTH, STH2, ST3EH	500	5000
<b>SST4H-L</b>	14.8	376	.300	7.6	.067	1.7	4.00	102	120	534		50	500
<b>SST8H-L</b>	27.5	699	.300	7.6	.067	1.7	8.00	203	120	534		50	500

A. System Overview

B1. Cable Ties

B2. Cable Accessories

B3. Stainless Steel Ties

C1. Wiring Duct

C2. Surface Raceway

C3. Abrasion Protection

C4. Cable Management

D1. Terminals

D2. Power Connectors

D3. Grounding Connectors

E1. Labeling Systems

E2. Labels

E3. Pre-Printed & Write-On Markers

E4. Permanent Identification

E5. Lockout/Tagout & Safety Solutions

F. Index

A.  
System  
Overview

## **PA** **US** **SP** **US** Sta-Strap® Cable Ties – Weather Resistant Nylon 6.6

B1.  
Cable Ties

- Greater resistance to damage caused by ultraviolet light – indoor or outdoor use
- Used for normal bundling and through-panel applications
- Small head height allows more efficient use of space in compact areas

- Exclusive two-piece design offers the lowest threading force in the industry
- Average 14% lighter than one-piece cable ties
- Releasable prior to final tensioning for bundle modifications

B2.  
Cable  
Accessories

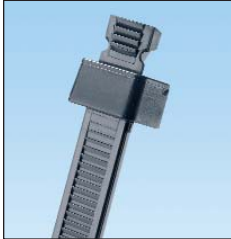

B3.  
Stainless  
Steel Ties

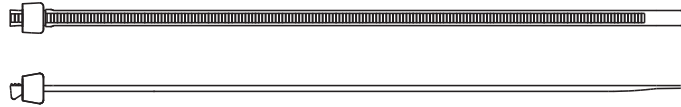

C1.  
Wiring  
Duct

C2.  
Surface  
Raceway

Part Number	Length		Width		Thickness		Max. Bundle Dia.		Min. Loop Tensile Str.		Recommended Installation Tool	Std. Pkg. Qty.	Std. Ctn. Qty.
	In.	mm	In.	mm	In.	mm	In.	mm	Lbs.	N			
<b>Miniature Cross Section</b>													
<b>SST1M-C0</b>	4.0	102	.095	2.4	.035	.9	.78	20	18	80	GTS, GTSL, GS2B, PTS, PPTS, STS2	100	1000
<b>SST1.5M-M0</b>	5.5	140	.095	2.4	.037	.9	1.25	32	18	80		1000	50000
<b>Intermediate Cross Section</b>													
<b>SST1.5I-M0</b>	5.3	137	.135	3.4	.037	.9	1.25	32	40	178	GTS, GTSL, GS2B, PTS, PPTS, STS2	1000	25000
<b>SST2I-M0</b>	8.1	206	.135	3.4	.040	1.0	2.00	51	40	178		1000	25000
<b>SST3I-C0</b>	11.0	279	.135	3.4	.040	1.0	3.00	76	40	178		100	1000
<b>SST4I-M0</b>	14.7	375	.135	3.4	.040	1.0	4.00	102	40	178		1000	10000
<b>Standard Cross Section</b>													
<b>SST1.5S-M0</b>	5.7	146	.180	4.6	.045	1.2	1.25	32	50	222	GTS, GTSL, GS2B, GTH, GS4H, PTS, PTH, PPTS, STS2, STH2	1000	25000
<b>SST2S-C0</b>	6.7	172	.180	4.6	.045	1.2	1.75	45	50	222		100	1000
<b>SST3S-C0</b>	11.0	279	.180	4.6	.048	1.2	3.00	76	50	222		100	1000
<b>SST4S-C0</b>	15.0	381	.180	4.6	.048	1.2	4.00	102	50	222		100	1000
<b>Light-Heavy Cross Section</b>													
<b>SST2H-D0</b>	8.0	203	.300	7.6	.062	1.6	2.00	51	120	534	GTH, GS4H, GS4EH, PTH, STH2, ST3EH	500	5000
<b>SST4H-L0</b>	14.8	376	.300	7.6	.067	1.7	4.00	102	120	534		50	500
<b>SST8H-L0</b>	27.5	699	.300	7.6	.067	1.7	8.00	203	120	534		50	500

E1.  
Labeling  
Systems

E2.  
Labels

E3.  
Pre-Printed  
& Write-On  
Markers

E4.  
Permanent  
Identification

E5.  
Lockout/  
Tagout  
& Safety  
Solutions

F.  
Index

## UL® cUL® Sta-Strap® Cable Ties – Heat Stabilized Nylon 6.6

- For high temperature applications up to 239°F (115°C) – indoor use
- Used for normal bundling and through-panel applications
- *Heavy head* design is available for use in through-panel applications with a larger opening up to .400" (10.2mm)
- Small head height allows more efficient use of space in compact areas

- Exclusive two-piece design offers the lowest threading force in the industry
- Average 14% lighter than one-piece cable ties
- Releasable prior to final tensioning for bundle modifications

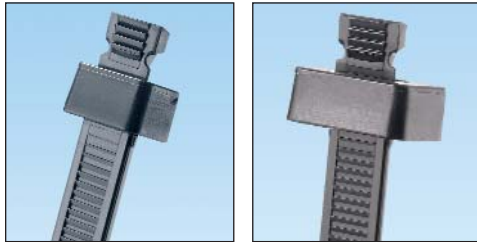

SST

SST2HH



Part Number	Length		Width		Thickness		Max. Bundle Dia.		Min. Loop Tensile Str.		Recommended Installation Tool	Std. Pkg. Qty.	Std. Ctn. Qty.
	In.	mm	In.	mm	In.	mm	In.	mm	Lbs.	N			
<b>Miniature Cross Section</b>													
<b>SST1M-M30</b>	4.0	102	.095	2.4	.035	.9	.78	20	18	80	GTS, GTSL, GS2B, PTS, PPTS, STS2	1000	50000
<b>SST1.5M-M30</b>	5.5	140	.095	2.4	.037	.9	1.25	32	18	80		1000	50000
<b>Standard Cross Section</b>													
<b>SST2S-M30</b>	6.7	172	.180	4.6	.045	1.2	1.75	45	50	222	GTS, GTSL, GS2B, GTH, GS4H, PTS, PTH, PPTS, STS2, STH2	1000	15000
<b>SST3S-M30</b>	11.0	279	.180	4.6	.048	1.2	3.00	76	50	222		1000	10000
<b>SST4S-M30</b>	15.0	381	.180	4.6	.048	1.2	4.00	102	50	222		1000	5000
<b>Light-Heavy Cross Section</b>													
<b>SST4H-D30</b>	14.8	376	.300	7.6	.067	1.7	4.00	102	120	534	GTH, GS4H, GS4EH, PTH, STH2, ST3EH	500	2500
<b>SST8H-D30</b>	27.5	699	.300	7.6	.067	1.7	8.00	203	120	534		500	2000
<b>Heavy Head Design Light-Heavy Cross Section</b>													
<b>SST2HH-D30</b>	8.0	203	.300	7.6	.062	1.6	2.00	50	120	534	GTH, GS4H, GS4EH, PTH, STH2, ST3EH	500	2500
<b>SST4HH-D30</b>	14.8	376	.300	7.6	.062	1.6	4.00	102	120	534		500	2500

A. System Overview

B1. Cable Ties

B2. Cable Accessories

B3. Stainless Steel Ties

C1. Wiring Duct

C2. Surface Raceway

C3. Abrasion Protection

C4. Cable Management

D1. Terminals

D2. Power Connectors

D3. Grounding Connectors

E1. Labeling Systems

E2. Labels

E3. Pre-Printed & Write-On Markers

E4. Permanent Identification

E5. Lockout/Tagout & Safety Solutions

F. Index

A. System Overview

## UL® cUL® Sta-Strap® Clamp Ties

- Natural nylon material for indoor use
- Weather resistant material has greater resistance to damage caused by ultraviolet light – indoor or outdoor use
- Heat stabilized material for high temperature applications up to 239°F (115°C) – indoor use
- Design allows for bundling before or after screwing clamp in place

- Exclusive two-piece design offers the lowest threading force in the industry
- Used to secure a cable bundle to another surface such as a control panel, communication rack, wall or ceiling
- Only clamp tie that is releasable prior to final tensioning



SSC2S-S10-C



SSC2S-S10-M0

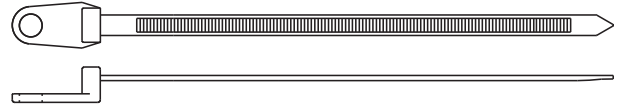

B1. Cable Ties

B2. Cable Accessories

B3. Stainless Steel Ties

C1. Wiring Duct

C2. Surface Raceway

C3. Abrasion Protection

C4. Cable Management

D1. Terminals

D2. Power Connectors

D3. Grounding Connectors

E1. Labeling Systems

E2. Labels

E3. Pre-Printed & Write-On Markers

E4. Permanent Identification

E5. Lockout/Tagout & Safety Solutions

F. Index

Part Number	Length		Width		Thickness		Nominal Hole Dia.		Screw Size	Metric Screw Size	Max. Bundle Dia.		Min. Loop Tensile Str.		Recommended Installation Tool	Std. Pkg. Qty.	Std. Ctn. Qty.
	In.	mm	In.	mm	In.	mm	In.	mm			In.	mm	Lbs.	N			

### Nylon 6.6

#### Standard Cross Section

SSC2S-S6-C	7.4	187	.180	4.6	.045	1.1	.148	3.8	#6	M3	1.75	45	50	222	GTS, GTSL, GS2B, GTH, GS4H, PTS, PTH, PPTS, STS2, STH2	100	1000
<b>SSC2S-S10-C</b>	7.4	187	.180	4.6	.045	1.1	.200	5.1	#10	M5	1.75	45	50	222		100	1000
SSC4S-S10-C	15.7	398	.180	4.6	.045	1.1	.200	5.1	#10	M5	4.00	102	50	222		100	500

#### Light-Heavy Cross Section

SSC4H-S25-L	15.6	395	.300	7.6	.065	1.7	.260	6.6	1/4	M6	4.00	102	120	534	GTH, GS4H, GS4EH, PTH, STH2, ST3EH	50	500
-------------	------	-----	------	-----	------	-----	------	-----	-----	----	------	-----	-----	-----	------------------------------------	----	-----

### Weather Resistant Nylon 6.6

#### Standard Cross Section

SSC2S-S6-M0	7.4	187	.180	4.6	.045	1.1	.148	3.8	#6	M3	1.75	45	50	222	GTS, GTSL, GS2B, GTH, GS4H, PTS, PTH, PPTS, STS2, STH2	1000	10000
<b>SSC2S-S10-M0</b>	7.4	187	.180	4.6	.045	1.1	.200	5.1	#10	M5	1.75	45	50	222		1000	10000
SSC4S-S10-M0	15.7	398	.180	4.6	.045	1.1	.200	5.1	#10	M5	4.00	102	50	222		1000	5000

#### Light-Heavy Cross Section

SSC4H-S25-D0	15.6	395	.300	7.6	.065	1.7	.260	6.6	1/4	M6	4.00	102	120	534	GTH, GS4H, GS4EH, PTH, STH2, ST3EH	500	2500
--------------	------	-----	------	-----	------	-----	------	-----	-----	----	------	-----	-----	-----	------------------------------------	-----	------

### Heat Stabilized Nylon 6.6

#### Standard Cross Section

<b>SSC2S-S10-M30</b>	7.4	187	.180	4.6	.045	1.2	.200	5.1	#10	M5	1.75	45	50	222	GTS, GTSL, GS2B, GTH, GS4H, PTS, PTH, PPTS, STS2, STH2	1000	10000
----------------------	-----	-----	------	-----	------	-----	------	-----	-----	----	------	----	----	-----	--	------	-------

#### Light-Heavy Cross Section

SSC4H-S25-D30	15.6	395	.300	7.6	.065	1.7	.260	6.6	1/4	M6	4.00	102	120	534	GTH, GS4H, GS4EH, PTH, STH2, ST3EH	500	2500
---------------	------	-----	------	-----	------	-----	------	-----	-----	----	------	-----	-----	-----	------------------------------------	-----	------

## UL<sup>®</sup> CS<sup>®</sup> Sta-Strap<sup>®</sup> Marker Ties – Nylon and Weather Resistant Nylon 6.6

- Natural nylon material for indoor use
- Weather resistant material has greater resistance to damage caused by ultraviolet light – indoor or outdoor use
- Used to fasten and identify bundles at the same time
- Unique design allows tie to be used as a wrap-around or flag marker

- Can be marked with Panduit Marker Pens on page B1.51 or computer printable labels
- Custom imprinting with text, symbols, or trademarks available using Panduit Custom Hot Stamping Service, see page B1.91



SSM2S-C



SSM2S-D0

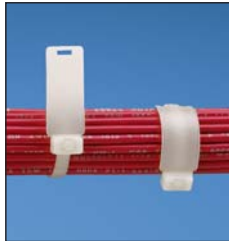

Part Number	Marker Type	Length		Width		Thickness		Marker Write-On Area		Max. Bundle Dia.		Min. Loop Tensile Str.		Recommended Installation Tool	Std. Pkg. Qty.	Std. Ctn. Qty.
		In.	mm	In.	mm	In.	mm	In.	mm	In.	mm	Lbs.	N			

### Nylon 6.6

#### Standard Cross Section

<b>SSM2S-C</b>	Wrap/Flag	6.7	170	.180	4.6	.045	1.1	.44 x .96	11.2 x 24.4	1.75	45	50	222	GTS, GTSL, GS2B, GTH, GS4H, PTS, PTH, PPTS, STS2, STH2	100	500
<b>SSM4S-D</b>	Wrap/Flag	14.9	378	.180	4.6	.045	1.1	.44 x .96	11.2 x 24.4	4.00	102	50	222		500	5000

### Weather Resistant Nylon 6.6

#### Standard Cross Section

<b>SSM2S-D0</b>	Wrap/Flag	6.7	170	.180	4.6	.045	1.1	.44 x .96	11.2 x 24.4	1.75	45	50	222	GTS, GTSL, GS2B, GTH, GS4H, PTS, PTH, PPTS, STS2, STH2	500	10000
-----------------	-----------	-----	-----	------	-----	------	-----	-----------	-------------	------	----	----	-----	--	-----	-------

A.  
System Overview

B1.  
Cable Ties

B2.  
Cable Accessories

B3.  
Stainless Steel Ties

C1.  
Wiring Duct

C2.  
Surface Raceway

C3.  
Abrasion Protection

C4.  
Cable Management

D1.  
Terminals

D2.  
Power Connectors

D3.  
Grounding Connectors

E1.  
Labeling Systems

E2.  
Labels

E3.  
Pre-Printed & Write-On Markers

E4.  
Permanent Identification

E5.  
Lockout/Tagout & Safety Solutions

F.  
Index

A.  
System  
Overview

## Sta-Strap® Cable Ties

B1.  
Cable Ties

### Material and Color Chart

Material	Color	Panduit Suffix
Nylon 6.6	Natural	✓
Weather Resistant Nylon 6.6	Black	0
Nylon 6.6	Red	2

Material	Color	Panduit Suffix
Nylon 6.6	Black	20
Heat Stabilized Nylon 6.6	Black	30

✓Denotes Panduit Natural Nylon 6.6 (no suffix).

C1.  
Wiring  
Duct

C2.  
Surface  
Raceway

C3.  
Abrasion  
Protection

### Part Number Availability List

	Standard Packaging			Bulk Packaging		
	Part Number	Natural Nylon 6.6	Material/Color Suffix	Part Number	Natural Nylon 6.6	Material/Color Suffix
C4. Cable Management	SSC2S-S6-C	✓		SSC2S-S6-M	✓	0
	SSC2S-S10-C	✓		SSC2S-S10-M	✓	0,30
	SSC4S-S10-C	✓		SSC4S-S10-M	✓	0
D1. Terminals	SSC4H-S25-L	✓		SSC4H-S25-D	✓	0
	SSM2S-C	✓		SSM2S-D	✓	0
D2. Power Connectors				SSM4S-D	✓	
	SST1M-C	✓	0	SST1M-M	✓	0,20,30
	SST1.5M-C	✓		SST1.5M-M	✓	0,20,30
	SST1.5I-C	✓		SST1.5I-M	✓	0
D3. Grounding Connectors	SST2I-C	✓		SST2I-M	✓	0
	SST3I-C	✓	0	SST3I-M	✓	0
	SST4I-C	✓		SST4I-M	✓	0
E1. Labeling Systems				SST1.5S-M	✓	0
	SST2S-C	✓	0	SST2S-M	✓	0,20,30
	SST3S-C	✓	0	SST3S-M	✓	0,20,30
	SST4S-C	✓	0	SST4S-M	✓	0,2,30
				SST2H-D	✓	0
E2. Labels				SST2HH-D		30
	SST4H-L	✓	0	SST4H-D	✓	0,30
			0	SST4HH-D		30
			SST8H-D	✓	0,30	
SST8H-L	✓	0				

E3.  
Pre-Printed  
& Write-On  
Markers

E4.  
Permanent  
Identification

E5.  
Lockout/  
Tagout  
& Safety  
Solutions

F.  
Index

## Selection Guide – Specialty Ties



	Material, Color (Suffix)	Style/Function	Part Number Prefix	Catalog Page
Stud Mounted Cable Ties	Heat Stabilized Nylon 6.6, Black (30)	Locking Ties/Bundle	PLST	B1.74
		Releasable/Re-usable	PRST	B1.74
	Heat Stabilized Weather Resistant Nylon 6.6, Black (300)	Locking/Bundle	PLST	B1.74
Ladder Style Stud Mount	Heat Stabilized Nylon 6.6, Black (30)	Releasable/Re-usable	PRST	B1.75
Double Loop Ties – One-Piece	Nylon 6.6, Natural (No Suffix)	Locking/Bundle	PLB	B1.76
	Weather Resistant Nylon 6.6, Black (0)			
	Heat Stabilized Nylon 6.6, Black (30)			
Double Loop Ties – Two-Piece	Nylon 6.6, Natural (No Suffix)	Locking/Bundle	SSB	B1.77
	Weather Resistant Nylon 6.6, Black (0)			
	Heat Stabilized Nylon 6.6, Black (30)			
Triple Loop Ties	Weather Resistant Nylon 6.6, Black (0)	Locking/Bundle	PL3B	B1.78
Double Hose Clamp	Weather Resistant Nylon 6.6, Black (0)	Locking/Bundle	DHC	B1.78
Chassis/Panel Mount Ties	Heat Stabilized Weather Resistant Nylon 6.6, Black (300)	Locking/Bundle	SSPM	B1.79
Cable Marker Strap	Polyethylene (No Suffix)	Releasable/Re-usable	CM4S	B1.80

### Part Number System for Specialty Cable Ties

PLST	4	H	S25	—	TL	300
Type	Size	Cross Section	Stud Size		Package Size	Material/Color
CM4S = Cable Marker Strap	Approx. Maximum Bundle Dia. (In.)	S = Standard H = Heavy EH = Extra-Heavy	-S25 = M6 -SC = 5mm -S14 = 5mm		L = 50 C = 100 TL = 250 D = 500 M = 1000	See Page B1.81
PLB = Locking Bow Tie						
PL3B = Triple Loop Tie						
DHC = Double Hose Clamp						
PLST = Locking Stud Mounted Tie						
PRST = Releasable Stud Mount Ladder Style						
SSB = Sta-Strap® Bow-Ty™ Tie						
SSPM = Sta-Strap® Panel Mount						



Cable tie tools speed installation and reduce total installed cost. See pages B1.109 – B1.114.



Cable tie accessories are used to speed and simplify the mounting of wires, cables, and tubing. See pages B2.1 – B2.29.

A. System Overview



## Pan-Ty® Stud Mounted Cable Ties – Heat Stabilized and Heat Stabilized Weather Resistant Nylon 6.6

B1. Cable Ties

- Heat stabilized material for high temperature applications up to 239°F (115°C) – indoor use
- Heat stabilized weather resistant material has greater resistance to damage caused by ultraviolet light and for high temperature applications up to 212°F (100°C) – indoor or outdoor use
- Integral mount pushes onto a threaded stud and tie wraps around bundle

- Mid-mount style (PLST\_SC) centers the wire bundle over the stud
- Tie can be removed from the stud by turning counterclockwise
- Releasable style available (PRST)
- Curved tip is easy to pick up from flat surfaces and allows faster initial threading to speed installation

B2. Cable Accessories

B3. Stainless Steel Ties

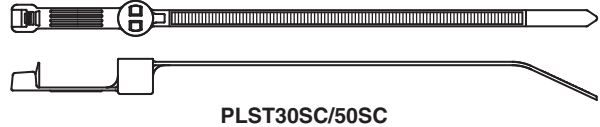

C1. Wiring Duct

C2. Surface Raceway

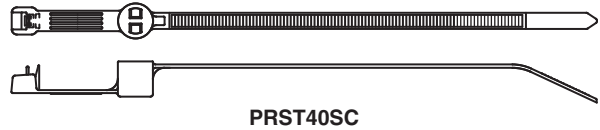

C3. Abrasion Protection

C4. Cable Management

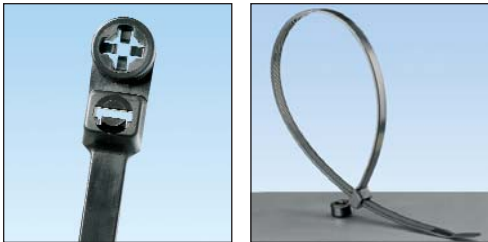

D1. Terminals

D2. Power Connectors

D3. Grounding Connectors

Part Number	Length		Width		Thickness		Recommended Stud Size		Max. Bundle Dia.		Min. Loop Tensile Str.		Recommended Installation Tool	Std. Pkg. Qty.	Std. Ctn. Qty.
	In.	mm	In.	mm	In.	mm	In.	mm	In.	mm	Lbs.	N			

E1. Labeling Systems

### Heat Stabilized Nylon 6.6 Standard Cross Section

<b>PLST30SC-D30</b>	5.7	146	.190	4.8	.050	1.3	10-24	5.0	1.18	30	50	222	GTS, GTSL, GS2B, GTH, GS4H, PTS, PTH, PPTS, STS2, STH2	500	5000
<b>PLST50SC-D30</b>	8.1	207	.190	4.8	.050	1.3	10-24	5.0	1.97	50	50	222		500	5000
<b>PRST40SC-D30</b>	6.9	176	.190	4.8	.050	1.3	10-24	5.0	1.57	40	50	222		Hand install only	500

E2. Labels

E3. Pre-Printed & Write-On Markers

### Heat Stabilized Weather Resistant Nylon 6.6 Light-Heavy Cross Section

<b>PLST4HS25-TL300</b>	15.3	389	.300	7.6	.075	1.9	1/4-20	6.4	4.00	102	120	534	GTH, GS4H, GS4EH, PTH, STH2, ST3EH	250	2500
------------------------	------	-----	------	-----	------	-----	--------	-----	------	-----	-----	-----	------------------------------------	-----	------

E4. Permanent Identification

E5. Lockout/Tagout & Safety Solutions

F. Index

Note: UL Recognized and CSA Certified except PLST4H.



## cUL<sup>us</sup> cSP<sup>us</sup> Pan-Ty® Ladder Style Stud Mounted Cable Tie – Heat Stabilized Nylon 6.6

- For high temperature applications up to 239°F (115°C) – indoor use
- Integral mount pushes onto a threaded stud and tie wraps around bundle

- Tie can be removed from the stud by turning counterclockwise
- Adjustable, releasable, and re-usable
- Install by hand – no tools required

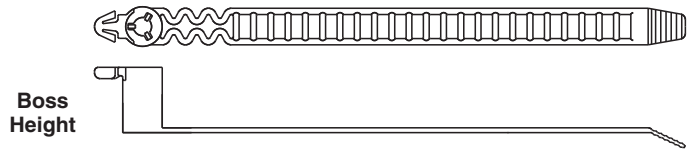

Part Number	Length		Width		Thickness		Boss Height		Recommended Stud Size		Max. Bundle Dia.		Min. Loop Tensile Str.		Std. Pkg. Qty.	Std. Ctn. Qty.
	In.	mm	In.	mm	In.	mm	In.	mm	In.	mm	In.	mm	Lbs.	N		
<b>Standard Cross Section</b>																
PRST30S-S14-M30	5.2	132	.380	9.7	.050	1.3	.59	15	10-24	5.0	1.18	30	35	156	1000	10000

A.  
System Overview

B1.  
Cable Ties

B2.  
Cable Accessories

B3.  
Stainless Steel Ties

C1.  
Wiring Duct

C2.  
Surface Raceway

C3.  
Abrasion Protection

C4.  
Cable Management

D1.  
Terminals

D2.  
Power Connectors

D3.  
Grounding Connectors

E1.  
Labeling Systems

E2.  
Labels

E3.  
Pre-Printed & Write-On Markers

E4.  
Permanent Identification

E5.  
Lockout/Tagout & Safety Solutions

F.  
Index

A. System Overview

## UL® US® CS® Pan-Ty® Double Loop Cable Ties

B1. Cable Ties

- Natural nylon material for indoor use
- Weather resistant material has greater resistance to damage caused by ultraviolet light – indoor or outdoor use
- Heat stabilized material for high temperature applications up to 239°F (115°C) – indoor use

- A fast and economical method to secure and separate two bundles
- Reduces part number inventory – single part covers multiple bundle sizes
- Installs easily by hand – second loop can be installed with Panduit cable tie installation tools

B2. Cable Accessories

B3. Stainless Steel Ties



**PLB4H**  
Head Design



**PLB2S/3S/4S**  
Head Design

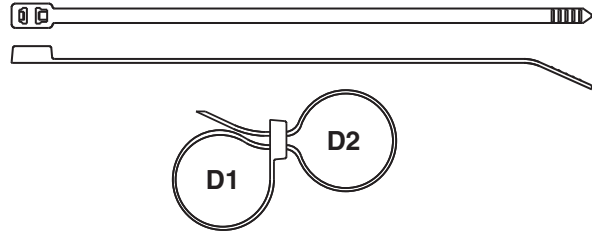

Assembled View

C1. Wiring Duct

C2. Surface Raceway

C3. Abrasion Protection

C4. Cable Management

D1. Terminals

D2. Power Connectors

D3. Grounding Connectors

E1. Labeling Systems

E2. Labels

E3. Pre-Printed & Write-On Markers

E4. Permanent Identification

E5. Lockout/Tagout & Safety Solutions

F. Index

Part Number	Max. Combined Bundle Dia. D1 + D2		Length		Width		Thickness		Min. Loop Tensile Str.		Recommended Installation Tool	Std. Pkg. Qty.	Std. Ctn. Qty.
	In.	mm	In.	mm	In.	mm	In.	mm	Lbs.	N			

### Nylon 6.6

#### Standard Cross Section

<b>PLB2S-C</b>	1.80	46	7.6	193	.190	4.8	.052	1.3	50	222	GTS, GTSL, GS2B, GTH, GS4H, PTS, PTH, PPTS, STS2, STH2	100	1000
<b>PLB3S-C</b>	3.00	76	11.8	300	.190	4.8	.052	1.3	50	222		100	1000
<b>PLB4S-C</b>	4.10	104	14.8	376	.190	4.8	.052	1.3	50	222		100	1000

#### Light-Heavy Cross Section

<b>PLB4H-TL</b>	3.60	91	14.7	373	.300	7.6	.075	1.9	120	534	GTH, GS4H, GS4EH, PTH, STH2, ST3EH	250	2500
-----------------	------	----	------	-----	------	-----	------	-----	-----	-----	------------------------------------	-----	------

### Weather Resistant Nylon 6.6

#### Standard Cross Section

<b>PLB2S-C0</b>	1.80	46	7.6	193	.190	4.8	.052	1.3	50	222	GTS, GTSL, GS2B, GTH, GS4H, PTS, PTH, PPTS, STS2, STH2	100	1000
<b>PLB3S-C0</b>	3.00	76	11.8	300	.190	4.8	.052	1.3	50	222		100	1000
<b>PLB4S-M0</b>	4.10	104	14.8	376	.190	4.8	.052	1.3	50	222		1000	5000

#### Light-Heavy Cross Section

<b>PLB4H-TL0</b>	3.60	91	14.7	373	.300	7.6	.075	1.9	120	534	GTH, GS4H, GS4EH, PTH, STH2, ST3EH	250	2500
------------------	------	----	------	-----	------	-----	------	-----	-----	-----	------------------------------------	-----	------

### Heat Stabilized Nylon 6.6

#### Standard Cross Section

<b>PLB2S-M30</b>	1.80	46	7.6	193	.190	4.8	.052	1.3	50	222	GTS, GTSL, GS2B, GTH, GS4H, PTS, PTH, PPTS, STS2, STH2	1000	10000
<b>PLB3S-M30</b>	3.00	76	11.8	300	.190	4.8	.052	1.3	50	222		1000	10000
<b>PLB4S-M30</b>	4.10	104	14.8	376	.190	4.8	.052	1.3	50	222		1000	5000

#### Light-Heavy Cross Section

<b>PLB4H-TL30</b>	3.60	91	14.7	373	.300	7.6	.075	1.9	120	534	GTH, GS4H, GS4EH, PTH, STH2, ST3EH	250	2500
-------------------	------	----	------	-----	------	-----	------	-----	-----	-----	------------------------------------	-----	------

Note: UL Recognized and CSA Certified except PLB4H-TL0.

## UL® CS® Sta-Strap® Bow-Ty™ Cable Ties

- Natural nylon material for indoor use
- Weather resistant material has greater resistance to damage caused by ultraviolet light – indoor or outdoor use
- Heat stabilized material for high temperature applications up to 239°F (115°C) – indoor use

- A fast and economical method to secure and separate two bundles
- Exclusive two-piece design offers the lowest threading force in the industry
- First loop is releasable prior to final tensioning



SSB2S-C

SSB2S-M0 (30)

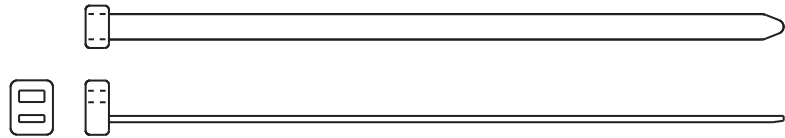

Top View

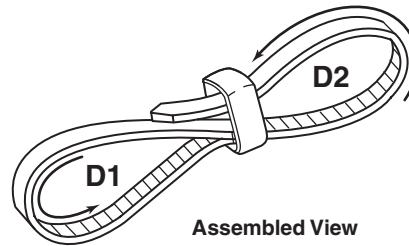

Assembled View

Part Number	Max. Combined Bundle Dia. D1 + D2		Length		Width		Thickness		Min. Loop Tensile Str.		Recommended Installation Tool	Std. Pkg. Qty.	Std. Ctn. Qty.
	In.	mm	In.	mm	In.	mm	In.	mm	Lbs.	N			

### Nylon 6.6

#### Standard Cross Section

SSB2S-C	1.25	32	6.8	172	.18	4.6	.045	1.1	30	133	Hand install only	100	1000
---------	------	----	-----	-----	-----	-----	------	-----	----	-----	-------------------	-----	------

### Weather Resistant Nylon 6.6

#### Standard Cross Section

SSB2S-M0	1.25	32	6.8	172	.18	4.6	.045	1.1	30	133	Hand install only	1000	10000
----------	------	----	-----	-----	-----	-----	------	-----	----	-----	-------------------	------	-------

### Heat Stabilized Nylon 6.6

#### Standard Cross Section

SSB2S-M30	1.25	32	6.8	172	.18	4.6	.045	1.1	30	133	Hand install only	1000	10000
-----------	------	----	-----	-----	-----	-----	------	-----	----	-----	-------------------	------	-------

A.  
System  
Overview

B1.  
Cable  
Ties

B2.  
Cable  
Accessories

B3.  
Stainless  
Steel Ties

C1.  
Wiring  
Duct

C2.  
Surface  
Raceway

C3.  
Abrasion  
Protection

C4.  
Cable  
Management

D1.  
Terminals

D2.  
Power  
Connectors

D3.  
Grounding  
Connectors

E1.  
Labeling  
Systems

E2.  
Labels

E3.  
Pre-Printed  
& Write-On  
Markers

E4.  
Permanent  
Identification

E5.  
Lockout/  
Tagout  
& Safety  
Solutions

F.  
Index

A. System Overview

## Pan-Ty® Triple Loop Cable Tie – Weather Resistant Nylon 6.6

B1. Cable Ties

- Greater resistance to damage caused by ultraviolet light – indoor or outdoor use
- A fast and economical method to secure and separate three bundles

- Third loop can be installed with Panduit cable tie installation tools

B2. Cable Accessories

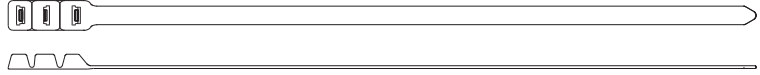

B3. Stainless Steel Ties

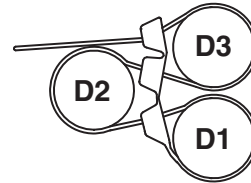

Assembled View

C1. Wiring Duct

C2. Surface Raceway

Part Number	Max. Combined Bundle Dia. D1 + D2 + D3		Length		Width		Thickness		Min. Loop Tensile Str.		Recommended Installation Tool	Std. Pkg. Qty.	Std. Ctn. Qty.
	In.	mm	In.	mm	In.	mm	In.	mm	Lbs.	N			
<b>Extra-Heavy Cross Section</b>													
<b>PL3B5EH-C0</b>	5.00	127	20.0	508	.500	12.7	.075	1.9	125	556	GS4EH, ST3EH	100	1000

C3. Abrasion Protection

C4. Cable Management

## Double Hose Clamp – Weather Resistant Nylon 6.6

- Greater resistance to damage caused by ultraviolet light – indoor or outdoor use

- Holds and separates two gasoline, hydraulic, or pneumatic hoses
- Holds each hose individually to prevent abrasion and twisting

D1. Terminals



D2. Power Connectors



D3. Grounding Connectors



E1. Labeling Systems

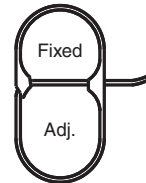

Assembled View

E2. Labels

Part Number	Length		Width		Thickness		Fixed Loop Dia.		Adjustable Loop Dia.		Min. Loop Tensile Str.		Recommended Installation Tool	Std. Pkg. Qty.	Std. Ctn. Qty.
	In.	mm	In.	mm	In.	mm	In.	mm	In.	mm	Lbs.	N			
<b>DHC1.12X1.75-D0</b>	11.0	279	0.28	7.1	0.05	1.3	1.12	28	1.00 – 1.75	25 – 44	100	445	GTH, GS4H, PTH, STH2, ST3EH	500	2500

E3. Pre-Printed & Write-On Markers

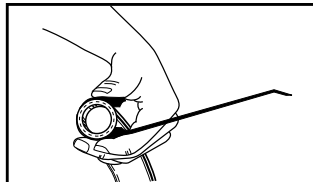

1) Wrap clamp around hose

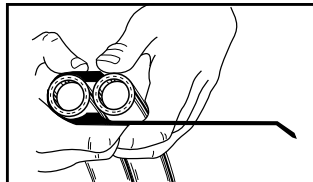

2) Position second hose in clamp

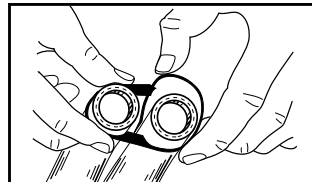

3) Loop tail around second hose and thread tail through both spacer heads

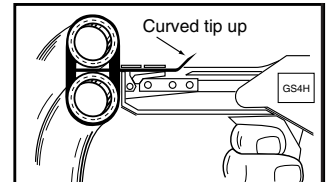

4) Tension and cut off with recommended tool

E4. Permanent Identification

E5. Lockout/Tagout & Safety Solutions

F. Index

**UL US cUL US** **Sta-Strap® Chassis/Panel Mount Ties – Heat Stabilized Weather Resistant Nylon 6.6**

- Greater resistance to damage caused by ultraviolet light and for high temperature applications up to 212°F (100°C) – indoor or outdoor use
- Unique design allows tie to secure a bundle directly to a chassis or panel without the need for separate fasteners or mounting devices
- Releasable prior to final tensioning for bundle modifications
- Engages clearance hole with optional centering pilot to prevent tie from shifting or abrading in high vibration environments

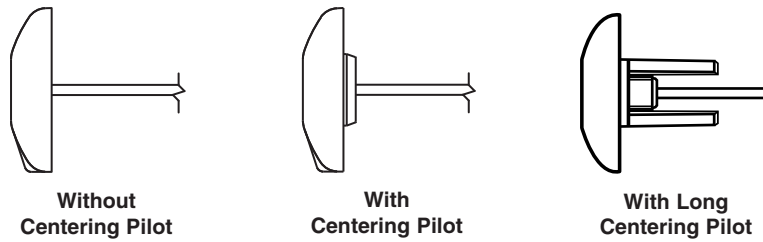

Part Number	Length		Width		Thickness		Hole Diameter Range		Max. Bundle Dia.		Min. Loop Tensile Str.		Recommended Installation Tool	Std. Pkg. Qty.	Std. Ctn. Qty.
	In.	mm	In.	mm	In.	mm	In.	mm	In.	mm	Lbs.	N			
<b>Without Centering Pilot</b>															
SSPM2.5H-L300	10.1	257	.300	7.6	.062	1.6	.316 – .820	8.0 – 21.0	2.76	70	120	534	GTH, GS4H, GS4EH, PTH, STH2, ST3EH	50	2500
SSPM4H-L300	14.8	376	.300	7.6	.062	1.6	.316 – .820	8.0 – 21.0	4.00	102	120	534	GTH, GS4H, GS4EH, PTH, STH2, ST3EH	50	2500
<b>With Centering Pilot</b>															
SSPM2.5HP-L300	10.1	257	.300	7.6	.062	1.6	.440 – .820	11.2 – 21.0	2.76	70	120	534	GTH, GS4H, GS4EH, PTH, STH2, ST3EH	50	2500
SSPM4HP-L300	14.8	376	.300	7.6	.062	1.6	.440 – .820	11.2 – 21.0	4.00	102	120	534	GTH, GS4H, GS4EH, PTH, STH2, ST3EH	50	2500
<b>With Long Centering Pilot</b>															
SSPM4HLP-TL300	14.8	376	.300	7.6	.062	1.6	.440 – .820	11.2 – 21.0	4.00	102	120	534	GTH, GS4H, GS4EH, PTH, STH2, ST3EH	250	2500

### Through-Panel Mount Installation in Three Easy Steps:

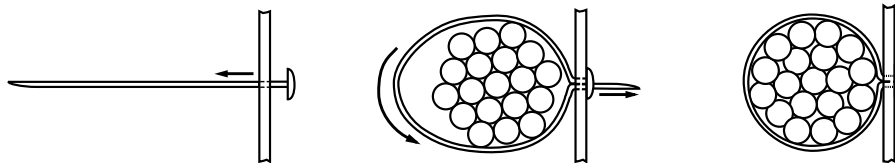

1) Insert tip of cable tie through the pre-drilled hole in the panel.

2) Wrap cable tie around the bundle and insert tip back through the hole and head of the cable tie.

3) Pull tip until cable tie is snug on bundle. Tension and cut off excess portion with installation tool.

A. System Overview

## Cable Marker Straps – Polyethylene

B1. Cable Ties

- Identify and code telephone and fiber optic cable
- Eliminate the need for costly and cumbersome lead marking tags
- Lightweight and easy to install
- Use as wrap-around or flag marker

- For underground identification applications
- Can be marked with Panduit marker pens, see page B1.51
- Custom imprinting with text, symbols, or trademarks available using Panduit Custom Hot Stamping Service, see page B1.93

B2. Cable Accessories

B3. Stainless Steel Ties

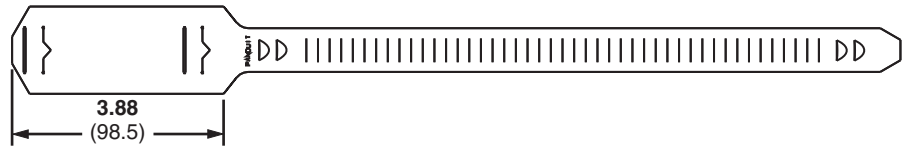

C1. Wiring Duct

C2. Surface Raceway

C3. Abrasion Protection

C4. Cable Management

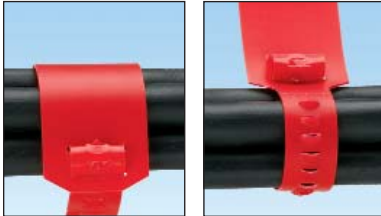

D1. Terminals

**Wrap-Around Marker**  
(Min. Dia.: 1.27")

**Flag Marker**  
(Min. Dia.: .25")

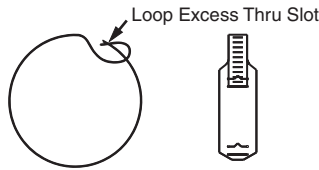

D2. Power Connectors

Part Number	Length		Width		Thickness		Color	Marker Write-On Area		Max. Bundle Dia.		Recommended Installation Tool	Std. Pkg. Qty.	Std. Ctn. Qty.
	In.	mm	In.	mm	In.	mm		In.	mm	In.	mm			
<b>Standard Cross Section</b>														
<b>CM4S-L2</b>	15.3	387	.750	19.1	.033	.84	Red	1.50 x 2.62	38.1 x 66.5	4.38	111	Hand install only	50	500
<b>CM4S-L8</b>	15.3	387	.750	19.1	.033	.84	Gray	1.50 x 2.62	38.1 x 66.5	4.38	111		50	500

E1. Labeling Systems

E2. Labels

E3. Pre-Printed & Write-On Markers

E4. Permanent Identification

E5. Lockout/Tagout & Safety Solutions

F. Index

## Specialty Cable Ties

### Material and Color Chart

Material	Color	Panduit Suffix
Nylon 6.6	Natural	✓
Weather Resistant Nylon 6.6	Black	0
Nylon 6.6	Red	2
Nylon 6.6	Gray	8

Material	Color	Panduit Suffix
Heat Stabilized Nylon 6.6	Black	30
Heat Stabilized Weather Resistant Nylon 6.6	Black	300

✓Denotes Panduit Natural Nylon 6.6 (no suffix).

### Part Number Availability List

Standard Packaging			Bulk Packaging		
Part Number	Natural Nylon 6.6	Material/Color Suffix	Part Number	Natural Nylon 6.6	Material/Color Suffix
CM4S-L		2,8			
			DHC1.12X1.75-D		0
PLB2S-C	✓	0	PLB2S-M	✓	0,30
PLB3S-C	✓	0	PLB3S-M	✓	0,30
PLB4S-C	✓		PLB4S-M	✓	0,30
			PLB4H-TL	✓	0,30
			PL3B5EH-C		0
			PLST4HS25-TL		300
			PLST30SC-D		30
			PLST50SC-D		30
			PRST30S-S14-M		30
			PRST40SC-SD		30
SSB2S-C	✓		SSB2S-M	✓	0,30
SSPM2.5H-L		300	SSPM2.5H-TL		300
SSPM2.5HP-L		300	SSPM2.5HP-TL		300
SSPM4H-L		300	SSPM4H-TL		300
SSPM4HP-L		300	SSPM4HP-TL		300
			SSPM4HLP-TL		300

A.  
System  
Overview

B1.  
Cable Ties

B2.  
Cable  
Accessories

B3.  
Stainless  
Steel Ties

C1.  
Wiring  
Duct

C2.  
Surface  
Raceway

C3.  
Abrasion  
Protection

C4.  
Cable  
Management

D1.  
Terminals

D2.  
Power  
Connectors

D3.  
Grounding  
Connectors

E1.  
Labeling  
Systems

E2.  
Labels

E3.  
Pre-Printed  
& Write-On  
Markers

E4.  
Permanent  
Identification

E5.  
Lockout/  
Tagout  
& Safety  
Solutions

F.  
Index

# PANDUIT® ELECTRICAL SOLUTIONS

A. System Overview

## UL® US C SP® US Pan-Ty® Striped Cable Ties – Nylon 6.6

B1. Cable Ties

- Nylon material for indoor use
- Striped Pan-Ty® Cable Ties in 25 color combinations match the universally accepted Even-Count Color Code

- Solid color ties are available for identification of “super groups” in cable containing more than 600 pairs
- Each 50-piece package fits in the Pan-Pouch™ Kit or pocket pouch shown on the next page

B2. Cable Accessories

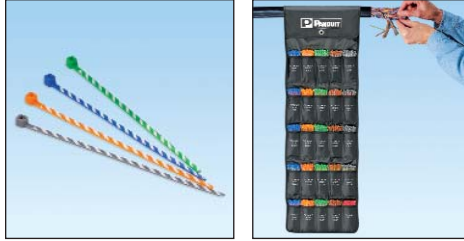

B3. Stainless Steel Ties

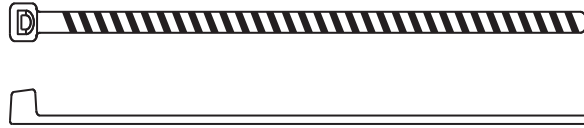

C1. Wiring Duct

C2. Surface Raceway

C3. Abrasion Protection

C4. Cable Management

D1. Terminals

D2. Power Connectors

D3. Grounding Connectors

E1. Labeling Systems

E2. Labels

E3. Pre-Printed & Write-On Markers

E4. Permanent Identification

E5. Lockout/Tagout & Safety Solutions

F. Index

Part Number	Color	Length		Width		Thickness		Max. Bundle Dia.		Min. Loop Tensile Str.		Std. Pkg. Qty.	Std. Ctn. Qty.
		In.	mm	In.	mm	In.	mm	In.	mm	Lbs.	N		
<b>Miniature Cross Section (Straight Tip)</b>													
<b>PLT1M-L6-10</b>	Blue/White Stripe	4.0	102	.100	2.5	.036	.9	.82	21	18	80	50	1000
<b>PLT1M-L3-10</b>	Orange/White Stripe	4.0	102	.100	2.5	.036	.9	.82	21	18	80	50	1000
<b>PLT1M-L5-10</b>	Green/White Stripe	4.0	102	.100	2.5	.036	.9	.82	21	18	80	50	1000
<b>PLT1M-L1-10</b>	Brown/White Stripe	4.0	102	.100	2.5	.036	.9	.82	21	18	80	50	1000
<b>PLT1M-L8-10</b>	Slate/White Stripe	4.0	102	.100	2.5	.036	.9	.82	21	18	80	50	1000
<b>PLT1M-L6-2</b>	Blue/Red Stripe	4.0	102	.100	2.5	.036	.9	.82	21	18	80	50	1000
<b>PLT1M-L3-2</b>	Orange/Red Stripe	4.0	102	.100	2.5	.036	.9	.82	21	18	80	50	1000
<b>PLT1M-L5-2</b>	Green/Red Stripe	4.0	102	.100	2.5	.036	.9	.82	21	18	80	50	1000
<b>PLT1M-L1-2</b>	Brown/Red Stripe	4.0	102	.100	2.5	.036	.9	.82	21	18	80	50	1000
<b>PLT1M-L8-2</b>	Slate/Red Stripe	4.0	102	.100	2.5	.036	.9	.82	21	18	80	50	1000
<b>PLT1M-L6-0</b>	Blue/Black Stripe	4.0	102	.100	2.5	.036	.9	.82	21	18	80	50	1000
<b>PLT1M-L3-0</b>	Orange/Black Stripe	4.0	102	.100	2.5	.036	.9	.82	21	18	80	50	1000
<b>PLT1M-L5-0</b>	Green/Black Stripe	4.0	102	.100	2.5	.036	.9	.82	21	18	80	50	1000
<b>PLT1M-L1-0</b>	Brown/Black Stripe	4.0	102	.100	2.5	.036	.9	.82	21	18	80	50	1000
<b>PLT1M-L8-0</b>	Slate/Black Stripe	4.0	102	.100	2.5	.036	.9	.82	21	18	80	50	1000
<b>PLT1M-L6-4</b>	Blue/Yellow Stripe	4.0	102	.100	2.5	.036	.9	.82	21	18	80	50	1000
<b>PLT1M-L3-4</b>	Orange/Yellow Stripe	4.0	102	.100	2.5	.036	.9	.82	21	18	80	50	1000
<b>PLT1M-L5-4</b>	Green/Yellow Stripe	4.0	102	.100	2.5	.036	.9	.82	21	18	80	50	1000
<b>PLT1M-L1-4</b>	Brown/Yellow Stripe	4.0	102	.100	2.5	.036	.9	.82	21	18	80	50	1000
<b>PLT1M-L8-4</b>	Slate/Yellow Stripe	4.0	102	.100	2.5	.036	.9	.82	21	18	80	50	1000
<b>PLT1M-L6-7</b>	Blue/Violet Stripe	4.0	102	.100	2.5	.036	.9	.82	21	18	80	50	1000
<b>PLT1M-L3-7</b>	Orange/Violet Stripe	4.0	102	.100	2.5	.036	.9	.82	21	18	80	50	1000
<b>PLT1M-L5-7</b>	Green/Violet Stripe	4.0	102	.100	2.5	.036	.9	.82	21	18	80	50	1000
<b>PLT1M-L1-7</b>	Brown/Violet Stripe	4.0	102	.100	2.5	.036	.9	.82	21	18	80	50	1000
<b>PLT1M-L8-7</b>	Slate/Violet Stripe	4.0	102	.100	2.5	.036	.9	.82	21	18	80	50	1000
<b>PLT1M-L0</b>	Black	4.0	102	.100	2.5	.036	.9	.82	21	18	80	50	1000
<b>PLT1M-L1</b>	Brown	4.0	102	.100	2.5	.036	.9	.82	21	18	80	50	1000
<b>PLT1M-L2</b>	Red	4.0	102	.100	2.5	.036	.9	.82	21	18	80	50	1000
<b>PLT1M-L3</b>	Orange	4.0	102	.100	2.5	.036	.9	.82	21	18	80	50	1000
<b>PLT1M-L4Y</b>	Yellow	4.0	102	.100	2.5	.036	.9	.82	21	18	80	50	1000
<b>PLT1M-L5</b>	Green	4.0	102	.100	2.5	.036	.9	.82	21	18	80	50	1000
<b>PLT1M-L6</b>	Blue	4.0	102	.100	2.5	.036	.9	.82	21	18	80	50	1000
<b>PLT1M-L8</b>	Slate	4.0	102	.100	2.5	.036	.9	.82	21	18	80	50	1000

Note: CSA Certified on solid colors only.



## Telephone Cable Identification Kits

- Pan-Pouch™ Kit is made of two-ply laminated black nylon/vinyl and folds for easy storage
- Easily hang pouch from cable by using hook and loop fasteners
- Pocket pouch holds five (50-piece) packages and is made of a white vinyl



PPC25X50F



PP5X50F

Part Number	Description	Dimensions		Std. Pkg. Qty.
		Open	Closed	
PPC25X50F	Pouch filled with 1,250 cable ties (50 each of all 24 striped ties and 50 solid red ties)	10.5" x 38" (267mm x 965mm)	10.5" x 6" (267mm x 152mm)	1
PPC25X50	Empty pouch	10.5" x 38" (267mm x 965mm)	10.5" x 6" (267mm x 152mm)	1
PP5X50F	Pocket pouch filled with 250 cable ties (50 of each color: blue, orange, green, brown and slate – all with white stripe)	—	3.5" x 5.25" (89mm x 133mm)	1

## Cable Tie Kits in Steel Boxes



K-205



K-504/SR2

Part Number	Part Description	Std. Pkg. Qty.
K-205	<b>Kit for Indoor Use</b> Pan-Ty® Cable Ties, cable tie installation tool, terminals, splices and crimp tool: (1) GTS tool (1) CT-100 crimp tool <u>Natural Nylon 6.6 Cable Ties</u> (100) PLT1M (100) PLT1.5I (100) PLT2S <u>Terminals</u> (100) PV18-6LF (100) PV14-8LF (100) PV14-10LF (50) PV10-10LF <u>Splices</u> (50) BSV10X (100) BSV14X (100) BSV18X	1
K-504	<b>Kit for Indoor Use</b> Pan-Ty® Cable Ties, cable tie installation tool, and mounts: (1) STS2 tool <u>Natural Nylon 6.6 Cable Ties</u> (100) PLT1M (100) PLT1.5I (100) PLT2S (100) PLC2S-S10 <u>Mounts</u> (100) TM2S8 (100) ABM2S-A	1
SR2	Two-drawer slide rack to hold K-504 cable tie kit or K-1000 series terminal kit. Dimensions: 6.25"H x 15.25"W x 11.75"D (158.7mm x 387.4mm x 298.5mm)	1

A.  
System  
Overview

## Cable Tie Kits in Plastic Boxes and Bags

B1.  
Cable Ties

B2.  
Cable  
Accessories

B3.  
Stainless  
Steel Ties



**KP-506A**

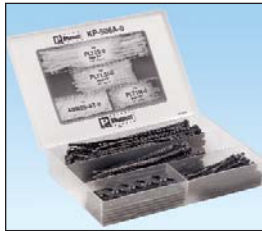

**KP-506A-0**



**KP-509**



**KB-550**



**KB-551**

C1.  
Wiring  
Duct

C2.  
Surface  
Raceway

C3.  
Abrasion  
Protection

C4.  
Cable  
Management

D1.  
Terminals

D2.  
Power  
Connectors

D3.  
Grounding  
Connectors

E1.  
Labeling  
Systems

E2.  
Labels

E3.  
Pre-Printed  
& Write-On  
Markers

E4.  
Permanent  
Identification

E5.  
Lockout/  
Tagout  
& Safety  
Solutions

F.  
Index

Part Number	Part Description	Std. Pkg. Qty.
<b>KP-506A</b>	<b>Kit for Indoor Use</b> Pan-Ty® Cable Ties and Mounts: <u>Natural Nylon 6.6</u> (100) PLT1M (100) PLT1.5I (100) PLT2S (50) ABM2S-A mounts	1
<b>KP-506A-0</b>	<b>Kit for Outdoor Use</b> Pan-Ty® Cable Ties and Mounts: <u>Black Weather Resistant Nylon 6.6</u> (100) PLT1M-0 (100) PLT1.5I-0 (100) PLT2S-0 (50) ABM2S-AT-0 mounts	1
<b>KP-509</b>	<b>Kit for Indoor Use</b> For prototyping and new product development – contains over 600 pieces. Pan-Ty® Cable Ties in different styles, sizes, and colors. Huge assortment of cable tie mounts and wiring accessories.	1
<b>KB-550</b>	<b>Assortment Pack for Indoor and Outdoor Use</b> Pan-Ty® Cable Ties: <u>Natural Nylon 6.6</u> (15) PLT1M (15) PLT1.5I (15) PLT2S (15) PLT3S <u>Black Weather Resistant Nylon 6.6</u> (10) PLT1M-0 (10) PLT1.5I-0 (10) PLT2S-0 (10) PLT3S-0	1
<b>KB-551</b>	<b>Assortment Pack for Indoor and Outdoor Use</b> Dome-Top® Barb Ty Cable Ties: <u>Natural Nylon 6.6</u> (15) BT1M (15) BT1.5I (15) BT2S (15) BT3S <u>Black Weather Resistant Nylon 6.6</u> (10) BT1M-0 (10) BT1.5I-0 (10) BT2S-0 (10) BT3S-0	1

## Features and Benefits – Hook and Loop Cable Ties

The comprehensive family of hook and loop cable ties delivers reliability by protecting against over-tensioning of high performance fiber and copper cables. These ties are adjustable, releasable, and re-usable to effectively support frequent moves, adds, and changes (MACs). A wide range of colors provides flexibility and an aesthetically pleasing appearance. The complete line of Panduit Hook and Loop Cable Ties help maintain the reliable, scalable, and aesthetic requirements of data centers.

### Tak-Ty® Hook & Loop Cable Ties – Premium, durable designs and sizes

#### Loop Style



Allows for pre-wrapping of bundles

#### Roll/Strip/Brick Style



Available in continuous or perforated rolls and stacked strips

#### Plenum-Rated



Distinctive maroon color (also available in black)

### Tak-Tape™ Hook & Loop Rolls



Strong, low profile hook and loop material

Convenient packaging



### Ultra-Cinch™ Hook & Loop Cable Ties



Unique same-sided material secures a greater range of bundle diameters

Available in three styles and eight colors; grommet styles used for bundle mounting applications

Low profile contoured cinch ring reduces overall bundle size



Wire management accessories speed and simplify the mounting of high performance cabling.

See pages B2.4, B2.5, B2.12, B2.21, B2.24, C4.4 – C4.6, C4.10, C4.11, C4.13, and C4.14.

A. System Overview

B1. Cable Ties

B2. Cable Accessories

B3. Stainless Steel Ties

C1. Wiring Duct

C2. Surface Raceway

C3. Abrasion Protection

C4. Cable Management

D1. Terminals

D2. Power Connectors

D3. Grounding Connectors

E1. Labeling Systems

E2. Labels

E3. Pre-Printed & Write-On Markers

E4. Permanent Identification

E5. Lockout/Tagout & Safety Solutions

F. Index

A. System Overview

## Selection Guide – Hook and Loop Cable Ties

B1. Cable Ties



B2. Cable Accessories

B3. Stainless Steel Ties

C1. Wiring Duct

Product, Color (Suffix)	Style/Function	Part Number Prefix	Catalog Page
-------------------------	----------------	--------------------	--------------

C2. Surface Raceway

Tak-Ty® Ties, Black (0)	Loop Ties/Re-usable	HLT	B1.87
	Strip Ties/Re-usable	HLS	B1.87
	15' and 75' Rolls/Re-usable	HLM, HLS	B1.87
	Strip Ties/Re-usable/Brick	HLB	B1.87

C3. Abrasion Protection

Tak-Ty® Plenum-Rated Ties, UL Listed Black, Maroon (0, 12)	Loop Ties/Re-usable	HLTP	B1.88
	Strip Ties/Re-usable	HLSP	B1.88

C4. Cable Management

Tak-Tape™ Rolls, Black (0)	20' and 35' Rolls/Re-usable	TTS	B1.88
----------------------------	-----------------------------	-----	-------

D1. Terminals

Ultra-Cinch™ Ties, Black (0)	Cinch Ties/Re-usable	UCT	B1.89
	Cinch Ties – Center Mount Grommet/Re-usable	UGCTC	B1.89
	Cinch Ties – End Mount Grommet/Re-usable	UGCTE	B1.89

D2. Power Connectors

D3. Grounding Connectors

E1. Labeling Systems

E2. Labels

E3. Pre-Printed & Write-On Markers

E4. Permanent Identification

E5. Lockout/Tagout & Safety Solutions

F. Index

### Part Number System for Hook and Loop Ties

HLT	2	I	—	X	0
Type	Size	Cross Section		Package Size	Color
HL = Hook and Loop	Approx. Maximum Bundle Dia. (In.)	I = Intermediate S = Standard		X = 10 C = 100 15R = 15' Roll 20R = 20' Roll 35R3 = 35' Rolls (3) 35RX = 35' Rolls (10) 75R = 75' Roll	See page B1.90
HLB = HL Brick					
HLM = HL Miniature					
HLT = HL Loop Tie					
HLTP = HL Loop Tie Plenum-Rated					
HLS = HL Strip Tie					
HLSP = HL Strip Tie Plenum-Rated					
TTS = Tak-Tape™ Roll					
UCT = Ultra-Cinch™ Tie					
UGCTC = UCT Grommet Cinch Tie – Center Mount					
UGCTE = UCT Grommet Cinch Tie – End Mount					

## Tak-Ty® Hook & Loop Cable Ties

- Soft, premium material is safe to use on high performance cabling protecting against over-tensioning
- Broadest selection of durable designs and sizes to meet your application needs
- Adjustable, releasable, and re-usable multiple times – ideal for applications requiring frequent moves, adds, or changes

- A full range of colors
- Operating temperature range: 0°F to 220°F (-18°C to 104°C)
- Complementary mounts available, see page B2.6

Note: Minimum 2" overlap required to achieve loop tensile rating.



HLT (Loop Ties)



HLS (Strip Ties)



HLM/HLS (Rolls)



HLB2S (Stacked Strips)



Part Number	Length		Width		Max. Bundle Dia.		Min. Loop Tensile Str.		Std. Pkg. Qty.	Std. Ctn. Qty.
	In.	mm	In.	mm	In.	mm	Lbs.	N		

### Loop Ties – Slot allows for pre-wrapping of bundles

<b>HLT21-X0</b>	8.0	203	0.500	12.7	1.91	49	40	178	10	100
<b>HLT31-X0</b>	12.0	305	0.500	12.7	3.18	81	40	178	10	100

### Strip Ties – Perforated in convenient 6", 12", and 18" strips

<b>HLS1.5S-X0</b>	6.0	152	0.750	19.1	1.50	38	50	222	10	100
<b>HLS3S-X0</b>	12.0	305	0.750	19.1	3.20	81	50	222	10	100
<b>HLS5S-X0</b>	18.0	457	0.750	19.1	5.00	127	50	222	10	100

### Stacked Strip Ties – Eliminates cutting ties to length and staging them for each job

Rounded edges for installer safety – 100 pieces

<b>HLB2S-C0</b>	7.0	178	0.750	19.1	1.60	41	50	222	1	10
-----------------	-----	-----	-------	------	------	----	----	-----	---	----

Part Number	Length		Width		Max. Bundle Dia.		Min. Loop Tensile Str.		Std. Pkg. Qty.	Std. Ctn. Qty.
	Ft.	m	In.	mm	In.	mm	Lbs.	N		

### 15' and 75' Continuous Rolls – Can be cut to desired length, eliminating waste

<b>HLM-15R0</b>	15.0	4.6	.330	8.4	Various	Various	40	178	1	10
<b>HLS-15R0</b>	15.0	4.6	.750	19.1	Various	Various	50	222	1	10
<b>HLS-75R0</b>	75.0	22.9	.750	19.1	Various	Various	50	222	1	10

A. System Overview

B1. Cable Ties

B2. Cable Accessories

B3. Stainless Steel Ties

C1. Wiring Duct

C2. Surface Raceway

C3. Abrasion Protection

C4. Cable Management

D1. Terminals

D2. Power Connectors

D3. Grounding Connectors

E1. Labeling Systems

E2. Labels

E3. Pre-Printed & Write-On Markers

E4. Permanent Identification

E5. Lockout/Tagout & Safety Solutions

F. Index

A. System Overview



## Tak-Ty® Hook & Loop Cable Ties – Plenum-Rated

B1. Cable Ties

- Soft, premium material is safe to use on high performance cabling protecting against over-tensioning
- UL Listed for use in plenum or air handling spaces (such as ceiling voids and underfloor areas) per NEC, Section 300-22 (C) and (D)
- Flammability rating: UL 94V-2

- Adjustable, releasable, and re-usable multiple times – ideal for applications requiring frequent moves, adds, or changes
- Operating temperature range: 0°F to 122°F (-18°C to 50°C)

Note: Minimum 2" overlap required to achieve loop tensile rating.

B2. Cable Accessories



B3. Stainless Steel Ties

C1. Wiring Duct



C2. Surface Raceway

Part Number	Length		Width		Max. Bundle Dia.		Min. Loop Tensile Str.		Std. Pkg. Qty.	Std. Ctn. Qty.
	In.	mm	In.	mm	In.	mm	Lbs.	N		
<b>UL Listed Loop Ties (Maroon) – Slot allows for pre-wrapping of bundles</b>										
HLTP2I-X12	8.0	203	.500	12.7	1.91	49	40	178	10	100
HLTP3I-X12	12.0	305	.500	12.7	3.18	81	40	178	10	100
<b>UL Listed Loop Ties (Black) – Slot allows for pre-wrapping of bundles</b>										
<b>HLTP2I-X0</b>	8.0	203	.500	12.7	1.91	49	40	178	10	100
HLTP3I-X0	12.0	305	.500	12.7	3.18	81	40	178	10	100
<b>UL Listed Strip Ties (Maroon) – Perforated in convenient 6", 12", and 18" strips</b>										
HLSP1.5S-X12	6.0	152	.750	19.1	1.50	38	50	222	10	100
HLSP3S-X12	12.0	305	.750	19.1	3.20	81	50	222	10	100
HLSP5S-X12	18.0	457	.750	19.1	5.00	127	50	222	10	100
<b>UL Listed Strip Ties (Black) – Perforated in convenient 6", 12", and 18" strips</b>										
<b>HLSP1.5S-X0</b>	6.0	152	.750	19.1	1.50	38	50	222	10	100
HLSP3S-X0	12.0	305	.750	19.1	3.20	81	50	222	10	100
HLSP5S-X0	18.0	457	.750	19.1	5.00	127	50	222	10	100

C3. Abrasion Protection

C4. Cable Management

D1. Terminals

D2. Power Connectors

D3. Grounding Connectors

E1. Labeling Systems

E2. Labels

E3. Pre-Printed & Write-On Markers

E4. Permanent Identification

E5. Lockout/Tagout & Safety Solutions

F. Index

## Tak-Tape™ Hook & Loop Cable Tie Rolls

- Strong, low profile, flexible material is safe to use on high performance cabling protecting against over-tensioning
- Adjustable, releasable, and re-usable
- Cost-effective for general purpose bundling
- Continuous rolls can be easily cut to size – Panduit cutter included with TTS-35RX0
- Handy, re-usable plastic case with TTS-20R0, keeps material clean

- Leaves no residue
- Available in black color
- Operating temperature range: -22°F to 194°F (-30°C to 90°C)
- Complementary mounts available, see page B2.6

Note: Minimum 2" overlap required to achieve loop tensile rating.



Part Number	Length		Width		Max. Bundle Dia.		Min. Loop Tensile Str.		Std. Pkg. Qty.	Std. Ctn. Qty.
	Ft.	m	In.	mm	In.	mm	Lbs.	N		
<b>TTS-20R0</b>	20.0	6.1	.750	19.1	Various	Various	40	178	1	10
<b>TTS-35R3-0</b>	35.0	10.7	.750	19.1	Various	Various	40	178	1	8
<b>TTS-35RX0</b>	35.0	10.7	.750	19.1	Various	Various	40	178	1	10

Std. Pkg. Qty. of TTS-35R3-0 denotes 1 package of three 35' rolls, TTS-35RX0 denotes 1 package of ten 35' rolls.

## Ultra-Cinch™ Hook & Loop Cable Ties

- Unique material with hooks and loops on same side allows user to secure a greater range of bundle diameters, including smaller bundles
- Soft, premium material is safe to use on high performance cabling, protecting against over-tensioning
- Adjustable, releasable, and re-usable multiple times – ideal for applications requiring frequent moves, adds, or changes
- Low profile contoured cinch ring provides extra strength and bundle tightness while reducing overall bundle size
- Grommet (UGCTC and UGCTE styles) offers strength and assures reliable installations that resist pullout when bundling and mounting cables within cabinet applications
- Tapered tip facilitates easy, snag-free threading to speed installation
- Use flat-head screws for grommet applications shown below

Note: Minimum 2" overlap required to achieve loop tensile rating.

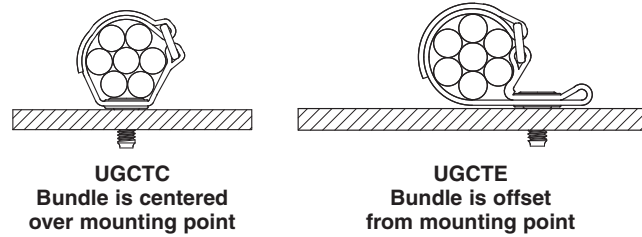
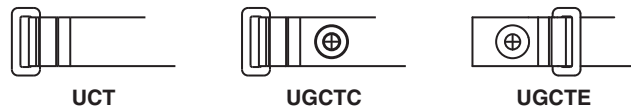

Part Number	Length		Width		Max. Bundle Dia.		Min. Loop Tensile Str.		Std. Pkg. Qty.	Std. Ctn. Qty.
	In.	mm	In.	mm	In.	mm	Lbs.	N		
<b>Cinch Ties</b>										
UCT3S-X0	12.0	305	.850	21.6	3.00	76	50	222	10	100
UCT5S-X0	18.0	457	.850	21.6	5.00	127	50	222	10	100
<b>Cinch Ties – Center Mount Grommet (Bundle is centered over mounting point)</b>										
UGCTC3S-X0	12.0	305	.850	21.6	3.00	76	50	222	10	100
UGCTC5S-X0	18.0	457	.850	21.6	5.00	127	50	222	10	100
<b>Cinch Ties – End Mount Grommet (Bundle is offset from mounting point)</b>										
UGCTE3S-X0	12.0	305	.850	21.6	3.00	76	50	222	10	100
UGCTE5S-X0	18.7	475	.850	21.6	5.00	127	50	222	10	100

Note: 1/4" (6mm) diameter mounting hole on grommet style cinch ties.

### Flat Head Screws for Grommet Cinch Ties

Part Number	Part Description	Std. Pkg. Qty.	Std. Ctn. Qty.
UCTGS1224-X	12-24 UNC x 5/8mm (.625") flat head phillips screw	10	100
UCTGSM5-X	M5 x 16mm flat head phillips screw	10	100
UCTGSM6-X	M6 x 16mm flat head phillips screw	10	100

A. System Overview

B1. Cable Ties

B2. Cable Accessories

B3. Stainless Steel Ties

C1. Wiring Duct

C2. Surface Raceway

C3. Abrasion Protection

C4. Cable Management

D1. Terminals

D2. Power Connectors

D3. Grounding Connectors

E1. Labeling Systems

E2. Labels

E3. Pre-Printed & Write-On Markers

E4. Permanent Identification

E5. Lockout/Tagout & Safety Solutions

F. Index

A.  
System  
Overview

## Hook and Loop Cable Ties

B1.  
Cable Ties

### Color Chart

Color	Panduit Suffix
Black	0
Red	2
Orange	3
Yellow	4
Green	5

Color	Panduit Suffix
Blue	6
Gray	8
White	10
Maroon	12

C1.  
Wiring  
Duct

C2.  
Surface  
Raceway

C3.  
Abrasion  
Protection

C4.  
Cable  
Management

D1.  
Terminals

D2.  
Power  
Connectors

D3.  
Grounding  
Connectors

E1.  
Labeling  
Systems

E2.  
Labels

E3.  
Pre-Printed  
& Write-On  
Markers

E4.  
Permanent  
Identification

E5.  
Lockout/  
Tagout  
& Safety  
Solutions

F.  
Index

### Part Number Availability List

Standard Packaging	
Part Number	Color
HLB2S	0
HLM-15R	0,2,3,4,5,6,8,10
HLS-15R	0,2,3,4,5,6,8,10
HLS-75R	0,2,3,4,5,6,8,10
HLS1.5S-X	0,2,3,4,5,6,8,10
HLS3S-X	0,2,3,4,5,6,8,10
HLS5S-X	0,2,3,4,5,6,8,10
HLSP1.5S-X	0,12
HLSP3S-X	0,12
HLSP5S-X	0,12
HLT2I-X	0,2,3,4,5,6,8,10
HLT3I-X	0,2,3,4,5,6,8,10
HLTP2I-X	0,12
HLTP3I-X	0,12
TTS-20R	0
TTS-35RX	0
TTS-35R3	0
UCT3S-X	0,2,3,4,5,6,8,10
UCT5S-X	0,2,3,4,5,6,8,10
UGCTC3S-X	0,2,3,4,5,6,8,10
UGCTC5S-X	0,2,3,4,5,6,8,10
UGCTE3S-X	0,2,3,4,5,6,8,10
UGCTE5S-X	0,2,3,4,5,6,8,10





## HLW Marker Hook and Loop Wrap Ties

- Safe choice for network cable bundling
- Re-usable multiple times; use where frequent moves, adds, and changes are anticipated

- Black tie contains a white rectangular "write-on" area where users can write a message using Panduit permanent marking pens on page B2.28
- Minimum 2" overlap required to achieve loop tensile rating



Part Number	Max. Bundle Diameter In. (mm)	Length In. (mm)	Width In. (mm)	Thickness In. (mm)	Marker Write-on Area In. (mm)	Min. Loop Tensile Strength Lbs. (N)	Std. Pkg. Qty.	Std. Ctn. Qty.
HLWM1.5S-X0	1.5 (38)	6.0 (152)	0.790 (20.1)	0.17 (4.3)	2.5 x 0.50 63.5 x 12.7	50 (222)	10	100
HLWM3S-X0	3.2 (81)	12.0 (305)	0.790 (20.1)	0.17 (4.3)	2.5 x 0.50 63.5 x 12.7	50 (222)	10	100

## Elastomeric Cable Ties – ERT



- Elastic material provides a flexible tie body that safely contours around cable bundle to prevent over-tensioning of data cables to maintain network integrity
- UL 94V-0 material provides greater flame resistance and meets stringent telecommunication flammability requirements (i.e. NEBS GR-63-CORE)
- Greater resistance to damage caused by ultraviolet light – indoor or outdoor use
- Soft material has no sharp edges to protect the installer and cable bundle for improved jobsite safety and reliability

- The high coefficient of friction material provides a tight grip and prevents lateral movement along cable bundle, minimizing overall installation time and potential re-work
- Releasable design allows release and re-use to accommodate frequent moves, adds, and changes to support evolving equipment and cabling needs
- Halogen-free, non-toxic and environmentally safe material will not release toxic or corrosive gases upon combustion
- Locking head design; the tapered tip tail threads into locking head to speed productivity; industry-accepted, intuitive tie design



Part Number	Color	Length In. (mm)	Width In. (mm)	Thickness In. (mm)	Head Height In. (mm)	Head Width In. (mm)	Min. Loop Tensile Strength Lbs. (N)	Std. Pkg. Qty.	Std. Ctn. Qty.
ERT2M-C20	Black	8.5 (216)	0.500 (12.70)	0.090 (2.29)	.323 (8.20)	.841 (21.36)	18 (80)	100	1000
ERT3M-C20	Black	11.0 (279)						100	1000
ERT4.5M-C20	Black	16.0 (406)						100	1000

A. System Overview

B1. Cable Ties

B2. Cable Accessories

B3. Stainless Steel Ties

C1. Wiring Duct

C2. Surface Raceway

C3. Abrasion Protection

C4. Cable Management

D1. Terminals

D2. Power Connectors

D3. Grounding Connectors

E1. Labeling Systems

E2. Labels

E3. Pre-Printed & Write-On Markers

E4. Permanent Identification

E5. Lockout/Tagout & Safety Solutions

F. Index



## Cable Bundle Organizing Tool

A. System Overview

B1. Cable Ties

B2. Cable Accessories

B3. Stainless Steel Ties

C1. Wiring Duct

C2. Surface Raceway

C3. Abrasion Protection

C4. Cable Management

D1. Terminals

D2. Power Connectors

D3. Grounding Connectors

E1. Labeling Systems

E2. Labels

E3. Pre-Printed & Write-On Markers

E4. Permanent Identification

E5. Lockout/Tagout & Safety Solutions

F. Index

- Reduces cable installation time up to 50% compared to traditional methods
- Arranges 24 cables prior to applying Panduit network cable ties
- Optimizes bundle size and improves installed appearance
- Two inserts handle multiple network cable diameters

- Unique design allows twist-free bundling from the end or the middle of bundle
- Smooth edges; safe for use on network cables preventing cable abrasion
- Ergonomic fit and compact design
- Impact resistant material and low friction design to glide smoothly across cable bundle



Part Number	Description	Recommended for Cable Outer Diameter Range	Use the Following Insert	Insert Used with the Following Panduit Cable Types	Std. Pkg. Qty.	Std. Ctn. Qty.
CBOT24K	Kit contains jacket cover with hook and loop fastener and two inserts.	0.180" – 0.248" (4.57mm – 6.30mm)	Fluorescent Green	TX5500™ Category 5e UTP TX6000™ Category 6 UTP	1	10
		0.230" – 0.310" (5.84mm – 7.87mm)	Fluorescent Yellow	TX6500™ Enhanced Category 6 TX6A™ 10Gig™ Category 6A** All Shielded Cables		

\*\*When using the CBOT24K on 10 Gigabit cables, it is recommended that Panduit 10Gig™ Category 6A cables be used for optimum performance of installed cable. See [www.panduit.com](http://www.panduit.com) for cable details.

## Installation Instructions

The steps below outline how easy it is to use the Panduit cable bundle organizing tool starting from the middle of the bundle outwards, using two tools. For starting at the end of the bundle, follow the same steps using only one tool. (Use above table to select appropriate insert based on cable diameter/type.)



### Step 1

Use the unique pocket and boss features to align two same color inserts. Hold both together.



### Step 2

Insert cables, one at a time, into the pre-formed slots of both inserts until all cables are installed.

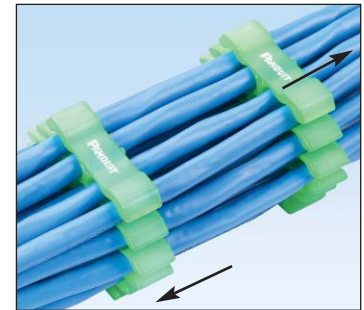

### Step 3

Pull the two inserts apart.



### Step 4

Place the jacket cover around each insert and secure with the attached hook and loop fastener.



### Step 5

Guide the tool along the bundle length to organize the cables, stopping at desired intervals to apply Panduit Network Cable Ties.



### Step 6

When completed, slide tool off of cable bundle. The Panduit cable bundle organizing tool reduces installation time up to 50% and delivers a professional, organized installation.

## Hot Stamping Service Custom Printed Cable Ties

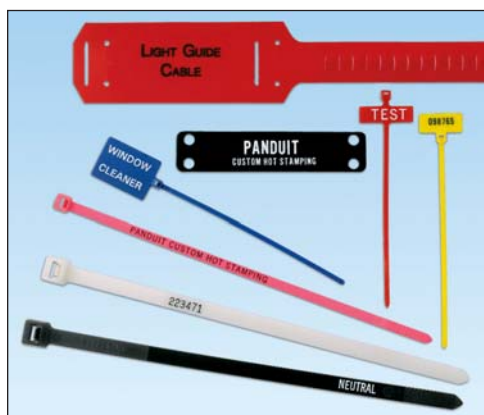

Custom Hot Stamping Service provides a permanent, high quality imprinted message on Panduit cable ties and marker plates. Graphics, text, numbers and colors provide a variety of choices for customization.

Hot stamped cable ties and marker plates are typically used for identification, or for labeling critical components. Panduit cable ties, marker ties, marker plates and marker straps are available to suit your application.

Your choice of:

- Seven text colors (black, blue, green, red, yellow, orange, white)
- A variety of characters and fonts
- Sequential numbering
- Special customer logos and diagrams

### FAST! TWO WEEK LEAD TIME

Minimum Order: (Pieces/part number and message)

- 5,000 for Miniature\*, Intermediate, Standard and Heavy-Standard cross section cable ties
- 3,000 for Light-Heavy, Heavy, and Extra-Heavy cross section cable ties
- 3,000 for Hook and Loop Wrap Ties

For hot stamping orders and inquiries, please call 1-800-777-3300



### Cable Ties

- Used wherever you need to bundle wire, cable, hose or tubing
- A variety of colors for color-coding applications
- Cross Sections: Intermediate, Standard, Heavy-Standard, Light-Heavy, Heavy and Extra-Heavy

### Marker and Flag Ties

- Fasten and identify bundles at the same time
- A variety of colors for color-coding applications
- Cross Sections: Miniature and Standard

### Marker Plates

- Mount in any direction, either vertically or horizontally as flags, tags, or wrap-around identification plates.
- White or Weather Resistant black color
- Marker plate sizes:
 

1.50" x .75"	2.50" x .75"
1.75" x .75"	3.50" x .75"
2.00" x .75"	2.50" x 1.75"

### Cable Marker Straps

- Identify and code telephone and fiber optic cable – replaces costly and cumbersome lead marking tags
- Lightweight and easy to install
- Can be used as **wrap-around** or **flag** marker
- Also can be used in underground identification applications
- Polyethylene material available in red and gray
- Marking area: 1.50" x 2.62"

\*Custom imprinting available on Miniature cross section for the Flag Style Cable Ties (PLF) only.



## Panduit Cable Tie Approvals

	Logo (Symbol)	Agency	Spec/Approval	Requirement	Applicable Products
B1. Cable Ties		Underwriters Laboratories, Inc.	File E56854 and MH29590	ZODZ(7), ZODZ(8), ALKW	Most miniature, intermediate, standard, light-heavy and heavy cross section ties are Recognized or Listed in the US and Canada
B2. Cable Accessories		Canadian Standards Association	File 031212	C22.2 No. 18.5-02 under the category "Fittings – Positioning Devices"	Most miniature, intermediate, standard, light-heavy and heavy cross section ties are Recognized or Listed in the US and Canada
B3. Stainless Steel Ties		Conformity European	Low Voltage Directive 73/23/EEC (amended 93/68/EEC). PAN-TY AND Dome-Top Barb Ty cable ties also meet the requirements from EN50146	CE Marking is required for products sold within the European Union. CE Marking Directives specify the minimum performance of these products. Applying the CE mark signifies compliance with essential requirements of specific directives.	All cable tie products
C1. Wiring Duct		ABS (American Bureau of Shipping)	05-HS463235-PDA	2005 Vessel Rules 1-1-4/7.7, 4-8/421.9.3 2001 MODU Rules 4-3-3/5.9.1	PLT Series, BT Series
C2. Surface Raceway		Bureau Veritas	Cert 05968/C0 BV1178B/BVN/04 File ACE 14/601/01	Bureau Veritas Rules for the Classification of Steel Ships	PLT Series, BT Series, PRT Series, CBR Series
C3. Abrasion Protection		Det Norske Veritas	E-6405	Det Norske Veritas' Rules for Classification of Ships and Mobile Offshore Units	PLT Series, PLC Series, PLM Series, PRT Series, PLWP Series, PRWP Series, PRST Series
C4. Cable Management		Germany (VG) Military	K17/97165	VG 95 387 – 100 MS 3367F	PLT Series, BT Series, SST Series
D1. Terminals		Lloyd's Register of Shipping	89/60111 (E3)	Lloyd's Register Type Approval	PLT Series, BT Series, SST Series
D2. Power Connectors		NRC (Nuclear Regulatory Commission)	NRC 10CFR50	Quality Assurance Criteria for Nuclear Plants and Reprocessing Plants	All cable tie products
D3. Grounding Connectors		Plenum-Rated	Panduit logo	Panduit symbol indicates that the cable ties represented are suitable for use in plenum or air handling spaces in accordance with Sec. 300.22(C) and (D) of the National Electrical Code and Rules 12-010 (3), (4) and (5) and 12-020 of the Canadian Electrical Code, Part I.	Halar (702Y) and select Nylon 6.6 cable ties as noted throughout catalog
E1. Labeling Systems		US Military Aerospace Standard	QPL-AS23190-2	SAE spec AS23190	See Military Cross Reference Page B1.95
E2. Labels		AQA International	ISO/TS16949	AQA registration. Quality management system assessment certificate	Tinley Park, Illinois Manufacturing Operations (Cable Tie Division) Quality Management System.
E3. Pre-Printed & Write-On Markers					
E4. Permanent Identification					
E5. Lockout/Tagout & Safety Solutions					
F. Index					

## Military Cross Reference

The Panduit cable ties and marker ties listed in the following tables meet all of the testing requirements of Aerospace Standard SAE-AS23190A (formerly MIL-S-23190E) and the dimensional requirements of Aerospace Standards SAE-AS33671 (formerly MS3367) and SAE-AS33681 (formerly MS3368).

Cable Tie Cross Reference						
Mil. Std. Part Number	Color	Pan-Ty®	Dome-Top® Barb Ty	Sta-Strap®	Belt-Ty™ In-Line	Contour-Ty®
MS3367-1-0	Black*	PLT2S-C00, -M00	—	—	—	—
MS3367-1-1	Brown	PLT2S-C1, -M1	BT2S-M1	—	—	—
MS3367-1-2	Red	PLT2S-C2, -M2	BT2S-M2	—	—	—
MS3367-1-3	Orange	PLT2S-C3, -M3	BT2S-M3	—	—	—
MS3367-1-4	Yellow	PLT2S-C4Y, -M4Y	BT2S-M4Y	—	—	—
MS3367-1-5	Green	PLT2S-C5, -M5	BT2S-M5	—	—	—
MS3367-1-6	Blue	PLT2S-C6, -M6	BT2S-M6	—	—	—
MS3367-1-7	Purple	PLT2S-C7, -M7	BT2S-M7	—	—	—
MS3367-1-8	Gray	PLT2S-C8, -M8	BT2S-M8	—	—	—
MS3367-1-9	Natural	PLT2S-C, -M, -VMR	BT2S-C, -M	SST2S-C, -M	—	—
MS3367-2-0	Black*	PLT4S-C00, -M00	—	—	—	—
MS3367-2-1	Brown	PLT4S-M1	—	—	—	—
MS3367-2-2	Red	PLT4S-C2, -M2	BT4S-M2	SST4S-M2	—	—
MS3367-2-3	Orange	PLT4S-C3, -M3	BT4S-M3	—	—	—
MS3367-2-4	Yellow	PLT4S-C4Y, -M4Y	BT4S-M4Y	—	—	—
MS3367-2-5	Green	PLT4S-C5, -M5	BT4S-M5	—	—	—
MS3367-2-6	Blue	PLT4S-C6, -M6	BT4S-M6	—	—	—
MS3367-2-7	Purple	PLT4S-C7, -M7	BT4S-M7	—	—	—
MS3367-2-8	Gray	PLT4S-C8, -M8	BT4S-M8	—	—	—
MS3367-2-9	Natural	PLT4S-C, -M	BT4S-C, -M	SST4S-C, -M	—	—
MS3367-3-0	Black*	PLT4H-L00, -TL00	—	—	—	—
MS3367-3-1	Brown	PLT4H-TL1	—	—	—	—
MS3367-3-2	Red	PLT4H-TL2	—	—	—	—
MS3367-3-3	Orange	PLT4H-TL3	—	—	—	—
MS3367-3-4	Yellow	PLT4H-TL4Y	—	—	—	—
MS3367-3-5	Green	PLT4H-TL5	—	—	—	—
MS3367-3-6	Blue	PLT4H-TL6	—	—	—	—
MS3367-3-9	Natural	PLT4H-L, -C, -TL	BT4LH-L, -TL	SST4H-L, -D	—	—
MS3367-4-0	Black*	PLT1M-C00, -M00, -XMR00	—	—	—	—
MS3367-4-0	Black*	PLT1.5M-XMR00	—	—	—	—
MS3367-4-1	Brown	PLT1M-C1, -M1, -XMR1	BT1M-M1	—	—	—
MS3367-4-2	Red	PLT1M-C2, -M2, -XMR2	BT1M-M2	—	—	—
MS3367-4-3	Orange	PLT1M-C3, -M3, -XMR3	BT1M-M3	—	—	—
MS3367-4-4	Yellow	PLT1M-C4Y, -M4Y, -XMR4Y	BT1M-M4Y	—	—	—
MS3367-4-5	Green	PLT1M-C5, -M5, -XMR5	BT1M-M5	—	—	—
MS3367-4-6	Blue	PLT1M-C6, -M6, -XMR6	BT1M-M6	—	—	—
MS3367-4-7	Purple	PLT1M-C7, -M7, -XMR7	BT1M-M7	—	—	—
MS3367-4-8	Gray	PLT1M-C8, -M8, -XMR8	BT1M-M8	—	—	—
MS3367-4-9	Natural	PLT1M-C, -M, -XMR	BT1M-C, -M, -XMR	SST1M-C, -M	—	—
MS3367-4-9	Natural	PLT.7M-C, -M	—	—	—	—
MS3367-4-9	Natural	PLT1.5M-XMR	BT1.5M-XMR	—	—	—
MS3367-5-0	Black*	PLT1.5I-M00	—	—	—	—
MS3367-5-1	Brown	PLT1.5I-C1, -M1	BT1.5I-M1	—	—	—
MS3367-5-2	Red	PLT1.5I-C2, -M2	BT1.5I-M2	—	—	—
MS3367-5-3	Orange	PLT1.5I-C3, -M3	BT1.5I-M3	—	—	—
MS3367-5-4	Yellow	PLT1.5I-C4Y, -M4Y	BT1.5I-M4Y	—	—	—

\*Weather resistant per ASTM D 4066-94B.

Table continues on page B1.96

A.  
System  
Overview

## Military Cross Reference (continued)

B1.  
Cable Ties

B2.  
Cable  
Accessories

B3.  
Stainless  
Steel Ties

C1.  
Wiring  
Duct

C2.  
Surface  
Raceway

C3.  
Abrasion  
Protection

C4.  
Cable  
Management

D1.  
Terminals

D2.  
Power  
Connectors

D3.  
Grounding  
Connectors

E1.  
Labeling  
Systems

E2.  
Labels

E3.  
Pre-Printed  
& Write-On  
Markers

E4.  
Permanent  
Identification

E5.  
Lockout/  
Tagout  
& Safety  
Solutions

F.  
Index

### Cable Tie Cross Reference

Mil. Std. Part Number	Color	Pan-Ty®	Dome-Top® Barb Ty	Sta-Strap®	Belt-Ty™ In-Line	Contour-Ty®
MS3367-5-5	Green	PLT1.5I-C5, -M5	BT1.5I-M5	—	—	—
MS3367-5-6	Blue	PLT1.5I-C6, -M6	BT1.5I-M6	—	—	—
MS3367-5-7	Purple	PLT1.5I-C7, -M7	BT1.5I-M7	—	—	—
MS3367-5-8	Gray	PLT1.5I-C8, -M8	BT1.5I-M8	—	—	—
MS3367-5-9	Natural	PLT1.5I-C, -M	BT1.5I-C, -M	SST1.5I-C, -M	—	—
MS3367-6-9	Natural	PLT8LH-L, -C	BT8LH-L, -C	SST8H-L, -D	—	—
MS3367-6-9	Natural	—	BT9LH-L, -C	—	—	—
MS3367-7-0	Black*	PLT3S-C00, -M00	—	—	—	—
MS3367-7-1	Brown	PLT3S-M1	—	—	—	—
MS3367-7-2	Red	PLT3S-C2, -M2	BT3S-C2	—	—	—
MS3367-7-3	Orange	PLT3S-M3	—	—	—	—
MS3367-7-4	Yellow	PLT3S-M4Y	—	—	—	—
MS3367-7-5	Green	PLT3S-M5	—	—	—	—
MS3367-7-6	Blue	PLT3S-M6	—	—	—	—
MS3367-7-7	Purple	PLT3S-M7	—	—	—	—
MS3367-7-8	Gray	PLT3S-M8	—	—	—	—
MS3367-7-9	Natural	PLT3S-C, -M	BT3S-C, -M	SST3S-C, -M	—	—
MS3367-8-9	Natural	PLT5H-L, -C	—	—	—	—
MS3367-9-9	Natural	PLT6H-L, -C	—	—	—	—
MS3367-11-9	Natural	PLT8H-L, -C	—	—	—	—
MS3367-14-9	Natural	PLT13H-Q, -C	—	—	—	—
MS3367-20-9	Natural	PLT5EH-Q, -C	—	—	—	—
MS3367-21-9	Natural	PLT6EH-Q, -C	—	—	—	—
MS3367-22-9	Natural	PLT8EH-C	—	—	—	—
MS3367-23-9	Natural	—	—	—	ILT2S-C, -M	—
MS3367-24-9	Natural	—	—	—	ILT4S-C, -M	—
MS3367-25-9	Natural	—	—	—	ILT4LH-TL	—
MS3367-29-9	Natural	—	—	—	ILT3S-C, -M	—
MS3367-30-9	Natural	—	—	—	—	CBR1M-M
MS3367-31-9	Natural	—	—	—	—	CBR1.5M-M
MS3367-32-1	Brown	—	—	—	—	CBR2M-M1
MS3367-32-2	Red	—	—	—	—	CBR2M-M2
MS3367-32-3	Orange	—	—	—	—	CBR2M-M3
MS3367-32-4	Yellow	—	—	—	—	CBR2M-M4Y
MS3367-32-5	Green	—	—	—	—	CBR2M-M5
MS3367-32-6	Blue	—	—	—	—	CBR2M-M6
MS3367-32-7	Purple	—	—	—	—	CBR2M-M7
MS3367-32-9	Natural	—	—	—	—	CBR2M-M
MS3367-33-9	Natural	—	—	—	—	CBR1.5I-M
MS3367-34-1	Brown	—	—	—	—	CBR3I-M1
MS3367-34-2	Red	—	—	—	—	CBR3I-M2
MS3367-34-3	Orange	—	—	—	—	CBR3I-M3
MS3367-34-4	Yellow	—	—	—	—	CBR3I-M4Y
MS3367-34-5	Green	—	—	—	—	CBR3I-M5
MS3367-34-6	Blue	—	—	—	—	CBR3I-M6
MS3367-34-7	Purple	—	—	—	—	CBR3I-M7
MS3367-34-8	Gray	—	—	—	—	CBR3I-M8
MS3367-34-9	Natural	—	—	—	—	CBR3I-M
MS3367-35-9	Natural	—	—	—	—	CBR4I-M

\*Weather resistant per ASTM D 4066-94B.

### Cable Tie Cross Reference

Mil. Std. Part Number	Color	Pan-Ty®	Dome-Top® Barb Ty	Sta-Strap®	Belt-Ty™ In-Line	Contour-Ty®
MS3367-36-9	Natural	—	—	—	—	CBR2S-M
MS3367-37-9	Natural	—	—	—	—	CBR3S-M
MS3367-38-9	Natural	—	—	—	—	CBR4S-M
MS3367-39-9	Natural	—	—	—	—	CBR2HS-D
MS3367-40-9	Natural	—	—	—	—	CBR4LH-TL
MS3367-41-9	Natural	—	—	—	—	CBR6LH-C
MS3368-1-2A	Red	PLM2S-D2	—	—	—	—
MS3368-1-3A	Orange	PLM2S-D3	—	—	—	—
MS3368-1-4A	Yellow	PLM2S-C4Y, -D4Y	—	—	—	—
MS3368-1-5A	Green	PLM2S-D5	—	—	—	—
MS3368-1-6A	Blue	PLM2S-D6	—	—	—	—
MS3368-1-8A	Gray	PLM2S-D8	—	—	—	—
MS3368-1-9A	Natural	PLM2S-C, -D	BM2S-C, -D	—	—	—
MS3368-1-9B	Natural	—	—	SSM2S-C, -D	—	—
MS3368-2-2A	Red	PLM4S-D2	—	—	—	—
MS3368-2-4A	Yellow	PLM4S-D4Y	—	—	—	—
MS3368-2-6A	Blue	PLM4S-D6	—	—	—	—
MS3368-2-9A	Natural	PLM4S-C, -D	BM4S-C, -D	—	—	—
MS3368-2-9B	Natural	—	—	SSM4S-D	—	—
MS3368-3-4C	Yellow	PL2M2S-D4Y	—	—	—	—
MS3368-3-9C	Natural	PL2M2S-L, -D	B2M2S-D	—	—	—
MS3368-4-4D	Yellow	PL3M2S-D4Y	—	—	—	—
MS3368-4-9D	Natural	PL3M2S-L, -D	B3M2S-TL	—	—	—
MS3368-5-1E	Brown	PLM1M-M1	—	—	—	—
MS3368-5-2E	Red	PLM1M-M2	—	—	—	—
MS3368-5-3E	Orange	PLM1M-M3	—	—	—	—
MS3368-5-4E	Yellow	PLM1M-M4Y	—	—	—	—
MS3368-5-5E	Green	PLM1M-M5	—	—	—	—
MS3368-5-6E	Blue	PLM1M-M6	—	—	—	—
MS3368-5-7E	Purple	PLM1M-M7	—	—	—	—
MS3368-5-8E	Gray	PLM1M-M8	—	—	—	—
MS3368-5-9E	Natural	PLM1M-C, -M	BM1M-C, -M	—	—	—

## Installation Tools

The Panduit installation tools listed in the table below meet all of the testing requirements of MIL-T-81306 and the dimensional requirements of MS90387.

Mil. Spec. Part Number	Panduit Part Number
MS90387-1	GTS, GS2B
MS90387-2	GS4H, GTH
MS90387-4	GS4EH
MS90387-5	GTSL

A.  
System  
Overview

## Cable Tie Selection and Specification Guidelines

B1.  
Cable Ties

### Selecting the Proper Cable Tie Material for Your Application

B2.  
Cable  
Accessories

By using the information on our material selection chart on pages B1.2 and B1.3 as a guide, the user will be better equipped to select the best cable tie and material suited to perform its intended function over a long period of time.

B3.  
Stainless  
Steel Ties

For long life and dependable service, there are many factors to consider when selecting the proper cable tie for each application. Since it is impossible for Panduit to provide data on all the various combinations of conditions which may arise, it is suggested that this data be used as a guide. Sample cable ties should be tested under actual end-use conditions to determine the correct cable tie for the application.

C1.  
Wiring  
Duct

To select the optimum cable tie for a specific application, the chart on pages B1.2 and B1.3 can be used as a reference. First, determine the most critical design criteria and then read across the table to find which material is most suitable to meet this need. Next, review the other criteria by scanning in a vertical direction on the chart and then make your final selection.

C2.  
Surface  
Raceway

#### Example No. 1

Application	Selection
The application requires high radiation (2 x 10 <sup>6</sup> rads) resistance and excellent resistance to hydrocarbons.	The best choice is PEEK, TEFZEL <sup>■</sup> , or HALAR <sup>▲</sup> . The price is higher than other materials, but all have high ratings in resistance to radiation and hydrocarbons.

C3.  
Abrasion  
Protection

#### Example No. 2

Application	Selection
The application requires a low cost material, good ultraviolet resistance, and good resistance to acid rains.	The best choice is Weather Resistant Polypropylene. Price is medium, the UV rating is 6, and the acid resistance rating is 9.

C4.  
Cable  
Management

D1.  
Terminals

■TEFZEL is a registered trademark of E.I. du Pont de Nemours and Company.  
▲HALAR is a registered trademark of Ausimont USA, Inc.

D2.  
Power  
Connectors

D3.  
Grounding  
Connectors

E1.  
Labeling  
Systems

E2.  
Labels

E3.  
Pre-Printed  
& Write-On  
Markers

E4.  
Permanent  
Identification

E5.  
Lockout/  
Tagout  
& Safety  
Solutions

F.  
Index



## Weathering

Over a period of time, ultraviolet light (a component of sunlight) attacks most plastic materials and reduces their properties by breaking the molecular chain. The material breakdown is accompanied by reductions in tensile strength and elongation, increased brittleness, color changes and loss of surface gloss.

Carbon black, which is used in Panduit nylon, polypropylene, and acetal cable ties, is one of the most effective stabilizers known today. A uniform dispersion of carbon black provides good ultraviolet light resistance without adversely affecting physical properties. The addition of carbon black, or any other ultraviolet light stabilizer, prolongs the useful outdoor life of plastic products, but it does not totally eliminate the destructive effects of the light. Some plastics, such as TEFZEL<sup>■</sup> or HALAR<sup>▲</sup>, are intrinsically very resistant to ultraviolet light and do not require stabilizing additives.

### Weathering Test Methods

In order to monitor the effects of ultraviolet light and the effectiveness of ultraviolet stabilizers, Panduit, in conformance with industry standards, adopted two methods of weatherability testing: Outdoor Aging and Accelerated Weather Aging.

### Outdoor Aging

The Outdoor Aging method is probably the best and most realistic method of the two. It is conducted in accordance with ASTM D 1435 Standard Practice for Outdoor Weathering of Plastics, and allows the material to be affected by not only ultraviolet light, but by all other outdoor elements as well. Although this may more closely approximate an actual application, two drawbacks do exist. The period of time required to produce property decay and material failure may be quite long, and varying adverse chemical environments cannot be tested.

### Accelerated Weather Aging

Accelerated weathering tests are conducted to estimate the rate of degradation due to a combination of ultraviolet light, temperature, and moisture. The methods used are in accordance with the following standards:

- ASTM D 1499, Operating Light and Water Exposure Apparatus (Carbon-Arc type) for exposure to plastics
- ASTM G 154-04, Operating Light and Water Exposure (Fluorescent UV Condensation type) for exposure of non-metallic materials

The condition specified in ASTM D 1499 utilizes a water spray and a carbon arc to simulate natural sunshine. The test chamber is operated 20 hrs./day with a two-hour cycle of 108 minutes of simulated sunshine and twelve minutes of sunshine and water spray. The temperature of a black body inside the chamber is approximately 63°C (145°F) during the “sunshine only” portion of the cycle. Humidity is not controlled inside the chamber.

The test chamber per ASTM G 154-04 uses fluorescent sun lamps to generate ultraviolet light only. A heated water pan produces condensation during a portion of the cycle. The daily cycle is composed of 20 hours of light followed by 4 hours of condensation. Black body temperatures during the light cycle are 50°C (122°F) and 40°C (104°F) during the condensation cycle.

Panduit has also designed a special chamber, which is used to simulate the effect of acid rain and ultraviolet light on cable tie materials. The effects of other common chemicals, such as road salt, are also evaluated in this chamber.

These methods are effective in quickly determining the ultraviolet light resistance of the various cable tie materials, but it must be emphasized that there are no exact correlations between accelerated aging and actual outdoor exposure.

<sup>■</sup>TEFZEL is a registered trademark of E.I. du Pont de Nemours and Company.

<sup>▲</sup>HALAR is a registered trademark of Ausimont USA, Inc.

A.  
System  
Overview

B1.  
Cable Ties

B2.  
Cable  
Accessories

B3.  
Stainless  
Steel Ties

C1.  
Wiring  
Duct

C2.  
Surface  
Raceway

C3.  
Abrasion  
Protection

C4.  
Cable  
Management

D1.  
Terminals

D2.  
Power  
Connectors

D3.  
Grounding  
Connectors

E1.  
Labeling  
Systems

E2.  
Labels

E3.  
Pre-Printed  
& Write-On  
Markers

E4.  
Permanent  
Identification

E5.  
Lockout/  
Tagout  
& Safety  
Solutions

F.  
Index

A.  
System  
Overview

## Weathering (continued)

B1.  
Cable Ties

### Material Failure Testing

Property decay can lead to three different modes of failure: loss of strength, loss of toughness, or change in appearance. The critical mode for any given application would depend upon the application and the requirements it places upon the material itself.

B2.  
Cable  
Accessories

Loss of strength is monitored by tensile testing samples of the material before and after it has been weathered. This test will reveal the decreasing strength accompanied by extended weathering.

B3.  
Stainless  
Steel Ties

Loss of toughness can be monitored by measuring changes in elongation and impact strength. As ultraviolet light exposure time increases and the material becomes brittle, its elongation and impact strength are greatly reduced. It is important to note that brittle failures can occur even when the tensile strength shows no change.

C1.  
Wiring  
Duct

Although change in appearance is normally not a failure mode for cable ties, the plastic does tend to discolor and lose its surface gloss as exposure increases. These changes can be measured by color difference using Adams units, which are similar to National Bureau of Standard units.

C2.  
Surface  
Raceway

Panduit has its own weathering test program to determine estimated life of various cable tie materials. This includes examining many previously aged samples obtained throughout the world.

C3.  
Abrasion  
Protection

In all cases, the amount of property decay increased with increasing exposure to ultraviolet light. The principal signs of degradation were found to be brittleness, cracking, and loss of surface gloss. It was also determined that the time for failure to occur was shorter than indicated from industry tests performed on material samples. This discrepancy is in part due to the fact that cable ties were tested in an end use, stressed condition, while most plastic resin suppliers conduct weathering tests using unstressed test bars.

C4.  
Cable  
Management

Five cable tie materials have superior ultraviolet light resistance: TEFZEL<sup>■</sup>, HALAR<sup>▲</sup>, Weather Resistant Acetal, Nylon 12 and Stainless Steel.

D1.  
Terminals

Determining the outdoor life expectancy of any material is difficult since there are other factors, besides ultraviolet light stability, which have to be considered. These factors are listed below and should be considered before specifying a cable tie material.

D2.  
Power  
Connectors

**Table A – External Factors That Affect the Life of a Cable Tie**

Factor	Effect on Cable Tie Life
Chemicals	Applications which have chemicals present can reduce the life of a tie. <b>This is the most detrimental factor to the life of a tie.</b>
Bundle diameter	As the bundle diameter is reduced, the tie has more bending stress. A thick strap on a small bundle diameter has more stress.
Loading	If the tie is under high loading, this will add additional stress on the tie body.
Thickness	A thinner tie will have a decreased life since surface cracks will penetrate the thickness of the tie faster.
Vibration	Applications with high vibrations will cause impact, which will propagate any surface cracks.
Degree of exposure	No shield or shade, southern exposure, higher altitudes and high temperatures, decrease the life of a cable tie.
Moisture	High humidity plus high temperature can result in degradation due to hydrolysis in nylon.
Galvanized metals	Acid rain and acid moisture acting on galvanized metals release chemicals known to attack Nylon 6.6.

Weathering Life Expectancy	
Material, Color (Part Number Suffix)	Years*
Polypropylene, Green (109)	1
Nylon 6.6, Natural (No suffix)	1 – 2
Flame Retardant Nylon 6.6, Black (60)	1 – 2
Flame Retardant Nylon 6.6, Ivory (69)	1 – 2
Heat Stabilized Nylon 6.6, Natural (39)	1 – 2
PEEK, Polyetheretherketone, Translucent Brown (71)	1 – 2
Heat Stabilized Nylon 6.6, Black (30)	4 – 5
Weather Resistant Polypropylene, Black (100)	7 – 9
Weather Resistant Nylon 6.6, Black (0 and 00)	7 – 9
Heat Stabilized Weather Resistant Nylon 6.6, Black (300)	7 – 9
Weather Resistant Nylon 12, Black (120)	12 – 15
TEFZEL <sup>■</sup> , Aqua Blue (76)	>15
HALAR <sup>▲</sup> , Maroon (702Y)	>15
Weather Resistant Acetal, Black	>20
Stainless Steel	>30

\*Based on the assumption of minimum loading, no chemical attack and impact-free conditions.

■TEFZEL is a registered trademark of E.I. du Pont de Nemours and Company.

▲HALAR is a registered trademark of Ausimont USA, Inc.

## Flammability

### Flammability

A number of test procedures have been developed which can be used for the evaluation and comparison of various materials to support combustion.

### UL 94 Vertical Burning Test

Samples of a material, with dimensions 127mm by 12.7mm and the thickness of the intended end use product, are tested in an unaged “as manufactured” state and in an aged state (seven days at 158°F, 70°C). The test requires the placement of a precisely controlled flame under a vertically supported specimen for a ten second period. The controlled flame is removed and the duration of flaming combustion of the specimen is recorded. When the flaming combustion of the specimen extinguishes, it is immediately subjected to an additional controlled flame exposure. After the additional ten seconds of exposure, the controlled flame is removed, and the duration of flaming combustion of the specimen is recorded. A piece of surgical cotton is placed under the specimen. If drips ignite the cotton, this fact is also recorded.

### Materials Classed 94V-0

Requirements:

- None of the specimens will burn with flaming combustion for more than ten seconds after either application of the controlled flame
- The total flaming combustion time will not exceed 50 seconds for the ten controlled flame applications (two controlled flame applications for each of the five specimens)
- None of the specimens will burn with flaming or glowing combustion up to the holding clamp
- None of the specimens will drip flaming particles that ignite the dry absorbent surgical cotton located 12 inches (305mm) below the test specimen
- None of the specimens will exhibit glowing combustion that persists for more than 30 seconds after the second removal of the controlled flame

### Materials Classed 94V-1

Requirements:

- None of the specimens will burn with flaming combustion for more than 30 seconds after either application of the controlled flame
- The total flaming combustion time will not exceed 250 seconds for the ten controlled flame applications (two controlled flame applications for each of the five specimens)
- None of the specimens will burn with flaming or glowing combustion up to the holding clamp
- Specimens may drip flaming particles which burn only briefly, and may not ignite the dry absorbent surgical cotton located 12 inches (305mm) below the test specimen
- None of the specimens will exhibit glowing combustion that persists for more than 60 seconds after the second removal of the controlled flame

### Materials Classed 94V-2

Requirements:

- None of the specimens will burn with flaming combustion for more than 30 seconds after either application of the controlled flame
- The total flaming combustion time will not exceed 250 seconds for the ten controlled flame applications (two controlled flame applications for each of the five specimens)
- None of the specimens will burn with flaming or glowing combustion up to the holding clamp
- Specimens may drip flaming particles which burn only briefly, and may ignite the dry absorbent surgical cotton placed 12 inches (305mm) below the test specimen
- None of the specimens will exhibit glowing combustion that persists for more than 60 seconds after the second removal of the controlled flame

A.  
System  
Overview

B1.  
Cable Ties

B2.  
Cable  
Accessories

B3.  
Stainless  
Steel Ties

C1.  
Wiring  
Duct

C2.  
Surface  
Raceway

C3.  
Abrasion  
Protection

C4.  
Cable  
Management

D1.  
Terminals

D2.  
Power  
Connectors

D3.  
Grounding  
Connectors

E1.  
Labeling  
Systems

E2.  
Labels

E3.  
Pre-Printed  
& Write-On  
Markers

E4.  
Permanent  
Identification

E5.  
Lockout/  
Tagout  
& Safety  
Solutions

F.  
Index

A.  
System  
Overview

B1.  
Cable Ties

B2.  
Cable  
Accessories

B3.  
Stainless  
Steel Ties

C1.  
Wiring  
Duct

C2.  
Surface  
Raceway

C3.  
Abrasion  
Protection

C4.  
Cable  
Management

D1.  
Terminals

D2.  
Power  
Connectors

D3.  
Grounding  
Connectors

E1.  
Labeling  
Systems

E2.  
Labels

E3.  
Pre-Printed  
& Write-On  
Markers

E4.  
Permanent  
Identification

E5.  
Lockout/  
Tagout  
& Safety  
Solutions

F.  
Index

## Flammability (continued)

### ASTM D 635

Samples of a material, with dimensions 125mm by 12.5mm and the thickness of the intended end use product, are tested in an unaged “as manufactured” state. A precisely controlled flame is applied to the specimen and a stopwatch is started. The flame is applied for 30 seconds. The stopwatch is stopped when burning or glowing combustion ceases or when the flame has proceeded to a mark 100mm from the free end. Ten specimens are tested. If any of the specimens burn to the 100mm mark, an additional ten specimens are tested.

#### Burning Rate

- If two or more specimens have burned to the 100mm mark then Average Burning Rate (cm/min.) shall be reported as the average of the burning rates of all specimens which have burned to the 100mm mark

#### Average Time of Burning and Average Extent of Burning

- Average time of burning and average extent of burning of the sample shall be reported if none of the ten samples or no more than one of the twenty specimens have burned to the 100mm mark

- Average Time of Burning (ATB):

$$ATB, s = \frac{\sum_0^N [time(sec) - 30(sec)]}{N}$$

N = Number of specimens tested  
Rounded to the nearest 5 seconds

- Average Extent of Burning (AEB):

$$AEB, mm = \frac{\sum_0^N [10(mm) - unburned length(mm)]}{N}$$

N = Number of specimens tested  
Rounded to the nearest 5mm

**Table B – Flammability Ratings**

Materials	Part Number Suffix	UL 94	ASTM D 635
Nylon 6.6, Natural	None	94V-2 @ .71mm	AEB = 20mm ATB = 5 seconds
Weather Resistant Nylon 6.6, Black (Meets Mil. Spec.)	00	94V-2 @ .71mm	AEB = 20mm ATB = 5 seconds
Weather Resistant Nylon 6.6, Black*	0	94V-2** @ .71mm	AEB = 20mm ATB = 5 seconds
Heat Stabilized Nylon 6.6, Black	30	94V-2 @ .71mm	AEB = 20mm ATB = 5 seconds
Heat Stabilized Nylon 6.6, Natural	39	94V-2 @ .71mm	AEB = 20mm ATB = 5 seconds
Heat Stabilized Weather Resistant Nylon 6.6, Black	300	94V-2 @ .71mm	AEB = 20mm ATB = 5 seconds
Flame Retardant Nylon 6.6, Black	60	94V-0 @ .81mm	AEB = 15mm ATB = < 5 seconds
Flame Retardant Nylon 6.6, Natural (Ivory)	69	94V-0 @ .81mm	AEB = 15mm ATB = < 5 seconds
PEEK, Polyetheretherketone, Translucent Brown	71	94V-0 @ 1.5mm	—
Metal Detectable Nylon 6.6, Blue	86	94 HB @ .71mm	AEB = 20mm ATB = 5 seconds
Weather Resistant Nylon 12, Black	120	94 HB @ 1.6mm	Avg. Burning Rate 1.6cm/min.
Polypropylene, Green	109	94 HB @ .94mm	Avg. Burning Rate 2cm/min.
Weather Resistant Polypropylene, Black	100	94 HB @ .94mm	Avg. Burning Rate 2cm/min.
TEFZEL <sup>■</sup> , Aqua Blue	76	94V-0 @ 1.5mm	AEB = 15mm ATB = < 5 seconds
HALAR <sup>▲</sup> , Maroon	702Y	94V-0 @ .18mm	AEB = 15mm ATB = < 5 seconds
Weather Resistant Acetal, Black	DT Prefix	94 HB @ 1.5mm	Avg. Burning Rate 2.8cm/min

\*UL Recognized cable ties meet stated ratings. \*\*UL Recognized -0 parts

■TEFZEL is a registered trademark of E.I. du Pont de Nemours and Company.

▲HALAR is a registered trademark of Ausimont USA, Inc.

## Radiation/Moisture/Temperature/Tensile Strength

### Radiation

Installed cable ties of various materials have been exposed to different amounts of radiation to determine the maximum acceptable limit. These tests were conducted by Panduit to determine the acceptability for use in various areas of nuclear power plants (for radiation exposure accumulated over a 40 year life). See Cable Tie Selection Chart (pages B1.2 and B1.3) for radiation resistance rating.

### Moisture

Many plastics when exposed to high relative humidity absorb water and, as such, the tensile strength of the material can change dramatically. Nylon 6.6 when exposed to 100% relative humidity, will absorb as much as 8.5% water which will reduce tensile strength by 50% when compared to a dry cable tie. Polypropylene, HALAR<sup>▲</sup>, Type 12 Nylon, TEFZEL<sup>■</sup>, Acetal and PEEK are low water absorbing materials and, as such, the effect of water is minimal. See Cable Tie Selection Chart (pages B1.2 and B1.3) for moisture absorption.

### Proper Storage

Nylon 6.6 is a hygroscopic material (affected by atmospheric moisture variations). The optimum storage requirement for Nylon 6.6 cable ties is 73°F (± 15°F) and 50% RH (relative humidity) in sealed containers. Improper storage, especially in cold/dry conditions can result in moisture loss, which impedes cable tie performance. Panduit packaging provides Nylon 6.6 cable ties conditioned to 2.5% moisture added by weight in heavy-wall, polyethylene heat-sealed bags.

### Temperature

Plastic materials normally undergo property loss due to oxidation caused by exposure to high temperatures. The maximum continuous use temperature for cable tie materials depends upon the time at the elevated temperature as well as other environmental conditions. Initially, plastics become more flexible and weaker when exposed to high temperatures. After a period of time, oxidation may occur which will cause embrittlement, making plastic cable ties more susceptible to failure from impact and vibration.

The maximum continuous use temperature, is based on the UL Relative Thermal Index (mechanical without impact) as determined by UL per UL 746B. It is one indicator of a material's ability to retain a particular physical property when exposed to elevated temperatures over an extended period of time. It is based on the assumption that there is no loading, no chemical attack, and impact-free condition. The maximum continuous use temperatures for cable tie materials are listed in the Cable Tie Selection Chart (pages B1.2 and B1.3).

Low temperature exposure will also make most plastics more brittle during the exposure, but little property loss occurs when the material is returned to room temperatures. The minimum application use temperatures for cable tie materials are listed in the Cable Tie Selection Chart (pages B1.2 and B1.3).

### Tensile Strength

Most cable ties are selected based on material, length, and minimum loop tensile strength. Minimum loop tensile strength was established under SAE Aerospace Standard AS23190. Each cable tie cross section (SM = Subminiature, M = Miniature, I = Intermediate, S = Standard, HS = Heavy-Standard, LH = Light-Heavy, H = Heavy and EH = Extra-Heavy) has a different loop tensile strength when tested per AS23190.

The cable tie is first conditioned at 49°C (120°F), 20% relative humidity for 24 hours, then the cable tie is installed on a split mandrel and the halves of the mandrel separated at a rate of 1 inch (25.4mm) per minute. The separating force required to unlock or break the cable tie is the loop tensile strength. Loop tensile strength is dependent both on the locking design and the tensile strength (psi) of the material. As an example, the tensile strength of polypropylene material is approximately 1/2 to 1/3 of Nylon 6.6; thus the loop tensile strength of a given cross section tie made of polypropylene would be much less than a tie made of Nylon 6.6. This is another property to be considered when selecting a cable tie. The various representative loop tensile strengths are listed in the Cable Tie Selection Chart (pages B1.2 and B1.3).

### Halogen-Free

All Panduit cable ties (with the exception of TEFZEL<sup>■</sup> and HALAR<sup>▲</sup>) are halogen-free per IEC Specification 61249-2-21.

<sup>▲</sup>HALAR is a registered trademark of Ausimont USA, Inc.

<sup>■</sup>TEFZEL is a registered trademark of E.I. du Pont de Nemours and Company.

A.  
System  
Overview

B1.  
Cable Ties

B2.  
Cable  
Accessories

B3.  
Stainless  
Steel Ties

## Table C – Chemical Resistance Table

Many factors combine to determine the useful life of a cable tie material and none is as important as chemical exposure. Various chemicals will have different effects on plastics depending on such variables as chemical concentrations, temperature, stress and ultraviolet light. This table is an excellent guideline for the selection of the best cable tie material for various cable tie environments. It should be noted that the exposure for this chemical resistance chart is at 70°F (21°C).

### Resistance of Panduit cable tie materials to chemical attack at 70°F (21°C)

A = Excellent

B = Satisfactory

C = Slight Attack

D = Attacked

— = Not Tested

<sup>1</sup> = Pitting occurs under some conditions

<sup>2</sup> = Attack may occur if sulfuric acid present

Aq. = Aqueous

C.S. = Cold Saturated

C1.  
Wiring  
Duct

C2.  
Surface  
Raceway

C3.  
Abrasion  
Protection

C4.  
Cable  
Management

D1.  
Terminals

D2.  
Power  
Connectors

D3.  
Grounding  
Connectors

E1.  
Labeling  
Systems

E2.  
Labels

E3.  
Pre-Printed  
& Write-On  
Markers

E4.  
Permanent  
Identification

E5.  
Lockout/  
Tagout  
& Safety  
Solutions

F.  
Index

Agent	Percent Concentration	Nylon 6.6*	Nylon 12	Polypropylene	TEFZEL <sup>‡</sup>	HALAR <sup>‡</sup>	PEEK	304 Stainless Steel	316 Stainless Steel
Acetaldehyde	90	B	—	C	A	A	A	—	—
Acetic Acid	97	D	D	A	A	A	A	A	A
Acetic Acid	10	C	B	A	A	A	—	A	A
Acetic Anhydride	90	—	B	A	A	A	—	A	A
Acetone	100	A	A	A	A	A	A	A	A
Acetophenone	100	—	—	B	A	A	—	A	A
Acetylene	100	—	—	A	A	A	A	A	A
Aluminum Chloride	10	B	A	A	A	A	A	D	C
Aluminum Fluoride	10	B	A	A	A	A	—	D	C
Aluminum Hydroxide	Aq. C.S.	—	A	A	A	A	—	A	A
Aluminum Potassium Sulfate	10	B	A	A	A	A	—	A <sup>1</sup>	A <sup>1</sup>
Ammonia	All	—	A	A	A	A	A	A	A
Ammonium Carbonate	1 to 5	—	A	—	A	A	—	A	A
Ammonium Chloride	10 to 25	D	A	A	A	A	A	A <sup>1</sup>	A
Ammonium Hydroxide	10	A	—	—	A	A	A	—	—
Ammonium Nitrate	100	—	A	A	A	A	A	A	A <sup>1</sup>
Ammonium Sulfate	10	—	A	A	A	A	A	E <sup>1</sup>	A
Amyl Acetate	100	—	—	C	A	A	A	A	A
Aniline	100	—	B	A	A	A	A	A	A
Antimony Trichloride	All	D	—	A	A	A	A	A	A
Arsenic Acid	1 to 80	—	—	A	A	A	—	A	A
Barium Carbonate	All	—	A	A	A	A	—	A	A
Barium Chloride	All	—	A	A	A	A	—	A <sup>1</sup>	A
Barium Sulfate	All	—	A	A	A	A	—	A	A
Barium Sulfide	All	—	A	A	A	A	—	A	A
Benzene	100	A	A	C	A	A	A	A	A
Benzoic Acid	100	D	A	A	A	A	A	A	A
Benzoyl Chloride	100	—	—	C	A	A	—	—	—
Benzyl Alcohol	100	—	—	A	A	A	A	—	—
Boric Acid	All	D	A	A	A	A	A	B	—
Bromine	100	D	D	D	A	A	D	D	D
Butadiene	100	—	—	C	A	A	—	A	A
Butane	100	—	A	A	A	A	A	A	A
Butanediol	100	—	—	A	A	A	—	—	—
Butyl Acetate	100	—	A	C	A	A	A	—	—
N. Butyl Alcohol	100	—	A	A	A	A	A	A	A
Butyl Phthalate	100	—	—	A	A	A	—	—	—
Butyraldehyde	100	—	—	A	A	A	—	—	—
Butyric Acid	10 to 100	D	—	A	A	A	—	A	A
Calcium Carbonate	Aq. C.S.	—	—	A	A	A	A	A	A
Calcium Chlorate	Aq. C.S.	—	—	A	A	A	—	A	A

\*Includes all 6.6 Nylons (weather resistant, heat stabilized, and flame retardant).

‡TEFZEL is a registered trademark of E.I. du Pont de Nemours and Company.

‡HALAR is a registered trademark of Ausimont USA, Inc.

Agent	Percent Concentration	Nylon 6.6*	Nylon 12	Polypropylene	TEFZEL®	HALAR®	PEEK	304 Stainless Steel	316 Stainless Steel
Calcium Chloride	5	C	A	A	A	A	A	A <sup>1</sup>	A <sup>1</sup>
Calcium Hydroxide	50	—	—	A	A	A	A	A	A
Calcium Hypochlorite	2	D	—	A	A	A	A	A <sup>1</sup>	A <sup>1</sup>
Calcium Nitrate	50	—	A	A	A	A	A	—	—
Calcium Sulfate	2	C	—	A	A	A	A	A	A
Carbon Tetrachloride	100	A	A	D	A	A	A	A	A
Carbon Tetrachloride	Aq. 10	—	—	—	—	A	—	C <sup>1</sup>	A <sup>1</sup>
Chlorine	Dry	—	D	D	A	A	D	C	C
Chlorine	Wet	—	D	C	A	A	D	D	D
Chloroacetic Acid	10 to 50	D	—	A	A	A	A	D	C
Chlorobenzene	100	—	C	A	A	A	A	—	—
Chloroform	100	A	C	C	A	A	A	A	A
Chlorosulphonic Acid	10 to 100	D	D	D	B	A	D	D	D
Chromic Acid	10 to 50	D	D	A	A	A	A	C	C
Citric Acid	10 to 50	B	B	A	—	A	A	A	A
Copper Chloride	1 to 10	D	—	A	A	A	A	A <sup>1</sup> -D	A <sup>1</sup> -C <sup>1</sup>
Copper Cyanide	Aq. C.S.	—	—	A	A	A	A	A	A
Copper Nitrate	50	—	—	A	A	A	A	A	A
Cresol	100	D	D	—	A	A	—	A	A
Crotonaldehyde	100	—	—	A	A	A	—	—	—
Cyclohexane	100	—	A	C	A	A	A	A	—
Cyclohexanol	100	—	A	A	A	A	A	A	—
Cyclohexanone	100	—	A	C	A	A	A	A	—
Dibutyl Phthalate	100	—	—	A	A	A	A	—	—
Dichloroethane	100	—	—	A	—	A	A	A	A
Dichloroethylene	100	—	—	C	A	A	—	—	—
Diesel Fuel	100	—	A	C	A	A	A	A	A
Diethyl Ether	100	—	A	A	A	A	A	A	A
Diglycolic Acid	Aq. C.S.	—	—	A	A	A	—	—	—
Diisobutyl Ketone	100	—	—	A	A	A	—	—	—
Dimethyl Amine	100	—	—	A	A	A	—	—	—
Dimethyl Formamide	100	—	A	A	A	A	A	A	—
Dimethyl Sulfate	100	—	—	C	A	A	—	—	—
Diocetyl Phthalate	100	—	—	A	A	A	A	A	—
1,4-Dioxane	100	—	B	C	A	A	A	A	—
Ethyl Acetate	100	A	A	B	A	A	A	A	A
Ethyl Alcohol	100	A	A	A	A	A	A	A	A
Ethyl Chloride	100	—	—	C	A	A	—	A	A
Ethylene Chloride	100	A	C	C	A	A	—	A	A
Ethylene Glycol	100	A	A	A	A	A	A	A	A
Ethylene Oxide	100	—	—	C	A	A	A	—	—
Fatty Acids	100	—	—	A	A	A	—	—	—
Ferric Chloride	50	D	—	A	A	A	C	D	D
Ferric Hydroxide	All	—	—	A	A	A	—	A	A
Ferric Nitrate	All	—	—	A	A	A	A	A	A
Ferrous Chloride	Aq. C.S.	D	—	A	A	A	A	D	C
Ferrous Sulfate	10	—	—	A	A	A	A	A <sup>1</sup>	A
Fluorine (Dry)	100	—	—	D	A	—	D	D	D
Formaldehyde	40	A	B	A	A	A	A	A <sup>1</sup>	A
Formic Acid	All	D	D	A	A	A	C	A	A
Freons	100	A	—	—	A	A	A	—	—
Fuel Oil	100	—	A	—	A	A	A	A	A
Furfural	100	A	—	—	A	A	—	A	A
Gallic Acid	Aq. C.S.	—	—	—	A	A	—	A	A
Gasoline	100	A	—	C	A	A	A	A	A
Glycerin	100	—	A	A	—	A	—	A	A
Glycolic Acid	40	D	—	A	A	A	—	—	—
Heptane	100	—	A	A	A	A	A	A	A
Hexane	100	—	A	A	A	A	A	A	A
Hydrobromic Acid	All	D	D	A	A	A	D	D	D

\*Includes all 6.6 Nylons (weather resistant, heat stabilized, and flame retardant).

®TEFZEL is a registered trademark of E.I. du Pont de Nemours and Company.

®HALAR is a registered trademark of Ausimont USA, Inc.

Table continues on page B1.106

## Table C – Chemical Resistance Table (continued)

Agent	Percent Concentration	Nylon 6.6*	Nylon 12	Polypropylene	TEFZEL <sup>■</sup>	HALAR <sup>▲</sup>	PEEK	304 Stainless Steel	316 Stainless Steel
<b>Hydrochloric Acid</b>	All	D	D	A	A	A	A	D	D
<b>Hydrocyanic Acid</b>	All	—	D	A	A	A	A	C	C
<b>Hydrofluoric Acid</b>	All	D	D	A	A	A	D	D	D
<b>Hydrofluorosilicic Acid</b>	30	—	D	A	A	A	—	D	D
<b>Hydrogen Peroxide</b>	30	D	B	B	A	A	A	B	A
<b>Hydrogen Sulfide</b>	Dry	—	—	A	A	A	A	A	A
<b>Hydrogen Sulfide</b>	Wet	D	—	A	A	A	—	C <sup>2</sup>	A <sup>2</sup>
<b>Hydroquinone</b>	100	—	—	A	A	A	—	—	—
<b>Iodine</b>	100	—	—	A	A	A	C	D	D
<b>Iodoform</b>	100	—	—	—	A	A	—	A	A
<b>Isopropyl Alcohol</b>	100	A	A	A	A	A	A	A	A
<b>Jet Fuel</b>	100	A	—	A	A	A	A	A	A
<b>Lactic Acid</b>	10	A	B	A	A	A	—	A	A
<b>Lanolin</b>	10	A	A	A	A	A	—	A	A
<b>Lead Acetate</b>	Aq. C.S.	—	—	A	A	A	A	A	A
<b>Linseed Oil</b>	100	A	A	A	A	A	—	A	A
<b>Magnesium Carbonate</b>	Aq. C. S.	—	A	A	A	A	—	A	A
<b>Magnesium Chloride</b>	Aq. C.S.	C	A	A	A	A	A	A <sup>1</sup>	A <sup>1</sup>
<b>Magnesium Nitrate</b>	Aq. C. S.	—	A	A	A	A	—	A	A
<b>Maleic Acid</b>	100	—	—	A	A	A	A	—	—
<b>Malic Acid</b>	Aq. C.S.	—	—	A	A	A	—	A	A
<b>Mercuric Chloride</b>	Dilute	—	A	A	A	A	A	D	D
<b>Mercury</b>	100	—	A	A	A	A	A	A	A
<b>Methyl Alcohol</b>	100	A	A	A	A	A	A	A	A
<b>Methyl Bromide</b>	100	—	—	D	A	A	—	—	—
<b>Methyl Chloride</b>	100	—	—	C	A	A	—	—	A
<b>Methyl Chloroform</b>	100	A	—	C	A	A	—	—	—
<b>Methyl Ethyl Ketone</b>	100	—	A	C	A	A	A	A	A
<b>Methyl Isobutyl Ketone</b>	100	A	—	C	A	A	—	A	A
<b>Methylene Chloride</b>	100	C	D	C	A	A	A	A	A
<b>Naphtha</b>	100	—	—	A	A	A	A	A	A
<b>Naphthalene</b>	100	—	B	A	A	A	A	A	A
<b>Nickel Chloride</b>	Aq. C.S.	—	A	A	A	A	A	A <sup>1</sup>	A <sup>1</sup>
<b>Nickel Sulfate</b>	Aq. C.S.	—	A	A	A	A	A	A <sup>1</sup>	A <sup>1</sup>
<b>Nitric Acid</b>	10 to 30	D	D	A	A	A	—	A	A
<b>Nitric Acid</b>	30 to 68	D	D	D	B	A	C	A	A
<b>Nitro Benzene</b>	100	—	C	C	A	A	A	A	A
<b>Nitro Methane</b>	100	A	—	—	A	A	—	—	—
<b>Nitrous Acid</b>	5	—	—	—	A	A	A	A	A
<b>Oleic Acid</b>	100	—	C	A	A	A	A	A	A
<b>Oxalic Acid</b>	10	—	C	A	A	A	A	A	A
<b>Oxygen</b>	All	—	—	A	A	A	A	—	—
<b>Paraffin</b>	100	A	A	A	A	A	—	A	A
<b>Perchloroethylene</b>	100	—	—	C	A	A	A	A	A
<b>Petroleum Ether</b>	100	—	A	A	A	A	A	A	A
<b>Phenol</b>	90	D	D	A	A	A	D	A	A
<b>Phosphoric Acid</b>	10	D	D	A	A	A	A	A	A
<b>Phosphorous Pentoxide</b>	100	—	D	A	A	A	A	—	—
<b>Phosphorous Trichloride</b>	100	—	D	C	A	A	—	A	A
<b>Phthalic Acid</b>	50	—	—	C	A	A	—	A	A
<b>Picric Acid</b>	1	—	—	A	A	A	A	A	A
<b>Potassium Borate</b>	1	—	—	A	A	A	—	—	—
<b>Potassium Bromide</b>	Aq. C.S.	—	—	A	A	A	A	A <sup>1</sup>	A <sup>1</sup>
<b>Potassium Carbonate</b>	Aq. C.S.	—	C	A	A	A	A	A	A
<b>Potassium Chlorate</b>	Aq. C. S.	—	B	A	A	A	A	A	A
<b>Potassium Chloride</b>	5	—	A	A	A	A	A	A <sup>1</sup>	A <sup>1</sup>
<b>Potassium Dichromate</b>	Aq. C.S.	—	D	A	A	A	A	A	A
<b>Potassium Ferrocyanide</b>	25	—	—	A	A	A	A	A	A
<b>Potassium Hydroxide</b>	30	C	—	A	A	A	A	C	C

\*Includes all 6.6 Nylons (weather resistant, heat stabilized, and flame retardant).

■TEFZEL is a registered trademark of E.I. du Pont de Nemours and Company.

▲HALAR is a registered trademark of Ausimont USA, Inc.



Agent	Percent Concentration	Nylon 6.6*	Nylon 12	Polypropylene	TEFZEL <sup>®</sup>	HALAR <sup>▲</sup>	PEEK	304 Stainless Steel	316 Stainless Steel
Potassium Iodide	Aq. C.S.	—	A	A	—	A	—	A	A
Potassium Nitrate	Aq. C.S.	—	A	A	A	A	A	A	A
Potassium Perchlorate	1	—	—	A	A	A	—	—	—
Potassium Permanganate	5	D	D	A	A	A	A	A	A
Potassium Persulfate	All	—	—	A	A	A	—	—	—
Potassium Sulfate	Aq. C.S.	—	A	A	A	A	A	A	A
Potassium Sulfide	Aq. C.S.	—	—	A	A	A	A	A	A
Propionic Acid	50	—	—	A	A	A	—	—	—
Propyl Alcohol	100	A	—	A	A	A	A	A	A
Pyridine	100	—	A	C	A	A	A	C	C
Sea Water	100	—	A	A	A	A	—	A <sup>1</sup>	A <sup>1</sup>
Silver Chloride	Aq. C.S.	—	A	A	A	A	—	D	D
Silver Nitrate	10	—	A	A	A	A	A	A	A
Sodium Acetate	Aq. C.S.	A	—	A	A	A	A	A <sup>1</sup>	A
Sodium Benzoate	Aq. C.S.	—	—	A	A	A	—	—	—
Sodium Bicarbonate	Aq. C.S.	A	A	A	A	A	A	A	A
Sodium Bisulfate	10	—	—	A	A	A	—	A	A
Sodium Bisulfite	Aq. C.S.	—	B	A	A	A	—	A	A
Sodium Borate	Aq. C.S.	—	—	A	A	A	—	A	A
Sodium Carbonate	2	A	A	A	A	A	A	A	A
Sodium Chlorate	25	—	C	A	A	A	A	A	A
Sodium Chloride	10	A	A	A	A	A	A	A <sup>1</sup>	A <sup>1</sup>
Sodium Chromate	Aq. C.S.	D	—	A	A	A	—	A	A
Sodium Fluoride	5	—	—	A	A	A	—	A <sup>1</sup>	A <sup>1</sup>
Sodium Hydroxide	10	A	A	A	A	A	A	A	A
Sodium Hypochlorite	5	B	C	A	A	A	A	C <sup>1</sup>	A <sup>1</sup>
Sodium Hyposulfite	Aq.C.S.	—	—	—	A	A	—	A	A
Sodium Nitrate	5	A	A	A	A	A	A	A	A
Sodium Perborate	Aq. C.S.	—	B	A	A	A	—	—	C
Sodium Perchlorate	10	—	—	—	A	A	—	A	A
Sodium Phosphate	5	—	A	A	A	A	—	A	A
Sodium Sulfate	5	—	A	A	A	A	A	A	A
Sodium Sulfide	5	—	A	A	A	A	A	A <sup>1</sup>	A
Sodium Thiosulfate	25	—	A	A	A	A	—	A <sup>2</sup>	A <sup>2</sup>
Stannic Chloride	Aq. C.S.	D	—	A	A	A	A	D	C
Stannous Chloride	Aq. C.S.	—	A	A	A	A	A	C	B
Stearic Acid	100	—	C	A	A	A	—	A	A
Succinic Acid	100	—	B	A	A	A	—	—	—
Sulfur	100	—	A	A	A	A	A	B	C
Sulfur Dioxide	All	D	—	C	A	A	A	A	A
Sulfuric Acid	5	D	C	A	A	A	C	C	A
Sulfuric Acid	50	D	D	A	A	A	D	D	C
Sulfuric Acid	Concentrate	D	D	C	A	A	D	C	C
Sulfurous Acid	10	A	—	A	A	A	A	C <sup>1</sup>	A <sup>1</sup>
Tannic Acid	10	—	A	A	A	A	A	A	A
Tartaric Acid	50	—	B	A	A	A	A	A	A
Tetrahydrofuran	100	—	C	C	A	A	A	A	A
Toluene	100	A	A	C	A	A	A	A	A
Trichloroacetic Acid	10	D	—	B	A	A	—	D	D
Trichloroethylene	100	—	D	C	A	A	A	A <sup>1</sup>	A <sup>1</sup>
Turpentine	100	—	B	D	A	A	A	A	A
Urea	50	—	A	A	A	A	—	—	—
Vinyl Acetate	100	—	—	A	A	A	—	—	—
Xylene	100	A	—	D	A	A	A	A	A
Zinc Chloride	70	D	A	A	A	A	A	A	A
Zinc Nitrate	Aq. C.S.	—	A	A	A	A	—	A	A
Zinc Sulfate	Aq. C.S.	—	A	A	A	A	A	A	A

\*Includes all 6.6 Nylons (weather resistant, heat stabilized, and flame retardant).

®TEFZEL is a registered trademark of E.I. du Pont de Nemours and Company.

▲HALAR is a registered trademark of Ausimont USA, Inc.

A.  
System  
Overview

B1.  
Cable Ties

B2.  
Cable  
Accessories

B3.  
Stainless  
Steel Ties

C1.  
Wiring  
Duct

C2.  
Surface  
Raceway

C3.  
Abrasion  
Protection

C4.  
Cable  
Management

D1.  
Terminals

D2.  
Power  
Connectors

D3.  
Grounding  
Connectors

E1.  
Labeling  
Systems

E2.  
Labels

E3.  
Pre-Printed  
& Write-On  
Markers

E4.  
Permanent  
Identification

E5.  
Lockout/  
Tagout  
& Safety  
Solutions

F.  
Index

A.  
System  
Overview

B1.  
Cable Ties

B2.  
Cable  
Accessories

B3.  
Stainless  
Steel Ties

C1.  
Wiring  
Duct

C2.  
Surface  
Raceway

C3.  
Abrasion  
Protection

C4.  
Cable  
Management

D1.  
Terminals

D2.  
Power  
Connectors

D3.  
Grounding  
Connectors

E1.  
Labeling  
Systems

E2.  
Labels

E3.  
Pre-Printed  
& Write-On  
Markers

E4.  
Permanent  
Identification

E5.  
Lockout/  
Tagout  
& Safety  
Solutions

F.  
Index

## NOTES

## MANUAL CABLE TIE INSTALLATION TOOLS

Panduit provides the most preferred hand-operated tools in the industry. These versatile tools can be used for production, maintenance, or construction applications.

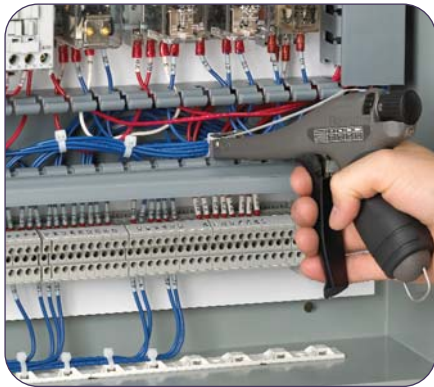

### Tool Highlights:

- Tool controlled tension and cut-off
  - Ergonomic tools are durable, lightweight, and easy to use
  - Manual tools
  - Pneumatic tools
- Installer controlled tension and cut-off
  - Large selection of tools available for complete range of Panduit cable ties
  - Cost-effective alternative for small volume applications



Panduit cable tie installation tools promote worker safety, help reduce downtime, improve productivity and provide the lowest total installed cost. As with all Panduit products, quality in design and production along with customer service excellence, are assured.

A.  
System  
Overview

B1.  
Cable Ties

B2.  
Cable  
Accessories

B3.  
Stainless  
Steel Ties

C1.  
Wiring  
Duct

C2.  
Surface  
Raceway

C3.  
Abrasion  
Protection

C4.  
Cable  
Management

D1.  
Terminals

D2.  
Power  
Connectors

D3.  
Grounding  
Connectors

E1.  
Labeling  
Systems

E2.  
Labels

E3.  
Pre-Printed  
& Write-On  
Markers

E4.  
Permanent  
Identification

E5.  
Lockout/  
Tagout  
& Safety  
Solutions

F.  
Index

## Selection Guide – Hand Tools, Accessories, and Kits

A. System Overview

B1. Cable Ties

B2. Cable Accessories

B3. Stainless Steel Ties

C1. Wiring Duct

C2. Surface Raceway

C3. Abrasion Protection

C4. Cable Management

D1. Terminals

D2. Power Connectors

D3. Grounding Connectors

E1. Labeling Systems

E2. Labels

E3. Pre-Printed & Write-On Markers

E4. Permanent Identification

E5. Lockout/Tagout & Safety Solutions

F. Index

### Hand Tools

#### Manual

##### Tool Controlled Tension and Cut-Off

Recommended usage: under 50,000 ties/year

Typical applications: Low to medium volume tie usage in OEM, MRO, or construction

Cross Section	Tool Part Number – Page B1.111					
	GTS	GTSL	GS2B	GTH	GS4H	GS4EH
SM	X	X				
M	X	X	X			
I	X	X	X			
S	X	X	X	X	X	
HS				X	X	
LH				X	X	X
H				X	X	X
EH						X

Cross Sections	
SM	= Subminiature
M	= Miniature
I	= Intermediate
S	= Standard
HS	= Heavy-Standard
LH	= Light-Heavy
H	= Heavy
EH	= Extra-Heavy

##### Installer Controlled Tension and Cut-Off

Recommended usage: under 10,000 ties/year

Typical applications: MRO or construction

Cross Section	Tool Part Number – Page B1.112			
	STS2	STH2	ST3EH	STHV
M	X			
I	X			
S	X	X		
HS		X		
LH		X	X	X
H		X	X	X
EH			X	

#### Pneumatic

Recommended usage: under 250,000 ties/year

Typical applications: Medium to high volume tie usage in OEM

Cross Section	Tool Part Number – Page B1.113	
	PTS	PTH
SM	X	
M	X	
I	X	
S	X	X
HS		X
LH		X
H		X

### Accessories/Kits

#### Manual

	Part Number	For Tool	Page
Tool Tension Locking Kits	KGTSTL	GTS, GTSL	B1.114
	KGHTL	GTH	B1.114
	TTLK3	GS2B, GS4H	B1.114
Blade Replacement Kits	KGTSBLD	GTS, GTSL	B1.114
	KGTHBLD	GTH	B1.114
	K2-BLD2	GS2B	B1.114
	K4H-BLD	GS4H	B1.114
Tool Holster	GHH	GTS, GTSL, GS2B, GTH, GS4H, GS4EH	B1.114
	KGTHSLV	GTH	B1.114
Cushion Sleeve Kit	KGTSBLV	GTS	B1.114
	KGTHSLV	GTH	B1.114
Pneumatic Hose Assembly, Filter/Regulator, Adapter Fittings	PPH10		B1.113
	PL289N1		B1.113
	PHCAQ	PTS, PTH, PPTS	B1.113
	PHCAT		B1.113

#### Pneumatic

Part Number	For Tool	Page
KPTSTL	PTS, PTH	B1.114
TTLK3	PPTS	B1.114
KGTSBLD	PTS	B1.114
KPTHBLD	PTH	B1.114
K2-BLD2	PPTS	B1.114
GHH	PTS, PPTS	B1.114
PPH10		B1.113
PL289N1		B1.113
PHCAQ	PTS, PTH, PPTS	B1.113
PHCAT		B1.113

## Cable Tie Tools – Tool Controlled Tension and Cut-Off

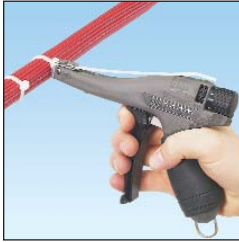

GTS

- Used in production, maintenance, or construction applications
- Tool controlled tension provides flush cut-off and speeds installation to lower installed cost
- Lightweight and balanced
- Easy to change tension adjustment and easy to operate
- A combination of design, operation, and construction features, provides a long service life
- Replacement blades available, see page B1.114
- No special maintenance required



GTS



GTSL



GS2B



GTH



GS4H



GS4EH

Part Number	Used with Cable Ties	Weight		Part Features	Standards	Std. Pkg. Qty.
		Oz.	g			
GTS	SM, M, I, S	9.8	278	Ergonomic design with impact resistant resin housing, narrow nose, and cushion handle.	QPL per Mil. Std. SAE AS81306 and Mil. Spec. SAE AS90387-1	1
GTSL	SM, M, I, S	8.8	249	Ergonomic design with impact resistant resin housing, narrow nose, and cushion handle. Shorter handle reach (than GTS) for users with smaller hands.	QPL per Mil. Std. SAE AS81306 and Mil. Spec. SAE AS90387-5	1
GS2B	M, I, S	11.5	327	Metal tool with a durable powder coat finish.	QPL per Mil. Std. SAE AS81306 and Mil. Spec. SAE AS90387-1	1
GTH	S, HS, LH, H	12.0	340	Ergonomic design with impact resistant resin housing, narrow nose, and cushion handle.	QPL per Mil. Std. SAE AS81306 and Mil. Spec. SAE AS90387-2	1
GS4H	S, HS, LH, H	16.0	454	Metal tool with a durable powder coat finish.	QPL per Mil. Std. SAE AS81306 and Mil. Spec. SAE AS90387-2	1
GS4EH	LH, H, EH	16.0	454	Metal tool with a durable powder coat finish.	QPL per Mil. Std. SAE AS81306 and Mil. Spec. SAE AS90387-4	1

Cable tie cross section sizes: SM = Subminiature, M = Miniature, I = Intermediate, S = Standard, HS = Heavy-Standard, LH = Light-Heavy, H = Heavy, EH = Extra-Heavy.

A.  
System  
Overview

B1.  
Cable Ties

B2.  
Cable  
Accessories

B3.  
Stainless  
Steel Ties

C1.  
Wiring  
Duct

C2.  
Surface  
Raceway

C3.  
Abrasion  
Protection

C4.  
Cable  
Management

D1.  
Terminals

D2.  
Power  
Connectors

D3.  
Grounding  
Connectors

E1.  
Labeling  
Systems

E2.  
Labels

E3.  
Pre-Printed  
& Write-On  
Markers

E4.  
Permanent  
Identification

E5.  
Lockout/  
Tagout  
& Safety  
Solutions

F.  
Index

A. System Overview

## Cable Tie Tools – Installer Controlled Tension and Cut-Off

B1. Cable Ties

B2. Cable Accessories

B3. Stainless Steel Ties



STS2

- Economical series of tools for maintenance or construction applications

- Excellent tools for low volume applications

C1. Wiring Duct



STS2

C2. Surface Raceway



STH2

C3. Abrasion Protection

C4. Cable Management



ST3EH

D1. Terminals

D2. Power Connectors



STHV

D3. Grounding Connectors

E1. Labeling Systems

E2. Labels

E3. Pre-Printed & Write-On Markers

E4. Permanent Identification

E5. Lockout/Tagout & Safety Solutions

F. Index

Part Number	Used with Cable Ties	Color	Weight		Part Features	Std. Pkg. Qty.
			Oz.	g		
STS2	M, I, S	Black	2.5	71	Economical tool with short handle span and top loading feature for right- or left-handed users.	1
STH2	S, HS, LH, H	Red	2.5	71	Economical tool with short handle span and top loading feature for right- or left-handed users.	1
ST3EH	LH, H, EH	Blue/Black	9.0	256	Durable, all steel construction with comfortable plastic handles.	1
STHV	LH, H	Yellow	12.0	341	Durable all steel construction and "travel stop" to prevent pinched fingers.	1

Cable tie cross section sizes: SM = Subminiature, M = Miniature, I = Intermediate, S = Standard, HS = Heavy-Standard, LH = Light-Heavy, H = Heavy, EH = Extra-Heavy.

### Installation Procedure (STS2/STH2/ST3EH):

Install cable tie around bundle and tension tie by squeezing tool handle. Reduce tension slightly and twist tool 1/4" turn either direction to cut off excess cable tie.

### Installation Procedure (STHV):

Install cable tie around bundle and tension tie by squeezing tool handle. A separate lever cuts off excess cable tie.

## Pneumatic Hand Tools – Tool Controlled Tension and Cut-Off



PTS



PTS



PTH

- Pneumatic, push button operation tensions and cuts off excess tie in a fraction of a second
- Durable, lightweight, ergonomic design is easy to operate and designed to reduce operator fatigue
- Easy to change tension adjustment
- Operates on non-lubricated air, without special maintenance

Part Number	Used with Cable Ties	Weight		Part Features	Std. Pkg. Qty.
		Oz.	g		
PTS	SM, M, I, S	17.3	490	Ergonomic design with impact resistant resin housing and black knob; replacement parts can be part of a scheduled maintenance program.	1
PTH	S, HS, LH, H	32.0	907	Ergonomic design with impact resistant resin housing and red knob; replacement parts can be part of a scheduled maintenance program.	1

Note: All tools require the PPH10 hose and PL289N1 filter/regulator for proper operation.

Cable tie cross section sizes: SM = Subminiature, M = Miniature, I = Intermediate, S = Standard, HS = Heavy-Standard, LH = Light-Heavy, H = Heavy.

## Pneumatic Tool Accessories



PL289N1/PPH10



PHCAQ



PHCAT

Part Number	Used with Installation Tool	Part Description	Std. Pkg. Qty.
PL289N1	PTS, PPTS, PTH	Filter/regulator .5 micron element, regulated range 3 – 100 psig, features 1/8" NPT female output port (to hose PPH10) and 1/4" male quick disconnect to source air line.	1
PPH10	PTS, PPTS, PTH	10.0' (3m) hose assembly (regulator to tool); includes a 1/8" NPT male connector (to regulator) and 1/8" female quick disconnect (to tool).	1
PHCAQ	PTS, PPTS, PTH	Adapter fitting for 10.0' (3m) hose (PPH10) to regulator with 1/4" female quick disconnect output, features 1/8" NPT female connection (to hose) and 1/4" male quick disconnect (to regulator).	1
PHCAT	PTS, PPTS, PTH	Adapter fitting for 10.0' (3m) hose (PPH10) to regulator with 1/4" NPT female output port, features 1/8" NPT female connection (to hose) and 1/4" NPT male connection (to regulator).	1

A. System Overview

## Hand Tool Accessories: Tool Tension Locking Kits

B1. Cable Ties

- For applications requiring a locking device on either the selector knob (one cross section size and tension only) or tension level adjustment (but allow cross section size changes)

B2. Cable Accessories



KGTHTL

B3. Stainless Steel Ties

Part Number	Used with Installation Tool	Contents	Std. Pkg. Qty.
KGTSTL	GTS, GTSL	Lockout cap and screw.	1
KGTHTL	GTH	Lockout cap and screw.	1
KPTSTL	PTS, PTH	Lockout cap and screw.	1
TTLK3	GS2B, GS4H, PPTS	Selection locking clip and screws.	1

C1. Wiring Duct

## Blade Replacement Kits

C2. Surface Raceway

- Blade replacement kits can be part of a user's scheduled maintenance plan or used when cut-offs are not clean and crisp

C3. Abrasion Protection



KGTSBLD

C4. Cable Management

Part Number	Used with Installation Tool	Contents	Std. Pkg. Qty.
KGTSBLD	GTS, GTSL, PTS	Threadlocker, screw, washer and replacement blade.	1
KGTHBLD	GTH	Threadlocker, screw, and replacement blade.	1
K2-BLD2	GS2B, PPTS	Threadlocker, screws, and replacement blade.	1
K4H-BLD	GS4H	Threadlocker, screws, and replacement blade.	1
K4EH-BLD	GS4EH	Threadlocker, screw, and replacement blade.	1
KPTHBLD	PTH	Threadlocker, screw, and replacement blade.	1

D1. Terminals

## Hand Tool Holster

D2. Power Connectors

- Durable leather construction holster with rivets and extra tie-down strap to hold tool in place – easily fits on belt

D3. Grounding Connectors



Part Number	Used with Installation Tool	Color	Std. Pkg. Qty.
GHH	GTS, GTSL, GS2B, GTH, GS4H, GS4EH, PTS, PPTS, ST3EH	Black	1

E1. Labeling Systems

E2. Labels

## **NEW!** Cushion Sleeve Kits

E3. Pre-Printed & Write-On Markers

- Cushion sleeve can be added to existing GTS or GTH hand tool
- Reduce operator fatigue
- Reduce the amount of shock an operator may experience while tensioning and cutting off cable ties
- Unique thermoplastic elastomer material that won't split or fall off the tool over time

E4. Permanent Identification



KGTSSLV

E5. Lockout/Tagout & Safety Solutions

Part Number	Used with Installation Tool	Color	Contents	Std. Pkg. Qty.
KGTSSLV	GTS	Black	Cushion sleeve and lubricant.	1
KGTHSLV	GTH	Red	Cushion sleeve and lubricant.	1

F. Index



## AUTOMATIC CABLE TIE INSTALLATION SYSTEMS



The complete line of Panduit automatic cable tie installation systems offers a superior solution for high volume harness, assembly, fastening and packaging applications. These ergonomic systems increase productivity, provide consistent performance, and reduce activities that lead to repetitive motion injuries. A variety of tool options provide users with flexible solutions for their unique application needs.



### System Highlights

Multiple systems improve productivity, reliability, and versatility:

- Install a cable tie in less than one second
- Multiple cable tie styles and sizes for maximum productivity
- Optional software for advanced system monitoring and performance



Combined, these innovations improve reliability, maximize productivity, and lower installed costs. As with all Panduit products, quality in design and production along with customer service excellence, are assured.

A.  
System  
Overview

B1.  
Cable Ties

B2.  
Cable  
Accessories

B3.  
Stainless  
Steel Ties

C1.  
Wiring  
Duct

C2.  
Surface  
Raceway

C3.  
Abrasion  
Protection

C4.  
Cable  
Management

D1.  
Terminals

D2.  
Power  
Connectors

D3.  
Grounding  
Connectors

E1.  
Labeling  
Systems

E2.  
Labels

E3.  
Pre-Printed  
& Write-On  
Markers

E4.  
Permanent  
Identification

E5.  
Lockout/  
Tagout  
& Safety  
Solutions

F.  
Index

A.  
System  
Overview

## Selection Guide – Automatic Installation Systems and Reel-Fed Cable Ties

B1.  
Cable Ties

Recommended for annual usage of over 250,000 cable ties/year.  
Typical applications: High volume OEM/contract manufacturing.

B2.  
Cable  
Accessories

### PAT1M/PAT1.5M Systems

Tool Head for use with MINIATURE Cross Section

Part Number	Description	Page
PAT1M	For miniature cross section up to .82" (21mm) bundle diameter.	B1.117
PAT1.5M	For miniature cable ties up to 1.31" (33mm) bundle diameter.	B1.117

#### Dispenser

Part Number	Description	Page
PDM	Stationary dispenser.	B1.117
PDM-DI	Dispenser and data interface software.	B1.119
PD-DIA	Data interface accessory – software and interface card.	B1.119

#### Transfer Hose

Part Number	Description	Page
PHM1	3.2' (1m) transfer hose.	B1.118
PHM2	6.5' (2m) transfer hose.	B1.118
PHM3	10.0' (3m) transfer hose.	B1.118
PHM4	13.1' (4m) transfer hose.	B1.118

#### Optional System Accessories

Part Number	Description	Page
PDH10-37	Air hose.	B1.118
PL283N1	Filter/regulator.	B1.118
PATMBM	Bench mount and foot pedal.	B1.118

### Reel-Fed Cable Ties

#### MINIATURE Cross Section

Part Number	Description	Color	Page
<b>Barbed Tie – Max. Bundle Dia.: .82" (21mm), 30 lbs.</b>			
BT1M-XMR	Nylon 6.6.	Natural	B1.120
BT1M-XMR0	Weather Resistant Nylon 6.6.	Black	B1.120
BT1M-XMR30	Heat Stabilized Nylon 6.6.	Black	B1.120
<b>Barbed Tie – Max. Bundle Dia.: 1.31" (33mm), 30 lbs.</b>			
BT1.5M-XMR	Nylon 6.6.	Natural	B1.120
BT1.5M-XMR0	Weather Resistant Nylon 6.6.	Black	B1.120
BT1.5M-XMR30	Heat Stabilized Nylon 6.6.	Black	B1.120
BT1.5M-XMR69	Flame Retardant Nylon 6.6.	Natural Ivory	B1.120
<b>All-Nylon Tie – Max. Bundle Dia.: .82" (21mm), 18 lbs.</b>			
PLT1M-XMR	Nylon 6.6.	Natural	B1.121
PLT1M-XMR0	Weather Resistant Nylon 6.6.	Black	B1.121
PLT1M-XMR00	Weather Resistant Nylon 6.6 (Meets Mil Spec).	Black	B1.121
PLT1M-XMR30	Heat Stabilized Nylon 6.6.	Black	B1.121
<b>All-Nylon Tie – Max. Bundle Dia.: 1.31" (33mm), 18 lbs.</b>			
PLT1.5M-XMR	Nylon 6.6.	Natural	B1.121
PLT1.5M-XMR0	Weather Resistant Nylon 6.6.	Black	B1.121
PLT1.5M-XMR00	Weather Resistant Nylon 6.6 (Meets Mil Spec).	Black	B1.121
PLT1.5M-XMR30	Heat Stabilized Nylon 6.6.	Black	B1.121

### PAT2S/PAT3S Systems

Tool Head for use with STANDARD Cross Section

Part Number	Description	Page
PAT2S	For standard cross section up to 2.00" (51mm) bundle diameter.	B1.117
PAT3S	For standard cross section up to 2.75" (70mm) bundle diameter.	B1.117

#### Dispenser

Part Number	Description	Page
PDS	Stationary dispenser, PAT2S.	B1.117
PD3S	Stationary dispenser, PAT3S.	B1.117
PDS-DI	Dispenser and data interface software.	B1.119
PDS-DIA	Data interface accessory – software and interface card.	B1.119

#### Transfer Hose

Part Number	Description	Page
PHS2	6.5' (2m) transfer hose.	B1.118
PHS3	10.0' (3m) transfer hose.	B1.118

#### Dispenser Frame

Part Number	Description	Page
PDSF	Dispenser frame, PAT2S.	B1.118
PD3SF	Dispenser frame, PAT3S.	B1.118

#### Optional System Accessories

Part Number	Description	Page
PDH10-37	Air hose.	B1.118
PL283N1	Filter/regulator.	B1.118
PAT2SBM	Bench mount and foot pedal for PAT2S and PAT3S.	B1.118

### Reel-Fed Cable Ties

#### STANDARD Cross Section

Part Number	Description	Color	Page
<b>All-Nylon Tie – Max. Bundle Dia.: 2.00" (51mm), 50 lbs.</b>			
PLT2S-VMR	Nylon 6.6.	Natural	B1.122
PLT2S-VMR0	Weather Resistant Nylon 6.6.	Black	B1.122
PLT2S-VMR00	Weather Resistant Nylon 6.6 (Meets Mil Spec).	Black	B1.122
PLT2S-VMR30	Heat Stabilized Nylon 6.6.	Black	B1.122
<b>All-Nylon Tie – Max. Bundle Dia.: 2.75" (70mm), 50 lbs.</b>			
PLT3S-VMR	Nylon 6.6.	Natural	B1.122
PLT3S-VMR30	Heat Stabilized Nylon 6.6.	Black	B1.122

## Tool Head – Multiple sizes accommodate a wide variety of applications

- Ergonomic, lightweight design reduces operator fatigue and repetitive motion injuries – no counter balance required
- Right or left hand operation
- Durable, one-piece cable tie tip collector (for cut-off tips)
- Includes tension adjustment
- Built-in safety interlock prevents false triggering if anything obstructs jaw path



PAT1M



PAT1.5M



PAT2S



PAT3S



PAT1.5M-ATM  
For Bundling and  
Mounting Applications

Part Number	Max. Bundle Dia.		Dispenser/Frame	Transfer Hose	Used with Cable Ties	Std. Pkg. Qty.
	In.	mm				
PAT1M	.82	21	PDM	PHM1, PHM2, PHM3, PHM4	PLT1M-XMR, BT1M-XMR	1
PAT1.5M	1.31	33	PDM		PLT1.5M-XMR, BT1.5M-XMR	1
PAT2S	2.00	51	PDS/PDSF	PHS2, PHS3	PLT2S-VMR	1
PAT3S	2.75	70	PD3S/PD3SF		PLT3S-VMR	1
PAT1.5M-ATM	1.31	33	PDM	PHM1, PHM2, PHM3, PHM4	PLT1.5M-XMR, BT1.5M-XMR	1

## Dispensers

- Microprocessor based controller monitors system performance through LCD display; provides production data and reporting, including error detection and cycle count for improved reliability
- Online HELP menu through LCD display in five languages (English, Spanish, German, Italian or French), is user-friendly for quick and simple training



PDM



PDS/PD3S

Part Number	Used with Tool Head	Description	Std. Pkg. Qty.
PDM	PAT1M, PAT1.5M, PAT1.5M-ATM	Stationary dispenser with electronic display. Online help menu. System operates on 65 psig (minimum) non-lubricated filtered air and 100 – 24 FAC/TP or 60 MHz.	1
PDS	PAT2S		1
PD3S	PAT3S		1

A. System Overview

B1. Cable Ties

B2. Cable Accessories

B3. Stainless Steel Ties

C1. Wiring Duct

C2. Surface Raceway

C3. Abrasion Protection

C4. Cable Management

D1. Terminals

D2. Power Connectors

D3. Grounding Connectors

E1. Labeling Systems

E2. Labels

E3. Pre-Printed & Write-On Markers

E4. Permanent Identification

E5. Lockout/Tagout & Safety Solutions

F. Index

A.  
System  
Overview

## Transfer Hoses



PHM3

Part Number	Used with Tool Head	Part Description	Length		Std. Pkg. Qty.
			Ft.	m	
PHM1	PAT1M, PAT1.5M	Transfers cable tie and signal from dispenser to tool head; electrical connectors designed for easy attachment provide a reliable, secure connection.	3.2	1	1
PHM2			6.5	2	1
PHM3			10.0	3	1
PHM4			13.1	4	1
PHS2	PAT2S, PAT3S		6.5	2	1
PHS3			10.0	3	1

B1.  
Cable Ties

B2.  
Cable  
Accessories

B3.  
Stainless  
Steel Ties

C1.  
Wiring  
Duct

## Dispenser Frame



PDSF



PD3SF

Part Number	Used with Dispenser	Description	Std. Pkg. Qty.
PDSF	PDS (PAT2S)	Metal frame supports the PDS dispenser for PAT2S above the cable tie reel as ties are loaded into the dispenser; can be used as a freestanding unit or permanently mounted to a bench or cart.	1
PD3SF	PD3S (PAT3S)	Assembly holds cable tie reel and rewinds the packaging paper liner as cable ties are being loaded into the dispenser.	1

C2.  
Surface  
Raceway

C3.  
Abrasion  
Protection

C4.  
Cable  
Management

## Optional System Accessories:

### Filter/Regulator and Air Supply Hose



PL283N1



PDH10-37

Part Number	Used with Dispenser	Description	Std. Pkg. Qty.
PL283N1	PDM, PDS	Regulates air flow to dispenser. Filter/regulator 25 micron (max.) element, 3/8" ports. Includes a male connector and a 3/8" port.	1
PDH10-37	PDM, PDS	Air hose from filter/regulator to dispenser; 10.0' (3m) – includes standard air fittings.	1

D1.  
Terminals

D2.  
Power  
Connectors

D3.  
Grounding  
Connectors

E1.  
Labeling  
Systems

## Bench Mount



PATMBM

Part Number	Used with Tool Head	Description	Std. Pkg. Qty.
PATMBM	PAT1M, PAT1.5M	Allows hands-free operation for high volume usage. Includes bench mount fixture and foot pedal assembly.	1
PATSBM	PAT2S, PAT3S		1

E2.  
Labels

E3.  
Pre-Printed  
& Write-On  
Markers

E4.  
Permanent  
Identification

E5.  
Lockout/  
Tagout/  
& Safety  
Solutions

F.  
Index



## Data Interface Software and Ethernet Enabled Dispenser

Panduit exclusive Ethernet enabled dispenser and customized data interface software allow production personnel to monitor real-time data in a shop floor environment.

The Ethernet enabled dispenser provides a physical connection between the cable tie installation system and an Industrial Ethernet Network via an RJ45 connection and internal Ethernet card.

- Allows production and/or engineering personnel the capability to measure and track production performance such as job tracking, cycle counts, tool and dispenser serial numbers, and routine maintenance
- Provides the ability to send email notifications for specific system messages
- Data extraction and reporting capabilities on system performance through an exportable electronic log; helps identify operator training needs
- Ability to monitor alerts from remote desktop locations



Part Number	Used with Dispenser	Description	Std. Pkg. Qty.
PDM-DI	PDM	Ethernet enabled PDM dispenser and data interface software.	1
PDS-DI	PDS	Ethernet enabled PDS dispenser and data interface software.	1
PD-DIA	PDM/PDS	Data interface accessory for existing PDM, PDS dispensers; software and network interface card.	1

## PAT/Robot Integration Kit

- Used with the PAT1M and PAT1.5M tool heads
- Utilizes the PAT system electronic interface option, PDM-EI, to optimally integrate the PAT system to a robot for a completely automated cable tie installation process
- Significantly reduces labor costs while improving installation quality, reliability, and consistency



PATM-RK



PATM-TT

Part Number	Components	Description	Std. Pkg. Qty.
PATM-RK	Metallic housing	Includes a pneumatic trigger actuator for remote cable tie installation and a mounting bolt pattern to ease PAT tool integration with a robot end effector for a robust and accurate grip.	1
	Transfer hose strain relief kit	Strain relief to maintain transfer hose bend radius reducing tie misfeeds due to sharp hose bend radii during robot motion; also sold separately under part number PATM-RKS (includes two 1-foot strain relief tubes with fastening cable ties).	
	Quick start guides	Provides easily understood electrical, network, and mechanical installation instructions minimizing the robot integrator's design time and simplifying the integration process.	
	Best practices document	List of best practices when integrating the PAT system to a robot optimizing system performance and productivity.	
PATM-TT	Test tool with rubber jaws	This test tool is used during robot cable tie installation programming, providing a safe method to debug robot software without damaging actual PAT tools (test tool is not provided with the PAT/Robot Integration Kit).	1
PATM-RKS	Transfer hose strain relief kit	Strain relief to maintain transfer hose bend radius reducing cable tie misfeeds due to sharp hose bend radii during robot motion; kit is also included on the PATM-RK kit or sold separately (includes two 1-foot strain relief tubes with fastening cable ties).	1

A. System Overview



## BT-XMR Reel-Fed Cable Ties

B1. Cable Ties

- Continuously molded cable ties (5,000 ties/reel) provide continuous feeding for high productivity and reduced downtime due to fewer reel changes
- Reel-fed cable ties with exclusive stainless steel locking barb and 30 lbs. minimum loop tensile strength permit higher tension for demanding applications
- Metal locking barb and tie body design provide greater bundle tightness, reducing both rotational and lateral movement of the tie
- Reel-fed cable ties in Nylon 6.6 material (Natural color) are UL Listed for use in plenum or air handling spaces per NEC

B2. Cable Accessories

B3. Stainless Steel Ties

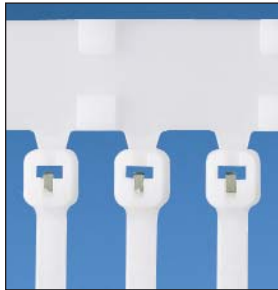

BT\_XMR

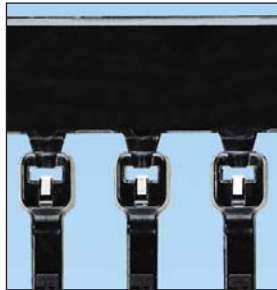

BT\_XMR (0, 30)

C1. Wiring Duct

C2. Surface Raceway

C3. Abrasion Protection

C4. Cable Management

D1. Terminals

D2. Power Connectors

D3. Grounding Connectors

E1. Labeling Systems

E2. Labels

E3. Pre-Printed & Write-On Markers

E4. Permanent Identification

E5. Lockout/Tagout & Safety Solutions

F. Index



Part Number	Tie Style	Material	Color	Max. Bundle Dia.		Length		Width		Min. Loop Tensile Str.		
				In.	mm	In.	mm	In.	mm	Lbs.	N	
<b>Reel-Fed Cable Ties for PAT1M System</b>												
<b>BT1M-XMR</b>	Barbed	Nylon 6.6	Natural	.82	21	4.0	102	.100	2.5	30	133	
<b>BT1M-XMR0</b>	Barbed	Weather Resistant Nylon 6.6	Black	.82	21	4.0	102	.100	2.5	30	133	
<b>BT1M-XMR30</b>	Barbed	Heat Stabilized Nylon 6.6	Black	.82	21	4.0	102	.100	2.5	30	133	
<b>Reel-Fed Cable Ties for PAT1.5M System</b>												
<b>BT1.5M-XMR</b>	Barbed	Nylon 6.6	Natural	1.31	33	5.6	142	.100	2.5	30	133	
<b>BT1.5M-XMR0</b>	Barbed	Weather Resistant Nylon 6.6	Black	1.31	33	5.6	142	.100	2.5	30	133	
<b>BT1.5M-XMR30</b>	Barbed	Heat Stabilized Nylon 6.6	Black	1.31	33	5.6	142	.100	2.5	30	133	



## PLT-XMR Reel-Fed Cable Ties

- Continuously molded cable ties (5,000 ties/reel) provide continuous feeding for high productivity and reduced downtime due to fewer reel changes
- All-nylon, one-piece locking ties with 18 lbs. minimum loop tensile strength in miniature cross section
- Available in a variety of colors and materials
- Reel-fed cable ties in Nylon 6.6 material (except black) are UL Listed for use in plenum or air handling spaces per NEC



Part Number	Tie Style	Material	Color	Max. Bundle Dia.		Length		Width		Min. Loop Tensile Str.	
				In.	mm	In.	mm	In.	mm	Lbs.	N
<b>Reel-Fed Cable Ties for PAT1M System</b>											
PLT1M-XMR	All-Nylon	Nylon 6.6	Natural	.82	21	4.0	102	.100	2.5	18	80
PLT1M-XMR0	All-Nylon	Weather Resistant Nylon 6.6	Black	.82	21	4.0	102	.100	2.5	18	80
PLT1M-XMR00*	All-Nylon	Weather Resistant Nylon 6.6	Black	.82	21	4.0	102	.100	2.5	18	80
PLT1M-XMR1	All-Nylon	Nylon 6.6	Brown	.82	21	4.0	102	.100	2.5	18	80
PLT1M-XMR2	All-Nylon	Nylon 6.6	Red	.82	21	4.0	102	.100	2.5	18	80
PLT1M-XMR3	All-Nylon	Nylon 6.6	Orange	.82	21	4.0	102	.100	2.5	18	80
PLT1M-XMR4Y	All-Nylon	Nylon 6.6	Yellow	.82	21	4.0	102	.100	2.5	18	80
PLT1M-XMR5	All-Nylon	Nylon 6.6	Green	.82	21	4.0	102	.100	2.5	18	80
PLT1M-XMR6	All-Nylon	Nylon 6.6	Blue	.82	21	4.0	102	.100	2.5	18	80
PLT1M-XMR7	All-Nylon	Nylon 6.6	Purple	.82	21	4.0	102	.100	2.5	18	80
PLT1M-XMR8	All-Nylon	Nylon 6.6	Gray	.82	21	4.0	102	.100	2.5	18	80
PLT1M-XMR10	All-Nylon	Nylon 6.6	White	.82	21	4.0	102	.100	2.5	18	80
PLT1M-XMR30	All-Nylon	Heat Stabilized Nylon 6.6	Black	.82	21	4.0	102	.100	2.5	18	80

### Reel-Fed Cable Ties for PAT1.5M System

PLT1.5M-XMR	All-Nylon	Nylon 6.6	Natural	1.31	33	5.6	142	.100	2.5	18	80
PLT1.5M-XMR0	All-Nylon	Weather Resistant Nylon 6.6	Black	1.31	33	5.6	142	.100	2.5	18	80
PLT1.5M-XMR00*	All-Nylon	Weather Resistant Nylon 6.6	Black	1.31	33	5.6	142	.100	2.5	18	80
PLT1.5M-XMR30	All-Nylon	Heat Stabilized Nylon 6.6	Black	1.31	33	5.6	142	.100	2.5	18	80

\*Military grade weather resistant material.

Note: PLT\_XMR cable ties (natural, 00, and colors) are Class 2 Mil. Spec. per SAE-AS23190A and SAE-AS33671.

A. System Overview

B1. Cable Ties

B2. Cable Accessories

B3. Stainless Steel Ties

C1. Wiring Duct

C2. Surface Raceway

C3. Abrasion Protection

C4. Cable Management

D1. Terminals

D2. Power Connectors

D3. Grounding Connectors

E1. Labeling Systems

E2. Labels

E3. Pre-Printed & Write-On Markers

E4. Permanent Identification

E5. Lockout/Tagout & Safety Solutions

F. Index

A.  
System  
Overview

**PLT-VMR Reel-Fed Cable Ties**



B1.  
Cable Ties

- Continuously molded cable ties (2,500 ties/reel) provide continuous feeding for high productivity and reduced downtime due to fewer reel changes

- All-nylon, one-piece locking ties with 50 lbs. minimum loop tensile strength in standard cross section for larger bundles up to 1.94" (49mm) diameter
- Reel-fed cable ties in Nylon 6.6 material (Natural color) are UL Listed for use in plenum or air handling spaces per NEC

B2.  
Cable  
Accessories

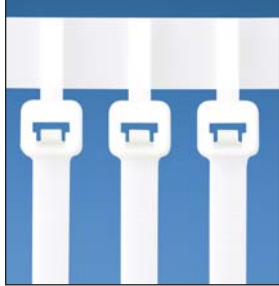

B3.  
Stainless  
Steel Ties

C1.  
Wiring  
Duct



C2.  
Surface  
Raceway

Part Number	Tie Style	Material	Color	Max. Bundle Dia.		Length		Width		Min. Loop Tensile Str.		
				In.	mm	In.	mm	In.	mm	Lbs.	N	
<b>Reel-Fed Cable Ties for PAT2S System</b>												
<b>PLT2S-VMR</b>	All-Nylon	Nylon 6.6	Natural	1.94	49	8.1	206	0.190	4.8	50	222	
<b>PLT2S-VMR0</b>	All-Nylon	Weather Resistant Nylon 6.6	Black	1.94	49	8.1	206	0.190	4.8	50	222	
<b>PLT2S-VMR30</b>	All-Nylon	Heat Stabilized Nylon 6.6	Black	1.94	49	8.1	206	0.190	4.8	50	222	
<b>Reel-Fed Cable Ties for PAT3S System</b>												
<b>PLT3S-VMR</b>	All-Nylon	Nylon 6.6	Natural	2.75	70	11.3	287	0.190	4.8	50	222	
<b>PLT3S-VMR30</b>	All-Nylon	Heat Stabilized Nylon 6.6	Black	2.75	70	11.3	287	0.190	4.8	50	222	

Note: PLT\_VMR Nylon 6.6 cable ties are Class 2 Mil. Spec. per SAE-AS23190A and SAE-AS33671.

D2.  
Power  
Connectors

D3.  
Grounding  
Connectors

E1.  
Labeling  
Systems

E2.  
Labels

E3.  
Pre-Printed  
& Write-On  
Markers

E4.  
Permanent  
Identification

E5.  
Lockout/  
Tagout  
& Safety  
Solutions

F.  
Index



## CABLE ACCESSORIES



Panduit provides a comprehensive offering of cable accessories. These accessories are engineered to speed installation and lower installed costs for routing and managing cable. Panduit cable accessories are designed and manufactured to meet applicable quality standards including International, UL, Military, ISO and Aerospace.



- Largest selection of mounts, clips, and clamps for cable management
- Panduit cable ties and accessories can be used in a variety of applications and environments, providing the optimal cable management solution
- Installation methods include adhesive backed, user applied adhesive, screws, rivets or push barb



Panduit mounts, clips, and clamps are manufactured in an environment committed to design innovation, high quality, and knowledgeable service to our customers. Adhesive backed mounts provide a strong adhesive bond for long-term reliability. Cable clips offer a one-piece solution to save time and reduce inventory. Harness board accessories speed the routing and forming of cable bundles in the fabrication of a harness. They hold bundles at a uniform height above the board and are ideal for use with Panduit manual and automatic cable tie tooling.

A.  
System  
Overview

B1.  
Cable Ties

B2.  
Cable  
Accessories

B3.  
Stainless  
Steel Ties

C1.  
Wiring  
Duct

C2.  
Surface  
Raceway

C3.  
Abrasion  
Protection

C4.  
Cable  
Management

D1.  
Terminals

D2.  
Power  
Connectors

D3.  
Grounding  
Connectors

E1.  
Labeling  
Systems

E2.  
Labels

E3.  
Pre-Printed  
& Write-On  
Markers

E4.  
Permanent  
Identification

E5.  
Lockout/  
Tagout  
& Safety  
Solutions

F.  
Index

A.  
System  
Overview

## Cable Accessories Products Overview – Used with Cable Ties

B1.  
Cable Ties

### Adhesive Backed Cable Tie Mounts

Pages B2.4 – B2.10

B2.  
Cable  
Accessories



- Uses premium Panduit adhesive for a long-term, reliable bond
- Adhesive backing allows routing of wires and cables where mounting holes cannot be drilled
- Mounts should be used with Panduit cable ties for a complete wire routing solution

B3.  
Stainless  
Steel Ties

C1.  
Wiring  
Duct

C2.  
Surface  
Raceway

C3.  
Abrasion  
Protection

### Screw Applied Cable Tie Mounts

Pages B2.11 – B2.17

C4.  
Cable  
Management



- Screw/riev applied cable tie mounts offer a countersunk or through hole in the mount through which a screw or rivet can be secured
- Offered in a wide selection of specialty materials for resistance to severe conditions such as heat, radiation, chemicals, and outdoor environments
- Available in styles ranging from low profile mounts with integral push-rivet to high stability cradle mounts for Extra-Heavy strength cable ties

D1.  
Terminals

D2.  
Power  
Connectors

D3.  
Grounding  
Connectors

E1.  
Labeling  
Systems

### Other Cable Tie Mounts

Pages B2.18 – B2.29

E2.  
Labels



- Push mount designs lock into a hole in a metallic panel or in a blind masonry hole
- Edge clip mounts secure to a panel edge using metal barbs that dig into panel surface
- Stud mounts secure onto threaded bolts by screwing or hammering on the bolt
- Connector rings can be used to attach adjacent bundles to provide spacing and prevent vibration damage

E3.  
Pre-Printed  
& Write-On  
Markers

E4.  
Permanent  
Identification

E5.  
Lockout/  
Tagout  
& Safety  
Solutions

F.  
Index

## Cable Accessories Products Overview – Used without Cable Ties

A.  
System  
Overview

B1.  
Cable  
Ties

### Adhesive Backed Clips and Clamps

Pages B2.30 – B2.39

B2.  
Cable  
Accessories

B3.  
Stainless  
Steel  
Ties

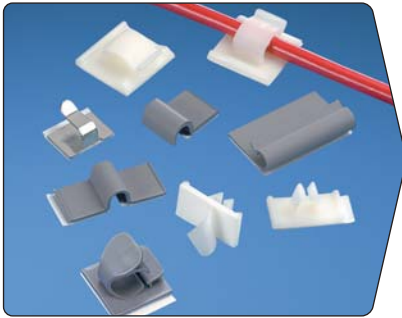

- A wide range of styles and sizes of adhesive backed clips and clamps to secure a variety of cables, from individual small diameter wires to large flat cables
- Products come in designs that use friction to hold a few cables, or more secure releasable latching designs
- Uses premium Panduit adhesive for a long-term, reliable bond

C1.  
Wiring  
Duct

C2.  
Surface  
Raceway

### Other Clips and Clamps

Pages B2.39 – B2.46

C3.  
Abrasion  
Protection

C4.  
Cable  
Management



- Screw clips use a screw, nail, or rivet to secure the clip to surface
- Plastic edge clips secure to an edge in a panel which incorporates a punched hole to provide mechanical retention
- Push-in clips use an arrow-head shaped barb to lock into a hole in a panel, and is available in a range of bundle sizes

D1.  
Terminals

D2.  
Power  
Connectors

D3.  
Grounding  
Connectors

### Harness Board Accessories

Pages B2.47 – B2.52

E1.  
Labeling  
Systems

E2.  
Labels

E3.  
Pre-Printed  
& Write-On  
Markers

E4.  
Permanent  
Identification

E5.  
Lockout/  
Tagout  
& Safety  
Solutions



- Allow an installer to quickly configure a specific arrangement of wires, to aid in required wire bundling and termination
- Hold wire bundles at a uniform height from a harness board to ease manual or automatic cable tie installation
- Aid in the proper routing and forming of wire bundles to help maintain end product consistency, reduce expensive rework and maximize safety

F.  
Index

A. System Overview

## 4-Way Adhesive Backed Cable Tie Mounts

B1. Cable Ties

- Allow cable tie entry from all four sides
- Available in multiple sizes to match application load requirements
- Produced 2-up or 4-up for fast and easy liner removal to speed installation

B2. Cable Accessories



B3. Stainless Steel Ties

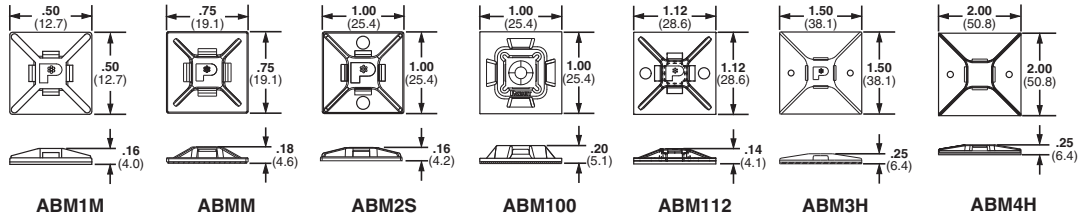

C1. Wiring Duct

Part Number	Used with Cable Ties‡	Material	Color	Environment	Mounting Method*	Std. Pkg. Qty.	Std. Ctn. Qty.
-------------	-----------------------	----------	-------	-------------	------------------	----------------	----------------

### 4-Way Mounts with Pre-Installed Adhesive

ABM1M-A-C	M	Nylon 6.6	White	Indoors	Rubber	100	500
ABM1M-AT-C		Nylon 6.6	White	Indoors/High Temp	Acrylic	100	500
ABMM-A-C	M, I	ABS	White	Indoors	Rubber	100	500
ABMM-AT-C		ABS	White	Indoors/High Temp	Acrylic	100	500
ABMM-AT-C0		Weather Resistant ABS	Black	Outdoors/High Temp	Acrylic	100	500
ABM2S-A-C	M, I, S	ABS	White	Indoors	Rubber	100	500
ABM2S-A-C14		ABS	Gray	Indoors	Rubber	100	500
ABM2S-A-C15		ABS	Ivory	Indoors	Rubber	100	500
ABM2S-AT-C		ABS	White	Indoors/High Temp	Acrylic	100	500
ABM2S-AT-C0		Weather Resistant ABS	Black	Outdoors/High Temp	Acrylic	100	500
ABM100-A-C	M, I, S	Nylon 6.6	White	Indoors	Rubber	100	1000
ABM100-A-C15		Nylon 6.6	Ivory	Indoors	Rubber	100	1000
ABM100-AT-C		Nylon 6.6	White	Indoors/High Temp	Acrylic	100	1000
ABM100-AT-C0		Weather Resistant Nylon 6.6	Black	Outdoors/High Temp	Acrylic	100	1000
ABM112-A-C		Nylon 6.6	White	Indoors	Rubber	100	500
ABM112-AT-C	Nylon 6.6	White	Indoors/High Temp	Acrylic	100	1000	
ABM112-AT-C0	Weather Resistant Nylon 6.6	Black	Outdoors/High Temp	Acrylic	100	1000	
ABM3H-A-L	M, I, S, HS, LH, H, HLM	Nylon 6.6	White	Indoors	Rubber	50	500
ABM3H-AT-L		Nylon 6.6	White	Indoors/High Temp	Acrylic	50	500
ABM4H-A-L		Nylon 6.6	White	Indoors	Rubber	50	500
ABM4H-AT-L		Nylon 6.6	White	Indoors/High Temp	Acrylic	50	500

‡Cable tie cross section sizes: M = Miniature, I = Intermediate, S = Standard, HS = Heavy-Standard, LH = Light-Heavy, and H = Heavy, HLM = Miniature Tak-Ty® Hook & Loop Ties.

\*For proper selection of adhesives see page B2.54.

E4. Permanent Identification

E5. Lockout/Tagout & Safety Solutions

F. Index

## 4-Way Adhesive Backed Cable Tie Mounts (continued)

Part Number	Used with Cable Ties‡	Material	Color	Environment	Mounting Method*	Std. Pkg. Qty.	Std. Ctn. Qty.	
<b>4-Way Mounts for Installation with Screws or User-Supplied Adhesive</b>								
ABMM-D	M, I	ABS	White	Indoors	User Supplied Adhesive	500	5000	
ABM2S-S6-D	M, I, S	ABS	White	Indoors	User Supplied Adhesive and/or two #6 (M3) Screws	500	5000	
ABM100-S6-C		Nylon 6.6	White	Indoors		100	1000	
ABM100-S6-C69		Flame Retardant Nylon 6.6	Natural	Indoors	User Supplied Adhesive and/or #6 (M3) Screw	100	1000	
ABM112-S6-C		Nylon 6.6	White	Indoors	User Supplied Adhesive and/or Two #6 (M3) Screws	100	1000	
ABM112-S6-C69		Flame Retardant Nylon 6.6	Natural	Indoors		100	500	
ABM3H-S6-T		M, I, S, HS, LH, H, HLM	Nylon 6.6	White	Indoors	User Supplied Adhesive and/or Two #6 (M3) Screws	200	2000
ABM4H-S6-T			Nylon 6.6	White	Indoors		200	1000

‡Cable tie cross section sizes: M = Miniature, I = Intermediate, S = Standard, HS = Heavy-Standard, LH = Light-Heavy, and H = Heavy, HLM = Miniature Tak-Ty® Hook & Loop Ties.

\*For proper selection of adhesives see page B2.54.

A.  
System  
Overview

B1.  
Cable Ties

B2.  
Cable  
Accessories

B3.  
Stainless  
Steel Ties

C1.  
Wiring  
Duct

C2.  
Surface  
Raceway

C3.  
Abrasion  
Protection

C4.  
Cable  
Management

D1.  
Terminals

D2.  
Power  
Connectors

D3.  
Grounding  
Connectors

E1.  
Labeling  
Systems

E2.  
Labels

E3.  
Pre-Printed  
& Write-On  
Markers

E4.  
Permanent  
Identification

E5.  
Lockout/  
Tagout  
& Safety  
Solutions

F.  
Index

A. System Overview

## ABMQ® Multiple Bridge Adhesive Backed Cable Tie Mounts

B1. Cable Ties

B2. Cable Accessories

B3. Stainless Steel Ties

- Multiple cable tie bridges on one mount speeds installation of cable bundles by reducing the number of mounts applied
- Dovetail connection system provides alignment and a joining method to expand routing capabilities
- V-groove allows for easy separation into two mounts with two bridges each for separate applications

- 4-way cable tie bridges allow cable bundles to be secured perpendicular to the mount for even spacing or inline to secure a bundle in multiple places
- Large adhesive surface area provides long-term reliability and keeps product in place despite heavy load or high stress

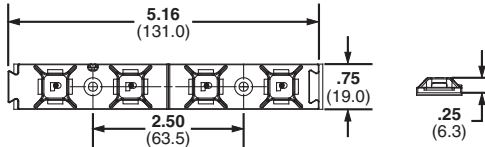

C1. Wiring Duct

C2. Surface Raceway

C3. Abrasion Protection

C4. Cable Management

D1. Terminals

D2. Power Connectors

D3. Grounding Connectors

E1. Labeling Systems

E2. Labels

E3. Pre-Printed & Write-On Markers

E4. Permanent Identification

E5. Lockout/Tagout & Safety Solutions

F. Index

Part Number	Used with Cable Ties‡	Material	Color	Environment	Mounting Method	Std. Pkg. Qty.	Std. Ctn. Qty.
<b>ABMQ Mounts with Pre-Installed Adhesive</b>							
<b>ABMQS-A-Q</b>	M, I, S	ABS	White	Indoors	Rubber	25	250
<b>ABMQS-A-Q20</b>		ABS	Black	Indoors	Rubber	25	250
<b>ABMQS-AT-Q</b>		ABS	White	Indoors/High Temp	Acrylic	25	250
<b>ABMQS-AT-Q0</b>		Weather Resistant ABS	Black	Outdoors/High Temp	Acrylic	25	250
<b>ABMQ Mounts for Installation with Screws or User-Supplied Adhesive</b>							
<b>ABMQS-S6-C0</b>	M, I, S	Weather Resistant ABS	Black	Outdoors/High Temp	Two #6 M3 Screws	100	1000
<b>ABMQS-S6-C</b>		ABS	White	Indoors/High Temp		100	1000

‡Cable tie cross section sizes: M = Miniature, I = Intermediate, and S = Standard.

## Tak-Ty® Hook & Loop Cable Tie Mounts

- For use with hook and loop cable ties, see page B1.87, B1.88
- Unique cradle design provides maximum stability for cable bundle
- For indoor use only

- Dimensions: 1.10"L x 1.12"W x 0.34"H (27.9mm x 28.4mm x 8.6mm)

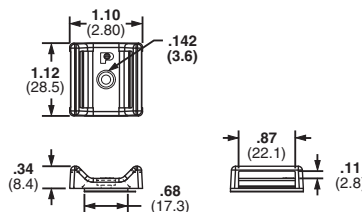

Part Number	Used with Cable Ties‡	Material	Color	Max. Static Load		Mounting Method*	Std. Pkg. Qty.	Std. Ctn. Qty.
				Lbs.	g			
<b>ABMT-A-C</b>	HLT, HLS, TTS, UCT	Nylon 6.6	Natural	0.38	174	Pre-installed Rubber Adhesive	100	1000
<b>ABMT-A-C20</b>			Black					
<b>ABMT-S6-C</b>			Natural	—	—	#6 (M3) Screw	100	1000
<b>ABMT-S6-C20</b>		Black						
<b>ABMT-S6-C60</b>		Black						
<b>ABMT-S6-C69</b>		Flame Retardant Nylon 6.6	Natural	—	—	100	1000	

‡Cable tie cross section sizes: HLT = Tak-Ty™ Hook & Loop Ties, HLS = Tak-Ty™ Hook & Loop Strip Tie, TTS = Tak-Tape™ Roll, UCT = Ultra-Cinch™ Tie.

\*For proper selection of adhesives see page B2.54.

## Super-Grip™ Adhesive Backed Cable Tie Mounts

- Low profile design keeps bundle close to mounting surface
- Small overall size allows use where space is limited

- For use with Super-Grip™ Cable Ties found on page B1.38
- New! High Bond Adhesive available

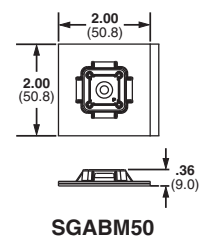
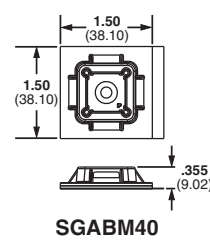
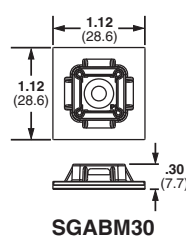
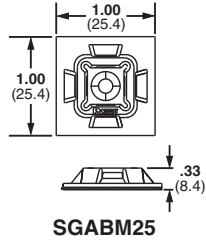

Part Number	Used with Cable Ties‡	Material	Color	Environment	Mounting Method*	Std. Pkg. Qty.	Std. Ctn. Qty.
<b>Super-Grip™ Mounts with Pre-Installed Adhesive</b>							
SGABM20-A-C	SGM, SGI	Nylon 6.6	White	Indoor Use	Rubber Adhesive	100	500
SGABM20-AT-C0		Weather Resistant Nylon 6.6	Black	Outdoors/High Temp	Acrylic Adhesive	100	500
SGABM20-AV-C300		Heat Stabilized Weather Resistant Nylon 6.6	Black	Outdoors/High Temp	High Bond Acrylic Adhesive	100	500
SGABM25-A-C	SGM, SGI, SGS	Nylon 6.6	White	Indoor Use	Rubber Adhesive	100	1000
SGABM25-AT-C0		Weather Resistant Nylon 6.6	Black	Outdoors/High Temp	Acrylic Adhesive	100	1000
SGABM25-AV-C300		Heat Stabilized Weather Resistant Nylon 6.6	Black	Outdoors/High Temp	High Bond Acrylic Adhesive	100	1000
SGABM30-A-C		Nylon 6.6	White	Indoor Use	Rubber Adhesive	100	500
SGABM30-AT-C0		Weather Resistant Nylon 6.6	Black	Outdoors/High Temp	Acrylic Adhesive	100	500
SGABM30-AV-C300		Heat Stabilized Weather Resistant Nylon 6.6	Black	Outdoors/High Temp	High Bond Acrylic Adhesive	100	500
SGABM40-A-L	SGM, SGI, SGS, SGLH, SGH	Nylon 6.6	White	Indoor Use	Rubber Adhesive	50	500
SGABM40-AT-L0		Weather Resistant Nylon 6.6	Black	Outdoors/High Temp	Acrylic Adhesive	50	500
SGABM50-A-L		Nylon 6.6	White	Indoor Use	Rubber Adhesive	50	500
SGABM50-AT-L0		Weather Resistant Nylon 6.6	Black	Outdoors/High Temp	Acrylic Adhesive	50	500
<b>Super-Grip™ Mounts for Installation with Screws or User-Supplied Adhesive</b>							
SGABM25-S6-C	SGM, SGI, SGS	Nylon 6.6	White	Indoors	#6 (M3) Screw	100	1000
SGABM25-S6-C0		Weather Resistant Nylon 6.6	Black	Outdoors	#6 (M3) Screw or User Supplied Adhesive	100	1000

‡Cable tie cross section sizes: SGM = Super-Grip® Miniature, SGI = Super-Grip® Intermediate, SGS = Super-Grip® Standard, SGLH = Super-Grip® Light-Heavy, and SGH = Super-Grip® Heavy.

\*For proper selection of adhesive see page B2.54.

A. System Overview

## Combination Adhesive Mount/Cable Ties

B1. Cable Ties

- Adhesive mount and cable tie molded as one-piece helps reduce inventory costs
- Available with locking or releasable tie
- For indoor use only
- Material: Nylon 6.6

B2. Cable Accessories



B3. Stainless Steel Ties

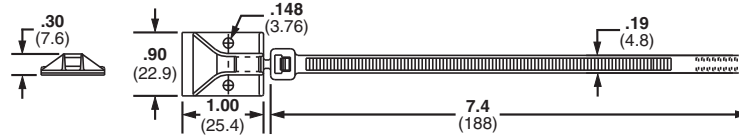

C1. Wiring Duct

C2. Surface Raceway

C3. Abrasion Protection

C4. Cable Management

Part Number	Tool	Color	Adhesive Type	Std. Pkg. Qty.	Std. Ctn. Qty.
<b>Locking Cable Tie</b>					
<b>PLA2S-A-Q</b>	GTS, GTSL, GS2B, GS4H, PTS, PTH, PPTS, STS2, STH2	White	Rubber	25	250
<b>Releasable Cable Tie</b>					
<b>PRA2S-A-Q</b>	Hand installed only	White	Rubber	25	250

## Snap-In Cable Tie Mounts – Mechanically Applied

D1. Terminals

D2. Power Connectors

D3. Grounding Connectors

E1. Labeling Systems

E2. Labels

E3. Pre-Printed & Write-On Markers

E4. Permanent Identification

E5. Lockout/Tagout & Safety Solutions

F. Index

- For use with Panduit Standard cross section cable ties including PLT1S, PLT1.5S, PLT2S, PRT1.5S and PRT2S
- Integral retaining notch holds cable tie head in place below bundle
- Eliminates protruding tie head and facilitates one hand tie threading
- Quickly route wire and cable where mounting holes cannot be drilled
- For indoor use only
- Material: ABS

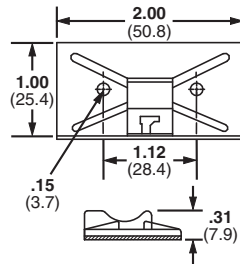

Part Number	Used with Cable Ties†	Color	Mounting Method	Std. Pkg. Qty.	Std. Ctn. Qty.
<b>Snap-In Mounts with Pre-Installed Adhesive</b>					
<b>SMS-A-C</b>	S	White	Rubber	100	500
<b>SMS-A-C14</b>		Gray	Rubber	100	500
<b>SMS-A-C15</b>		Ivory	Rubber	100	500
<b>Snap-in Mounts for application with screws or user-supplied adhesive</b>					
<b>SMS-S6-D</b>	S	White	User Supplied Adhesive and/or Two #6 M3 Screws	500	5000

†Cable tie cross section size: S = Standard.



## Epoxy Applied Mounts

- Provide a fast, strong, economical method to secure wire/cable to most surfaces
- Eliminate the need to drill holes

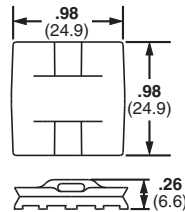

Part Number	Used with Cable Ties‡	Material	Color	Environment	Mounting Method	Std. Pkg. Qty.	Std. Ctn. Qty.
EMS-A-C	M, I, S	Nylon 6.6	Natural	Indoors	EMA epoxy	100	1000
EMS-A-C0		Weather Resistant Nylon 6.6	Black	Outdoors			

‡Cable tie cross section sizes: M = Miniature, I = Intermediate, and S = Standard.

## Epoxy Applied Swivel Mount

- Swivels 360° to assure proper orientation with harness
- For indoor use only
- Four inspection holes to check adhesive coverage

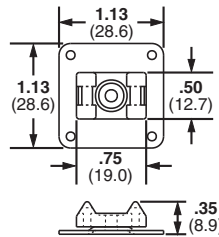

Part Number	Used with Cable Ties‡	Mounting Method	Std. Pkg. Qty.	Std. Ctn. Qty.
ASMS-A-X	M, I, S, SGM, SGI	EMA Epoxy	10	100

‡Cable tie cross section sizes: M = Miniature, I = Intermediate, S = Standard, SGM = Super-Grip® Miniature, and SGI = Super-Grip® Intermediate.

## Epoxy Applied Cable Tie Mount Kits

- EMA Epoxy supplied in convenient two-compartment mixer cup with a mixer stick for each cup
- Each cup contains adhesive for three EMS or ASMS mounts
- Epoxy hardens in approximately five minutes
- After full 24 hour cure time, bonding strength will exceed 50 lbs. on a clean, grease-free surface
- Not recommended for use on polyethylene and polypropylene surfaces



Part Number	Used with Cable Ties‡	Environment	Epoxy Cups	Mixer Sticks	EMS Mounts	Cable Ties	Std. Pkg. Qty.	Std. Ctn. Qty.
<b>Epoxy Adhesive Only</b>								
EMA-X	—	Indoors/Outdoors	10	10	—	—	10	—
<b>Epoxy Mounting Kit with EMS Mounts</b>								
EMSK3-1-X0	M, I, S	Indoors/Outdoors	1	1	3	—	10	—
<b>Epoxy Mounting Kit with EMS Mounts and Cable Ties</b>								
EMSK3-1-3-0	M, I, S	Indoors/Outdoors	1	1	3	3	1	10
EMSK12-4-12-X0		Indoors/Outdoors	4	4	12	12	10	10

‡Cable tie cross section sizes: M = Miniature, I = Intermediate, and S = Standard.

A.  
System  
Overview

## **PANDUIT® Tie Mounts – Applied with User Supplied Adhesives**

B1.  
Cable Ties

- Solid flat bottom surface provides maximum holding area
- For indoor use only
- Material: Nylon 6.6

B2.  
Cable  
Accessories



B3.  
Stainless  
Steel Ties

Part Number	Used with Cable Ties‡	Color	Mounting Method	Std. Pkg. Qty.	Std. Ctn. Qty.
TM1A-C	M	Natural	User Supplied Adhesive	100	1000
TM2A-C	M, I, S			100	500
TM3A-C	M, I, S, HS, LH			100	500

‡Cable tie cross section sizes: M = Miniature, I = Intermediate, S = Standard, HS = Heavy Standard and LH = Light-Heavy.

C1.  
Wiring  
Duct

C2.  
Surface  
Raceway

## **PANDUIT® Low Profile Tie Mounts – User Supplied Adhesive Mounts**

C3.  
Abrasion  
Protection

- Low profile design keeps bundle close to mounting surface
- For indoor use only
- Material: Nylon 6.6

C4.  
Cable  
Management



D1.  
Terminals



D2.  
Power  
Connectors

Part Number	Used with Cable Ties‡	Color	Mounting Method	Std. Pkg. Qty.	Std. Ctn. Qty.
AM2-C	M, I, S	Natural	User Supplied Adhesive	100	500

‡Cable tie cross section sizes: M = Miniature, I = Intermediate, and S = Standard.

D3.  
Grounding  
Connectors

E1.  
Labeling  
Systems

E2.  
Labels

E3.  
Pre-Printed  
& Write-On  
Markers

E4.  
Permanent  
Identification

E5.  
Lockout/  
Tagout  
& Safety  
Solutions

F.  
Index

## Cable Tie Mounts – Screw Applied

- Unique cradle design provides maximum stability for the cable bundle
- Low profile design keeps bundle close to mounting surface

- Wide selection of materials available
- UL Recognized except HVTM and SGTM series

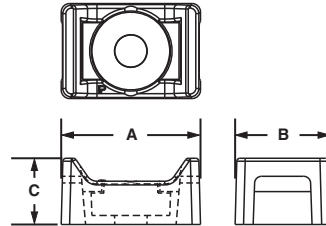

Part Number	Used with Cable Ties†	Counterbore Diameter		Length A		Width B		Height C		Mounting Method	Std. Pkg. Qty.	Std. Ctn. Qty.
		In.	mm	In.	mm	In.	mm	In.	mm			
TM1S4-C	M	0.23	5.7	0.51	13.0	0.32	8.0	0.23	5.8	#4 (M2.5) Screw	100	500
TM1S6-C		0.28	7.0	0.51	13.0	0.32	8.0	0.23	5.8	#6 (M3) Screw	100	500
TM2S6-C	M, I, S	0.29	7.1	0.63	16.0	0.43	10.8	0.28	7.0	#6 (M3) Screw	100	500
TM2S8-C		0.33	8.4	0.63	16.0	0.43	10.8	0.28	7.0	#8 (M4) Screw	100	500
TM3S8-C	M, I, S, LH	0.32	8.1	0.86	21.9	0.61	15.5	0.37	9.4	#8 (M4) Screw	100	500
TM3S10-C		0.38	9.7	0.86	21.9	0.61	15.8	0.37	9.4	#10 (M5) Screw	100	500

### Super-Grip® Cable Tie Mounts



SGTM1S6-C	SGM	0.28	7.0	0.51	13.0	0.38	9.7	0.22	5.6	#6 (M3) Screw	100	500
SGTM1S6-C0	SGM	0.28	7.0	0.51	13.0	0.38	9.7	0.22	5.6	#6 (M3) Screw	100	500
SGTM2S8-C	SGM, SGI, SGS	0.33	8.4	0.66	16.7	0.48	12.2	0.34	7.0	#8 (M4) Screw	100	500
SGTM2S8-C0	SGM, SGI, SGS	0.33	8.4	0.66	16.7	0.48	12.2	0.34	8.6	#8 (M4) Screw	100	500
SGTM3S10-C	SGM, SGI, SGS, SGLH	0.38	9.7	0.91	23.1	0.61	15.4	0.43	11.0	#10 (M5) Screw	100	500
SGTM3S10-C0	SGM, SGI, SGS, SGLH	0.38	9.7	0.91	23.1	0.61	15.4	0.43	11.0	#10 (M5) Screw	100	500

### Hyper-V™ Cable Tie Mounts

HVTM-06-C0	HV	0.40	10.2	0.81	20.6	0.68	17.3	0.41	10.4	#10 (6mm) Screw	100	500
------------	----	------	------	------	------	------	------	------	------	-----------------	-----	-----

†Cable tie cross section sizes: M = Miniature, I = Intermediate, S = Standard, LH = Light-Heavy, SGM = Super-Grip® Miniature, SGI = Super-Grip® Intermediate, SGS = Super-Grip® Standard, SGLH = Super-Grip® Light-Heavy, and HV = Hyper-V™.

### Additional tie mounts available in specified materials. All are available as standard Panduit parts.

Metal Detectable Nylon	Metal Detectable Polypropylene	PEEK	Heat Stabilized Nylon	Flame Retardant Nylon	Weather Resistant Nylon	Weather Resistant Polypropylene	Tefzel®
TMS28-C86	TMS28-C186	TM2S8-C71	TM1S4-M30	TM1S4-M69	TM1S6-M0	TM2S8-C100	TM2S8-C76
TM3S8-C86	TM3S8-C186		TM1S6-M30	TM1S6-M69	TM2R6-M0	TM3S8-C100	TM3S8-C76
TM3S10-C86	TM3S10-C186		TM2R6-M30	TM2S6-M69	TM2S6-M0	TM3S8-M100	TM3S10-C76
			TM2S6-M30	TM2S8-M69	TM2S8-M0		
			TM2S8-M30	TM3S8-C69	TM3R6-M0		
			TM3S8-M30	TM3S8-M69	TM3S10-M0		
			TM3S10-M30	TM3S10-M69	TM3S25-M0		
			TM3S25-M30				

®TEFZEL is a registered trademark of E.I. du Pont de Nemours and Company.

A.  
System  
Overview

B1.  
Cable  
Ties

B2.  
Cable  
Accessories

B3.  
Stainless  
Steel  
Ties

C1.  
Wiring  
Duct

C2.  
Surface  
Raceway

C3.  
Abrasion  
Protection

C4.  
Cable  
Management

D1.  
Terminals

D2.  
Power  
Connectors

D3.  
Grounding  
Connectors

E1.  
Labeling  
Systems

E2.  
Labels

E3.  
Pre-Printed  
& Write-On  
Markers

E4.  
Permanent  
Identification

E5.  
Lockout/  
Tagout  
& Safety  
Solutions

F.  
Index

A. System Overview

## Extra-Heavy Cable Tie Mounts – Screw Applied

- Unique cradle design provides maximum stability for cable bundle
- Route and support large diameter and heavy cable bundles

B1. Cable Ties

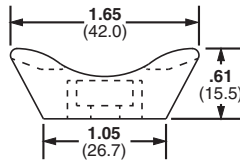

B2. Cable Accessories

B3. Stainless Steel Ties

C1. Wiring Duct

C2. Surface Raceway

C3. Abrasion Protection

C4. Cable Management

D1. Terminals

D2. Power Connectors

D3. Grounding Connectors

E1. Labeling Systems

E2. Labels

E3. Pre-Printed & Write-On Markers

E4. Permanent Identification

E5. Lockout/Tagout & Safety Solutions

F. Index

Part Number	Used with Cable Ties‡	Material	Color	Environment	Mounting Method	Std. Pkg. Qty.	Std. Ctn. Qty.
<b>TMEH-S8-Q0</b>	M, I, S, HS, LH, H, EH, HLM	Weather Resistant Nylon 6.6	Black	Outdoors	#8 (M4) Screw	25	250
<b>TMEH-S10-Q0</b>					#10 (M5) Screw	25	250
<b>TMEH-S25-Q0</b>					1/4 (M6) Screw	25	250
<b>TMEH-S10-C100</b>		Weather Resistant Polypropylene	Green	Indoors	#10 (M5) Screw	100	500
<b>TMEH-S10-C109</b>	Polypropylene	#10 (M5) Screw			100	500	

‡Cable tie cross section sizes: M = Miniature, I = Intermediate, S = Standard, HS = Heavy-Standard, LH = Light-Heavy, H = Heavy, EH = Extra-Heavy and HLM = Miniature Tak-Ty® Hook & Loop Ties.

## Swivel Mounts

- The two mounts are securely fastened together with a connecting rivet that allows both mounts to rotate
- Separates bundles to avoid abrasion
- Material: Weather Resistant Nylon 6.6
- Can join bundles of cable, tubing, or hoses that may need to move or are not parallel

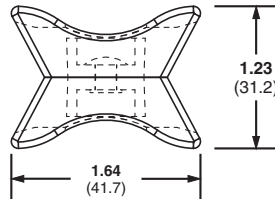

TMEH

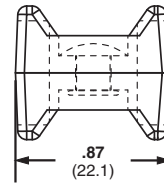
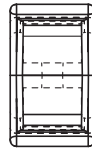

TM3

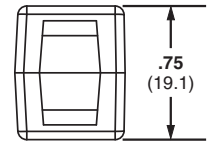

Part Number	Used with Cable Ties‡	Pull Apart Force		Color	Environment	Std. Pkg. Qty.	Std. Ctn. Qty.
		Lbs.	g				
<b>TM3-X2-C0Y</b>	M, I, S, HS, LH	120	54,431	Black	Indoors/Outdoors	100	1000
<b>TMEH-X2-L0Y</b>	M, I, S, HS, LH, H, EH, HLM	250	113,398			50	500

‡Cable tie cross section sizes: M = Miniature, I = Intermediate, S = Standard, HS = Heavy-Standard, LH = Light-Heavy, H = Heavy, EH = Extra-Heavy and HLM = Miniature Tak-Ty® Hook & Loop Ties.

## 4-Way Tie Anchor Mounts – Screw Applied

- 4-way cable tie entry makes part orientation fast and easy
- Small overall size allows for use where space is limited



Part Number	Used With Cable Ties‡	Hole Diameter		Material	Color	Environment	Mounting Method	Std. Pkg. Qty.	Std. Ctn. Qty.
		In.	mm						
<b>TA1S8-C</b>	M, I, S	0.17	4.3	Nylon 6.6	Natural	Indoors	#8 (M4) Screw	100	500
<b>TA1S8-M0</b>		0.17	4.3	Weather Resistant Nylon 6.6	Black	Outdoors	#8 (M4) Screw	1000	5000
<b>TA1S8-M30</b>		0.17	4.3	Heat Stabilized Nylon 6.6	Black	Indoors	#8 (M4) Screw	1000	5000
<b>TA1S8-M69</b>		0.17	4.3	Flame Retardant Nylon 6.6	Natural	Indoors	#8 (M4) Screw	1000	5000
<b>TA1S10-C</b>		0.17	4.3	Nylon 6.6	Natural	Indoors	#10 (M5) Screw	100	500
<b>TA1S10-M0</b>		0.20	5.1	Weather Resistant Nylon 6.6	Black	Outdoors	#10 (M5) Screw	1000	5000

### Super-Grip® Cable Tie Mounts

<b>SGTA1S8-C</b>	SGM,SGI,SGS	0.17	4.3	Nylon 6.6	Natural	Indoors	#8 (M4) Screw	100	500
------------------	-------------	------	-----	-----------	---------	---------	---------------	-----	-----

‡Cable tie cross section sizes: M = Miniature, I = Intermediate, S = Standard, SGM = Super-Grip® Miniature, SGI = Super-Grip® Intermediate, and SGS = Super-Grip® Standard.

## Tie Anchor Mounts – Screw Applied

- Install perpendicular to the wire bundle
- Elongated slot permits cable bundle adjustment in application
- Low profile design keeps bundle close to mounting surface where overhead space is limited
- Material: Nylon 6.6

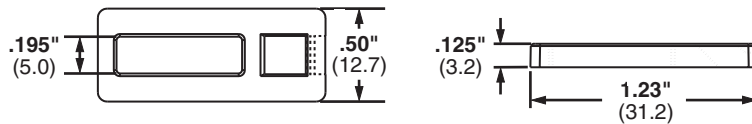

Part Number	Used with Cable Ties‡	Color	Environment	Mounting Method	Std. Pkg. Qty.	Std. Ctn. Qty.
<b>TA2-C</b>	M, I, S	Natural	Indoors	#10 (M5) Screw	100	1000
<b>TA2-M</b>					1000	5000

‡Cable tie cross section sizes: M = Miniature, I = Intermediate, and S = Standard.

A.  
System  
Overview

B1.  
Cable Ties

B2.  
Cable  
Accessories

B3.  
Stainless  
Steel Ties

C1.  
Wiring  
Duct

C2.  
Surface  
Raceway

C3.  
Abrasion  
Protection

C4.  
Cable  
Management

D1.  
Terminals

D2.  
Power  
Connectors

D3.  
Grounding  
Connectors

E1.  
Labeling  
Systems

E2.  
Labels

E3.  
Pre-Printed  
& Write-On  
Markers

E4.  
Permanent  
Identification

E5.  
Lockout/  
Tagout  
& Safety  
Solutions

F.  
Index

A. System Overview

## Low Profile Mounts – Screw Applied

- Low profile design keeps bundle close to mounting surface
- Small overall size
- Install with a screw or rivet for a strong, secure installation
- For indoor use only
- Material: Nylon 6.6

B1. Cable Ties

B2. Cable Accessories

B3. Stainless Steel Ties

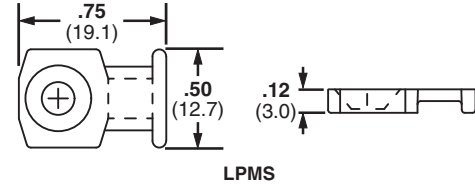
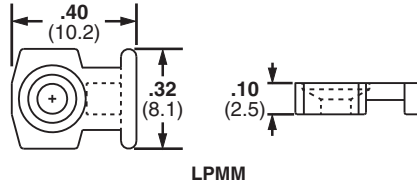

Part Number	Used with Cable Ties‡	Color	Mounting Method	Std. Pkg. Qty.	Std. Ctn. Qty.
<b>LPMM-S2-C</b>	M	Natural	#2 (M2) Countersunk Screw	100	1000
<b>LPMM-S5-C</b>	M		#5 (M3) Countersunk Screw	100	1000
<b>LPMS-S8-C</b>	M, I, S		#8 (M4) Countersunk Screw	100	1000

‡Cable tie cross section sizes: M = Miniature, I = Intermediate, and S = Standard.

C1. Wiring Duct

C2. Surface Raceway

C3. Abrasion Protection

C4. Cable Management

## Low Profile Mounts – Push Rivet Applied

- Eliminate screws
- Secure wires to any pre-drilled panel
- Can be installed in any panel thickness
- Low profile design keeps bundle close to mounting surface
- For indoor use only
- Material: Nylon 6.6

D1. Terminals

D2. Power Connectors

D3. Grounding Connectors

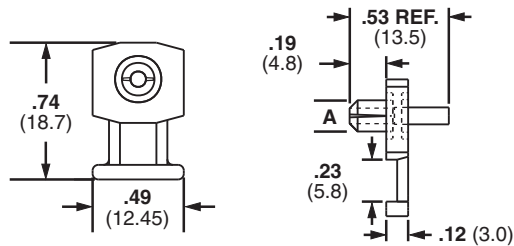
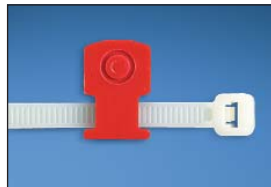

Part Number	Used with Cable Ties‡	Hole Diameter A		Color	Mounting Method	Std. Pkg. Qty.	Std. Ctn. Qty.
		In.	mm				
<b>KIMS-H366-C2</b>	M, I, S	.144	3.7	Red	Integral Push Rivet	100	1000
<b>KIMS-H430-C6</b>		.169	4.3	Blue	Integral Push Rivet	100	1000
<b>KIMS-H500-C4</b>		.196	5.0	Yellow	Integral Push Rivet	100	1000

‡Cable tie cross section sizes: M = Miniature, I = Intermediate, and S = Standard.

E1. Labeling Systems

E2. Labels

E3. Pre-Printed & Write-On Markers

E4. Permanent Identification

E5. Lockout/Tagout & Safety Solutions

F. Index

## Cable Tie Plates

- Slotted mounting hole accommodates various fastener spacing
- Low profile design keeps bundle close to mounting surface
- For indoor use only
- Material: Nylon 6.6

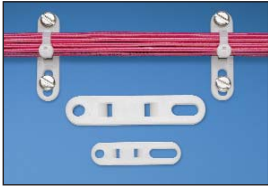

Part Number	Used with Cable Ties‡	Length A		Width B		Height C		Hole Spacing D		Color	Mounting Method	Std. Pkg. Qty.	Std. Ctn. Qty.
		In.	mm	In.	mm	In.	mm	In.	mm				
TP2-C	M, I, S	1.98	50.3	.50	12.7	.13	3.2	1.60	40.6	Natural	#10 (M5) Screw	100	1000
TP4H-C	M, I, S, HS, LH, H	3.08	78.2	.62	15.7	.20	5.2	2.50	63.5	Natural	1/4 (M6) Screw	100	1000

‡Cable tie cross section sizes: M = Miniature, I = Intermediate, S = Standard, HS = Heavy-Standard, LH = Light-Heavy and H = Heavy.

## Multiple Tie Plates

- Used to secure closely spaced wire bundles
- Low profile design keeps bundle close to mounting surface
- For indoor use only
- Material: Nylon 6.6

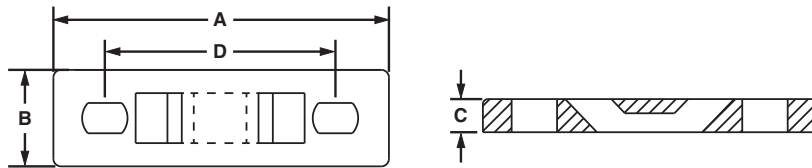

Part Number	No. of Bundles	Used with Cable Ties‡	Length A		Width B		Height C		Hole Spacing D		Mounting Method	Mil. Std. Part Number	Std. Pkg. Qty.	Std. Ctn. Qty.
			In.	mm	In.	mm	In.	mm	In.	mm				
MTP1S-E6-C	1	M, I, S	1.75	44.5	.50	12.7	.13	3.2	1.25	31.8	#6 (M3) Screw	MS3339-1-9	100	1000
MTP1S-E10-C			1.75	44.5	.50	12.7	.13	3.2	1.25	31.8	#10 (M5) Screw	—	100	1000
MTP1H-E6-C		M, I, S, HS, LH, H	2.09	53.1	.63	16.0	.20	5.2	1.50	38.1	#6 (M3) Screw	MS3339-6-9	100	1000
MTP1H-E10-C			2.09	53.1	.63	16.0	.20	5.2	1.50	38.1	#10 (M5) Screw	—	100	1000
MTP2S-E6-C	2	M, I, S	3.00	76.2	.50	12.7	.13	3.2	2.50	63.5	#6 (M3) Screw	MS3339-2-9	100	1000
MTP2S-E10-C			3.00	76.2	.50	12.7	.13	3.2	2.50	63.5	#10 (M5) Screw	—	100	1000
MTP2H-E6-C		M, I, S, HS, LH, H	3.59	91.2	.63	16.0	.20	5.2	3.00	76.2	#6 (M3) Screw	MS3339-7-9	100	1000
MTP2H-E10-C			3.59	91.2	.63	16.0	.20	5.2	3.00	76.2	#10 (M5) Screw	—	100	1000

‡Cable tie cross section sizes: M = Miniature, I = Intermediate, S = Standard, HS = Heavy-Standard, LH = Light-Heavy and H = Heavy.

Table continues on page B2.16

A. System Overview

B1. Cable Ties

B2. Cable Accessories

B3. Stainless Steel Ties

C1. Wiring Duct

C2. Surface Raceway

C3. Abrasion Protection

C4. Cable Management

D1. Terminals

D2. Power Connectors

D3. Grounding Connectors

E1. Labeling Systems

E2. Labels

E3. Pre-Printed & Write-On Markers

E4. Permanent Identification

E5. Lockout/Tagout & Safety Solutions

F. Index

## Multiple Tie Plates (continued)

Part Number	No. of Bundles	Used with Cable Ties‡	Length A		Width B		Height C		Hole Spacing D		Mounting Method	Mil. Std. Part Number	Std. Pkg. Qty.	Std. Ctn. Qty.
			In.	mm	In.	mm	In.	mm	In.	mm				
MTP3S-E6-C	3	M, I, S	4.25	108.0	.50	12.7	.13	3.2	3.75	95.3	#6 (M3) Screw	MS3339-3-9	100	1000
MTP3S-E10-C			4.25	108.0	.50	12.7	.13	3.2	3.75	95.3	#10 (M5) Screw	—	100	1000
MTP3H-E6-C		M, I, S, HS, LH, H	5.09	129.3	.63	16.0	.20	5.2	4.50	114.3	#6 (M3) Screw	MS339-8-9	100	1000
MTP3H-E10-C			5.09	129.3	.63	16.0	.20	5.2	4.50	114.3	#10 (M5) Screw	—	100	1000
MTP4S-E6-C	4	M, I, S	5.50	139.7	.50	12.7	.13	3.2	5.00	127.0	#6 (M3) Screw	MS3339-4-9	100	1000
MTP4S-E10-C			5.50	139.7	.50	12.7	.13	3.2	5.00	127.0	#10 (M5) Screw	—	100	1000
MTP4H-E6-C		M, I, S, HS, LH, H	6.59	167.4	.63	15.7	.20	5.2	6.00	152.4	#6 (M3) Screw	MS3339-9-9	100	1000
MTP4H-E10-C			6.59	167.4	.63	15.7	.20	5.2	6.00	152.4	#10 (M5) Screw	—	100	1000
MTP5S-E6-C	5	M, I, S	6.75	171.5	.50	12.7	.13	3.2	6.25	158.8	#6 (M3) Screw	MS3339-5-9	100	1000
MTP5S-E10-C			6.75	171.5	.50	12.7	.13	3.2	6.25	158.8	#10 (M5) Screw	—	100	1000
MTP5H-E6-C		M, I, S, HS, LH, H	8.09	205.5	.63	16.0	.20	5.2	7.50	190.5	#6 (M3) Screw	MS3339-10-9	100	1000
MTP5H-E10-C			8.09	205.5	.63	16.0	.20	5.2	7.50	190.5	#10 (M5) Screw	—	100	1000
MTP6H-E6-C	6	M, I, S, HS, LH, H	9.59	243.6	.63	16.0	.20	5.2	9.00	228.6	#6 (M3) Screw	MS3339-11-9	100	1000
MTP6H-E10-C			9.59	243.6	.63	16.0	.20	5.2	9.00	228.6	#10 (M5) Screw	—	100	1000

‡Cable tie cross section sizes: M = Miniature, I = Intermediate, S = Standard, HS = Heavy-Standard, LH = Light-Heavy and H = Heavy.

## Contour Multiple Tie Plates

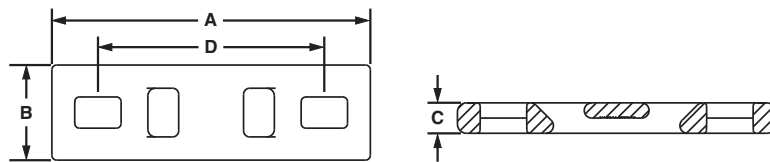

Part Number	No. of Bundles	Used with Cable Ties‡	Length A		Width B		Height C		Hole Spacing D		Mounting Method	Mil. Std. Part Number	Std. Pkg. Qty.	Std. Ctn. Qty.
			In.	mm	In.	mm	In.	mm	In.	mm				
MTPC1H-E10-C39	1	M, I, S, HS, LH, H	2.09	53.1	.63	16.0	.20	5.2	1.5	38.1	#10 (M5) Screw	—	100	1000
MTPC2H-E10-C39	2		3.59	91.2	.63	16.0	.20	5.2	3.0	6.2	#10 (M5) Screw	—	100	1000
MTPC3H-E10-C39	3		5.09	129.3	.63	16.0	.20	5.2	4.50	114.3	#10 (M5) Screw	—	100	1000
MTPC4H-E10-C39	4		6.59	167.4	.63	15.7	.20	5.2	6.00	152.4	#10 (M5) Screw	—	100	1000
MTPC5H-E10-C39	5		8.09	205.5	.63	16.0	.20	5.2	7.50	190.5	#10 (M5) Screw	—	100	1000
MTPC6H-E10-C39	6		9.59	243.6	.63	16.0	.20	5.2	9.00	228.6	#10 (M5) Screw	—	100	1000

‡Cable tie cross section sizes: M = Miniature, I = Intermediate, S = Standard, HS = Heavy-Standard, LH = Light-Heavy and H = Heavy.



## Right Angle Mounts

- Hold cable bundles away from the sharp edges of bulkheads or cabinet holes
- For indoor use only
- Can also be used to mount cable bundles adjacent to any surface
- Material: Nylon 6.6

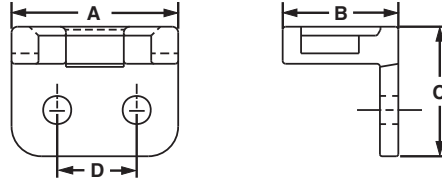

Part Number	Used with Cable Ties‡	Length A		Width B		Height C		Hole Spacing D		Color	Mil. Std. Part Number	Mounting Method	Std. Pkg. Qty.	Std. Ctn. Qty.
		In.	mm	In.	mm	In.	mm	In.	mm					
RAMS-S3-M	M, I, S	.56	14.2	.39	9.9	.44	11.0	.28	7.1	Natural	MS3341-2-9	#3 (M2.5) Screw or 3/32 (2.4) Rivet	1000	5000
RAMH-S6-D	M, I, S, HS, LH, H	1.00	25.4	.75	19.1	1.00	25.4	.28	7.1		MS3341-1-9	#6 (M3) Screw or 1/8 (3.2) Rivet	500	5000
RAMH-S10-D	M, I, S, HS, LH, H	1.00	25.4	.75	19.1	1.00	25.4	.50	12.7		—	#10 (M5) Screw or 3/16 (4.7) Rivet	500	5000

‡Cable tie cross section sizes: M = Miniature, I = Intermediate, S = Standard, HS = Heavy Standard, LH = Light-Heavy and H = Heavy.

## Lightening Hole Mounts

- Secure cable bundles that run through bulkhead lightening holes
- For indoor use only
- Protect cable bundles from sharp edges
- Material: Nylon 6.6

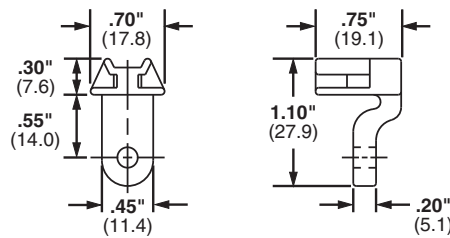

Part Number	Used with Cable Ties‡	Color	Mil. Std. Part Number	Mounting Method	Std. Pkg. Qty.	Std. Ctn. Qty.
LHMS-S5-D	M, I, S	Natural	—	#5 (M3) Screw or 1/8 (3.2) Rivet	500	2500
LHMS-S6-D			MS3340-1-9	#6 (M3) Screw or 9/64 (3.5) Rivet	500	2500
LHMS-S10-D			—	#10 (M5) Screw or 3/16 (4.7) Rivet	500	2500

‡Cable tie cross section sizes: M = Miniature, I = Intermediate, and S = Standard.

A. System Overview

## Stud Tie Mounts

B1. Cable Ties

- Easily applied to bolts or studs with a light hammer blow or turning of the mount
- Material: Impact Modified Weather Resistant Nylon 6.6
- Designed for use with cable ties to route and secure cable bundles, air, water and hydraulic lines

B2. Cable Accessories



B3. Stainless Steel Ties

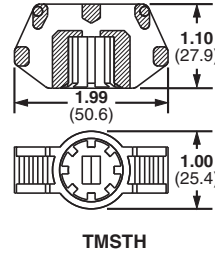
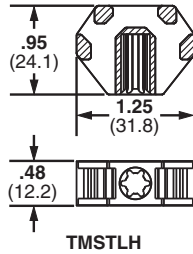

C1. Wiring Duct

C2. Surface Raceway

C3. Abrasion Protection

C4. Cable Management

Part Number	Used with Cable Ties‡	Color	Environment	Mounting Method	Std. Pkg. Qty.	Std. Ctn. Qty.
TMSTLHS6-M0	M, I, S, HS, LH	Black	Outdoors	1/4" stud dia. (6mm)	1000	5000
TMSTLHS8-M0	M, I, S, HS, LH			5/16" stud dia. (8mm)	1000	5000
TMSTHS10-D0	M, I, S, HS, LH, H			3/8" stud dia. (10mm)	500	—
TMSTHS11-D0	M, I, S, HS, LH, H			7/16" stud dia. (11mm)	500	—
TMSTHS12-D0	M, I, S, HS, LH, H			12mm stud dia.	500	—
TMSTHS13-D0	M, I, S, HS, LH, H			1/2" stud dia. (13mm)	500	—
TMSTHS16-D0	M, I, S, HS, LH, H			5/8" stud dia. (16mm)	500	—
TMSTHS19-D0	M, I, S, HS, LH, H			3/4" stud dia. (19mm)	500	—

‡Cable tie cross section sizes: M = Miniature, I = Intermediate, S = Standard, HS = Heavy-Standard, LH = Light-Heavy and H = Heavy.

D1. Terminals

## Metal Clip-On Mounts

D2. Power Connectors

- Clips on sheet metal edges for fast mounting of harness with cable ties
- For indoor use only
- Material: Zinc plated steel
- Allows cable tie entry from all four sides for easy harness orientation

D3. Grounding Connectors



E1. Labeling Systems

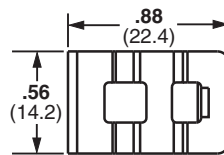

E2. Labels

E3. Pre-Printed & Write-On Markers

E4. Permanent Identification

E5. Lockout/Tagout & Safety Solutions

F. Index

Part Number	Used with Cable Ties‡	Height A		Max. Panel Thickness		Mounting Method	Std. Pkg. Qty.	Std. Ctn. Qty.
		In.	mm	In.	mm			
MCMS12-P-C	M, I, S	.31	8.0	.13	3.2	Clip-On	100	500
MCMS25-P-C		.46	11.5	.24	6.1		100	500
MCMS30-P-C		.55	14.0	.27	6.9		100	500

‡Cable Tie Cross Section Sizes: M = Miniature, I = Intermediate, and S = Standard.

## Metal Screw-On Mount

- Screw applied aluminum mounting base for a secure support in demanding applications

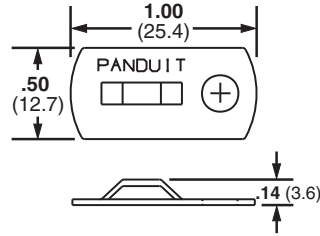
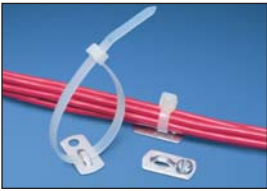

Part Number	Used with Cable Ties‡	Material	Environment	Mounting Method	Max. Static Load		Std. Pkg. Qty.	Std. Ctn. Qty.
					Lbs.	g		
MBMS-S10-CY	M, I, S	Aluminum	Indoors/Outdoors	#10 (M5) Screw	10.00	4540	100	1000

‡Cable Tie Cross Section Sizes: M = Miniature, I = Intermediate, and S = Standard.

## Push Barb Cable Tie Mounts

- Wing provides added stability
- Requires no adhesive or additional mounting hardware
- Can be used where only one side of the panel is accessible

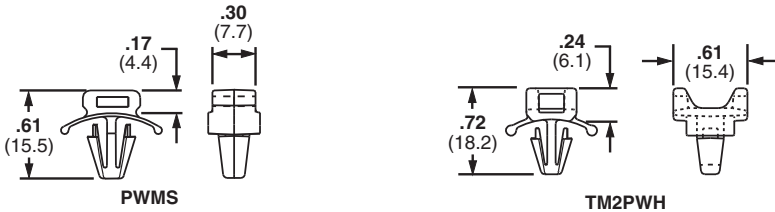

Part Number	Used with Cable Ties‡	Max. Panel Thickness		Panel Hole Diameter		Material	Color	Environment	Mounting Method	Std. Pkg. Qty.	Std. Ctn. Qty.
		In.	mm	In.	mm						
PWMS-H25-C	M, I, S	.11	2.7	.25	6.5	Nylon 6.6	Natural	Indoors	Push Barb	100	1000
PWMS-H25-M0		.11	2.7	.25	6.5	Weather Resistant Nylon 6.6	Black	Outdoors	Push Barb	1000	5000
TM2PWH25-C		.10	2.3	.25	6.5	Nylon 6.6	Natural	Indoors	Push Barb	100	500

‡Cable tie cross section Sizes: M = Miniature, I = Intermediate, and S = Standard.

A.  
System  
Overview

B1.  
Cable Ties

B2.  
Cable  
Accessories

B3.  
Stainless  
Steel Ties

C1.  
Wiring  
Duct

C2.  
Surface  
Raceway

C3.  
Abrasion  
Protection

C4.  
Cable  
Management

D1.  
Terminals

D2.  
Power  
Connectors

D3.  
Grounding  
Connectors

E1.  
Labeling  
Systems

E2.  
Labels

E3.  
Pre-Printed  
& Write-On  
Markers

E4.  
Permanent  
Identification

E5.  
Lockout/  
Tagout  
& Safety  
Solutions

F.  
Index

A. System Overview

## Push Mounts

- Require no adhesive or additional mounting hardware
- Can be used where only one side of the panel is accessible

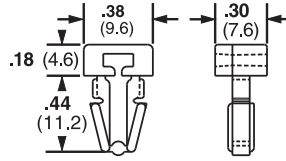

Part Number	Used with Cable Ties‡	Max. Panel Thickness		Panel Hole Diameter		Material	Color	Environment	Mounting Method	Std. Pkg. Qty.	Std. Ctn. Qty.
		In.	mm	In.	mm						
<b>PM2H25-C</b>	M, I, S	.125	3.2	.250	6.4	Nylon 6.6	Natural	Indoors	Push Barb	100	500
<b>PM2H25-M0</b>		.125	3.2	.250	6.4	Weather Resistant Nylon 6.6	Black	Outdoors		1000	5000
<b>PM2H25-M30</b>		.125	3.2	.250	6.4	Heat Stabilized Nylon 6.6	Black	Indoors		1000	5000

‡Cable tie cross section sizes: M = Miniature, I = Intermediate, and S = Standard.

C3. Abrasion Protection

## Push Button Mounts

- Require no adhesive or additional mounting hardware
- Designed for use where both sides of the panel are accessible

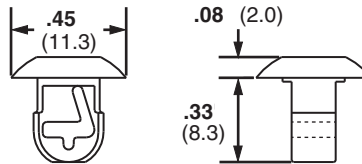

Part Number	Used with Cable Ties‡	Max. Panel Thickness		Panel Hole Diameter		Material	Color	Environment	Mounting Method	Std. Pkg. Qty.	Std. Ctn. Qty.
		In.	mm	In.	mm						
<b>PBMS-H25-C</b>	M, I, S	.13	3.2	.25	6.4	Nylon 6.6	Natural	Indoors	Push Barb	100	1000
<b>PBMS-H25-C14</b>		.13	3.2	.25	6.4	Nylon 6.6	Gray	Indoors		100	1000
<b>PBMS-H25-M0</b>		.13	3.2	.25	6.4	Weather Resistant Nylon 6.6	Black	Outdoors		1000	5000
<b>PBMS-H25-M30</b>		.13	3.2	.25	6.4	Heat Stabilized Nylon 6.6	Black	Indoors		1000	5000
<b>PBMSL-H25-C30</b>		.29	7.2	.25	6.4	Heat Stabilized Nylon 6.6	Black	Indoors		100	1000
<b>PBMSL-H25-M30</b>		.29	7.2	.25	6.4	Heat Stabilized Nylon 6.6	Black	Indoors		1000	5000

‡Cable tie cross section sizes: M = Miniature, I = Intermediate, and S = Standard.

E4. Permanent Identification

E5. Lockout/Tagout & Safety Solutions

F. Index

## Masonry Push Mounts

- Used to secure wire, cable, or tubing to masonry surfaces
- Installed quickly into pre-drilled holes; design holds bundle securely
- Material: Impact Modified Weather Resistant Nylon 6.6

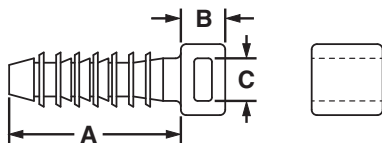

Part Number	Used with Cable Ties‡	Grip Length A		Height B		Hole Diameter C		Color	Environment	Mounting Method	Std. Pkg. Qty.	Std. Ctn. Qty.
		In.	mm	In.	mm	In.	mm					
<b>Pan-Ty® Masonry Push Mounts</b>												
MPMS19-C0	M, I, S	0.97	24.6	0.25	6.4	0.19	5.0	Black	Indoors/ Outdoors	Fir Tree Hole Mount	100	500
MPMS25-C0		0.97	24.6	0.27	6.9	0.25	6.4				100	500
MPMH38-L0	M, I, S, HS, LH, H, HLM	1.25	31.8	0.30	7.5	0.38	9.5				50	500
MPMWH32-L0	M, I, S, HS, LH, H, HLM	1.41	35.8	0.28	7.1	0.32	8.0				50	500
<b>Super-Grip® Masonry Push Mounts</b>												
SGMPMS19-C0	SGM, SGI, SGS	0.97	24.6	1.19	30.2	0.19	5.0	Black	Indoors/ Outdoors	Fir Tree Hole Mount	100	500
SGMPMS25-C0		0.97	24.6	1.24	31.5	0.25	6.4				100	500
SGMPMH38-L0		1.25	31.8	1.49	37.8	0.38	9.5				50	500
SGMPMWH32-L0	SGM, SGI, SGS, SGLH, SGH	1.41	35.8	0.28	7.1	0.32	8.0				50	500
<b>Hyper-V™ Masonry Push Mounts</b>												
HVMPM32-C0	HV	1.41	35.8	1.63	41.4	0.31	8.0	Black	Outdoors	Fir Tree Hole Mount	100	500

‡Cable Tie Cross Section Sizes: M = Miniature, I = Intermediate, S = Standard, HS = Heavy-Standard, LH = Light-Heavy, H = Heavy, HLM = Tak-Ty® Miniature, SGM = Super-Grip® Miniature, SGI = Super-Grip® Intermediate, SGS = Super-Grip® Standard, SGLH = Super-Grip® Light-Heavy, SGH = Super-Grip® Heavy, and HV = Hyper-V™.

## Wood Push Mount

- Used to secure wire, cable, or tubing to wood surfaces
- Barbed design holds mount in place – rated for 60 lb. pullout

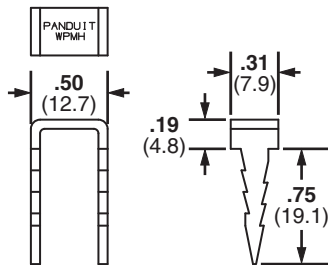

Part Number	Used with Cable Ties‡	Material	Environment	Mounting Method	Std. Pkg. Qty.
WPMH-C	M, I, S, HS, LH, H, HLM	Plated Steel	Indoors/Outdoors	Hammer into wood	100

‡Cable tie cross section sizes: M = Miniature, I = Intermediate, S = Standard, HS = Heavy Standard, LH = Light-Heavy, H = Heavy and HLM = Miniature Tak-Ty® Hook & Loop Ties.

A.  
System  
Overview

B1.  
Cable Ties

B2.  
Cable  
Accessories

B3.  
Stainless  
Steel Ties

C1.  
Wiring  
Duct

C2.  
Surface  
Raceway

C3.  
Abrasion  
Protection

C4.  
Cable  
Management

D1.  
Terminals

D2.  
Power  
Connectors

D3.  
Grounding  
Connectors

E1.  
Labeling  
Systems

E2.  
Labels

E3.  
Pre-Printed  
& Write-On  
Markers

E4.  
Permanent  
Identification

E5.  
Lockout/  
Tagout  
& Safety  
Solutions

F.  
Index

A.  
System  
Overview

## Fir Tree Push Mounts

- Unique alternating barb design
- Lock securely into position
- Umbrella tensiing
- Exclusive contoured anvil head
- Material: Heat Stabilized Nylon 6.6

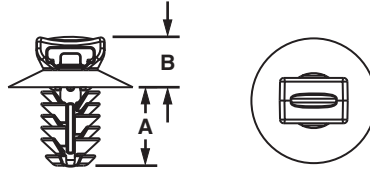

B1.  
Cable Ties

B2.  
Cable  
Accessories

B3.  
Stainless  
Steel Ties

C1.  
Wiring  
Duct

C2.  
Surface  
Raceway

C3.  
Abrasion  
Protection

C4.  
Cable  
Management

D1.  
Terminals

D2.  
Power  
Connectors

D3.  
Grounding  
Connectors

E1.  
Labeling  
Systems

E2.  
Labels

E3.  
Pre-Printed  
& Write-On  
Markers

E4.  
Permanent  
Identification

E5.  
Lockout/  
Tagout/  
& Safety  
Solutions

F.  
Index

Part Number	Used with Cable Ties‡	Head Diameter		Panel to Top of Mount		Overall Height		Panel Hole Diameter Range		Panel Thickness Range		Std. Pkg. Qty.	Std. Ctn. Qty.
		In.	mm	In.	mm	In.	mm	In.	mm	In.	mm		
<b>PUM-049-M30</b>	M, I, S	.67	17.0	.26	6.6	.54	13.8	.18 – .19	4.6 – 4.9	.03 – .19	0.7 – 3.0	1000	5000
<b>PUM-071-M30</b>	M, I, S	.67	17.0	.26	6.5	.67	16.9	.25 – .28	6.3 – 7.1	.03 – .28	0.8 – 7.0	1000	5000
<b>PUM-100-M30</b>	M, I, S	.64	16.0	.26	6.5	.67	16.9	.35 – .40	9.0 – 10.0	.03 – .28	0.8 – 7.0	1000	5000
<b>PUM-925-M30</b>	M, I, S, LH	.77	20.0	.30	7.6	1.05	26.7	.34 – .36	8.8 – 9.3	.04 – .62	1.0 – 16.0	1000	5000

‡Cable Tie Cross Section: M = Miniature, I = Intermediate, S = Standard, and LH = Light-Heavy.

## Fir Tree Push Mount Assemblies

- Cable tie/mount assemblies significantly reduce installation time compared to loose parts
- Fewer parts throughout the manufacturing/assembly process
- Heat Stabilized Nylon 6.6 standard on cable ties and mounts

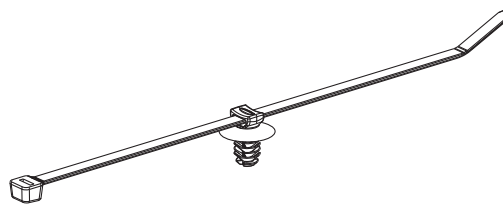
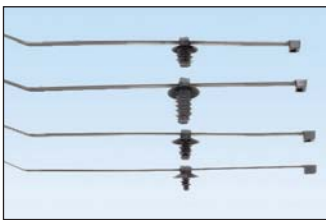

Part Number‡	Head Diameter		Panel To Top of Mount		Overall Height		Panel Hole Diameter Range		Panel Thickness Range		Max. Bundle Diameter		Std. Pkg. Qty.	Std. Ctn. Qty.
	In.	mm	In.	mm	In.	mm	In.	mm	In.	mm	In.	mm		
<b>PUM-049-2S-D30</b>	0.67	17.0	0.26	6.6	0.54	13.8	0.18 - 0.19	4.6 - 4.9	0.03 - 0.19	0.7 - 3.0	1.88	48	500	5000
<b>PUM-071-2S-D30</b>	0.67	17.0	0.26	6.6	0.67	16.9	0.25 - 0.28	6.3 - 7.1	0.03 - 0.28	0.8 - 7.0			500	5000
<b>PUM-100-2S-D30</b>	0.64	16.0	0.26	6.6	0.67	16.9	0.35 - 0.40	9.0 - 10.0	0.03 - 0.28	0.8 - 7.0			500	5000
<b>PUM-925-3H-T30</b>	0.77	20.0	0.30	7.6	1.05	26.7	0.34 – 0.36	8.8 – 9.3	0.04 – 0.62	1.0 – 16.0	3.00	76	200	1000

‡Use with PLT2S Cable Ties except PUM-925-3H-T30, use with PLT3H Cable Ties.

## Control Panel Mounts

- Installed behind control panel switch
- Ideal for high strain areas where cable is routed from panel to panel door
- Compatible with most control panel switch designs
- Indoor use only

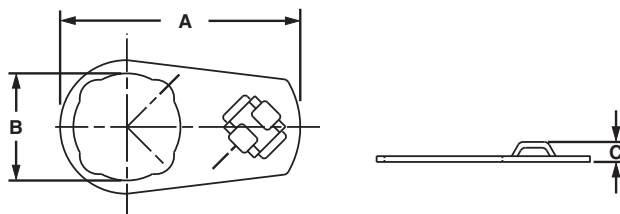

Part Number	Used with Cable Ties‡	Length A		Width B		Height C		Material	Mounting Method	Std. Pkg. Qty.	Std. Ctn. Qty.
		In.	mm	In.	mm	In.	mm				
CPM87S-C	M, I, S	2.01	51.1	.89	22.6	.17	4.3	Zinc plated steel	Control panel switch	100	1000
CPM122S-C	M, I, S	2.82	71.7	1.22	31.0	.17	4.3	Zinc plated steel	Control panel switch	100	1000

‡Cable tie cross section sizes: M = Miniature, I = Intermediate, and S = Standard.

## Pan-Post™ Standoff

- Supports cable bundles above or away from surface
- For indoor use only
- Material: Nylon 6.6

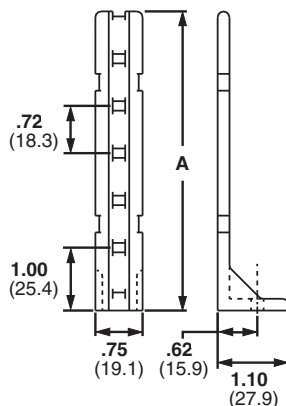

Part Number	Used with Cable Ties‡	Height A		Color	Mounting Method	Std. Pkg. Qty.	Std. Ctn. Qty.
		In.	mm				
PP1S-S10-X	M, I, S	2.00	50.8	Natural	#10 (M5) Screw	10	100
PP1S-S12-X		2.00	50.8		#12 (M5.5) Screw	10	100
PP2S-S10-X		4.60	116.8		#10 (M5) Screw	10	100
PP2S-S12-X		4.60	116.8		#12 (M5.5) Screw	10	100

‡Cable tie cross section sizes: M = Miniature, I = Intermediate, and S = Standard.

A. System Overview

## Flat Pan-Post™ Standoffs

- Standard EIA hole spacing allows product to be mounted with user supplied screws up to 1/4" diameter
- Mounting method: 1/4" (M6) screw
- Use where space is limited
- Organize cables in standard cabinets and racks
- For indoor use only



PPF2S

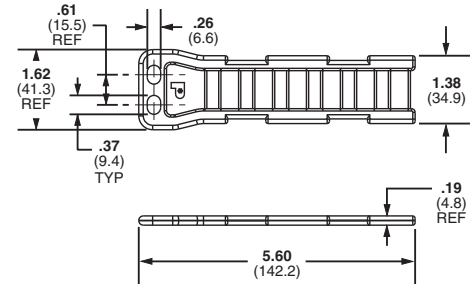

PPF2SV

B1. Cable Ties

B2. Cable Accessories

B3. Stainless Steel Ties

C1. Wiring Duct

C2. Surface Raceway

C3. Abrasion Protection

C4. Cable Management

Part Number	Used with Cable Ties‡	Material	Color	Mounting Method	Std. Pkg. Qty.	Std. Ctn. Qty.
PPF2S-S25-V	M, I, S	Nylon 6.6	Natural	Two 1/4" (M6) screws	5	100
PPF2S-S25-V69		Flame Retardant Nylon 6.6				
PPF2SV-S25-V	M, I, S, HS, LH, H, HLM, HLS	Nylon 6.6				
PPF2SV-S25-V69		Flame Retardant Nylon 6.6				

‡Cable Tie Cross Section Sizes: M = Miniature, I = Intermediate, S = Standard, HS = Heavy-Standard, LH = Light-Heavy, H = Heavy, HLM = Miniature Tak-Ty® Hook & Loop Ties and HLS = Standard Tak-Ty® Hook & Loop Ties .

D1. Terminals

## Right Angle Bases

- Support cable above the mounting surface

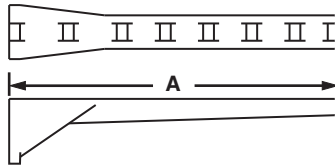

D2. Power Connectors

D3. Grounding Connectors

E1. Labeling Systems

E2. Labels

E3. Pre-Printed & Write-On Markers

E4. Permanent Identification

E5. Lockout/Tagout & Safety Solutions

F. Index

Part Number	Used with Cable Ties‡	Max. Flat Cable Width		Length A		Material	Color	Environment	Mounting Method	Std. Pkg. Qty.	Std. Ctn. Qty.
		In.	mm	In.	mm						
RAFCBI1-S6-C20	I	1.00	25.4	1.75	44.4	Nylon 6.6	Black	Indoors	#6 (M3) Screw	100	1000
RAFCBI2-S6-C20	I	2.00	50.8	2.78	70.6						
RAFCBI3-S6-C20	I	3.00	76.2	3.81	96.8						

‡Cable tie cross section sizes: I = Intermediate.



## Flat Cable Mounting System – FCB Base and FCPI Plate

- Secures stacked cables, folds, and breakouts, as well as laminated and molded bus bars
- Use one base, one corresponding size plate (FCPI), and one Intermediate cross section cable tie
- For indoor use only
- See also Latching Flat Cable Mounts on page B2.38
- Material: Nylon 6.6

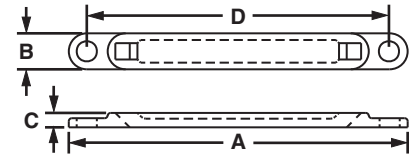
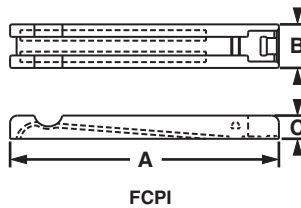

Part Number	Max. Flat Cable Width		Length A		Width B		Height C		Hole Spacing D		Color	Mounting Method	Std. Pkg. Qty.	Std. Ctn. Qty.
	In.	mm	In.	mm	In.	mm	In.	mm	In.	mm				
FCBI1-A-C20	1.04	26.4	2.50	63.5	.38	9.5	.15	3.8	—	—	Black	User Supplied Adhesive	100	1000
FCBI2-A-C20	2.04	51.8	3.50	88.9	.38	9.5	.15	3.8	—	—		User Supplied Adhesive	100	1000
FCBI3-A-C20	3.32	7.72	4.52	114.8	.38	9.5	.15	3.8	—	—		User Supplied Adhesive	100	1000
FCBI1-S10-C20	1.04	26.4	2.50	63.5	.38	9.5	.15	3.8	2.08	52.8		#10 (M5) Screw	100	1000
FCBI2-S10-C20	2.04	51.8	3.50	88.9	.38	9.5	.15	3.8	3.10	78.7		#10 (M5) Screw	100	1000
FCBI3-S10-C20	3.32	77.2	4.52	114.8	.38	9.5	.15	3.8	4.12	104.6		#10 (M5) Screw	100	1000
FCPI1-C20*	1.04	26.4	1.29	32.8	.38	9.5	.20	5.1	—	—		Cable Ties	100	1000
FCPI2-C20*	2.04	51.8	2.31	58.7	.38	9.5	.20	5.1	—	—		Cable Ties	100	1000
FCPI3-C20*	3.32	77.2	3.32	84.3	.38	9.5	.20	5.1	—	—		Cable Ties	100	1000

\*Recommend for use with PLT2I cable ties on page B1.8.

- A. System Overview
- B1. Cable Ties
- B2. Cable Accessories
- B3. Stainless Steel Ties
- C1. Wiring Duct
- C2. Surface Raceway
- C3. Abrasion Protection
- C4. Cable Management
- D1. Terminals
- D2. Power Connectors
- D3. Grounding Connectors
- E1. Labeling Systems
- E2. Labels
- E3. Pre-Printed & Write-On Markers
- E4. Permanent Identification
- E5. Lockout/Tagout & Safety Solutions
- F. Index

A. System Overview

## Closed Connector Rings

- Connect multiple cable bundles

B1. Cable Ties

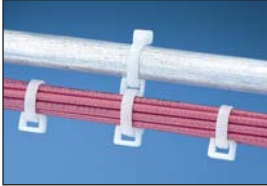

B2. Cable Accessories

B3. Stainless Steel Ties

Part Number	Used with Cable Ties‡	Length A		Width B		Height C		Material	Color	Environment	Mounting Method	Std. Pkg. Qty.	Std. Ctn. Qty.
		In.	mm	In.	mm	In.	mm						
<b>CR2-M</b>	M, I, S	0.33	8.4	0.20	5.1	0.20	5.0	Nylon 6.6	Natural	Indoors	Cable Ties	1000	10000
<b>CR4H-M</b>	M, I, S, HS, LH	0.57	14.5	0.36	9.1	0.30	7.6			Indoors			
<b>CR4H-M0</b>	M, I, S, HS, LH	0.57	14.5	0.36	9.1	0.30	7.6	Weather Resistant Nylon 6.6	Indoors/Outdoors				

‡Cable tie cross section sizes: M = Miniature, I = Intermediate, S = Standard, HS = Heavy-Standard and LH = Light-Heavy.

C1. Wiring Duct

C2. Surface Raceway

## Open Connector Ring

- Designed to add on cable bundles without removing cable ties

C3. Abrasion Protection

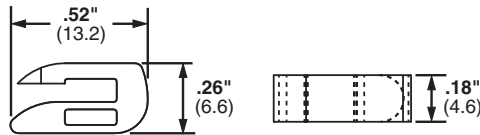

C4. Cable Management

D1. Terminals

Part Number	Used With Cable Ties‡	Material	Color	Environment	Mounting Method	Std. Pkg. Qty.	Std. Ctn. Qty.
<b>CROS-M</b>	M, I, S	Nylon 6.6	Natural	Indoors	Cable Ties	1000	5000

‡Cable tie cross section sizes: M = Miniature, I = Intermediate, and S = Standard.

D2. Power Connectors

D3. Grounding Connectors

E1. Labeling Systems

## Cable Spacers

- Used to separate and/or hang cords, cables, and tubing

E2. Labels

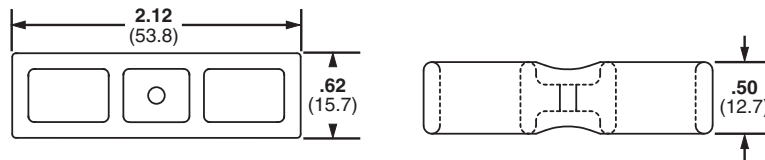

E3. Pre-Printed & Write-On Markers

E4. Permanent Identification

Part Number	Used with Cable Ties‡	Material	Color	Environment	Mounting Method	Std. Pkg. Qty.	Std. Ctn. Qty.
<b>CSH-D20</b>	M, I, S, HS, LH, H	Nylon 6.6	Black	Indoors	Cable Ties	500	2500
<b>CSH-D0</b>	M, I, S, HS, LH, H	Weather Resistant Nylon 6.6	Black	Indoors/Outdoors	Cable Ties	500	2500

‡Cable tie cross section sizes: M = Miniature, I = Intermediate, S = Standard, HS = Heavy-Standard, LH = Light-Heavy and H = Heavy.

E5. Lockout/Tagout & Safety Solutions

F. Index

## Cable Spacer Cross

- Connects two bundles at 90°
- Separates bundles to prevent abrasion

- Dual cradle design stabilizes cable bundle

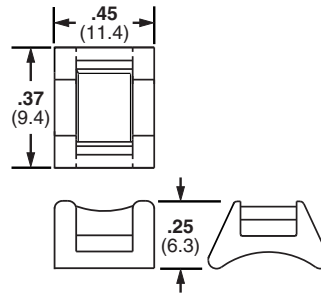

Part Number	Used with Cable Ties‡	Material	Color	Environment	Mounting Method	Std. Pkg. Qty.	Std. Ctn. Qty.
CSCS-M	M, I, S	Nylon 6.6	Natural	Indoors	Cable Ties	1000	10000

‡Cable tie cross section sizes: M = Miniature, I = Intermediate, and S = Standard.

## Stackable Aerial Cable Spacer

- Greater resistance to damage caused by ultraviolet light – indoor or outdoor use
- Each spacer snaps into another to increase spacer heights by 1/2" increments

- Designed for use in parallel or perpendicular applications
- For use with Dura-Ty™ Cable Ties shown on page B1.53 or Pan-Steel® Self-Locking Ties on page B3.5, B3.6, B3.7.

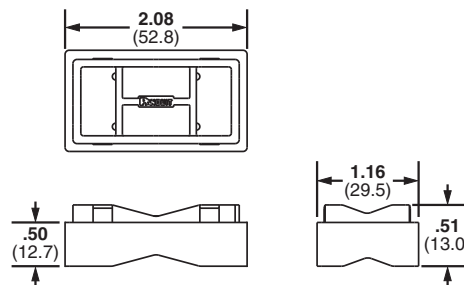

Part Number	Used with Cable Ties‡	Material	Color	Environment	Mounting Method	Std. Pkg. Qty.	Std. Ctn. Qty.
SACS50-T100	LH, H, EH	Weather Resistant Polypropylene	Black	Outdoors	Cable Ties	200	2000

\*Cable tie cross sizes: LH = Light-Heavy, H = Heavy, and EH = Extra-Heavy.

A.  
System  
Overview

B1.  
Cable Ties

B2.  
Cable  
Accessories

B3.  
Stainless  
Steel Ties

C1.  
Wiring  
Duct

C2.  
Surface  
Raceway

C3.  
Abrasion  
Protection

C4.  
Cable  
Management

D1.  
Terminals

D2.  
Power  
Connectors

D3.  
Grounding  
Connectors

E1.  
Labeling  
Systems

E2.  
Labels

E3.  
Pre-Printed  
& Write-On  
Markers

E4.  
Permanent  
Identification

E5.  
Lockout/  
Tagout  
& Safety  
Solutions

F.  
Index

A. System Overview

B1. Cable Ties

B2. Cable Accessories

B3. Stainless Steel Ties

C1. Wiring Duct

C2. Surface Raceway

C3. Abrasion Protection

C4. Cable Management

D1. Terminals

D2. Power Connectors

D3. Grounding Connectors

E1. Labeling Systems

E2. Labels

E3. Pre-Printed & Write-On Markers

E4. Permanent Identification

E5. Lockout/Tagout & Safety Solutions

F. Index

## Aerial Support Ties – Weather Resistant Polypropylene

- Designed to attach coax or telephone cable to the 1/4" (6.4mm) or 5/16" (7.9mm) support strand to form the expansion loop and keep equipment and cables clear of pole hardware
- One-piece construction with integral 1/2" (12.7mm) spacer reduces inventory costs of separate spacer and bands, and installs faster to lower installed cost
- Releasable and re-usable
- Hand install only

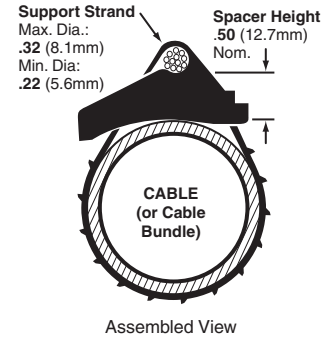
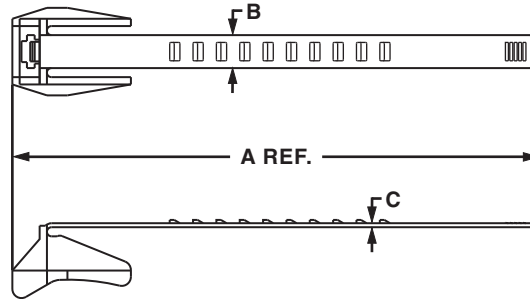

Part Number	Length A		Width B		Thickness C		Max. Bundle Diameter		Min. Loop Tensile Strength		Std. Pkg. Qty.	Std. Ctn. Qty.
	In.	mm	In.	mm	In.	mm	In.	mm	Lbs.	N		
<b>AST10-5-C100</b>	5.6	142	.448	11.4	.055	1.4	1.00	25	75	334	100	1000
<b>AST15-5-C100</b>	6.9	175	.448	11.4	.055	1.4	1.50	38	75	334	100	1000
<b>AST20-5-C100</b>	8.4	214	.448	11.4	.055	1.4	2.00	51	75	334	100	1000
<b>AST25-5-C100</b>	10.0	254	.448	11.4	.055	1.4	2.50	64	75	334	100	1000

## Permanent Marking Pens

- Fast drying, permanent ink for identification on marker ties (pages B1.34, B1.52, and B1.71), marker plates (page B2.29), or cable marker straps (page B1.80)
- May be used with any label shown in the catalog when a printer is not available



Part Number	Color	Description	Std. Pkg. Qty.	Std. Ctn. Qty.
<b>PX-0</b>	Black	Permanent marking pen – regular tip.	12	144
<b>PX-2</b>	Red	Permanent marking pen – regular tip.	12	144
<b>PFX-0</b>	Black	Permanent marking pen – fine tip.	12	144
<b>PFX-2</b>	Red	Permanent marking pen – fine tip.	12	144
<b>PX-10</b>	White	Marking pen for black or other dark colored parts – regular tip.	12	300

## Marker Plates – Loose Piece

- Install as flags, tags, or wrap-around identification plates to clearly identify all wire harnesses
- Use with nylon marking pens for an easy and economic alternative to identify wire harnesses
- Available in black or white to match the wire harness
- Thickness: .02 inches (0.5mm)

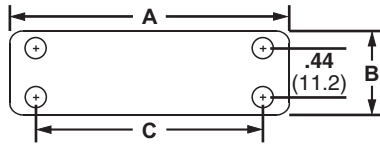

Part Number	Used with Cable Ties‡	Length A		Width B		Hole Spacing C		Material	Color	Environment	Mounting Method	Std. Pkg. Qty.	Std. Ctn. Qty.
		In.	mm	In.	mm	In.	mm						
<b>Loose Piece</b>													
MP150-C	M, I, S	1.50	38.1	.75	19.0	1.03	26.2	Nylon 6.6	White	Indoors	Cable Ties	100	500
MP175-C	M, I, S	1.75	44.4	.75	19.0	1.28	32.5					100	500
MP200-C	M, I, S	2.00	50.8	.75	19.0	1.53	38.9					100	500
MP250-C	M, I, S	2.50	63.5	.75	19.0	2.03	51.6					100	500
MP350-C	M, I, S	3.50	88.9	.75	19.0	3.03	77.7					100	1000
MP250W175-C	M, I, S	2.50	63.5	1.75	44.5	2.03	51.6					100	1000
MP150-C0	M, I, S	1.50	38.1	.75	19.0	1.03	26.2	Weather Resistant Nylon 6.6	Black	Indoors/Outdoors	Cable Ties	100	500
MP175-C0	M, I, S	1.75	44.4	.75	19.0	1.28	32.5					100	500
MP200-C0	M, I, S	2.00	50.8	.75	19.0	1.53	38.9					100	500
MP250-C0	M, I, S	2.50	63.5	.75	19.0	2.03	51.6					100	500
MP350-C0	M, I, S	3.50	88.9	.75	19.0	3.03	77.7					100	1000
<b>Marker Plates on Rolls</b>													
MP150-R	M, I, S	1.50	38.1	.75	19.0	1.03	26.2	Nylon 6.6	White	Indoors	Cable Ties	1000	5000
MP175-R	M, I, S	1.75	44.4	.75	19.0	1.28	32.5					1000	5000
MP200-R	M, I, S	2.00	50.8	.75	19.0	1.53	38.9					1000	5000
MP250-R	M, I, S	2.50	63.5	.75	19.0	2.03	51.6					1000	5000

‡Cable tie cross section sizes: M = Miniature, I = Intermediate, and S = Standard.

A. System Overview

## Cable and Wire Mounting Devices (Used without Cable Ties)

B1. Cable Ties

B2. Cable Accessories

B3. Stainless Steel Ties



Wiring accessories are an integral part of the Panduit comprehensive selection of wire management products.

These accessories are one piece solutions that help provide the lowest installed cost for controlling, mounting, and protecting wire and cable. Mounting methods include:

- Adhesive-backed
- Screw applied
- Rivet applied
- Push mounts

C1. Wiring Duct

C2. Surface Raceway

C3. Abrasion Protection

## Adhesive Backed Mounting Devices

### Faster Liner Removal Speeds Installation and Lowers Installed Cost

- The adhesive backed mounts are offered either as one or two mounts per liner
- The 2-up mounts are easily removed by bending the mounts away from the liner
- The individual mounts have a convenient tear tab for quick removal

C4. Cable Management

D1. Terminals

D2. Power Connectors

D3. Grounding Connectors

## Clincher™ Adjustable Releasable Clamp

- Adjustable clamp designed to contain a range of cable bundle diameters
- Latch can be released to provide access to cable bundles
- For indoor use only
- Material: Polypropylene



E1. Labeling Systems

E2. Labels

E3. Pre-Printed & Write-On Markers

E4. Permanent Identification

E5. Lockout/Tagout & Safety Solutions

F. Index

Part Number	Bundle Diameter Range		Color	Mounting Method	Std. Pkg. Qty.	Std. Ctn. Qty.
	In.	mm				
<b>ARC.68-A-Q</b>	0.19 – 0.68	4.8 – 17.3	White	Rubber Adhesive Tape	25	250
<b>ARC.68-A-Q14</b>	0.19 – 0.68	4.8 – 17.3	Gray	Rubber Adhesive Tape	25	250
<b>ARC.68-S6-Q</b>	0.19 – 0.69	4.8 – 17.5	White	#6 (M3) Screw	25	250
<b>ARC.68-S6-Q14</b>	0.19 – 0.69	4.8 – 17.5	Gray	#6 (M3) Screw	25	250

## Adhesive Backed Cord Clips

- Cables are easily snapped into or out of the clips



Part Number	Max. Bundle Diameter		Length A		Width B		Height C		Material	Color	Adhesive Type	Std. Pkg. Qty.	Std. Ctn. Qty.
	In.	mm	In.	mm	In.	mm	In.	mm					
ACC19-A-C	0.19	4.8	0.75	19.0	0.62	15.7	0.25	6.4	Nylon 6.6	Natural	Rubber	100	500
ACC19-AT-C	0.19	4.8	0.75	19.0	0.62	15.7	0.25	6.4		Natural	Acrylic	100	500
ACC19-A-C20	0.19	4.8	0.75	19.0	0.62	15.7	0.25	6.4		Black	Rubber	100	500
ACC19-AT-C0	0.19	4.8	0.75	19.0	0.62	15.7	0.25	6.4		Weather Resistant Nylon 6.6	Black	Acrylic	100
<b>NEW!</b> ACC19-AV-M300	0.19	4.8	0.75	19.0	0.62	15.7	0.38	6.4	Heat Stabilized Weather Resistant Nylon 6.6	Black	High Bond Acrylic	1000	5000
ACC38-A-C	0.38	9.7	1.00	25.4	1.00	25.4	0.38	9.7	Nylon 6.6	Natural	Rubber	100	500
ACC38-AT-C	0.38	9.7	1.00	25.4	1.00	25.4	0.38	9.7		Natural	Acrylic	100	500
ACC38-A-C20	0.38	9.7	1.00	25.4	1.00	25.4	0.38	9.7		Black	Rubber	100	500
ACC38-AT-C0	0.38	9.7	1.00	25.4	1.00	25.4	0.38	9.7	Weather Resistant Nylon 6.6	Black	Acrylic	100	500
<b>NEW!</b> ACC38-AV-M300	0.38	9.7	1.00	25.4	1.00	25.4	0.40	10.2	Heat Stabilized Weather Resistant Nylon 6.6	Black	High Bond Acrylic	1000	5000
ACC62-A-C	0.62	15.7	1.24	31.5	1.12	28.4	0.63	16.0	Nylon 6.6	Natural	Rubber	100	500
ACC62-AT-C	0.62	15.7	1.24	31.5	1.12	28.4	0.63	16.0		Natural	Acrylic	100	500
ACC62-A-C20	0.62	15.7	1.24	31.5	1.12	28.4	0.63	16.0		Black	Rubber	100	500
ACC62-AT-C0	0.62	15.7	1.24	31.5	1.12	28.4	0.63	16.0	Weather Resistant Nylon 6.6	Black	Acrylic	100	500
<b>NEW!</b> ACC62-AV-D300	0.62	15.7	1.24	31.5	1.12	28.4	0.63	16.0	Heat Stabilized Weather Resistant Nylon 6.6	Black	High Bond Acrylic	500	5000

## Push Mount Cord Clip

- Cables are easily snapped into or out of clips
- Winged design holds mount in place even in applications where vibration is present
- Design of wing provides added stability

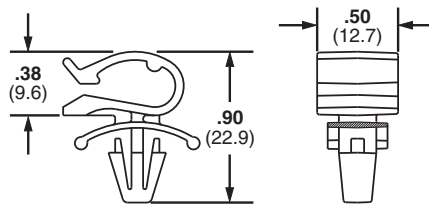

Part Number	Max. Bundle Diameter		Max. Panel Thickness		Panel Hole Diameter		Material	Color	Environment	Mounting Method	Std. Pkg. Qty.	Std. Ctn. Qty.
	In.	mm	In.	mm	In.	mm						
PMCC38H25-C	.38	9.6	.105	2.7	.250	6.4	Nylon 6.6	Natural	Indoors	Push Barb	100	1000
PMCC38H25-M0	.38	9.6	.105	2.7	.250	6.4	Weather Resistant Nylon 6.6	Black	Outdoors	Push Barb	1000	5000

A. System Overview

## "J" Clips

- Low profile clips retain cords, cables, or tubing
- Flexible design allows for easy cord insertion, yet holds bundle tightly
- For indoor use only
- Material: PVC

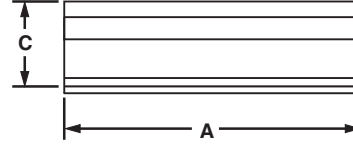
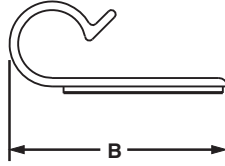

B1. Cable Ties

B2. Cable Accessories

B3. Stainless Steel Ties

C1. Wiring Duct

C2. Surface Raceway

C3. Abrasion Protection

C4. Cable Management

Part Number	Max. Bundle Diameter		Length A		Width B		Height C		Diameter		Color	Adhesive Type	Std. Pkg. Qty.	Std. Ctn. Qty.
	In.	mm	In.	mm	In.	mm	In.	mm	In.	mm				
AJC12-A-C	0.12	3.0	1.00	25.4	0.86	21.8	0.19	4.8	0.13	3.3	Light Gray	Rubber Adhesive Tape	100	1000
AJC19-A-C	0.19	4.8	1.25	31.8	0.87	22.1	0.26	6.6	0.18	4.6			100	1000
AJC25-A-C	0.25	6.4	1.50	38.1	0.97	24.6	0.31	7.9	0.23	5.8			100	1000
AJC31-A-C	0.31	7.9	1.75	44.5	1.22	30.1	0.40	10.2	0.29	7.4			100	1000
AJC38-A-C	0.38	9.6	2.00	50.8	1.27	32.3	0.50	12.7	0.39	9.9			100	1000

## A1C Type Clips

- Hold cords, cables, and tubing
- Single rubber adhesive pad for confined areas
- For indoor use only
- Material: PVC

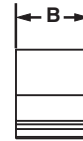
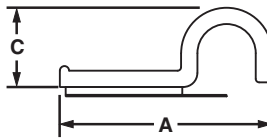

D1. Terminals

D2. Power Connectors

D3. Grounding Connectors

E1. Labeling Systems

E2. Labels

E3. Pre-Printed & Write-On Markers

E4. Permanent Identification

E5. Lockout/Tagout & Safety Solutions

F. Index

Part Number	Max. Bundle Diameter		Length A		Width B		Height C		Color	Adhesive Type	Std. Pkg. Qty.	Std. Ctn. Qty.
	In.	mm	In.	mm	In.	mm	In.	mm				
A1C12-A-C8	0.12	3.0	0.77	19.6	0.63	16.0	0.23	5.8	Light Gray	Rubber	100	1000
A1C25-A-C8	0.25	6.4	0.91	23.1	0.63	16.0	0.38	9.7			100	1000
A1C38-A-C8	0.38	9.5	1.04	26.4	0.63	16.0	0.51	13.0			100	1000
A1C50-A-C8	0.50	12.7	1.17	29.7	0.63	16.0	0.64	16.3			100	1000



## A2C Type Clips

- Hold cords, cables, and tubing
- Two rubber adhesive pads for added strength

- For indoor use only
- Material: PVC

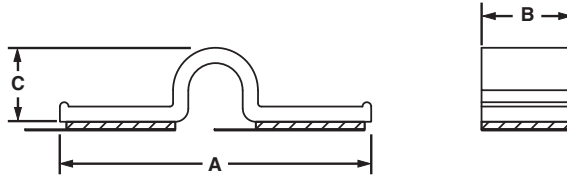

Part Number	Max. Bundle Diameter		Length A		Width B		Height C		Color	Adhesive Type	Std. Pkg. Qty.	Std. Ctn. Qty.
	In.	mm	In.	mm	In.	mm	In.	mm				
A2C12-A-C8	0.12	3.0	1.30	33.0	0.63	16.0	0.23	5.8	Light Gray	Rubber	100	1000
A2C25-A-C8	0.25	6.4	1.43	36.3	0.63	16.0	0.36	9.1			100	1000
A2C38-A-C8	0.38	9.5	1.56	39.6	0.63	16.0	0.49	12.4			100	1000
A2C50-A-C8	0.50	12.7	1.72	43.7	0.63	16.0	0.61	15.5			100	1000

## Metal Adhesive Backed Cord Clips

- Can be opened and closed without damaging clip in order to remove or add cables quickly and easily

- For indoor use only

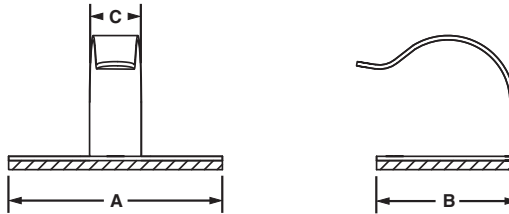

Part Number	Max. Bundle Diameter		Length A		Width B		Clip Width C		Material	Adhesive Type	Std. Pkg. Qty.	Std. Ctn. Qty.
	In.	mm	In.	mm	In.	mm	In.	mm				
MACC25-A-C	0.25	6.4	0.77	19.6	0.54	13.7	0.29	7.4	Zinc Plated Steel	Rubber	100	1000
MACC62-A-C	0.62	15.7	1.18	30.0	0.78	19.7	0.29	7.4			100	1000
MACC25-AV-D	0.25	6.4	0.77	19.6	0.54	13.7	0.29	7.4		High Bond Acrylic	500	1000
MACC62-AV-C	0.62	15.7	1.18	30.0	0.78	19.7	0.29	7.4			100	1000



A. System Overview

B1. Cable Ties

B2. Cable Accessories

B3. Stainless Steel Ties

C1. Wiring Duct

C2. Surface Raceway

C3. Abrasion Protection

C4. Cable Management

D1. Terminals

D2. Power Connectors

D3. Grounding Connectors

E1. Labeling Systems

E2. Labels

E3. Pre-Printed & Write-On Markers

E4. Permanent Identification

E5. Lockout/Tagout & Safety Solutions

F. Index

A. System Overview

## Latching Wire Clips

- Route and secure cords and cables
- Convenient releasable latch
- Available in six sizes with releasable latch

- Push barb parts are for use with a max panel thickness of 0.11" (2.7mm) and a hole diameter of .22" (5.6mm)
- For indoor use only
- Material: Nylon 6.6

B1. Cable Ties

B2. Cable Accessories

B3. Stainless Steel Ties

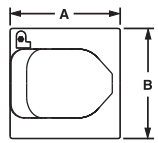
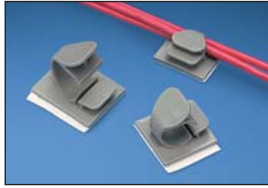

LWC\*\*-A

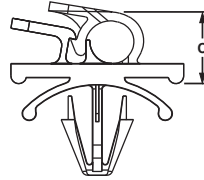

LWC\*\*-H25

C1. Wiring Duct

C2. Surface Raceway

C3. Abrasion Protection

C4. Cable Management

D1. Terminals

D2. Power Connectors

D3. Grounding Connectors

E1. Labeling Systems

E2. Labels

E3. Pre-Printed & Write-On Markers

E4. Permanent Identification

E5. Lockout/Tagout & Safety Solutions

F. Index

Part Number	Max. Bundle Diameter		Length A		Width B		Height C		Color	Mounting Method	Std. Pkg. Qty.	Std. Ctn. Qty.	
	In.	mm	In.	mm	In.	mm	In.	mm					
<b>Adhesive Backed</b>													
LWC19-A-C	0.19	4.8	0.85	21.6	0.61	15.5	0.39	9.9	Natural	Rubber Adhesive	100	1000	
LWC19-A-C14	0.19	4.8	0.85	21.6	0.61	15.5	0.39	9.9	Gray		100	1000	
LWC19-A-C20	0.19	4.8	0.85	21.6	0.61	15.5	0.39	9.9	Black		100	1000	
LWC25-A-C	0.25	6.4	0.88	22.2	1.00	25.4	0.45	11.4	Natural		100	1000	
LWC25-A-C14	0.25	6.4	0.88	22.2	1.00	25.4	0.45	11.4	Gray		100	1000	
LWC25-A-C20	0.25	6.4	0.88	22.2	1.00	25.4	0.45	11.4	Black		100	1000	
LWC38-A-C	0.38	9.5	1.00	25.4	1.00	25.4	0.56	14.2	Natural		100	1000	
LWC38-A-C14	0.38	9.5	1.00	25.4	1.00	25.4	0.56	14.2	Gray		100	1000	
LWC38-A-C20	0.38	9.5	1.00	25.4	1.00	25.4	0.56	14.2	Black		100	1000	
LWC50-A-L	0.50	12.7	1.26	32.0	1.00	25.4	0.67	17.0	Natural		50	500	
LWC50-A-L14	0.50	12.7	1.26	32.0	1.00	25.4	0.67	17.0	Gray		50	500	
LWC50-A-L20	0.50	12.7	1.26	32.0	1.00	25.4	0.67	17.0	Black		50	500	
LWC75-A-L	0.75	19.1	1.48	37.6	1.24	31.5	0.90	22.9	Natural		50	500	
LWC75-A-L14	0.75	19.1	1.48	37.6	1.24	31.5	0.90	22.9	Gray		50	500	
LWC75-A-L20	0.75	19.1	1.48	37.6	1.24	31.5	0.90	22.9	Black		50	500	
LWC100-A-L	1.00	25.4	2.21	56.1	1.97	50.0	1.26	32.0	Natural		50	500	
LWC100-A-L14	1.00	25.4	2.21	56.1	1.97	50.0	1.26	32.0	Gray		50	500	
LWC100-A-L20	1.00	25.4	2.21	56.1	1.97	50.0	1.26	32.0	Black		50	500	
<b>Push Mount</b>													
LWC19-H25-C	0.19	4.8	0.85	21.6	0.51	12.8	0.41	10.4	Natural		Push Barb	100	1000
LWC19-H25-C14	0.19	4.8	0.85	21.6	0.51	12.8	0.41	10.4	Gray	100		1000	
LWC25-H25-C	0.25	6.4	0.86	21.8	0.58	14.7	0.47	11.9	Natural	100		1000	
LWC25-H25-C14	0.25	6.4	0.86	21.8	0.58	14.7	0.47	11.9	Gray	100		1000	
LWC25-H25-C20	0.25	6.4	0.86	21.8	0.58	14.7	0.47	11.9	Black	100		1000	
LWC38-H25-C	0.38	9.5	0.94	23.9	0.58	14.7	0.57	14.5	Natural	100		1000	
LWC38-H25-C14	0.38	9.5	0.94	23.9	0.58	14.7	0.57	14.5	Gray	100		1000	
LWC38-H25-C20	0.38	9.5	0.94	23.9	0.58	14.7	0.57	14.5	Black	100		1000	
LWC50-H25-L	0.50	12.7	1.25	31.8	0.76	19.3	0.78	19.8	Natural	50		500	
LWC50-H25-L14	0.50	12.7	1.25	31.8	0.76	19.3	0.78	19.8	Gray	50		500	
LWC50-H25-L20	0.50	12.7	1.25	31.8	0.76	19.3	0.78	19.8	Black	50		500	
LWC75-H25-L	0.75	19.1	1.45	36.8	0.87	22.1	0.97	24.7	Natural	50		500	
LWC75-H25-L14	0.75	19.1	1.45	36.8	0.87	22.1	0.97	24.7	Gray	50		500	
LWC75-H25-L20	0.75	19.1	1.45	36.8	0.87	22.1	0.97	24.7	Black	50		500	
LWC100-H25-L	1.00	25.4	1.89	47.9	0.99	25.2	1.30	33.0	Natural	50		500	
LWC100-H25-L14	1.00	25.4	1.89	47.9	0.99	25.2	1.30	33.0	Gray	50		500	
LWC100-H25-L20	1.00	25.4	1.89	47.9	0.99	25.2	1.30	33.0	Black	50		500	

## Bevel Entry Clips

- Beveled entry allows for easy insertion of cable bundle



BEC

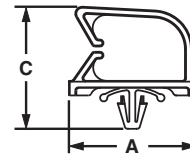

BECP

Part Number	Max. Bundle Diameter		Length A		Width B		Height C		Material	Color	Environment	Mounting Method	Std. Pkg. Qty.	Std. Ctn. Qty.
	In.	mm	In.	mm	In.	mm	In.	mm						
<b>Adhesive Backed</b>														
BEC38-A-L	0.38	9.6	1.46	37.1	1.24	31.5	0.52	13.2	Nylon 6.6	Natural	Indoors	Rubber Adhesive	50	500
BEC38-A-L20	0.38	9.6	1.46	37.1	1.24	31.5	0.52	13.2		Black		Rubber Adhesive	50	500
BEC38-AT-L0	0.38	9.6	1.46	37.1	1.24	31.5	0.52	13.2	Weather Resistant Nylon 6.6	Black	Outdoors	Acrylic Adhesive	50	500
BEC62-A-L	0.62	15.7	1.46	37.1	1.24	31.5	0.79	20.1	Nylon 6.6	Natural	Indoors	Rubber Adhesive	50	500
BEC62-A-L20	0.62	15.7	1.46	37.1	1.24	31.5	0.79	20.1		Black		Rubber Adhesive	50	500
BEC62-AT-L0	0.62	15.7	1.46	37.1	1.24	31.5	0.79	20.1	Weather Resistant Nylon 6.6	Black	Outdoors	Acrylic Adhesive	50	500
BEC75-A-L	0.75	19.0	1.46	37.1	1.49	37.8	0.89	22.6	Nylon 6.6	Natural	Indoors	Rubber Adhesive	50	500
BEC75-A-L20	0.75	19.0	1.46	37.1	1.49	37.8	0.89	22.6		Black		Rubber Adhesive	50	500
BEC75-AT-L0	0.75	19.0	1.46	37.1	1.49	37.8	0.89	22.6	Weather Resistant Nylon 6.6	Black	Outdoors	Acrylic Adhesive	50	500
<b>Push Barb</b>														
BECP38H25-L	0.38	9.6	1.46	37.1	0.73	18.5	1.00	25.4	Nylon 6.6	Natural	Indoors	Push Barb	50	500
BECP38H25-L20	0.38	9.6	1.46	37.1	0.73	18.5	1.00	25.4		Black			50	500
BECP75H25-L	0.75	19.0	1.47	37.3	0.73	18.5	1.35	34.3		Natural			50	500
BECP75H25-L20	0.75	19.0	1.47	37.3	0.73	18.5	1.35	34.3		Black			50	500

\*For proper selection of adhesive see page B2.54.

A.  
System  
Overview

B1.  
Cable Ties

B2.  
Cable  
Accessories

B3.  
Stainless  
Steel Ties

C1.  
Wiring  
Duct

C2.  
Surface  
Raceway

C3.  
Abrasion  
Protection

C4.  
Cable  
Management

D1.  
Terminals

D2.  
Power  
Connectors

D3.  
Grounding  
Connectors

E1.  
Labeling  
Systems

E2.  
Labels

E3.  
Pre-Printed  
& Write-On  
Markers

E4.  
Permanent  
Identification

E5.  
Lockout/  
Tagout  
& Safety  
Solutions

F.  
Index

A. System Overview

## Adhesive Backed Dual Cord Clip

- Holds two cables in high temperature applications

B1. Cable Ties

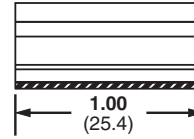
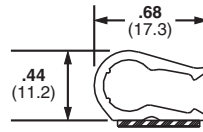

B2. Cable Accessories

B3. Stainless Steel Ties

Part Number	Max. Bundle Diameter		Material	Color	Environment	Adhesive Type	Std. Pkg. Qty.	Std. Ctn. Qty.
	In.	mm						
<b>ADCC31-AT-C10</b>	0.33	9.0	NORYL*	White	Indoors	Acrylic	100	500

\*NORYL Thermoplastic Resin is a registered trademark of General Electric Company.

C1. Wiring Duct

C2. Surface Raceway

## Adhesive Backed Mount Cord Clip

- Holds a single cable
- Funnel entry speeds cable insertion
- Vertical cable entry for ease of installation

C3. Abrasion Protection

C4. Cable Management

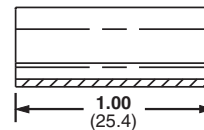
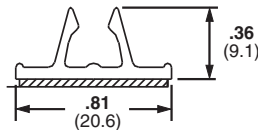

D1. Terminals

D2. Power Connectors

Part Number	Max. Bundle Diameter		Material	Color	Environment	Adhesive Type	Std. Pkg. Qty.	Std. Ctn. Qty.
	In.	mm						
<b>AMC25-AT-C10</b>	.22 – .28	6.0 – 7.0	PVC	White	Indoors	Acrylic	100	1000

D3. Grounding Connectors

E1. Labeling Systems

## Vertical Cord Clips

- Funnel entry design allows for easy insertion of cords and cables
- For indoor use only
- Vertical cable entry for ease of installation

E2. Labels

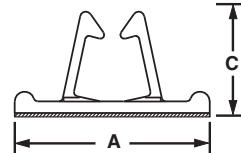
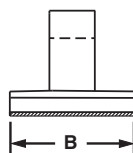
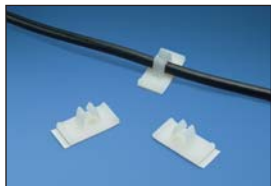

E3. Pre-Printed & Write-On Markers

E4. Permanent Identification

Part Number	Max. Bundle Diameter		Length A		Width B		Height C		Material	Color	Adhesive Type	Std. Pkg. Qty.	Std. Ctn. Qty.
	In.	mm	In.	mm	In.	mm	In.	mm					
<b>VCC25-A-C</b>	0.25	6.4	1.00	25.4	0.50	12.7	0.44	11.2	Nylon 6.6	Natural	Rubber	100	500
<b>VCC50-A-C</b>	0.50	12.7	1.56	39.7	1.00	25.4	0.81	20.6		Natural		100	500

E5. Lockout/Tagout & Safety Solutions

F. Index

## Adhesive Backed Latching Clips

- Latching cover withstands vibration

- For indoor use only

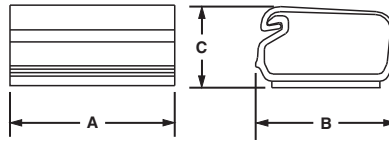
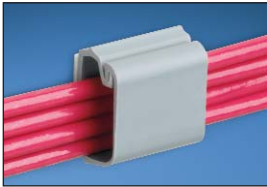

Part Number	Max. Bundle Diameter		Length A		Width B		Height C		Material	Color	Adhesive Type	Std. Pkg. Qty.	Std. Ctn. Qty.
	In.	mm	In.	mm	In.	mm	In.	mm					
LC3-A-C8	0.20	5.0	0.75	19.1	0.75	19.0	0.47	11.9	PVC	Light Gray	Rubber	100	1000
LC5-A-C8	0.36	9.1	1.01	25.7	1.01	25.7	0.61	15.5				100	1000
LC10-A-L8	0.93	23.6	1.51	38.4	1.51	38.4	0.84	21.3				50	500

## Cable Holder – Adhesive Backed

- Convenient releasable latch allows easy addition and removal of cables

- Low profile design provides a compact cable routing solution

- For indoor use only

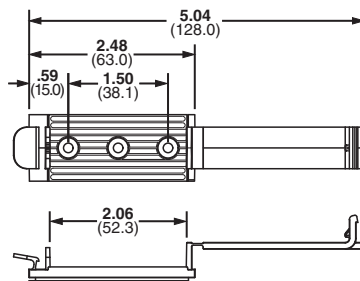

Part Number	Cable Width		Material	Color	Mounting Method	Std. Pkg. Qty.	Std. Ctn. Qty.
	In.	mm					
CH105-A-C14	2.06	52.3	Nylon 6.6	Gray	Rubber Adhesive Tape	100	1000
CH105-S6-C14	2.06	52.3			#6 (M3) Screw	100	1000

## Low Profile Flat Cable Mounts

- Three sizes provide a cost effective flat cable containment for stack heights up to .105 inches (2.7mm)

- Low profile design holds wires, cables, and tubing

- For indoor use only

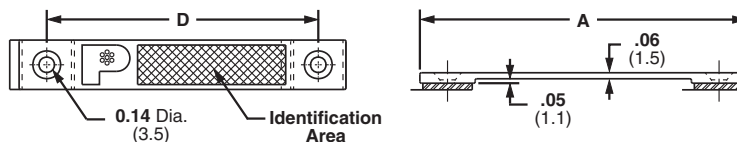
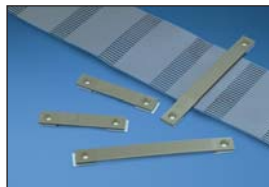

Part Number	Cable Width		Length A		Hole Spacing D		Material	Color	Adhesive Type	Std. Pkg. Qty.	Std. Ctn. Qty.
	In.	mm	In.	mm	In.	mm					
LPFCM14-A-C14	1.44	37.0	2.56	65.0	2.00	50.8	Nylon 6.6	Gray	Rubber	100	500
LPFCM22-A-C14	2.19	56.0	3.31	84.0	2.75	69.9				100	500
LPFCM34-A-C14	3.44	87.0	4.56	115.8	4.00	101.6				100	500

A. System Overview

B1. Cable Ties

B2. Cable Accessories

B3. Stainless Steel Ties

C1. Wiring Duct

C2. Surface Raceway

C3. Abrasion Protection

C4. Cable Management

D1. Terminals

D2. Power Connectors

D3. Grounding Connectors

E1. Labeling Systems

E2. Labels

E3. Pre-Printed & Write-On Markers

E4. Permanent Identification

E5. Lockout/Tagout & Safety Solutions

F. Index

## Latching Flat Cable Mounts

- Available in four sizes with a stack height of .17 inches (4.3mm) to accommodate different flat cable widths
- Low profile design holds wires, cables, and tubing
- Convenient releasable latch
- Large mounting base for high bonding strength
- For indoor use only
- Material: Nylon 6.6

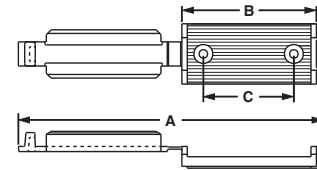
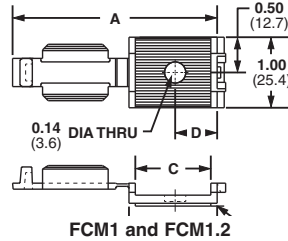

Part Number	Cable Width		Length A		Width B		Hole Spacing C		Color	Mounting Method	Std. Pkg. Qty.	Std. Ctn. Qty.
	In.	mm	In.	mm	In.	mm	In.	mm				
<b>Adhesive Backed</b>												
<b>FCM1-A-C14</b>	1.05	26.7	2.90	73.7	1.05	26.7	—	—	Gray	Rubber Adhesive	100	500
<b>FCM1.2-A-C14</b>	1.20	30.5	3.16	80.3	1.37	34.8	—	—			100	1000
<b>FCM2-A-C14</b>	2.05	52.1	5.06	128.5	2.22	56.4	1.53	38.9			100	500
<b>FCM3.25-A-L14</b>	3.38	85.9	7.30	185.4	3.38	85.9	1.50	38.1			50	500
<b>Screw Mounted</b>												
<b>FCM1-S6-C14</b>	1.05	26.7	2.90	73.7	1.00	25.4	—	—	Gray	#6 (M3) Screw	100	1000
<b>FCM1.2-S6-C14</b>	1.20	30.5	3.16	80.3	1.37	34.8	—	—			100	1000
<b>FCM2-S6-C14</b>	2.05	52.1	5.06	128.5	2.22	56.4	1.53	38.9			100	1000
<b>FCM3.25-S6-L14</b>	3.38	85.9	7.30	185.4	3.38	85.9	1.50	38.1			50	500

## Latching Flat Cable Holders

- Low profile design holds wires, cables, and tubing
- Convenient releasable latch
- Large mounting base for high bonding strength
- For indoor use only
- See also Flat Cable Mounting System on Page B2.25
- Material: Nylon 6.6

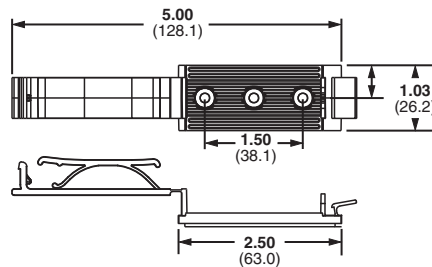

Part Number	Length		Cable Width		Color	Mounting Method	Std. Pkg. Qty.	Std. Ctn. Qty.
	In.	mm	In.	mm				
<b>FCH2-A-C14</b>	2.48	63.0	2.00	50.8	Gray	Rubber Adhesive	100	500
<b>FCH2-S6-C14</b>	2.48	63.0	2.00	50.8	Gray	#6 (M3) Screw	100	500

See also Flat Cable Mounting System on Page B2.25.

## Flat Cable Clips

- Use with any width flat cable for a maximum stack height of .17 inches (4.3mm)
- Low profile design holds wires, cables, and tubing
- For indoor use only
- Material: PVC



Part Number	Cable Width	Length A		Width B		Height C		Color	Mounting Method	Std. Pkg. Qty.	Std. Ctn. Qty.
		In.	mm	In.	mm	In.	mm				
FCC5-A-C8	Any width flat cable	1.00	25.4	.56	14.2	.29	7.4	Gray	Rubber	100	1000
FCC-A-C8		1.00	25.4	1.09	27.7	.38	9.7			100	1000

## Pan-Clamp™ Heavy Duty Fixed Diameter Clamps

- One-piece design significantly reduces installation time
- Integrated ribs prevent rotation of cable bundles and ensures secure grip on hoses
- Material: Impact modified Weather Resistant Nylon 6.6

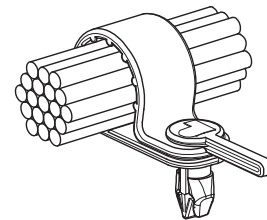
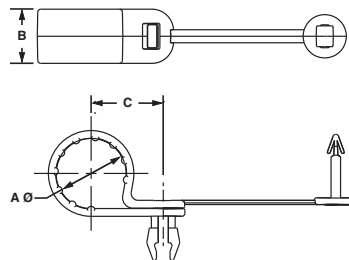

Part Number	Max. Bundle Diameter A		Width B		Bundle Offset C		Max. Panel Thickness		Panel Hole Diameter		Color	Std. Pkg. Qty.	Std. Ctn. Qty.
	In.	mm	In.	mm	In.	mm	In.	mm	In.	mm			
PC038-H25D-C0	.38	9.5	.62	15.7	.64	16.3	.13	3.2	.28	7.1	Black	100	500
PC050-H25D-C0	.50	12.7	.62	15.7	.71	17.9	.13	3.2	.28	7.1		100	500
PC062-H25D-C0	.63	15.8	.62	15.7	.77	19.5	.13	3.2	.28	7.1		100	500
PC075-H25D-C0	.75	19.1	.62	15.7	.83	21.1	.13	3.2	.28	7.1		100	1000
PC087-H25D-C0	.88	22.1	.62	15.7	.89	22.7	.13	3.2	.28	7.1		100	1000
PC100-H25D-C0	1.00	25.4	.62	15.7	.96	24.3	.13	3.2	.28	7.1		100	1000
PC112-H25D-C0	1.13	28.5	.62	15.7	1.02	25.8	.13	3.2	.28	7.1		100	1000
PC125-H25D-C0	1.25	31.8	.62	15.7	1.08	27.4	.13	3.2	.28	7.1		100	1000

A.  
System  
Overview

## Fixed Diameter Cable Clamps

- Durable Nylon 6.6 cable clamps

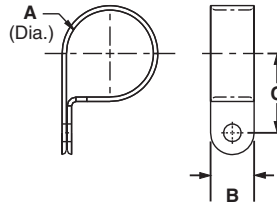

B1.  
Cable Ties

B2.  
Cable  
Accessories

B3.  
Stainless  
Steel Ties

C1.  
Wiring  
Duct

C2.  
Surface  
Raceway

C3.  
Abrasion  
Protection

C4.  
Cable  
Management

D1.  
Terminals

D2.  
Power  
Connectors

D3.  
Grounding  
Connectors

E1.  
Labeling  
Systems

E2.  
Labels

E3.  
Pre-Printed  
& Write-On  
Markers

E4.  
Permanent  
Identification

E5.  
Lockout/  
Tagout  
& Safety  
Solutions

F.  
Index

Part Number	Max. Bundle Diameter A		Width B		Bundle Offset C		Mounting Method	Std. Pkg. Qty	Std. Ctn. Qty.
	In.	mm	In.	mm	In.	mm			
<b>CCS12-S8-C</b>	.12	3.1	.37	9.4	.33	8.4	#8 (M4) Screw	100	500
<b>CCS19-S8-C</b>	.19	4.8	.37	9.4	.43	10.9	#8 (M4) Screw	100	500
<b>CCS25-S8-C</b>	.25	6.3	.37	9.4	.41	10.4	#8 (M4) Screw	100	500
<b>CCS25-S10-C</b>	.25	6.3	.37	9.4	.41	10.4	#10 (M5) Screw	100	500
<b>CCS31-S8-C</b>	.31	7.9	.37	9.4	.49	12.4	#8 (M4) Screw	100	500
<b>CCS38-S8-C</b>	.38	9.5	.37	9.4	.59	15.0		100	500
<b>CCS44-S8-C</b>	.44	11.1	.37	9.4	.57	14.5		100	500
<b>CCS50-S8-C</b>	.50	12.7	.37	9.4	.60	15.2		100	500
<b>CCH12-S10-C</b>	.12	3.1	.50	12.7	.36	9.1	#10 (M5) Screw	100	500
<b>CCH19-S10-C</b>	.19	4.8	.50	12.7	.42	10.7		100	500
<b>CCH25-S10-C</b>	.25	6.3	.50	12.7	.46	11.7		100	500
<b>CCH31-S10-C</b>	.31	7.9	.50	12.7	.50	12.7		100	500
<b>CCH38-S10-C</b>	.38	9.5	.50	12.7	.53	13.5		100	500
<b>CCH44-S10-C</b>	.44	11.1	.50	12.7	.56	14.2		100	500
<b>CCH50-S10-C</b>	.50	12.7	.50	12.7	.59	15.0		100	500
<b>CCH56-S10-C</b>	.56	14.2	.50	12.7	.61	15.5		100	500
<b>CCH62-S10-C</b>	.62	15.7	.50	12.7	.65	16.5		100	500
<b>CCH69-S10-C</b>	.69	17.5	.50	12.7	.75	19.1		100	500
<b>CCH75-S10-C</b>	.75	19.1	.50	12.7	.78	19.8		100	500
<b>CCH81-S10-C</b>	.81	20.6	.50	12.7	.81	20.6		100	500
<b>CCH87-S10-C</b>	.87	22.1	.50	12.7	.84	21.3		100	500
<b>CCH100-S10-C</b>	1.00	25.4	.50	12.7	.91	23.1		100	500
<b>CCH112-S10-C</b>	1.12	28.4	.50	12.7	.97	24.6	100	500	
<b>CCH119-S10-C</b>	1.19	30.2	.50	12.7	1.00	25.4	100	500	
<b>CCH125-S10-C</b>	1.25	31.8	.50	12.7	1.06	26.9	100	500	
<b>CCH138-S10-C</b>	1.37	34.8	.50	12.7	1.12	28.4	100	500	
<b>CCH150-S10-C</b>	1.50	38.1	.50	12.7	1.19	30.2	100	500	

All parts listed are also available in black weather resistant material (add suffix 0). Bulk package only.



## Wire Retainers

- Wires slide into the clip and are held in place by tension
- Low profile design holds wires, cables, and tubing
- Funnel entry design allows for easy insertion of cords and cables

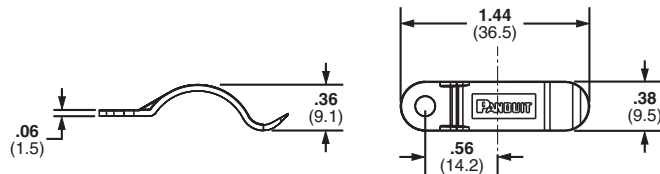

Part Number	Max. Bundle Diameter		Material	Color	Environment	Mounting Method	Std. Pkg. Qty.	Std. Ctn. Qty.
	In.	mm						
TWR-C	0.38	9.5	Nylon 6.6	Natural	Indoors	#6 (M3) Screw	100	500
TWR-C0	0.38	9.5	Weather Resistant Nylon 6.6	Black	Outdoors		100	500

## Siding Clips

- Low profile installs without drilling or nailing
- Attach coax cable to buildings having "Pittsburgh Interlok" type aluminum or steel siding
- Will not corrode or stain siding

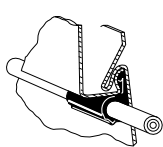

Horizontal Siding Clip

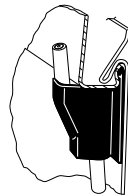

Vertical Siding Clip

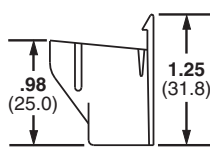

VSC Vertical Clip

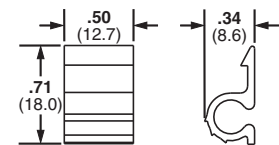
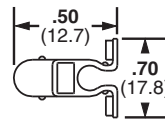

HSC Horizontal Clip

Part Number	Max. Bundle Diameter		Material	Color	Mounting Method	Std. Pkg. Qty.	Std. Ctn. Qty.
	In.	mm					
HSC.25-L	0.25	6.4	Nylon 6.6	White	Clip	50	500
HSC.25-L100	0.25	6.4	Weather Resistant Polypropylene	Black		50	500
VSC.25-L	0.25	6.4	Nylon 6.6	White		50	500
VSC.25-L100	0.25	6.4	Weather Resistant Polypropylene	Black		50	500

A.  
System  
Overview

## Wire Standoffs

B1.  
Cable Ties

- For retaining wires, cable, components or tubing away from panel or conductive chassis
- Design of wing provides added stability
- Material: Nylon 6.6
- Finger grip flanges can be easily locked or unlocked for revisions
- For indoor use only

B2.  
Cable  
Accessories



B3.  
Stainless  
Steel Ties

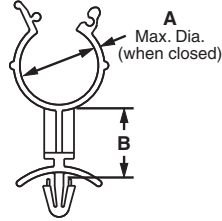

C1.  
Wiring  
Duct

C2.  
Surface  
Raceway

C3.  
Abrasion  
Protection

C4.  
Cable  
Management

D1.  
Terminals

D2.  
Power  
Connectors

D3.  
Grounding  
Connectors

E1.  
Labeling  
Systems

E2.  
Labels

E3.  
Pre-Printed  
& Write-On  
Markers

E4.  
Permanent  
Identification

E5.  
Lockout/  
Tagout  
& Safety  
Solutions

F.  
Index

Part Number	Max. Bundle Diameter A		Standoff Height B		Max. Panel Thickness		Panel Hole Diameter		Color	Mounting Method	Std. Pkg. Qty.	Std. Ctn. Qty.
	In.	mm	In.	mm	In.	mm	In.	mm				
WS25-25-C	.25	6.4	.25	6.4	.08	2.0	.19	4.7	Natural	Push Barb	100	500
WS25-50-C	.25	6.4	.50	12.7	.08	2.0	.19	4.7			100	500
WS25-75-C	.25	6.4	.75	19.1	.08	2.0	.19	4.7			100	500
WS35-25-C	.35	8.9	.25	6.4	.08	2.0	.19	4.7			100	500
WS35-50-C	.35	8.9	.50	12.7	.08	2.0	.19	4.7			100	500
WS35-75-C	.35	8.9	.75	19.1	.08	2.0	.19	4.7			100	500
WS50-25-C	.47	11.9	.25	6.4	.08	2.0	.19	4.7			100	500
WS50-50-C	.47	11.9	.50	12.7	.08	2.0	.19	4.7			100	500
WS50-75-C	.47	11.9	.75	19.1	.08	2.0	.19	4.7			100	500
WS75-25-C	.78	19.8	.25	6.4	.08	2.0	.19	4.7			100	500
WS75-50-C	.78	19.8	.50	12.7	.08	2.0	.19	4.7			100	500
WS75-75-C	.78	19.8	.75	19.1	.08	2.0	.19	4.7			100	500

## ® Snap-In Clips

- Clip around bundle to hold securely in place
- Clips are placed on the bundle then attached to the panel
- Material: Nylon 6.6
- For indoor use only

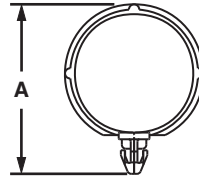

Part Number	Max. Bundle Diameter		Height A		Max. Panel Thickness		Panel Hole Diameter		Color	Mounting Method	Std. Pkg. Qty.	Std. Ctn. Qty.
	In.	mm	In.	mm	In.	mm	In.	mm				
SICH25-C	.25	6.4	.40	20.9	.10	2.5	.25	6.4	Natural	Push Barb	100	500
SICH38-C	.38	9.7	.54	24.9	.10	2.5	.25	6.4			100	500
SICH50-C	.50	12.7	.67	28.2	.10	2.5	.25	6.4			100	500
SICH75-C	.75	19.1	.96	35.6	.10	2.5	.25	6.4			100	500
SICH100-C	1.00	25.4	1.21	41.9	.10	2.5	.25	6.4			100	500
SICH150-C	1.50	38.0	1.71	54.6	.10	2.5	.25	6.4			100	500

## ® Wire Saddles

- Funnel entry design for fast insertion of wires and cables
- Available in vertical and horizontal loading configurations
- Design of wing provides added stability
- Material: Nylon 6.6
- For indoor use only

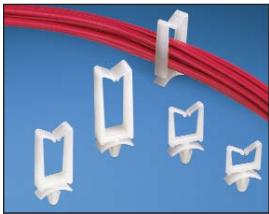

VWS Vertical

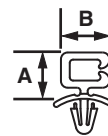

HWS Horizontal

Part Number	Max. Bundle Capacity		Height A		Width B		Max. Panel Thickness		Panel Hole Diameter		Color	Mounting Method	Std. Pkg. Qty.	Std. Ctn. Qty.
	In.	mm	In.	mm	In.	mm	In.	mm	In.	mm				
VWS4218-C	0.18 x 0.42	5.0 x 10.7	0.58	14.7	0.60	15.2	0.08	2.0	0.19	4.7	Natural	Push Barb	100	500
VWS4238-C	0.40 x 0.42	10.2 x 10.7	0.78	19.8	0.60	15.2	0.08	2.0	0.19	4.7			100	500
VWS4274-C	0.74 x 0.42	19.0 x 10.7	1.14	29.0	0.60	15.2	0.08	2.0	0.19	4.7			100	500
VWS42105-C	1.05 x .42	27.0 x 10.7	1.45	36.8	0.60	15.2	0.08	2.0	0.19	4.7			100	1000
HWS2819-C	0.19 x 0.28	5.0 x 7.1	0.42	10.7	0.44	11.2	0.08	2.0	0.19	4.7			100	500

A. System Overview



## Corrugated Tubing Holder with Push Mount

B1. Cable Ties

- Use to secure and route all standard sizes of solid wall or slit corrugated loom tubing
- Ribs prevent lateral movement of corrugated loom tubing along the mount

- Rugged clip prevents accidental disassembly of tubing due to shock or vibration

B2. Cable Accessories

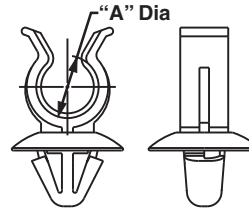

B3. Stainless Steel Ties

C1. Wiring Duct

C2. Surface Raceway

C3. Abrasion Protection

C4. Cable Management

Part Number	Nominal Diameter A		Max. Panel Thickness		Panel Hole Diameter		Std. Pkg. Qty.	Std. Ctn. Qty.
	In.	mm	In.	mm	In.	mm		
CTH19U04-C30	0.19	5	0.125	3.2	0.386	9.8	100	—
CTH35U08-C30	0.35	9	0.125	3.2	0.386	9.8	100	500
CTH38U10-C30	0.38	10	0.125	3.2	0.386	9.8	100	—
CTH50U13-C30	0.50	13	0.125	3.2	0.386	9.8	100	—
CTH62U17-C30	0.62	17	0.125	3.2	0.386	9.8	100	—
CTH87U22-C30	0.87	22	0.125	3.2	0.386	9.8	100	—

D1. Terminals

## Harness Clips

D2. Power Connectors

- Integral "spring" holds wire bundles tightly
- Available in vertical and horizontal loading configurations

- Design of wing provides added stability

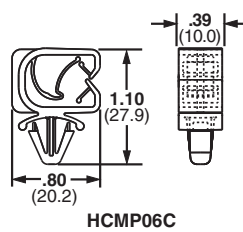
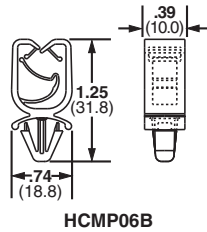

E1. Labeling Systems

E2. Labels

E3. Pre-Printed & Write-On Markers

Part Number	Max. Bundle Diameter Range		Max. Panel Thickness		Panel Hole Diameter		Material	Color	Mounting Method	Std. Pkg. Qty.	Std. Ctn. Qty.
	In.	mm	In.	mm	In.	mm					
HCMP06B12-C20	.24 - .47	5.9 - 12.5	.118	3.0	.25	6.4	Nylon 6.6	Black	Push Mount	100	500
HCMP06C12-C20	.24 - .47	5.9 - 12.5	.105	2.7	.25	6.4				100	500

E4. Permanent Identification

E5. Lockout/Tagout & Safety Solutions

F. Index

## Optical Fiber Network Saddles

• Use in pre-drilled .18 inch (4.0mm) holes in panels up to .09 inch (2.0mm) thick

• Smooth rounded edges eliminate potential for snagging and stress on cable

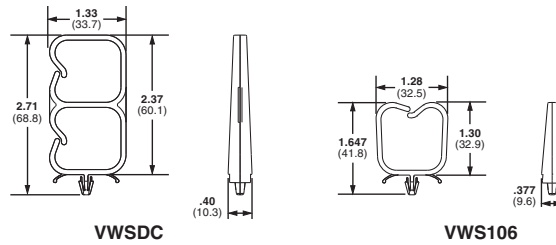

Part Number	Max. Bundle Diameter		Material	Mounting Method	Color	Std. Pkg. Qty.	Std. Ctn. Qty.
	In.	mm					
VWSDC-C*	1.06	26.9	Nylon 6.6	Push Barb	Natural	100	500
VWSDC-C20*	1.06	26.9	Nylon 6.6	Push Barb	Black	100	—
VWS106-C	1.06	26.9	Nylon 6.6	Push Barb	Natural	100	500
VWS106-C20	1.06	26.9	Nylon 6.6	Push Barb	Black	100	500

\*Accepts two bundles.

## Nylon Edge Clips

• Integral “spring” holds wire bundles tightly  
• Available in vertical and horizontal loading configurations

• Design of wing provides added stability  
• Indoor/Outdoor use

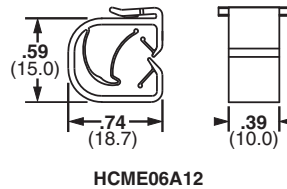

Part Number	Max. Bundle Diameter Range		Max. Panel Thickness		Material	Color	Mounting Method	Std. Pkg. Qty.	Std. Ctn. Qty.
	In.	mm	In.	mm					
HCME04Y09-C30*	0.16 – 0.35	4.0 – 9.0	0.16	4.0	Nylon 6.6 Heat Stabilized	Black	Clip onto Edge	100	—
HCME06A12-C130	0.24 – 0.47	5.9 – 12.5	0.05	1.2	Acetal Heat Stabilized			100	500
HCME06Y12-C30*	0.31 – 0.47	8.0 – 12.0	0.16	4.0	Nylon 6.6 Heat Stabilized			100	—

\*Bulk packaging size available.

## Wire Bundle Strap

• Securely routes large cable bundles

• Rounded edges prevent damage to cable jackets

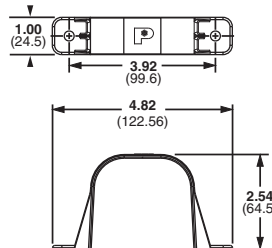

Part Number	Bundle Retaining Area In. <sup>2</sup>	Material	Color	Mounting Method	Std. Pkg. Qty.	Std. Ctn. Qty.
WBS6-Q	6.00	ABS	White	(2) 1/4" (M6) Screws	25	125

A. System Overview

## Circuit Board Posts

B1. Cable Ties

- For board-to-board or board-to-chassis mounting
- Bell flange on bottom end provides greater stability
- Releasable and reusable

- Material: Nylon 6.6
- Color: Natural

B2. Cable Accessories



B3. Stainless Steel Ties

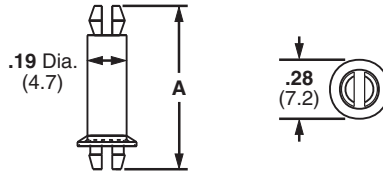

Part Number	Standoff Height		Height A		Panel Hole Diameter		Mounting Method	Std. Pkg. Qty.	Std. Ctn. Qty.
	In.	mm	In.	mm	In.	mm			
<b>CBP12-C</b>	.12	3.0	.40	10.2	.156	3.96	Push Barb	100	500
<b>CBP25-C</b>	.25	6.4	.54	13.5	.156	3.96		100	500
<b>CBP31-C</b>	.31	7.9	.59	15.0	.156	3.96		100	500
<b>CBP37-C</b>	.37	9.4	.62	15.7	.156	3.96		100	500
<b>CBP50-C</b>	.50	12.7	.78	19.8	.156	3.96		100	500
<b>CBP62-C</b>	.62	15.7	.91	23.0	.156	3.96		100	500
<b>CBP75-C</b>	.75	19.1	1.04	26.2	.156	3.96		100	500
<b>CBP87-C</b>	.87	22.1	1.15	29.2	.156	3.96		100	500
<b>CBP100-C</b>	1.00	25.4	1.28	32.5	.156	3.96		100	500

C1. Wiring Duct

C2. Surface Raceway

C3. Abrasion Protection

C4. Cable Management

D1. Terminals

## Circuit Board Locking Supports

D2. Power Connectors

- For board-to-chassis support
- Snap-in design for fast assembly
- Design of wing provides added stability

- Releasable and reusable
- Material: Nylon 6.6

D3. Grounding Connectors

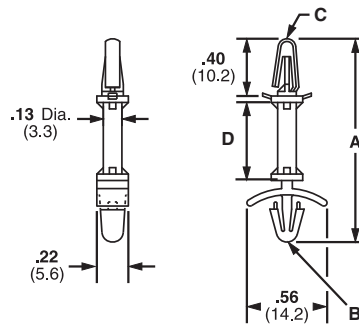

E1. Labeling Systems

E2. Labels

Part Number	Height A		Panel Hole Diameter B		Chassis Panel Hole Diameter C		Standoff Height D		Color	Mounting Method	Std. Pkg. Qty.	Std. Ctn. Qty.
	In.	mm	In.	mm	In.	mm	In.	mm				
<b>CBLS18-C</b>	.92	23.4	.19	4.8	.16	4.0	.19	4.7	Natural	Push Barb	100	500
<b>CBLS25-C</b>	.98	24.9	.19	4.8	.16	4.0	.25	6.4			100	500
<b>CBLS37-C</b>	1.11	28.2	.19	4.8	.16	4.0	.38	9.5			100	500
<b>CBLS50-C</b>	1.23	31.2	.19	4.8	.16	4.0	.50	12.7			100	500
<b>CBLS62-C</b>	1.35	34.3	.19	4.8	.16	4.0	.63	15.9			100	500
<b>CBLS75-C</b>	1.48	37.5	.19	4.8	.16	4.0	.75	19.1			100	500

E3. Pre-Printed & Write-On Markers

E4. Permanent Identification

E5. Lockout/Tagout & Safety Solutions

F. Index

## Harness Board Accessories

Panduit harness board accessories provide fast routing and forming of wires in harness fabrication. They hold the wires off the harness board at a uniform height for easy application of cable ties. The accessories are designed for use with various Panduit cable tie installation tools. To maintain the harness at a uniform height of approx. 1.33 inches (33.8mm) (at the center of the harness) above the board, use RER Elastic Retainers, BR.75-E6 or BR.5-E6, CPH.75-S8, TJF and SHH1-S8 or SHH3-S8 harness board accessories. This height is suitable for use with PAT1M Automatic Cable Tie Installation Tool.



## Elastic Retainers

- Cable bundles are formed as individual wires are inserted
- Completed bundles can be easily removed
- The elastic band is replaceable
- For indoor use only

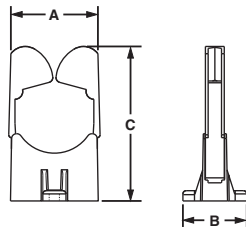

### Replacement Elastic

Part Number	Pkg. Qty.
RER.5E-X	10
RER.75E-X	10
RER1.25E-X	10
RER2.0E-X	10

For economy, the elastic band can be replaced in the RER Elastic Retainers without removing the RER base.

Part Number	Max. Bundle Diameter		Length A		Width B		Height C		Material	Color	Mounting Method	Std. Pkg. Qty.	Std. Ctn. Qty.
	In.	mm	In.	mm	In.	mm	In.	mm					
RER.5-S6-X	0.50	12.7	1.18	30.0	0.84	21.3	1.89	48.0	Nylon 6.6	Black Base, White Arm	Two #6 (M3) Screws	10	50
RER.75-S6-X	0.75	19.0	1.18	30.0	1.12	28.4	2.21	56.1				10	50
RER1.25-S6-X	1.25	31.8	1.18	30.0	1.64	41.7	2.86	72.6		10		50	
RER2.0-S6-X	2.00	50.8	1.31	33.3	2.81	71.4	3.94	100.2		Natural		10	50



## Elastic Retainers – ER Type

- Cable bundles are formed as cable bundles are inserted
- Completed bundles can be easily removed
- For indoor use only

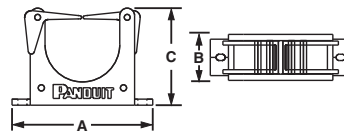

Part Number	Max. Bundle Diameter		Length A		Width B		Height C		Material	Color	Mounting Method	Std. Pkg. Qty.	Std. Ctn. Qty.
	In.	mm	In.	mm	In.	mm	In.	mm					
ER.5-E4-X	.50	12.7	1.96	49.8	.56	14.2	1.00	25.4	Nylon 6.6	Black	Two #6 (M3) Screws	10	100
ER1.25-E4-X	1.25	31.8	2.90	73.7	.95	24.1	2.00	50.8				10	100

A. System Overview

B1. Cable Ties

B2. Cable Accessories

B3. Stainless Steel Ties

C1. Wiring Duct

C2. Surface Raceway

C3. Abrasion Protection

C4. Cable Management

D1. Terminals

D2. Power Connectors

D3. Grounding Connectors

E1. Labeling Systems

E2. Labels

E3. Pre-Printed & Write-On Markers

E4. Permanent Identification

E5. Lockout/Tagout & Safety Solutions

F. Index

## Bundle Retainers

- Funnel entry allows fast cable insertion
- Completed bundles can be easily removed
- For indoor use only
- Color: Black

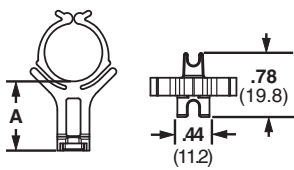

BR.5 and BR.75

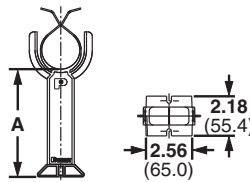

BR2

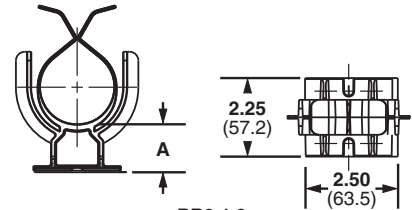

BR2-1.3

Part Number	Max. Bundle Diameter		Standoff Height A		Material	Mounting Method	Std. Pkg. Qty.	Std. Ctn. Qty.
	In.	mm	In.	mm				
BR.5-E6-C	0.50	12.7	1.07	27.2	Impact Resistant Nylon 6.6	Two #6 (M3) Screws	100	500
BR.75-E6-C	0.75	19.0	0.95	24.1			100	500
BR2-1.3-X	2.00	50.8	1.32	33.5	Glass Filled Nylon 6.6	Two 1/4" (M6) Screws	10	10
BR2-1.3-A-X	2.00	50.8	1.35	34.3		Rubber Adhesive Tape	10	10
BR2-1.5-X	2.00	50.8	1.59	40.4		Two 1/4" (M6) Screws	10	10
BR2-4-X	2.00	50.8	4.06	103.1			10	10
BR2-6-X	2.00	50.8	6.02	152.9		10	10	

## Corner Posts

- Designed to pre-form tight bundles at harness corners and breakouts
- Top arm rotates upward for easy removal of completed harness
- For indoor use only

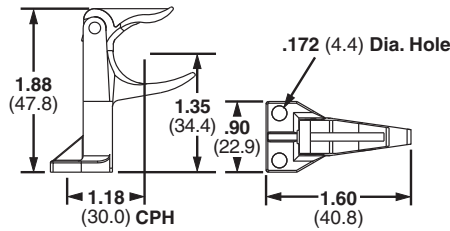

1.18 (30.0) CPH

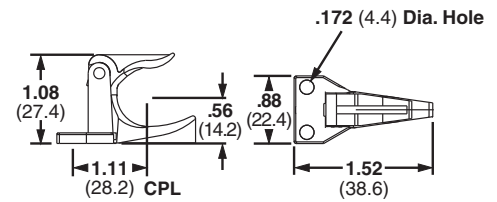

1.11 (28.2) CPL

Part Number	Max. Bundle Diameter		Material	Color	Mounting Method	Std. Pkg. Qty.	Std. Ctn. Qty.
	In.	mm					
CPH.75-S8-X	.75	19.0	Nylon 6.6	Black	Two #8 (M4) Screws	10	100
CPL.75-S8-X							

## T-Junction Fixture

- Forms cable junctions
- Fixture moves down for easy harness removal
- For indoor use only

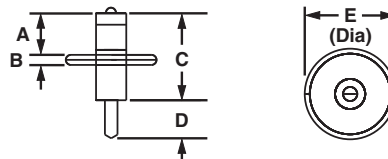

Part Number	Max. Bundle Diameter		Material	Color	Mounting Method	Std. Pkg. Qty.	Std. Ctn. Qty.
	In.	mm					
TJF-X	1.34	34.0	Nylon 6.6 and Nickel Plated Steel	Black	Nail	10	100



## Wire End Holder

- Secures wire ends while harness is being fabricated
- Used with #28 thru #16 AWG wires

- For indoor use only

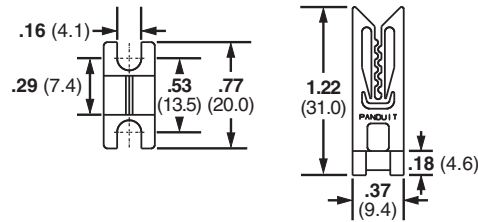

Part Number	Material	Color	Mounting Method	Std. Pkg. Qty.	Std. Ctn. Qty.
WEH-E8-C	Acetal	Black	Two #8 (M4) Screws	100	1000

## Harness Board Nails

- Speed routing of wires
- Uniform driving depth is insured by a collar stop

- Smooth finish on nails prevents abrasion to wire jackets
- For indoor use only

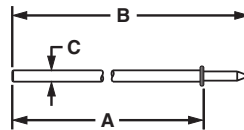

Part Number	Length A		Overall Length B		Thickness C		Material	Mounting Method	Std. Pkg. Qty.	Std. Ctn. Qty.
	In.	mm	In.	mm	In.	mm				
HBN.75-T	.75	19.1	1.40	35.6	.07	1.9	Nickel Plated Steel	Hammered into harness board	200	1000
HBN1-T	1.00	25.4	1.65	41.9	.07	1.9			200	1000
HBN1.5-T	1.50	38.1	2.16	54.9	.08	2.1			200	1000
HBN2-T	2.00	50.8	2.66	67.6	.09	2.4			200	1000
HBN2.5-T	2.50	63.5	3.16	80.3	.11	2.8			200	1000
HBN3-T	3.00	76.2	3.67	93.2	.12	3.0			200	1000
HBN4-T	4.00	101.6	4.67	118.6	.14	3.7			200	1000

A. System Overview

## Fanning Strip System

- Holds wires in a specific orientation
- No sharp edges to damage wire insulation
- Will accept wires up to 18 AWG
- Fanning strip can remain as part of completed harness

B1. Cable Ties

B2. Cable Accessories

B3. Stainless Steel Ties

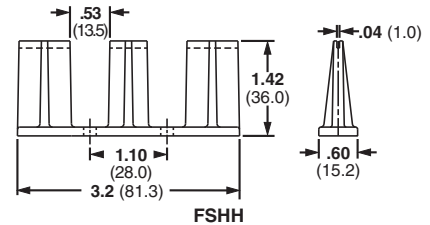
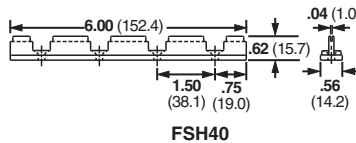
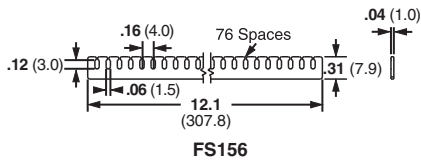

C1. Wiring Duct

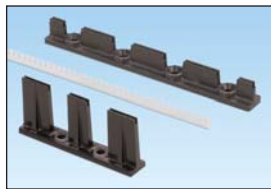

Part Number	Material	Color	Mounting Method	Std. Pkg. Qty.	Std. Ctn. Qty.
FS156-C	Nylon 6.6	Natural	FSH Holder	100	1000
FSH40-X	ABS	Black	Four #8 (M4) Screws	10	100
FSHH-X			Two #8 (M4) Screws	10	100

C2. Surface Raceway

C3. Abrasion Protection

C4. Cable Management

## Spring Wire Breakout System

- Harness board spring and spring holder holds wire ends secure while harness is being fabricated
- Wires simply pull out from spring when harness is removed
- Each SHH Spring Holder is supplied with one rigid wire piece to hold the spring laterally and two #8 (M4), 2" (50.8mm) hex head wood screws; purchase spring separately

D1. Terminals

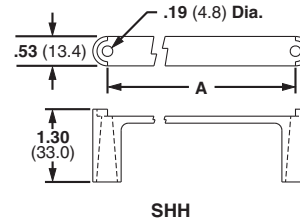
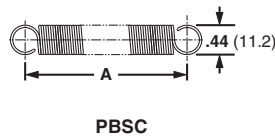
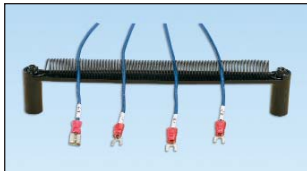

D2. Power Connectors

D3. Grounding Connectors

Part Number	Hole Spacing A		Material	Color	Mounting Method	Std. Pkg. Qty.	Std. Ctn. Qty.
	In.	mm					
PBSC1-X	1.00	25.4	Steel	—	SHH1 Spring Holder	10	100
PBSC3-X	3.00	76.2		—	Two #8 (M4) Screws	10	100
PBSC6-X	6.00	152.4		—	SHH3 Spring Holder	10	100
PBSC12-X	12.00	304.8		—	Two #8 (M4) Screws	10	100
SHH1-S8-X	1.85	47.0	Nylon 6.6	Natural	Two #8 (M4) Screws	10	100
SHH3-S8-X	6.80	172.7			Two #8 (M4) Screws	10	100

E1. Labeling Systems

E2. Labels

E3. Pre-Printed & Write-On Markers

E4. Permanent Identification

E5. Lockout/Tagout & Safety Solutions

F. Index

## Tie Harness Mounts

- Designed to be attached to the wire harness during assembly
- Cable ties can be installed by hand or with Panduit automatic cable tie tools
- Used with harness board standoff posts
- Available with or without corrugated tubing location tab
- Natural nylon material for indoor use
- Heat stabilized nylon material (30) for high temperature applications – indoor use

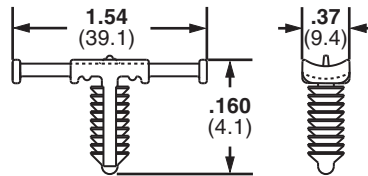

Part Number	Used with Cable Ties*	Maximum Panel Thickness		Panel Hole Diameter		Material	Color	Mounting Method	Std. Pkg. Qty.	Std. Ctn. Qty.
		In.	mm	In.	mm					

**FOR CORRUGATED TUBING – A location tab on the mount shelf aligns with the corrugated tubing grooves to ensure proper mount location during assembly**

THMSP20-C	M, I, S	.160	4.1	0.244 – 0.283	6.2 – 7.2	Nylon 6.6	Natural	Push Barb	100	1000
THMSP20-C30	M, I, S	.160	4.1	0.244 – 0.283	6.2 – 7.2	Heat Stabilized Nylon 6.6	Black	Push Barb	100	1000
THMSP25-C	M, I, S	.230	5.8	0.244 – 0.283	6.2 – 7.2	Nylon 6.6	Natural	Push Barb	100	1000
THMSP25-C30	M, I, S	.230	5.8	0.244 – 0.283	6.2 – 7.2	Heat Stabilized Nylon 6.6	Black	Push Barb	100	1000

**FOR DISCRETE WIRING – No location tab**

THMSP20F-C	M, I, S	.160	4.1	0.244 – 0.283	6.2 – 7.2	Nylon 6.6	Natural	Push Barb	100	1000
THMSP20F-C30	M, I, S	.160	4.1	0.244 – 0.283	6.2 – 7.2	Heat Stabilized Nylon 6.6	Black	Push Barb	100	1000
THMSP25F-C	M, I, S	.230	5.8	0.244 – 0.283	6.2 – 7.2	Nylon 6.6	Natural	Push Barb	100	1000
THMSP25F-C30	M, I, S	.230	5.8	0.244 – 0.283	6.2 – 7.2	Heat Stabilized Nylon 6.6	Black	Push Barb	100	1000

\*Cable tie cross section sizes: M = Miniature, I = Intermediate, S = Standard.

## Harness Board Standoff Posts and Adapter

- Used to hold a push mount accessory or cable tie at a specific location on a harness board

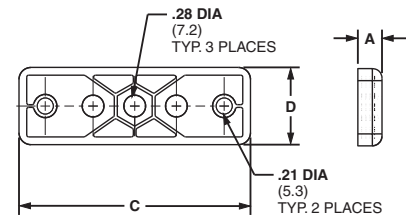
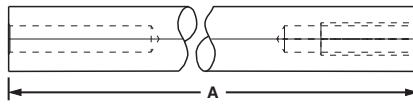
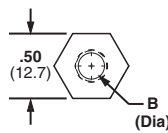

HB2SP

HBUA

Part Number	Height A		Hole Diameter B		Length C		Width D		For Use With	Material	Mounting Method	Std. Pkg. Qty.	Std. Ctn. Qty.
	In.	mm	In.	mm	In.	mm	In.	mm					

### Posts

HB2SP19-X	2.00	50.8	.20	5.2	—	—	0.50	12.7	PLWP, PRWP, WS, VWS, HWS, TPM	Aluminum	Bolt – Included	10	100
HB2SP25-X	2.00	50.8	.30	7.5	—	—	0.50	12.7	PLWP, PRWP, PLP, THMS, HCMP, PMCC	Aluminum	Bolt – Included	10	100

### Adapter

HBUA-X	.31	7.9	.28	7.1	3.00	76.2	1.00	25.4	HB2SP19-X, HB2SP25-X	Nylon 6.6	#10 (M5) Screw	10	100
--------	-----	-----	-----	-----	------	------	------	------	----------------------	-----------	----------------	----	-----

A. System Overview



## Automatic Cable Tie Mounts

B1. Cable Ties

- Multiple sizes work with industry standard panel thickness and hole diameters for greater application flexibility
- Low profile design keeps bundle close to mounting surface, saving space and providing greater protection for bundles in high vibration applications

- Supports Miniature and Intermediate cross section cable ties

B2. Cable Accessories

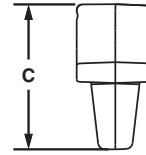
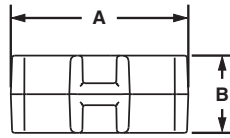

B3. Stainless Steel Ties

C1. Wiring Duct

C2. Surface Raceway

C3. Abrasion Protection

C4. Cable Management

Part Number	Used with Cable Ties	A Length		B Width		C Height		Maximum Panel Thickness		Panel Hole Diameter Range		Material	Color	Std. Pkg. Qty.	Std. Ctn. Qty.
		In.	mm	In.	mm	In.	mm	In.	mm	In.	mm				
ATM-W187-M	BT1.5M-XMR, PLT1.5M-XMR	0.80	20.5	0.35	9.0	0.58	14.6	0.12	3.0	0.17 – 0.20	4.3 – 4.9	Nylon 6.6	Natural	1000	5000
ATM-W187-M20													Black	1000	5000
ATM-W187-M30												Heat Stabilized Nylon 6.6	1000	5000	
ATM-W250-M										0.23 – 0.26	5.7 – 6.6	Nylon 6.6	Natural	1000	5000
ATM-W250-M20													Black	1000	5000
ATM-W250-M30												Heat Stabilized Nylon 6.6	1000	5000	

Auto Tie Mounts work with Reel-fed Cable Ties and Automatic Tooling. See page B1.115.

D1. Terminals

D2. Power Connectors

D3. Grounding Connectors

E1. Labeling Systems

E2. Labels

E3. Pre-Printed & Write-On Markers

E4. Permanent Identification

E5. Lockout/Tagout & Safety Solutions

F. Index



## Harness Board Fixtures

- Automatic alignment orients the tool head with the mount for reliable feeding of the cable through the mount to speed installation
- Multiple fixture configurations allow mounting in horizontal, vertical, or 45° orientation

- Integrated switch\* capability enables placement of a switch to detect the mount's presence providing an input to a quality control system
- Activation device on harness board fixture prevents tool from operating unless it is properly engaged in the fixture for operator safety

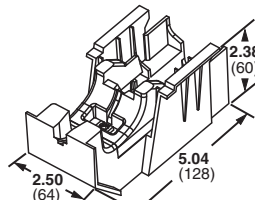

ATMB

Part Number	Description	Mounting	Color	Material	Std. Pkg. Qty.	Std. Ctn. Qty.
ATMB	Base	Screw base to harness board with 1/4" screws	Black	Acetal	—	10
ATMI-W187-X	Insert for ATM-W187 mount	Snaps into ATMB	Yellow		10	—
ATMI-W250-X	Insert for ATM-W250 mount	Snaps into ATMB	Red		10	—
ATMI-XMR-X	Used for cable tie installations where mounts are NOT required	Snaps into ATMB	Black		10	—
ATMC	Clamp used to secure the ATMB (base) in a vertical or 45° position	Screw clamp to harness board with 1/4" screws	Black	—	10	

\*The Omron Electronics D2SW-3L1HS switch is compatible with the ATM system. Similar switches from other manufacturers may also be suitable. See page B1.115 for Panduit Automatic Cable Tie Installation Systems.

## Physical Properties and Colors of Cable Accessory Materials<sup>‡</sup>

Design Criteria	Flame Retardant Nylon 6.6	Glass Filled Flame Retardant Nylon 6.6	General Purpose Polypropylene	Weather Resistant Polypropylene	General Purpose ABS	General Purpose ABS	Weather Resistant ABS	Flame Retardant Polypropylene	Acetal	PVC
<b>Color</b>	Black, Natural	Black	Black	Black	Black	Natural	Black	Black	Black	Gray, White
<b>Part Number Suffix</b>	60, 69	None	None/109	100	None	20	0	None	None	810
<b>UL Flammability – UL 94</b>	V-0	V-0	HB	HB	HB	HB	HB	V-0	HB	V-0
<b>Gamma Radiation Resistance</b>	1x10 <sup>5</sup> Rads	N/A	1x10 <sup>5</sup> Rads	1x10 <sup>5</sup> Rads	N/A	N/A	N/A	N/A	N/A	N/A
<b>Water Absorption</b>	1.1% (24 hrs.)	0.7% (24 hrs.)	0.1% (24 hrs.)	0.1% (24 hrs.)	0.3% (24 hrs.)	0.3% (24 hrs.)	0.3% (24 hrs.)	0.15% (24 hrs.)	0.43% (24 hrs.)	0.3% (24 hrs.)
<b>UV Resistance</b>	Poor	Poor	Poor	Good	Poor	Fair	Good	Good	Good	Poor
<b>Maximum Continuous Use Temperature</b>	230°F (110°C)	230°F (110°C)	221°F (105°C)	221°F (105°C)	185°F (85°C)	185°F (85°C)	185°F (85°C)	257°F (125°C)	194°F (90°C)	122°F (50°C)
<b>Minimum Continuous Use Temperature</b>	-40°F (-40°C)	-40°F (-40°C)	-40°F (-40°C)	-40°F (-40°C)	-40°F (-40°C)	-40°F (-40°C)	-40°F (-40°C)	-40°F (-40°C)	-40°F (-40°C)	-40°F (-40°C)

<sup>‡</sup>TEFZEL is a registered trademark of E.I. du Pont de Nemours and Company.

<sup>‡</sup>For more detail and additional materials, see Selection Chart on Pages B1.2 – B1.3.

## Application Chart

Since Panduit manufactures adhesive backed mounts with a variety of adhesive types, this chart should be used as a guideline for choosing the best adhesive for often-encountered conditions. Each type of adhesive is rated good, fair or poor for some specific mounting surfaces and/or chemical environments.

## Mount Spacing

To determine the number of mounts to use in a given application, the following formula can be used as a guideline:

$$\frac{\text{Cable or weight (Lbs./ft.)}}{\text{Static Load rating of Mount (Lbs./mt.)}} = \text{Spacing} \frac{\text{Mounts}}{\text{Ft.}}$$

Surfaces	Rubber Based Foam Tape Mounts	Acrylic Based Foam Tape Mounts	Epoxy Applied Adhesive Mounts
Plastics	Good	Good	Good
Wood	Good	Good	Good
Glass	Fair	Good	Good
Painted Surfaces	Good	Good	Fair
Powder Coating	Good	Fair	Good
Metal	Good <sup>1</sup>	Good <sup>1</sup>	Good
Paper	Good	Good	Fair
Concrete, Stone, Masonry	Not Recommended	Not Recommended	Good
Chemical Resistance			
Water	Good	Good	Poor
Oil	Poor	Fair <sup>3</sup>	Good
Gasoline	Poor	Fair <sup>3</sup>	Fair
Dilute Acids	Poor	Fair <sup>3</sup>	Fair
Dilute Alkalis	Good	Fair <sup>3</sup>	Fair
Organic Solvents	Poor	Fair <sup>3</sup>	Not Recommended
Outdoor Exposure	Not Recommended	Good	Good <sup>2</sup>

1. Not recommended for use on copper or brass.

2. Mounts manufactured from outdoor material only. For specific applications, individual testing prior to extensive use is suggested.

3. Depends on concentration, exposure time, and chemical composition.

A. System Overview

B1. Cable Ties

B2. Cable Accessories

B3. Stainless Steel Ties

C1. Wiring Duct

C2. Surface Raceway

C3. Abrasion Protection

C4. Cable Management

D1. Terminals

D2. Power Connectors

D3. Grounding Connectors

E1. Labeling Systems

E2. Labels

E3. Pre-Printed & Write-On Markers

E4. Permanent Identification

E5. Lockout/Tagout & Safety Solutions

F. Index

A.  
System  
Overview

## Selection and Use of Adhesive Mounts

B1.  
Cable Ties

Panduit adhesive mounts provide a quick, economical, and dependable method of supporting, routing, and protecting wires or cables. Some are used with Panduit cable ties and others can be used without cable ties.

B2.  
Cable  
Accessories

Adhesive backed mounts adhere to a variety of surfaces. This alternative to mechanical fasteners offers the advantage of lower installed cost with safe, easy to use, quality products.



B3.  
Stainless  
Steel Ties

### Applications

- To route wires in control panels and switchboards
- To support bundles of wires away from moving mechanical devices
- Routing and harnessing cables, both indoors and out, to prevent safety hazards
- To organize flat cables in many locations with low profile construction
- Ideal for supporting wire bundles where holes cannot be made in the substrate
- To separate groups of wires for identification



C1.  
Wiring  
Duct

C2.  
Surface  
Raceway

C3.  
Abrasion  
Protection

### General Mount Guidelines

Panduit pressure sensitive adhesive (foam tape) mounts are intended to secure wire bundles or other light objects to smooth surfaces. These mounts are not designed to support excessive loads and should not be used when the maximum expected load exceeds the rated capacity of the mount.

C4.  
Cable  
Management

D1.  
Terminals

### Choosing the Right Adhesive

Panduit offers two standard pressure sensitive foam tapes which are available on most adhesive backed wiring accessories products. The general purpose tape is produced with a rubber based adhesive and is identified by an “-A” in the part number. This tape develops its strength extremely fast and can be used in environments with temperatures ranging from -20°F (-29°C) to 120°F (49°C). It is recommended that rubber based adhesive mounts dwell 2 hours after installation, prior to loading. Rubber based adhesive tape is the best choice for most adhesive mount applications, including powder coated surfaces.

D2.  
Power  
Connectors

D3.  
Grounding  
Connectors

Acrylic based adhesive tape is also available and is identified by an “-AT” in the part number. This tape is for use in environments where continuous exposure to temperatures ranging from -20°F (-29°C) to 180°F (82°C) is possible. Acrylic based adhesive develops its maximum strength over a longer period of time than rubber based adhesive. It is recommended that acrylic adhesive mounts dwell 8 hours after installation, prior to loading. Acrylic based adhesive tape is a good choice for environments with exposure to UV rays or temperatures above 120°F (49°C).

E1.  
Labeling  
Systems

E2.  
Labels

Panduit adhesive backed cable accessories are also available pre-installed with high bond acrylic-based adhesive. This adhesive can be used in applications with continuous use temperatures ranging from -31°F (-35°C) to 200°F (93°C), though higher temperatures may be possible for short-term exposure. High Bond cable accessories are recommended for use in demanding applications such as where high temperatures are required, or where fatigue loading is expected.

E3.  
Pre-Printed  
& Write-On  
Markers

E4.  
Permanent  
Identification

Panduit also offers a 2-part epoxy for use in applications where excessive loading is required, or where the surface to which the mount must be applied is porous rather than smooth. Panduit EMA adhesive is a 2-part epoxy cement which is packaged in convenient mixer cups containing an equal amount of resin and hardener. Peel the protective covering off and pop the center of the cup in to form a mixing bowl. Each cup is supplied with a mixer stick and contains enough epoxy to properly apply three EMS mounts. The resin and hardener should be thoroughly mixed together until the epoxy is a consistent and uniform color. The mixer stick can then be used to apply the adhesive to the mount. The epoxy should be forced into the grooves on the bottom of the mount to obtain optimum bond performance. The mount should be applied to the surface with light pressure and a back-and-forth twisting motion. Hardening of the epoxy begins five minutes after mixing at room temperature.

E5.  
Lockout/  
Tagout  
& Safety  
Solutions

F.  
Index

## Selection and Use of Adhesive Mounts (continued)

### Surface Preparation

For best results, Panduit adhesive mounts should be applied to clean, dry, grease-free surfaces. We recommend that the surface be cleaned prior to mount installation. For rubber and acrylic based foam tape adhesives, a blend of isopropyl alcohol and water 50/50 may be used to clean most surfaces.

For epoxy type adhesives, especially masonry surfaces, be sure to clean all loose particles away before mount installation. Some surface abrasion is recommended to achieve maximum strength. A light rubbing with medium grit emery cloth or sandpaper is best. Wash after abrading.

### Proper Installation Techniques For Pressure Sensitive Adhesive Mounts

For proper installation of adhesive mounts with foam tape, simply remove the release liner and place the mount in the desired location. Avoid touching the adhesive prior to positioning the mount. Apply firm pressure to the mount for 5 seconds to insure proper adhesion.

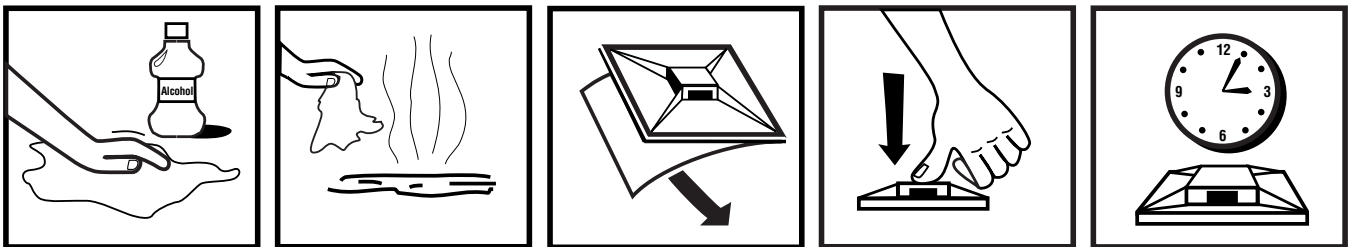

- 1) Clean surface with a clean cloth and isopropyl alcohol.
- 2) Allow surface to air dry.
- 3) Remove the release liner, being careful not to touch the adhesive.
- 4) Apply full thumb pressure for at least 5 seconds.
- 5) Allow mount to properly dwell.

### Proper Storage Conditions

All Panduit adhesive products have an expiration date printed on the package label. Use the following storage guidelines:

1. For rubber and acrylic based foam tape adhesives, store in temperatures of 70°F (21°C) and 45% Relative Humidity (R.H.).
2. For epoxy type adhesives, store in temperatures of 40°F (4°C) to 75°F (25°C) and relative humidity not in excess of 45%. Storage in opened containers is not recommended. Using the guidelines above, the shelf life of foam tape is 3 years. Shelf life of epoxy is 1 year. Deviation from the recommended storage conditions may reduce the shelf life or adhesive strength. In any case, adhesive products should never be stored near heating vents or other heat sources, and storage in lower temperatures than those recommended may increase the shelf life.

### Stock Rotation

Adhesive mount inventory should be rotated in order to insure the quality of the adhesive foam tape. Each package of Panduit adhesive backed mounts has a quality control number and a best-if-used-by date on the package label. The best-if-used-by date provides the customer with an accurate way to control the rotation of inventory, and, as is the case with all Panduit products, the quality control number provides complete traceability for all components that go into a specific production run of product.

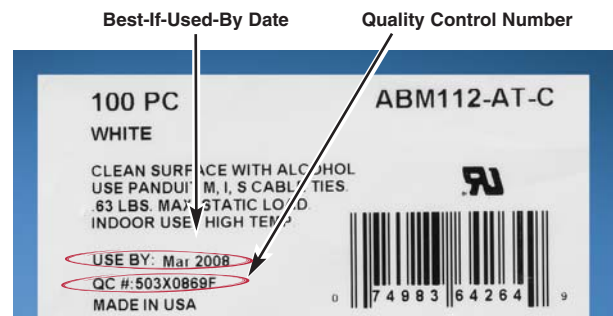

### Mount Removal

There is no simple or easy method for removing Panduit adhesives. A thin wire or razor blade can be moved in between the surfaces when removing foam tape mounts; however, the adhesive residue will remain on the surface. Epoxy adhesives may be removed with a commercial paint stripping solution.

A.  
System  
Overview

B1.  
Cable Ties

B2.  
Cable  
Accessories

B3.  
Stainless  
Steel Ties

C1.  
Wiring  
Duct

C2.  
Surface  
Raceway

C3.  
Abrasion  
Protection

C4.  
Cable  
Management

D1.  
Terminals

D2.  
Power  
Connectors

D3.  
Grounding  
Connectors

E1.  
Labeling  
Systems

E2.  
Labels

E3.  
Pre-Printed  
& Write-On  
Markers

E4.  
Permanent  
Identification

E5.  
Lockout/  
Tagout  
& Safety  
Solutions

F.  
Index

A.  
System  
Overview

B1.  
Cable Ties

B2.  
Cable  
Accessories

B3.  
Stainless  
Steel Ties

C1.  
Wiring  
Duct

C2.  
Surface  
Raceway

C3.  
Abrasion  
Protection

C4.  
Cable  
Management

D1.  
Terminals

D2.  
Power  
Connectors

D3.  
Grounding  
Connectors

E1.  
Labeling  
Systems

E2.  
Labels

E3.  
Pre-Printed  
& Write-On  
Markers

E4.  
Permanent  
Identification

E5.  
Lockout/  
Tagout  
& Safety  
Solutions

F.  
Index

## NOTES



## PAN-STEEL® SYSTEM

The Pan-Steel® System provides a strong, durable method of bundling and mechanical fastening, for all indoor, outdoor, and underground (including direct burial) applications. The ties are designed for use in critical applications where strength, vibration, radiation, weathering, corrosion and temperature extremes are a factor.

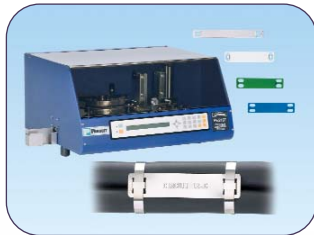
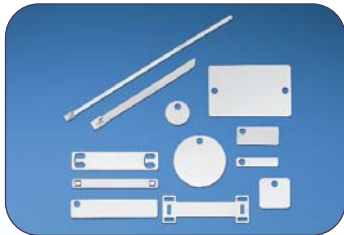
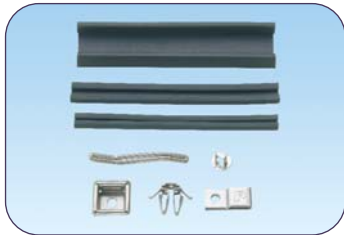
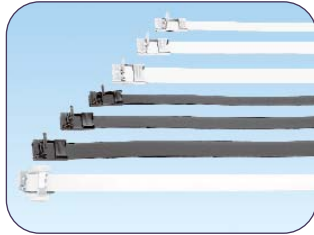
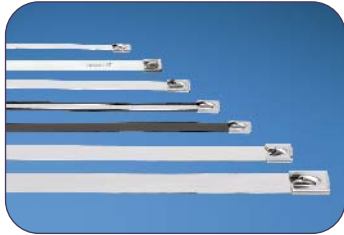

- Patented locking head design assures locking in any position, with a high rated loop tensile strength for a durable solution that delivers an extra margin of safety
- 201, 304, or 316 grade stainless steel provides a strong, long-lasting method of bundling and mechanical fastening in harsh environments
- Accessories available to protect, speed, and simplify the mounting of wires, cable, and tubing with Panduit® Pan-Steel® Stainless Steel Cable Ties
- Complete line of manual and powered installation tools available with controlled tension and automatic cut-off for lower installed cost
- Large selection of stainless steel marker plates, tags, and cable ties to deliver maximum design flexibility to match your specific application requirements; for details, refer to Permanent Identification Section E4

Panduit continues to develop stainless steel solutions for harsh environment applications by solving customer problems with innovative products and reliable tooling to achieve lowest installed cost.

A.  
System  
Overview

B1.  
Cable Ties

B2.  
Cable  
Accessories

B3.  
Stainless  
Steel Ties

C1.  
Wiring  
Duct

C2.  
Surface  
Raceway

C3.  
Abrasion  
Protection

C4.  
Cable  
Management

D1.  
Terminals

D2.  
Power  
Connectors

D3.  
Grounding  
Connectors

E1.  
Labeling  
Systems

E2.  
Labels

E3.  
Pre-Printed  
& Write-On  
Markers

E4.  
Permanent  
Identification

E5.  
Lockout/  
Tagout  
& Safety  
Solutions

F.  
Index

A.  
System  
Overview

## Pan-Steel® Products Overview

B1.  
Cable Ties

### Pan-Steel® Cable Ties

Pages B3.4 – B3.7, B3.11 – B3.13



- Designed for use in indoor, outdoor, and underground applications
- Self-locking head design speeds installation
- Strong, durable method of cable bundling
- Rounded edges assure cable protection and worker safety

B2.  
Cable  
Accessories

B3.  
Stainless  
Steel Ties

C1.  
Wiring  
Duct

C2.  
Surface  
Raceway

### Pan-Steel® Coated Cable Ties

Pages B3.8 – B3.9, B3.12 – B3.13



- Designed for use in indoor, outdoor, and underground applications
- Self-locking head design speeds installation
- Provides additional edge protection
- Prevents corrosion between dissimilar metals

C3.  
Abrasion  
Protection

C4.  
Cable  
Management

D1.  
Terminals

D2.  
Power  
Connectors

### Pan-Alum™ Cable Ties

Page B3.10

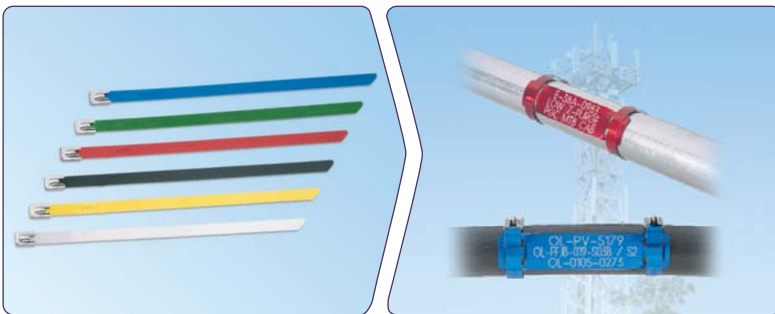

- Ideal for use in permanent identification and color-coding applications
- Five color options in addition to natural aluminum
- Lightweight construction for flexibility and ease of handling
- Used with aluminum marker plates for fast and easy installation

D3.  
Grounding  
Connectors

E1.  
Labeling  
Systems

E2.  
Labels

E3.  
Pre-Printed  
& Write-On  
Markers

### Pan-Steel® Retained Tension Ties

Pages B3.17 – B3.20

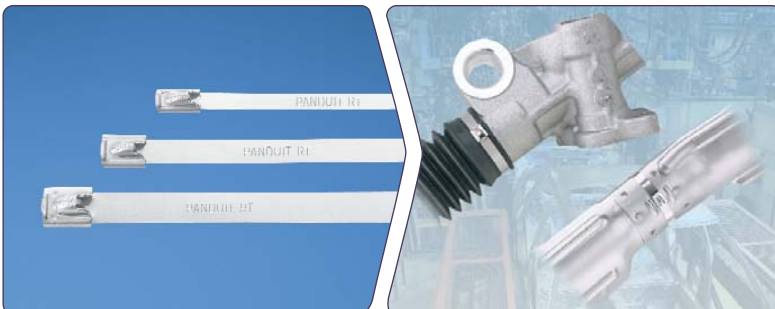

- Designed for use in Industrial, OEM, and Transportation Markets
- Provides tight bundling of armored cables, pipes, conduit and rigid materials
- Locks into place at any length along the tie body
- 360° seal design option eliminates gaps for a completely sealed installation

E4.  
Permanent  
Identification

E5.  
Lockout/  
Tagout  
& Safety  
Solutions

F.  
Index

## Pan-Steel® Products Overview (continued)

### Installation Tools

Pages B3.14 – B3.16, B3.20, B3.26



- Used in production, maintenance, and construction applications
- Full line of lightweight, ergonomic hand tools
- Highest reliability in the industry
- Flush cut-off of ties limits exposure to sharp edges

### Pan-Steel® Strapping

Pages B3.21 – B3.26



- Fold over design provides high retained tension
- Cut end is locked inside low profile buckle – no sharp edges
- Coil-in-box packaging option for job site versatility with minimum inventory
- Coated design option for additional edge protection

### Accessories

Pages B3.26 – B3.29

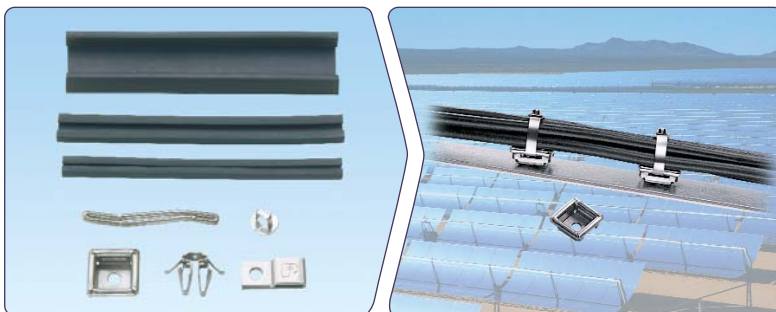

- Cushion sleeving provides full separation between ties and bundles
- Multiple mount options for range of applications and panel thicknesses
- Mounts secure ties to structure quickly and easily

### Permanent Identification Products

Pages E4.1 – E4.6



- Withstand the test of time and provide legibility in harsh environments
- Factory Custom Marking Service creates custom embossed or laser etched metal plates, tags, and ties
- Portable marking tools for quick and easy on-site identification
- Large selection delivers maximum design flexibility

A.  
System  
Overview

B1.  
Cable Ties

B2.  
Cable  
Accessories

B3.  
Stainless  
Steel Ties

C1.  
Wiring  
Duct

C2.  
Surface  
Raceway

C3.  
Abrasion  
Protection

C4.  
Cable  
Management

D1.  
Terminals

D2.  
Power  
Connectors

D3.  
Grounding  
Connectors

E1.  
Labeling  
Systems

E2.  
Labels

E3.  
Pre-Printed  
& Write-On  
Markers

E4.  
Permanent  
Identification

E5.  
Lockout/  
Tagout  
& Safety  
Solutions

F.  
Index

A. System Overview

## Features and Benefits – Pan-Steel® Cable Ties

Panduit® Pan-Steel® Stainless Steel Ties are engineered for safety, productivity, and durability by providing round edges and smooth surfaces, easy threading, high loop tensile strength and tight clamping.

B1. Cable Ties

B2. Cable Accessories

B3. Stainless Steel Ties

### Self-Locking Head Construction

**\*Aggressive locking head**  
Quicker locking, tighter installation

**Unique locking ramp**  
Assures locking in any position

**\*Lead in design**  
Wider entrance for easier threading

**Strengthening ribs**  
Stronger head increases lock strength

**\*Innovative displacement lock**  
Assures superior locking strength

**Extended retaining tab**  
Increases overall tie strength



\*Patented

C1. Wiring Duct

C2. Surface Raceway

C3. Abrasion Protection

C4. Cable Management

### Fully Rounded Edges

### Self-Locking for Fast Installation



Panduit tie body



Other manufacturer's tie body

The Pan-Steel® Stainless Steel Cable Tie features fully rounded edges to assure bundle protection and operator safety. Panduit not only removes the burr, but actually passes the material through a secondary process which removes the top and bottom corners of the material.



Self-locking design can be fastened by hand requiring no fold over or additional installation steps.



Pan-Steel® Installation Tools for adjustable tension control and automatic cut-off for quick, consistent, and secure installation.

D1. Terminals

D2. Power Connectors

D3. Grounding Connectors

E1. Labeling Systems

E2. Labels

E3. Pre-Printed & Write-On Markers

E4. Permanent Identification

E5. Lockout/Tagout & Safety Solutions

F. Index



Large selection of installation tools, the proper tool available to meet the requirements of every application. See pages B3.14 – B3.16.



Pan-Steel® System Accessories are used with Pan-Steel® Stainless Steel Cable Ties to speed and simplify the mounting of wires, cables, and tubing. Installation methods include screw mounts and push mounts. See pages B3.26 – B3.29.



Pan-Steel® Permanent Identification Solutions are designed for use with Panduit® Pan-Steel® Stainless Cable Ties and Pan-Alum™ Aluminum Cable Ties for quick and easy on-demand identification in harsh environments. See pages E4.1 – E4.6.

## Part Number System for Pan-Steel® Cable Ties

<b>MLT</b>	<b>6</b>	<b>S</b>	—	<b>CP</b>	
Type	Bundle Diameter Reference (In.)	Cross Section		Standard Package Size	Material
MLT = Metal Locking Tie		S = Standard LH = Light Heavy H = Heavy EH = Extra-Heavy EH15 = Extra-Heavy-15 SH = Super-Heavy		Q = 25 L* = 50 LP** = 50 CP = 100 *Standard Cross Section **Heavy Cross Section	(blank) = 304 316 = 316

### Pan-Steel® Self-Locking Cable Ties – MLT Series

- Self-locking head design speeds installation and locks into place at any length along the tie body
- Provides a strong, durable method of cable bundling
- Can be used in a wide range of indoor, outdoor, and underground (including direct burial) applications
- Smooth surfaces and rounded edges assures cable protection and worker safety
- Available in AISI 304 stainless steel for general-purpose applications
- Available in AISI 316 stainless steel for the most corrosive environments

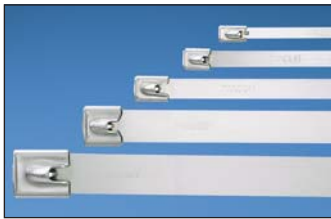

Part Number	Max. Bundle Diameter		Length*		Min. Loop Tensile Strength**		Min. Bundle Diameter		Width		Thickness		Recommended Installation Tool***	Std. Pkg. Qty.	Std. Ctn. Qty.
	In.	mm	In.	mm	Lbs.	N	In.	mm	In.	mm	In.	mm			

#### AISI 304 Stainless Steel – For General Purpose

##### Standard Cross Section

<b>MLT1S-CP</b>	1.0	25	5.0	127	200	890	0.50	12.7	0.18	4.6	0.010	0.25	GS4MT, HTMT, PPTMT, ST2MT	100	500
<b>MLT2S-CP</b>	2.0	51	7.9	201	200	890	0.50	12.7	0.18	4.6	0.010	0.25		100	500
<b>MLT2S-L</b>	2.0	51	7.9	201	200	890	0.50	12.7	0.18	4.6	0.010	0.25		50	500
<b>MLT2.7S-CP</b>	2.7	69	10.2	259	200	890	0.50	12.7	0.18	4.6	0.010	0.25		100	500
<b>MLT4S-CP</b>	4.0	102	14.3	362	200	890	0.50	12.7	0.18	4.6	0.010	0.25		100	500
<b>MLT4S-L</b>	4.0	102	14.3	362	200	890	0.50	12.7	0.18	4.6	0.010	0.25		50	500
<b>MLT6S-CP</b>	6.0	152	20.5	521	200	890	0.50	12.7	0.18	4.6	0.010	0.25		100	500
<b>MLT8S-CP</b>	8.0	203	26.8	679	200	890	0.50	12.7	0.18	4.6	0.010	0.25		100	500
<b>MLT10S-CP</b>	10.0	254	33.0	838	200	890	0.50	12.7	0.18	4.6	0.010	0.25		100	500
<b>MLT12S-Q</b>	12.0	304	39.3	998	200	890	0.50	12.7	0.18	4.6	0.010	0.25		25	125
<b>MLT14S-Q</b>	14.0	355	45.5	1156	200	890	0.50	12.7	0.18	4.6	0.010	0.25		25	125
<b>MLT15S-Q</b>	15.0	380	49.2	1250	200	890	0.50	12.7	0.18	4.6	0.010	0.25		25	125

\*Other lengths available, contact Panduit Customer Service.

\*\*Per SAE Standard AS23190/3 (formerly MIL). For additional details, refer to page B3.32.

\*\*\*For information on installation tools, refer to pages B3.14 – B3.16.

Table continued on page B3.6

A. System Overview



## Pan-Steel® Self-Locking Cable Ties – MLT Series (continued)

B1. Cable Ties

B2. Cable Accessories

B3. Stainless Steel Ties

C1. Wiring Duct

C2. Surface Raceway

C3. Abrasion Protection

C4. Cable Management

D1. Terminals

D2. Power Connectors

D3. Grounding Connectors

E1. Labeling Systems

E2. Labels

E3. Pre-Printed & Write-On Markers

E4. Permanent Identification

E5. Lockout/Tagout & Safety Solutions

F. Index

Part Number	Max. Bundle Diameter		Length*		Min. Loop Tensile Strength**		Min. Bundle Diameter		Width		Thickness		Recommended Installation Tool***	Std. Pkg. Qty.	Std. Ctn. Qty.
	In.	mm	In.	mm	Lbs.	N	In.	mm	In.	mm	In.	mm			
<b>Light-Heavy Cross Section</b>															
MLT2LH-LP	2.0	51	7.9	201	250	1112	0.50	12.7	0.25	6.4	0.010	0.25	GS4MT, HTMT, PPTMT, ST2MT	50	250
MLT4LH-LP	4.0	102	14.3	362	250	1112	0.50	12.7	0.25	6.4	0.010	0.25		50	250
MLT6LH-LP	6.0	152	20.5	521	250	1112	0.50	12.7	0.25	6.4	0.010	0.25		50	250
MLT8LH-LP	8.0	203	26.8	679	250	1112	0.50	12.7	0.25	6.4	0.010	0.25		50	250
<b>Heavy Cross Section</b>															
MLT2H-LP	2.0	51	7.9	201	450	2000	0.50	12.7	0.31	7.9	0.010	0.25	GS4MT, ST2MT, HTMT, PPTMT, PBTMT	50	250
MLT2.7H-LP	2.7	69	10.2	259	450	2000	0.50	12.7	0.31	7.9	0.010	0.25		50	250
MLT4H-LP	4.0	102	14.3	362	450	2000	0.50	12.7	0.31	7.9	0.010	0.25		50	250
MLT6H-LP	6.0	152	20.5	521	450	2000	0.50	12.7	0.31	7.9	0.010	0.25		50	250
MLT8H-LP	8.0	203	26.8	679	450	2000	0.50	12.7	0.31	7.9	0.010	0.25		50	250
MLT10H-LP	10.0	254	33.0	838	450	2000	0.50	12.7	0.31	7.9	0.010	0.25		50	250
MLT12H-Q	12.0	304	39.3	998	450	2000	0.50	12.7	0.31	7.9	0.010	0.25		25	125
MLT14H-Q	14.0	355	45.5	1156	450	2000	0.50	12.7	0.31	7.9	0.010	0.25		25	125
<b>Extra-Heavy Cross Section</b>															
MLT4EH-LP	4.0	102	17.1	434	600	2670	1.00	25.4	0.50	12.7	0.010	0.25	ST2MT, RT2HT, RT2HTN, PBTMT	50	250
MLT6EH-LP	6.0	152	23.4	594	600	2670	1.00	25.4	0.50	12.7	0.010	0.25		50	250
MLT8EH-LP	8.0	203	29.7	754	600	2670	1.00	25.4	0.50	12.7	0.010	0.25		50	250
MLT10EH-LP	10.0	254	35.9	912	600	2670	1.00	25.4	0.50	12.7	0.010	0.25		50	250
MLT12EH-Q	12.0	305	42.2	1072	600	2670	1.00	25.4	0.50	12.7	0.010	0.25		25	125
MLT4EH15-LP	4.0	102	17.1	434	700	3115	1.00	25.4	0.50	12.7	0.015	0.38		50	250
MLT6EH15-LP	6.0	152	23.4	594	700	3115	1.00	25.4	0.50	12.7	0.015	0.38		50	250
MLT8EH15-LP	8.0	203	29.7	754	700	3115	1.00	25.4	0.50	12.7	0.015	0.38		50	250
MLT10EH15-LP	10.0	254	35.9	912	700	3115	1.00	25.4	0.50	12.7	0.015	0.38		50	250
MLT12EH15-Q	12.0	305	42.2	1072	700	3115	1.00	25.4	0.50	12.7	0.015	0.38		25	125
<b>Super-Heavy Cross Section</b>															
MLT4SH-LP	4.0	102	17.1	434	900	4005	1.00	25.4	0.63	15.9	0.015	0.38	RT2HT, RT2HTN, PBTMT	50	250
MLT6SH-LP	6.0	152	23.4	594	900	4005	1.00	25.4	0.63	15.9	0.015	0.38		50	250
MLT8SH-LP	8.0	203	29.7	754	900	4005	1.00	25.4	0.63	15.9	0.015	0.38		50	250
MLT10SH-LP	10.0	254	35.9	912	900	4005	1.00	25.4	0.63	15.9	0.015	0.38		50	250
MLT12SH-Q	12.0	305	42.2	1072	900	4005	1.00	25.4	0.63	15.9	0.015	0.38		25	125
<b>AISI 316 Stainless Steel – For Superior Corrosion Resistance</b>															
<b>Standard Cross Section</b>															
MLT1S-CP316	1.0	25	5.0	127	200	890	0.50	12.7	0.18	4.6	0.010	0.25	GS4MT, HTMT, PPTMT, ST2MT	100	500
MLT2S-CP316	2.0	51	7.9	201	200	890	0.50	12.7	0.18	4.6	0.010	0.25		100	500
MLT2.7S-CP316	2.7	69	10.2	259	200	890	0.50	12.7	0.18	4.6	0.010	0.25		100	500
MLT4S-CP316	4.0	102	14.3	362	200	890	0.50	12.7	0.18	4.6	0.010	0.25		100	500
MLT6S-CP316	6.0	152	20.5	521	200	890	0.50	12.7	0.18	4.6	0.010	0.25		100	500
MLT8S-CP316	8.0	203	26.8	679	200	890	0.50	12.7	0.18	4.6	0.010	0.25		100	500
MLT10S-CP316	10.0	254	33.0	838	200	890	0.50	12.7	0.18	4.6	0.010	0.25	100	500	
<b>Light-Heavy Cross Section</b>															
MLT2LH-LP316	2.0	51	7.9	201	250	1112	0.50	12.7	0.25	6.4	0.010	0.25	GS4MT, HTMT, PPTMT, ST2MT	50	250
MLT4LH-LP316	4.0	102	14.3	362	250	1112	0.50	12.7	0.25	6.4	0.010	0.25		50	250
MLT6LH-LP316	6.0	152	20.5	521	250	1112	0.50	12.7	0.25	6.4	0.010	0.25		50	250
MLT8LH-LP316	8.0	203	26.8	679	250	1112	0.50	12.7	0.25	6.4	0.010	0.25		50	250

\*Other lengths available, contact Panduit Customer Service.  
 \*\*Per SAE Standard AS23190/3 (formerly MIL). For additional details, refer to page B3.32.  
 \*\*\*For information on installation tools, refer to pages B3.14 – B3.16.



## Pan-Steel® Self-Locking Cable Ties – MLT Series (continued)

Part Number	Max. Bundle Diameter		Length*		Min. Loop Tensile Strength**		Min. Bundle Diameter		Width		Thickness		Recommended Installation Tool***	Std. Pkg. Qty.	Std. Ctn. Qty.
	In.	mm	In.	mm	Lbs.	N	In.	mm	In.	mm	In.	mm			
<b>Heavy Cross Section</b>															
MLT2H-LP316	2.0	51	7.9	201	450	2000	0.50	12.7	0.31	7.9	0.010	0.25	GS4MT, ST2MT, HTMT, PPTMT, PBTMT	50	250
MLT2.7H-LP316	2.7	69	10.2	259	450	2000	0.50	12.7	0.31	7.9	0.010	0.25		50	250
MLT4H-LP316	4.0	102	14.3	362	450	2000	0.50	12.7	0.31	7.9	0.010	0.25		50	250
MLT6H-LP316	6.0	152	20.5	521	450	2000	0.50	12.7	0.31	7.9	0.010	0.25		50	250
MLT8H-LP316	8.0	203	26.8	679	450	2000	0.50	12.7	0.31	7.9	0.010	0.25		50	250
MLT10H-LP316	10.0	254	33.0	838	450	2000	0.50	12.7	0.31	7.9	0.010	0.25		50	250
<b>Extra-Heavy Cross Section</b>															
MLT4EH-LP316	4.0	102	17.1	434	600	2670	1.00	25.4	0.50	12.7	0.010	0.25	ST2MT, RT2HT, RT2HTN, PBTMT	50	250
MLT6EH-LP316	6.0	152	23.4	594	600	2670	1.00	25.4	0.50	12.7	0.010	0.25		50	250
MLT8EH-LP316	8.0	203	29.7	754	600	2670	1.00	25.4	0.50	12.7	0.010	0.25		50	250
MLT4EH15-LP316	4.0	102	17.1	434	700	3115	1.00	25.4	0.50	12.7	0.015	0.38		50	250
MLT6EH15-LP316	6.0	152	23.4	594	700	3115	1.00	25.4	0.50	12.7	0.015	0.38		50	250
MLT8EH15-LP316	8.0	203	29.7	754	700	3115	1.00	25.4	0.50	12.7	0.015	0.38		50	250
<b>Super-Heavy Cross Section</b>															
MLT4SH-LP316	4.0	102	17.1	434	900	4005	1.00	25.4	0.63	15.9	0.015	0.38	RT2HT, RT2HTN, PBTMT	50	250
MLT6SH-LP316	6.0	152	23.4	594	900	4005	1.00	25.4	0.63	15.9	0.015	0.38		50	250
MLT8SH-LP316	8.0	203	29.7	754	900	4005	1.00	25.4	0.63	15.9	0.015	0.38		50	250

\*Other lengths available, contact Panduit Customer Service.

\*\*Per SAE Standard AS23190/3 (formerly MIL). For additional details, refer to page B3.32.

\*\*\*For information on installation tools, refer to pages B3.14 – B3.16.

A.  
System  
Overview

B1.  
Cable Ties

B2.  
Cable  
Accessories

B3.  
Stainless  
Steel Ties

C1.  
Wiring  
Duct

C2.  
Surface  
Raceway

C3.  
Abrasion  
Protection

C4.  
Cable  
Management

D1.  
Terminals

D2.  
Power  
Connectors

D3.  
Grounding  
Connectors

E1.  
Labeling  
Systems

E2.  
Labels

E3.  
Pre-Printed  
& Write-On  
Markers

E4.  
Permanent  
Identification

E5.  
Lockout/  
Tagout  
& Safety  
Solutions

F.  
Index

A. System Overview

B1. Cable Ties

B2. Cable Accessories

B3. Stainless Steel Ties

C1. Wiring Duct

C2. Surface Raceway

C3. Abrasion Protection

C4. Cable Management

D1. Terminals

D2. Power Connectors

D3. Grounding Connectors

E1. Labeling Systems

E2. Labels

E3. Pre-Printed & Write-On Markers

E4. Permanent Identification

E5. Lockout/Tagout & Safety Solutions

F. Index

## Pan-Steel® Polyester Fully Coated Cable Ties – MLTFC Series

- Polyester coating available in six color options provides visual indication for easy identification in color-coding applications (heavy cross section only)
- Self-locking head design speeds installation and locks into place at any length along the tie body
- Polyester coating provides additional edge protection and prevents corrosion between dissimilar metals
- AISI 316 stainless steel for the most corrosive environments
- Available in standard, heavy, extra-heavy and super-heavy cross sections
- UV resistant, low smoke, halogen-free material
- Temperature tolerance -40°F (-40°C) to 302°F (150°C)

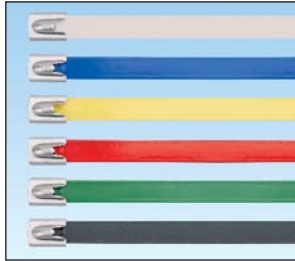

Part Number	Max. Bundle Diameter		Length*		Color	Min. Loop Tensile Strength**		Width		Thickness^		Recommended Installation Tool***	Std. Pkg. Qty.	Std. Ctn. Qty.
	In.	mm	In.	mm		Lbs.	N	In.	mm	In.	mm			
<b>Standard Cross Section^^</b>														
MLTFC2S-CP316	2.0	51	7.9	201	Black	100	445	0.18	4.6	0.010	0.25	GS4MT, HTMT, PPTMT, ST2MT	100	500
MLTFC4S-CP316	4.0	102	14.3	362	Black	100	445	0.18	4.6	0.010	0.25		100	500
MLTFC6S-CP316	6.0	152	20.5	521	Black	100	445	0.18	4.6	0.010	0.25		100	500
MLTFC8S-CP316	8.0	203	26.8	679	Black	100	445	0.18	4.6	0.010	0.25		100	500

<b>Heavy Cross Section^^</b>														
MLTFC2H-LP316RD	2.0	51	7.9	201	Red	250	1112	0.31	7.9	0.010	0.25	GS4MT, ST2MT, HTMT, PPTMT, PBTMT	50	250
MLTFC4H-LP316RD	4.0	102	14.3	362	Red	250	1112	0.31	7.9	0.010	0.25		50	250
MLTFC6H-LP316RD	6.0	152	20.5	521	Red	250	1112	0.31	7.9	0.010	0.25		50	250
MLTFC2H-LP316YL	2.0	51	7.9	201	Yellow	250	1112	0.31	7.9	0.010	0.25		50	250
MLTFC4H-LP316YL	4.0	102	14.3	362	Yellow	250	1112	0.31	7.9	0.010	0.25		50	250
MLTFC6H-LP316YL	6.0	152	20.5	521	Yellow	250	1112	0.31	7.9	0.010	0.25		50	250
MLTFC2H-LP316GR	2.0	51	7.9	201	Green	250	1112	0.31	7.9	0.010	0.25		50	250
MLTFC4H-LP316GR	4.0	102	14.3	362	Green	250	1112	0.31	7.9	0.010	0.25		50	250
MLTFC6H-LP316GR	6.0	152	20.5	521	Green	250	1112	0.31	7.9	0.010	0.25		50	250
MLTFC2H-LP316BU	2.0	51	7.9	201	Blue	250	1112	0.31	7.9	0.010	0.25		50	250
MLTFC4H-LP316BU	4.0	102	14.3	362	Blue	250	1112	0.31	7.9	0.010	0.25		50	250
MLTFC6H-LP316BU	6.0	152	20.5	521	Blue	250	1112	0.31	7.9	0.010	0.25		50	250
MLTFC2H-LP316WH	2.0	51	7.9	201	White	250	1112	0.31	7.9	0.010	0.25		50	250
MLTFC4H-LP316WH	4.0	102	14.3	362	White	250	1112	0.31	7.9	0.010	0.25		50	250
MLTFC6H-LP316WH	6.0	152	20.5	521	White	250	1112	0.31	7.9	0.010	0.25		50	250
MLTFC2H-LP316	2.0	51	7.9	201	Black	250	1112	0.31	7.9	0.010	0.25		50	250
MLTFC4H-LP316	4.0	102	14.3	362	Black	250	1112	0.31	7.9	0.010	0.25	50	250	
MLTFC6H-LP316	6.0	152	20.5	521	Black	250	1112	0.31	7.9	0.010	0.25	50	250	
MLTFC8H-LP316	8.0	203	26.8	679	Black	250	1112	0.31	7.9	0.010	0.25	50	250	

<b>Extra-Heavy Cross Section^^</b>														
MLTFC4EH-LP316	4.0	102	17.1	434	Black	300	1335	0.50	12.7	0.010	0.25	ST2MT, RT2HT, RT2HTN, PBTMT	50	250
MLTFC6EH-LP316	6.0	152	23.4	594	Black	300	1335	0.50	12.7	0.010	0.25		50	250
MLTFC8EH-LP316	8.0	203	29.7	754	Black	300	1335	0.50	12.7	0.010	0.25		50	250

<b>Super-Heavy Cross Section^^</b>														
MLTFC4SH-LP316	4.0	102	17.1	434	Black	450	2000	0.63	15.9	0.015	0.38	RT2HT, RT2HTN, PBTMT	50	250
MLTFC6SH-LP316	6.0	152	23.4	594	Black	450	2000	0.63	15.9	0.015	0.38		50	250
MLTFC8SH-LP316	8.0	203	29.7	754	Black	450	2000	0.63	15.9	0.015	0.38		50	250

\*Other lengths available, contact Panduit Customer Service.  
 \*\*Per SAE Standard AS23190/3 (formerly MIL). For additional details, refer to page B3.32.  
 \*\*\*For information on installation tools, refer to pages B3.14 – B3.16.  
 ^Base material less coating. ^^Minimum bundle diameter is .50"(12.7mm). ^^Minimum bundle diameter is 1.0"(25.4mm).



## Pan-Steel® Nylon 11 Selectively Coated Cable Ties – MLTC Series

- Self-locking head design speeds installation and locks into place at any length along the tie body
- Nylon 11 coating provides additional edge protection and prevents corrosion between dissimilar metals
- AISI 316 stainless steel for the most corrosive environments
- Available in heavy cross section
- UV resistant, low smoke, halogen-free material
- Temperature tolerance -40°F (-40°C) to 285°F (140°C)



Part Number	Max. Bundle Diameter		Length*		Min. Loop Tensile Strength**		Min. Bundle Diameter		Width		Thickness^		Recommended Installation Tool***	Std. Pkg. Qty.	Std. Ctn. Qty.
	In.	mm	In.	mm	Lbs.	N	In.	mm	In.	mm	In.	mm			
<b>AISI 316 Stainless Steel – For Nylon 11 Selectively Coated Cable Ties</b>															
<b>Heavy Cross Section</b>															
<b>MLTC2H-LP316</b>	2.0	51	7.9	201	250	1112	0.50	12.7	0.31	7.9	0.010	0.25	GS4MT, ST2MT, HTMT, PPTMT, PBTMT	50	250
<b>MLTC4H-LP316</b>	4.0	102	14.3	362	250	1112	0.50	12.7	0.31	7.9	0.010	0.25		50	250
<b>MLTC6H-LP316</b>	6.0	152	20.5	521	250	1112	0.50	12.7	0.31	7.9	0.010	0.25		50	250
<b>MLTC8H-LP316</b>	8.0	203	26.8	679	250	1112	0.50	12.7	0.31	7.9	0.010	0.25		50	250
<b>MLTC10H-LP316</b>	10.0	254	33.0	838	250	1112	0.50	12.7	0.31	7.9	0.010	0.25		50	250

\*Other lengths available, contact Panduit Customer Service.  
 \*\*Per SAE Standard AS23190/3 (formerly MIL). For additional details, refer to page B3.32.  
 \*\*\*For information on installation tools, refer to pages B3.14 – B3.16.  
 ^Base material less coating.

- A. System Overview
- B1. Cable Ties
- B2. Cable Accessories
- B3. Stainless Steel Ties
- C1. Wiring Duct
- C2. Surface Raceway
- C3. Abrasion Protection
- C4. Cable Management
- D1. Terminals
- D2. Power Connectors
- D3. Grounding Connectors
- E1. Labeling Systems
- E2. Labels
- E3. Pre-Printed & Write-On Markers
- E4. Permanent Identification
- E5. Lockout/Tagout & Safety Solutions
- F. Index

A. System Overview

## Pan-Alum™ Aluminum Cable Ties – MLT Series

B1. Cable Ties

- Self-locking head design speeds installation and locks into place at any length along the tie body
- Lightweight, aluminum construction for flexibility and ease of handling
- Five color options in addition to natural aluminum finish for color-coding applications
- Smooth surfaces and rounded edges assures cable protection and worker safety
- For use with Pan-Alum™ Marker Plates on page E4.5, for fast installation at the lowest installed cost

B2. Cable Accessories

B3. Stainless Steel Ties



C1. Wiring Duct

C2. Surface Raceway

C3. Abrasion Protection

C4. Cable Management

D1. Terminals

D2. Power Connectors

D3. Grounding Connectors

E1. Labeling Systems

E2. Labels

E3. Pre-Printed & Write-On Markers

E4. Permanent Identification

E5. Lockout/Tagout & Safety Solutions

F. Index

Part Number	Max. Bundle Diameter		Length		Color	Min. Loop Tensile Strength*		Min. Bundle Diameter		Width		Thickness		Recommended Installation Tool**	Std. Pkg. Qty.	Std. Ctn. Qty.
	In.	mm	In.	mm		Lbs.	N	In.	mm	In.	mm	In.	mm			
<b>MLT1H-LPALBL</b>	1.0	25	5.5	140	Black	50	222	0.50	12.7	0.31	7.9	0.012	0.03	ST2MT, HTMT	50	250
<b>MLT2H-LPALBL</b>	2.0	51	7.9	201	Black	50	222	0.50	12.7	0.31	7.9	0.012	0.03		50	250
<b>MLT4H-LPALBL</b>	4.0	102	14.3	362	Black	50	222	0.50	12.7	0.31	7.9	0.012	0.03		50	250
<b>MLT1H-LPALRD</b>	1.0	25	5.5	140	Red	50	222	0.50	12.7	0.31	7.9	0.012	0.03		50	250
<b>MLT2H-LPALRD</b>	2.0	51	7.9	201	Red	50	222	0.50	12.7	0.31	7.9	0.012	0.03		50	250
<b>MLT4H-LPALRD</b>	4.0	102	14.3	362	Red	50	222	0.50	12.7	0.31	7.9	0.012	0.03		50	250
<b>MLT1H-LPALYL</b>	1.0	25	5.5	140	Yellow	50	222	0.50	12.7	0.31	7.9	0.012	0.03		50	250
<b>MLT2H-LPALYL</b>	2.0	51	7.9	201	Yellow	50	222	0.50	12.7	0.31	7.9	0.012	0.03		50	250
<b>MLT4H-LPALYL</b>	4.0	102	14.3	362	Yellow	50	222	0.50	12.7	0.31	7.9	0.012	0.03		50	250
<b>MLT1H-LPALGR</b>	1.0	25	5.5	140	Green	50	222	0.50	12.7	0.31	7.9	0.012	0.03		50	250
<b>MLT2H-LPALGR</b>	2.0	51	7.9	201	Green	50	222	0.50	12.7	0.31	7.9	0.012	0.03		50	250
<b>MLT4H-LPALGR</b>	4.0	102	14.3	362	Green	50	222	0.50	12.7	0.31	7.9	0.012	0.03		50	250
<b>MLT1H-LPALBU</b>	1.0	25	5.5	140	Blue	50	222	0.50	12.7	0.31	7.9	0.012	0.03		50	250
<b>MLT2H-LPALBU</b>	2.0	51	7.9	201	Blue	50	222	0.50	12.7	0.31	7.9	0.012	0.03		50	250
<b>MLT4H-LPALBU</b>	4.0	102	14.3	362	Blue	50	222	0.50	12.7	0.31	7.9	0.012	0.03		50	250
<b>MLT1H-LPAL</b>	1.0	25	5.5	140	Aluminum	50	222	0.50	12.7	0.31	7.9	0.012	0.03		50	250
<b>MLT2H-LPAL</b>	2.0	51	7.9	201	Aluminum	50	222	0.50	12.7	0.31	7.9	0.012	0.03		50	250
<b>MLT4H-LPAL</b>	4.0	102	14.3	362	Aluminum	50	222	0.50	12.7	0.31	7.9	0.012	0.03		50	250

\*Per SAE Standard AS23190/3 (formerly MIL). For additional details, refer to page B3.32.

\*\*For information on installation tools, refer to page B3.15.

## Pan-Steel® Double Wrapped Cable Ties – MLTD Series

- Self-locking head design speeds installation and locks into place at any length along the tie body
- Cable tie body passes through the head two times for additional strength
- Available in heavy, extra-heavy, and super-heavy cross sections
- Available in AISI 304 stainless steel for general-purpose applications
- Available in AISI 316 stainless steel for the most corrosive environments
- Super-heavy double wrapped tested for short circuit applications up to 71.5 kA

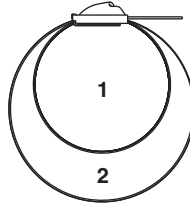

Part Number	Max. Bundle Diameter		Length*		Min. Loop Tensile Strength**		Min. Bundle Diameter		Width		Thickness		Recommended Installation Tool***	Std. Pkg. Qty.	Std. Ctn. Qty.
	In.	mm	In.	mm	Lbs.	N	In.	mm	In.	mm	In.	mm			

### AISI 304 Stainless Steel – MLTD Double Wrapped Ties

#### Heavy Cross Section

<b>MLT2DH-L</b>	2.0	51	18.5	470	600	2670	1.00	25.4	0.31	7.9	0.010	0.25	GS4MT, HTMT, PPTMT, ST2MT	50	250
<b>MLT4DH-L</b>	4.0	102	28.0	711	600	2670	1.00	25.4	0.31	7.9	0.010	0.25		50	250
<b>MLT5DH-L</b>	5.0	127	34.0	863	600	2670	1.00	25.4	0.31	7.9	0.010	0.25		50	250
<b>MLT6DH-Q</b>	6.0	152	40.0	1016	600	2670	1.00	25.4	0.31	7.9	0.010	0.25		25	250

#### Extra-Heavy Cross Section

<b>MLT4DEH-Q</b>	4.0	102	29.5	749	800	3560	1.00	25.4	0.50	12.7	0.010	0.25	ST2MT, RT2HT, RT2HTN, PBTMT	25	125
<b>MLT6DEH-Q</b>	6.0	152	41.5	1054	800	3560	1.00	25.4	0.50	12.7	0.010	0.25		25	125
<b>MLT8DEH-Q</b>	8.0	203	53.5	1359	800	3560	1.00	25.4	0.50	12.7	0.010	0.25		25	125
<b>MLT4DEH15-Q</b>	4.0	102	29.5	749	1000	4450	1.00	25.4	0.50	12.7	0.015	0.38		25	125
<b>MLT6DEH15-Q</b>	6.0	152	41.5	1054	1000	4450	1.00	25.4	0.50	12.7	0.015	0.38		25	125
<b>MLT8DEH15-Q</b>	8.0	203	53.5	1359	1000	4450	1.00	25.4	0.50	12.7	0.015	0.38		25	125

#### Super-Heavy Cross Section

<b>MLT4DSH-Q</b>	4.0	102	29.5	749	1200	5340	1.00	25.4	0.62	15.9	0.015	0.38	RT2HT, RT2HTN, PBTMT	25	125
<b>MLT6DSH-Q</b>	6.0	152	41.5	1054	1200	5340	1.00	25.4	0.62	15.9	0.015	0.38		25	125
<b>MLT8DSH-Q</b>	8.0	203	53.5	1359	1200	5340	1.00	25.4	0.62	15.9	0.015	0.38		25	125

### AISI 316 Stainless Steel – For MLTD Double Wrapped Ties

#### Extra-Heavy Cross Section

<b>MLT4DEH-Q316</b>	4.0	102	29.5	749	800	3560	1.00	25.4	0.50	12.7	0.010	0.25	ST2MT, RT2HT, RT2HTN, PBTMT	25	125
<b>MLT6DEH-Q316</b>	6.0	152	41.5	1054	800	3560	1.00	25.4	0.50	12.7	0.010	0.25		25	125
<b>MLT8DEH-Q316</b>	8.0	203	53.5	1359	800	3560	1.00	25.4	0.50	12.7	0.010	0.25		25	125
<b>MLT4DEH15-Q316</b>	4.0	102	29.5	749	1000	4450	1.00	25.4	0.50	12.7	0.015	0.38		25	125
<b>MLT6DEH15-Q316</b>	6.0	152	41.5	1054	1000	4450	1.00	25.4	0.50	12.7	0.015	0.38		25	125
<b>MLT8DEH15-Q316</b>	8.0	203	53.5	1359	1000	4450	1.00	25.4	0.50	12.7	0.015	0.38		25	125

#### Super-Heavy Cross Section

<b>MLT4DSH-Q316</b>	4.0	102	29.5	749	1200	5340	1.00	25.4	0.63	15.9	0.015	0.38	RT2HT, RT2HTN, PBTMT	25	125
<b>MLT6DSH-Q316</b>	6.0	152	41.5	1054	1200	5340	1.00	25.4	0.63	15.9	0.015	0.38		25	125
<b>MLT8DSH-Q316</b>	8.0	203	53.5	1359	1200	5340	1.00	25.4	0.63	15.9	0.015	0.38		25	125

\*Other lengths available, contact Panduit Customer Service.

\*\*Per SAE Standard AS23190/3 (formerly MIL). For additional details, refer to page B3.32.

\*\*\*For information on installation tools, refer to pages B3.14 – B3.16.

A.  
System  
Overview

B1.  
Cable Ties

B2.  
Cable  
Accessories

B3.  
Stainless  
Steel Ties

C1.  
Wiring  
Duct

C2.  
Surface  
Raceway

C3.  
Abrasion  
Protection

C4.  
Cable  
Management

D1.  
Terminals

D2.  
Power  
Connectors

D3.  
Grounding  
Connectors

E1.  
Labeling  
Systems

E2.  
Labels

E3.  
Pre-Printed  
& Write-On  
Markers

E4.  
Permanent  
Identification

E5.  
Lockout/  
Tagout  
& Safety  
Solutions

F.  
Index

A. System Overview

## Pan-Steel® Custom Length Banding – MBS, MBH, MBEH and MBSH Series

B1. Cable Ties

- For applications that require various bundle diameters
- Supplied in reels of 82.50 feet (25.0m), 200.00 feet (60.9m), 250.00 feet (76.2m) or 1000.00 feet (304.8m)
- Provides job site versatility with minimum inventory
- Packaging speeds removal of steel and includes bundle diameter cut-off guide

### Polyester coating (optional):

- Polyester coating provides additional edge protection and prevents corrosion between dissimilar metals
- UV resistant, low smoke, halogen-free material
- Temperature tolerance -40°F (-40°C) to 302°F (150°C)
- AISI 316 stainless steel for the most corrosive environments

B2. Cable Accessories

B3. Stainless Steel Ties



C1. Wiring Duct

C2. Surface Raceway

C3. Abrasion Protection

C4. Cable Management

D1. Terminals

D2. Power Connectors

D3. Grounding Connectors

E1. Labeling Systems

E2. Labels

E3. Pre-Printed & Write-On Markers

E4. Permanent Identification

E5. Lockout/Tagout & Safety Solutions

F. Index

**KNOCK-OUT HANDLE LOCATION (BOTH SIDES)**

**METRIC MEASURE**

**DIAMETER CUT-OFF GUIDE**

**FOLD OVER RETAINER TAB**

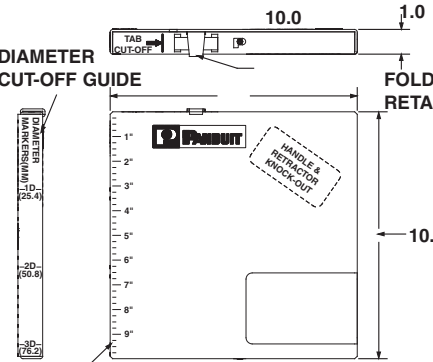
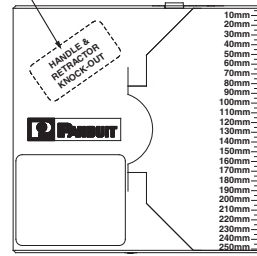

**ENGLISH MEASURE**

Part Number	Max. Bundle Diameter		Length*		Min. Loop Tensile Strength**		Min. Bundle Diameter		Width		Thickness^		Recommended Installation Tool***	Recommended Banding Head	Std. Pkg. Qty.‡
	In.	mm	Ft.	m	Lbs.	N	In.	mm	In.	mm	In.	mm			

### AISI 304 Stainless Steel — For General Purpose Banding

#### Standard Cross Section

<b>MBS-TLR</b>	Any	Any	250	76	100	445	0.50	12.7	0.18	4.4	0.010	0.25	GS4MT, ST2MT, HTMT, PPTMT	MTHS-C	1
<b>MBS-MR</b>	Any	Any	1000	305	100	445	0.50	12.7	0.18	4.4	0.010	0.25	GS4MT, ST2MT, HTMT, PPTMT	MTHS-C	1

#### Heavy Cross Section

<b>MBH-TLR</b>	Any	Any	250	76	250	1112	0.50	12.7	0.31	7.9	0.010	0.25	GS4MT, ST2MT, HTMT, PPTMT, PBTMT	MTHH-C	1
<b>MBH-MR</b>	Any	Any	1000	305	250	1112	0.50	12.7	0.31	7.9	0.010	0.25		MTHH-C	1

#### Extra-Heavy Cross Section

<b>MBEH-TLR</b>	Any	Any	250	76	300	1335	1.00	25.4	0.50	12.7	0.010	0.25	ST2MT, RT2HT, RT2HTN, PBTMT	MTHEH-C	1
-----------------	-----	-----	-----	----	-----	------	------	------	------	------	-------	------	-----------------------------	---------	---

#### Super-Heavy Cross Section

<b>MBSH-TR</b>	Any	Any	200	61	450	2000	1.00	25.4	0.63	15.9	0.015	0.38	RT2HT, RT2HTN, PBTMT	MTHSH-C	1
----------------	-----	-----	-----	----	-----	------	------	------	------	------	-------	------	----------------------	---------	---

### AISI 316 Stainless Steel — For Superior Corrosion Resistance

#### Standard Cross Section

<b>MBS-TLR316</b>	Any	Any	250	76	100	445	0.50	12.7	0.18	4.4	0.010	0.25	GS4MT, ST2MT, HTMT, PPTMT	MTHS-C316	1
<b>MBS-MR316</b>	Any	Any	1000	305	100	445	0.50	12.7	0.18	4.4	0.010	0.25	GS4MT, ST2MT, HTMT, PPTMT	MTHS-C316	1

#### Heavy Cross Section

<b>MBH-TLR316</b>	Any	Any	250	76	250	1112	0.50	12.7	0.31	7.9	0.010	0.25	GS4MT, ST2MT, HTMT, PPTMT, PBTMT	MTHH-C316	1
<b>MBH-MR316</b>	Any	Any	1000	305	250	1112	0.50	12.7	0.31	7.9	0.010	0.25		MTHH-C316	1

#### Extra-Heavy Cross Section

<b>MBEH-TLR316</b>	Any	Any	250	76	300	1335	1.00	25.4	0.50	12.7	0.010	0.25	ST2MT, RT2HT, RT2HTN, PBTMT	MTHEH-C316	1
--------------------	-----	-----	-----	----	-----	------	------	------	------	------	-------	------	-----------------------------	------------	---

#### Super-Heavy Cross Section

<b>MBSH-TR316</b>	Any	Any	200	61	450	2000	1.00	25.4	0.63	15.9	0.015	0.38	RT2HT, RT2HTN, PBTMT	MTHSH-C316	1
-------------------	-----	-----	-----	----	-----	------	------	------	------	------	-------	------	----------------------	------------	---

\*Other lengths available, contact Panduit Customer Service.

\*\*Per SAE Standard AS23190/3 (formerly MIL). For additional details, refer to page B3.32.

\*\*\*For information on installation tools, refer to pages B3.14 – B3.16.

^Base material less coating

‡Order in number of reels required.

## Pan-Steel® Custom Length Banding – MBS, MBH, MBEH and MBSH Series

Part Number	Max. Bundle Diameter		Length*		Min. Loop Tensile Strength**		Min. Bundle Diameter		Width		Thickness^		Recommended Installation Tool***	Recommended Banding Head	Std. Pkg. Qty.‡
	In.	mm	Ft.	m	Lbs.	N	In.	mm	In.	mm	In.	mm			
<b>Polyester Coated AISI 316 Stainless Steel</b>															
<b>Heavy Cross Section</b>															
<b>MBCH-QR316</b>	Any	Any	82	25	250	1112	0.50	12.7	0.31	7.9	0.010	0.25	GS4MT, ST2MT, HTMT, PPTMT, PBTMT	MTHCH-C316	1
<b>Extra-Heavy Cross Section</b>															
<b>MBCEH-QR316</b>	Any	Any	82	25	300	1335	1.00	25.4	0.50	12.7	0.010	0.25	ST2MT, RT2HT, RT2HTN, PBTMT	MTHCEH-C316	1
<b>Super-Heavy Cross Section</b>															
<b>MBCSH-QR316</b>	Any	Any	82	25	450	2000	1.00	25.4	0.63	15.9	0.015	0.38	RT2HT, RT2HTN, PBTMT	MTHCSH-C316	1

\*Other lengths available, contact Panduit Customer Service.  
 \*\*Per SAE Standard AS23190/3 (formerly MIL). For additional details, refer to page B3.32.  
 \*\*\*For information on installation tools, refer to pages B3.14 – B3.16.  
 ^Base material less coating  
 ‡Order in number of reels required.

*To determine the proper amount of banding required, use the following formula:*

<b>Calculate S and H Cross Section</b>	Diameter inches (mm) x 3.14 + 3 inches (76mm)
<b>Calculate EH and SH Cross Section</b>	Diameter inches (mm) x 3.14 + 4.5 inches (114mm)

## Pan-Steel® Custom Length Banding Heads – MTH Series

- Self-locking head design speeds installation and locks into place at any length along the tie body



Part Number	Part Description	Std. Pkg. Qty.	Std. Ctn. Qty.
<b>AISI 304 Stainless Steel</b>			
<b>MTHS-C</b>	Loose piece banding head for standard cross section banding.	100	1000
<b>MTHH-C</b>	Loose piece banding head for heavy cross section banding.	100	1000
<b>MTHEH-C</b>	Loose piece banding head for extra-heavy cross section banding.	100	1000
<b>MTHSH-C</b>	Loose piece banding head for super-heavy cross section banding.	100	1000
<b>AISI 316 Stainless Steel</b>			
<b>MTHS-C316</b>	Loose piece banding head for standard cross section banding.	100	1000
<b>MTHH-C316</b>	Loose piece banding head for heavy cross section banding.	100	1000
<b>MTHEH-C316</b>	Loose piece banding head for extra-heavy cross section banding.	100	1000
<b>MTHSH-C316</b>	Loose piece banding head for super-heavy cross section banding.	100	1000
<b>AISI 316 Coated Stainless Steel</b>			
<b>MTHCH-C316</b>	Loose piece coated banding head for heavy cross section banding.	100	1000
<b>MTHCEH-C316</b>	Loose piece coated banding head for extra-heavy cross section banding.	100	1000
<b>MTHCSH-C316</b>	Loose piece coated banding head for super-heavy cross section banding.	100	1000



1) Take one end of the cut banding and bend back 1/2" (13mm).



2) Take a self-locking head and slide it the entire length of the band until it reaches the bend.



3) Bend tail flat against bottom of banding head to complete assembly.

A.  
System  
Overview

## GS4MT Hand Operated Installation Tool

B1.  
Cable Ties

- Single handle operation for fast installation
- Cable tie side entry for immediate positioning of tie and tool
- Controlled tension, fully adjustable
- Easy removal of excess tie

- Qualified product listed per MIL Standard MS90387-3
- Automatically tensions and cuts off tie when predetermined tension is reached
- Installs standard .18 inch (4.6mm), light-heavy .25 inch (6.4mm) and heavy .31 inch (7.9mm) cross section ties

B2.  
Cable  
Accessories

B3.  
Stainless  
Steel Ties



GS4MT

Part Number	Part Description	Std. Pkg. Qty.
<b>GS4MT</b>	Used with standard, light-heavy, and heavy cross section Pan-Steel® type MLT ties, type MLTC/MLTFC coated ties, and type MLTDH double wrapped ties.	1
<b>K4M-BLD</b>	Replacement cutter blade for GS4MT.	1
<b>K4MTG</b>	Replacement tension gripper for GS4MT.	1
<b>CAMT</b>	Cut-off accessory. Use this accessory with GS4MT tool to cut MBH or MBS continuous banding. Accessory drops in place for use.	1

C1.  
Wiring  
Duct

C2.  
Surface  
Raceway

C3.  
Abrasion  
Protection

C4.  
Cable  
Management



Side Entry



CAMT

D1.  
Terminals

D2.  
Power  
Connectors

## Tool Tension Locking Kits

- For applications requiring a locking device on either the selector knob (one cross section size and tension only) or tension level adjustment (but allow cross section size changes)

D3.  
Grounding  
Connectors

E1.  
Labeling  
Systems



Part Number	Part Description	Std. Pkg. Qty.
<b>TTLK3</b>	Tool tension locking kit for GS4MT and PPTMT installation tools.	1

E2.  
Labels

To lock selector knob and tension level.

E3.  
Pre-Printed  
& Write-On  
Markers



E4.  
Permanent  
Identification

To lock fine adjustment.

E5.  
Lockout/  
Tagout  
& Safety  
Solutions

F.  
Index

## ST2MT Installation Tool

- Cable tie side entry for immediate positioning of tie and tool
- One hand operation – lightweight
- Easy removal of excess tie
- Tool tension is controlled by installer – twist action cut-off
- Rugged, lightweight, easy-to-operate pliers-type tool provides mechanical advantage



Part Number	Part Description	Std. Pkg. Qty.
ST2MT	Used with standard, light-heavy, heavy and extra-heavy cross section Pan-Steel® type MLT ties, type MLTC/MLTFC coated ties, and type MLTDH double wrapped ties.	1

## RT2HT and RT2HTN Installation Tools

- Cable tie side entry for immediate positioning of tie and tool to speed installation
- Multi-position rear handle provides flexibility for a one or two hand installation
- Narrow nose tool design option available for applications requiring installations in tight confined spaces
- Replacement cutter blade and handle available for RT2HT



RT2HT



RT2HTN

Part Number	Part Description	Std. Pkg. Qty.
RT2HT	Used with extra-heavy, extra-heavy 15, and super-heavy cross section Pan-Steel® type MLT and MLTFC ties. Width of tool nose 2.60" (66.0mm).	1
RT2HTN	Narrow nose installation tool for use with extra-heavy, extra-heavy 15, and super-heavy cross section Pan-Steel® type MLT and MLTFC ties. Width of tool nose 1.06" (27.0mm).	1

## HTMT Installation Tool

- Economical
- Coiled tie end remaining after tensioning assures a safe end
- Manual tension, no cut-off
- Installs ties parallel to the bundle



Part Number	Part Description	Std. Pkg. Qty.
HTMT	Used with standard, light-heavy, and heavy cross section Pan-Steel® type MLT ties, type MLTC/MLTFC coated ties, and type MLTDH double wrapped ties.	1

A.  
System  
Overview

B1.  
Cable Ties

B2.  
Cable  
Accessories

B3.  
Stainless  
Steel Ties

C1.  
Wiring  
Duct

C2.  
Surface  
Raceway

C3.  
Abrasion  
Protection

C4.  
Cable  
Management

D1.  
Terminals

D2.  
Power  
Connectors

D3.  
Grounding  
Connectors

E1.  
Labeling  
Systems

E2.  
Labels

E3.  
Pre-Printed  
& Write-On  
Markers

E4.  
Permanent  
Identification

E5.  
Lockout/  
Tagout  
& Safety  
Solutions

F.  
Index

A. System Overview

## PPTMT Pneumatic Installation Tool

B1. Cable Ties

- Power assisted tool for fast and effortless installation
- Cable tie side entry for immediate positioning of tie and tool
- Controlled tension, fully adjustable
- Automatic cut-off
- One hand operation – lightweight
- Easy removal of excess tie
- Operates 85 PSI (586 KPA Bar) non-lubricated air and requires no special maintenance

B2. Cable Accessories

B3. Stainless Steel Ties



PPTMT

Part Number	Part Description	Std. Pkg. Qty.
<b>PPTMT</b>	Pneumatic hand tool used with Pan-Steel® type MLT ties, type MLTC/MLTFC coated ties, and type MLTDH double wrapped ties. Automatically tensions and cuts off tie when predetermined tension is reached, providing more reliable and consistent installations. Ideal for high production applications. Installs standard .18" (4.6mm), light-heavy .25" (6.4mm), and heavy .31" (7.9mm) cross section ties.	1
<b>PPH10</b>	10.0' (3m) hose assembly (regulator to tool); includes a .13" (3.3mm) NPT male connector (to regulator) and .13" (3.3mm) female quick disconnect (to tool).	1
<b>PL289N1</b>	Filter/regulator .5 micron element, regulated range 3 – 100 psig, features .13" (3.3mm) NPT female output port (to hose PPH10) and .25" (6.4mm) male quick disconnect to source air line.	1
<b>KPPTMTG</b>	Replacement gripper kit for PPTMT.	1
<b>KPPTMTB</b>	Replacement blade kit for PPTMT.	1

C1. Wiring Duct

C2. Surface Raceway

C3. Abrasion Protection

C4. Cable Management

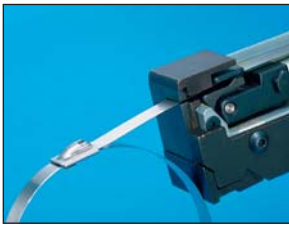

Side Entry

D1. Terminals

D2. Power Connectors

D3. Grounding Connectors

E1. Labeling Systems

E2. Labels

E3. Pre-Printed & Write-On Markers

E4. Permanent Identification

E5. Lockout/Tagout & Safety Solutions

F. Index

## **NEW!** PBTMT Battery Powered Installation Tool

- Lithium-Ion battery optimizes performance by installing more cable ties per charge
- Ergonomic tool design provides a compact lightweight body, reducing operator fatigue
- Automatic flush cut off enhances productivity with easy one hand installation
- Cable tie side entry allows quick side entry of tie into tool to speed installation
- 360° rotating head allows access to confined spaces
- Controlled tension mechanism provides consistent installations every time
- Battery indicator improves productivity with quick visual identification of battery life
- Variable speed trigger provides increased operator control, for easy installation



PBTMT

Part Number	Part Description	Std. Pkg. Qty.
<b>PBTMT</b>	Battery powered installation tool, for use with Pan-Steel® heavy, extra-heavy, and super-heavy cross section MLT style ties, and MLTD double wrapped style ties, 2 – 12 volt Lithium-Ion batteries and 115 volt, 60 Hz charger included.	1



360° Rotating Head



## Features and Benefits – Pan-Steel® Retained Tension Ties – MRT/MRS Series

Panduit® Pan-Steel® Retained Tension Ties are engineered for safety, productivity, and durability by providing round edges and smooth surfaces, easy threading, high loop tensile strength and tight clamping.

### Panduit Retained Tension Tie Technology

#### Features of Retained Tension Ties (MRT and MRS Series)

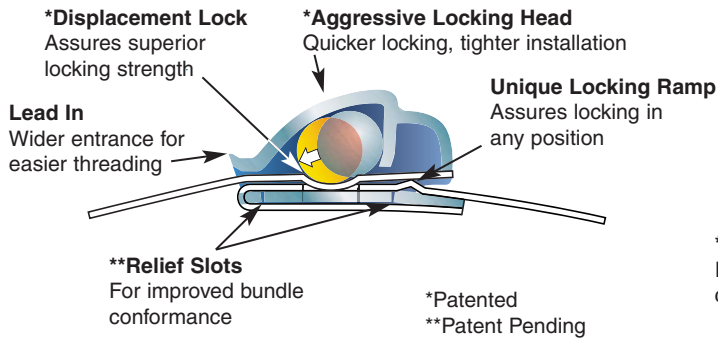

#### Additional Features of 360° Radial Seal Retained Tension Ties (MRS Series Only)



### Retained Tension Performance Comparison\*\*



\*\*Representative sample, actual results may vary.

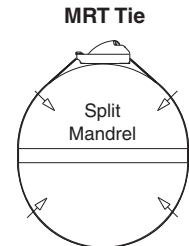

**Retained Tension**  
Split mandrel test fixture measures retained tension of installed tie

- A. System Overview
- B1. Cable Ties
- B2. Cable Accessories
- B3. Stainless Steel Ties
- C1. Wiring Duct
- C2. Surface Raceway
- C3. Abrasion Protection
- C4. Cable Management
- D1. Terminals
- D2. Power Connectors
- D3. Grounding Connectors
- E1. Labeling Systems
- E2. Labels
- E3. Pre-Printed & Write-On Markers
- E4. Permanent Identification
- E5. Lockout/Tagout & Safety Solutions
- F. Index

A.  
System  
Overview

## Part Number System for Pan-Steel® Retained Tension Ties – MRT Series

B1.  
Cable Ties

**MRT**

Type

MRT = Metal Retained  
Tension Tie

**6**

Bundle Diameter Reference  
(In.)

**S**

Cross Section

S = Standard  
LH = Light-Heavy  
H = Heavy

—

**C**

Package Qty.

L = 50  
C = 100

**4**

Material

4 = 304

B2.  
Cable  
Accessories

B3.  
Stainless  
Steel Ties



## Pan-Steel® Retained Tension Ties – MRT Series

- Provide tight bundling of armored cables, pipes, conduit and other rigid materials in harsh conditions for a reliable, easy to install fastening solution

- Self-locking cable tie design locks into place at any length along the tie body, unlike fixed diameter band clamps
- Available in AISI 304 stainless steel with a thickness of 0.010" (0.25mm)



C1.  
Wiring  
Duct

C2.  
Surface  
Raceway

C3.  
Abrasion  
Protection

C4.  
Cable  
Management

D1.  
Terminals

Part Number	Max. Bundle Diameter		Length		Min. Loop Tensile Strength		Min. Bundle Diameter		Width		Recommended Installation Tool***	Std. Pkg. Qty.	Std. Ctn. Qty.
	In.	mm	In.	mm	Lbs.	N	In.	mm	In.	mm			

### AISI 304 Stainless Steel – For General Purpose

#### Standard Cross Section

<b>MRT1S-C4</b>	1.0	25	9.0	229	180	800	0.75	19.1	0.18	4.4	MTRTLS	100	500
<b>MRT2S-C4</b>	2.0	51	12.2	310	180	800	0.75	19.1	0.18	4.4		100	500
<b>MRT4S-C4</b>	4.0	102	18.5	470	180	800	0.75	19.1	0.18	4.4		100	500
<b>MRT6S-C4</b>	6.0	152	24.8	630	180	800	0.75	19.1	0.18	4.4		100	500

#### Light-Heavy Cross Section

<b>MRT1.5LH-L4</b>	1.5	38	10.6	269	225	1000	1.00	25.4	0.25	6.4	MTRTLS	50	250
<b>MRT2LH-L4</b>	2.0	51	12.2	310	225	1000	1.00	25.4	0.25	6.4		50	250
<b>MRT4LH-L4</b>	4.0	102	18.5	470	225	1000	1.00	25.4	0.25	6.4		50	250
<b>MRT6LH-L4</b>	6.0	152	24.8	630	225	1000	1.00	25.4	0.25	6.4		50	250

#### Heavy Cross Section

<b>MRT1.5H-L4</b>	1.5	38	10.6	269	400	1780	1.00	25.4	0.31	7.9	MTRTH	50	250
<b>MRT2H-L4</b>	2.0	51	12.2	310	400	1780	1.00	25.4	0.31	7.9		50	250
<b>MRT4H-L4</b>	4.0	102	18.5	470	400	1780	1.00	25.4	0.31	7.9		50	250
<b>MRT6H-L4</b>	6.0	152	24.8	630	400	1780	1.00	25.4	0.31	7.9		50	250

### Double Wrapped – For Additional Strength

#### Standard Cross Section

<b>MRT1.5DS-C4</b>	1.5	38	14.4	366	250	1112	1.00	25.4	0.17	4.4	MTRTLS	100	500
<b>MRT2.5DS-C4</b>	2.5	63	20.7	526	250	1112	1.00	25.4	0.17	4.4		100	500

#### Light-Heavy Cross Section

<b>MRT2.5DLH-L4</b>	2.5	63	20.7	526	350	1556	1.00	25.4	0.25	6.4	MTRTLS	50	250
---------------------	-----	----	------	-----	-----	------	------	------	------	-----	--------	----	-----

#### Heavy Cross Section

<b>MRT2DH-L4</b>	2.0	51	18.5	470	550	2447	1.00	25.4	0.31	7.9	MTRTH	50	250
<b>MRT4DH-L4</b>	4.0	102	31.1	790	550	2447	1.00	25.4	0.31	7.9		50	250

\*\*\*For information on installation tools, refer to page B3.20.

D2.  
Power  
Connectors

D3.  
Grounding  
Connectors

E1.  
Labeling  
Systems

E2.  
Labels

E3.  
Pre-Printed  
& Write-On  
Markers

E4.  
Permanent  
Identification

E5.  
Lockout/  
Tagout  
& Safety  
Solutions

F.  
Index

## Part Number System for Pan-Steel® 360° Radial Seal Retained Tension Ties – MRS Series



## Pan-Steel® 360° Radial Seal Retained Tension Ties – MRS Series



- 360° radial seal eliminates gaps under the head of the tie to provide a completely sealed installation

- Self-locking cable tie design locks into place at any length along the tie body, unlike fixed diameter band clamps
- Available in AISI 304 stainless steel with a thickness of 0.010" (0.25mm)



Part Number	Max. Bundle Diameter		Length		Min. Loop Tensile Strength		Min. Bundle Diameter		Width		Recommended Installation Tool***	Std. Pkg. Qty.	Std. Ctn. Qty.
	In.	mm	In.	mm	Lbs.	N	In.	mm	In.	mm			

### AISI 304 Stainless Steel – For General Purpose

#### Standard Cross Section

MRS1S-C4	1.0	25	9.0	229	180	800	0.75	19.1	0.18	4.4	MTRTLS	100	500
MRS2S-C4	2.0	51	12.2	310	180	800	0.75	19.1	0.18	4.4		100	500
MRS4S-C4	4.0	102	18.5	470	180	800	0.75	19.1	0.18	4.4		100	500
MRS6S-C4	6.0	152	24.8	630	180	800	0.75	19.1	0.18	4.4		100	500

#### Light-Heavy Cross Section

MRS1.5LH-L4	1.5	38	10.6	269	225	1000	1.00	25.4	0.25	6.4	MTRTLS	50	250
MRS2LH-L4	2.0	51	12.2	310	225	1000	1.00	25.4	0.25	6.4		50	250
MRS4LH-L4	4.0	102	18.5	470	225	1000	1.00	25.4	0.25	6.4		50	250
MRS6LH-L4	6.0	152	24.8	630	225	1000	1.00	25.4	0.25	6.4		50	250

#### Heavy Cross Section

MRS1.5H-L4	1.5	38	10.6	269	400	1780	1.00	25.4	0.31	7.9	MTRTH	50	250
MRS2H-L4	2.0	51	12.2	310	400	1780	1.00	25.4	0.31	7.9		50	250
MRS4H-L4	4.0	102	18.5	470	400	1780	1.00	25.4	0.31	7.9		50	250
MRS6H-L4	6.0	152	24.8	630	400	1780	1.00	25.4	0.31	7.9		50	250

\*\*\*For information on installation tools, refer to page B3.20.

A.  
System  
Overview

B1.  
Cable  
Ties

B2.  
Cable  
Accessories

B3.  
Stainless  
Steel  
Ties

C1.  
Wiring  
Duct

C2.  
Surface  
Raceway

C3.  
Abrasion  
Protection

C4.  
Cable  
Management

D1.  
Terminals

D2.  
Power  
Connectors

D3.  
Grounding  
Connectors

E1.  
Labeling  
Systems

E2.  
Labels

E3.  
Pre-Printed  
& Write-On  
Markers

E4.  
Permanent  
Identification

E5.  
Lockout/  
Tagout  
& Safety  
Solutions

F.  
Index

A. System Overview

## MTRT Retained Tension Manual Installation Tools

B1. Cable Ties

- Adjustable detent mechanism provides user pre-set controlled tension for repeatable installations and maximum reliability
- Smooth cable tie cut-off eliminates burrs or sharp edges after installation to deliver added bundle protection and job site safety
- Tie tensioning mechanism provides improved durability compared to conventional gripper style tools
- Change over kits available to allow for installation of all tie cross sections with one tool

B2. Cable Accessories

B3. Stainless Steel Ties

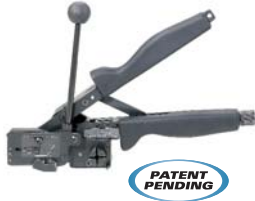

Part Number	Part Description	Std. Pkg. Qty.
<b>MTRTH</b>	Retained tension installation tool for use with Pan-Steel® heavy cross section MRT and MRS style ties and MRT double wrapped style ties.	1
<b>MTRTLS</b>	Retained tension installation tool for use with Pan-Steel® light-heavy and standard cross section MRT and MRS style ties and MRT double wrapped style ties.	1
<b>KMTRTH</b>	Change over kits allow for installation of heavy cross section MRT and MRS style ties, and MRT double wrapped style ties in MTRTH tools.	1
<b>KMTRTLS</b>	Change over kits allow for installation of light-heavy and standard cross section MRT and MRS style ties, and MRT double wrapped style ties in MTRTLS tools.	1

C1. Wiring Duct

C2. Surface Raceway

C3. Abrasion Protection

C4. Cable Management

D1. Terminals

D2. Power Connectors

D3. Grounding Connectors

E1. Labeling Systems

E2. Labels

E3. Pre-Printed & Write-On Markers

E4. Permanent Identification

E5. Lockout/Tagout & Safety Solutions

F. Index

## Features and Benefits – Pan-Steel® Strapping System

The Panduit® Pan-Steel® Stainless Steel Strapping is the ultimate solution for strapping applications. The buckle design and tension controlled installation tool offer a quick and safe installation for all harsh environments. Available in four widths 3/8" (9.5mm), 1/2" (12.7mm), 5/8" (15.9mm) and 3/4" (19.1mm) in base 201 (3/4" width only), 304, or 316 stainless steel with a temperature range of -112°F (-80°C) to 1000°F (538°C).

### Unique Locking Methods Pan-Steel® Stainless Steel Strapping

**\*Hooked Clamping Tab**

Bends strap body within retention area of buckle for increased loop tensile strength and full coverage of cut end of strap

**\*Cross Rib Support**

Enhanced rigidity for higher loop tensile strength

**Buckle Design**

Provides a low finished profile

**\*Concave Cross Section**

Enhanced support to improve tensile strength

**\*Concave Buckle Recess**

Increases body resistance for increased loop tensile strength

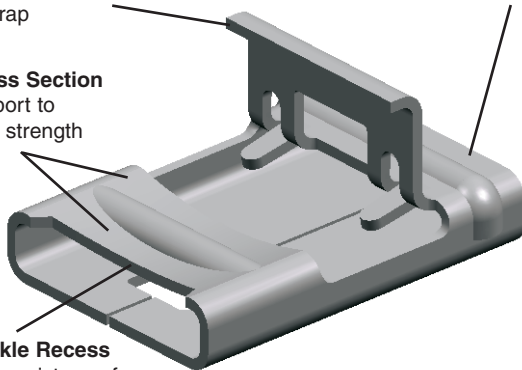

**No Sharp Edges**

After tensioning, cut end is locked inside buckle

## Pan-Steel® Stainless Steel MS75 Strapping

**Hooked Clamping Tab**

Provides full coverage of cut end of strap for enhanced safety

**Buckle Screwdriver Slot**

Allows use of screwdriver for buckle closure for a simple quick installation

**No Sharp Edges**

After tensioning, cut end is locked inside buckle

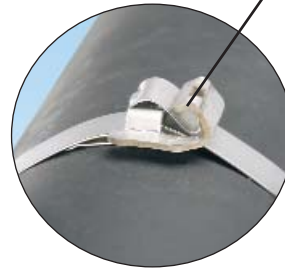
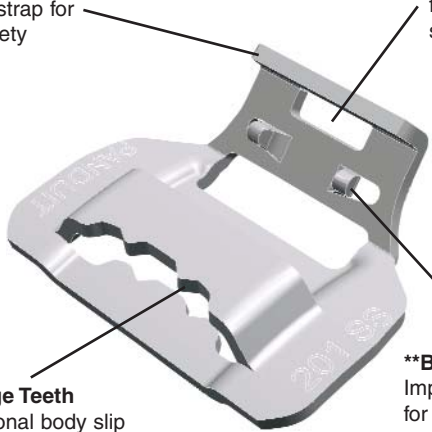

**Buckle Bridge Teeth**

Deliver additional body slip resistance for optimum strength

**\*\*Buckle Locking Tabs**

Improve locking mechanism for higher strength

\*Patented  
\*\*Patents Pending



Hand operated installation tools used with Panduit® Pan-Steel® Strapping. Tensions, cuts strapping, and secures the buckle tab. Easy to operate. See page B3.26.



Custom length strapping available for applications that require various bundle diameters, to provide job safety and versatility with minimum inventory. See page B3.25.

A. System Overview

## The Panduit Method Reduces Installation Time

### Pan-Steel® Stainless Steel Strapping

B1. Cable Ties

B2. Cable Accessories

B3. Stainless Steel Ties



1) Place strap around the material, insert tail of strap through buckle. Pull strapping tight and bend up to hold in place. Insert tail of strapping into tool nose section. Squeeze handle to tension.



2) Once proper tension is reached, maintain tension and raise tool 90° – 120° over buckle and pull down on cutter lever, cutting strap.



3) Remove tool, press cut end down and toward retaining tab.

C1. Wiring Duct

C2. Surface Raceway

C3. Abrasion Protection



4) Using the closure lever on the handle of the tool, bend retaining tab down and over cut end.



**Provides finished, safe, and secure closure.**

C4. Cable Management

### Pan-Steel® Stainless Steel MS75 Strapping

D1. Terminals

D2. Power Connectors

D3. Grounding Connectors



1) Place strap around the material, insert tail of strap through buckle. Pull strapping tight and bend up to hold in place.



2) Insert tail of strapping into tool nose section. Rotate handle to tension.



3) After tensioning raise tool 90° – 120° over buckle and pull down on cutter lever, cutting strap.



4) Remove tool, press cut end down toward retaining tab.



5) Using flathead screwdriver, bend retaining tab down and over cut end.



**Provides finished, safe, and secure closure.**

E1. Labeling Systems

E2. Labels

E3. Pre-Printed & Write-On Markers

E4. Permanent Identification

E5. Lockout/Tagout & Safety Solutions

F. Index

### Part Number System for Discrete Length Strapping

<b>MS</b>	<b>4</b>	<b>W</b>	<b>38</b>	<b>T</b>	<b>15</b>	<b>L</b>	<b>4</b>
Type	Bundle Diameter (In.)	Width	Inches	Thickness	15 = 0.015" 30 = 0.030"	Standard Package Size L = 50 Pcs. Q = 25 Pcs.	Material 2 = 201 SS 4 = 304 SS 6 = 316 SS
MS = Metal Strap MSC = Metal Strap Coated			38 = 3/8 50 = 1/2 63 = 5/8 75 = 3/4				

## Pan-Steel® Strapping – MS Series

- Fold over design provides high-retained tension in mechanical fastening and cable bundling applications
- After tensioning, cut end is locked inside low profile buckle – no sharp edges
- Can be used in a wide range of indoor, outdoor, and underground (including direct burial) applications
- Smooth surfaces and rounded edges assures cable protection and worker safety
- Available in AISI 201 (3/4" width only) and 304 stainless steel for general-purpose applications
- Available in AISI 316 stainless steel for the most corrosive environments



Part Number	Max. Bundle Diameter		Length*		Strap Breaking Strength		Min. Bundle Diameter		Width		Thickness		Recommended Installation Tool***	Std. Pkg. Qty.	Std. Ctn. Qty.	
	In.	mm	In.	mm	Lbs.	N	In.	mm	In.	mm	In.	mm				
<b>AISI 201 Stainless Steel</b>																
MS4W75T30-Q2	4.0	102	20.2	513	2400	10656	1.00	25.4	0.75	19.1	0.030	0.76	BT75SDT	25	25	
MS6W75T30-Q2	6.0	152	26.5	673	2400	10656	1.00	25.4	0.75	19.1	0.030	0.76		25	25	
MS8W75T30-Q2	8.0	203	32.7	831	2400	10656	1.00	25.4	0.75	19.1	0.030	0.76		25	25	
MS10W75T30-Q2	10.0	254	39.0	991	2400	10656	1.00	25.4	0.75	19.1	0.030	0.76		25	25	
<b>AISI 304 Stainless Steel</b>																
MS2W38T15-L4	2.0	51	11.8	300	502	2229	1.00	25.4	0.38	9.5	0.015	0.38	BT2HT	50	250	
MS4W38T15-L4	4.0	102	18.0	457	502	2229	1.00	25.4	0.38	9.5	0.015	0.38		50	250	
MS6W38T15-L4	6.0	152	24.4	620	502	2229	1.00	25.4	0.38	9.5	0.015	0.38		50	250	
MS8W38T15-L4	8.0	203	30.7	780	502	2229	1.00	25.4	0.38	9.5	0.015	0.38		50	250	
MS10W38T15-L4	10.0	254	37.0	940	502	2229	1.00	25.4	0.38	9.5	0.015	0.38		50	250	
MS4W50T15-L4	4.0	102	18.0	457	671	2979	1.00	25.4	0.50	12.7	0.015	0.38		50	250	
MS6W50T15-L4	6.0	152	24.4	620	671	2979	1.00	25.4	0.50	12.7	0.015	0.38		50	250	
MS8W50T15-L4	8.0	203	30.7	780	671	2979	1.00	25.4	0.50	12.7	0.015	0.38		50	250	
MS10W50T15-L4	10.0	254	37.0	940	671	2979	1.00	25.4	0.50	12.7	0.015	0.38		50	250	
MS4W63T15-L4	4.0	102	18.0	457	839	3725	1.00	25.4	0.63	15.9	0.015	0.38		50	250	
MS6W63T15-L4	6.0	152	24.4	620	839	3725	1.00	25.4	0.63	15.9	0.015	0.38		50	250	
MS8W63T15-L4	8.0	203	30.7	780	839	3725	1.00	25.4	0.63	15.9	0.015	0.38		50	250	
MS10W63T15-L4	10.0	254	37.0	940	839	3725	1.00	25.4	0.63	15.9	0.015	0.38		50	250	
<b>AISI 316 Stainless Steel</b>																
MS2W38T15-L6	2.0	51	11.8	300	502	2229	1.00	25.4	0.38	9.5	0.015	0.38		BT2HT	50	250
MS4W38T15-L6	4.0	102	18.0	457	502	2229	1.00	25.4	0.38	9.5	0.015	0.38			50	250
MS6W38T15-L6	6.0	152	24.4	620	502	2229	1.00	25.4	0.38	9.5	0.015	0.38	50		250	
MS8W38T15-L6	8.0	203	30.7	780	502	2229	1.00	25.4	0.38	9.5	0.015	0.38	50		250	
MS10W38T15-L6	10.0	254	37.0	940	502	2229	1.00	25.4	0.38	9.5	0.015	0.38	50		250	
MS4W50T15-L6	4.0	102	18.0	457	671	2979	1.00	25.4	0.50	12.7	0.015	0.38	50		250	
MS6W50T15-L6	6.0	152	24.4	620	671	2979	1.00	25.4	0.50	12.7	0.015	0.38	50		250	
MS8W50T15-L6	8.0	203	30.7	780	671	2979	1.00	25.4	0.50	12.7	0.015	0.38	50		250	
MS10W50T15-L6	10.0	254	37.0	940	671	2979	1.00	25.4	0.50	12.7	0.015	0.38	50		250	
MS4W63T15-L6	4.0	102	18.0	457	839	3725	1.00	25.4	0.63	15.9	0.015	0.38	50		250	
MS6W63T15-L6	6.0	152	24.4	620	839	3725	1.00	25.4	0.63	15.9	0.015	0.38	50		250	
MS8W63T15-L6	8.0	203	30.7	780	839	3725	1.00	25.4	0.63	15.9	0.015	0.38	50		250	
MS10W63T15-L6	10.0	254	37.0	940	839	3725	1.00	25.4	0.63	15.9	0.015	0.38	50		250	

\*Other lengths available, contact Panduit Customer Service.

\*\*\*For information on installation tool, refer to page B3.26.

A.  
System  
Overview

B1.  
Cable Ties

B2.  
Cable  
Accessories

B3.  
Stainless  
Steel Ties

C1.  
Wiring  
Duct

C2.  
Surface  
Raceway

C3.  
Abrasion  
Protection

C4.  
Cable  
Management

D1.  
Terminals

D2.  
Power  
Connectors

D3.  
Grounding  
Connectors

E1.  
Labeling  
Systems

E2.  
Labels

E3.  
Pre-Printed  
& Write-On  
Markers

E4.  
Permanent  
Identification

E5.  
Lockout/  
Tagout  
& Safety  
Solutions

F.  
Index

A.  
System  
Overview

## Pan-Steel® Nylon 11 Coated Strapping – MSC Series

- Fold over design provides high-retained tension in mechanical fastening and cable bundling applications
- After tensioning, cut end is locked inside low profile buckle – no sharp edges
- AISI 316 stainless steel for the most corrosive environments
- Available in 0.38 inch (9.5mm), 0.50 inch (12.7mm), 0.63 inch (15.9mm) cross sections
- UV resistant, low smoke, halogen-free material
- Temperature tolerance -40°F (-40°C) to 285°F (140°C)

B1.  
Cable Ties

B2.  
Cable  
Accessories

B3.  
Stainless  
Steel Ties



C1.  
Wiring  
Duct

C2.  
Surface  
Raceway

C3.  
Abrasion  
Protection

C4.  
Cable  
Management

D1.  
Terminals

D2.  
Power  
Connectors

D3.  
Grounding  
Connectors

E1.  
Labeling  
Systems

E2.  
Labels

E3.  
Pre-Printed  
& Write-On  
Markers

E4.  
Permanent  
Identification

E5.  
Lockout/  
Tagout  
& Safety  
Solutions

F.  
Index

Part Number	Max. Bundle Diameter		Length*		Strap Breaking Strength		Min. Bundle Diameter		Width		Thickness^		Recommended Installation Tool***	Std. Pkg. Qty.	Std. Ctn. Qty.
	In.	mm	In.	mm	Lbs.	N	In.	mm	In.	mm	In.	mm			
MSC2W38T15-L6	2.0	51	11.8	300	502	2229	1.00	25.4	0.38	9.5	0.015	0.38	BT2HT	50	250
MSC4W38T15-L6	4.0	102	18.0	457	502	2229	1.00	25.4	0.38	9.5	0.015	0.38		50	250
MSC6W38T15-L6	6.0	152	24.4	620	502	2229	1.00	25.4	0.38	9.5	0.015	0.38		50	250
MSC8W38T15-L6	8.0	203	30.7	780	502	2229	1.00	25.4	0.38	9.5	0.015	0.38		50	250
MSC10W38T15-L6	10.0	254	37.0	940	502	2229	1.00	25.4	0.38	9.5	0.015	0.38		50	250
MSC4W50T15-L6	4.0	102	18.0	457	671	2979	1.00	25.4	0.50	12.7	0.015	0.38		50	250
MSC6W50T15-L6	6.0	152	24.4	620	671	2979	1.00	25.4	0.50	12.7	0.015	0.38		50	250
MSC8W50T15-L6	8.0	203	30.7	780	671	2979	1.00	25.4	0.50	12.7	0.015	0.38		50	250
MSC10W50T15-L6	10.0	254	37.0	940	671	2979	1.00	25.4	0.50	12.7	0.015	0.38		50	250
MSC4W63T15-L6	4.0	102	18.0	457	839	3725	1.00	25.4	0.63	15.9	0.015	0.38		50	250
MSC6W63T15-L6	6.0	152	24.4	620	839	3725	1.00	25.4	0.63	15.9	0.015	0.38		50	250
MSC8W63T15-L6	8.0	203	30.7	780	839	3725	1.00	25.4	0.63	15.9	0.015	0.38		50	250
MSC10W63T15-L6	10.0	254	37.0	940	839	3725	1.00	25.4	0.63	15.9	0.015	0.38		50	250

\*Other lengths available, contact Panduit Customer Service.

\*\*\*For information on installation tools, refer to page B3.26.

^Base material less coating.



## Pan-Steel® Custom Length Strapping

- Fold over design provides high retained tension in mechanical fastening and cable bundling applications
- After tensioning, cut end is locked inside low profile buckle – no sharp edges
- For applications that require various bundle diameters
- Supplied in reels of 82.5 feet (25m) (coated) or 100 feet (30.5m) (uncoated)

- Provides job site versatility with minimum inventory
- Packaging speeds removal of steel and includes bundle diameter cut-off guide
- Available in AISI 201(3/4" width only) and 304 stainless steel for general-purpose applications
- Available in AISI 316 stainless steel for the most corrosive environments



### Nylon 11 coating (optional):

- Nylon 11 coating provides additional edge protection and prevents corrosion between dissimilar metals
- UV resistant, low smoke, halogen-free material
- Temperature tolerance -40°F (-40°C) to 285°F (140°C)
- AISI 316 stainless steel for the most corrosive environments

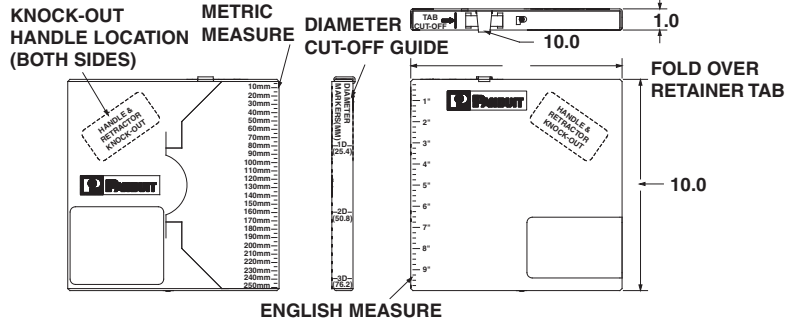

Part Number	Length*		Strap Breaking Strength		Width		Thickness^		Used with Buckle	Recommended Installation Tool***	Std. Pkg. Qty.‡
	Ft.	m	Lbs.	N	In.	mm	In.	mm			
<b>201 Stainless Steel</b>											
<b>NEW!</b> MSW75T30-CR2	100	30.5	2400	10656	0.75	19.1	0.030	0.80	MSBW75-C2	BT75SDT	1
<b>304 Stainless Steel</b>											
MSW38T15-CR4	100	30.5	502	2229	0.38	9.5	0.015	0.38	MSBW38-C4	BT2HT	1
MSW50T15-CR4	100	30.5	671	2979	0.50	12.7	0.015	0.38	MSBW50-C4		1
MSW63T15-CR4	100	30.5	839	3725	0.63	15.9	0.015	0.38	MSBW63-C4		1
<b>316 Stainless Steel</b>											
MSW38T15-CR6	100	30.5	502	2229	0.38	9.5	0.015	0.38	MSBW38-C6	BT2HT	1
MSW50T15-CR6	100	30.5	671	2979	0.50	12.7	0.015	0.38	MSBW50-C6		1
MSW63T15-CR6	100	30.5	839	3725	0.63	15.9	0.015	0.38	MSBW63-C6		1
<b>Nylon Coated Custom Length Strapping</b>											
MSCNW38T15-QR6	82.5	25.0	502	2229	0.38	9.5	0.015	0.38	MSBW38-C6	BT2HT	1
MSCNW50T15-QR6	82.5	25.0	671	2979	0.50	12.7	0.015	0.38	MSBW50-C6		1
MSCNW63T15-QR6	82.5	25.0	839	3725	0.63	15.9	0.015	0.38	MSBW63-C6		1

\*Other lengths available, contact Panduit Customer Service. ^Base metal less coating.

‡Order in number of reels required.\*\*\*For information on installation tools, refer to page B3.26.

To determine the proper amount of strapping required, use the following formula:

**Calculate** Diameter inches (mm) x 3.14 + 6 inches (152.4 mm)

## Pan-Steel® Buckles for Custom Length Strapping

- Buckle design provides a low finished profile
- After tensioning cut end is locked inside buckle – no sharp edges



Part Number	Material	Width		Part Description	Std. Pkg. Qty.	Std. Ctn. Qty.
		In.	mm			
<b>AISI 201 Stainless Steel</b>						
<b>NEW!</b> MSBW75-C2	201	0.75	19.1	Individual low profile buckles used with metal strapping.	100	—
<b>AISI 304 Stainless Steel</b>						
MSBW38-C4	304	0.38	9.5	Individual low profile buckles used with custom length strapping.	100	1000
MSBW50-C4	304	0.50	12.7		100	1000
MSBW63-C4	304	0.63	15.9		100	1000
<b>AISI 316 Stainless Steel</b>						
MSBW38-C6	316	0.38	9.5	Individual low profile buckles used with custom length strapping.	100	1000
MSBW50-C6	316	0.50	12.7		100	1000
MSBW63-C6	316	0.63	15.9		100	1000

A.  
System  
Overview

## BT2HT Hand Operated Installation Tool for Strapping

B1.  
Cable  
Ties

- Strap side entry
- Multi-position rear handle provides flexibility for a one or two hand installation
- Adjustable tension control
- Easy removal of excess strap
- Installs (3) sizes: 0.38 inch (9.5mm), 0.50 inch (12.7mm), and 0.63 inch (15.9mm)
- Replacement cutter blade and handle available

B2.  
Cable  
Accessories



B3.  
Stainless  
Steel Ties

Part Number	Part Description	Std. Pkg. Qty.
<b>BT2HT</b>	Installation tool for use with 0.38" (9.5mm), 0.50" (12.7mm), and 0.63" (15.9mm) widths of Panduit® Pan-Steel® Strapping. Tensions, cuts strapping, and secures the buckle tab. Lever cut off.	1
<b>KRT2BLD</b>	Replacement cutter blade for RT2HT and BT2HT.	1
<b>KRT2HNDL</b>	Replacement cutter handle for RT2HT and BT2HT.	1

C1.  
Wiring  
Duct

C2.  
Surface  
Raceway

## **NEW!** BT75SDT Hand Operated Installation Tool for MS75 Strapping

C3.  
Abrasion  
Protection

- Screw drive tension mechanism provides high tension with minimal effort, reducing operator fatigue
- Heavy duty construction offers a longer service life
- Strapping side entry allows quick side entry of the strap into tool to speed installation

C4.  
Cable  
Management



D1.  
Terminals

Part Number	Part Description	Std. Pkg. Qty.
<b>BT75SDT</b>	Installation tool for use with 0.75" (19.1mm) width strapping only. Tensions and cuts strapping. Screwdriver required for buckle closure (not included).	1

D2.  
Power  
Connectors

D3.  
Grounding  
Connectors

## PCS Cushion Sleeve

E1.  
Labeling  
Systems

- Black neoprene sleeving used with Pan-Steel® Stainless Steel Ties, custom length banding, and MS strap
- Used on applications requiring improved gripping on non-resilient objects
- Can be used indoors or outdoors (excellent ultraviolet resistance, good resistance to petroleum, and many chemicals)
- Isolation between dissimilar metals allows the ties and straps to be used with aluminum cable tray
- Provides full separation between the ties and the bundle
- Operating temperature range -40°F (-40°C) to 200°F (93°C)

E2.  
Labels



E3.  
Pre-Printed  
& Write-On  
Markers

Part Number	Used with Pan-Steel® Ties/Strapping	Width		Length		Std. Pkg. Qty.‡
		In.	mm	Ft.	m	
<b>PCSS-B-CR</b>	MLT/S	.33	8.4	100	30.5	1
<b>PCSH-B-CR</b>	MLT/LH/H	.47	11.9	100	30.5	1
<b>PCSSH-B-CR*</b>	MLT/EH/SH and MS Straps	.91	23.1	100	30.5	1

E4.  
Permanent  
Identification



E5.  
Lockout/  
Tagout  
& Safety  
Solutions

F.  
Index

\*Meets MIL-R-6855  
‡Order in number of reels required.  
Pkg. -CR = 100 ft. (30.5m) reel.

## Stainless Steel Tie Mounts

- Low profile
- One hole mounting

- For use with standard, light-heavy, and heavy cross section Pan-Steel® Ties as well as .38 inch (9.5mm) wide strapping
- 304 Stainless Steel

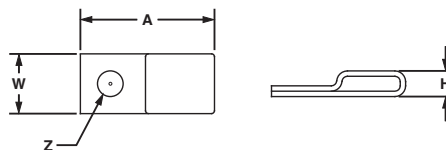

Part Number	Used with Pan-Steel® Ties/Strapping	Mounting Method*	Length A		Width W		Height H		Hole Diameter Z		Std. Pkg. Qty.	Std. Ctn. Qty.
			In.	mm	In.	mm	In.	mm	In.	mm		
<b>MTM1H-C</b>	MLTS/LH/H, MLTC/H, MLTFC/S/LH/H or MSW38	#8 (4mm) screw	.90	22.6	.40	10.2	.17	4.4	.17	4.4	100	1000
<b>MTM1H10-C</b>		#10 (5mm) screw	.90	22.6	.40	10.2	.17	4.4	.21	5.4	100	1000
<b>MTM1H25-C</b>		1/4" (6mm) screw	.90	22.6	.40	10.2	.17	4.4	.28	7.1	100	1000

\*Stainless steel screws are recommended for fastening to avoid corrosion problems associated with dissimilar metals.

## Stainless Steel Push Mount

- No tapping required
- Used where only one side of the panel is accessible
- Nothing to assemble

- For use with standard, light-heavy, and heavy cross section Pan-Steel® Ties
- 304 Stainless Steel

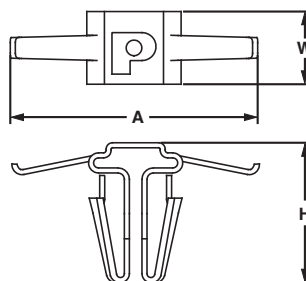

Part Number	Used with Pan-Steel® Ties/Strapping	Mounting Method	Length A		Width W		Height H		Panel Thickness		Std. Pkg. Qty.	Std. Ctn. Qty.
			In.	mm	In.	mm	In.	mm	In.	mm		
<b>MPWM-H56-Q</b>	MLTS/LH/H, MLTC/H or MLTFC/S/LH/H	Inserted into pre-drilled hole 5/16" (8mm)	.84	21.3	.29	7.3	.56	14.2	.03 – .09	.8 – 2.4	25	250

A.  
System  
Overview

B1.  
Cable  
Ties

B2.  
Cable  
Accessories

B3.  
Stainless  
Steel  
Ties

C1.  
Wiring  
Duct

C2.  
Surface  
Raceway

C3.  
Abrasion  
Protection

C4.  
Cable  
Management

D1.  
Terminals

D2.  
Power  
Connectors

D3.  
Grounding  
Connectors

E1.  
Labeling  
Systems

E2.  
Labels

E3.  
Pre-Printed  
& Write-On  
Markers

E4.  
Permanent  
Identification

E5.  
Lockout/  
Tagout  
& Safety  
Solutions

F.  
Index

A. System Overview

## Stainless Steel Push Button Mount

B1. Cable Ties

- Low profile
- No tapping required
- Designed for use only where both sides of the panel are accessible

- For use with standard cross section Pan-Steel® Ties
- 304 Stainless Steel

B2. Cable Accessories

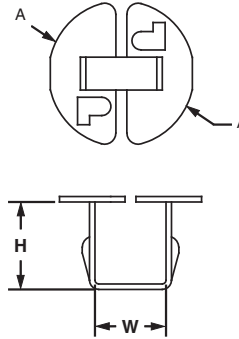
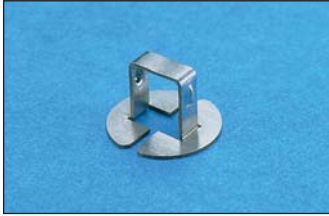

B3. Stainless Steel Ties

C1. Wiring Duct

C2. Surface Raceway

C3. Abrasion Protection

Part Number	Used with Pan-Steel® Ties/Strapping	Mounting Method	Diameter A		Width W		Height H		Panel Thickness		Std. Pkg. Qty.	Std. Ctn. Qty.
			In.	mm	In.	mm	In.	mm	In.	mm		
<b>MBM-H25-Q</b>	MLT/S or MLTFC/S	Inserted into pre-drilled hole .25" (6.4mm)	.40	10.0	.20	5.0	.26	6.5	.03 – .12	.8 – 3.0	25	250

C4. Cable Management

D1. Terminals

## Stainless Steel 2-Way Tie Mount

D2. Power Connectors

- Allows stainless steel cable ties to be inserted from either of two sides
- Low profile
- Single hole center mounting for maximum holding and stability
- Maximum screw head height .09 inches (2.3mm)

- For use with standard, light-heavy, and heavy cross section Pan-Steel® Ties
- 304 Stainless Steel

D3. Grounding Connectors

E1. Labeling Systems

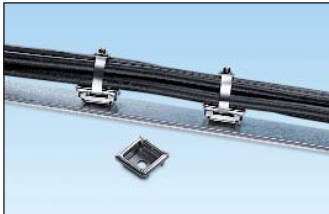

E2. Labels

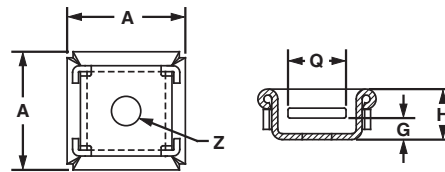

E3. Pre-Printed & Write-On Markers

Part Number	Used with Pan-Steel® Ties/Strapping	Mounting Method*	Length A		Height H		Screw Head Height G		Slot Width Q		Hole Diameter Z		Std. Pkg. Qty.	Std. Ctn. Qty.
			In.	mm	In.	mm	In.	mm	In.	mm	In.	mm		
<b>MTM2H-Q</b>	MLTS/LH/H, MLTC/H or MLTFC/S/LH/H	#8 (4mm) screw	.71	18.0	.30	8.0	.09	2.3	.35	9.0	.17	4.5	25	250

E4. Permanent Identification

E5. Lockout/Tagout & Safety Solutions

\*Stainless steel screws are recommended for fastening to avoid corrosion problems associated with dissimilar metals.

F. Index

## Stainless Steel Bulkhead Mount

- Zero profile
- Mounts directly to surface
- Used where only one side of the panel is accessible

- Permanent, secure application
- Used with standard, light-heavy, and heavy cross section Pan-Steel® Ties
- 304 Stainless Steel

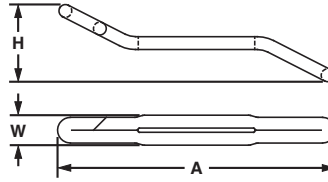

Part Number	Used with Pan-Steel® Ties/Strapping	Mounting Method	Length A		Width W		Height H		Max. Panel Thickness		Std. Pkg. Qty.	Std. Ctn. Qty.
			In.	mm	In.	mm	In.	mm	In.	mm		
MTMBH-Q	MLTS/LH/H/EH/SH, MLTC/H, or MLTFC/S/LH/H/EH/SH	Pre-drill hole size standard and light-heavy cross section MLT-S/LH .38" (9.5mm) – .50" (12.7mm). Heavy cross section MLT-H .50" (12.7mm) – .63" (15.9mm).	1.92	48.5	.21	5.3	.54	13.7	.50	12.7	25	250

### To Install Bulkhead Mount:

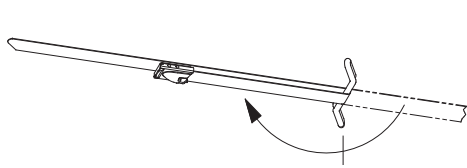

- 1) Insert cable tie through mount slot and fold cable tie.

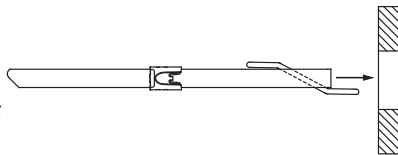

- 2) Insert cable tie and mount through panel/framework hole.

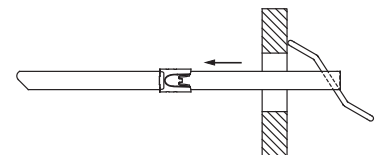

- 3) Pull cable tie back to secure the mount in the panel/framework.

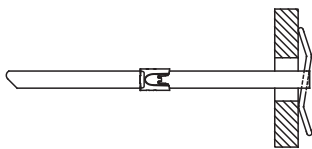

- 4) Mount shown in correct position for installation.



- 5) Separate cable tie to allow for bundling of cables/wires, etc.

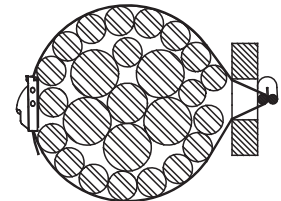

- 6) Install cable tie around bundle and fasten.

A.  
System  
Overview

## Stainless Steel Technical Information

### Physical Characteristics of Stainless Steel and Aluminum

B1.  
Cable Ties

B2.  
Cable  
Accessories

B3.  
Stainless  
Steel Ties

	Pan-Steel® Stainless Steel MS Strapping and Buckles	Pan-Steel® Stainless Steel Marker Plates, Tags, and Cable Ties	Pan-Alum™ Aluminum Marker Plates and Cable Ties
<b>Material:</b>	201 Grade Stainless Steel	304 and 316 Grade Stainless Steel	Aluminum – Natural and Anodized
<b>Maximum temperature rating:</b>	538°C	538°C	100°C
<b>Minimum temperature rating:</b>	-80°C	-80°C	-80°C
<b>RoHS:</b>	Compliant	Compliant	Compliant
<b>Flammability:</b>	Non-Flammable	Non-Flammable	Non-Flammable
<b>Ultraviolet light resistance:</b>	Excellent	Excellent	Good



C1.  
Wiring  
Duct

## Panduit Stainless Steel Cable Tie and Strapping Approvals

C2.  
Surface  
Raceway

C3.  
Abrasion  
Protection

C4.  
Cable  
Management

D1.  
Terminals

D2.  
Power  
Connectors

D3.  
Grounding  
Connectors

E1.  
Labeling  
Systems

E2.  
Labels

E3.  
Pre-Printed  
& Write-On  
Markers

E4.  
Permanent  
Identification

E5.  
Lockout/  
Tagout  
& Safety  
Solutions

F.  
Index

Logo (Symbol)	Agency	Spec /Approval	Requirement	Applicable Products
	Underwriters Laboratories, Inc.	Listing E56854	Dimensional, tensile, temp., cycling, humidity	MLT-S, MLT-LH, MLT-H, MLTEH15, MLTSH, MLTDEH and MLTDSH in 304, and 316. MSW38T15, MSW50T15, MSW63T15, MSBW38, MSBW50, MSBW63 in both 304 and 316 material. MSCW38T15, MSCW50T15, MSCW63T15, MSCN38T15, MLTFC3, SH, MLTCH, MSCNW50T15, and MSW63T15 in 316 material.
	Conformite European	Low Voltage Directive 73/23/EEC (amended 93/68/EEC) MLT cable ties and MS straps also meet the requirements from EN50146	CE Marking is required for products sold within the European Union. CE Marking Directives specify the minimum performance of these products. Applying the CE mark signifies compliance with essential requirements of specific directives.	All MLT, MRT, MRS ties and MS straps.
	Amer. Bureau of Shipping	Cert. #03-HS373867-PDA, 04-HS476898-PDA, 05-HS118592C/1-PDA, 06-HS152579-PDA, 05-HS118592A/2-PDA	Mechanical	All MLT ties and MS straps.
	Bureau Veritas	Cert. #04048/D2 BV	Material specification, dimensional, visual	All uncoated MLT ties in 304 and 316 material.
	Det Norske Veritas	Cert. # E-6540 E-6539	Salt mist test, tensile test, accelerated aging, vibration tests	All uncoated MLTS, MLTH, MLTE15, MLTDEH15, MLTSH, and MS strap coated and uncoated 316 material.
	Germanischer Lloyd	Cert. # 32666-83HH 51796-89HH	Mechanical	All uncoated stainless steel MLT ties and all MS straps.
	Lloyd's Register of Shipping	Cert. # 89/60123	Material specification, tensile test, vibration tests	All uncoated stainless steel MLT ties and all MS straps.
	RINA	Cert. # ELE71502CS	Material specification	All uncoated stainless steel MLT ties and all MS straps.
	SAE Int'l formerly US MIL	AS23190 formerly MS23109E	Dimensional, visual, vibration, temp. cycling, immersion	MLT-S and MLT-H ties in 304 and 306 material.
	US Coast Guard	File No.16703/46	Mechanical	MLT-H series cable ties.
	US Military	MIL-T-81306A/ MS90387-3	Mechanical	GS4MT installation tools.

## Chemical Resistance at 70°F (21°C) Temperature

Chemical	%	304 and 316 Stainless Steel*	Chemical	%	304 and 316 Stainless Steel*	Chemical	%	304 and 316 Stainless Steel*	Chemical	%	304 and 316 Stainless Steel*
Arsenic Acid	40	E	Cider		E	Methyl Alcohol	100	E	Sodium Bisulfate	10	E
Acetone	100	E	Dichloroethane	100	E	Methyl Chloride	100	E	Sodium Borate	All	E
Aluminum Hydroxide	AQ C.S.	E	Diethyl Ether	100	E	Methyl Ethyl Ketone	100	E	Sodium Carbonate	5	E
Ammonium Carbonate	5	E	Ethyl Alcohol	100	E	Naphtha	100	E	Sodium Chlorate	25	E
Ammonium Hydroxide	10	E	Ethyl Chloride	100	E	Nitric Acid	30 – 70	E	Sodium Chloride	2	E
Ammonium Nitrate		E	Ethyl Glycol	100	E	Nitrous Acid	5	E	Sodium Fluoride	5	F
Ammonium Sulfate	10	S	Ferric Hydroxide	All	E	Oleic Acid	100	E	Sodium Hydroxide	10	E
Barium Carbonate	All	E	Ferric Nitrate	10	E	Oxalic Acid	10	E	Sodium Hyposulfite	AQ C.S.	E
Barium Chloride	5	E	Ferrous Sulfate	10	E	Paraffin	100	E	Sodium Nitrate	5	E
Barium Sulfate	10	E	Fuel Oil	100	E	Petroleum Ether	100	E	Sodium Nitrite	AQ C.S.	E
Barium Sulfide	10	E	Furfural	100	E	Phenol	90	E	Sodium Percolate	10	E
Benzene	100	E	Gallic Acid	AQ C.S.	E	Phosphoric Acid	10	E	Sodium Phosphate	5	E
Benzoic Acid	100	E	Gasoline	100	E	Picric Acid	1	S	Sodium Sulfate	5	E
Butyric Acid	50	E	Glycerine	100	E	Potassium Bromide	AQ C.S.	S	Sodium Thiosulfate	5	S
Calcium Carbonate	AQ C.S.	E	Hydrocyanic Acid	All	E	Potassium Carbonate 1%	—	E	Stearic Acid	100	E
Calcium Chlorate	10	E	Hydrogen Peroxide	30	E	Potassium Chlorate	AQ C.S.	E	Sulfur	100	E
Calcium Hydroxide	20	E	Hydrogen Sulfide	Dry	E	Potassium Dichromate	40	E	Sulfur Dioxide	All	E
Calcium Hydrochlorite	2	F	Iodoform	100	E	Potassium Ferrocyanide	25	E	Sulfuric Acid	100	E
Calcium Sulfate	2	E	Isopropyl Alcohol	100	E	Potassium hydroxide	5	E	Sulfuric Acid	5	F
Carbon Tetrachloride	—	—	Jet Fuel	100	E	Potassium Iodide	All	E	Tannic Acid	10	E
Chlorine (Wet)	—	F	Lactic Acid	100	E	Potassium Nitrate	50	E	Tartaric Acid	50	E
Chlorine (Dry)	—	F	Lanolin	10	E	Potassium Permanganate	5	E	Tetrahydrofuran	100	E
Chloroacetic Acid	30	F	Lead Acetate	5	E	Potassium Sulfate	5	E	Toluene	100	F
Chloroform	100	E	Magnesium Carbonate	All	E	Potassium Sulfide	AQ C.S.	E	Xylene	100	E
Chromic Acid	5	E	Magnesium Chloride	10	F	Propyl Alcohol	100	E	Zinc Chloride	70	E
Citric Acid	50	E	Magnesium Nitrate	All	E	Silver Nitrate	10	E	Zinc Nitrate	AQ C.S.	E
Copper Cyanide	10	E	Malic Acid	AQ C.S.	E	Sodium Acetate	60	E	Zinc Sulfate	AQ C.S.	E
Copper Nitrate	50	E	Mercury	100	E	Sodium Bicarbonate	All	E			

\* E = Excellent, S = Satisfactory, F = Fair, AQ C.S. = Aqueous Cold Saturated, All = All % Concentrations.

A.  
System  
Overview

B1.  
Cable  
Ties

B2.  
Cable  
Accessories

B3.  
Stainless  
Steel  
Ties

C1.  
Wiring  
Duct

C2.  
Surface  
Raceway

C3.  
Abrasion  
Protection

C4.  
Cable  
Management

D1.  
Terminals

D2.  
Power  
Connectors

D3.  
Grounding  
Connectors

E1.  
Labeling  
Systems

E2.  
Labels

E3.  
Pre-Printed  
& Write-On  
Markers

E4.  
Permanent  
Identification

E5.  
Lockout/  
Tagout  
& Safety  
Solutions

F.  
Index

A.  
System  
Overview

## Rigorous Tests and Physical Properties of Stainless Steel

B1.  
Cable Ties

**STRENGTH:** Panduit® Pan-Steel® Stainless Steel Ties and Straps are tested per the SAE Standard AS23190 formerly U.S. Military Specification MIL-S-23190, minimum loop tensile test. This test consists of applying a tie to a split mandrel and then measuring the force required to separate the (two) halves until the tie fails. These minimum loop tensile strengths are given for the various products on pages B3.5 through B3.25.

B2.  
Cable  
Accessories

**TEMPERATURE EXTREMES:** Panduit® Pan-Steel® Stainless Steel Ties and Straps are 100% stainless steel in the alloy provided (locking head, locking ball, and body all provided from the same grade of material ordered).

Various temperature tests have been successfully completed. One such test is the U.S. Military Temperature Cycling Test per Thermal Shock Method 107, Test Condition B of MIL-STD-202. This test exposes the parts from low temperature -85°F (-65°C) to high temperature 275°F (135°C) to low temperature -85°F (-65°C). After exposure, the parts must be free of cracks, distortions, breaks, release of locking device; and meet the minimum loop tensile requirements.



B3.  
Stainless  
Steel Ties

**SHOCK AND VIBRATION:** Panduit® Pan-Steel® Standard and Heavy Cross Section ties have passed the U.S. Military random vibration Test Method 214. Test Condition II, Letter J of MIL-STD-202. This test consists of applying parts to a bundle and then vibrating them with random vibration for 8 hours in each of two mutually perpendicular directions. The parts are then subjected to further temperature testing and finally have to pass the minimum loop tensile strength test.

Panduit® Pan-Steel® Extra Heavy, Super Heavy, MSW50 Strapping and MSW63 Strapping have passed the U.S. Military Shock and Vibration Testing per MIL-STD-167 and MIL-S-901D. The ties were subjected to vibrations in all three planes from 4 – 50 Hz and Shock testing in all three planes utilizing a hammer shock machine.

**SALT SPRAY:** Panduit® Pan-Steel® Stainless Steel Ties and Straps have been subjected to salt spray tests without signs of corrosion or reduction in performance.

**OUTDOOR EXPOSURE:** Panduit® Pan-Steel® Stainless Steel Ties and Straps have been exposed outdoors at New Lenox, Illinois USA since 1985. At the printing of this catalog, there has been no sign of corrosion or loss of performance.

**FLUID IMMERSION:** Panduit® Pan-Steel® Stainless Steel Ties were immersed in: 1-Hydraulic Fluid, 2-Turbine Fuel, 3-Lubricating Oil, and 4-Isopropyl Alcohol for four hours at temperatures of 122°F (50°C). Per SAE Standard AS23190, the parts were then subjected to and passed the minimum loop tensile test.

**RADIATION:** Installed cable ties of various materials have been exposed to different amounts of radiation to determine the maximum acceptable limit. These tests were conducted by Panduit to determine the acceptability for use in various areas of nuclear power plants (accumulated over 40 year life). Radiation resistance is 2x10<sup>8</sup> rads.

C1.  
Wiring  
Duct

C2.  
Surface  
Raceway

C3.  
Abrasion  
Protection

C4.  
Cable  
Management

D1.  
Terminals

D2.  
Power  
Connectors

D3.  
Grounding  
Connectors

E1.  
Labeling  
Systems

E2.  
Labels

E3.  
Pre-Printed  
& Write-On  
Markers

E4.  
Permanent  
Identification

E5.  
Lockout/  
Tagout  
& Safety  
Solutions

F.  
Index

### Military Cross Reference (AS23190)

Military Standard Part Number	Panduit Part Number
AS23190/3-1	MLT2S-CP
AS23190/3-1	MLT2S-CP316
AS23190/3-2	MLT4S-CP
AS23190/3-2	MLT4S-CP316
AS23190/3-3	MLT6S-CP
AS23190/3-3	MLT6S-CP316
AS23190/3-4	MLT8S-CP
AS23190/3-4	MLT8S-CP316
AS23190/3-5	MLT2H-LP
AS23190/3-5	MLT2H-LP316
AS23190/3-6	MLT4H-LP
AS23190/3-6	MLT4H-LP316
AS23190/3-7	MLT6H-LP
AS23190/3-7	MLT6H-LP316
AS23190/3-8	MLT8H-LP
AS23190/3-8	MLT8H-LP316
AS23190/3-9	MLT10H-LP
AS23190/3-9	MLT10H-LP316



## WIRING DUCT

From the smallest wall mounted panels to the largest integrated turnkey systems Panduit® Panduct® Wiring Duct is the premium wire management solution for routing and concealing wiring in electrical control panels. Panduct® Wiring Duct provide solutions for the original equipment manufacturing, transportation, contract manufacturing, maintenance and repair and communications markets. All Panduct® Wiring Duct are UL Recognized and CSA Certified and most carry the CE mark.

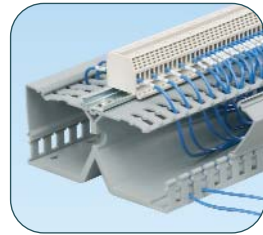
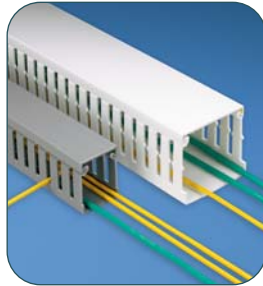
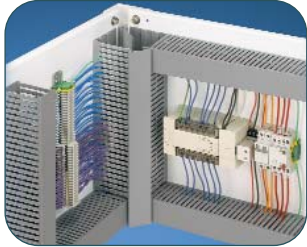

Some of the features and benefits found in Panduct® Wiring Duct include:

- Smooth corners and edges that will not abrade wiring or irritate hands
- Integrated nonskid liners and unique cover designs insure the duct cover will not slide once installed or during vibration
- Specially formulated lead-free PVC material meets the NFPA79: 2007 flame retardancy requirements and carries a UL 94V-0 flammability rating
- Scorelines for easy removal of duct fingers and sidewalls
- Accessories and tools that increase productivity and lower the installed cost

Panduit continues to develop new Panduct® Wiring Duct solutions to satisfy the challenges facing our customers worldwide. Maximize the utilization of enclosure space with PanelMax™ Corner Wiring Duct, DIN Rail Wiring Duct, and Noise Shield. PanelMax™ Corner Wiring Duct fits into unused space in the corner of enclosures providing up to 20% enclosure space savings\*. Integrate component mounting with wire management with PanelMax™ DIN Rail Wiring Duct for up to 30% enclosure space savings. PanelMax™ Noise Shield provides noise mitigation between noisy and sensitive cabling and can reduce air space requirements within the enclosure.

\*Versus panel layouts using conventional wiring duct.

A.  
System  
Overview

B1.  
Cable Ties

B2.  
Cable  
Accessories

B3.  
Stainless  
Steel Ties

C1.  
Wiring  
Duct

C2.  
Surface  
Raceway

C3.  
Abrasion  
Protection

C4.  
Cable  
Management

D1.  
Terminals

D2.  
Power  
Connectors

D3.  
Grounding  
Connectors

E1.  
Labeling  
Systems

E2.  
Labels

E3.  
Pre-Printed  
& Write-On  
Markers

E4.  
Permanent  
Identification

E5.  
Lockout/  
Tagout  
& Safety  
Solutions

F.  
Index

A. System Overview

B1. Cable Ties

B2. Cable Accessories

B3. Stainless Steel Ties

C1. Wiring Duct

C2. Surface Raceway

C3. Abrasion Protection

C4. Cable Management

D1. Terminals

D2. Power Connectors

D3. Grounding Connectors

E1. Labeling Systems

E2. Labels

E3. Pre-Printed & Write-On Markers

E4. Permanent Identification

E5. Lockout/Tagout & Safety Solutions

F. Index

## Wiring Duct for Control Panel Applications



### PanelMax™ DIN Rail Wiring Duct

1

Up to 30% space savings vs. conventional duct/rail layouts.

(pages C1.4 – C1.5)



### PanelMax™ Noise Shield

2

Installed separately or within wiring duct.

(pages C1.6 – C1.7)



### PanelMax™ Corner Wiring Duct

3

Up to 20% space savings in layouts with side and back panels

(pages C1.8 – C1.9)



### Hinged Cover Wiring Duct and Raceway

4

Wide slot, narrow slot wiring duct and solid wall raceway with hinging cover.

(pages C1.10 – C1.11)



### Halogen Free Wiring Duct

Up to 203°F (95°C) operating temperature.

(pages C1.22 – C1.24)



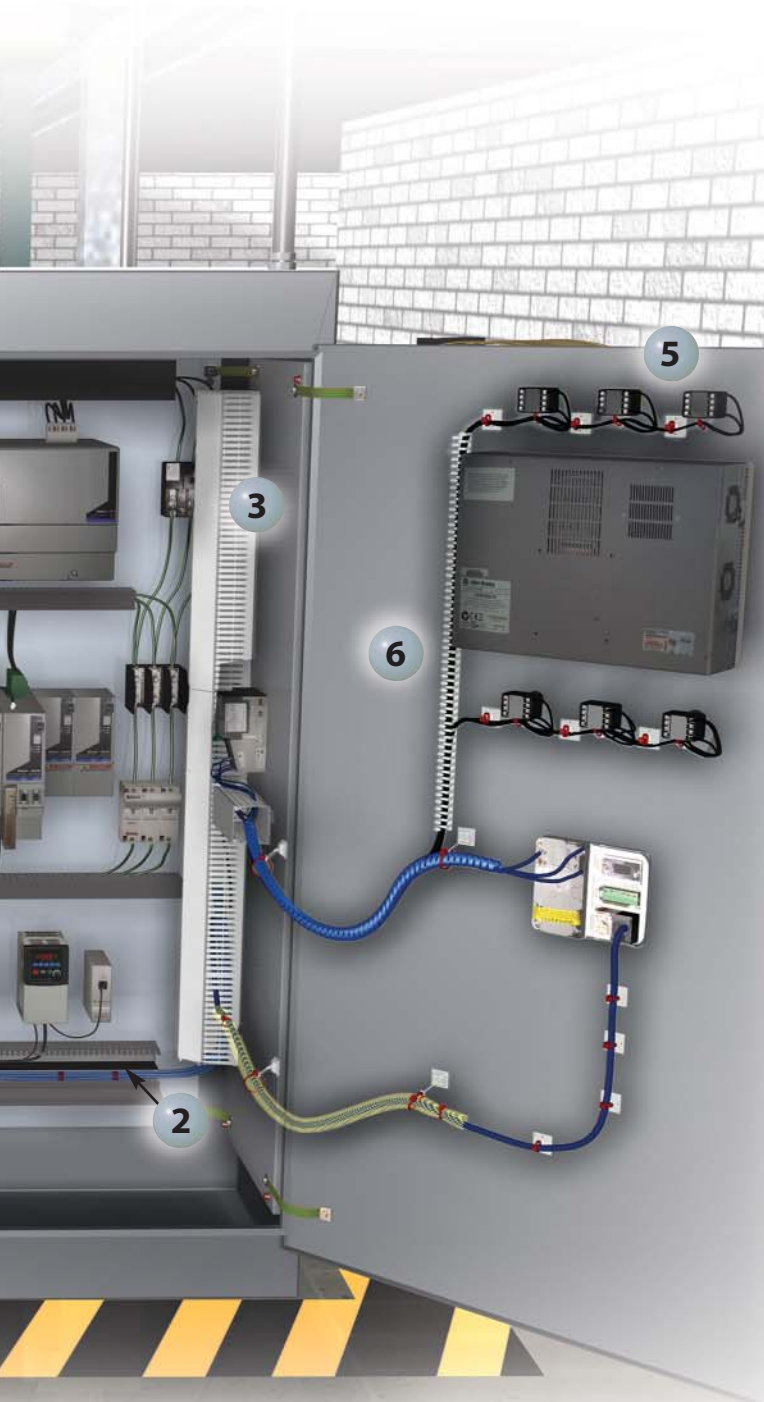

**Tools and Accessories**  
(pages C1.25 – C1.34)

**5**

**Type F Narrow Slot Wiring Duct**

Narrow slot, narrow finger design fits the spacing of high-density terminal blocks.

(pages C1.14 – C1.15)

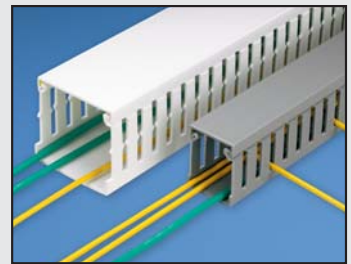

**Type G Wide Slot Wiring Duct**

Wide slot, wide finger design.

(pages C1.12 – C1.13)

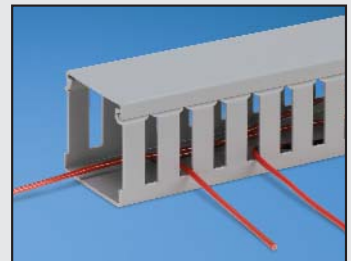

**Type D Round Hole Wiring Duct**

Multiple rows of holes to retain and support wire of variable heights and positions.

(pages C1.16 – C1.17)

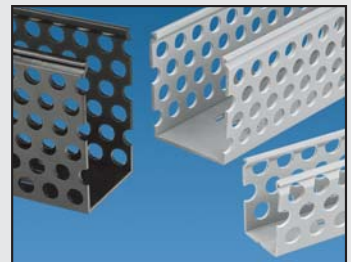

**Type MC Metric Wiring Duct**

Narrow slot, narrow finger design with DIN 43 659 mounting holes.

(pages C1.18 – C1.19)

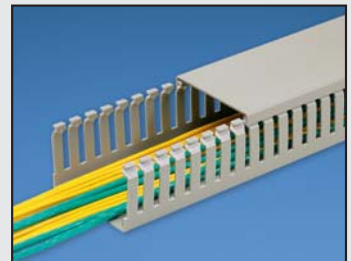

**6**

**Type FL Flexible Wiring Duct**

Solution for door mounted push-button wiring or tight spaces without cover access.

(page C1.26)



A. System Overview

B1. Cable Ties

B2. Cable Accessories

B3. Stainless Steel Ties

C1. Wiring Duct

C2. Surface Raceway

C3. Abrasion Protection

C4. Cable Management

D1. Terminals

D2. Power Connectors

D3. Grounding Connectors

E1. Labeling Systems

E2. Labels

E3. Pre-Printed & Write-On Markers

E4. Permanent Identification

E5. Lockout/Tagout & Safety Solutions

F. Index

A. System Overview

## Features and Benefits – Panduit® PanelMax™ DIN Rail Wiring Duct

B1. Cable Ties

B2. Cable Accessories

B3. Stainless Steel Ties

C1. Wiring Duct

C2. Surface Raceway

C3. Abrasion Protection

C4. Cable Management

**DIN rail and DIN component compatible**

**Unique finger/slot**  
progression for aesthetics and maximum slot capacity

**Hinged and flexible cover**  
acts as ledge for wire installation and flexes for easy opening and increased channel access for maintenance

**Integrated fastener slot**  
accepts supplied screw fasteners to install DIN rail (user supplied rail)

**Locating ribs**  
align and center DIN rail during installation

**Pass-through holes**  
shorten the wiring path between components on the same DIN rail

**Score lines** allow finger removal and base sidewall removal with sidewall notching tool



D1. Terminals

### Conventional Wiring Duct Panel Layout:

D2. Power Connectors

D3. Grounding Connectors

E1. Labeling Systems

E2. Labels

E3. Pre-Printed & Write-On Markers

E4. Permanent Identification

E5. Lockout/Tagout & Safety Solutions

F. Index

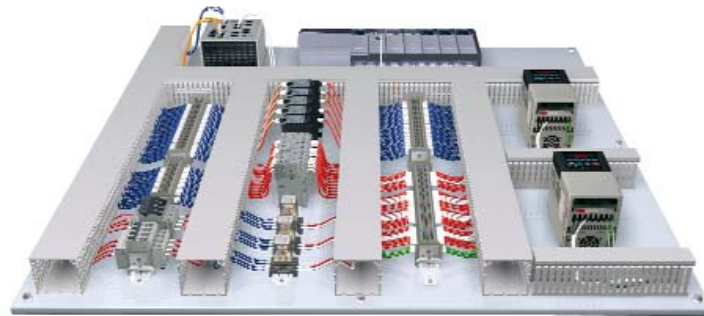

### DIN Rail Wiring Duct Panel Layout with 30% Space Savings:



Panduit® PanelMax™ DIN Rail Wiring Duct positions DIN rail and components off the panel directly above an integrated wire management channel for a 30%+ smaller footprint to the panel layout.

## c Panduct® PanelMax™ DIN Rail Wiring Duct



- Space saving design positions DIN rail and components off the panel directly above an integrated wire management channel for up to a 30% smaller footprint for duct and components; increased design flexibility and component access for easier installation and maintenance
- DIN rail and DIN component compatible with standard 35mm or 15mm rails and many DIN rail mount components for design flexibility
- Integrated DIN rail fastening slot allows the DIN rail to mount directly to product with plastic thread cutting screws for up to 40% faster duct and rail installation and reduced labor costs
- Hinged cover remains attached during maintenance and upgrades preventing lost covers, ensuring panel integrity, safety and aesthetics; L-shaped cover acts as ledge to aid wire installation for ease of use
- Slotted platform (horizontal) manage the wire from channel mounted components, outer sidewall slots (vertical) manage wire from adjacent panel mounted components; unique finger and slot progression for optimal wire management and aesthetics
- Channel pass through slots allows wires to transition internally between channels to ease wire connections to either side of components mounted on the same rail minimizing wire length and reducing material cost
- Optional wire retainer accessory retains cabling with cover opened or removed easing wire installation and future wire additions

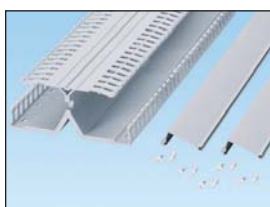

DRD



DRDWR

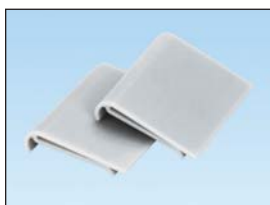

DRDCS

Part Number	Part Description	Std. Pkg. Qty.	Std. Ctn. Qty.
DRD22LG6	2" height PanelMax™ DIN Rail Wiring Duct with dual wiring channels. Base, covers and DIN rail fasteners included.	6 Ft.	6 Ft.
DRD33LG6	3" height PanelMax™ DIN Rail Wiring Duct with dual wiring channels. Base, covers and DIN rail fasteners included.	6 Ft.	6 Ft.
DRD44LG6	4" height PanelMax™ DIN Rail Wiring Duct with dual wiring channels. Base, covers and DIN rail fasteners included.	6 Ft.	6 Ft.
DRDC2LG6	2" replacement cover for PanelMax™ DIN Rail Wiring Duct.	6 Ft.	24 Ft.
DRDC3LG6	3" replacement cover for PanelMax™ DIN Rail Wiring Duct.	6 Ft.	24 Ft.
DRDC4LG6	4" replacement cover for PanelMax™ DIN Rail Wiring Duct.	6 Ft.	24 Ft.
DRDSF-C	Replacement DIN rail fasteners for PanelMax™ DIN Rail Wiring Duct.	100	—
DRDWR2-X	2" wire retainer for PanelMax™ DIN Rail Wiring Duct.	10	100
DRDWR3-X	3" wire retainer for PanelMax™ DIN Rail Wiring Duct.	10	100
DRDWR4-X	4" wire retainer for PanelMax™ DIN Rail Wiring Duct.	10	100
DRDCS2-X	2" corner strip for PanelMax™ DIN Rail Wiring Duct.	10	100
DRDCS3-X	3" corner strip for PanelMax™ DIN Rail Wiring Duct.	10	100
DRDCS4-X	4" corner strip for PanelMax™ DIN Rail Wiring Duct.	10	100

Product sold base and cover together in 6 ft. lengths. Replace LG with WH for white color.

A.  
System  
Overview

B1.  
Cable Ties

B2.  
Cable  
Accessories

B3.  
Stainless  
Steel Ties

C1.  
Wiring  
Duct

C2.  
Surface  
Raceway

C3.  
Abrasion  
Protection

C4.  
Cable  
Management

D1.  
Terminals

D2.  
Power  
Connectors

D3.  
Grounding  
Connectors

E1.  
Labeling  
Systems

E2.  
Labels

E3.  
Pre-Printed  
& Write-On  
Markers

E4.  
Permanent  
Identification

E5.  
Lockout/  
Tagout  
& Safety  
Solutions

F.  
Index

A. System Overview

## Features and Benefits – Panduit® PanelMax™ Noise Shield

B1. Cable Ties

B2. Cable Accessories

B3. Stainless Steel Ties

C1. Wiring Duct

C2. Surface Raceway

C3. Abrasion Protection

C4. Cable Management

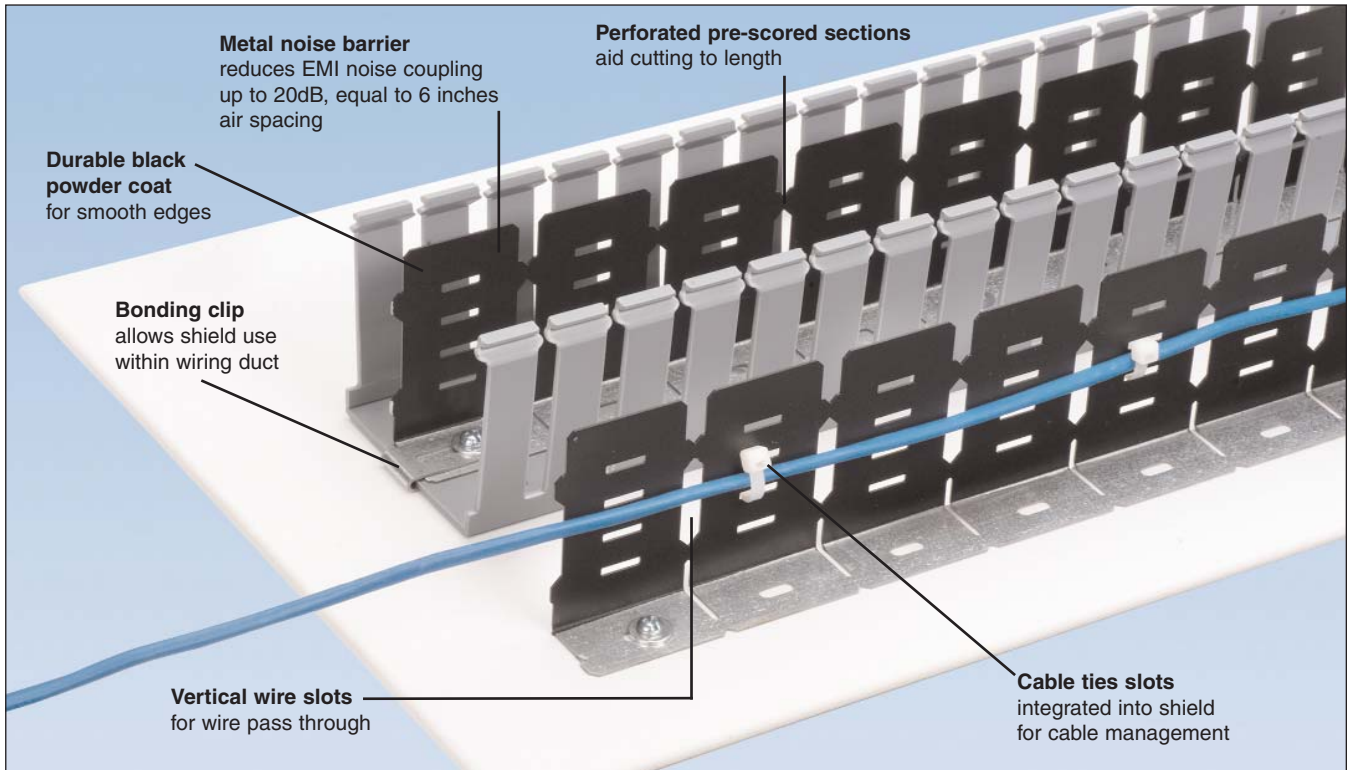

D1. Terminals

D2. Power Connectors

D3. Grounding Connectors

E1. Labeling Systems

E2. Labels

E3. Pre-Printed & Write-On Markers

E4. Permanent Identification

E5. Lockout/Tagout & Safety Solutions

F. Index



**PanelMax™ Noise Shield** separates drive cables and sensitive communication/signal cables within industrial control panels to reduce electromagnetic interference (EMI) while saving valuable space.



**Metal noise barrier** equivalent to 6 inches of air spacing between power and signal cables, saves valuable panel space.



**Perforated and pre-scored sections** make it easy to cut to length with minimal deburring required.



## Panduct® PanelMax™ Noise Shield

- Metal noise barrier reduces EMI noise coupling between noise emitting and sensitive cabling within a control panel; provides up to 20dB reduction in noise which is equivalent to 6 inches of air spacing
- Installs directly to metal panel surface or within 2, 3, or 4 inch height Panduit wiring duct (when shield is installed with supplied bonding clips)
- Perforated and pre-scored sections speed installation by allowing sections of the shield to be snapped off at pre-scored locations to easily cut to length with minimal deburring required

- Vertical wall slots allow wires to cross the barrier at 90° when necessary, providing greater design flexibility
- Horizontal cable tie slots allow cable bundles to be held in place using cable ties so cabling is kept near barrier for greater reliability and optimal aesthetics
- Zinc plated steel surface in contact areas with sub-panel and bonding clip ensures continuity and is corrosion resistant
- Black powder coated vertical surface for smooth edges
- Meets UL 508/508A requirements as a barrier between conductors

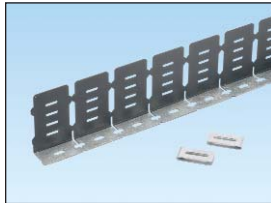

Part Number	Part Description	Std. Pkg. Qty.
SD2EMI	EMI Noise Shield kit for 2" height Panduit Wiring Duct; (2) three foot sections, bonding clips, and anti-oxidizing paste.	1
SD3EMI	EMI Noise Shield kit for 3" height Panduit Wiring Duct; (2) three foot sections, bonding clips, and anti-oxidizing paste.	1
SD4EMI	EMI Noise Shield kit for 4" height Panduit Wiring Duct; (2) three foot sections, bonding clips, and anti-oxidizing paste.	1

## Performance Characteristics

Relative noise reduction in dB over frequency range of the PanelMax™ Noise Shield is shown below.

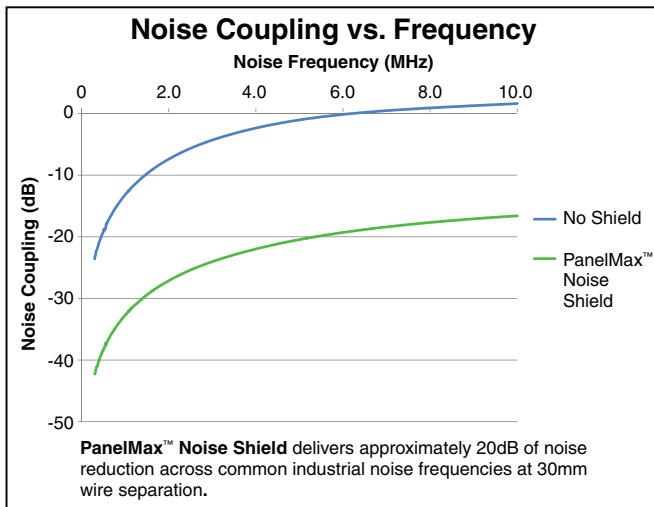

A.  
System  
Overview

B1.  
Cable Ties

B2.  
Cable  
Accessories

B3.  
Stainless  
Steel Ties

C1.  
Wiring  
Duct

C2.  
Surface  
Raceway

C3.  
Abrasion  
Protection

C4.  
Cable  
Management

D1.  
Terminals

D2.  
Power  
Connectors

D3.  
Grounding  
Connectors

E1.  
Labeling  
Systems

E2.  
Labels

E3.  
Pre-Printed  
& Write-On  
Markers

E4.  
Permanent  
Identification

E5.  
Lockout/  
Tagout  
& Safety  
Solutions

F.  
Index

A. System Overview

## Features and Benefits – Panduit® PanelMax™ Corner Wiring Duct

B1. Cable Ties

B2. Cable Accessories

B3. Stainless Steel Ties

C1. Wiring Duct

C2. Surface Raceway

C3. Abrasion Protection

C4. Cable Management

D1. Terminals

D2. Power Connectors

D3. Grounding Connectors

E1. Labeling Systems

E2. Labels

E3. Pre-Printed & Write-On Markers

E4. Permanent Identification

E5. Lockout/Tagout & Safety Solutions

F. Index

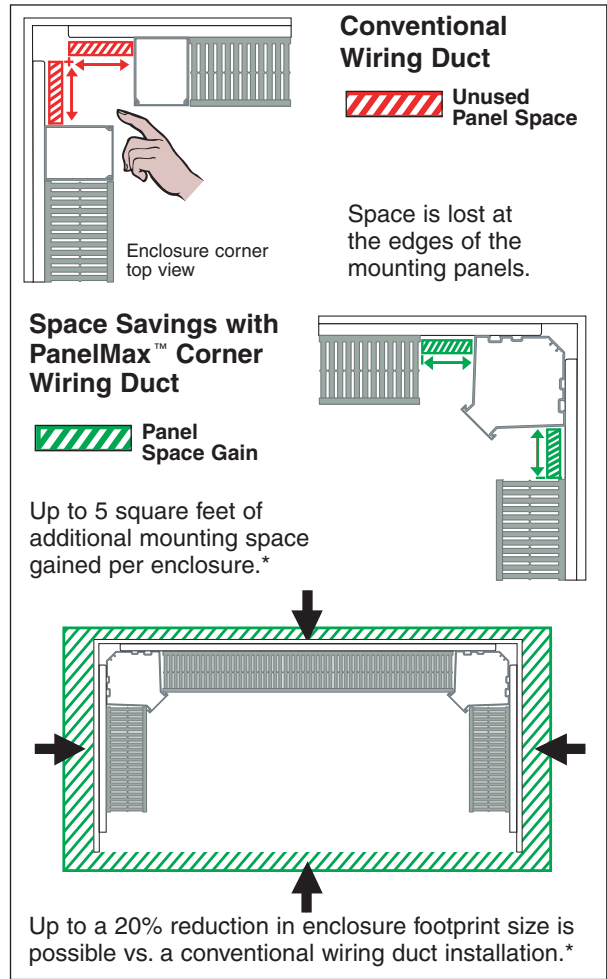
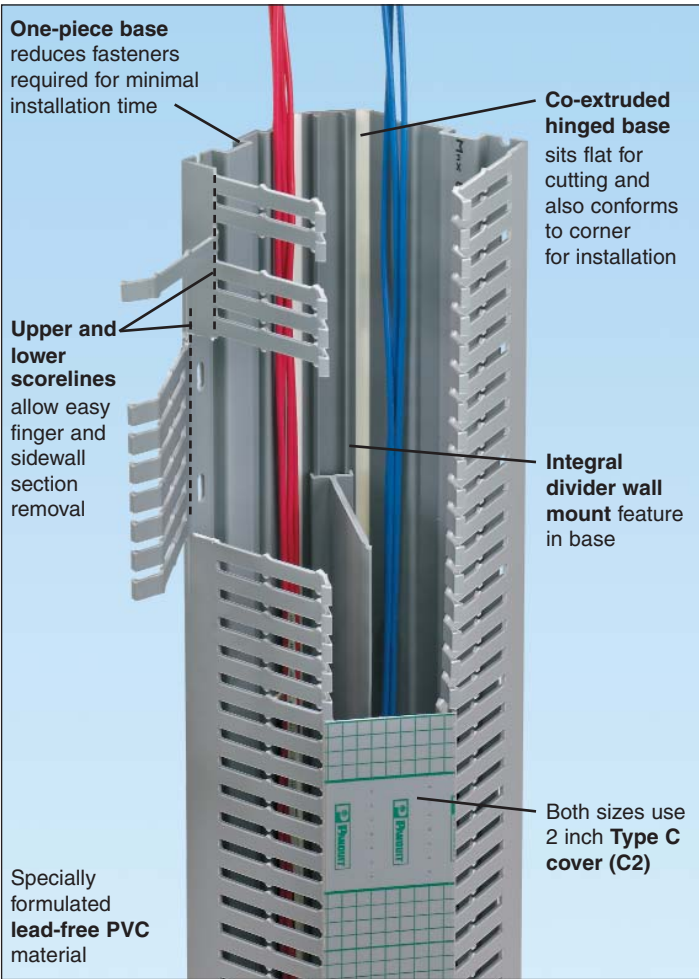

**Panduit® Nylon Rivets**  
Fast, lowest cost mounting method.  
(see page C1.34)



**Panduit® Installation Tools**  
Wide selection of hand tools for cutting and installing wiring duct.  
(see page C1.34)

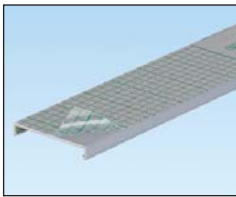

**Panduit® Type C Cover with Protective Film**  
Reduces scrap and labor costs by protecting the surface during storage, handling, and installation.  
(see page C1.9)

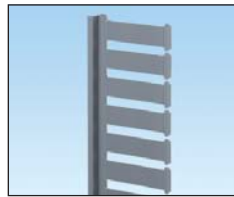

**Panduit® Divider Wall**  
Creates separate wiring channels within the wiring duct base. Available in solid or slotted wall styles.  
(see page C1.26)

\*Actual subpanel space savings will vary depending on wiring duct size, component layout, and enclosure size and type. Footprint savings is based on commercially available enclosures and may not be achievable in some applications.



## PanelMax™ Corner Wiring Duct

- Fits in the unused space in the vertical corner of enclosures, gaining sub-panel space or saving enclosure footprint area
- One-piece base requires less time to install than multi-piece solutions
- Optional quick mount clips engage anywhere along the product base further reducing assembly costs
- Panduit divider wall snaps directly to the integrated mounting feature in the channel to create two separate channels
- Compatible with Panduit 3" and 4" height wiring duct; both product sizes use standard 2 inch wiring duct cover
- Base and cover length is 6 feet.
- Base and covers sold separately



Base Part Number	Duct Size W x H (In.)	Slot Width		Cover Part Number	Std. Pkg. Qty.	Base Ctn. Qty.	Cover Ctn. Qty.
		In.	mm				
CWD3LG6	4.40 x 3.57	0.20	5.0	C2LG6	6	24	120
CWD4LG6	5.33 x 4.58	0.20	5.0	C2LG6	6	24	120
CWD3WH6	4.40 x 3.57	0.20	5.0	C2WH6	6	24	120
CWD4WH6	5.33 x 4.58	0.20	5.0	C2WH6	6	24	120

Part number shown in LG (Light Gray) color, also available in WH (White) color. Product available in 6' lengths.

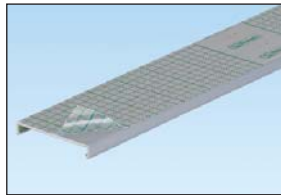
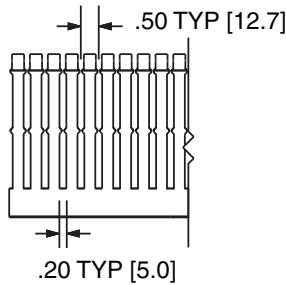
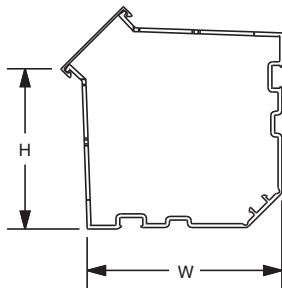

To order cover with protective film add "-F" to part number. 6" cover not available with protective film.



CDLB



CDCLP

Part Number	Part Description	Fastener Size	Std. Pkg. Qty.	Std. Ctn. Qty.
<b>Quick Mount Clips</b>				
CDLB3	L-bracket with quick mounting clip for installing CWD3 to back panel only.	#10-32 x 1/4 (user supplied)	16	—
CDLB4	L-bracket with quick mounting clip for installing CWD4 to back panel only.	#10-32 x 1/4 (user supplied)	16	—
CDCLP3	Quick mounting clip for installing CWD3 corner wiring duct.	#10-32 x 1/4 (user supplied)	16	—
CDCLP4	Quick mounting clip for installing CWD4 corner wiring duct.	#10-32 x 1/4 (user supplied)	16	—

A. System Overview

B1. Cable Ties

B2. Cable Accessories

B3. Stainless Steel Ties

C1. Wiring Duct

C2. Surface Raceway

C3. Abrasion Protection

C4. Cable Management

D1. Terminals

D2. Power Connectors

D3. Grounding Connectors

E1. Labeling Systems

E2. Labels

E3. Pre-Printed & Write-On Markers

E4. Permanent Identification

E5. Lockout/Tagout & Safety Solutions

F. Index

A. System Overview

## Features and Benefits – Panduit® Type H and HN Hinged Cover Wiring Duct

Available in eight sizes from 1.5" x 2" up to 4" x 4" in light gray, black, and white colors.

B1. Cable Ties

B2. Cable Accessories

B3. Stainless Steel Ties

C1. Wiring Duct

C2. Surface Raceway

C3. Abrasion Protection

C4. Cable Management

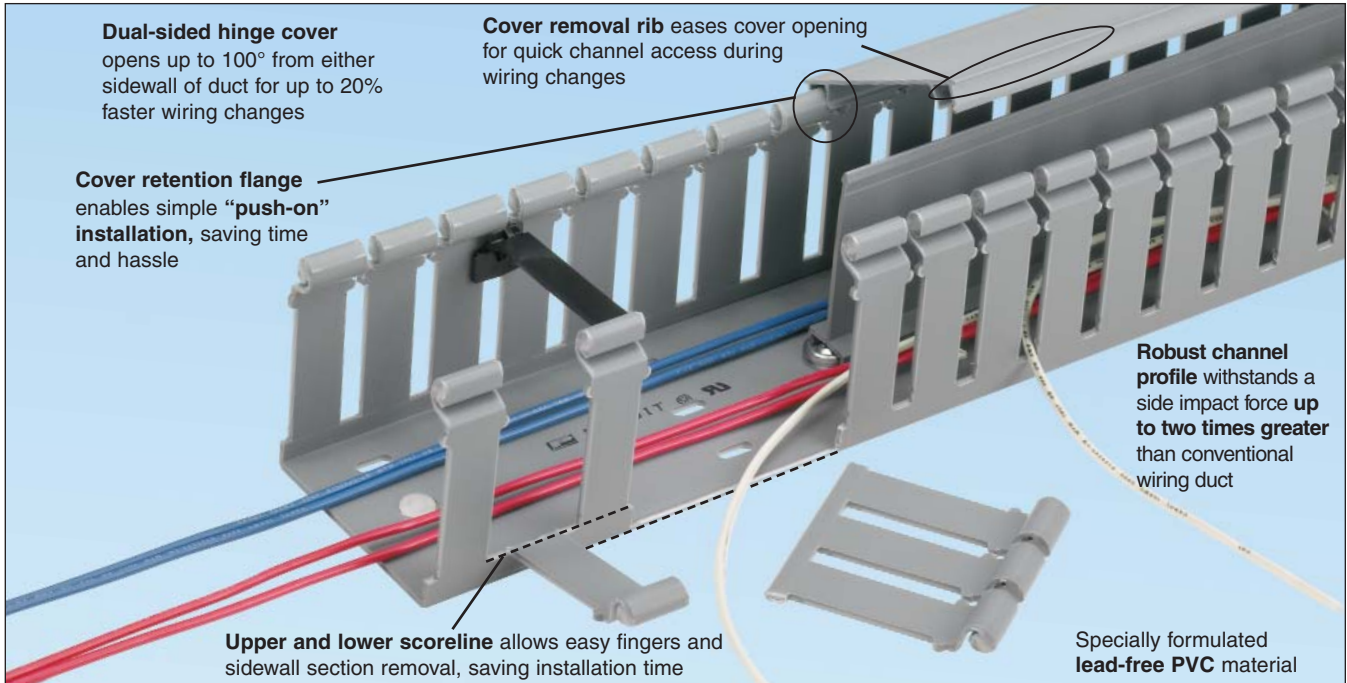

D1. Terminals

### Labor Savings

- By avoiding the time and hassle in removing and replacing covers, simple wiring changes can be made up to **20% faster** compared to conventional wiring duct installations\*

D2. Power Connectors

### Avoid Cover Replacement Costs

- Covers represent 20% of the cost of the wiring duct purchase
- Misplaced covers are a common occurrence after years of use
- Not needing to remove covers during maintenance ensures **better aesthetics and safety** and **avoids the cost to replace lost covers**

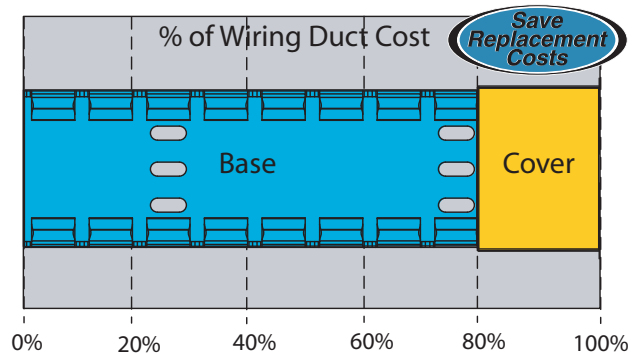

D3. Grounding Connectors

E1. Labeling Systems

E2. Labels

E3. Pre-Printed & Write-On Markers

E4. Permanent Identification

E5. Lockout/Tagout & Safety Solutions

F. Index



**Panduit® Wire Retainers**  
Contain wiring when duct cover is opened. Wire retainers snap easily between duct fingers.  
(see page C1.28)



**Panduit® Divider Wall**  
Create separate wiring channels within the wiring duct base. Available in solid or slotted wall styles.  
(see page C1.26)



**Panduit® Installation Tools**  
Wide selection of hand tools for cutting and installing wiring duct.  
(see page C1.34)



**Panduit® Nylon Rivets**  
Fast, lowest cost mounting method.  
(see page C1.34)

\*Based on mock panel installations of type H hinged cover wiring duct and other commonly available wiring ducts adding a single component with four wires.

## **UL** Panduct® Type HN Hinged Cover Narrow Slot Wiring Duct

- Narrow slot/finger design provides excellent wire management with smaller wire diameters and high-density components such as terminal blocks, input/output devices, and other hardware
- Material: Lead-free PVC
- UL Recognized continuous use temperature: 122°F (50°C)
- UL 94 flammability rating of V-0
- Conforms with NFPA 79-2007 section 13.3.1 requirement for flame retardant material
- Provided with mounting holes
- Base and cover length is 6 feet

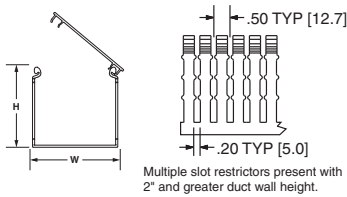
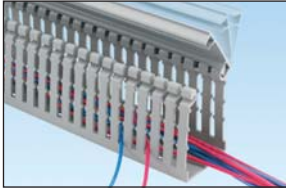

Base Part Number	Duct Size (W x H)*		Slot Width		Cover Part Number	Std. Pkg. Qty.	Base Ctn. Qty.	Cover Ctn. Qty.
	In.	mm	In.	mm				
HN1.5X2LG6	1.75 x 1.98	44.5 x 50.3	0.20	5.0	HC1.5LG6	6	120	120
HN1.5X3LG6	1.75 x 3.06	44.5 x 77.7	0.20	5.0	HC1.5LG6	6	120	120
HN2X2LG6	2.17 x 1.98	55.1 x 50.3	0.20	5.0	HC2LG6	6	120	120
HN2X3LG6	2.17 x 3.06	55.1 x 77.7	0.20	5.0	HC2LG6	6	60	120
HN2X4LG6	2.17 x 4.10	55.1 x 104.1	0.20	5.0	HC2LG6	6	60	120
HN3X3LG6	3.25 x 3.06	82.6 x 77.7	0.20	5.0	HC3LG6	6	60	120
HN3X4LG6	3.25 x 4.10	82.6 x 104.1	0.20	5.0	HC3LG6	6	60	120
HN4X4LG6	4.25 x 4.10	108.0 x 104.1	0.20	5.0	HC4LG6	6	60	60

Part Number shown for LG (Light Gray). Available in WH (White).  
Base and cover sold separately.  
\*\*"H" dimension includes duct and cover.

## **UL** Panduct® Type H Hinged Cover Wide Slot Wiring Duct

- Wide slot/finger design provides excellent wire management in general purpose applications and is compatible with a wide range of wire sizes and component types
- Material: Lead-free PVC
- Rated for continuous use temperature: 122°F (50°C)
- UL 94 flammability rating of V-0
- Conforms with NFPA 79-2007 section 13.3.1 requirement for flame retardant material
- Provided with standard mounting holes
- Base and cover length is 6 ft.

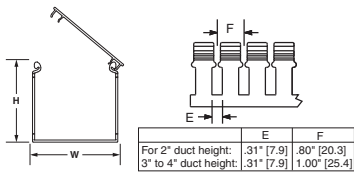
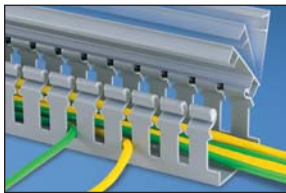

Base Part Number	Duct Size (W x H)*		Slot Width		Cover Part Number	Std. Pkg. Qty.	Base Ctn. Qty.	Cover Ctn. Qty.
	In.	mm	In.	mm				
H1.5X2LG6	1.75 x 1.98	44.5 x 50.3	.31	7.9	HC1.5LG6	6	120	120
H1.5X3LG6	1.75 x 3.06	44.5 x 77.7	.31	7.9	HC1.5LG6	6	120	120
H2X2LG6	2.17 x 1.98	55.1 x 50.3	.31	7.9	HC2LG6	6	120	120
H2X3LG6	2.17 x 3.06	55.1 x 77.7	.31	7.9	HC2LG6	6	60	120
H2X4LG6	2.17 x 4.10	55.1 x 104.1	.31	7.9	HC2LG6	6	60	120
H3X3LG6	3.25 x 3.06	82.6 x 77.7	.31	7.9	HC3LG6	6	60	120
H3X4LG6	3.25 x 4.10	82.6 x 104.1	.31	7.9	HC3LG6	6	60	120
H4X4LG6	4.25 x 4.10	108.0 x 104.1	.31	7.9	HC4LG6	6	60	60

Part Number shown for LG (Light Gray). Available in BL (Black) and WH (White).  
Base and cover sold separately.  
\*\*"H" dimension includes duct and cover.

## **UL** Panduct® Type HS Hinged Cover Solid Wall Raceway

- Solid wall raceway conceals and protects wiring in continuous runs such as in low-voltage cord management applications between control panel stations in conveyor systems
- Material: Lead-free PVC
- UL recognized continuous use temperature: 122°F (50°C)
- UL 94 flammability rating of V-0
- Supplied without mounting holes
- Base and cover length is 6 feet

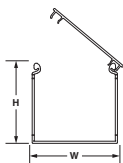
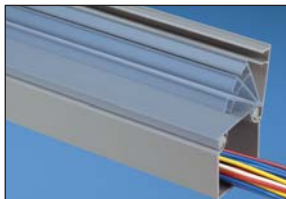

Base Part Number	Duct Size (W x H)*		Cover Part Number	Std. Pkg. Qty.	Base Ctn. Qty.	Cover Ctn. Qty.
	In.	mm				
HS1.5X2LG6NM	1.75 x 1.98	44.5 x 50.3	HC1.5LG6	6	120	120
HS1.5X3LG6NM	1.75 x 3.06	44.5 x 77.7	HC1.5LG6	6	60	120
HS2X2LG6NM	2.17 x 1.98	55.1 x 50.3	HC2LG6	6	120	120
HS2X3LG6NM	2.17 x 3.06	55.1 x 77.7	HC2LG6	6	60	120
HS2X4LG6NM	2.17 x 4.10	55.1 x 104.1	HC2LG6	6	60	120
HS3X3LG6NM	3.25 x 3.06	82.6 x 77.7	HC3LG6	6	60	120
HS3X4LG6NM	3.25 x 4.10	82.6 x 104.1	HC3LG6	6	60	120
HS4X4LG6NM	4.25 x 4.10	108.0 x 104.1	HC4LG6	6	60	60

Part Number shown for LG (Light Gray). For BL (Black) and WH (White) colors see color selection guide, page C1.48.  
Base and cover sold separately.  
\*\*"H" dimension includes duct and cover.

A.  
System Overview

B1.  
Cable Ties

B2.  
Cable Accessories

B3.  
Stainless Steel Ties

C1.  
Wiring Duct

C2.  
Surface Raceway

C3.  
Abrasion Protection

C4.  
Cable Management

D1.  
Terminals

D2.  
Power Connectors

D3.  
Grounding Connectors

E1.  
Labeling Systems

E2.  
Labels

E3.  
Pre-Printed & Write-On Markers

E4.  
Permanent Identification

E5.  
Lockout/Tagout & Safety Solutions

F.  
Index

A. System Overview

## Features and Benefits – Panduit® Type G Wide Slot Wiring Duct

Available in 35 sizes from .5" x .5" up to 6" x 4" in a variety of colors.

B1. Cable Ties

B2. Cable Accessories

B3. Stainless Steel Ties

C1. Wiring Duct

C2. Surface Raceway

C3. Abrasion Protection

C4. Cable Management



D1. Terminals

D2. Power Connectors

D3. Grounding Connectors

E1. Labeling Systems

E2. Labels

E3. Pre-Printed & Write-On Markers

E4. Permanent Identification

E5. Lockout/Tagout & Safety Solutions

F. Index



**Panduit® Wire Retainers**  
Contain wiring when duct cover is opened. Wire retainers snap easily between duct fingers. See page C1.28.



**Panduit® Divider Wall**  
Create separate wiring channels within the wiring duct base. Available in solid or slotted wall styles. See page C1.26.

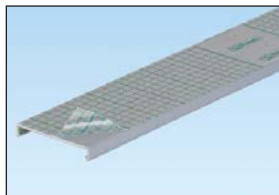

**Panduit® Type C Cover with Protective Film**  
Reduces scrap and labor costs by protecting the surface during storage, handling, and installation. See page C1.13.



**Panduit® Nylon Rivets**  
Fast, lowest cost mounting method. See page C1.34.



**Panduit® Installation Tools**  
Wide selection of hand tools for cutting and installing wiring duct. See page C1.34.

## Panduct® Type G Wide Slot Wiring Duct

- Wide slot/finger design provides greater sidewall rigidity and can be used with a wide range of wire bundle sizes
- Material: Lead-free PVC
- UL recognized continuous use temperature: 122°F (50°C)
- UL 94 flammability rating of V-0
- Conforms with NFPA 79-2007 section 13.3.1 requirement for flame retardant material
- Provided with mounting holes
- Base and cover length is 6 feet

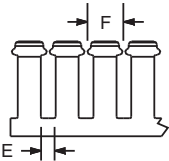
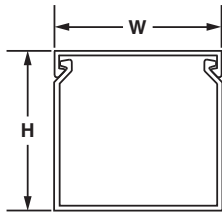
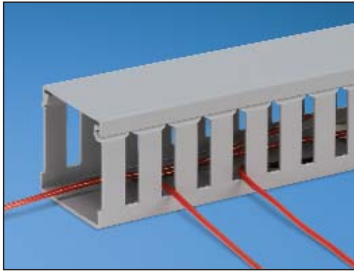

	E	F
For .5" duct height:	0.37" [9.4]	0.80" [20.3]
0.75" to 2" duct height:	0.31" [7.9]	0.80" [20.3]
3" to 4" duct height:	0.31" [7.9]	1.00" [25.4]
5" duct height:	0.38" [9.4]	1.33" [33.8]

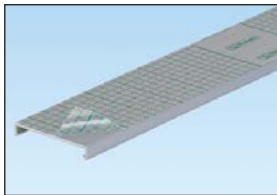

To order cover with protective film add "-F" to part number. 6" cover not available with film.

Base Part Number	Duct Size (W x H)*		Slot Width		Cover Part Number	Std. Pkg. Qty.	Base Ctn. Qty.	Cover Ctn. Qty.
	In.	mm	In.	mm				
G.5X.5LG6	0.69 x 0.60	17.5 x 15.2	0.38	9.7	C.5LG6	6	120	120
G.5X1LG6	0.69 x 1.06	17.5 x 26.9	0.31	7.9	C.5LG6	6	120	120
G.5X2LG6	0.69 x 2.03	17.5 x 51.6	0.31	7.9	C.5LG6	6	120	120
G.75X.75LG6	0.93 x 0.82	23.6 x 20.8	0.31	7.9	C.75LG6	6	120	120
G.75X1LG6	0.93 x 1.06	23.6 x 26.9	0.31	7.9	C.75LG6	6	120	120
G.75X1.5LG6	0.93 x 1.57	23.6 x 39.9	0.31	7.9	C.75LG6	6	120	120
G.75X2LG6	0.93 x 2.03	23.6 x 51.7	0.31	7.9	C.75LG6	6	120	120
G1X1LG6	1.26 x 1.12	32.0 x 28.4	0.31	7.9	C1LG6	6	120	120
G1X1.5LG6	1.26 x 1.62	32.0 x 41.1	0.31	7.9	C1LG6	6	120	120
G1X2LG6	1.26 x 2.12	32.0 x 53.8	0.31	7.9	C1LG6	6	120	120
G1X3LG6	1.26 x 3.12	32.0 x 79.2	0.31	7.9	C1LG6	6	120	120
G1X4LG6	1.26 x 4.10	32.0 x 104.1	0.31	7.9	C1LG6	6	60	120
G1.5X1LG6	1.75 x 1.12	44.5 x 28.4	0.31	7.9	C1.5LG6	6	120	120
G1.5X1.5LG6	1.75 x 1.62	44.5 x 41.1	0.31	7.9	C1.5LG6	6	120	120
G1.5X2LG6	1.75 x 2.12	44.5 x 53.8	0.31	7.9	C1.5LG6	6	120	120
G1.5X3LG6	1.75 x 3.12	44.5 x 79.2	0.31	7.9	C1.5LG6	6	120	120
G1.5X4LG6	1.75 x 4.10	44.5 x 104.1	0.31	7.9	C1.5LG6	6	60	120
G2X1LG6	2.25 x 1.12	57.2 x 28.4	0.31	7.9	C2LG6	6	120	120
G2X1.5LG6	2.25 x 1.62	57.2 x 41.1	0.31	7.9	C2LG6	6	120	120
G2X2LG6	2.25 x 2.12	57.2 x 53.8	0.31	7.9	C2LG6	6	120	120
G2X3LG6	2.25 x 3.12	57.2 x 79.2	0.31	7.9	C2LG6	6	60	120
G2X4LG6	2.25 x 4.10	57.2 x 104.1	0.31	7.9	C2LG6	6	60	120
G2X5LG6	2.25 x 5.10	57.2 x 129.5	0.38	9.7	C2LG6	6	60	120
G2.5X3LG6	2.75 x 3.12	69.9 x 79.2	0.31	7.9	C2.5LG6	6	120	120
G3X1LG6	3.25 x 1.12	82.6 x 28.4	0.31	7.9	C3LG6	6	120	120
G3X2LG6	3.25 x 2.12	82.6 x 53.8	0.31	7.9	C3LG6	6	120	120
G3X3LG6	3.25 x 3.12	82.6 x 79.2	0.31	7.9	C3LG6	6	60	120
G3X4LG6	3.25 x 4.10	82.6 x 104.1	0.31	7.9	C3LG6	6	60	120
G3X5LG6	3.25 x 5.10	82.6 x 129.5	0.38	9.7	C3LG6	6	60	120
G4X1.5LG6	4.25 x 1.62	108.0 x 41.1	0.31	7.9	C4LG6	6	120	120
G4X2LG6	4.25 x 2.12	108.0 x 53.8	0.31	7.9	C4LG6	6	60	120
G4X3LG6	4.25 x 3.12	108.0 x 79.2	0.31	7.9	C4LG6	6	60	120
G4X4LG6	4.25 x 4.10	108.0 x 104.1	0.31	7.9	C4LG6	6	60	120
G4X5LG6	4.25 x 5.10	108.0 x 129.5	0.38	9.7	C4LG6	6	60	120
G6X4LG6	6.25 x 4.15	158.8 x 105.4	0.31	7.9	C6LG6	6	60	120

Part number shown for LG (Light Gray). For other color availability see color selection guide, page C1.48. Base and cover sold separately.

\*\*"H" dimension includes duct and cover.

A.  
System  
Overview

B1.  
Cable Ties

B2.  
Cable  
Accessories

B3.  
Stainless  
Steel Ties

C1.  
Wiring  
Duct

C2.  
Surface  
Raceway

C3.  
Abrasion  
Protection

C4.  
Cable  
Management

D1.  
Terminals

D2.  
Power  
Connectors

D3.  
Grounding  
Connectors

E1.  
Labeling  
Systems

E2.  
Labels

E3.  
Pre-Printed  
& Write-On  
Markers

E4.  
Permanent  
Identification

E5.  
Lockout/  
Tagout  
& Safety  
Solutions

F.  
Index

A. System Overview

## Features and Benefits – Panduit® Type F Narrow Slot Wiring Duct

B1. Cable Ties

Available in 31 sizes from .5" x .5" up to 6" x 4" in a variety of colors.

B2. Cable Accessories

B3. Stainless Steel Ties

C1. Wiring Duct

C2. Surface Raceway

C3. Abrasion Protection

C4. Cable Management

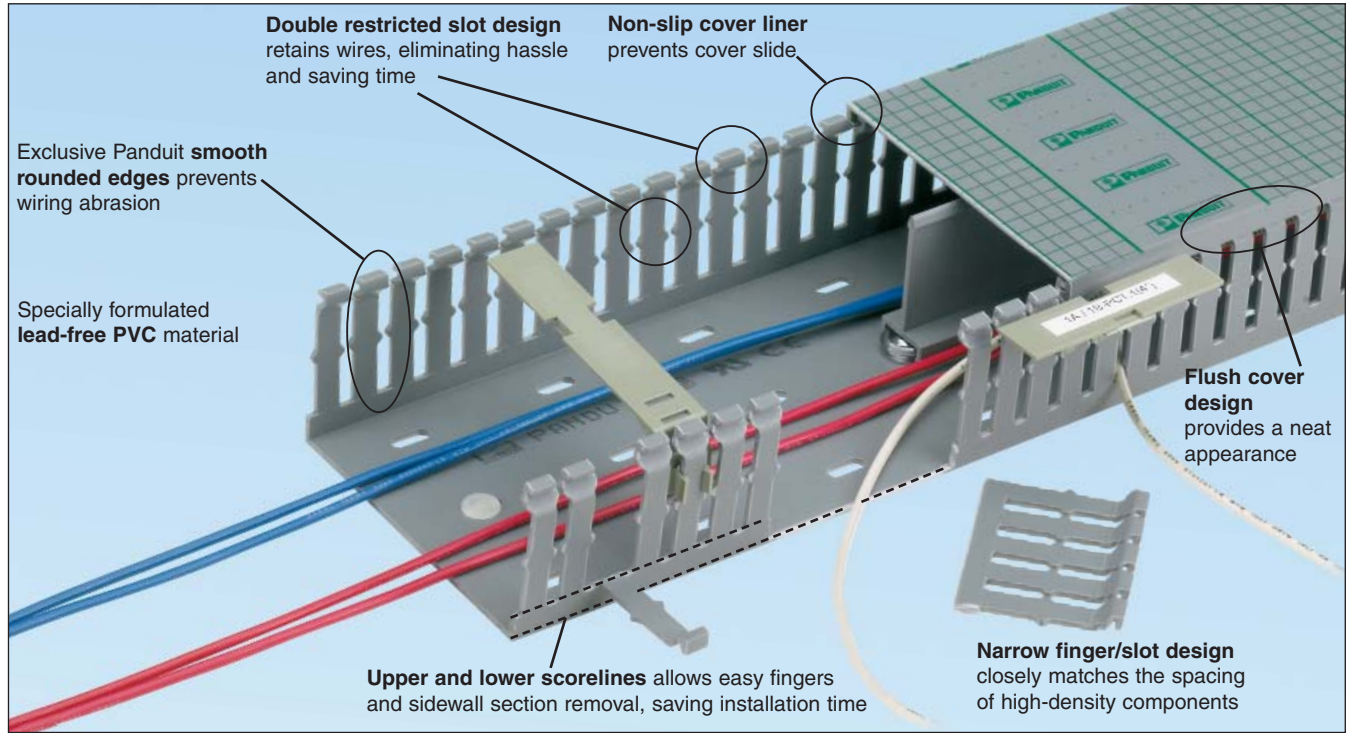

D1. Terminals

D2. Power Connectors

D3. Grounding Connectors

E1. Labeling Systems

E2. Labels

E3. Pre-Printed & Write-On Markers

E4. Permanent Identification

E5. Lockout/Tagout & Safety Solutions

F. Index



**Panduit® Wire Retainers for Type F Wiring Duct**  
Contain wiring when duct cover is opened. Wire retainers snap easily between duct fingers. (see page C1.29)



**Panduit® Divider Wall**  
Create separate wiring channels within the wiring duct base. Available in solid or slotted wall styles. (see page C1.26)

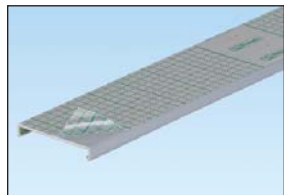

**Panduit® Type C Cover with Protective Film**  
Reduces scrap and labor costs by protecting the surface during storage, handling, and installation. (see page C1.15)



**Panduit® Nylon Rivets**  
Fast, lowest cost mounting method. (see page C1.34)



**Panduit® Installation Tools**  
Wide selection of hand tools for cutting and installing wiring duct. (see page C1.34)

## Panduct® Type F Narrow Slot Wiring Duct

- Narrow slot/finger design provides more slots to fit the spacing of high-density terminal blocks and other hardware
- Material: Lead-free PVC
- UL recognized continuous use temperature: 122°F (50°C)
- UL 94 flammability rating of V-0
- Conforms with NFPA 79-2007 section 13.3.1 requirement for flame retardant material
- Provided with mounting holes
- Base and cover length is 6 feet

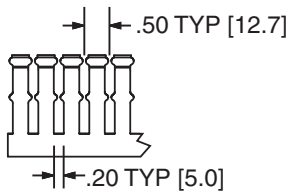
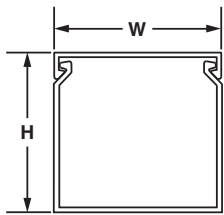
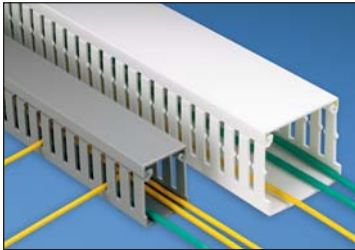

Multiple slot restrictors present with 2" and greater duct wall height.



To order cover with protective film add "-F" to part number. 6" cover not available with film.



Base Part Number	Duct Size (W x H)*		Slot Width		Cover Part Number	Std. Pkg. Qty.	Base Ctn. Qty.	Cover Ctn. Qty.
	In.	mm	In.	mm				
F.5X.5LG6	0.69 x 0.60	17.5 x 15.2	0.20	5.0	C.5LG6	6	120	120
F.5X1LG6	0.69 x 1.06	17.5 x 26.9	0.20	5.0	C.5LG6	6	120	120
F.75X.75LG6	0.93 x 0.82	23.6 x 20.9	0.20	5.0	C.75LG6	6	120	120
F.75X1.5LG6	0.93 x 1.57	23.6 x 39.9	0.20	5.0	C.75LG6	6	120	120
F1X1LG6	1.26 x 1.13	32.0 x 28.7	0.20	5.0	C1LG6	6	120	120
F1X1.5LG6	1.26 x 1.62	32.0 x 41.1	0.20	5.0	C1LG6	6	120	120
F1X2LG6	1.26 x 2.12	32.0 x 53.8	0.20	5.0	C1LG6	6	120	120
F1X3LG6	1.26 x 3.12	32.0 x 79.2	0.20	5.0	C1LG6	6	120	120
F1X4LG6	1.26 x 4.10	32.0 x 104.1	0.20	5.0	C1LG6	6	60	120
F1.5X1LG6	1.75 x 1.12	44.5 x 28.4	0.20	5.0	C1.5LG6	6	120	120
F1.5X1.5LG6	1.75 x 1.62	44.5 x 41.1	0.20	5.0	C1.5LG6	6	120	120
F1.5X2LG6	1.75 x 2.12	44.5 x 53.8	0.20	5.0	C1.5LG6	6	120	120
F1.5X3LG6	1.75 x 3.12	44.5 x 79.2	0.20	5.0	C1.5LG6	6	120	120
F1.5X4LG6	1.75 x 4.10	44.5 x 104.1	0.20	5.0	C1.5LG6	6	60	120
F2X1LG6	2.25 x 1.12	57.2 x 28.4	0.20	5.0	C2LG6	6	120	120
F2X1.5LG6	2.25 x 1.62	57.2 x 41.1	0.20	5.0	C2LG6	6	120	120
F2X2LG6	2.25 x 2.12	57.2 x 53.8	0.20	5.0	C2LG6	6	120	120
F2X3LG6	2.25 x 3.12	57.2 x 79.2	0.20	5.0	C2LG6	6	60	120
F2X4LG6	2.25 x 4.10	57.2 x 104.1	0.20	5.0	C2LG6	6	60	120
F2X5LG6	2.25 x 5.10	57.2 x 129.5	0.20	5.0	C2LG6	6	60	120
F2.5X3LG6	2.75 x 3.12	69.9 x 79.2	0.20	5.0	C2.5LG6	6	120	120
F3X1LG6	3.25 x 1.12	82.6 x 28.4	0.20	5.0	C3LG6	6	120	120
F3X2LG6	3.25 x 2.12	82.6 x 53.8	0.20	5.0	C3LG6	6	120	120
F3X3LG6	3.25 x 3.12	82.6 x 79.2	0.20	5.0	C3LG6	6	60	120
F3X4LG6	3.25 x 4.10	82.6 x 104.1	0.20	5.0	C3LG6	6	60	120
F3X5LG6	3.25 x 5.10	82.6 x 129.5	0.20	5.0	C3LG6	6	60	120
F4X2LG6	4.25 x 2.12	108.0 x 53.8	0.20	5.0	C4LG6	6	60	120
F4X3LG6	4.25 x 3.12	108.0 x 79.2	0.20	5.0	C4LG6	6	60	120
F4X4LG6	4.25 x 4.10	108.0 x 104.1	0.20	5.0	C4LG6	6	60	120
F4X5LG6	4.25 x 5.10	108.0 x 129.5	0.20	5.0	C4LG6	6	60	120
F6X4LG6	6.25 x 4.15	158.8 x 105.4	0.20	5.0	C6LG6	6	60	120

Part number shown for LG (Light Gray). For other color availability see color selection guide, page C1.48. Base and cover sold separately.

\*"H" dimension includes duct and cover.

A. System Overview

B1. Cable Ties

B2. Cable Accessories

B3. Stainless Steel Ties

C1. Wiring Duct

C2. Surface Raceway

C3. Abrasion Protection

C4. Cable Management

D1. Terminals

D2. Power Connectors

D3. Grounding Connectors

E1. Labeling Systems

E2. Labels

E3. Pre-Printed & Write-On Markers

E4. Permanent Identification

E5. Lockout/Tagout & Safety Solutions

F. Index

A. System Overview

## Features and Benefits – Panduit® Flush Cover Type D Round Hole Wiring Duct

Available in sixteen sizes from 1" x 2" up to 4" x 4" in a variety of colors.

B1. Cable Ties

B2. Cable Accessories

B3. Stainless Steel Ties

C1. Wiring Duct

C2. Surface Raceway

C3. Abrasion Protection

C4. Cable Management



D1. Terminals

D2. Power Connectors

D3. Grounding Connectors

E1. Labeling Systems

E2. Labels

E3. Pre-Printed & Write-On Markers

E4. Permanent Identification

E5. Lockout/Tagout & Safety Solutions

F. Index



### Panduit® Wire Retainers for Type D Wiring Duct

Contain wiring when duct cover is opened. Wire retainers mount onto walls with pressure sensitive adhesive. (see page C1.28)



### Panduit® Divider Wall

Create separate wiring channels within the wiring duct base. Available in solid or slotted wall styles. (see page C1.26)



### Panduit® Type C Cover with Protective Film

Reduces scrap and labor costs by protecting the surface during storage, handling, and installation. (see page C1.17)



### Panduit® Nylon Rivets

Fast, lowest cost mounting method. (see page C1.34)



### Panduit® Installation Tools

Wide selection of hand tools for cutting and installing wiring duct. (see page C1.34)



## UL® CE Panduct® Flush Cover Type D Round Hole Wiring Duct

- Round hole design has multiple rows of holes to retain and support wire at variable heights and positions
- Material: Lead-free PVC
- UL recognized continuous use temperature: 122°F (50°C)
- UL 94 flammability rating of V-0
- Conforms with NFPA 79-2007 section 13.3.1 requirement for flame retardant material
- Provided with mounting holes
- Base and cover length is 6 feet



For 2" duct height = 3 rows of holes  
 3" duct height = 4 rows of holes  
 4" duct height = 6 rows of holes

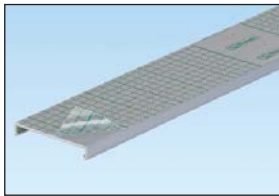

To order cover with protective film add "-F" to part number. 6" cover not available with film.

Base Part Number	Duct Size (W x H)*		Cover Part Number	Std. Pkg. Qty.	Base Ctn. Qty.	Cover Ctn. Qty.
	In.	mm				
D1X2LG6	1.26 x 2.12	32.0 x 53.8	C1LG6	6	120	120
D1X3LG6	1.26 x 3.12	32.0 x 79.2	C1LG6	6	120	120
D1X4LG6	1.26 x 4.10	32.0 x 104.1	C1LG6	6	120	120
D1.5X2LG6	1.75 x 2.12	44.5 x 53.8	C1.5LG6	6	120	120
D1.5X3LG6	1.75 x 3.12	44.5 x 79.2	C1.5LG6	6	120	120
D1.5X4LG6	1.75 x 4.10	44.5 x 104.1	C1.5LG6	6	60	120
D2X2LG6	2.25 x 2.12	57.2 x 53.8	C2LG6	6	120	120
D2X3LG6	2.25 x 3.12	57.2 x 79.2	C2LG6	6	60	120
D2X4LG6	2.25 x 4.10	57.2 x 104.1	C2LG6	6	60	120
D2.5X3LG6	2.75 x 3.12	69.9 x 79.2	C2.5LG6	6	120	120
D3X2LG6	3.25 x 2.12	82.6 x 53.8	C3LG6	6	120	120
D3X3LG6	3.25 x 3.12	82.6 x 79.2	C3LG6	6	60	120
D3X4LG6	3.25 x 4.10	82.6 x 104.1	C3LG6	6	60	120
D4X2LG6	4.25 x 2.12	108.0 x 53.8	C4LG6	6	60	120
D4X3LG6	4.25 x 3.12	108.0 x 79.2	C4LG6	6	60	120
D4X4LG6	4.25 x 4.10	108.0 x 104.1	C4LG6	6	60	120

Part number shown for LG (Light Gray). For other color availability see color selection guide, page C1.48.  
 Base and cover sold separately.  
 \*\*"H" dimension includes duct and cover.

A. System Overview

B1. Cable Ties

B2. Cable Accessories

B3. Stainless Steel Ties

C1. Wiring Duct

C2. Surface Raceway

C3. Abrasion Protection

C4. Cable Management

D1. Terminals

D2. Power Connectors

D3. Grounding Connectors

E1. Labeling Systems

E2. Labels

E3. Pre-Printed & Write-On Markers

E4. Permanent Identification

E5. Lockout/Tagout & Safety Solutions

F. Index

A. System Overview

## Features and Benefits – Panduit® Type MC Metric Narrow Slot Wiring Duct

Available in 20 sizes from 25mm x 25mm up to 100mm x 100mm in international gray and white colors.

B1. Cable Ties

B2. Cable Accessories

B3. Stainless Steel Ties

C1. Wiring Duct

C2. Surface Raceway

C3. Abrasion Protection

C4. Cable Management

D1. Terminals

D2. Power Connectors

D3. Grounding Connectors

E1. Labeling Systems

E2. Labels

E3. Pre-Printed & Write-On Markers

E4. Permanent Identification

E5. Lockout/Tagout & Safety Solutions

F. Index



**Panduit® Wire Retainers for Type MC Wiring Duct**  
Contain wiring when duct cover is opened. Wire retainers snap easily between duct fingers. (see page C1.29)



**Panduit® Divider Wall**  
Create separate wiring channels within the wiring duct base. Available in solid or slotted wall styles. (see page C1.26)



**Panduit® Installation Tools**  
Wide selection of hand tools for cutting and installing wiring duct. (see page C1.34)



**Panduit® Nylon Rivets**  
Fast, lowest cost mounting method. (see page C1.34)

## Panduct® Type MC Metric Narrow Slot Wiring Duct

- CE compliant and metric sizing for control panels intended for European applications
- Material: Lead-free PVC
- UL recognized continuous use temperature: 122°F (50°C)
- UL 94 flammability rating of V-0
- Conforms with NFPA 79-2007 section 13.3.1 requirement for flame retardant material
- Provided with DIN 43 659 mounting holes
- Duct and cover packaged together in 2m lengths

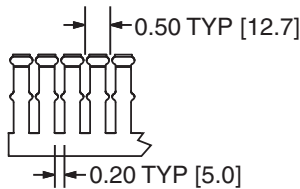
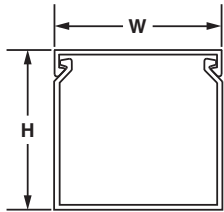
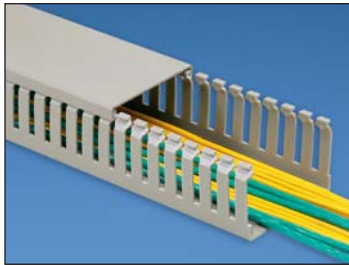

Multiple slot restrictors present with 62mm and greater duct wall height.

Base and Cover Part Number	Duct Size (W x H)*		Slot Width		Replacement Cover Part Number	Base and Cover Pkg. Qty. (m)	Replacement Cover Std. Pkg. Qty.
	mm	In.	In.	mm			
MC25X25IG2	24.6 x 23.6	0.97 x 0.93	0.20	5.0	C25IG2	20	20
MC25X37IG2	24.6 x 35.8	0.97 x 1.41	0.20	5.0	C25IG2	20	20
MC25X50IG2	24.6 x 47.8	0.97 x 1.88	0.20	5.0	C25IG2	20	20
MC25X62IG2	24.6 x 59.7	0.97 x 2.35	0.20	5.0	C25IG2	20	20
MC25X75IG2	24.6 x 72.4	0.97 x 2.85	0.20	5.0	C25IG2	20	20
MC37X37IG2	37.1 x 35.8	1.46 x 1.41	0.20	5.0	C37IG2	20	20
MC37X50IG2	37.1 x 47.8	1.46 x 1.88	0.20	5.0	C37IG2	20	20
MC37X62IG2	37.1 x 59.7	1.46 x 2.35	0.20	5.0	C37IG2	20	20
MC37X75IG2	37.1 x 72.4	1.46 x 2.85	0.20	5.0	C37IG2	20	20
MC50X50IG2	49.5 x 47.8	1.95 x 1.89	0.20	5.0	C50IG2	20	20
MC50X75IG2	49.5 x 72.4	1.95 x 2.85	0.20	5.0	C50IG2	10	20
MC50X100IG2	49.5 x 97.8	1.95 x 3.85	0.20	5.0	C50IG2	10	20
MC62X62IG2	62.0 x 59.7	2.44 x 2.35	0.20	5.0	C62IG2	20	20
MC75X50IG2	74.7 x 48.0	2.94 x 1.89	0.20	5.0	C75IG2	20	20
MC75X62IG2	74.7 x 59.7	2.94 x 2.35	0.20	5.0	C75IG2	20	20
MC75X75IG2	74.7 x 72.4	2.94 x 2.85	0.20	5.0	C75IG2	10	20
MC75X100IG2	74.7 x 97.8	2.94 x 3.85	0.20	5.0	C75IG2	10	20
MC100X50IG2	99.6 x 48.0	3.92 x 1.89	0.20	5.0	C100IG2	10	20
MC100X75IG2	99.6 x 72.4	3.92 x 2.85	0.20	5.0	C100IG2	10	20
MC100X100IG2	99.6 x 97.8	3.92 x 3.85	0.20	5.0	C100IG2	10	20

Available in IG (International Gray) and WH (White) colors.  
Base and cover sold together.  
\*H" dimension includes duct and cover.

A.  
System  
Overview

B1.  
Cable Ties

B2.  
Cable  
Accessories

B3.  
Stainless  
Steel Ties

C1.  
Wiring  
Duct

C2.  
Surface  
Raceway

C3.  
Abrasion  
Protection

C4.  
Cable  
Management

D1.  
Terminals

D2.  
Power  
Connectors

D3.  
Grounding  
Connectors

E1.  
Labeling  
Systems

E2.  
Labels

E3.  
Pre-Printed  
& Write-On  
Markers

E4.  
Permanent  
Identification

E5.  
Lockout/  
Tagout  
& Safety  
Solutions

F.  
Index

A. System Overview

## Features and Benefits – Panduct® Type FS Solid Wall Raceway

Available in 27 sizes from .5" x .5" up to 6" x 4" in a variety of colors.

B1. Cable Ties

B2. Cable Accessories

B3. Stainless Steel Ties

C1. Wiring Duct

C2. Surface Raceway

C3. Abrasion Protection

C4. Cable Management

D1. Terminals

D2. Power Connectors

D3. Grounding Connectors

E1. Labeling Systems

E2. Labels

E3. Pre-Printed & Write-On Markers

E4. Permanent Identification

E5. Lockout/Tagout & Safety Solutions

F. Index

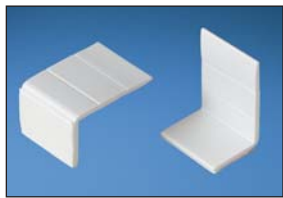
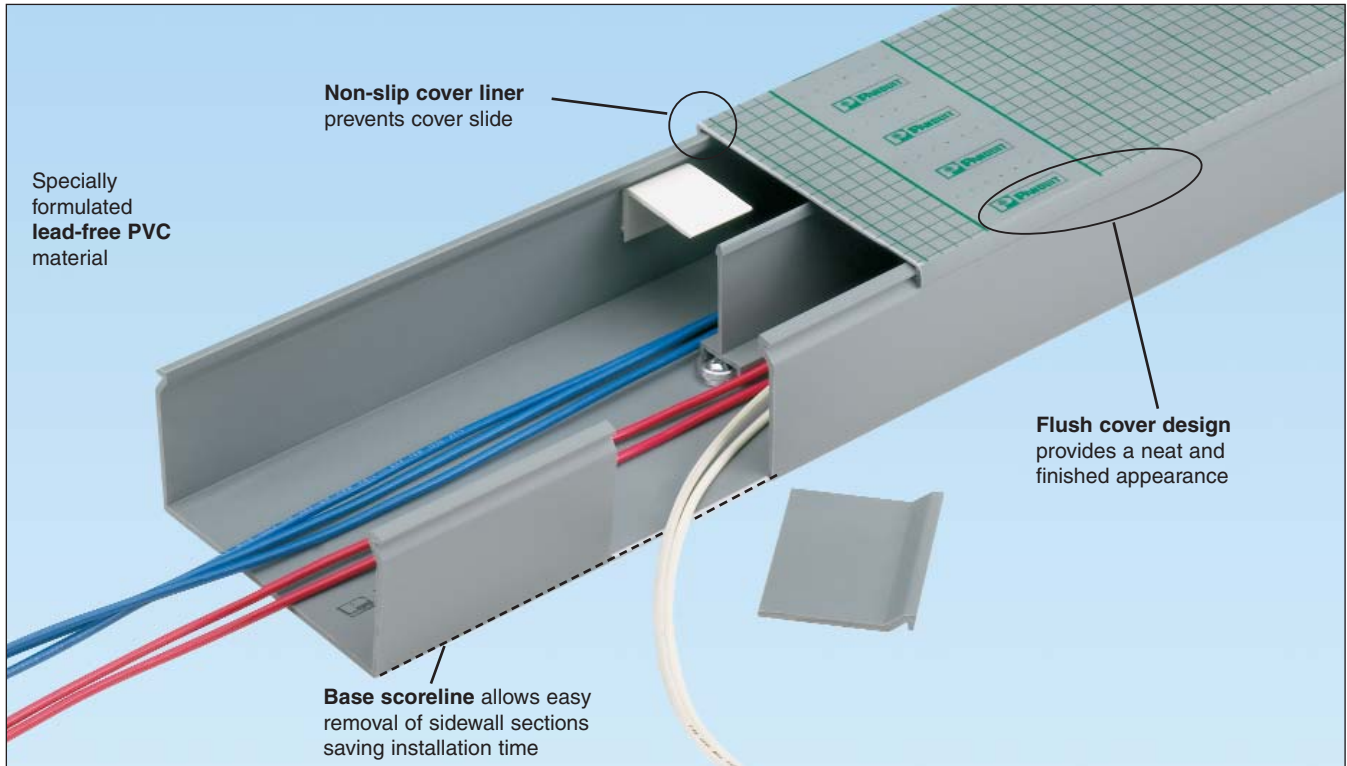

**Panduct® Wire Retainers for Type FS Solid Wall Raceway**  
Contain wiring when duct cover is opened. Wire retainers mount onto walls with pressure sensitive adhesive. (see page C1.28)



**Panduct® Divider Wall**  
Create separate wiring channels within the wiring duct base. Available in solid or slotted wall styles. (see page C1.26)

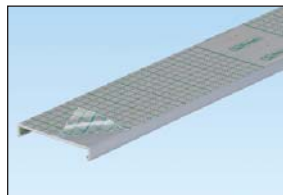

**Panduct® Type C Cover with Protective Film**  
Reduces scrap and labor costs by protecting the surface during storage, handling, and installation. (see page C1.21)



**Panduct® Nylon Rivets**  
Fast, lowest cost mounting method. (see page C1.34)



**Panduct® Installation Tools**  
Wide selection of hand tools for cutting and installing wiring duct. (see page C1.34)

## Panduit® Type FS Solid Wall Raceway

- Solid wall design fully encloses cables providing maximum protection and aesthetics
- Material: Lead-free PVC

- UL recognized continuous use temperature: 122°F (50°C)
- UL 94 flammability rating of V-0
- Base and cover length is 6 feet

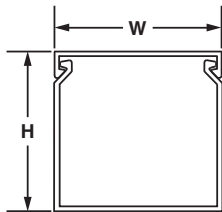
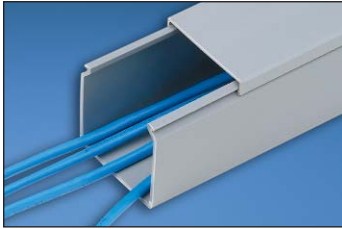

Base Part Number	Duct Size (W x H)*		Cover Part Number	Std. Pkg. Qty.	Base Ctn. Qty.	Cover Ctn. Qty.
	In.	mm				
> FS.5X.5LG6NM	.69 x .60	17.5 x 15.2	C.5LG6	6	120	120
> FS.5X1LG6NM	.69 x 1.06	17.5 x 26.9	C.5LG6	6	120	120
> FS.75X.75LG6NM	.93 x .82	23.6 x 20.8	C.75LG6	6	120	120
> FS1X1LG6NM	1.26 x 1.12	32.0 x 28.4	C1LG6	6	120	120
> FS1X1.5LG6NM	1.26 x 1.62	32.0 x 41.1	C1LG6	6	120	120
> FS1X2LG6NM	1.26 x 2.12	32.0 x 53.8	C1LG6	6	120	120
> FS1X3LG6NM	1.26 x 3.12	32.0 x 79.2	C1LG6	6	120	120
> FS1X4LG6NM	1.26 x 4.10	32.0 x 104.1	C1LG6	6	60	120
> FS1.5X1LG6NM	1.75 x 1.12	44.5 x 28.4	C1.5LG6	6	120	120
> FS1.5X1.5LG6NM	1.75 x 1.62	44.5 x 41.1	C1.5LG6	6	120	120
> FS1.5X2LG6NM	1.75 x 2.12	44.5 x 53.8	C1.5LG6	6	120	120
> FS1.5X3LG6NM	1.75 x 3.12	44.5 x 79.2	C1.5LG6	6	120	120
> FS2X1LG6NM	2.25 x 1.12	57.2 x 28.4	C2LG6	6	120	120
> FS2X1.5LG6NM	2.25 x 1.62	57.2 x 41.1	C2LG6	6	120	120
> FS2X2LG6NM	2.25 x 2.12	57.2 x 53.8	C2LG6	6	120	120
> FS2X3LG6NM	2.25 x 3.12	57.2 x 79.2	C2LG6	6	60	120
> FS2X4LG6NM	2.25 x 4.10	57.2 x 104.1	C2LG6	6	60	120
> FS3X1LG6NM	3.25 x 1.12	82.6 x 28.4	C3LG6	6	120	120
> FS3X2LG6NM	3.25 x 2.12	82.6 x 53.8	C3LG6	6	120	120
> FS3X3LG6NM	3.25 x 3.12	82.6 x 79.2	C3LG6	6	60	120
> FS3X4LG6NM	3.25 x 4.10	82.6 x 104.1	C3LG6	6	60	120
> FS3X5LG6NM	3.25 x 5.10	82.6 x 129.5	C3LG6	6	60	120
> FS4X2LG6NM	4.25 x 2.12	108.0 x 53.8	C4LG6	6	60	120
> FS4X3LG6NM	4.25 x 3.12	108.0 x 79.2	C4LG6	6	60	120
> FS4X4LG6NM	4.25 x 4.10	108.0 x 104.1	C4LG6	6	60	120
> FS4X5LG6NM	4.25 x 5.10	108.0 x 129.5	C4LG6	6	60	120
> FS6X4LG6NM	6.25 x 4.15	158.8 x 105.4	C6LG6	6	60	120

>Parts are available with mounting holes. To order with mounting holes, remove NM from part number. Part Number shown for LG (Light Gray). For other color availability see Color Selection Guide, page C1.48. Base and cover sold separately.

\*"H" dimension includes duct and cover.

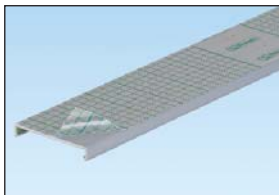

To order cover with protective film add "-F" to part number. 6" cover not available with film.

A. System Overview

B1. Cable Ties

B2. Cable Accessories

B3. Stainless Steel Ties

C1. Wiring Duct

C2. Surface Raceway

C3. Abrasion Protection

C4. Cable Management

D1. Terminals

D2. Power Connectors

D3. Grounding Connectors

E1. Labeling Systems

E2. Labels

E3. Pre-Printed & Write-On Markers

E4. Permanent Identification

E5. Lockout/Tagout & Safety Solutions

F. Index

A. System Overview

## Wiring Duct for Special Environments

B1. Cable Ties

### Features and Benefits – Panduct® Type NNC Halogen-Free Metric Wiring Duct

Available in fourteen sizes from 25mm x 25mm up to 100mm x 100mm in light gray and white.

B2. Cable Accessories

B3. Stainless Steel Ties

C1. Wiring Duct

C2. Surface Raceway

C3. Abrasion Protection

C4. Cable Management

D1. Terminals

D2. Power Connectors

D3. Grounding Connectors

E1. Labeling Systems

E2. Labels

E3. Pre-Printed & Write-On Markers

E4. Permanent Identification

E5. Lockout/Tagout & Safety Solutions

F. Index

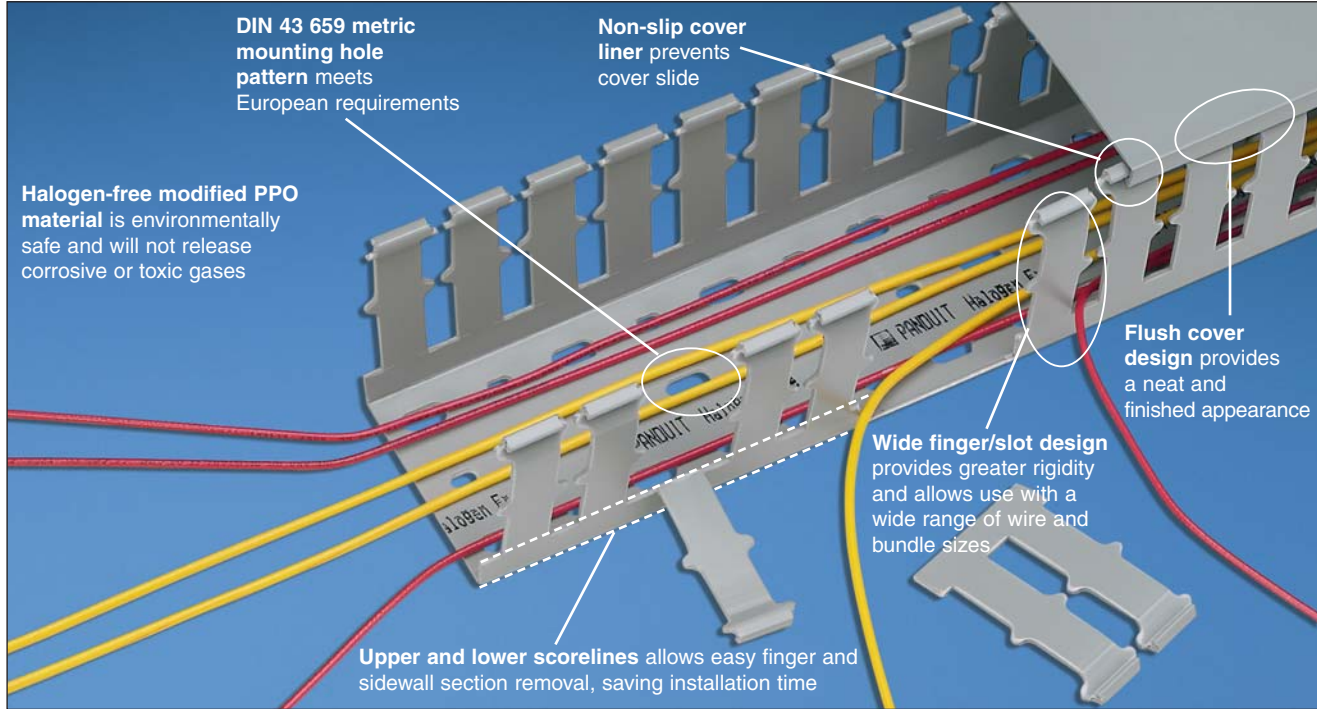

**Panduct® Type NNC Halogen-Free Solid Divider Wall**  
Create separate wiring channels within the wiring duct base. (see page C1.23)



**Panduct® Nylon Rivets**  
Fast, lowest cost mounting method. (see page C1.34)



**Panduct® Installation Tools**  
Wide selection of hand tools for cutting and installing wiring duct. (see page C1.34)

## UL® SP® C E Panduct® Type NNC Halogen-Free Metric Wiring Duct

- Material: Halogen-free modified polyphenylene oxide (mPPO) material as verified with IEC 60754-2 test method (test on gases evolved during combustion of electric cables)
- UL recognized continuous use temperature: 203°F (95°C)
- UL 94 flammability rating of V-0

- Conforms with NFPA 79-2007 section 13.3.1 requirement for flame retardant material
- Provided with DIN 43 659 mounting holes
- Metric sizing and finger progression
- Duct and cover packaged together in two meter lengths

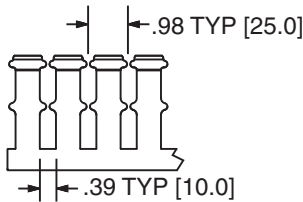
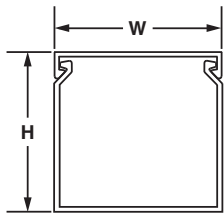
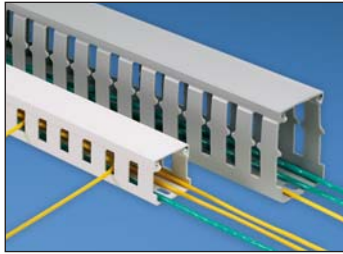

Multiple slot restrictors present with 75mm and greater duct wall height.

Base and Cover Part Number	Duct Size (W x H)*		Slot Width		Replacement Cover Part Number	Base and Cover Ctn. Qty. (m)	Replacement Cover Ctn. Qty. (m)
	mm	In.	In.	mm			
NNC25X25LG2	24.6 x 23.6	.97 x .93	.39	10.0	NC25LG2	20	20
NNC25X37LG2	24.6 x 35.8	.97 x 1.41	.39	10.0	NC25LG2	20	20
NNC25X50LG2	24.6 x 47.8	.97 x 1.88	.39	10.0	NC25LG2	20	20
NNC25X75LG2	24.6 x 72.4	.97 x 2.85	.39	10.0	NC25LG2	20	20
NNC37X37LG2	37.1 x 35.8	1.46 x 1.41	.39	10.0	NC37LG2	20	20
NNC37X50LG2	37.1 x 47.8	1.46 x 1.88	.39	10.0	NC37LG2	20	20
NNC37X75LG2	37.1 x 72.4	1.46 x 2.85	.39	10.0	NC37LG2	20	20
NNC50X50LG2	49.5 x 47.8	1.95 x 1.88	.39	10.0	NC50LG2	20	20
NNC50X75LG2	49.5 x 72.4	1.95 x 2.85	.39	10.0	NC50LG2	10	20
NNC50X100LG2	49.5 x 97.8	1.95 x 3.85	.39	10.0	NC50LG2	10	20
NNC75X75LG2	74.7 x 72.4	2.94 x 2.85	.39	10.0	NC75LG2	10	20
NNC100X50LG2	99.6 x 47.8	3.92 x 1.88	.39	10.0	NC100LG2	10	20
NNC100X75LG2	99.6 x 72.4	3.92 x 2.85	.39	10.0	NC100LG2	10	20
NNC100X100LG2	99.6 x 97.8	3.92 x 3.85	.39	10.0	NC100LG2	10	20

Available in LG (Light Gray) and WH (White).

Do not allow cutting, tapping, or cleaning fluids that contain hydrocarbons to come in contact with type NNC wiring duct as it will cause stress cracking. See page C1.49 for a list of chemicals to avoid.

\*"H" dimension includes duct and cover.

## Panduct® Type NNC Divider Wall

- NNC solid divider wall can be mounted inside NNC and NE wiring duct to create multiple channels
- Material: Halogen-free modified polyphenylene oxide (mPPO)

- Simply install the divider wall base when mounting the duct and snap the divider wall onto mounting base, DB-C



Part Number	Length (m)	For Nominal Duct Height (mm)	Std. Pkg. Qty.	Std. Ctn. Qty. (m)
NNC50DWH2	2	50	2	40
NNC75DWH2	2	75	2	40

Available in WH (White) color only.

NOTE: Must be used with mounting base DB-C (see page C1.26), which is sold separately. Install mounting bases to the duct channel, locate within 2" of each divider wall end and at least every 12" along the length.

A. System Overview

B1. Cable Ties

B2. Cable Accessories

B3. Stainless Steel Ties

C1. Wiring Duct

C2. Surface Raceway

C3. Abrasion Protection

C4. Cable Management

D1. Terminals

D2. Power Connectors

D3. Grounding Connectors

E1. Labeling Systems

E2. Labels

E3. Pre-Printed & Write-On Markers

E4. Permanent Identification

E5. Lockout/Tagout & Safety Solutions

F. Index

A. System Overview

## Panduit® Type NE Halogen-Free Wiring Duct

B1. Cable Ties

- Material: Halogen-free modified polyphenylene oxide (mPPO)
- UL recognized continuous use temperature: 203°F (95°C)
- UL 94 flammability rating of V-0
- Provided with mounting holes
- Base and cover length is 6 feet

B2. Cable Accessories



B3. Stainless Steel Ties

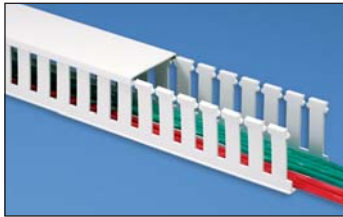

C1. Wiring Duct

C2. Surface Raceway

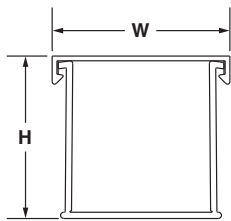

C3. Abrasion Protection

C4. Cable Management

D1. Terminals

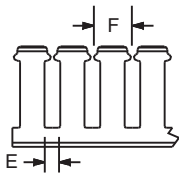

D2. Power Connectors

	E	F
For .5" duct height:	.37" [9.4]	.80" [20.3]
1" to 2" duct height:	.31" [7.9]	.80" [20.3]
3" to 4" duct height:	.31" [7.9]	1.00" [25.4]
5" duct height:	.38" [9.4]	1.33" [33.8]

D3. Grounding Connectors

E1. Labeling Systems

E2. Labels

E3. Pre-Printed & Write-On Markers

E4. Permanent Identification

E5. Lockout/Tagout & Safety Solutions

F. Index

Base Part Number	Duct Size (W x H)*		Slot Width		Cover Part Number	Std. Pkg. Qty.	Base Ctn. Qty.	Cover Ctn. Qty.
	In.	mm	In.	mm				
NE.5X.5WH6	.63 x .56	16.0 x 14.2	.38	9.7	NC.5WH6	6	120	120
NE.5X1WH6	.63 x 1.06	16.0 x 26.9	.31	7.9	NC.5WH6	6	120	120
NE1X1WH6	1.14 x 1.06	29.0 x 26.9	.31	7.9	NC1WH6	6	120	120
NE1X1.5WH6	1.14 x 1.62	29.0 x 41.1	.31	7.9	NC1WH6	6	120	120
NE1X2WH6	1.14 x 2.06	29.0 x 52.3	.31	7.9	NC1WH6	6	120	120
NE1X3WH6	1.14 x 3.06	29.0 x 77.7	.31	7.9	NC1WH6	6	120	120
NE1X4WH6	1.14 x 4.06	29.0 x 103.1	.31	7.9	NC1WH6	6	60	120
NE1.5X1.5WH6	1.64 x 1.62	41.7 x 41.1	.31	7.9	NC1.5WH6	6	120	120
NE1.5X2WH6	1.64 x 2.06	41.7 x 52.3	.31	7.9	NC1.5WH6	6	120	120
NE1.5X3WH6	1.64 x 3.06	41.7 x 77.7	.31	7.9	NC1.5WH6	6	120	120
NE1.5X4WH6	1.64 x 4.06	41.7 x 103.1	.31	7.9	NC1.5WH6	6	60	120
NE2X1WH6	2.14 x 1.06	54.4 x 26.9	.31	7.9	NC2WH6	6	120	120
NE2X2WH6	2.14 x 2.06	54.4 x 52.3	.31	7.9	NC2WH6	6	120	120
NE2X3WH6	2.14 x 3.06	54.4 x 77.7	.31	7.9	NC2WH6	6	60	120
NE2X4WH6	2.14 x 4.06	54.4 x 103.1	.31	7.9	NC2WH6	6	60	120
NE3X1WH6	3.14 x 1.06	79.8 x 26.9	.31	7.9	NC3WH6	6	120	120
NE3X2WH6	3.14 x 2.06	79.8 x 52.3	.31	7.9	NC3WH6	6	120	120
NE3X3WH6	3.14 x 3.06	79.8 x 77.7	.31	7.9	NC3WH6	6	60	120
NE3X4WH6	3.14 x 4.06	79.8 x 103.1	.31	7.9	NC3WH6	6	60	120
NE3X5WH6	3.14 x 5.06	79.8 x 128.5	.38	9.7	NC3WH6	6	60	120
NE4X2WH6	4.14 x 2.06	105.2 x 52.3	.31	7.9	NC4WH6	6	60	120
NE4X3WH6	4.14 x 3.06	105.2 x 77.7	.31	7.9	NC4WH6	6	60	120
NE4X4WH6	4.14 x 4.06	105.2 x 103.1	.31	7.9	NC4WH6	6	60	120
NE4X5WH6	4.14 x 5.06	105.2 x 128.5	.38	9.7	NC4WH6	6	60	120

Available in WH (White) only.

Do not allow cutting, tapping, or cleaning fluids that contain hydrocarbons to come in contact with type NE wiring duct as it will cause stress cracking. See page C1.49 for list of chemicals to avoid.

Base and cover sold separately.

\*\*H" dimension includes duct and cover.



## WIRING DUCT TOOLS AND ACCESSORIES

Panduit offers a selection of Panduct® Tools and Accessories to aid cutting, modifying, and installing wiring duct.



Some of the features and benefits found in Panduct® Tools and Accessories include:

- Wide selection of hand tools for cutting and installing wiring duct
- Snap-in wire retainers to retain cabling when the cover is removed or during cable installation
- Divider walls that mount within the duct, enabling multiple channels to be created within a duct channel
- Corner strips hold corners rigid at t-junctions in control panel applications
- Mounting clips provide an alternative method to mount the duct and allow the duct to be more easily removed

A.  
System  
Overview

B1.  
Cable Ties

B2.  
Cable  
Accessories

B3.  
Stainless  
Steel Ties

C1.  
Wiring  
Duct

C2.  
Surface  
Raceway

C3.  
Abrasion  
Protection

C4.  
Cable  
Management

D1.  
Terminals

D2.  
Power  
Connectors

D3.  
Grounding  
Connectors

E1.  
Labeling  
Systems

E2.  
Labels

E3.  
Pre-Printed  
& Write-On  
Markers

E4.  
Permanent  
Identification

E5.  
Lockout/  
Tagout  
& Safety  
Solutions

F.  
Index

A. System Overview

## Panduct® Type FL Flexible Wiring Duct

B1. Cable Ties

- Material: Flexible Polypropylene
- UL 94 flammability rating of V-2
- UL Recognized continuous use temperature: 149°F (65°C)
- Factory applied adhesive tape provided for easy mounting

B2. Cable Accessories



B3. Stainless Steel Ties

Part Number	Duct Size (W x H)*		Length		Std. Pkg. Qty.
	In.	mm	In.	mm	
FL12X12LG-A	.49 x .49	12.5 x 12.5	19.7	500	112
FL25X25LG-A	.98 x .98	25.0 x 25.0	19.7	500	70
FL50X50LG-A	1.97 x 1.97	50.0 x 50.0	19.7	500	32

Available in LG (RAL 7040 Light Gray) color only. Unit of measure is pieces.  
\*\*"H" dimension includes duct and cover.

C1. Wiring Duct

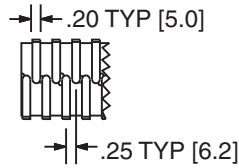
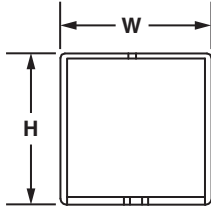

C2. Surface Raceway

C3. Abrasion Protection

## Panduct® Divider Wall

C4. Cable Management

- Wiring duct divider wall can be mounted inside any type of Panduit PVC wiring duct to create multiple channels
- Simply install the divider wall base when mounting the duct and snap the divider wall onto the mounting base
- All versions snap onto DB-C mounting base
- Meets UL508/508A insulation material requirement for barrier between conductors
- UL 94 flammability rating of V-0
- Material: Lead-free PVC
- Divider wall heights 2" and greater have a scoreline feature allowing sections to be removed leaving a smooth edge

D1. Terminals

D2. Power Connectors



DB-C

D3. Grounding Connectors

Part Number	Used with Anchors	Std. Pkg. Qty.	Std. Ctn. Qty.
Panduct® Divider Wall Mounting Base			
DB-C	Panduit NR1 or #8, #10, M4 or M5 screw	100	1000

E1. Labeling Systems



D\*H6 and D\*H2

E2. Labels

E3. Pre-Printed & Write-On Markers

E4. Permanent Identification



SD\*H6

E5. Lockout/Tagout & Safety Solutions

F. Index

Part Number	For Nominal Duct Height		Length		Color	Std. Pkg. Qty.	Std. Ctn. Qty.
	In.	mm	Ft.	m			
<b>Panduct® Solid Divider Wall</b>							
D2H6	2.00	50	6	—	Light Gray	6	120
D3H6	3.00	75	6	—	Light Gray	6	120
D4H6	4.00	100	6	—	Light Gray	6	120
D2HWH6	2.00	50	6	—	White	6	120
D3HWH6	3.00	75	6	—	White	6	120
D4HWH6	4.00	100	6	—	White	6	120
<b>Panduct® Slotted Divider Wall</b>							
SD2H6	2.00	50	6	—	Light Gray	6	120
SD3H6	3.00	75	6	—	Light Gray	6	120
SD4H6	4.00	100	6	—	Light Gray	6	120
SD2HWH6	2.00	50	6	—	White	6	120
SD3HWH6	3.00	75	6	—	White	6	120
SD4HWH6	4.00	100	6	—	White	6	120

Note: Must be used with mounting base, DB-C (see page C1.26) which is sold separately. Install mounting bases to the duct channel, locate within 2" of each divider wall end and at least every 12" along the length.

## Panduct® Type NNC Divider Wall

- NNC solid divider wall can be mounted inside NNC and NE wiring duct to create multiple channels
- Material: Halogen-free modified polyphenylene oxide (mPPO)

- Simply install the divider wall base when mounting the duct and snap the divider wall onto mounting base, DB-C



Part Number	For Nominal Duct Height		Std. Pkg. Qty.	Std. Ctn. Qty.
	In.	mm		
NNC50DWH2	2.00	50	2	40
NNC75DWH2	3.00	75	2	40

Available in WH (White) color only.

NOTE: Must be used with mounting base DB-C (see page C1.26), which is sold separately. Install mounting bases to the duct channel, locate within 2" of each divider wall end and at least every 12" along the length.

A.  
System  
Overview

B1.  
Cable Ties

B2.  
Cable  
Accessories

B3.  
Stainless  
Steel Ties

C1.  
Wiring  
Duct

C2.  
Surface  
Raceway

C3.  
Abrasion  
Protection

C4.  
Cable  
Management

D1.  
Terminals

D2.  
Power  
Connectors

D3.  
Grounding  
Connectors

E1.  
Labeling  
Systems

E2.  
Labels

E3.  
Pre-Printed  
& Write-On  
Markers

E4.  
Permanent  
Identification

E5.  
Lockout/  
Tagout  
& Safety  
Solutions

F.  
Index

A. System Overview

## Panduit® Type G and H Wiring Duct Wire Retainers

B1. Cable Ties

- Insert between fingers of type G and H to contain wiring when cover is removed
- Adjustable height
- Material: ABS

B2. Cable Accessories



B3. Stainless Steel Ties

Part Number	For Duct Width In. (mm)	For Duct Height In. (mm)	Std. Pkg. Qty.	Std. Ctn. Qty.
WR2-C	2.00 (50.8)	2.00 – 4.00 (50.8 – 101.6)	100	1000
WR2H-C	2.00 (50.8)	2.00 – 4.00 (50.8 – 101.6)	100	1000
WR3-C	3.00 (76.2)	2.00 – 4.00 (50.8 – 101.6)	100	1000
WR4-C	4.00 (101.6)	2.00 – 4.00 (50.8 – 101.6)	100	1000
WR5-C	Use with: 3x5, 4x5, or 6x4		100	1000

\*For 2" width type H hinged cover wiring duct use part number WR2H-C.

C1. Wiring Duct



C2. Surface Raceway

C3. Abrasion Protection

## Panduit® Solid Wall Raceway Type FS and Type D Wiring Duct Wire Retainer

C4. Cable Management

- Mounts onto walls of type FS raceway or type D duct with pressure sensitive adhesive
- One size fits three different duct widths
- Full length is used with 2 inch wide duct; for small widths, break off segments at scorelines
- Material: Lead-free PVC

D1. Terminals

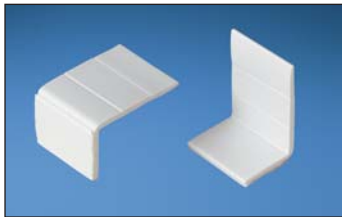

D2. Power Connectors

Part Number	For Duct Width In. (mm)	Std. Pkg. Qty.	Std. Ctn. Qty.
WRS-A-C10	1.00 (25.4)	100	1000
	1.50 (38.1)		
	2.00 (50.8)		

Full length is used with 2" wide duct. For smaller widths, break off segments at scorelines.

D3. Grounding Connectors

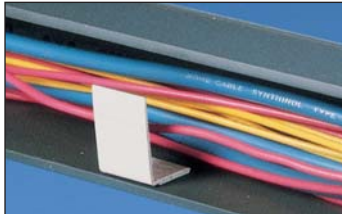

E1. Labeling Systems

E2. Labels

E3. Pre-Printed & Write-On Markers

E4. Permanent Identification

E5. Lockout/Tagout & Safety Solutions

F. Index

## Panduit® Type F, HN and MC Duct Wire Retainers/Labeling Device

- Used to contain wiring when cover is removed and can also be used as a labeling device
- FWR-C is compatible with type F and HN duct sizes
- FMWR-C is compatible with type MC duct sizes
- Material: Lead-free PVC



Part Number	Material	For Duct Width		Std. Pkg. Qty.	Std. Ctn. Qty.
		In.	mm		
FWR-C	Rigid PVC	1.50 – 4.00	37.0 – 76.2	100	1000
FMWR-C	Rigid PVC	1.46 – 3.94	37.0 – 100.0	100	1000

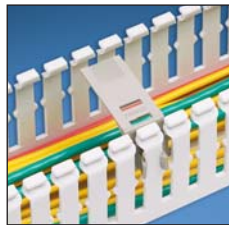

**Labeling Inside Duct –**  
Snaps onto duct fingers. Full length for use with 4" wide duct. For smaller widths, break off segments at scorelines.

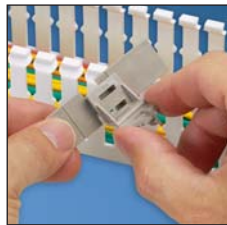

**Labeling Outside Duct –**  
Break off the last segment from wire retainer below 1.5" mark and snap onto the back of the remaining segment. Install label and mount between fingers facing outward.

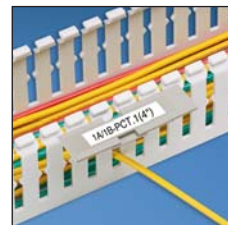

## Panduit® Duct Corner Strip with 1" Bend Radius Control

- Create a strong rigid corner at wiring duct junctions
- Provide bend radius protection for cabling as required in NFPA 79-2007 section 13.1.5.9 and TIA/EIA-568-B and 569-A
- Available in 6 foot lengths that can be cut to size to meet any size requirement
- Easy to install two-piece design
- Compatible with all styles of Panduit wiring duct
- UL 94 flammability rating of V-0
- Material: Lead-free PVC

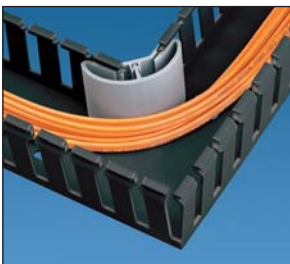

Part Number	Part Description	For Duct Height		Color	Std. Pkg. Qty.	Std. Ctn. Qty.
		In.	mm			
<b>6' Lengths for use with all Types of PVC Wiring Duct</b>						
CSC1LG6	Cut-to-size 6 foot corner strip with a 1" bend radius.	All sizes (Cut to height)*	All sizes (Cut to height)*	Light Gray	6	120

Order number of feet required, in multiples of 6' or Standard Package Quantity.  
\*Refer to Cutting Guide on page C1.30.

- A. System Overview
- B1. Cable Ties
- B2. Cable Accessories
- B3. Stainless Steel Ties
- C1. Wiring Duct
- C2. Surface Raceway
- C3. Abrasion Protection
- C4. Cable Management
- D1. Terminals
- D2. Power Connectors
- D3. Grounding Connectors
- E1. Labeling Systems
- E2. Labels
- E3. Pre-Printed & Write-On Markers
- E4. Permanent Identification
- E5. Lockout/Tagout & Safety Solutions
- F. Index

A. System Overview

## Panduit® Duct Corner Strip

B1. Cable Ties

- Slide onto duct at corner or t-junctions for smooth, round corners
- Available in 6 foot lengths that can be cut to size to meet any requirement
- Easy to install one-piece design
- Compatible with all styles of Panduit wiring duct
- UL 94 flammability rating of V-0
- Material: Lead-free PVC

B2. Cable Accessories



CS1LG6

B3. Stainless Steel Ties

Part Number	Part Description	For Nominal Duct Height		Color	Std. Pkg. Qty.	Std. Ctn. Qty.
		In.	mm			
<b>6' Lengths for use with all Types of PVC Wiring Duct</b>						
CS1LG6	6 foot length is cut by user to fit duct height.	All sizes (Cut to height)*	All sizes (Cut to height)*	Light Gray	6	120

\*Refer to Cutting Guide below.

C1. Wiring Duct

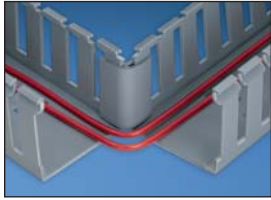

C2. Surface Raceway

C3. Abrasion Protection

C4. Cable Management

## Cutting Guide for Duct Corner Strips (CSC1\*\*6, CS1\*\*6)

D1. Terminals

D2. Power Connectors

D3. Grounding Connectors

E1. Labeling Systems

E2. Labels

E3. Pre-Printed & Write-On Markers

E4. Permanent Identification

E5. Lockout/Tagout & Safety Solutions

F. Index

Used with Duct Height	Cut-to-Size*	Used with Metric Duct Height	Cut-to-Size*
1 inch	.47" (11.9)	25mm	.43" (10.9)
1.5 inch	1.04" (26.4)	37mm	.91" (23.1)
2 inch	1.23" (31.2)	50mm	1.39" (35.3)
2.5 inch	1.97" (50.0)	62mm	1.85" (47.0)
3 inch	2.27" (57.7)	75mm	2.38" (60.5)
4 inch	3.25" (82.5)	100mm	3.35" (85.1)
5 inch	4.47" (113.5)		

\*Cut-to-size measure fits into the flat area of the duct sidewall.

### Panduct® Snap-Clip Mounting Brackets

- Duct easily snaps into bracket
- No mounting holes required in duct
- Ensures no metal is inside the duct
- Snap-clip spacing is not critical
- Simplifies fabrication drawings and panel layout
- Material: Spring steel



Part Number	Screw Required	For Duct Width		Std. Pkg. Qty.	Std. Ctn. Qty.
		In.	mm		
<b>Snap-Clip Mounting Brackets for use with Types G, F, FS and D Wiring Duct</b>					
S1F-C	#8-32 x 1/4 (Provided)	1.00	25.4	100	1000
S1.5F-C	#8-32 x 1/4 (Provided)	1.50	38.1	100	1000
S2F-C	#8-32 x 1/4 (Provided)	2.00	50.8	100	1000
S3F-C	#8-32 x 1/4 (Provided)	3.00	76.2	100	1000
S4F-C	#8-32 x 1/4 (Provided)	4.00	101.6	100	1000
<b>Snap-Clip Mounting Brackets for use with Types MC and NNC Wiring Duct</b>					
SNS25F-C	#8-32 x 1/4 (User Supplied)	1.00	25	100	1000
SNS37F-C	#8-32 x 1/4 (User Supplied)	1.50	37	100	1000
SNS50F-C	#8-32 x 1/4 (User Supplied)	2.00	50	100	1000
SNS62F-C	#8-32 x 1/4 (User Supplied)	2.50	62	100	1000
SNS75F-C	#8-32 x 1/4 (User Supplied)	3.00	75	100	1000

### Panduct® Snap-Clip Mounting Bracket – Type NE Wiring Duct

- Duct easily snaps into bracket
- Ensures no metal is inside the duct
- Snap-clip spacing is not critical
- Simplifies fabrication drawings and panel layout
- Material: Spring steel



Part Number	Screw Required	For Duct Width		Std. Pkg. Qty.	Std. Ctn. Qty.
		In.	mm		
SNS.5-C	#6-32 x 1/4 (User Supplied)	.50	12.7	100	1000
SNS.75-C	#6-32 x 1/4 (User Supplied)	.75	19.1	100	1000
SNS1-C	#8-32 x 1/4 (User Supplied)	1.00	25.4	100	1000
SNS1.5-C	#8-32 x 1/4 (User Supplied)	1.50	38.1	100	1000
SNS2-C	#8-32 x 1/4 (User Supplied)	2.00	50.8	100	1000
SNS3-C	#8-32 x 1/4 (User Supplied)	3.00	76.2	100	1000

A.  
System  
Overview

B1.  
Cable Ties

B2.  
Cable  
Accessories

B3.  
Stainless  
Steel Ties

C1.  
Wiring  
Duct

C2.  
Surface  
Raceway

C3.  
Abrasion  
Protection

C4.  
Cable  
Management

D1.  
Terminals

D2.  
Power  
Connectors

D3.  
Grounding  
Connectors

E1.  
Labeling  
Systems

E2.  
Labels

E3.  
Pre-Printed  
& Write-On  
Markers

E4.  
Permanent  
Identification

E5.  
Lockout/  
Tagout/  
& Safety  
Solutions

F.  
Index

A.  
System  
Overview

### Adhesive Tape for Wiring Duct

B1.  
Cable Ties

- Recommended installation temperature is 70°F (21°C)
- Optimum recommended dwell time for acrylic adhesive is 8 hours
- UL Recognized service temperature is 32°F (0°C) to 140°F (60°C)
- Recommended tape load is 1/2 lb. per square inch of tape area

B2.  
Cable  
Accessories



B3.  
Stainless  
Steel Ties

Duct Size (W x H)	Tape Part Number	Roll Length		Std. Pkg. Qty.	Std. Ctn. Qty.
		Yds.	m		
.5 x .5 thru 1.5 x 4	P32W2A2-50-7	7.0	6.4	1	100
	P32W2A2-50-72	72.0	65.5	1	9
2 x 1 thru 3 x 3	P32W2A2-50-7	7.0	6.4	1	100
	P32W2A2-50-72	72.0	65.5	1	9
3 x 4 thru 3 x 5	P32W2A2-75-7	7.0	6.4	1	60
	P32W2A2-75-72	72.0	65.5	1	7
4 x 1.5 thru 4 x 3	P32W2A2-50-7	7.0	6.4	1	100
	P32W2A2-75-72	72.0	65.5	1	9
4 x 4 thru 6 x 4	P32W2A2-75-7	7.0	6.4	1	60
	P32W2A2-75-72	72.0	65.5	1	7

C1.  
Wiring  
Duct

C2.  
Surface  
Raceway

C3.  
Abrasion  
Protection

### Specifications for Factory Applied Tape

C4.  
Cable  
Management

Duct Size (W x H)	Rows of Tape	Tape			
		Width		Thickness	
		In.	mm	In.	mm
.5 x .5 through .75 x 2	1	.50	12.7	.03	.8
1 x 1 through 1.5 x 4	1	.75	19.1	.03	.8
2 x 1 through 3 x 3	2	.50	12.7	.03	.8
3 x 4 through 3 x 5	2	.75	19.1	.03	.8
4 x 1.5 through 4 x 3	2	.50	12.7	.03	.8
4 x 4 through 6 x 4	2	.75	19.1	.03	.8

D1.  
Terminals

D2.  
Power  
Connectors

D3.  
Grounding  
Connectors

E1.  
Labeling  
Systems

E2.  
Labels

E3.  
Pre-Printed  
& Write-On  
Markers

E4.  
Permanent  
Identification

E5.  
Lockout/  
Tagout  
& Safety  
Solutions

F.  
Index



### Adhesive Tape Guide

Selection of wiring duct part numbers available with factory applied adhesive tape.



G Duct Light Gray	G Duct White	G Duct Black	F Duct Light Gray	F Duct White	FS Duct Light Gray	FS Duct White	FS Duct Black	NE Duct White
G.5X.5LG6-A	G.5X.5WH6-A	—	F.5X.5LG6-A	—	—	—	—	—
G.5X1LG6-A	G.5X1WH6-A	—	F.5X1LG6-A	—	—	—	—	—
G.75X.75LG6-A	—	—	F.75X.75LG6-A	—	—	—	—	—
G.75X1LG6-A	G.75X1WH6-A	—	—	—	—	—	—	—
G.75X1.5LG6-A	G.75X1.5WH6-A	—	F.75X1.5LG6-A	—	—	—	—	—
G.75X2LG6-A	G.75X2WH6-A	—	—	—	—	—	—	—
G1X1LG6-A	G1X1WH6-A	—	F1X1LG6-A	—	—	FS1X1WH6-A FS1X1WH6NM-A	—	—
G1X1.5LG6-A	G1X1.5WH6-A	—	F1X1.5LG6-A	—	FS1X1.5LG6-A	—	—	—
G1X2LG6-A	G1X2WH6-A	—	F1X2LG6-A	F1X2WH6-A	—	—	—	—
G1X3LG6-A	G1X3WH6-A	G1X3BL6-A	F1X3LG6-A	F1X3WH6-A	—	—	—	—
G1X4LG6-A	G1X4WH6-A	—	F1X4LG6-A	F1X4WH6-A	—	—	—	—
G1.5X1LG6-A	G1.5X1WH6-A	—	F1.5X1LG6-A	—	—	—	—	—
G1.5X1.5LG6-A	G1.5X1.5WH6-A	—	F1.5X1.5LG6-A	—	FS1.5X1.5LG6-A	FS1.5X1.5WH6-A	FS1.5X1.5BL6-A	—
G1.5X2LG6-A	G1.5X2WH6-A	—	F1.5X2LG6-A	—	—	—	—	NE1.5X2WH6-A
G1.5X3LG6-A	G1.5X3WH6-A	—	F1.5X3LG6-A	F1.5X3WH6-A	—	—	—	—
G1.5X4LG6-A	G1.5X4WH6-A	—	F1.5X4LG6-A	F1.5X4WH6-A	—	—	—	—
G2X1LG6-A	G2X1WH6-A	—	F2X1LG6-A	—	—	—	—	—
G2X1.5LG6-A	G2X1.5WH6-A	—	F2X1.5LG6-A	—	—	—	—	—
G2X2LG6-A	G2X2WH6-A	G2X2BL6-A	F2X2LG6-A	F2X2WH6-A	—	—	—	NE2X2WH6-A
G2X3LG6-A	G2X3WH6-A	—	F2X3LG6-A	F2X3WH6-A	—	—	—	—
G2X4LG6-A	G2X4WH6-A	G2X4BL6-A	F2X4LG6-A	F2X4WH6-A	—	—	—	—
G2X5LG6-A	G2X5WH6-A	—	F2X5LG6-A	—	—	—	—	—
G2.5X3LG6-A	G2.5X3WH6-A	—	—	—	—	—	—	—
G3X1LG6-A	G3X1WH6-A	—	F3X1LG6-A	—	—	—	—	—
G3X2LG6-A	G3X2WH6-A	—	F3X2LG6-A	—	—	—	—	—
G3X3LG6-A	G3X3WH6-A	G3X3BL6-A	F3X3LG6-A	F3X3WH6-A	—	—	—	—
G3X4LG6-A	G3X4WH6-A	—	F3X4LG6-A	F3X4WH6-A	—	—	—	—
G3X5LG6-A	G3X5WH6-A	—	F3X5LG6-A	—	—	—	—	—
G4X1.5LG6-A	G4X1.5WH6-A	—	—	—	—	—	—	—
G4X2LG6-A	G4X2WH6-A	—	F4X2LG6-A	—	—	—	—	NE4X2WH6-A
G4X3LG6-A	G4X3WH6-A	—	F4X3LG6-A	F4X3WH6-A	—	—	—	NE4X3WH6-A
G4X4LG6-A	G4X4WH6-A	G4X4BL6-A	F4X4LG6-A	F4X4WH6-A	—	—	—	NE4X4WH6-A
G4X5LG6-A	G4X5WH6-A	—	F4X5LG6-A	—	—	—	—	—
—	—	—	—	—	FS6X4LG6-A	—	—	—

All three sizes of flexible duct come provided with adhesive: FL12X12LG-A, FL25X25LG-A, FL50X50LG-A.

A.  
System  
Overview

B1.  
Cable Ties

B2.  
Cable  
Accessories

B3.  
Stainless  
Steel Ties

C1.  
Wiring  
Duct

C2.  
Surface  
Raceway

C3.  
Abrasion  
Protection

C4.  
Cable  
Management

D1.  
Terminals

D2.  
Power  
Connectors

D3.  
Grounding  
Connectors

E1.  
Labeling  
Systems

E2.  
Labels

E3.  
Pre-Printed  
& Write-On  
Markers

E4.  
Permanent  
Identification

E5.  
Lockout/  
Tagout  
& Safety  
Solutions

F.  
Index

A. System Overview

### Panduit® Installation Tools

B1. Cable Ties

- Panduit® Panduct® Bench Mount Wiring Duct Cutting Tool and Duct Cutting Tool easily cut Panduct® Wiring Duct and Cover
- DNT-100 notches duct sidewalls to bottom scoreline for tees and corner junctions

- TNR installs or removes Panduit nylon rivets, NR1-C and NR1-M, quickly and easily
- DFCT easily removes duct fingers in tight spaces

B2. Cable Accessories

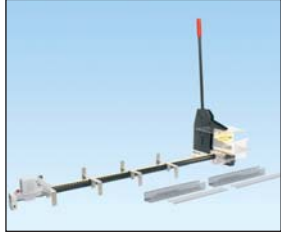

PBDCT

B3. Stainless Steel Ties

C1. Wiring Duct

C2. Surface Raceway



DCT



DFCT

C3. Abrasion Protection

C4. Cable Management



DNT-100



TNR

D1. Terminals

D2. Power Connectors



NR1

D3. Grounding Connectors

E1. Labeling Systems

E2. Labels

E3. Pre-Printed & Write-On Markers

E4. Permanent Identification

E5. Lockout/Tagout & Safety Solutions

F. Index

Part Number	Part Description	Std. Pkg. Qty
-------------	------------------	---------------

#### Duct Cutting Tools

PBDCT	Panduit bench-mount duct cutting tool. Cuts slotted wiring ducts and wiring duct covers with up to 6" width and up to 5" height. Full 78.74" (2 meter) measuring scale. Includes safety guarding.	1
DCT	Hand-held duct cutting tool.	1

#### Replacement Blade Kit (includes blade and nylon insert)

DCT-BLD	Replacement blade kit with blade and nylon insert.	1
---------	--	---

#### Replacement Nylon Insert

DCT-RI	Replacement nylon insert.	5
--------	---------------------------	---

#### Duct Finger Cutting Tool (For use with all wide slotted duct types)

DFCT	Hand-held duct finger cutting tool.	1
------	-------------------------------------	---

#### Duct Notching Tool (For use with all wide slotted duct types)

DNT-100	Hand-held sidewall notching tool.	1
---------	-----------------------------------	---

#### Nylon Rivet Installation Tool

TNR	Hand-held nylon rivet installation tool.	1
-----	--	---

#### Nylon Rivets

NR1-C	Nylon rivet for use with TNR rivet tool. Mean pull-off force PVC: 90 lbs. Type NE/Type NNC: 70 lbs. Mean shear force: PVC 139 lbs. Type NE/Type NNC: 126 lbs.	100
NR1-M	Nylon rivet for use with TNR rivet tool. Mean pull-off force PVC: 90 lbs. Type NE/Type NNC: 70 lbs. Mean shear force: PVC 139 lbs. Type NE/Type NNC: 126 lbs.	1000

Always use approved safety goggles when using any tools.

Total Thickness of Panel and Duct		Panel Hole Dia. Needed		ANSI Standard Drill Bit
In.	mm	In.	mm	
.158 – .187	4.0 – 4.7	.187	4.7	#15
.188 – .218	4.8 – 5.5	.193	4.9	#11
.219 – .250	5.6 – 6.4	.203	5.2	#7
.251 – .281	6.5 – 7.1	.213	5.4	#4

### Panduit® PanelMax™ DIN Rail Wiring Duct Dimensions

Dimensions are shown for reference only. Contact Panduit Customer Service at 800-777-3300 for specific dimensional needs.



### Panduit® PanelMax™ Noise Shield Dimensions

Dimensions are shown for reference only. Contact Panduit Customer Service at 800-777-3300 for specific dimensional needs.

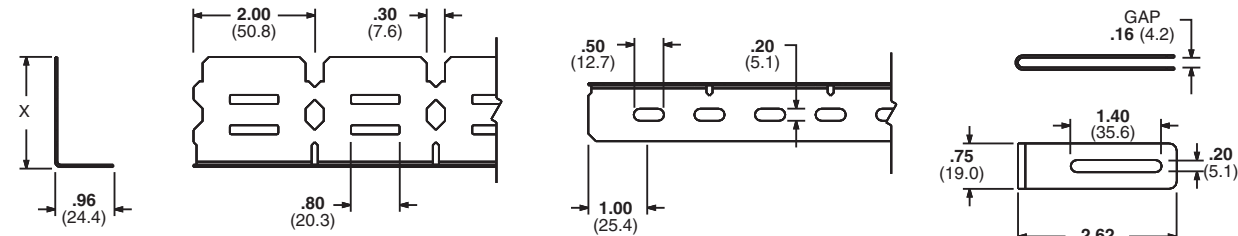

Part No.	X
SD2EMI	1.82 (46.1)
SD3EMI	2.88 (73.2)
SD4EMI	3.86 (98.2)

Sidewall: SD2EMI shown.  
SD3EMI, SD4EMI sidewall feature two pairs of cable tie slots per section.

Bottom view.

Bonding clip (for use with wiring duct).

All dimension shown in inches (mm).

### Panduit® PanelMax™ Corner Wiring Duct Dimensions

Dimensions are shown for reference only. Contact Panduit Customer Service at 800-777-3300 for specific dimensional needs.

Size	Dimensions – Inches (mm)								
	A	C	D	G	H	K	T	W	Z
CWD3	4.98 (126.6)	2.25 (57.2)	2.83 (71.8)	3.10 (79.1)	3.57 (90.7)	3.95 (100.4)	.10 (2.4)	4.40 (111.8)	5.16 (131.0)
CWD4	5.94 (150.9)	2.25 (57.2)	3.84 (97.5)	4.10 (104.1)	4.58 (115.7)	4.89 (124.3)	.11 (2.7)	5.33 (135.3)	6.54 (166.0)

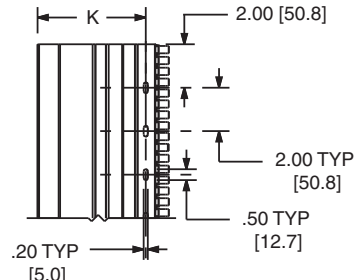
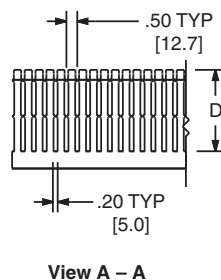
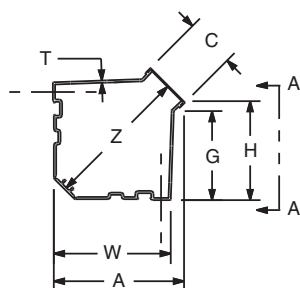

### Panduct® Type G and D Wiring Duct Dimensions

Dimensions are shown for reference only. Contact Panduit Customer Service at 800-777-3300 for specific dimensional needs.

A. System Overview

B1. Cable Ties

B2. Cable Accessories

B3. Stainless Steel Ties

C1. Wiring Duct

C2. Surface Raceway

C3. Abrasion Protection

C4. Cable Management

D1. Terminals

D2. Power Connectors

D3. Grounding Connectors

E1. Labeling Systems

E2. Labels

E3. Pre-Printed & Write-On Markers

E4. Permanent Identification

E5. Lockout/Tagout & Safety Solutions

F. Index

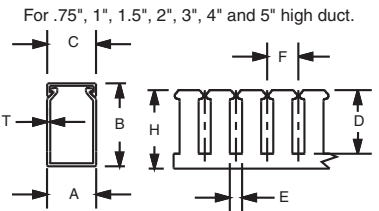
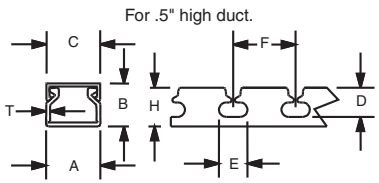

Note: 'A' dimension is measured at base.  
Note: 'K' dimension shown in mounting hole dimensions below.

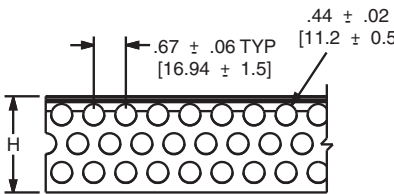

For 2" duct height = 3 rows of holes  
3" duct height = 4 rows of holes  
4" duct height = 6 rows of holes

**Mounting Hole Dimensions**  
For .5", .75", 1", and 1.5" wide duct.

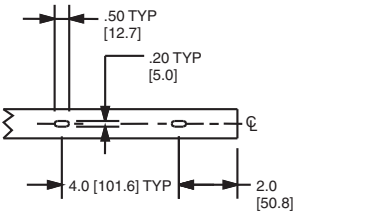

For 2.0", 2.5", 3", 4" and 6" wide duct.

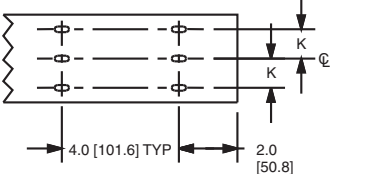

Duct Size (W x H)	Dimensions – Inches (mm)									
	A	B	C	D	E	F	H	K	T	
.5 x .5 (12.7) x (12.7)	.69 (17.5)	.60 (15.2)	.69 (17.5)	.38 (9.5)	.37 (9.3)	.80 (20.3)	.50 (12.7)		.05 (1.3)	
.5 x 1 (12.7) x (25.4)	.69 (17.5)	1.06 (26.9)	.69 (17.5)	.75 (19.1)	.31 (7.9)	.80 (20.3)	1.00 (25.4)		.05 (1.3)	
.5 x 2 (12.7) x (50.8)	.69 (17.5)	2.03 (51.6)	.69 (17.5)	1.63 (41.3)	.31 (7.9)	.80 (20.3)	2.00 (50.8)		.08 (2.0)	
.75 x .75 (19.1) x (19.1)	.93 (23.6)	.82 (20.8)	.94 (23.9)	.56 (14.3)	.31 (7.9)	.80 (20.3)	0.75 (19.1)		.06 (1.4)	
.75 x 1 (19.1) x (25.4)	.93 (23.6)	1.06 (26.9)	.94 (23.9)	.75 (19.1)	.31 (7.9)	.80 (20.3)	1.00 (25.4)		.06 (1.4)	
.75 x 1.5 (19.1) x (38.1)	.93 (23.6)	1.57 (39.9)	.94 (23.9)	1.20 (30.5)	.31 (7.9)	.80 (20.3)	1.50 (38.1)		.07 (1.8)	
.75 x 2 (19.1) x (50.8)	.93 (23.6)	2.03 (51.6)	.94 (23.9)	1.63 (41.3)	.31 (7.9)	.80 (20.3)	2.00 (50.8)		.08 (2.0)	
1 x 1 (25.4) x (25.4)	1.26 (32.0)	1.12 (28.4)	1.25 (31.8)	.75 (19.1)	.31 (7.9)	.80 (20.3)	1.00 (25.4)		.06 (1.4)	
1 x 1.5 (25.4) x (38.1)	1.26 (32.0)	1.62 (41.1)	1.25 (31.8)	1.20 (30.5)	.31 (7.9)	.80 (20.3)	1.50 (38.1)		.07 (1.8)	
1 x 2 (25.4) x (50.8)	1.26 (32.0)	2.12 (53.8)	1.25 (31.8)	1.63 (41.3)	.31 (7.9)	.80 (20.3)	2.00 (50.8)		.08 (2.0)	
1 x 3 (25.4) x (76.2)	1.26 (32.0)	3.12 (79.2)	1.25 (31.8)	2.63 (66.7)	.31 (7.9)	1.00 (25.4)	3.00 (76.2)		.10 (2.4)	
1 x 4 (25.4) x (101.6)	1.26 (32.0)	4.10 (104.1)	1.25 (31.8)	3.63 (92.1)	.31 (7.9)	1.00 (25.4)	4.00 (101.6)		.11 (2.7)	
1.5 x 1 (38.1) x (25.4)	1.75 (44.5)	1.12 (28.4)	1.75 (44.5)	.75 (19.1)	.31 (7.9)	.80 (20.3)	1.00 (25.4)		.06 (1.5)	
1.5 x 1.5 (38.1) x (38.1)	1.75 (44.5)	1.62 (41.1)	1.75 (44.5)	1.20 (30.5)	.31 (7.9)	.80 (20.3)	1.50 (38.1)		.07 (1.8)	
1.5 x 2 (38.1) x (50.8)	1.75 (44.5)	2.12 (53.8)	1.75 (44.5)	1.63 (41.3)	.31 (7.9)	.80 (20.3)	2.00 (50.8)		.08 (2.0)	
1.5 x 3 (38.1) x (76.2)	1.75 (44.5)	3.12 (79.2)	1.75 (44.5)	2.63 (66.7)	.31 (7.9)	1.00 (25.4)	3.00 (76.2)		.10 (2.4)	
1.5 x 4 (38.1) x (101.6)	1.75 (44.5)	4.10 (104.1)	1.75 (44.5)	3.63 (92.1)	.31 (7.9)	1.00 (25.4)	4.00 (101.6)		.11 (2.7)	
2 x 1 (50.8) x (25.4)	2.25 (57.2)	1.12 (28.4)	2.25 (57.2)	.75 (19.1)	.31 (7.9)	.80 (20.3)	1.00 (25.4)	.50 (12.7)	.06 (1.5)	
2 x 1.5 (50.8) x (38.1)	2.25 (57.2)	1.62 (41.1)	2.25 (57.2)	1.20 (30.5)	.31 (7.9)	.80 (20.3)	1.50 (38.1)	.50 (12.7)	.07 (1.8)	
2 x 2 (50.8) x (50.8)	2.25 (57.2)	2.12 (53.8)	2.25 (57.2)	1.63 (41.3)	.31 (7.9)	.80 (20.3)	2.00 (50.8)	.50 (12.7)	.08 (2.0)	
2 x 3 (50.8) x (76.2)	2.25 (57.2)	3.12 (79.2)	2.25 (57.2)	2.63 (66.7)	.31 (7.9)	1.00 (25.4)	3.00 (76.2)	.50 (12.7)	.10 (2.4)	
2 x 4 (50.8) x (101.6)	2.25 (57.2)	4.10 (104.1)	2.25 (57.2)	3.63 (92.1)	.31 (7.9)	1.00 (25.4)	4.00 (101.6)	.50 (12.7)	.11 (2.7)	
2 x 5 (50.8) x (127.0)	2.25 (57.2)	5.10 (129.5)	2.25 (57.2)	4.63 (117.5)	.38 (9.5)	1.33 (33.9)	5.00 (127.0)	.50 (12.7)	.12 (2.9)	
2.5 x 3 (63.5) x (76.2)	2.75 (69.9)	3.12 (79.2)	2.75 (69.9)	2.63 (66.7)	.31 (7.9)	1.00 (25.4)	3.00 (76.2)	.73 (18.4)	.10 (2.5)	
3 x 1 (76.2) x (25.4)	3.25 (82.6)	1.12 (28.4)	3.25 (82.6)	.75 (19.1)	.31 (7.9)	.80 (20.3)	1.00 (25.4)	1.00 (25.4)	.07 (1.8)	
3 x 2 (76.2) x (50.8)	3.25 (82.6)	2.12 (53.8)	3.25 (82.6)	1.63 (41.3)	.31 (7.9)	.80 (20.3)	2.00 (50.8)	1.00 (25.4)	.08 (2.0)	
3 x 3 (76.2) x (76.2)	3.25 (82.6)	3.12 (79.2)	3.25 (82.6)	2.63 (66.7)	.31 (7.9)	1.00 (25.4)	3.00 (76.2)	1.00 (25.4)	.10 (2.4)	
3 x 4 (76.2) x (101.6)	3.25 (82.6)	4.10 (104.1)	3.25 (82.6)	3.63 (92.1)	.31 (7.9)	1.00 (25.4)	4.00 (101.6)	1.00 (25.4)	.11 (2.7)	
3 x 5 (76.2) x (127.0)	3.25 (82.6)	5.10 (129.5)	3.25 (82.6)	4.63 (117.5)	.38 (9.5)	1.33 (33.9)	5.00 (127.0)	1.00 (25.4)	.12 (2.9)	
4 x 1.5 (101.6) x (38.1)	4.25 (108.0)	1.62 (41.1)	4.25 (108.0)	1.20 (30.5)	.31 (7.9)	.80 (20.3)	1.50 (38.1)	1.50 (38.1)	.07 (1.8)	
4 x 2 (101.6) x (50.8)	4.25 (108.0)	2.12 (53.8)	4.25 (108.0)	1.63 (41.3)	.31 (7.9)	0.80 (20.3)	2.00 (50.8)	1.50 (38.1)	.08 (2.0)	
4 x 3 (101.6) x (76.2)	4.25 (108.0)	3.12 (79.2)	4.25 (108.0)	2.63 (66.7)	.31 (7.9)	1.00 (25.4)	3.00 (76.2)	1.50 (38.1)	.10 (2.5)	
4 x 4 (101.6) x (101.6)	4.25 (108.0)	4.10 (104.1)	4.25 (108.0)	3.63 (92.1)	.31 (7.9)	1.00 (25.4)	4.00 (101.6)	1.50 (38.1)	.11 (2.7)	
4 x 5 (101.6) x (127.0)	4.25 (108.0)	5.10 (129.5)	4.25 (108.0)	4.63 (117.5)	.38 (9.5)	1.33 (33.9)	5.00 (127.0)	1.50 (38.1)	.12 (2.9)	
6 x 4 (152.4) x (101.6)	6.25 (158.8)	4.15 (105.4)	6.25 (158.8)	3.63 (92.1)	.31 (7.9)	1.00 (25.4)	4.00 (101.6)	2.50 (63.5)	.11 (2.8)	

ON CENTERLINE

> Available for type G wiring duct only.  
See page C1.13 and C1.17 for wiring duct color and size availability.

### Panduit® Type F Wiring Duct and FS Raceway Dimensions

Dimensions are shown for reference only. Contact Panduit Customer Service at 800-777-3300 for specific dimensional needs.

A.  
System  
Overview

B1.  
Cable  
Ties

B2.  
Cable  
Accessories

B3.  
Stainless  
Steel Ties

C1.  
Wiring  
Duct

C2.  
Surface  
Raceway

C3.  
Abrasion  
Protection

C4.  
Cable  
Management

D1.  
Terminals

D2.  
Power  
Connectors

D3.  
Grounding  
Connectors

E1.  
Labeling  
Systems

E2.  
Labels

E3.  
Pre-Printed  
& Write-On  
Markers

E4.  
Permanent  
Identification

E5.  
Lockout/  
Tagout  
& Safety  
Solutions

F.  
Index

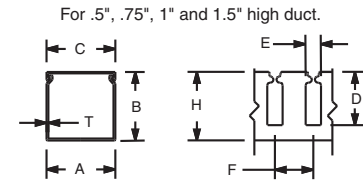

For .5", .75", 1" and 1.5" high duct.

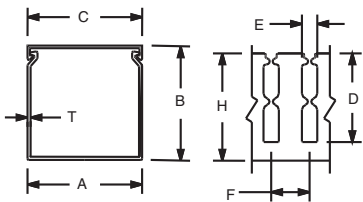

For 2", 3", 4" and 5" high duct.  
Note: 'A' dimension is measured at base.  
Note: 'K' dimension shown in mounting hole dimensions below.

#### Mounting Hole Dimensions

For .5", .75", 1" and 1.5" wide duct.

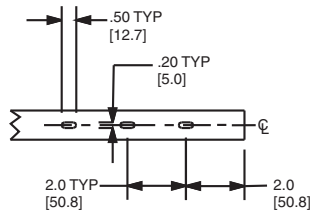

For 2.0", 2.5", 3", 4" and 6" wide duct.

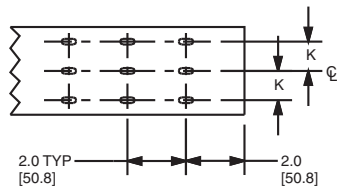

Note: For type FS raceway, no mounting holes is the standard condition; if mounting holes are required, delete NM from the part number.

Duct Size (W x H)	Dimensions – Inches (mm)								
	A	B	C	D	E	F	H	K	T
.5 x .5 (12.7) x (12.7)	.69 (17.5)	.60 (15.2)	.69 (17.5)	.38 (9.5)	.20 (5.0)	.50 (12.7)	.50 (12.7)	ON CENTERLINE	.05 (1.3)
.5 x 1 (12.7) x (25.4)	.69 (17.5)	1.06 (26.9)	.69 (17.5)	.75 (19.1)	.20 (5.0)	.50 (12.7)	1.00 (25.4)		.05 (1.3)
.75 x .75 (19.1) x (19.1)	.93 (23.6)	.82 (20.8)	.94 (23.9)	.56 (14.3)	.20 (5.0)	.50 (12.7)	.75 (19.1)		.06 (1.4)
.75 x 1.5 (19.1) x (38.1)	.93 (23.6)	1.57 (39.9)	.94 (23.9)	1.20 (30.5)	.20 (5.0)	.50 (12.7)	1.50 (38.1)		.07 (1.8)
1 x 1 (25.4) x (25.4)	1.26 (32.0)	1.12 (28.4)	1.25 (31.8)	.75 (19.1)	.20 (5.0)	.50 (12.7)	1.00 (25.4)		.06 (1.4)
1 x 1.5 (25.4) x (38.1)	1.26 (32.0)	1.62 (41.1)	1.25 (31.8)	1.20 (30.5)	.20 (5.0)	.50 (12.7)	1.50 (38.1)		.07 (1.8)
1 x 2 (25.4) x (50.8)	1.26 (32.0)	2.12 (53.8)	1.25 (31.8)	1.63 (41.3)	.20 (5.0)	.50 (12.7)	2.00 (50.8)		.08 (2.0)
1 x 3 (25.4) x (76.2)	1.26 (32.0)	3.12 (79.2)	1.25 (31.8)	2.63 (66.7)	.20 (5.0)	.50 (12.7)	3.00 (76.2)		.10 (2.4)
1 x 4 (25.4) x (101.6)	1.26 (32.0)	4.10 (104.1)	1.25 (31.8)	3.63 (92.1)	.20 (5.0)	.50 (12.7)	4.00 (101.6)		.11 (2.7)
1.5 x 1 (38.1) x (25.4)	1.75 (44.5)	1.12 (28.4)	1.75 (44.5)	.75 (19.1)	.20 (5.0)	.50 (12.7)	1.00 (25.4)		.06 (1.5)
1.5 x 1.5 (38.1) x (38.1)	1.75 (44.5)	1.62 (41.1)	1.75 (44.5)	1.20 (30.5)	.20 (5.0)	.50 (12.7)	1.50 (38.1)		.07 (1.8)
1.5 x 2 (38.1) x (50.8)	1.75 (44.5)	2.12 (53.8)	1.75 (44.5)	1.63 (41.3)	.20 (5.0)	.50 (12.7)	2.00 (50.8)		.08 (2.0)
1.5 x 3 (38.1) x (76.2)	1.75 (44.5)	3.12 (79.2)	1.75 (44.5)	2.63 (66.7)	.20 (5.0)	.50 (12.7)	3.00 (76.2)		.10 (2.4)
1.5 x 4 (38.1) x (101.6)	1.75 (44.5)	4.10 (104.1)	1.75 (44.5)	3.63 (92.1)	.20 (5.0)	.50 (12.7)	4.00 (101.6)		.11 (2.7)
2 x 1 (50.8) x (25.4)	2.25 (57.2)	1.12 (28.4)	2.25 (57.2)	.75 (19.1)	.20 (5.0)	.50 (12.7)	1.00 (25.4)		.06 (1.5)
2 x 1.5 (50.8) x (38.1)	2.25 (57.2)	1.62 (41.1)	2.25 (57.2)	1.20 (30.5)	.20 (5.0)	.50 (12.7)	1.50 (38.1)		.07 (1.8)
2 x 2 (50.8) x (50.8)	2.25 (57.2)	2.12 (53.8)	2.25 (57.2)	1.63 (41.3)	.20 (5.0)	.50 (12.7)	2.00 (50.8)		.08 (2.0)
2 x 3 (50.8) x (76.2)	2.25 (57.2)	3.12 (79.2)	2.25 (57.2)	2.63 (66.7)	.20 (5.0)	.50 (12.7)	3.00 (76.2)		.10 (2.4)
2 x 4 (50.8) x (101.6)	2.25 (57.2)	4.10 (104.1)	2.25 (57.2)	3.63 (92.1)	.20 (5.0)	.50 (12.7)	4.00 (101.6)		.11 (2.7)
2 x 5 (50.8) x (127.0)	2.25 (57.2)	5.10 (129.5)	2.25 (57.2)	4.63 (117.5)	.20 (5.0)	.50 (12.7)	5.00 (127.0)		.12 (2.9)
3 x 1 (76.2) x (25.4)	3.25 (82.6)	1.12 (28.4)	3.25 (82.6)	.75 (19.1)	.20 (5.0)	.50 (12.7)	1.00 (25.4)		.07 (1.7)
3 x 2 (76.2) x (50.8)	3.25 (82.6)	2.12 (53.8)	3.25 (82.6)	1.63 (41.3)	.20 (5.0)	.50 (12.7)	2.00 (50.8)		.08 (2.0)
3 x 3 (76.2) x (76.2)	3.25 (82.6)	3.12 (79.2)	3.25 (82.6)	2.63 (66.7)	.20 (5.0)	.50 (12.7)	3.00 (76.2)		.10 (2.4)
3 x 4 (76.2) x (101.6)	3.25 (82.6)	4.10 (104.1)	3.25 (82.6)	3.63 (92.1)	.20 (5.0)	.50 (12.7)	4.00 (101.6)		.11 (2.7)
3 x 5 (76.2) x (127.0)	3.25 (82.6)	5.10 (129.5)	3.25 (82.6)	4.63 (117.5)	.20 (5.0)	.50 (12.7)	5.00 (127.0)		.12 (2.9)
4 x 1.5 (101.6) x (38.1)	4.25 (108.0)	1.62 (41.1)	4.25 (108.0)	N/A	N/A	N/A	1.50 (38.1)		.07 (1.8)
4 x 2 (101.6) x (50.8)	4.25 (108.0)	2.12 (53.8)	4.25 (108.0)	1.63 (41.3)	.20 (5.0)	.50 (12.7)	2.00 (50.8)		.08 (2.0)
4 x 3 (101.6) x (76.2)	4.25 (108.0)	3.12 (79.2)	4.25 (108.0)	2.63 (66.7)	.20 (5.0)	.50 (12.7)	3.00 (76.2)		.10 (2.4)
4 x 4 (101.6) x (101.6)	4.25 (108.0)	4.10 (104.1)	4.25 (108.0)	3.63 (92.1)	.20 (5.0)	.50 (12.7)	4.00 (101.6)		.11 (2.7)
4 x 5 (101.6) x (127.0)	4.25 (108.0)	5.10 (129.5)	4.25 (108.0)	4.63 (117.5)	.20 (5.0)	.50 (12.7)	5.00 (127.0)		.12 (2.9)
6 x 4 (152.4) x (101.6)	6.25 (158.8)	4.15 (105.4)	6.25 (158.8)	3.63 (92.1)	.20 (5.0)	.50 (12.7)	4.00 (101.6)		.11 (2.8)

> Available for type FS raceway only.  
See page C1.48 for wiring duct color and size availability.

A.  
System  
Overview

### Panduit® Type MC Wiring Duct Dimensions

Dimensions are shown for reference only. Contact Panduit Customer Service at 800-777-3300 for specific dimensional needs.

B1.  
Cable Ties

B2.  
Cable  
Accessories

B3.  
Stainless  
Steel Ties

C1.  
Wiring  
Duct

C2.  
Surface  
Raceway

C3.  
Abrasion  
Protection

C4.  
Cable  
Management

For 25mm, 37.5mm, and 50mm high duct.

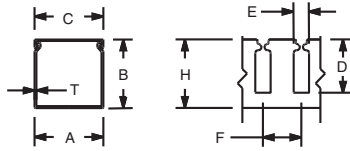

For 62.5mm, 75mm, and 100mm high duct.

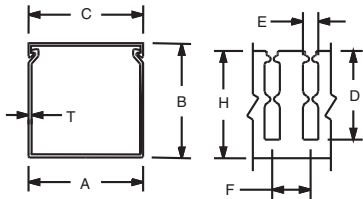

Note: 'A' dimension is measured at base.  
Note: 'K' dimension shown in mounting  
hole dimensions below.

#### Mounting Hole Dimensions

For 25mm, 37.5mm, and 50mm width duct.

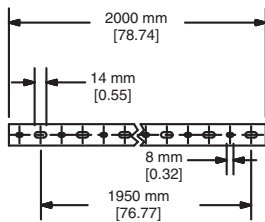

For 75mm and 100mm width duct.

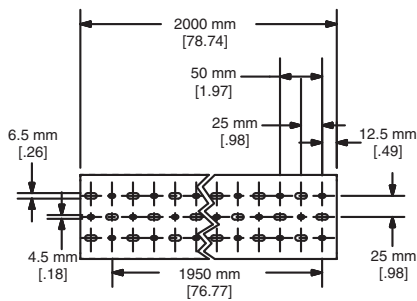

D1.  
Terminals

D2.  
Power  
Connectors

D3.  
Grounding  
Connectors

E1.  
Labeling  
Systems

E2.  
Labels

E3.  
Pre-Printed  
& Write-On  
Markers

E4.  
Permanent  
Identification

E5.  
Lockout/  
Tagout  
& Safety  
Solutions

F.  
Index

Duct Size (W x H)	Dimensions – mm (Inches)							
	A	B	C	D	E	F	H	T
25 x 25 (.98) x (.98)	24.6 (.97)	23.6 (.93)	24.6 (.97)	13.6 (.54)	5.0 (.20)	12.5 (.49)	20.5 (.81)	1.4 (.06)
25 x 37.5 (.98) x (1.48)	24.6 (.97)	35.8 (1.41)	24.6 (.97)	24.7 (.97)	5.0 (.20)	12.5 (.49)	33.0 (1.30)	1.4 (.06)
25 x 50 (.98) x (1.97)	24.6 (.97)	47.8 (1.88)	24.6 (.97)	34.8 (1.37)	5.0 (.20)	12.5 (.49)	45.5 (1.79)	1.5 (.06)
25 x 62.5 (.98) x (2.46)	24.6 (.97)	59.7 (2.35)	24.6 (.97)	45.8 (1.80)	5.0 (.20)	12.5 (.49)	58.0 (2.28)	1.5 (.06)
25 x 75 (.98) x (2.95)	24.6 (.97)	73.2 (2.88)	24.6 (.97)	57.6 (2.27)	5.0 (.20)	12.5 (.49)	70.5 (2.78)	1.7 (.07)
37.5 x 37.5 (1.48) x (1.48)	37.1 (1.46)	35.8 (1.41)	37.1 (1.46)	24.7 (.97)	5.0 (.20)	12.5 (.49)	33.0 (1.30)	1.5 (.06)
37.5 x 50 (1.48) x (1.97)	37.1 (1.46)	47.8 (1.88)	37.1 (1.46)	34.8 (1.37)	5.0 (.20)	12.5 (.49)	45.5 (1.79)	1.7 (.07)
37.5 x 62.5 (1.48) x (2.46)	37.1 (1.46)	59.7 (2.35)	37.1 (1.46)	45.8 (1.80)	5.0 (.20)	12.5 (.49)	58.0 (2.28)	1.7 (.07)
37.5 x 75 (1.48) x (2.95)	37.1 (1.46)	72.4 (2.85)	37.1 (1.46)	57.6 (2.27)	5.0 (.20)	12.5 (.49)	70.5 (2.78)	1.8 (.07)
50 x 50 (1.97) x (1.97)	49.5 (1.95)	48.0 (1.89)	49.6 (1.95)	34.8 (1.37)	5.0 (.20)	12.5 (.49)	45.5 (1.79)	1.7 (.07)
50 x 75 (1.97) x (2.95)	49.5 (1.95)	72.4 (2.85)	49.6 (1.95)	57.6 (2.27)	5.0 (.20)	12.5 (.49)	70.5 (2.78)	1.9 (.08)
50 x 100 (1.97) x (3.94)	49.5 (1.95)	97.8 (3.85)	49.6 (1.95)	81.0 (3.19)	5.0 (.20)	12.5 (.49)	95.5 (3.76)	2.2 (.09)
62.5 x 62.5 (2.46) x (2.46)	62.0 (2.44)	59.7 (2.35)	62.1 (2.44)	45.8 (1.80)	5.0 (.20)	12.5 (.49)	58.0 (2.28)	1.8 (.07)
75 x 50 (2.95) x (1.97)	74.7 (2.94)	48.0 (1.89)	74.6 (2.94)	34.8 (1.37)	5.0 (.20)	12.5 (.49)	45.5 (1.79)	2.0 (.08)
75 x 62.5 (2.95) x (2.46)	74.7 (2.94)	59.7 (2.35)	74.6 (2.94)	45.8 (1.80)	5.0 (.20)	12.5 (.49)	58.0 (2.28)	2.0 (.08)
75 x 75 (2.95) x (2.95)	74.7 (2.94)	73.2 (2.88)	74.6 (2.94)	57.6 (2.27)	5.0 (.20)	12.5 (.49)	70.5 (2.78)	2.2 (.09)
75 x 100 (2.95) x (3.94)	74.7 (2.94)	97.8 (3.85)	74.6 (2.94)	81.0 (3.19)	5.0 (.20)	12.5 (.49)	95.5 (3.76)	2.3 (.09)
100 x 50 (3.94) x (1.97)	99.6 (3.92)	48.0 (1.89)	99.6 (3.92)	34.8 (1.37)	5.0 (.20)	12.5 (.49)	45.5 (1.79)	2.0 (.08)
100 x 75 (3.94) x (2.95)	99.6 (3.92)	73.2 (2.88)	99.6 (3.92)	57.6 (2.27)	5.0 (.20)	12.5 (.49)	70.5 (2.78)	2.5 (.10)
100 x 100 (3.94) x (3.94)	99.6 (3.92)	97.8 (3.85)	99.6 (3.92)	81.0 (3.19)	5.0 (.20)	12.5 (.49)	99.5 (3.76)	2.5 (.10)

### Panduit® Type NNC Wiring Duct Dimensions

Dimensions are shown for reference only. Contact Panduit Customer Service at 800-777-3300 for specific dimensional needs.

For 25mm, 37.5mm, and 50mm high duct.

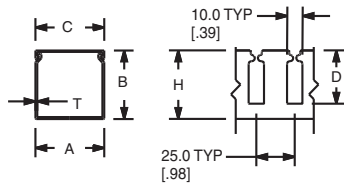

For 75mm and 100mm high duct.

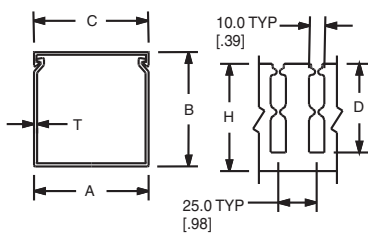

#### Mounting Hole Dimensions

For 25mm, 37.5mm, and 50mm width duct.

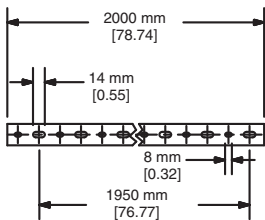

For 75mm and 100mm width duct.

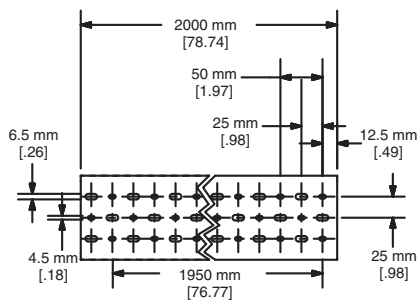

Duct Size (W x H)	Dimensions – mm (Inches)					
	A	B	C	D	H	T
25 x 25 (.98) x (.98)	24.6 (.97)	23.6 (.93)	24.6 (.97)	13.6 (.54)	20.3 (.80)	1.5 (.06)
25 x 37 (.98) x (1.48)	24.6 (.97)	35.8 (1.41)	24.6 (.97)	24.6 (.97)	33.0 (1.30)	1.8 (.07)
25 x 50 (.98) x (1.97)	24.6 (.97)	47.8 (1.88)	24.6 (.97)	34.8 (1.37)	45.5 (1.79)	2.0 (.08)
25 x 75 (.98) x (2.95)	24.6 (.97)	72.4 (2.85)	24.6 (.97)	57.6 (2.27)	70.6 (2.78)	2.0 (.08)
37.5 x 37.5 (1.48) x (1.48)	37.1 (1.46)	35.8 (1.41)	37.1 (1.46)	24.7 (.97)	33.0 (1.30)	1.8 (.07)
37.5 x 50 (1.48) x (1.97)	37.1 (1.46)	47.8 (1.88)	37.1 (1.46)	34.8 (1.37)	45.5 (1.79)	2.0 (.08)
37.5 x 75 (1.48) x (2.95)	37.1 (1.46)	72.4 (2.85)	37.1 (1.46)	57.6 (2.27)	70.6 (2.78)	2.0 (.08)
50 x 50 (1.97) x (1.97)	49.5 (1.95)	47.8 (1.88)	49.5 (1.95)	34.8 (1.37)	45.5 (1.79)	2.0 (.08)
50 x 75 (1.97) x (2.95)	49.5 (1.95)	72.4 (2.85)	49.5 (1.95)	57.6 (2.27)	70.6 (2.78)	2.0 (.08)
50 x 100 (1.97) x (3.94)	49.5 (1.95)	97.8 (3.85)	49.5 (1.95)	81.0 (3.19)	95.5 (3.76)	2.3 (.09)
75 x 75 (2.95) x (2.95)	74.7 (2.94)	72.4 (2.85)	74.7 (2.94)	57.6 (2.27)	70.6 (2.78)	2.0 (.08)
100 x 50 (3.94) x (1.97)	99.6 (3.92)	47.8 (1.88)	99.6 (3.92)	34.8 (1.37)	45.5 (1.79)	2.0 (.08)
100 x 75 (3.94) x (2.95)	99.6 (3.92)	72.4 (2.85)	99.6 (3.92)	57.6 (2.27)	70.6 (2.78)	2.0 (.08)
100 x 100 (3.92) x (3.85)	99.6 (3.92)	97.8 (3.85)	99.6 (3.92)	81.0 (3.19)	95.5 (3.76)	2.3 (.09)

A.  
System  
Overview

B1.  
Cable Ties

B2.  
Cable  
Accessories

B3.  
Stainless  
Steel Ties

C1.  
Wiring  
Duct

C2.  
Surface  
Raceway

C3.  
Abrasion  
Protection

C4.  
Cable  
Management

D1.  
Terminals

D2.  
Power  
Connectors

D3.  
Grounding  
Connectors

E1.  
Labeling  
Systems

E2.  
Labels

E3.  
Pre-Printed  
& Write-On  
Markers

E4.  
Permanent  
Identification

E5.  
Lockout/  
Tagout  
& Safety  
Solutions

F.  
Index

### Panduit® Type NE Wiring Duct Dimensions

Dimensions are shown for reference only. Contact Panduit Customer Service at 800-777-3300 for specific dimensional needs.

A.  
System  
Overview

B1.  
Cable Ties

B2.  
Cable  
Accessories

B3.  
Stainless  
Steel Ties

C1.  
Wiring  
Duct

C2.  
Surface  
Raceway

C3.  
Abrasion  
Protection

C4.  
Cable  
Management

D1.  
Terminals

D2.  
Power  
Connectors

D3.  
Grounding  
Connectors

E1.  
Labeling  
Systems

E2.  
Labels

E3.  
Pre-Printed  
& Write-On  
Markers

E4.  
Permanent  
Identification

E5.  
Lockout/  
Tagout  
& Safety  
Solutions

F.  
Index

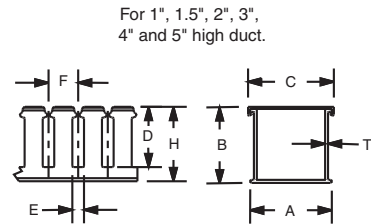
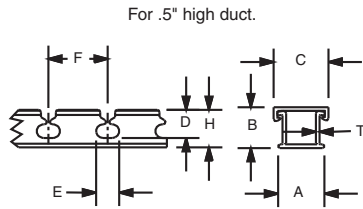

**Mounting Hole Dimensions**  
For .5", .75", 1" and 1.5" wide duct.

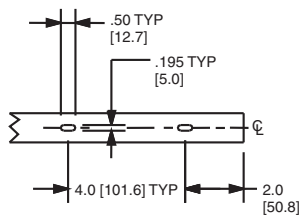

For 2.0", 2.5", 3" and 4" wide duct.

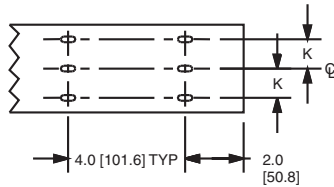

Duct Size (W x H)	Dimensions – Inches (mm)									
	A	B	C	D	E	F	H	K	T	
.5 x .5 (12.7) x (12.7)	.63 (16.0)	.56 (14.2)	.69 (17.5)	.38 (9.7)	.37 (9.4)	.80 (20.3)	.50 (12.7)	ON CENTERLINE	.05 (1.3)	
.5 x 1 (12.7) x (25.4)	.63 (16.0)	1.06 (26.9)	.69 (17.5)	.75 (19.1)	.31 (7.9)	.80 (20.3)	1.00 (25.4)		.06 (1.5)	
1 x 1 (25.4) x (25.4)	1.14 (29.0)	1.06 (26.9)	1.25 (31.8)	.75 (19.1)	.31 (7.9)	.80 (20.3)	1.00 (25.4)		.06 (1.5)	
1 x 1.5 (25.4) x (38.1)	1.14 (29.0)	1.62 (41.1)	1.25 (31.8)	1.20 (30.5)	.31 (7.9)	.80 (20.3)	1.50 (38.1)		.07 (1.8)	
1 x 2 (25.4) x (50.8)	1.14 (29.0)	2.06 (52.3)	1.25 (31.8)	1.63 (41.4)	.31 (7.9)	.80 (20.3)	2.00 (50.8)		.07 (1.8)	
1 x 3 (25.4) x (76.2)	1.14 (29.0)	3.06 (77.7)	1.25 (31.8)	2.63 (66.8)	.31 (7.9)	1.00 (25.4)	3.00 (76.2)		.07 (1.8)	
1 x 4 (25.4) x (101.6)	1.14 (29.0)	4.06 (103.1)	1.25 (31.8)	3.63 (92.2)	.31 (7.9)	1.00 (25.4)	4.00 (101.6)		.08 (2.0)	
1.5 x 1.5 (38.1) x (38.1)	1.64 (41.7)	1.62 (41.1)	1.75 (44.5)	1.20 (30.5)	.31 (7.9)	.80 (20.3)	1.50 (38.1)		.07 (1.8)	
1.5 x 2 (38.1) x (50.8)	1.64 (41.7)	2.06 (52.3)	1.75 (44.5)	1.63 (41.4)	.31 (7.9)	.80 (20.3)	2.00 (50.8)		.07 (1.8)	
1.5 x 3 (38.1) x (76.2)	1.64 (41.7)	3.06 (77.7)	1.75 (44.5)	2.63 (66.8)	.31 (7.9)	1.00 (25.4)	3.00 (76.2)		.07 (1.8)	
1.5 x 4 (38.1) x (101.6)	1.64 (41.7)	4.06 (103.1)	1.75 (44.5)	3.63 (92.2)	.31 (7.9)	1.00 (25.4)	4.00 (101.6)		.08 (2.0)	
2 x 1 (50.8) x (25.4)	2.14 (54.4)	1.06 (26.9)	2.25 (57.2)	.75 (19.1)	.31 (7.9)	.80 (20.3)	1.00 (25.4)		.50 (12.7)	.06 (1.5)
2 x 2 (50.8) x (50.8)	2.14 (54.4)	2.06 (52.3)	2.25 (57.2)	1.63 (41.4)	.31 (7.9)	.80 (20.3)	2.00 (50.8)		.50 (12.7)	.07 (1.8)
2 x 3 (50.8) x (76.2)	2.14 (54.4)	3.06 (77.7)	2.25 (57.2)	2.63 (66.8)	.31 (7.9)	1.00 (25.4)	3.00 (76.2)		.50 (12.7)	.07 (1.8)
2 x 4 (50.8) x (101.6)	2.14 (54.4)	4.06 (103.1)	2.25 (57.2)	3.63 (92.2)	.31 (7.9)	1.00 (25.4)	4.00 (101.6)		.50 (12.7)	.08 (2.0)
3 x 1 (76.2) x (25.4)	3.14 (79.8)	1.06 (26.9)	3.25 (82.6)	.75 (19.1)	.31 (7.9)	.80 (20.3)	1.00 (25.4)		1.00 (25.4)	.06 (1.5)
3 x 2 (76.2) x (50.8)	3.14 (79.8)	2.06 (52.3)	3.25 (82.6)	1.63 (41.4)	.31 (7.9)	.80 (20.3)	2.00 (50.8)		1.00 (25.4)	.07 (1.7)
3 x 3 (76.2) x (76.2)	3.14 (79.8)	3.06 (77.7)	3.25 (82.6)	2.63 (66.8)	.31 (7.9)	1.00 (25.4)	3.00 (76.2)		1.00 (25.4)	.07 (1.8)
3 x 4 (76.2) x (101.6)	3.14 (79.8)	4.06 (103.1)	3.25 (82.6)	3.63 (92.2)	.31 (7.9)	1.00 (25.4)	4.00 (101.6)		1.00 (25.4)	.08 (2.0)
3 x 5 (76.2) x (127.0)	3.14 (79.8)	5.06 (128.5)	3.25 (82.6)	4.63 (117.6)	.38 (9.7)	1.33 (33.8)	5.00 (127.0)		1.00 (25.4)	.09 (2.3)
4 x 2 (101.6) x (50.8)	4.14 (105.2)	2.06 (52.3)	4.25 (108.0)	1.63 (41.4)	.31 (7.9)	.80 (20.3)	2.00 (50.8)	1.50 (38.1)	.07 (1.8)	
4 x 3 (101.6) x (76.2)	4.14 (105.2)	3.06 (77.7)	4.25 (108.0)	2.63 (66.8)	.31 (7.9)	1.00 (25.4)	3.00 (76.2)	1.50 (38.1)	.07 (1.8)	
4 x 4 (101.6) x (101.6)	4.14 (105.2)	4.06 (103.1)	4.25 (108.0)	3.63 (92.2)	.31 (7.9)	1.00 (25.4)	4.00 (101.6)	1.50 (38.1)	.08 (2.0)	
4 x 5 (101.6) x (127.0)	4.14 (105.2)	5.06 (128.5)	4.25 (108.0)	4.63 (117.6)	.38 (9.7)	1.33 (33.8)	5.00 (127.0)	1.50 (38.1)	.09 (2.3)	



### Panduit® Type H and HS Wiring Duct Dimensions

Dimensions are shown for reference only. Contact Panduit Customer Service at 800-777-3300 for specific dimensional needs.

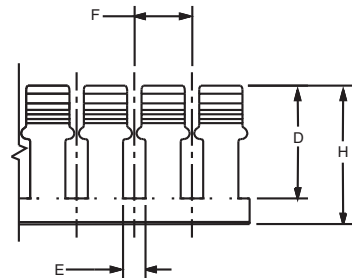
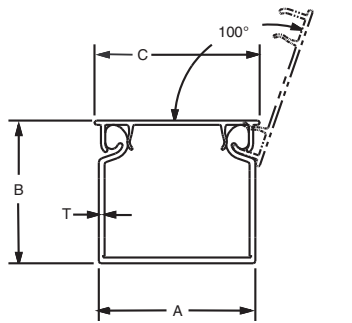

	E	F
For 2" duct height:	.31" [7.9]	.80" [20.3]
3" to 4" duct height:	.31" [7.9]	1.00" [25.4]

Duct Size (W x H)	Dimensions – Inches (mm)								
	A	B	C	D	E	F	H	K	T
1.5 x 2 (38.1) x (50.8)	1.75 (44.5)	1.98 (50.3)	1.88 (47.8)	1.63 (41.4)	.31 (7.9)	.80 (20.3)	1.92 (48.8)	.50 (12.7)	.08 (2.0)
1.5 x 3 (38.1) x (76.2)	1.75 (44.5)	3.06 (77.7)	1.88 (47.8)	2.63 (66.8)	.31 (7.9)	1.00 (25.4)	3.00 (76.2)		.10 (2.5)
2 x 2 (50.8) x (50.8)	2.17 (55.1)	1.98 (50.3)	2.29 (58.2)	1.57 (39.9)	.31 (7.9)	.80 (20.3)	1.92 (48.8)	.50 (12.7)	.08 (2.0)
2 x 3 (50.8) x (76.2)	2.17 (55.1)	3.06 (77.7)	2.29 (58.2)	2.63 (66.8)	.31 (7.9)	1.00 (25.4)	3.00 (76.2)		.10 (2.5)
2 x 4 (50.8) x (101.6)	2.17 (55.1)	4.1 (104.1)	4.38 (111.3)	3.63 (92.2)	.31 (7.9)	1.00 (25.4)	4.00 (101.6)	.50 (12.7)	.10 (2.7)
3 x 3 (76.2) x (76.2)	3.25 (82.6)	3.06 (77.7)	3.38 (85.9)	2.63 (66.8)	.31 (7.9)	1.00 (25.4)	3.00 (76.2)		1.00 (25.4)
3 x 4 (76.2) x (101.6)	3.25 (82.6)	4.1 (104.1)	3.38 (85.9)	3.63 (92.2)	.31 (7.9)	1.00 (25.4)	4.00 (101.6)	1.00 (25.4)	.11 (2.8)
4 x 4 (101.6) x (101.6)	4.25 (108.0)	4.1 (104.1)	4.38 (111.3)	3.63 (92.2)	.31 (7.9)	1.00 (25.4)	4.00 (101.6)	1.50 (38.1)	.11 (2.8)

For 2", 3", and 4" wide duct.



### Panduit® Type HN Wiring Duct Dimensions

Dimensions are shown for reference only. Contact Panduit Customer Service at 800-777-3300 for specific dimensional needs.



Multiple slot restrictors present with 2" and greater duct wall height.

Duct Size (W x H)	Dimensions – Inches (mm)								
	A	B	C	D	E	F	H	K	T
1.5 x 2 (38.1) x (50.8)	1.75 (44.5)	1.98 (50.3)	1.88 (47.8)	1.63 (41.4)	.20 (5.0)	.50 (12.7)	1.92 (48.8)	.50 (12.7)	.08 (2.0)
1.5 x 3 (38.1) x (76.2)	1.75 (44.5)	3.06 (77.7)	1.88 (47.8)	2.63 (66.8)	.20 (5.0)	.50 (12.7)	3.00 (76.2)		.10 (2.5)
2 x 2 (50.8) x (50.8)	2.17 (55.1)	1.98 (50.3)	2.29 (58.2)	1.57 (39.9)	.20 (5.0)	.50 (12.7)	1.92 (48.8)	.50 (12.7)	.08 (2.0)
2 x 3 (50.8) x (76.2)	2.17 (55.1)	3.06 (77.7)	2.29 (58.2)	2.63 (66.8)	.20 (5.0)	.50 (12.7)	3.00 (76.2)		.10 (2.5)
2 x 4 (50.8) x (101.6)	2.17 (55.1)	4.1 (104.1)	4.38 (111.3)	3.63 (92.2)	.20 (5.0)	.50 (12.7)	4.00 (101.6)	.50 (12.7)	.10 (2.7)
3 x 3 (76.2) x (76.2)	3.25 (82.6)	3.06 (77.7)	3.38 (85.9)	2.63 (66.8)	.20 (5.0)	.50 (12.7)	3.00 (76.2)		1.00 (25.4)
3 x 4 (76.2) x (101.6)	3.25 (82.6)	4.1 (104.1)	3.38 (85.9)	3.63 (92.2)	.20 (5.0)	.50 (12.7)	4.00 (101.6)	1.00 (25.4)	.11 (2.8)
4 x 4 (101.6) x (101.6)	4.25 (108.0)	4.1 (104.1)	4.38 (111.3)	3.63 (92.2)	.20 (5.0)	.50 (12.7)	4.00 (101.6)	1.50 (38.1)	.11 (2.8)

For 2", 3", and 4" wide duct.



A. System Overview

B1. Cable Ties

B2. Cable Accessories

B3. Stainless Steel Ties

C1. Wiring Duct

C2. Surface Raceway

C3. Abrasion Protection

C4. Cable Management

D1. Terminals

D2. Power Connectors

D3. Grounding Connectors

E1. Labeling Systems

E2. Labels

E3. Pre-Printed & Write-On Markers

E4. Permanent Identification

E5. Lockout/Tagout & Safety Solutions

F. Index

A. System Overview

### Panduit® Type FL Wiring Duct Dimensions

Dimensions are shown for reference only.

Dimensions are in mm (in.). Contact Panduit Customer Service at 800-777-3300 for specific dimensional needs.

B1. Cable Ties

B2. Cable Accessories

B3. Stainless Steel Ties

C1. Wiring Duct

C2. Surface Raceway

C3. Abrasion Protection

C4. Cable Management

D1. Terminals

D2. Power Connectors

D3. Grounding Connectors

E1. Labeling Systems

E2. Labels

E3. Pre-Printed & Write-On Markers

E4. Permanent Identification

E5. Lockout/Tagout & Safety Solutions

F. Index

Mounting Hole Dimensions  
For FL12X12LG-A



For FL25X25LG-A and FL50X50LG-A

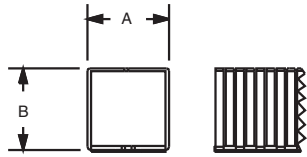

Note: 'B' dimension is without adhesive.

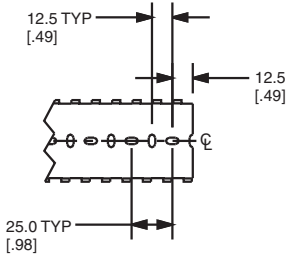

Nominal Duct Size (W x H) mm	Dimensions – mm (In.)	
	A	B
12 x 12 (.49) x (.49)	12.4 (.49)	12.4 (.49)
25 x 25 (.98) x (.98)	24.9 (.98)	24.9 (.98)
50 x 50 (1.97) x (1.97)	50 (1.97)	50 (1.97)

Note: Type FL wiring duct has factory applied adhesive. For 50 x 50 two strips of tape are used; otherwise, only one strip is centered on the part.

### Panduit® PanelMax™ DIN Rail Wiring Duct – Wirefill Capacity

Nominal Duct Size (W x H) In.	Area per channel In. <sup>2</sup>	Electrical														Communication						
		8 AWG		10 AWG		12 AWG		14 AWG		16 AWG		18 AWG		22 AWG		23 AWG	23/24 AWG	24 AWG	Fiber Cable			
		.216	.164	.130	.141	.152	.111	.124	.133	.096	.111	.118	.084	.100	.106	.085	.298	.289	.250	.187	.118	
DRD22	6.25 x 2.15	4.760	51	88	140	119	103	193	154	134	258	193	170	337	238	211	329	26	28	38	68	170
DRD33	7.25 x 3.16	6.536	70	121	193	164	141	265	212	184	354	265	234	463	326	290	452	36	39	52	93	234
DRD44	8.25 x 4.16	9.180	98	170	271	230	198	372	298	259	498	372	329	650	459	408	635	51	54	73	131	329

Table shows maximum wirefill per channel based on 50% of duct internal cross sectional area. Formula = internal area/2.00 x D<sup>2</sup>.

### Panduit® PanelMax™ Corner Wiring Duct – Wirefill Capacity

Nominal Duct Size (W x H) In.	Area In. <sup>2</sup>	Electrical														Communication					
		8 AWG		10 AWG		12 AWG		14 AWG		16 AWG		18 AWG		22 AWG		23 AWG	23/24 AWG	24 AWG	Fiber Cable		
		.216	.164	.130	.141	.152	.111	.124	.133	.096	.111	.118	.084	.100	.106	.085	.330	.250	.190	.118	
CWD3	4.4 x 3.6	17.580	188	326	520	442	380	713	571	496	953	713	631	1245	879	782	1216	80	140	243	630
CWD4	5.4 x 4.6	26.920	288	500	796	677	582	1092	875	760	1460	1092	966	1907	1346	1197	1862	123	215	372	964

Table shows maximum wirefill based on 50% of duct internal cross sectional area. Formula = area/2.00 x D<sup>2</sup>.

### Panduit® Type H, HN, and HS Wiring Duct – Wirefill Capacity

Nominal Duct Size (W x H) In.	Nominal Area In. <sup>2</sup>	Electrical														Communication				
		8 AWG		10 AWG		12 AWG		14 AWG		16 AWG		18 AWG		22 AWG		23 AWG	23/24 AWG	24 AWG	Fiber Cable	
		.216	.164	.130	.141	.152	.111	.124	.133	.096	.111	.118	.084	.100	.106	.085	.330	.250	.190	.118
1.50 x 2.00	3.000	34	60	95	81	70	131	105	91	175	131	116	229	162	144	224	14	25	44	116
1.50 x 3.00	4.500	52	90	143	122	105	197	158	137	263	197	174	344	243	216	336	22	38	67	174
2.00 x 2.00	4.000	46	80	127	108	93	175	140	122	234	175	155	306	216	192	299	19	34	59	154
2.00 x 3.00	6.000	69	120	191	163	140	263	210	183	351	263	232	459	324	288	448	29	51	89	232
2.00 x 4.00	8.000	92	160	255	217	187	350	281	244	469	350	310	612	432	384	598	39	69	119	309
3.00 x 3.00	9.000	104	180	287	244	210	394	316	275	527	394	349	689	486	432	673	44	77	134	348
3.00 x 4.00	12.000	139	241	383	326	280	526	421	366	703	526	465	919	648	577	897	59	103	179	464
4.00 x 4.00	16.000	185	321	511	435	374	701	562	488	938	701	621	1225	864	769	1197	79	138	239	619

Table shows maximum wirefill based on 50% of duct internal cross sectional area. Formula = nominal area/1.85 x D<sup>2</sup>. See page C1.48 for wiring duct color and size availability. AWG dimensions represent typical outer cable diameter in inches.

### Panduit® Type D, G, F and FS Wiring Duct – Wirefill Capacity

Nominal Duct Size (W x H) In.	Nominal Area In. <sup>2</sup>	Electrical															Communication						
		8 AWG		10 AWG			12 AWG			14 AWG			16 AWG			18 AWG			22 AWG	23 AWG	23/24 AWG	24 AWG	Fiber Cable
		.216	.164	.13	.141	.152	.111	.124	.133	.096	.111	.118	.084	.100	.106	.085	.330	.25	.190	.118			
		THHN	THHN	THHN	MTW	MTW	THHN	MTW	MTW	TFFN	MTW	MTW	TFFN	MTW	MTW	MTW	Cat. 6A	Cat. 6	Cat. 5e	3.0 mm			
0.50 x 0.50	0.250	3	5	8	7	6	11	9	8	15	11	10	20	14	12	19	1	2	3	10			
0.50 x 1.00	0.500	6	10	16	14	12	23	18	16	31	23	20	40	28	25	39	2	4	7	20			
0.50 x 2.00	1.000	12	21	33	28	24	46	37	32	62	46	41	80	57	50	79	5	9	15	40			
0.75 x 0.75	0.563	6	11	19	16	13	26	20	18	34	26	23	45	32	28	44	2	5	8	23			
0.75 x 1.00	0.750	9	15	25	21	18	34	27	24	46	34	30	60	42	38	59	3	6	11	30			
0.75 x 1.50	1.125	13	23	38	32	27	52	41	36	69	52	46	91	64	57	88	5	10	17	46			
0.75 x 2.00	1.500	18	31	50	43	37	69	55	48	93	69	61	121	85	76	118	7	13	23	61			
1.00 x 1.00	1.000	12	21	33	28	24	46	37	32	62	46	41	80	57	50	79	5	9	15	40			
1.00 x 1.50	1.500	18	31	50	43	37	69	55	48	93	69	61	121	85	76	118	7	13	23	61			
1.00 x 2.00	2.000	24	42	67	57	49	92	74	64	124	92	82	161	114	101	158	10	18	31	81			
1.00 x 3.00	3.000	36	63	101	86	74	139	111	96	186	139	123	242	171	152	237	15	27	47	122			
1.00 x 4.00	4.000	48	84	135	114	98	185	148	129	248	185	164	323	228	203	316	20	36	63	163			
1.50 x 1.00	1.500	18	31	50	43	37	69	55	48	93	69	61	121	85	76	118	7	13	23	61			
1.50 x 1.50	2.250	27	47	76	64	55	104	83	72	139	104	92	182	128	114	177	11	20	35	92			
1.50 x 2.00	3.000	36	63	101	86	74	139	111	96	186	139	123	242	171	152	237	15	27	47	122			
1.50 x 3.00	4.500	55	95	152	129	111	208	167	145	279	208	184	364	257	228	355	23	41	71	184			
1.50 x 4.00	6.000	73	127	202	172	148	278	222	193	372	278	246	485	342	305	474	31	54	94	245			
2.00 x 1.00	2.000	24	42	67	57	49	92	74	64	124	92	82	161	114	101	158	10	18	31	81			
2.00 x 1.50	3.000	36	63	101	86	74	139	111	96	186	139	123	242	171	152	237	15	27	47	122			
2.00 x 2.00	4.000	48	84	135	114	98	185	148	129	248	185	164	323	228	203	316	20	36	63	163			
2.00 x 3.00	6.000	73	127	202	172	148	278	222	193	372	278	246	485	342	305	474	31	54	94	245			
2.00 x 4.00	8.000	97	169	270	229	197	371	297	258	496	371	328	647	457	406	632	41	73	126	327			
2.00 x 5.00	10.000	122	212	338	287	247	463	371	323	620	463	410	809	571	508	790	52	91	158	409			
2.50 x 3.00	7.500	91	159	253	215	185	347	278	242	465	347	307	607	428	381	593	39	68	118	307			
3.00 x 1.00	3.000	36	63	101	86	74	139	111	96	186	139	123	242	171	152	237	15	27	47	122			
3.00 x 2.00	6.000	73	127	202	172	148	278	222	193	372	278	246	485	342	305	474	31	54	94	245			
3.00 x 3.00	9.000	110	191	304	258	222	417	334	290	558	417	369	728	514	457	711	47	82	142	368			
3.00 x 4.00	12.000	146	254	405	344	296	556	445	387	744	556	492	971	685	610	949	62	109	189	491			
3.00 x 5.00	15.000	183	318	507	431	370	695	557	484	930	695	615	1214	857	762	1186	78	137	237	614			
4.00 x 1.50	6.000	73	127	202	172	148	278	222	193	372	278	246	485	342	305	474	31	54	94	245			
4.00 x 2.00	8.000	97	169	270	229	197	371	297	258	496	371	328	647	457	406	632	41	73	126	327			
4.00 x 3.00	12.000	146	254	405	344	296	556	445	387	744	556	492	971	685	610	949	62	109	189	491			
4.00 x 4.00	16.000	195	339	540	459	395	742	594	516	992	742	656	1295	914	813	1265	83	146	253	655			
4.00 x 5.00	20.000	244	424	676	574	494	927	743	646	1240	927	820	1619	1142	1017	1581	104	182	316	819			
6.00 x 4.00	24.000	293	509	811	689	593	1113	891	775	1488	1113	984	1943	1371	1220	1898	125	219	379	983			

Table shows maximum wirefill based on 50% of duct internal cross sectional area. Formula = nominal area/1.75 x D<sup>2</sup>. See page C1.48 for wiring duct color and size availability. Not all sizes available for each duct type.  
 AWG dimensions represent typical outer cable diameter in inches.

A. System Overview

B1. Cable Ties

B2. Cable Accessories

B3. Stainless Steel Ties

C1. Wiring Duct

C2. Surface Raceway

C3. Abrasion Protection

C4. Cable Management

D1. Terminals

D2. Power Connectors

D3. Grounding Connectors

E1. Labeling Systems

E2. Labels

E3. Pre-Printed & Write-On Markers

E4. Permanent Identification

E5. Lockout/Tagout & Safety Solutions

F. Index

### Panduct® Type MC and NNC Wiring Duct – Wirefill Capacity

Nominal Duct Size (W x H) mm	Nominal Area mm <sup>2</sup>	Electrical															Communication				
		8 AWG		10 AWG		12 AWG			14 AWG			16 AWG		18 AWG			22 AWG	23 AWG	23/24 AWG	24 AWG	Fiber Cable
		5.5	4.2	3.3	3.6	3.9	2.8	3.1	3.4	2.4	2.8	3	2.1	2.5	2.7	2.2	8.4	6.4	4.8	3	
		THHN	THHN	THHN	MTW	MTW	THHN	MTW	MTW	TFFN	MTW	MTW	TFFN	MTW	MTW	MTW	Cat. 6A	Cat. 6	Cat. 5e	3.0 mm	
25 x 25	625	11	20	32	27	23	44	36	31	60	44	39	78	55	49	76	5	8	15	39	
25 x 37	925	17	30	48	41	35	66	53	46	88	66	58	116	81	72	113	7	13	22	58	
25 x 50	1250	23	41	65	55	47	89	72	62	120	89	79	156	110	98	153	10	17	30	79	
25 x 62	1550	29	51	81	69	59	111	89	77	148	111	98	194	137	122	190	12	21	38	98	
25 x 75	1875	35	61	98	83	71	134	108	93	180	134	119	235	166	147	229	15	26	46	119	
37 x 37	1369	25	45	71	60	52	98	78	68	131	98	87	171	121	107	167	11	19	33	86	
37 x 50	1850	35	60	96	82	70	132	106	92	177	132	117	232	163	145	226	15	26	45	117	
37 x 62	2294	43	75	120	102	87	164	132	114	220	164	145	287	203	180	281	18	32	56	145	
37 x 75	2775	52	91	145	123	106	199	159	138	266	199	176	348	245	218	340	22	39	68	176	
50 x 50	2500	47	82	131	111	95	179	144	125	240	179	159	313	221	197	306	20	35	61	158	
50 x 75	3750	71	123	196	167	143	269	216	187	360	269	238	470	332	295	459	30	53	92	238	
50 x 100	5000	94	164	262	222	191	359	288	250	480	359	318	627	442	394	612	40	70	122	317	
62 x 62	3844	72	126	201	171	147	276	221	192	369	276	244	482	340	303	471	31	54	94	244	
75 x 50	3750	71	123	196	167	143	269	216	187	360	269	238	470	332	295	459	30	53	92	238	
75 x 62	4650	88	153	243	207	178	334	267	232	446	334	295	583	411	366	570	37	65	114	295	
75 x 75	5625	106	185	294	250	215	404	324	281	540	404	357	706	498	443	689	45	79	138	357	
75 x 100	7500	142	246	393	334	287	539	432	375	720	539	477	941	664	591	919	60	106	184	476	
100 x 50	5000	94	164	262	222	191	359	288	250	480	359	318	627	442	394	612	40	70	122	317	
100 x 75	7500	142	246	393	334	287	539	432	375	720	539	477	941	664	591	919	60	106	184	476	
100 x 100	10000	189	329	524	445	383	718	576	500	961	718	636	1255	885	788	1225	81	141	245	634	

Table shows maximum wirefill based on 50% of duct internal cross sectional area. Formula = nominal area/1.75 x D<sup>2</sup>. See page C1.48 for wiring duct color and size availability. Not all sizes available for each duct type.  
 AWG dimensions represent typical outer cable diameter in millimeters.

- D1. Terminals
- D2. Power Connectors
- D3. Grounding Connectors
- E1. Labeling Systems
- E2. Labels
- E3. Pre-Printed & Write-On Markers
- E4. Permanent Identification
- E5. Lockout/Tagout & Safety Solutions
- F. Index

### Panduct® Type NE Wiring Duct – Wirefill Capacity

Nominal Duct Size (W x H) In.	Nominal Area In. <sup>2</sup>	Electrical															Communication					
		8 AWG		10 AWG		12 AWG			14 AWG			16 AWG			18 AWG			22 AWG	23 AWG	23/24 AWG	24 AWG	Fiber Cable
		.216	.164	.130	.141	.152	.111	.124	.133	.096	.111	.118	.084	.100	.106	.085	.330	.25	.190	.118		
		THHN	THHN	THHN	MTW	MTW	THHN	MTW	MTW	TFFN	MTW	MTW	TFFN	MTW	MTW	MTW	Cat. 6A	Cat. 6	Cat. 5e	3.0 mm		
0.50 x 0.50	0.250	2	4	7	6	5	10	8	7	13	10	8	17	12	11	17	1	2	3	8		
0.50 x 1.00	0.500	5	9	14	12	10	20	16	14	27	20	17	35	25	22	34	2	4	6	17		
1.00 x 1.00	1.000	10	18	29	25	21	40	32	28	54	40	35	70	50	44	69	4	8	13	35		
1.00 x 1.50	1.500	16	27	44	37	32	60	48	42	81	60	53	106	75	66	103	6	12	20	53		
1.00 x 2.00	2.000	21	37	59	50	43	81	65	56	108	81	71	141	100	88	138	9	16	27	71		
1.00 x 3.00	3.000	32	55	88	75	64	121	97	84	162	121	107	212	150	133	207	13	24	41	107		
1.00 x 4.00	4.000	42	74	118	100	86	162	130	113	217	162	143	283	200	177	276	18	32	55	143		
1.50 x 1.50	2.250	24	41	66	56	48	91	73	63	122	91	80	159	112	100	155	10	18	31	80		
1.50 x 2.00	3.000	32	55	88	75	64	121	97	84	162	121	107	212	150	133	207	13	24	41	107		
1.50 x 3.00	4.500	48	83	133	113	97	182	146	127	244	182	161	318	225	200	311	20	36	62	161		
1.50 x 4.00	6.000	64	111	177	150	129	243	195	169	325	243	215	425	300	266	415	27	48	83	215		
2.00 x 1.00	2.000	21	37	59	50	43	81	65	56	108	81	71	141	100	88	138	9	16	27	71		
2.00 x 2.00	4.000	42	74	118	100	86	162	130	113	217	162	143	283	200	177	276	18	32	55	143		
2.00 x 3.00	6.000	64	111	177	150	129	243	195	169	325	243	215	425	300	266	415	27	48	83	215		
2.00 x 4.00	8.000	85	148	236	201	173	324	260	226	434	324	287	566	400	355	553	36	64	110	286		
3.00 x 1.00	3.000	32	55	88	75	64	121	97	84	162	121	107	212	150	133	205	13	24	41	107		
3.00 x 2.00	6.000	64	111	177	150	129	243	195	169	325	243	215	425	300	266	415	27	48	83	215		
3.00 x 3.00	9.000	96	167	266	226	194	365	292	254	488	365	323	637	450	400	622	41	72	124	322		
3.00 x 4.00	12.000	128	223	355	301	259	486	390	339	651	486	430	850	600	533	830	55	96	166	430		
3.00 x 5.00	15.000	160	278	443	377	324	608	487	423	813	608	538	1062	750	667	1038	68	120	207	537		
4.00 x 2.00	8.000	85	148	236	201	173	324	260	226	434	324	287	566	400	355	553	36	64	110	286		
4.00 x 3.00	12.000	128	223	355	301	259	486	390	339	651	486	430	850	600	533	830	55	96	166	430		
4.00 x 4.00	16.000	171	297	473	402	346	649	520	452	868	649	574	1133	800	711	1107	73	128	221	573		
4.00 x 5.00	20.000	214	371	591	502	432	811	650	565	1085	811	718	1417	1000	889	1384	91	160	277	716		

Table shows maximum wirefill based on 50% of duct internal cross sectional area. Formula = nominal area/2.00 x D<sup>2</sup>. AWG dimensions represent typical outer cable diameter in inches.

### Panduct® Type FL Wiring Duct – Wirefill Capacity

Nominal Duct Size (W x H) mm	Nominal Area mm <sup>2</sup>	Electrical															Communication					
		8 AWG		10 AWG		12 AWG			14 AWG			16 AWG			18 AWG			22 AWG	23 AWG	23/24 AWG	24 AWG	Fiber Cable
		5.5	4.2	3.3	3.6	3.9	2.8	3.1	3.4	2.4	2.8	3.0	2.1	2.5	2.7	2.2	8.4	6.4	4.8	3.0		
		THHN	THHN	THHN	MTW	MTW	THHN	MTW	MTW	TFFN	MTW	MTW	TFFN	MTW	MTW	MTW	Cat. 6A	Cat. 6	Cat. 5e	3.0 mm		
12 x 12	144	1	3	5	4	3	7	5	5	9	7	6	12	8	7	12	0	1	2	6		
25 x 25	625	8	14	22	19	16	31	25	21	42	31	27	54	38	34	53	3	6	10	27		
50 x 50	2500	33	57	91	77	67	125	100	87	168	125	111	219	155	137	214	14	24	42	111		

Table shows maximum wirefill based on 50% of duct internal cross sectional area. Formula = nominal area/2.50 x D<sup>2</sup>. AWG dimensions represent typical outer cable diameter in millimeters.

A. System Overview

B1. Cable Ties

B2. Cable Accessories

B3. Stainless Steel Ties

C1. Wiring Duct

C2. Surface Raceway

C3. Abrasion Protection

C4. Cable Management

D1. Terminals

D2. Power Connectors

D3. Grounding Connectors

E1. Labeling Systems

E2. Labels

E3. Pre-Printed & Write-On Markers

E4. Permanent Identification

E5. Lockout/Tagout & Safety Solutions

F. Index

A. System Overview

### Wirefill Formula

B1. Cable Ties

#### General Formula

Panduit Wiring Duct wirefills are calculated using the following general formula:

$$50\% \text{ Wirefill} = 50\% \text{ of } \left( \frac{\text{Usable Duct Area}}{\text{Wire Area}} \right)$$

B2. Cable Accessories

B3. Stainless Steel Ties

#### Why use a 50% Wirefill?

As specified in NFPA79-2007 section 13.5.2, *Percentage Fills of Raceways (Ducts)*, a 50% wirefill is given as the maximum wirefill capacity in all Panduit Wiring Ducts. This helps ensure general safe wiring practices are followed. In actual practice, a 50% wirefill is the maximum amount of wiring the duct can hold given the additional airspace created between cables by non-uniform cable shapes, cable interlacing, and cable packing factors.

C1. Wiring Duct

C2. Surface Raceway

#### What is the Usable Duct Area?

The usable area we define as the calculation of internal area that can be occupied by wires or cables.

##### Calculation of Internal Area



Since we use the outer channel dimensions in our calculation, we make an adjustment in our formula for the thickness of material and for design elements that extend inside the channel.

##### Air Space Allotment

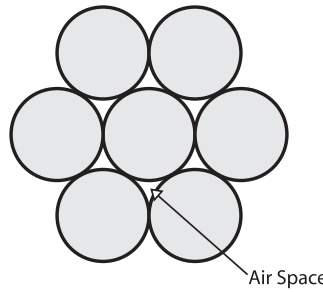

In our wirefill formula an adjustment is made to the channel internal area to account for “unusable” air space that will be present between cables when placed in the channel. Our formula assumes a uniform close packed or high-density cable arrangement (see diagram) (Note 1).

D1. Terminals

D2. Power Connectors

Considering these factors, the usable duct area is equal to an average of 90% of the nominal area, or  $(W \times H) \times .90$ .

D3. Grounding Connectors

#### Wire Area

The wire area formula is converted to allow calculation using the cable diameter:

$$A_{\text{WIRE}} = \pi r^2$$

$$A_{\text{WIRE}} = (\pi/4) \times D^2$$

$$A_{\text{WIRE}} = .785 \times D^2$$

E1. Labeling Systems

E2. Labels

#### Formula Derivation

Inserting the elements from above into the general formula results in the following:

$$50\% \text{ Wirefill} = .50 \left( \frac{(W \times H) \times .90}{.785 \times D^2} \right)$$

Simplifying this formula results in the formula used for wirefill calculation (Note 2):

$$50\% \text{ Wirefill} = \left( \frac{W \times H}{1.75 \times D^2} \right)$$

E3. Pre-Printed & Write-On Markers

E4. Permanent Identification

E5. Lockout/Tagout & Safety Solutions

Note: When calculating wirefill capacity using the above formula, variables W, H, and D must be expressed in same units (i.e. mm or inches).

<sup>1</sup> This calculation does not account for additional airspace created between cables by non-uniform cable shapes, cable interlacing, and cable packing factors.

<sup>2</sup> The resulting formula is used for all Panduit flush cover ducts, this excludes type NE duct which has a different profile design that results in a divisor of  $2.0 \times D^2$  (rather than  $1.75 \times D^2$  as shown here) and type H and HS wiring duct with a profile design that results in a divisor of  $1.85 \times D^2$  and corner wiring duct which uses calculated internal area and a divisor of  $2.0 \times D^2$ .

F. Index

### Panduct® Wiring Duct and Raceway – Material Specifications

Properties	Units	Test Method	Lead-Free PVC	Halogen-Free Modified PPO (NNC, NE)	Polypropylene (FL)
<b>General</b>					
Specific gravity	g/cc	ASTM D 792	1.45	1.09	0.95
Heat deflection temperature @264 psi	°F	ASTM D 648	156	215	117
Thermal expansion	10-5 in/in/°F	ASTM D 696	3.7	3.8	N/A
Thermal conductivity	(BTU-in/hr-ft²)°F	ASTM C 177	1.3	1.3	N/A
<b>Burning Characteristics</b>					
Flammability class	—	UL 94	V-0	V-0	V-2
Smoke density @ 4 minutes	—	ASTM E 662	538	513	N/A
Limited oxygen index (LOI)	—	ASTM D 2863	35	30	25
Peak heat release rate	kW/m2	ASTM E 1354	N/A	N/A	N/A
<b>Hardness</b>					
Durometer hardness	"D"	ASTM D 2240	78	N/A	N/A
Rockwell hardness	"R"	ASTM D 785	111	116	N/A
<b>Tensile</b>					
Yield Strength	psi	ASTM D 638	6,200	7,700	3,770
Modulus	psi	ASTM D 638	390,000	350,000	172,000
<b>Flexural</b>					
Yield Strength	psi	ASTM D 790	8,700	11,500	4,350
Modulus	psi	ASTM D 790	325,000	340,000	181,250
<b>Impact strength</b>					
Notched Izod (.125")					
23°C (73°F)	ft-lb/in	ASTM D 256	4.0	5.0	1.8
0°C (32°F)	ft-lb/in		1.6	2.0	N/A
<b>Electrical Properties</b>					
Power factor:					
60 Hz @30°C (86°F)	—	ASTM D 150	2.90	N/A	N/A
1 MHz @30°C (86°F)	—		4.00	N/A	N/A
Dielectric constant:					
60 Hz @30°C (86°F)	—	ASTM D 150	3.90	N/A	N/A
1 MHz @30°C (86°F)	—		3.30	N/A	N/A
Dielectric strength:					
Unconditioned	volts/mil	ASTM D 149	690	N/A	N/A
Conditioned	volts/mil		700	N/A	N/A

Note: To the best of our knowledge the above information is accurate. Panduit assumes no liability for the accuracy or completeness of this information.

#### Rigid Polyvinyl Chloride (PVC)

A general purpose material for use in indoor applications. PVC has a UL 94 flammability rating of V-0 and is UL Recognized for continuous use temperatures up to 122°F (50°C). PVC is an economical wiring duct material.

#### Halogen-Free (Modified Polyphenylene Oxide)

A special purpose material for use in halogen-free or high temperature applications. Modified PPO has a UL 94 flammability rating of V-0 and is UL Recognized for continuous use temperatures up to 203°F (95°C), and is 20% lighter than PVC.

#### Polypropylene

A flexible material with a UL 94 flammability rating of V-2 and UL Recognized for continuous use temperatures up to 149°F (65°C).

A. System Overview

B1. Cable Ties

B2. Cable Accessories

B3. Stainless Steel Ties

C1. Wiring Duct

C2. Surface Raceway

C3. Abrasion Protection

C4. Cable Management

D1. Terminals

D2. Power Connectors

D3. Grounding Connectors

E1. Labeling Systems

E2. Labels

E3. Pre-Printed & Write-On Markers

E4. Permanent Identification

E5. Lockout/Tagout & Safety Solutions

F. Index

### Panduct® Wiring Duct and Raceway – Color and Size Selection

System Overview	Duct Size W x H	LG Light Gray											WH White											BL Black		IB Intr. Blue*	IG Intl. Gry.		
		In.	mm																										
				G	F	FS								FL															
B1. Cable Ties	.5 x .5	12 x 12	G	F	FS							FL																	
B2. Cable Accessories	.5 x 1		G	F	FS																								
	.5 x 2		G																										
	.75 x .75		G	F	FS																								
B3. Stainless Steel Ties	.75 x 1		G																										
	.75 x 1.5		G	F																									
	.75 x 2		G																										
C1. Wiring Duct	1 x 1	25 x 25	G	F	FS							NNC	FL												G	F	MC	MC	
	1 x 1.5	25 x 37	G	F	FS							NNC													G	F	MC	MC	
	1 x 2	25 x 50	G	F	FS	D						NNC													G	F	MC	MC	
	1 x 2.5	25 x 62																											MC
C2. Surface Raceway	1 x 3	25 x 75	G	F	FS	D						NNC													G	F	MC	MC	
	1 x 4	25 x 100	G	F	FS	D																			G	F	MC	MC	
	1.5 x 1		G	F	FS																								
C3. Abrasion Protection	1.5 x 1.5	37 x 37	G	F	FS							NNC													G	F	MC	MC	
	1.5 x 2	37 x 50	G	F	FS	D	H	HN	HS	NNC															G	F	MC	MC	
	1.5 x 2.5	37 x 62																											MC
	1.5 x 3	37 x 75	G	F	FS	D	H	HN	HS	NNC															G	F	MC	MC	
	1.5 x 4		G	F		D																			G	F	MC	MC	
C4. Cable Management	2 x 1		G	F	FS																				G				
	2 x 1.5		G	F	FS																				G				
	2 x 2	50 x 50	G	F	FS	D	H	HN	HS	NNC	FL														G	F	MC	MC	
	2 x 3	50 x 75	G	F	FS	D	H	HN	HS	NNC															G	F	MC	MC	
	2 x 4	50 x 100	G	F	FS	D	H	HN	HS	NNC															G	F	MC	MC	
D1. Terminals	2 x 5		G	F																									
	2.5 x 2.5	62 x 62																											MC
	2.5 x 3		G	F		D																			G				
D2. Power Connectors	3 x 1		G	F	FS																								
	3 x 2	75 x 50	G	F	FS	D																				G	F	MC	MC
	3 x 2.5	75 x 62																											MC
	3 x 3	75 x 75	G	F	FS	D	H	HN	HS	NNC															G	F	MC	MC	
	3 x 4	75 x 100	G	F	FS	D	H	HN	HS																G	F	MC	MC	
D3. Grounding Connectors	3 x 5		G	F	FS																								
	4 x 1.5		G	F	FS																								
	4 x 2	100 x 50	G	F	FS	D					NNC														G	F	MC	MC	
	4 x 3	100 x 75	G	F	FS	D					NNC														G	F	MC	MC	
E1. Labeling Systems	4 x 4	100 x 100	G	F	FS	D	H	HN	HS	NNC															G	F	MC	MC	
	4 x 5		G	F	FS																				G				
	6 x 4		G	F	FS																								
E2. Labels	4.40 x 3.57*	111.8 x 90.7										CWD																CWD	
	5.33 x 4.58*	135.3 x 115.7										CWD																CWD	
	6.25 x 2.12**	156.7 x 54.0											DRD															DRD	
E3. Pre-Printed & Write-On Markers	7.25 x 3.12**	184.1 x 79.4											DRD															DRD	
	8.25 x 4.12**	209.5 x 104.8											DRD															DRD	

\*Corner Duct Profile  
 \*\*DIN Rail Duct Profile

#### \*Intrinsic Blue Color – IB

Intrinsic blue wiring duct is made from the same lead-free PVC material as our standard PVC duct. Intrinsic blue is an internationally recognized standard blue color that identifies the wiring duct as "incapable of releasing sufficient electrical or thermal energy under normal or abnormal conditions to cause ignition of a specific hazardous atmospheric mixture in its most easily ignited concentrations."

\*ISA-RD12.6 (Instrument Society of America)



### Installation Tips:

#### Application of Latex Paint on Panduct® Wiring Duct



The following is recommended to properly prepare the surface of the wiring duct/raceway and covers for the best adhesion of latex paint:

1. Clean surface with mild soap and water solution or mineral spirits with a clean lint free towel. Allow to dry.
2. Using a sanding pad (such as synthetic stripping pad or medium/fine steel wool), slightly roughen the surface to be painted.
3. Apply a coat of all-purpose 100% acrylic primer and allow to dry.
4. Apply the desired topcoat of latex paint and allow to dry.
5. Install the wiring duct/raceway and covers.

#### Cutting Wiring Duct and Cover

For small quantities, use the DCT duct cutting tool on page C1.34. For larger quantities use a miter cutting saw blade for clean burr-free cuts. Recommended blade: *Carbide 80T or 100T; .90" thickness, .125 kerf.*

#### Recommended Precaution when Using Type NNC and NE Wiring Duct

Cleaning solvents and cutting fluids that contain any of the following chemical agents should not come in contact with type NNC or type NE wiring duct. These chemicals are known to cause stress cracking in the halogen-free PPO material.

- Hydrocarbons
- Phenols
- Ketones
- Amines
- Ethers
- Organic, inorganic and oxidizing acids
- Petrol

Note: Panduit assumes no liability for the accuracy or completeness of this list.

#### Part Number System for Panduct® Wiring Duct

<b>G</b>	<b>.5</b>	<b>X</b>	<b>.5</b>	<b>LG</b>	<b>6</b>	<b>-A</b>
<b>Type</b>	<b>Nominal Width</b>		<b>Nominal Height</b>	<b>Color</b>	<b>Length</b>	
	In. or mm		In. or mm		Ft. or m	
G = Wide Slot Flush Design				LG = Light Gray		-A = Adhesive Backed = Without Adhesive (leave blank)
F = Narrow Slot Flush Design				WH = White		NM = No Mounting Holes
FL = Flexible Duct				BL = Black		
FS = Solid Wall Flush Design				IB = Intrinsic Blue		
H = Wide Slot Hinged Design				IG = International Gray		
HN = Narrow Slot Hinged Design						
HS = Solid Wall Hinged Design						
D = Round Hole Flush Design						
NNC = Halogen-Free Design						
NE = Halogen-Free Wide Slot Design						
MC = Metric Narrow Slot Design						

A.  
System  
Overview

### Part Number System for Panduct® PanelMax™ DIN Rail Wiring Duct

B1.  
Cable Ties

DRD

Type

DRD = DIN Rail Duct

22

Size

Capability Height  
22 = 2" Height  
33 = 3" Height  
44 = 4" Height

LG

Color

LG = Light  
Gray  
WH = White

6

Length

Ft.

B2.  
Cable  
Accessories

B3.  
Stainless  
Steel Ties

C1.  
Wiring  
Duct

### Part Number System for Panduct® PanelMax™ Corner Wiring Duct

CWD

Type

CWD = Corner Wiring Duct

3

Capability Height

3 = 3" Height  
4 = 4" Height

LG

Color

LG = Light  
Gray  
WH = White

6

Length

Ft.

C2.  
Surface  
Raceway

C3.  
Abrasion  
Protection

C4.  
Cable  
Management

D1.  
Terminals

D2.  
Power  
Connectors

D3.  
Grounding  
Connectors

E1.  
Labeling  
Systems

E2.  
Labels

E3.  
Pre-Printed  
& Write-On  
Markers

E4.  
Permanent  
Identification

E5.  
Lockout/  
Tagout  
& Safety  
Solutions

F.  
Index

### Panduit Wiring Duct Approvals and Compliances



Logo (Symbol)	Agency	Complies with:	Requirement	Applicable Products
	Underwriters Laboratories, Inc.	File No. E147128	UL 1565 CSA C22.2 No.18.5-02 "Positioning Devices."	Wiring duct types: H, HS, HN, and DRD
	Underwriters Laboratories, Inc.	File No. E147128	UL 1565	All types of wiring duct
	Canadian Standards Association	File No. 016446	CSA C22.2 No.18.5-02 "Positioning Devices."	All types of wiring duct (except DRD, H, HN, HS)
	Conformite European	Low Voltage Directive 2006/95/EEC	EN50085 cable trunking system and cable ducting systems for electrical installations <ul style="list-style-type: none"> <li>• CDS (cable ducting system for impact 2 J)</li> <li>• Minimum storage and transport temperature -5°C</li> <li>• Minimum installation and application temperature -5°C</li> <li>• Maximum application temperature 60°C</li> <li>• Non-flame propagating</li> <li>• Without electrical continuity</li> <li>• Cover removable without a tool</li> </ul>	Wiring duct types: H, HS, G, F, D, MC, FS, NNC, NE, and DRD
Logo (Symbol)	Agency	Complies with:	Requirement	Applicable Products
	DIN (Deutsches Institut für Normung), German Institute for Standardization	DIN 43 659	This European standard specifies dimensions for slotted trunkings that will be used in electrical switchgear assemblies and that conform to the corresponding requirements in DIN VDE 060 Part 506. The dimensions specified with the standard include: <ul style="list-style-type: none"> <li>• The channel mounting hole pattern, slot dimensions, pitch, and location</li> <li>• The distance from the first to last like size mounting hole</li> <li>• Minimum overall product length</li> </ul>	Wiring duct types: MC and NNC
	National Fire Protection Agency	NFPA 79-2007, section 13.3.1	"Non-metallic ducts shall be permitted (inside enclosures) only when they are made with a flame retardant material." Flame-retardant material is defined in the standard by the IEC 60332-1 test method.	Wiring duct types: H, G, F, D, MC, NNC, CWD, HN, and NE
		NFPA 79-2007, section 13.5.2	Panduit wiring duct publishes a maximum percentage wirefill for common wire types equal to 50% of the interior cross-sectional area of the duct.	All types of wiring duct
		NFPA 79-2007, section 13.1.5.9	Panduit bend radius control accessories can be mounted at right angle and T junctions created using wiring duct in order to maintain cable bend radius control.	Duct corner strip with 1" bend radius control

A.  
System  
Overview

B1.  
Cable  
Ties

B2.  
Cable  
Accessories

B3.  
Stainless  
Steel Ties

C1.  
Wiring  
Duct

C2.  
Surface  
Raceway

C3.  
Abrasion  
Protection

C4.  
Cable  
Management

D1.  
Terminals

D2.  
Power  
Connectors

D3.  
Grounding  
Connectors

E1.  
Labeling  
Systems

E2.  
Labels

E3.  
Pre-Printed  
& Write-On  
Markers

E4.  
Permanent  
Identification

E5.  
Lockout/  
Tagout/  
& Safety  
Solutions

F.  
Index

A.  
System  
Overview

### Panduit Wiring Duct Approvals and Compliances (continued)

B1.  
Cable Ties

B2.  
Cable  
Accessories

B3.  
Stainless  
Steel Ties

C1.  
Wiring  
Duct

C2.  
Surface  
Raceway

C3.  
Abrasion  
Protection

C4.  
Cable  
Management

Logo (Symbol)	Agency	Complies with:	Requirement	Applicable Products
	Underwriters Laboratories, Inc.	UL 508, section 15	An insulating barrier material shall comply with the properties indicated in Table 15.1.	PVC divider wall
		UL 508, sections 34, 181	Shall comply with minimum thickness as required in section 6.3.	SD*EMI metal barrier
	Elevated temperature	Panduit logo	Material is rated for a continuous use temperature above 167°F (75°C).	Wiring duct types: NNC and NE
	Halogen-free IEC 60754-2	Panduit logo	Material contains no fluorine, bromide, or chlorine and will not emit any corrosive or toxic gases when burned, confirmed using IEC 60754-2 test method.	Wiring duct types: NNC and NE
	Low flammability UL 94V-0	Panduit logo	Per UL standard, material is self-extinguishing and has excellent fire resistance.	Wiring duct types: NNC, NE, and all PVC wiring duct
	Low toxicity Boeing and Airbus BSS-7239, ATS 1000.1	Panduit logo	Per the Boeing and Airbus test standards, material exceeds the requirements for low levels of toxic gas release.	Wiring duct type: NNC and NE

D1.  
Terminals

D2.  
Power  
Connectors

D3.  
Grounding  
Connectors

E1.  
Labeling  
Systems

E2.  
Labels

E3.  
Pre-Printed  
& Write-On  
Markers

E4.  
Permanent  
Identification

E5.  
Lockout/  
Tagout/  
& Safety  
Solutions

F.  
Index

## FIBER-DUCT™ ROUTING SYSTEM

Panduit provides leading solutions for cable routing. These routing products are compatible with our cable management solutions increasing your ability to maintain an orderly and clean work environment, implement quick and easy moves, adds, and changes and maintain the integrity of your fiber and copper cabling plant in order to maximize long-term performance.



- Two system sizes available: 2x2 and 4x4
- Minimum 2 inch (50.8mm) bend radius fittings protect against signal loss due to excessive cable bends
- Snap-on non-slip covers
- Compatible with Panduit® FiberRunner® 12x4, 6x4, 4x4 and 2x2 Routing Systems

The 2x2 and 4x4 Fiber-Duct™ Routing Systems are comprised of channel, fittings, and brackets designed to segregate, route, and protect fiber optic and copper cabling to and between racks within the telecommunications room.

A.  
System  
Overview

B1.  
Cable Ties

B2.  
Cable  
Accessories

B3.  
Stainless  
Steel Ties

C1.  
Wiring  
Duct

C2.  
Surface  
Raceway

C3.  
Abrasion  
Protection

C4.  
Cable  
Management

D1.  
Terminals

D2.  
Power  
Connectors

D3.  
Grounding  
Connectors

E1.  
Labeling  
Systems

E2.  
Labels

E3.  
Pre-Printed  
& Write-On  
Markers

E4.  
Permanent  
Identification

E5.  
Lockout/  
Tagout  
& Safety  
Solutions

F.  
Index

A. System Overview

## 2x2 and 4x4 Fiber-Duct™ Routing Systems Roadmap

B1. Cable Ties

B2. Cable Accessories

B3. Stainless Steel Ties

C1. Wiring Duct

C2. Surface Raceway

C3. Abrasion Protection

C4. Cable Management

D1. Terminals

D2. Power Connectors

D3. Grounding Connectors

E1. Labeling Systems

E2. Labels

E3. Pre-Printed & Write-On Markers

E4. Permanent Identification

E5. Lockout/Tagout & Safety Solutions

F. Index

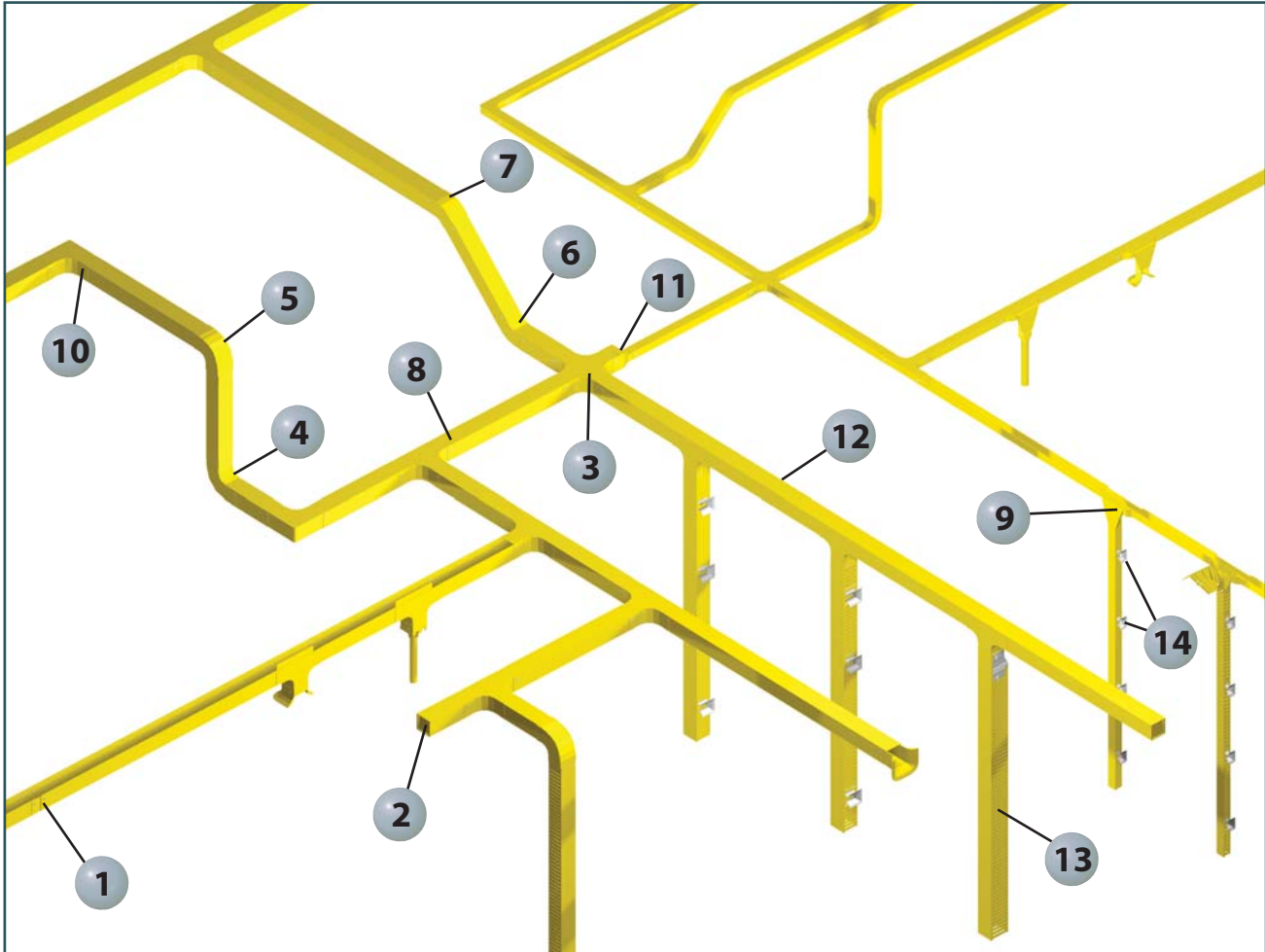

### Fiber-Duct™ Mounting Brackets



**FTRBE12 – Existing Threaded Rod Bracket**  
(page C1.60)



**FTRBN12 – New Threaded Rod Bracket**  
(page C1.60)



**FUSB – Underfloor Pedestal Bracket**  
(page C1.60)



**F2PCLB12 – Two-Piece Ladder Rack Bracket for Attaching Threaded Rod to 1 1/2" – 2" Ladder Rack**  
(page C1.61)



**FLRB – Ladder Rack Bracket**  
(page C1.60)



**FLB – "L" Wall Mount Bracket**  
(page C1.60)



**FZBA1.5X4 – Adjustable "Z" Bracket**  
(page C1.60)



**FZBLP – Low Profile "Z" Bracket**  
(page C1.60)



**1** FCF2X2\*\* and FCF4X4\*\* – Coupler Fitting (see page C1.56)

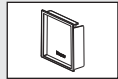

**2** FEC2X2\*\* and FEC4X4\*\* – End Cap Fitting (see page C1.57)

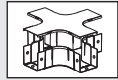

**3** FFWC2X2\*\* and FFWC4X4\*\* – 4-Way Cross Fitting (see page C1.57)

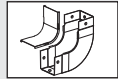

**4** FIVRA2X2\*\* and FIVRA4X4\*\* – Inside Vertical Right Angle (see page C1.57)

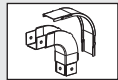

**5** FOVRA2X2\*\* and FOVRA4X4\*\* – Outside Vertical Right Angle (see page C1.57)



**6** FIV452X2\*\* and FIV454X4\*\* – Inside Vertical 45° Angle (see page C1.57)

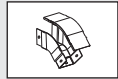

**7** FOV452X2\*\* and FOV454X4\*\* – Outside Vertical 45° Angle (see page C1.57)

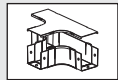

**8** FT2X2\*\* and FT4X4\*\* – Horizontal Tee Fitting (see page C1.57)

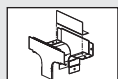

**9** FVT4X4\*\* – 4x4 Vertical Tee (see page C1.58)



**10** FRA2X2\*\* – FRA4X4\*\* – Right Angle Fitting (see page C1.56)



**11** FRF42\*\* – 4x4 to 2x2 Fiber-Duct™ Reducer Fitting (see page C1.57)

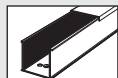

**12** S2X2\*\*6NM and S4X4\*\*6NM Fiber-Duct™ Channel (see page C1.56)



**13** E2X2\*\*6 and E4X4\*\*6 Fiber-Duct™ Slotted Channel (see page C1.56)

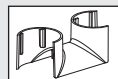

**14** TRC2BL and TRC4BL – Bend Radius Control Trumpet (see page C1.59)

\*\*Available colors include: YL (Yellow), OR (Orange), and BL (Black).

A.  
System  
Overview

B1.  
Cable Ties

B2.  
Cable  
Accessories

B3.  
Stainless  
Steel Ties

C1.  
Wiring  
Duct

C2.  
Surface  
Raceway

C3.  
Abrasion  
Protection

C4.  
Cable  
Management

D1.  
Terminals

D2.  
Power  
Connectors

D3.  
Grounding  
Connectors

E1.  
Labeling  
Systems

E2.  
Labels

E3.  
Pre-Printed  
& Write-On  
Markers

E4.  
Permanent  
Identification

E5.  
Lockout/  
Tagout/  
& Safety  
Solutions

F.  
Index

A. System Overview



## 2x2 and 4x4 Fiber-Duct™ Routing Systems

B1. Cable Ties

- Channel, covers, fittings and other non-metallic system components made from V-0 flame class rated material
- Snap-on non-slip covers
- Compatible with Panduit® FiberRunner® 2x2, 4x4, 6x4 and 12x4 Routing Systems

B2. Cable Accessories

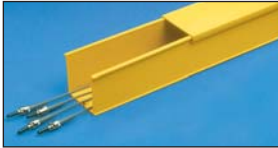

**S2X2**  
**S4X4**

B3. Stainless Steel Ties

C1. Wiring Duct

C2. Surface Raceway



**E2X2**  
**E4X4**

C3. Abrasion Protection

C4. Cable Management



**C2**  
**C4**

D1. Terminals

D2. Power Connectors

D3. Grounding Connectors

E1. Labeling Systems

E2. Labels

E3. Pre-Printed & Write-On Markers

E4. Permanent Identification

E5. Lockout/Tagout & Safety Solutions

F. Index

Part Number	Part Description	System Size	Std. Pkg. Qty.	Std. Ctn. Qty.
<b>Fiber-Duct™ Channel</b>				
<b>S2X2YL6NM</b>	Used to carry the cables throughout the Fiber-Duct™ Routing System. Accepts cover C2YL6. Cover sold separately.	2x2	6	120
<b>S4X4YL6NM</b>	Used to carry the cables throughout the Fiber-Duct™ Routing System. Accepts cover C4YL6. Cover sold separately.	4x4	6	60

Part Number	Part Description	System Size	Std. Pkg. Qty.	Std. Ctn. Qty.
<b>Fiber-Duct™ Slotted Channel</b>				
<b>E2X2YL6</b>	Used to carry the cables vertically to the front or the back of equipment racks throughout the system. Accepts cover C2YL6. Extra supports required when used in horizontal applications. Cover sold separately.	2x2	6	120
<b>E4X4YL6</b>	Used to carry the cables vertically to the front or the back of equipment racks throughout the system. Accepts cover C4YL6. Extra supports required when used in horizontal applications. Cover sold separately.	4x4	6	60

Part Number	Part Description	System Size	Std. Pkg. Qty.	Std. Ctn. Qty.
<b>Fiber-Duct™ Cover</b>				
<b>C2YL6</b>	Cover for Fiber-Duct™ Channel and Fiber-Duct™ Slotted Channel. Non-slip cover design incorporates integral high friction lining to inhibit cover movement.	2x2	6	120
<b>C4YL6</b>	Cover for Fiber-Duct™ Channel and Fiber-Duct™ Slotted Channel. Non-slip cover design incorporates integral high friction lining to inhibit cover movement.	4x4	6	120

Note: Available with mounting holes. To order, delete NM from the part number. For fastest installation use NR2WH-L or NR4BL-L snap rivets. For other colors replace YL (Yellow) with OR (Orange) or BL (Black). Order number of feet required, in multiples of standard 6' length increments.

## Fiber-Duct™ System Fittings



**FCF2X2**  
**FCF4X4**

**FRA2X2**  
**FRA4X4**

Part Number	Part Description	System Size	Std. Pkg. Qty.	Std. Ctn. Qty.
<b>Coupler Fitting</b>				
<b>FCF2X2YL</b>	Used to join two sections of duct together. Fiber-Duct™ Coupler is not required at each fitting connection.	2x2	1	5
<b>FCF4X4YL</b>		4x4	1	5
<b>Horizontal Right Angle Fitting</b>				
<b>FRA2X2YL</b>	Attaches to channel to create a 90° horizontal turn from a straight horizontal run. Cover included.	2x2	1	5
<b>FRA4X4YL</b>		4x4	1	5

For other colors replace suffix YL (Yellow) with OR (Orange) or BL (Black). Fittings include 5/16" assembly holes for fast mechanical fastening.



## Fiber-Duct™ System Fittings (continued)



FT2X2  
FT4X4



FFWC2X2  
FFWC4X4



FEC2X2  
FEC4X4



FIV452X2  
FIV454X4



FOV452X2  
FOV454X4



FIVRA2X2  
FIVRA4X4



FOVRA2X2  
FOVRA4X4



FRF42

Part Number	Part Description	System Size	Std. Pkg. Qty.	Std. Ctn. Qty.
<b>Horizontal Tee Fitting</b>				
<b>FT2X2YL</b>	Attaches to channel to create a 90° horizontal branch from a straight horizontal run. Cover included.	2x2	1	5
<b>FT4X4YL</b>		4x4	1	5
<b>Four Way Cross Fitting</b>				
<b>FFWC2X2YL</b>	Attaches to channel to create a horizontal four way cross intersection. Cover included.	2x2	1	5
<b>FFWC4X4YL</b>		4x4	1	5
<b>End Cap Fitting</b>				
<b>FEC2X2YL</b>	Used for closing off open ends of the channel. No coupler required. Push-on installation.	2x2	1	5
<b>FEC4X4YL</b>		4x4	1	5
<b>Inside Vertical 45° Angle Fitting</b>				
<b>FIV452X2YL</b>	Attaches to channel to create a 45° upward angle from a straight horizontal run. Used with outside vertical 45° angle fitting FOV452X2YL or FOV454X4YL to change level of straight horizontal runs. Cover included.	2x2	1	5
<b>FIV454X4YL</b>		4x4	1	5
<b>Outside Vertical 45° Angle Fitting</b>				
<b>FOV452X2YL</b>	Attaches to channel to create a 45° downward angle from a straight horizontal run. Used with inside vertical 45° angle fitting FIV452X2YL or FIV454X4YL to change level of straight horizontal runs. Cover included.	2x2	1	5
<b>FOV454X4YL</b>		4x4	1	5
<b>Inside Vertical Right Angle Fitting</b>				
<b>FIVRA2X2YL</b>	Attaches to channel to create a 90° upward angle from a straight horizontal run. Used with outside vertical 90° angle fitting FOVRA2X2YL or FOVRA4X4YL to change level of straight horizontal runs. Cover included.	2x2	1	5
<b>FIVRA4X4YL</b>		4x4	1	5
<b>Outside Vertical Right Angle Fitting</b>				
<b>FOVRA2X2YL</b>	Attaches to channel to create a 90° downward angle from a straight horizontal run. Used with inside vertical 90° angle fitting FIVRA2X2YL or FIVRA4X4YL to change level of straight horizontal runs. Cover included.	2x2	1	5
<b>FOVRA4X4YL</b>		4x4	1	5
<b>4x4 to 2x2 Fiber-Duct™ Reducer Fitting</b>				
<b>FRF42YL</b>	Joins any 4x4 Fiber-Duct™ Fitting to the 2x2 Fiber-Duct™ Channel, S2X2YL6 or E2X2YL6. Cover included.	2x2 4x4	1	5

For other colors replace suffix YL (Yellow) with OR (Orange) or BL (Black).  
Fittings include 5/16" assembly holes for fast mechanical fastening.

A.  
System  
Overview

B1.  
Cable Ties

B2.  
Cable  
Accessories

B3.  
Stainless  
Steel Ties

C1.  
Wiring  
Duct

C2.  
Surface  
Raceway

C3.  
Abrasion  
Protection

C4.  
Cable  
Management

D1.  
Terminals

D2.  
Power  
Connectors

D3.  
Grounding  
Connectors

E1.  
Labeling  
Systems

E2.  
Labels

E3.  
Pre-Printed  
& Write-On  
Markers

E4.  
Permanent  
Identification

E5.  
Lockout/  
Tagout  
& Safety  
Solutions

F.  
Index

A. System Overview

## Fiber-Duct™ Spillouts

B1. Cable Ties

B2. Cable Accessories

B3. Stainless Steel Ties

C1. Wiring Duct

C2. Surface Raceway

C3. Abrasion Protection

C4. Cable Management

D1. Terminals

D2. Power Connectors

D3. Grounding Connectors

E1. Labeling Systems

E2. Labels

E3. Pre-Printed & Write-On Markers

E4. Permanent Identification

E5. Lockout/Tagout & Safety Solutions

F. Index



FVTHD2X2



FTR2X2



FIDT2X2



FVT4X4



FTR4X4



FIDT4X4BL

Part Number	Part Description	System Size	Std. Pkg. Qty.	Std. Ctn. Qty.
<b>2x2 Vertical Tee</b>				
<b>FVTHD2X2YL</b>	Attaches to 2x2 channel to create a 90° vertical drop from a horizontal run. Hinged door included. Accepts channel cover in conjunction with channel. Use QuikLock™ Coupler FBC2X2YL with HS2X2YL6 or H2X2YL6 channels. Use snap rivets NR2WH-L or bolts F14PN-L with S2X2YL6 or E2X2YL6 channels. Also accepts FIDT2X2YL.	2x2	1	5
<b>3-Sided BRC Trumpet Spillout for 2x2 Exit</b>				
<b>FTR2X2YL</b>	Used to limit the bend radius of the cable to 2" (50.8mm) when exiting from a spill-over junction with a 2x2 exit or from 2x2 Fiber-Duct™ Channel.	2x2	1	5
<b>1-Port Spillout to 1.5" (38mm) Inside Diameter Corrugated Tubing</b>				
<b>FIDT2X2YL</b>	Used to route cable into one piece of 1.5" (38mm) diameter split corrugated tubing. Used with a spill-over junction with a 2x2 exit, 2x2 Fiber-Duct™ Fittings, and the 2x2 FiberRunner® Hinged Channel. Securely holds split corrugated tubing to ensure system integrity and easy access to add or remove cables.	2x2	1	5
<b>4x4 Vertical Tee</b>				
<b>FVT4X4YL</b>	Attaches to channel to create a 90° vertical drop from a horizontal run. Accepts FIDT4X4BL, FTR4X4YL, S4X4YL6 or E4X4YL6 directly.	4x4	1	5
<b>3-Sided Vertical Tee Trumpet Spillout</b>				
<b>FTR4X4YL</b>	Used to limit the bend radius of the cable to 2" (50.8mm) when exiting from a 4x4 or 6x4 FiberRunner® Vertical Tee and 4x4 Fiber-Duct™ Fittings.	4x4	1	5
<b>2-Port Spillout to 1.5" (38mm) Inside Diameter Corrugated Tubing</b>				
<b>FIDT4X4BL</b>	Used to route cable into one or two pieces of 1.5" (38mm) diameter split corrugated tubing. Used with FRVT6X4YL, FRVT4X4YL, or FVT4X4YL. Securely holds corrugated split tubing to ensure system integrity and easy access to add or remove cables. Black color only.	4x4	1	5

## Fiber-Duct™ Bend Radius Control Trumpets

- Provide method to transition cabling into rack system
- Maintain 1 inch (25.4mm) bend radius control



TRC2BL

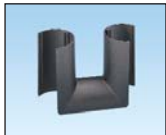

TRC4BL

Part Number	Part Description	System Size	Std. Pkg. Qty.	Std. Ctn. Qty.
TRC2BL	Bend radius control trumpet for exiting at the sidewall of 2" wall heights of type G, FS, E, or S Fiber-Duct™ Channels.	2x2	1	10
TRC4BL	Bend radius control trumpet for exiting at the sidewall of 4" wall heights of type G, FS, E, or S Fiber-Duct™ Channels.	4x4	1	10

## Fiber-Duct™ Accessories



NR2WH-L  
NR4BL-L



F14PWN-L



F14PN-L

Part Number	Part Description	System Size	Std. Pkg. Qty.	Std. Ctn. Qty.
<b>Snap Rivets</b>				
NR2WH-L	Snap rivet fastens channel and fittings together for added strength and rigidity. Snap rivet mounts flush to surfaces.	2x2	50	500
NR4BL-L		4x4	50	500
<b>Plastic Bolts and Nuts</b>				
F14PWN-L	1/4" plastic bolts and wing nuts fastens channel and fittings together for added strength and rigidity.	2x2 4x4	50	500
<b>Plastic Bolts and Nuts</b>				
F14PN-L	1/4" plastic bolts and hex nuts fastens channel and fittings together for added strength and rigidity.	2x2 4x4	50	500

A.  
System  
Overview

B1.  
Cable Ties

B2.  
Cable  
Accessories

B3.  
Stainless  
Steel Ties

C1.  
Wiring  
Duct

C2.  
Surface  
Raceway

C3.  
Abrasion  
Protection

C4.  
Cable  
Management

D1.  
Terminals

D2.  
Power  
Connectors

D3.  
Grounding  
Connectors

E1.  
Labeling  
Systems

E2.  
Labels

E3.  
Pre-Printed  
& Write-On  
Markers

E4.  
Permanent  
Identification

E5.  
Lockout/  
Tagout  
& Safety  
Solutions

F.  
Index

A.  
System  
Overview

## Fiber-Duct™ Mounting Brackets

B1.  
Cable Ties



**FTRBE12, FTRBE58  
FTRBE12M**

B2.  
Cable  
Accessories

B3.  
Stainless  
Steel Ties

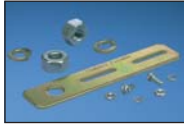

**FTRBN12, FTRBN58  
FTRBN12M**

C1.  
Wiring  
Duct

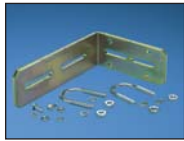

**FUSB**

C2.  
Surface  
Raceway



**FLRB**

C3.  
Abrasion  
Protection

C4.  
Cable  
Management

D1.  
Terminals

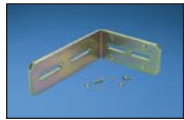

**FLB**

D2.  
Power  
Connectors



**FZBA1.5X4**

D3.  
Grounding  
Connectors

E1.  
Labeling  
Systems



**FZBLP**

E2.  
Labels

E3.  
Pre-Printed  
& Write-On  
Markers

E4.  
Permanent  
Identification

E5.  
Lockout/  
Tagout  
& Safety  
Solutions

F.  
Index

Part Number	Part Description	For Threaded Rod Size	Std. Pkg. Qty.	Std. Ctn. Qty.
<b>Existing Threaded Rod Bracket for Fiber-Duct™ System</b>				
<b>FTRBE12</b>	Used for supporting the 2x2 and 4x4 Fiber-Duct™ Systems from existing threaded rod installations.	1/2"	1	10
<b>FTRBE58</b>	Bracket is secured to threaded rod with two split nuts. Contains hardware for attaching to threaded rods and hardware for mounting channel to bracket.	5/8"	1	10
<b>FTRBE12M</b>		12mm	1	10
<b>New Threaded Rod Bracket for Fiber-Duct™ System</b>				
<b>FTRBN12</b>	Used for supporting the 2x2 and 4x4 Fiber-Duct™ Systems from new threaded rod installations. Bracket is secured to threaded rod with two nuts. Contains hardware for attaching to threaded rods and hardware for mounting channel to bracket.	1/2"	1	10
<b>FTRBN58</b>		5/8"	1	10
<b>FTRBN12M</b>		12mm	1	10
<b>Underfloor Pedestal Bracket for Fiber-Duct™ System</b>				
<b>FUSB</b>	Used to support the 2x2 and 4x4 Fiber-Duct™ Systems by attaching to underfloor pedestal (not included). Use on pedestals up to 1" in diameter. Bracket contains hardware to attach to pedestal and hardware for mounting channel to bracket.	—	1	10
<b>Ladder Rack Bracket for Fiber-Duct™ System</b>				
<b>FLRB</b>	Used to support the 2x2 and 4x4 Fiber-Duct™ Systems attaching directly to any 3/8" (9.5mm) x 1 1/2" (38.1mm) or 3/8" (9.5mm) x 2" (50.8mm) ladder rack rail. No threaded rod required. Contains hardware for mounting channel to bracket.	—	1	10
<b>"L" Wall Mount Bracket for Fiber-Duct™ System</b>				
<b>FLB</b>	Used to support 2x2 and 4x4 Fiber-Duct™ Systems by attaching to a wall or the front or back of an equipment rack. Contains hardware for mounting channel to bracket.	—	1	10
<b>Adjustable "Z" Bracket</b>				
<b>FZBA1.5X4</b>	Bracket used to offset Fiber-Duct™ System from mounting surface, adjustable from 1.5" (38mm) to 4" (101mm). Typically used on the front of an equipment rack.	—	1	10
<b>Low Profile "Z" Bracket</b>				
<b>FZBLP</b>	Bracket used to offset 2x2 or 4x4 Fiber-Duct™ System and hinged duct from the front face of an equipment rack. Bracket provides a secure mounting surface .67" (17mm) from the front of an equipment rack.	—	1	10

## Fiber-Duct™ Mounting Brackets (continued)



F2PCLB12  
F2PCLB58



FRAF58

Part Number	Part Description	For Threaded Rod Size	Std. Pkg. Qty.	Std. Ctn. Qty.
<b>Two-Piece Ladder Rack Bracket for Attaching Threaded Rod to 1 1/2" – 2" Ladder Rack</b>				
<b>F2PCLB12</b>	Two-piece bracket attaches to 3/8" (9.5mm) wide x 1 1/2" (38.1mm) or 3/8" (9.5mm) wide x 2" (50.8mm) ladder rack rail. Bracket halves slide into position and clamp together on the ladder rack rail, which allows for a one-handed assembly of the threaded rod (not included). Contains bracket and hardware for attaching bracket to ladder rack.	1/2"	1	10
<b>F2PCLB58</b>		5/8"	1	10
<b>Two-Piece Framing Clip for Attaching 5/8" Threaded Rod to 2" x 9/16" C-Channel Auxiliary Framing Bars</b>				
<b>FRAF58</b>	Two-piece framing clip attaches to auxiliary framing bars. Framing clip halves slide into position and interlock on the auxiliary framing bars, allowing easier assembly of the threaded rod to bars. Contains two-piece framing clip and hardware for attaching framing clip to auxiliary framing bars. (5/8" threaded rod not included.)	5/8"	1	10

A.  
System  
Overview

B1.  
Cable Ties

B2.  
Cable  
Accessories

B3.  
Stainless  
Steel Ties

C1.  
Wiring  
Duct

C2.  
Surface  
Raceway

C3.  
Abrasion  
Protection

C4.  
Cable  
Management

D1.  
Terminals

D2.  
Power  
Connectors

D3.  
Grounding  
Connectors

E1.  
Labeling  
Systems

E2.  
Labels

E3.  
Pre-Printed  
& Write-On  
Markers

E4.  
Permanent  
Identification

E5.  
Lockout/  
Tagout  
& Safety  
Solutions

F.  
Index

A. System Overview



## 2x2 and 4x4 Fiber-Duct™ Routing Systems

B1. Cable Ties

### Cable Fills for 2x2 and 4x4 Fiber-Duct™ Cable Routing Systems

The maximum amounts may vary according to the cable fill installation methods, straightness of cables, etc.

B2. Cable Accessories

B3. Stainless Steel Ties

2x2 Fiber-Duct™ Cable Routing System							
Fill/Pile Up	Internal Area In. <sup>2</sup>	Diameter 1.6mm .063"	Diameter 2.0mm .079"	Diameter 3.0mm .118"	Fiber Optic Flat Ribbon Interconnect Cable 5.20mm .205"	Category 6A Diameter 7.57mm .298"	Cat. 6 Diameter 6.35mm .250"
<b>40% Fill</b>							
2" Pile Up	3.5	449	288	128	42	20	29
<b>50% Fill</b>							
2" Pile Up	3.5	562	359	160	53	25	36
<b>60% Fill</b>							
2" Pile Up	3.5	674	431	192	64	30	43

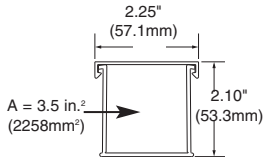

**Channel cutting instructions:** For optimum results, use a miter box and saw. For larger quantities use a plastic cutting saw blade for clean, burr-free cuts. Recommend: Carbide 80T and 100T; .090" thickness, .125" kerf.

C2. Surface Raceway

C3. Abrasion Protection

C4. Cable Management

4x4 Fiber-Duct™ Cable Routing System							
Fill/Pile Up	Internal Area In. <sup>2</sup>	Diameter 1.6mm .063"	Diameter 2.0mm .079"	Diameter 3.0mm .118"	Fiber Optic Flat Ribbon Interconnect Cable 5.20mm .205"	Category 6A Diameter 7.57mm .298"	Cat. 6 Diameter 6.35mm .250"
<b>40% Fill</b>							
2" Pile Up	7.6	976	624	277	92	44	62
3" Pile Up	11.3	1450	928	413	137	65	92
4" Pile Up	14.6	1874	1199	533	177	84	119
<b>50% Fill</b>							
2" Pile Up	7.6	1219	780	347	115	54	77
3" Pile Up	11.3	1813	1160	516	171	81	115
4" Pile Up	14.6	2343	1499	666	221	105	149
<b>60% Fill</b>							
2" Pile Up	7.6	1463	936	416	138	65	93
3" Pile Up	11.3	2176	1392	619	205	97	138
4" Pile Up	14.6	2811	1799	800	265	126	178

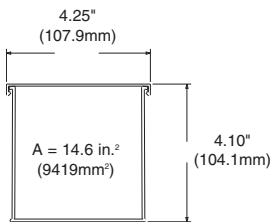

**Channel cutting instructions:** For optimum results, use a miter box and saw. For larger quantities use a plastic cutting saw blade for clean, burr-free cuts. Recommend: Carbide 80T and 100T; .090" thickness, .125" kerf.

D1. Terminals

D2. Power Connectors

D3. Grounding Connectors

E1. Labeling Systems

E2. Labels

E3. Pre-Printed & Write-On Markers

E4. Permanent Identification

E5. Lockout/Tagout & Safety Solutions

F. Index

### PAN-WAY® METAL RACEWAY

Pan-Way® Metal Raceway is a series of single and multi-channel solutions for routing, protecting, concealing and terminating power wire and high performance copper, voice, video or fiber optic cable. Panduit metal raceway is designed with labor saving features to increase productivity and lower installed costs, while incorporating benefits of increased safety and cable protection. Pan-Way® Metal Raceway is an innovative routing solution that offers superior benefits over competitive systems:

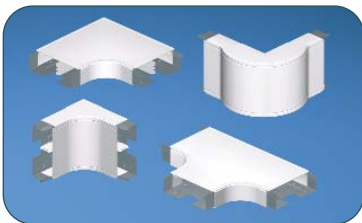

Pan-Way® Metal Raceway systems include a complete assortment of fittings, junction boxes, faceplates and accessories. They are available in white and almond color to match any decor and most popular electrical outlets. Systems are optimized for use with Panduit® Mini-Com® Modules for complete connectivity possibilities.

#### PMR5 and PMR7 Single Channel Metal Raceway

- Raceway system features a patent pending bonding design that provides full continuity of the ground path between fittings and channel, for increased electrical safety
- System components incorporate an innovative snap-mount assembly method for fast installations, resulting in measurable contractor labor savings
- Fittings and mounts can be attached using various types and sizes of fasteners, eliminating the requirements of using only flat head style screws
- One-piece channel construction eliminates the problem of channel separation, associated with competitive two-piece designs, saving installation time

#### PMR40 Multi-Channel Metal Raceway

- Raceway accepts standard double gang faceplates for increased termination options and reduced number of components
- System includes optional faceplates and fittings to support high performance Category 6A copper and fiber optic cabling terminations
- Full capacity 2 inch bend radius fittings provide necessary cable protection without restricting channel capacity

A.  
System  
Overview

B1.  
Cable Ties

B2.  
Cable  
Accessories

B3.  
Stainless  
Steel Ties

C1.  
Wiring  
Duct

C2.  
Surface  
Raceway

C3.  
Abrasion  
Protection

C4.  
Cable  
Management

D1.  
Terminals

D2.  
Power  
Connectors

D3.  
Grounding  
Connectors

E1.  
Labeling  
Systems

E2.  
Labels

E3.  
Pre-Printed  
& Write-On  
Markers

E4.  
Permanent  
Identification

E5.  
Lockout/  
Tagout  
& Safety  
Solutions

F.  
Index

A.  
System  
Overview

## PMR40 Raceway Roadmap

B1.  
Cable Ties

B2.  
Cable  
Accessories

B3.  
Stainless  
Steel Ties

C1.  
Wiring  
Duct

C2.  
Surface  
Raceway

C3.  
Abrasion  
Protection

C4.  
Cable  
Management

D1.  
Terminals

D2.  
Power  
Connectors

D3.  
Grounding  
Connectors

E1.  
Labeling  
Systems

E2.  
Labels

E3.  
Pre-Printed  
& Write-On  
Markers

E4.  
Permanent  
Identification

E5.  
Lockout/  
Tagout  
& Safety  
Solutions

F.  
Index

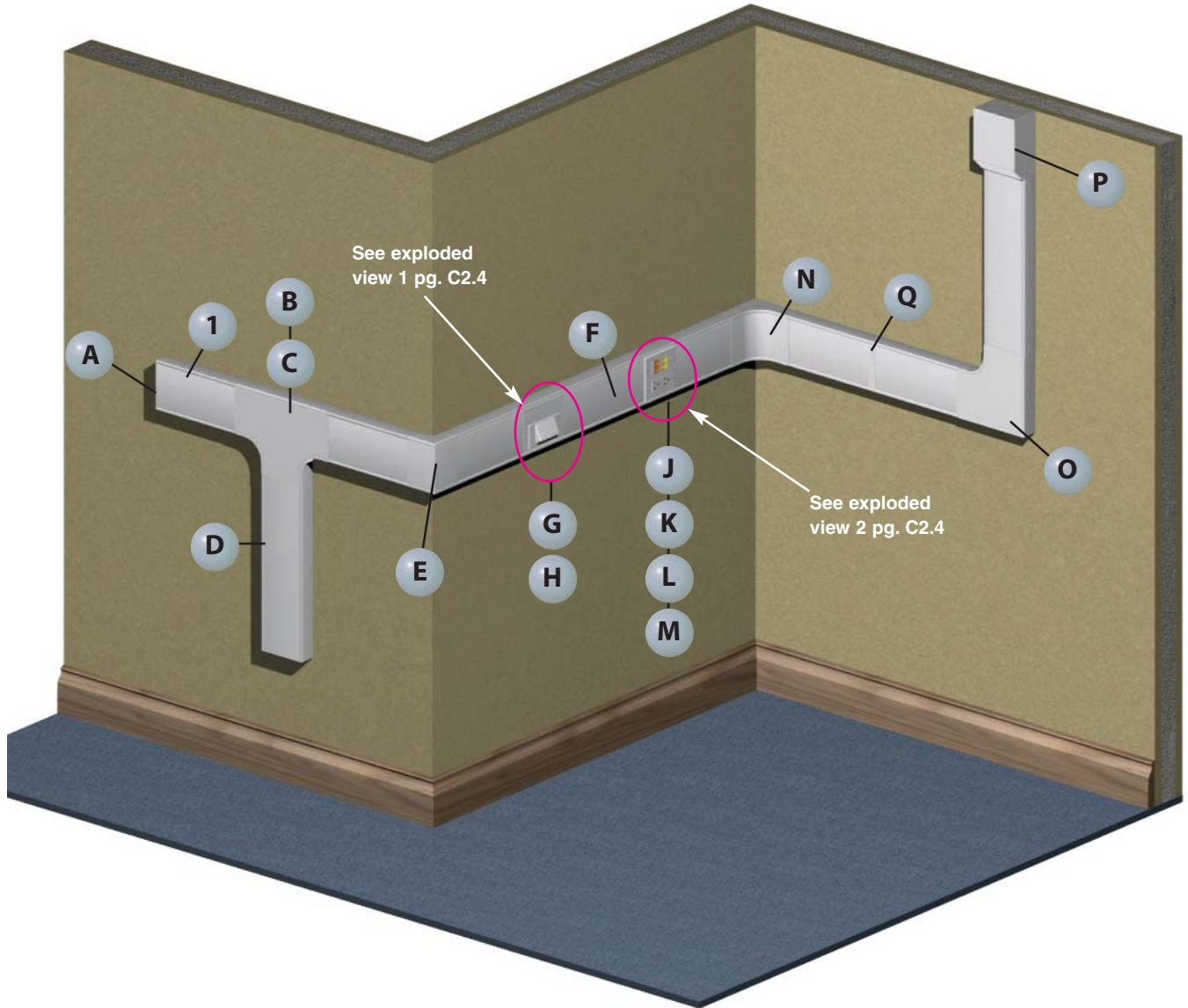





**1** PMR40\*\* – PMR40 Metal Raceway (page C2.5)

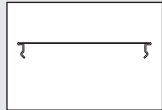

**1** PMR40C\*\* – PMR40 Cover (page C2.5)

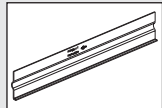

**1** PMR40DW\* – PMR40 Divider Wall (page C2.5)



**1** PMR40DC-X – PMR40 Divider Clip (page C2.5)



**A** PMR40EC\*\* – End Cap (page C2.6)



**B** PMR40T\*\* – Tee Fitting (page C2.6)



**C** PMR40TD50 – Tee Divider Insert (page C2.6)



**D** PMR40BF\*\* – Backfeed Fitting (page C2.6)



**E** PMR40SOC\*\* – Outside Corner (no bend radius) (page C2.6)



**F** PMR40C\*\*7.5 – Pre-Cut Cover for mounting devices on 12" centers (page C2.5)



**G** PMR40FH4\*\* – Horizontal Sloped Communication Faceplate (page C2.6)



**H** PMR40DP50\*\* – PMR40 50/50 Data Plate (page C2.6)



**J** MP2GR\*\* – Double Gang Rectangular Faceplate (page C2.17)

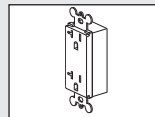

**K** ERU20\*\* – 20 A Specification Grade Rectangular Outlet (page C2.61)



**L** CFG4 – Mini-Com® Frame (see SA-NCCB51)



**M** PMR40DB50 – Device Bracket (page C2.6)



**N** PMR40IC\*\* – Inside Corner (page C2.6)



**O** PMR40RA\*\* – Right Angle (page C2.5)

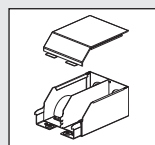

**P** PMR40EE\*\* – Entrance End (page C2.6)



**Q** PMR40SC\*\*-X – Seam Clip (page C2.5)

A. System Overview

B1. Cable Ties

B2. Cable Accessories

B3. Stainless Steel Ties

C1. Wiring Duct

C2. Surface Raceway

C3. Abrasion Protection

C4. Cable Management

D1. Terminals

D2. Power Connectors

D3. Grounding Connectors

E1. Labeling Systems

E2. Labels

E3. Pre-Printed & Write-On Markers

E4. Permanent Identification

E5. Lockout/Tagout & Safety Solutions

F. Index

A.  
System  
Overview

## PMR40 Configurations

B1.  
Cable Ties

### Exploded View 1

	Components Required	See page
A.	PMR40FH4 = Horizontal sloped communication faceplate.	C2.6
B.	PMR40DP50** = PMR40 50/50 data plate and offset divider wall.	C2.6
C.	Mini-Com® Modules.	—

B2.  
Cable  
Accessories

B3.  
Stainless  
Steel Ties

C1.  
Wiring  
Duct

C2.  
Surface  
Raceway

C3.  
Abrasion  
Protection

C4.  
Cable  
Management

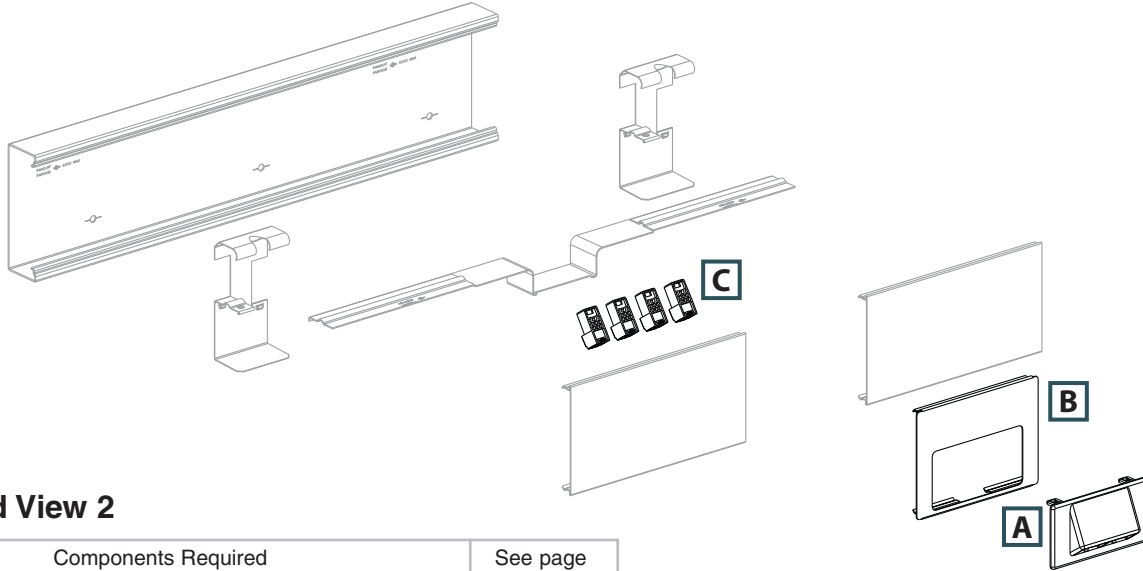

D1.  
Terminals

### Exploded View 2

	Components Required	See page
A.	MP2GR** = Double gang rectangular faceplate.	C2.17
B.	ERU20** = 20 V specification grade rectangular outlet.	C2.61
C.	CFG4 = Mini-Com® Frame.	—
D.	Mini-Com® Modules.	—
E.	PMR40DB50 = Device bracket.	C2.6

D2.  
Power  
Connectors

D3.  
Grounding  
Connectors

E1.  
Labeling  
Systems

E2.  
Labels

E3.  
Pre-Printed  
& Write-On  
Markers

E4.  
Permanent  
Identification

E5.  
Lockout/  
Tagout  
& Safety  
Solutions

F.  
Index

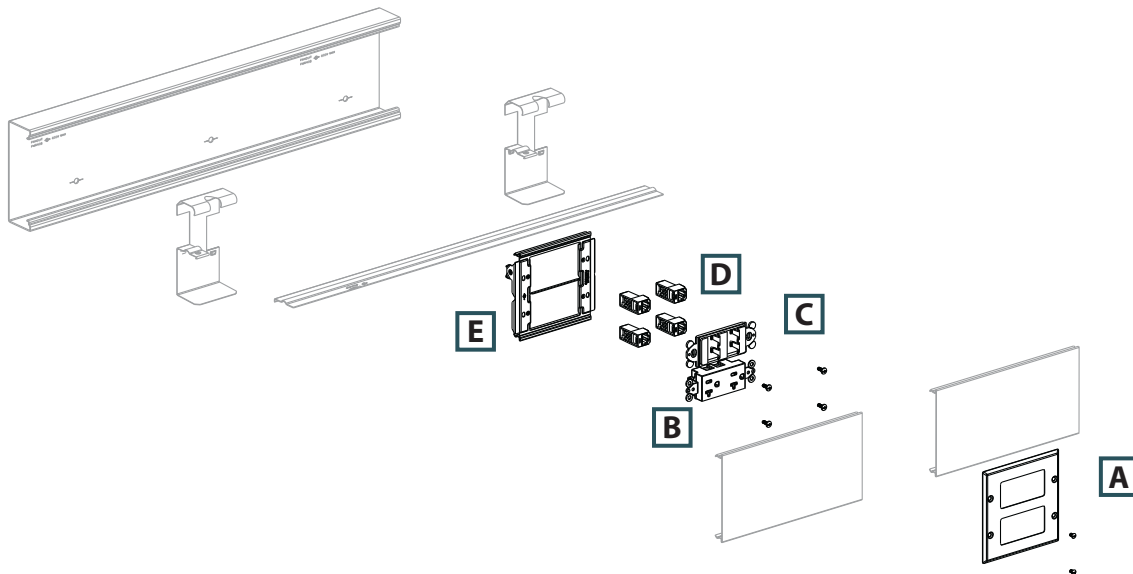

## Pan-Way® PMR40 Metal Raceway System

- c-UL-us listed and rated to 600 V; meets UL 5 and CSA22.2 No. 62-93 safety standards
- Raceway accepts standard double gang faceplates for increased termination options and reduced number of components
- System includes optional faceplates and fittings to support high performance Category 6A copper and fiber optic cabling terminations

- Full capacity 2 inch bend radius fittings provide necessary cable protection without restricting channel capacity
- Supplied with pre-punched mounting holes

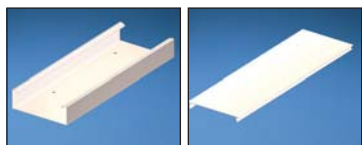
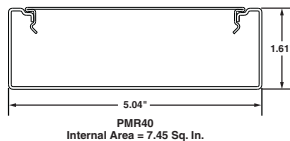

PMR40B

PMR40C

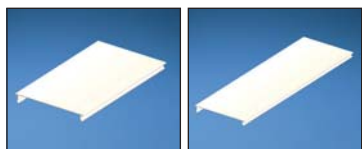

PMR40C\*\*\*

PMR40C\*\*\*

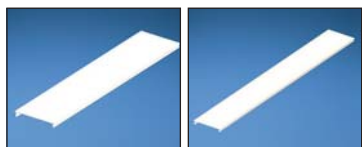

PMR40C\*\*\*

PMR40C\*\*\*



PMR40DW5

PMR40DC

Part Number	Part Description	Raceway Size	Color‡	Length Ft.	Std. Pkg. Qty.
<b>PMR40 Metal Raceway Base</b>					
<b>PMR40BWH10</b>	PMR40 raceway base available in 10' lengths. Supplied with pre-punched mounting holes.	5.04" x 1.61" (128.0mm x 40.9mm)	White	10	10
<b>PMR40 Metal Raceway Cover</b>					
<b>PMR40CWH5</b>	PMR40 raceway cover available in 5' lengths.	—	White	5	5
<b>PMR40 Metal Raceway Pre-cut Covers</b>					
<b>PMR40CWH7.75</b>	7.75" pre-cut cover. To be used with PMR40 raceway for mounting devices on 12" centers.	—	White	—	1
<b>PMR40CWH13.75</b>	13.75" pre-cut cover. To be used with PMR40 raceway for mounting devices on 18" centers.	—	White	—	1
<b>PMR40CWH19.75</b>	19.75" pre-cut cover. To be used with PMR40 raceway for mounting devices on 24" centers.	—	White	—	1
<b>PMR40CWH31.75</b>	31.75" pre-cut cover. To be used with PMR40 raceway for mounting devices on 36" centers.	—	White	—	1
<b>PMR40 Metal Raceway Divider Wall</b>					
<b>PMR40DW5</b>	PMR40 divider wall snaps into PMR40DC-X to create separate channels. Must use wire retainers to ensure channel separation per UL/CSA. Available in 5' lengths.	—	Gray	5	5
<b>PMR40 Metal Raceway Divider Wall Clip</b>					
<b>PMR40DC-X</b>	Divider wall clip. Required for supporting PMR40DW. 30" spacing recommended between clips.	—	Gray	—	10

‡For other colors replace WH (White) with AL (Almond). Order number of feet required in multiples of standard carton quantity. Order raceway base and cover separately.

## Pan-Way® PMR40 Metal Raceway Fittings

- PMR40 fittings are designed to exceed the TIA/EIA-568-B and 569-B required minimum bend radius for high performance copper and fiber optic cabling systems

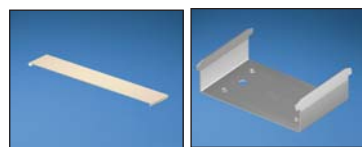

PMR40SCWH-X

PMR40BC



PMR40RA

PMR40SIC

Part Number	Part Description	Color‡	Std. Pkg. Qty.	Std. Ctn. Qty.
<b>PMR40SCWH-X</b>	Seam clip. Used to join sections of PMR40 raceway.	White	10	100
<b>PMR40BC</b>	Base coupler. Used to join sections of PMR40 raceway base.	Gray	10	100
<b>PMR40RAWH</b>	Right angle fitting. Used to join sections of PMR40 raceway at right angles.	White	1	10
<b>PMR40SIC</b>	Inside corner fitting w/out bend radius control. Used to join sections of PMR40 raceway at inside corners.	Gray	1	10

‡For other colors replace WH (White) with AL (Almond).

Table continues on page C2.6

A. System Overview

B1. Cable Ties

B2. Cable Accessories

B3. Stainless Steel Ties

C1. Wiring Duct

C2. Surface Raceway

C3. Abrasion Protection

C4. Cable Management

D1. Terminals

D2. Power Connectors

D3. Grounding Connectors

E1. Labeling Systems

E2. Labels

E3. Pre-Printed & Write-On Markers

E4. Permanent Identification

E5. Lockout/ Tagout & Safety Solutions

F. Index

A. System Overview

 **Pan-Way® PMR40 Metal Raceway Fittings (continued)**

B1. Cable Ties



**PMR40IC**



**PMR40I45E**

B2. Cable Accessories



**PMR40SOC**

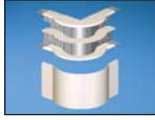

**PMR40OC**

B3. Stainless Steel Ties

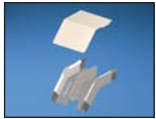

**PMR40E45E**

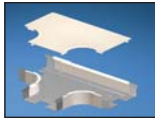

**PMR40T**

C1. Wiring Duct



**PMR40TD50**



**PMR40EC**

C2. Surface Raceway



**PMR40EE**



**PMR40TR**

C3. Abrasion Protection



**PMR40BF**



**PMR40PC**

D1. Terminals

D2. Power Connectors

D3. Grounding Connectors

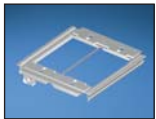

**PMR40DB50**

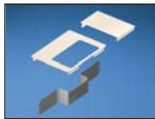

**PMR40DP50**

E1. Labeling Systems

E2. Labels

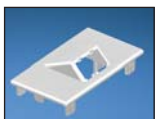

**PMR40FH2**

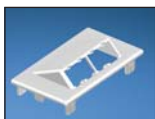

**PMR40FH4**

E3. Pre-Printed & Write-On Markers



**PMR40KH2**



**PMR40KH4**

E4. Permanent Identification



**RBFIWH**

E5. Lockout/Tagout & Safety Solutions

F. Index

Part Number	Part Description	Color‡	Std. Pkg. Qty.	Std. Ctn. Qty.
<b>PMR40ICWH</b>	Inside corner fitting. Used to join sections of PMR40 raceway at inside corners.	White	1	10
<b>PMR40I45EWH</b>	Internal 45° elbow fitting. Used to join sections of PMR40 raceway at 45° inside corners.	White	1	10
<b>PMR40SOCWH</b>	Outside corner fitting without bend radius control. Used to join sections of PMR40 raceway at outside corners.	White	1	10
<b>PMR40OCWH</b>	Outside corner fitting. Used to join sections of PMR40 raceway at outside corners.	White	1	10
<b>PMR40E45EWH</b>	External 45° elbow fitting. Used to join sections of PMR40 raceway at 45° outside corners.	White	1	10
<b>PMR40TWH</b>	Tee fitting. Used to join sections of PMR40 raceway at tee intersections.	White	1	10
<b>PMR40TD50</b>	Tee divider insert for a 50/50 data/power split. Maintains a 50/50 channel separation for power and data applications.	Gray	1	10
<b>PMR40ECWH</b>	End cap fitting. Used to terminate or allow entry into PMR40 raceway. Breakouts for 1/2" conduit.	White	1	10
<b>PMR40EEWH</b>	Entrance end fitting. Breakouts for 3/4", 1", and 1 1/4" conduit which allows entry from ceiling or wall.	White	1	10
<b>PMR40TRWH</b>	WIREMOLD* to PMR40 transition fitting. In-line transition fitting from WIREMOLD* 4000 series to PMR40 raceway.	White	1	10
<b>PMR40BFWH</b>	Backfeed fitting. Allows cable entry through the back of the PMR40 raceway. Two round breakouts for 1/2", 3/4" and 1" conduit, two round breakouts for 3/4", 1", and 1 1/4" conduit and two 1 11/16" X 2 9/16" rectangular breakouts.	White	1	10
<b>PMR40PCWH</b>	Panel connector. To connect PMR40 raceway with surface type panel boxes.	White	1	10
<b>PMR40ICC</b>	Internal corner coupling.	Gray	1	10
<b>PMR40WR-X</b>	Wire retainer. Used to hold wires in place during installation.	Gray	10	100
<b>PMR40DB50</b>	Device mounting bracket 50/50 split. Used to mount NEMA standard single gang electrical outlets and communication devices with either screw-on or snap-on single gang faceplates.	Gray	1	10
<b>PMR40DP50WH</b>	PMR40 data plate for mounting data faceplates PMR40FH2, PMR40FH4, PMR40KH2 or PMR40KH4 when a 50/50 split channel is used in the PMR40 base. Includes data plate, 2.50" pre-cut cover, and offset divider wall.	White	1	10
<b>PMR40FH2WH</b>	Snap-on horizontal sloped communication faceplate. Accepts two Panduit® Mini-Com® Modules (not included). Note: Customer needs to purchase PMR40DP50WH.	White	1	10
<b>PMR40FH4WH</b>	Snap-on horizontal sloped communication faceplate. Accepts four Panduit® Mini-Com® Modules (not included). Note: Customer needs to purchase PMR40DP50WH.	White	1	10
<b>PMR40KH2WH</b>	Snap-on horizontal sloped communication faceplate. Accepts two Keystone modules (not included). Note: Customer needs to purchase PMR40DP50WH.	White	1	10
<b>PMR40KH4WH</b>	Snap-on horizontal sloped communication faceplate. Accepts four Keystone modules (not included). Note: Customer needs to purchase PMR40DP50WH.	White	1	10
<b>RBFIWH</b>	Rectangular blank faceplate. Snap-in insert for any NEMA standard rectangular opening in metal raceway faceplates. Reserves the location for future use.	White	1	10

‡For other colors replace WH (White) with AL (Almond).

\*WIREMOLD is a registered trademark of the Wiremold Co.

## Cable Fill Capacities for PMR40 Metal Raceway

This information is to be used as a guide in selecting the proper size raceway. The maximum amounts may vary according to the cable installation methods, straightness of cables, etc.



**A = 7.45 in.<sup>2</sup>**

**Cable fill #1:** Open channel without devices



**A = 6.18 in.<sup>2</sup>**

**Cable fill #2:** Undivided, wire retainer only



**A = 2.64 in.<sup>2</sup>**

**B = 3.04 in.<sup>2</sup>**

**Cable fill #3:** Divided with wire retainer

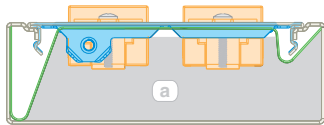

**A = 4.64 in.<sup>2</sup>**

**Cable fill #4:** Undivided with duplex receptacle on two sides

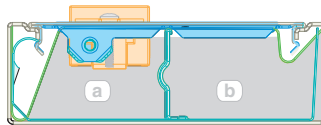

**A = 1.87 in.<sup>2</sup>**

**B = 2.84 in.<sup>2</sup>**

**Cable fill #5:** Divided with duplex receptacle on (A) side

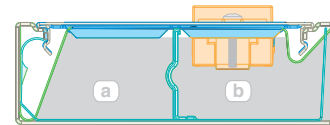

**A = 2.49 in.<sup>2</sup>**

**B = 2.21 in.<sup>2</sup>**

**Cable fill #6:** Divided with duplex receptacle on (B) side

**SPEC = 40% cable fill** – Recommended by TIA/EIA-569-B for design.

**MAX for 60% cable fill** – Recommended by TIA/EIA-569-B for unplanned additions.

**MAX for 40% power cable fill** – Based on available internal area.

Raceway Type and Configuration	Fill Area (in <sup>2</sup> )	Electrical Cables			Data Grade Cables		Data Grade Cables		Audio/Video	
		14 AWG	12 AWG	10 AWG	24 AWG/UTP CM		24 AWG/UTP CM		RG6	
		THHN/T90			Cat. 6		Cat. 6A			
		0.111	0.130	0.164	DIA. = 0.250		DIA. = 0.330		DIA. = 0.275	
		FILL			FILL		FILL		FILL	
		MAX 40%	MAX 40%	MAX 40%	SPEC 40%	MAX 60%	SPEC 40%	MAX 60%	SPEC 40%	MAX 60%
1. PMR40 - Undivided (base and cover)	7.45	307	224	140	60	91	34	52	50	75
2. PMR40 - Undivided, wire retainer only	6.18	255	186	117	50	75	28	43	41	62
3a. PMR40 - Divided, with wire retainer	2.64	109	79	50	21	32	12	18	17	26
	3b. PMR40 - Divided, with wire retainer	3.04	125	91	57	24	37	14	21	30
4. PMR40 - Undivided with duplex receptacle 2 sides	4.64	191	139	87	—	—	—	—	—	—
5a. PMR40 - Divided with duplex receptacle on (A) side	1.87	78	57	36	—	—	—	—	—	—
	5b. PMR40 - Divided with duplex receptacle on (A) side	2.84	—	—	—	23	34	13	19	19
6a. PMR40 - Divided with duplex receptacle on (B) side	2.49	—	—	—	20	30	11	17	16	25
	6b. PMR40 - Divided with duplex receptacle on (B) side	2.21	91	66	41	—	—	—	—	—

AWG dimensions represent typical outer cable diameter in inches.

- A. System Overview
- B1. Cable Ties
- B2. Cable Accessories
- B3. Stainless Steel Ties
- C1. Wiring Duct
- C2. Surface Raceway
- C3. Abrasion Protection
- C4. Cable Management
- D1. Terminals
- D2. Power Connectors
- D3. Grounding Connectors
- E1. Labeling Systems
- E2. Labels
- E3. Pre-Printed & Write-On Markers
- E4. Permanent Identification
- E5. Lockout/Tagout & Safety Solutions
- F. Index

A.  
System  
Overview

## PMR5/7 Raceway Roadmap

B1.  
Cable Ties

B2.  
Cable  
Accessories

B3.  
Stainless  
Steel Ties

C1.  
Wiring  
Duct

C2.  
Surface  
Raceway

C3.  
Abrasion  
Protection

C4.  
Cable  
Management

D1.  
Terminals

D2.  
Power  
Connectors

D3.  
Grounding  
Connectors

E1.  
Labeling  
Systems

E2.  
Labels

E3.  
Pre-Printed  
& Write-On  
Markers

E4.  
Permanent  
Identification

E5.  
Lockout/  
Tagout  
& Safety  
Solutions

F.  
Index

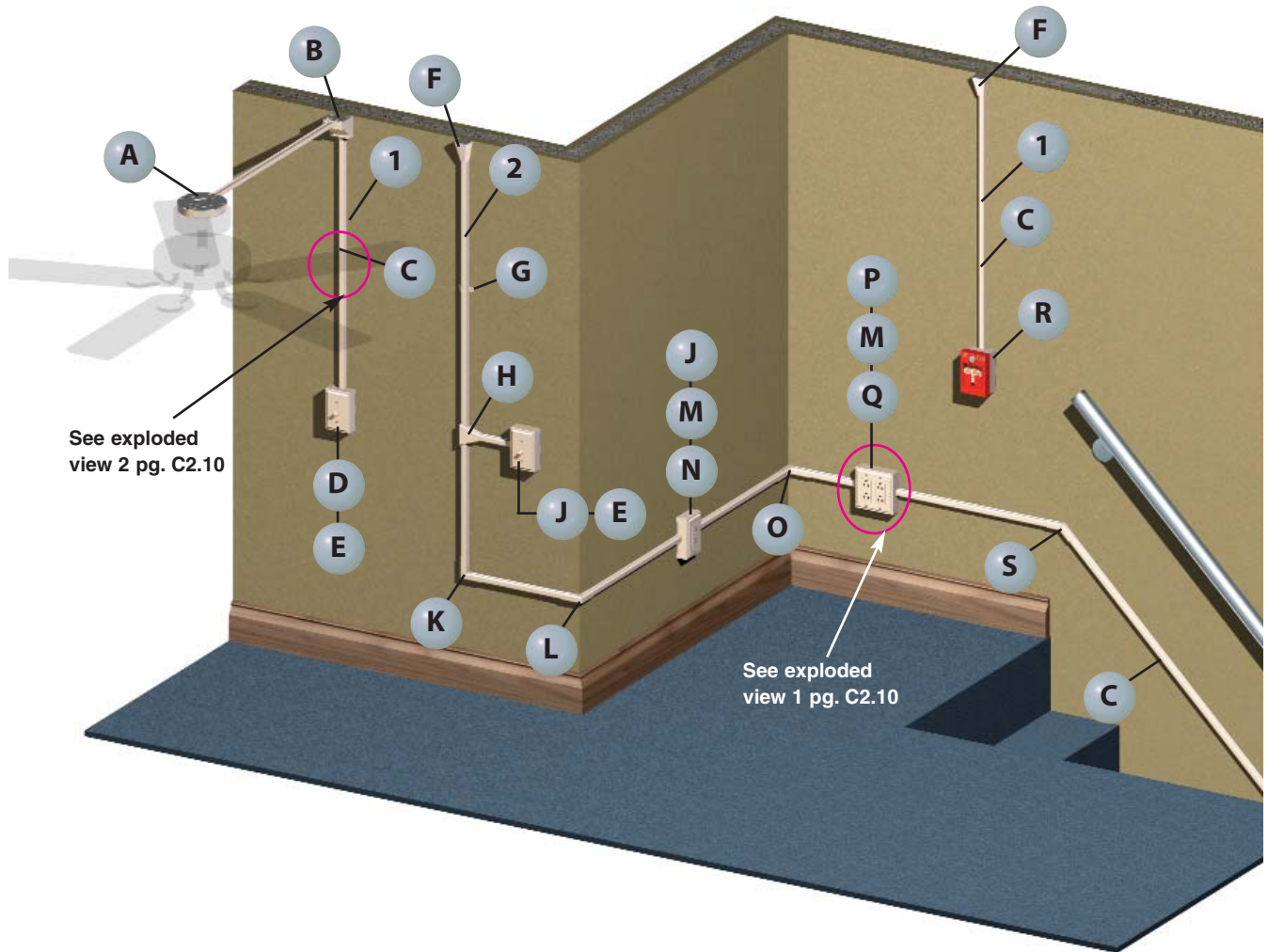

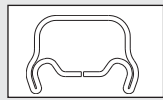

**1** PMR5\*\* – PMR5 Metal Raceway (page C2.11)

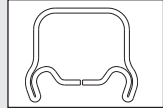

**2** PMR7\*\* – PMR7 Metal Raceway (page C2.11)



**A** PMR5738A\*\* – Round Fan/Fixture Box (page C2.16)

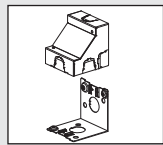

**B** PMR57CB\*\* – Corner Box (page C2.12)

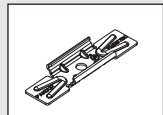

**C** PMR57SC-X – Supporting Clip (page C2.11)

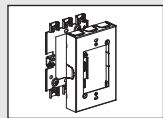

**D** PMR5751\*\* – Single Gang Extension Box (page C2.15)

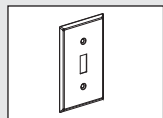

**E** MP1TS\*\* – Single Gang Toggle Switch Faceplate (page C2.17)

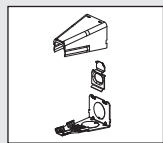

**F** PMR57EE\*\* – Entrance End Fitting (page C2.12)

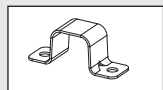

**G** PMR7MS\*\* – Mounting Strap (page C2.11)

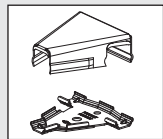

**H** PMR57T\*\* – Tee Fitting (page C2.12)

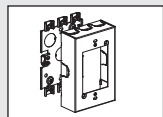

**J** PMR5747\*\* – Single Gang Shallow Outlet Box (page C2.15)

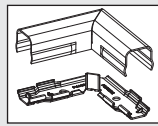

**K** PMR7RA\*\* – Right Angle Fitting (page C2.12)

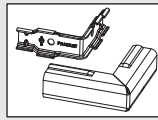

**L** PMR7OC\*\* – Outside Corner Fitting (page C2.12)

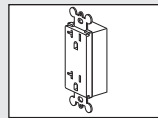

**M** ERU20\*\* – 20 A Specification Grade Rectangular Outlet (page C2.61)

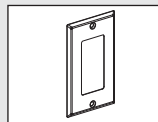

**N** MP1GR\*\* – Single Gang Rectangular Faceplate (page C2.17)

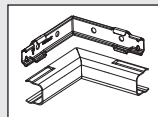

**O** PMR7IC\*\* – Inside Corner Fitting (page C2.12)

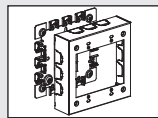

**P** PMR5747-2\*\* – Double Gang Shallow Outlet Box (page C2.15)

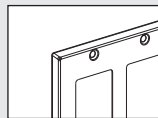

**Q** MP2GR\*\* – Double Gang Rectangular Faceplate (page C2.17)

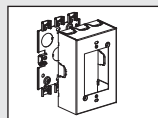

**R** PMR5748\*\* – Single Gang Outlet Box (page C2.15)

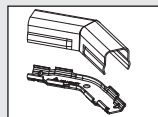

**S** PMR7DA\*\* – Diagonal 45° Angle Fitting (page C2.12)

A. System Overview

B1. Cable Ties

B2. Cable Accessories

B3. Stainless Steel Ties

C1. Wiring Duct

C2. Surface Raceway

C3. Abrasion Protection

C4. Cable Management

D1. Terminals

D2. Power Connectors

D3. Grounding Connectors

E1. Labeling Systems

E2. Labels

E3. Pre-Printed & Write-On Markers

E4. Permanent Identification

E5. Lockout/Tagout & Safety Solutions

F. Index

A.  
System  
Overview

## PMR5/PMR7 Configurations

B1.  
Cable Ties

### Exploded View 1

	Components Required	See page
A.	MP2GR = Double gang rectangular faceplate.	C2.17
B.	ERU20 = 20 A Specification rectangular outlet.	C2.61
C.	PMR5747-2 = Double gang deep outlet box.	C2.15

B2.  
Cable  
Accessories

B3.  
Stainless  
Steel Ties

C1.  
Wiring  
Duct

C2.  
Surface  
Raceway

C3.  
Abrasion  
Protection

C4.  
Cable  
Management

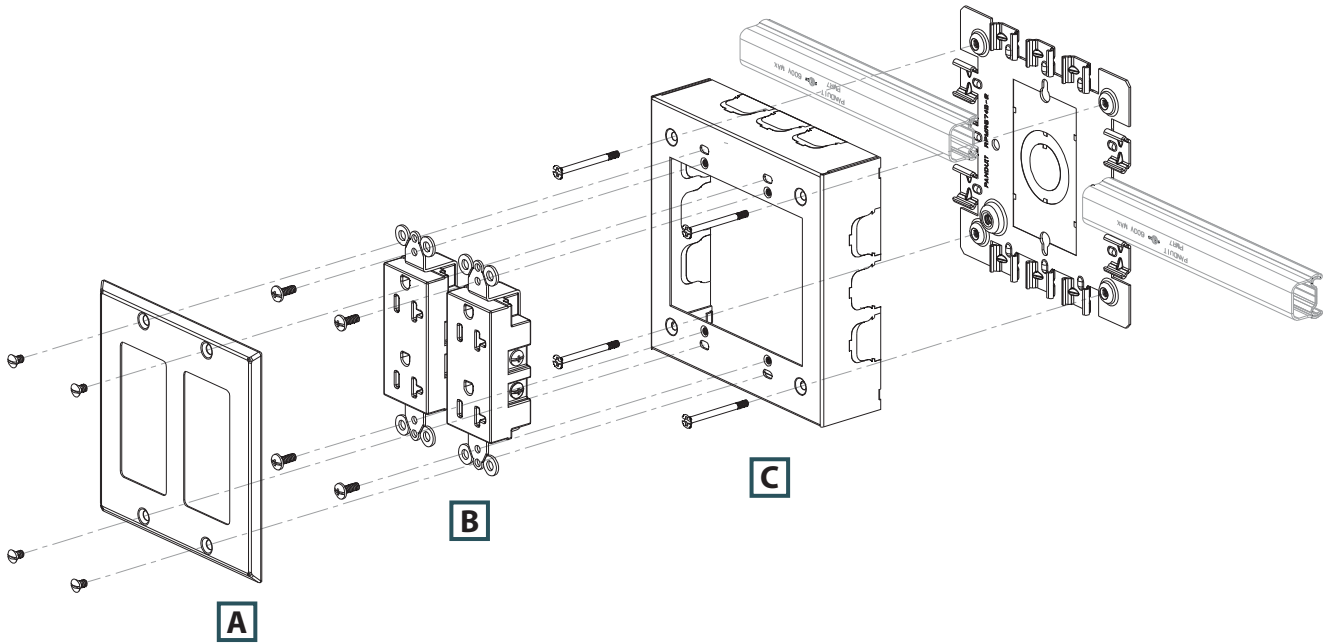

D1.  
Terminals

D2.  
Power  
Connectors

### Exploded View 2

	Components Required	See page
A.	PMR57SC-X = Supporting clip.	C2.11
B.	PMR7*** = PMR7 metal raceway.	C2.11

D3.  
Grounding  
Connectors

E1.  
Labeling  
Systems

E2.  
Labels

E3.  
Pre-Printed  
& Write-On  
Markers

E4.  
Permanent  
Identification

E5.  
Lockout/  
Tagout  
& Safety  
Solutions

F.  
Index

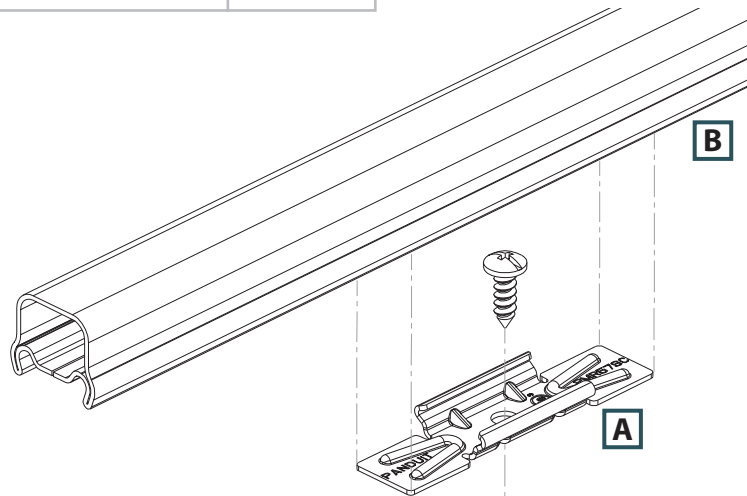



## c-UL-us Pan-Way® PMR5/PMR7 Metal Raceway System

- c-UL-us listed and rated to 600 V; meets UL 5 and CSA22.2 No. 62-93 safety standards
- Raceway system features a patent pending bonding design that provides full continuity of the ground path between fittings and channel, for increased electrical safety
- System components incorporate a unique snap mount assembly method for faster installation

- Fittings and mounts can be attached using various types and sizes of fasteners, eliminating the requirements of using only flat head style screws
- One-piece channel construction eliminates the problem of channel separation, associated with competitive two-piece designs, saving installation time

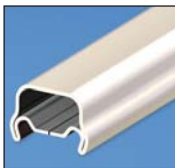
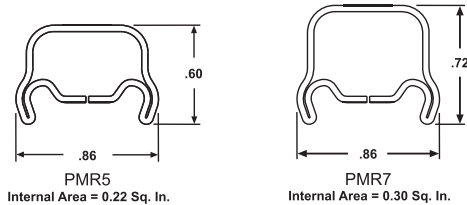

PMR5

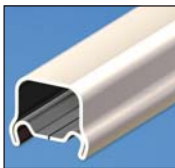

PMR7



PMR57SC

PMR57JC

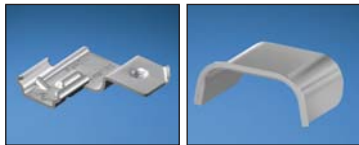

PMR57GC

PMR5WPB  
PMR7WPB



PMR5MS  
PMR7MS

Part Number	Part Description	Raceway Size	Color‡	Length (Ft.)	Std. Pkg. Qty.	Std. Ctn. Qty.
<b>PMR5 Metal Raceway</b>						
<b>PMR5WH5</b>	One-piece single channel metal surface raceway. Available in 5' lengths.	0.86" x 0.60" (21.8mm x 15.2mm)	White	5	5	50
<b>PMR5WH10</b>	One-piece single channel metal surface raceway. Available in 10' lengths.	0.86" x 0.60" (21.8mm x 15.2mm)	White	10	10	100
<b>PMR7 Metal Raceway</b>						
<b>PMR7WH5</b>	One-piece single channel metal surface raceway. Available in 5' lengths.	0.86" x 0.72" (21.8mm x 18.3mm)	White	5	5	50
<b>PMR7WH10</b>	One-piece single channel metal surface raceway. Available in 10' lengths.	0.86" x 0.72" (21.8mm x 18.3mm)	White	10	10	100
<b>PMR7 Metal Raceway</b>						
<b>PMR57SC-X</b>	Supporting clip used to support lengths of PMR5 or PMR7 raceway at any desired point.	—	Gray	—	10	100
<b>PMR7 Metal Raceway</b>						
<b>PMR57JC-X</b>	Joint coupling used to join two lengths of PMR5 or PMR7 raceway.	—	Gray	—	10	100
<b>PMR7 Metal Raceway</b>						
<b>PMR57GC-X</b>	Ground clip used to provide additional grounding of raceway or to ground remote installations. For use with PMR5 or PMR7 raceway.	—	Gray	—	10	100
<b>Supporting Clip</b>						
<b>PMR5WPB-X</b>	Bushing used to protect wires from abrasion. For use with PMR5 raceway.	—	Gray	—	10	100
<b>PMR7WPB-X</b>	Bushing used to protect wires from abrasion. For use with PMR7 raceway.	—	Gray	—	10	100
<b>PMR7 Metal Raceway</b>						
<b>PMR5MSWH-X</b>	Mounting strap for use with PMR5 raceway.	—	White	—	10	100
<b>PMR7MSWH-X</b>	Mounting strap for use with PMR7 raceway.	—	White	—	10	100

‡For other colors replace WH (White) with AL (Almond).

A.  
System  
Overview

B1.  
Cable  
Ties

B2.  
Cable  
Accessories

B3.  
Stainless  
Steel Ties

C1.  
Wiring  
Duct

C2.  
Surface  
Raceway

C3.  
Abrasion  
Protection

C4.  
Cable  
Management

D1.  
Terminals

D2.  
Power  
Connectors

D3.  
Grounding  
Connectors

E1.  
Labeling  
Systems

E2.  
Labels

E3.  
Pre-Printed  
& Write-On  
Markers

E4.  
Permanent  
Identification

E5.  
Lockout/  
Tagout  
& Safety  
Solutions

F.  
Index



## Pan-Way® PMR5/PMR7 Metal Raceway Fittings

A. System Overview

B1. Cable Ties

B2. Cable Accessories

B3. Stainless Steel Ties

C1. Wiring Duct

C2. Surface Raceway

C3. Abrasion Protection

C4. Cable Management

D1. Terminals

D2. Power Connectors

D3. Grounding Connectors

E1. Labeling Systems

E2. Labels

E3. Pre-Printed & Write-On Markers

E4. Permanent Identification

E5. Lockout/Tagout & Safety Solutions

F. Index

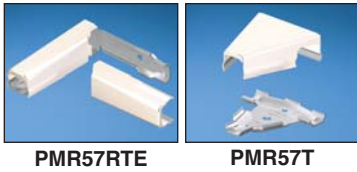
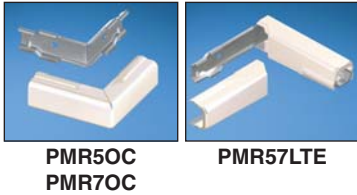
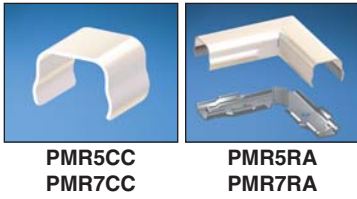

Part Number	Part Description	Color‡	Std. Pkg. Qty.	Std. Ctn. Qty.
<b>PMR5CCWH-X</b>	Coupler fitting for use with PMR5 raceway.	White	10	100
<b>PMR7CCWH-X</b>	Coupler fitting for use with PMR7 raceway.	White	10	100
<b>PMR5RAWH</b>	Right angle fitting for use with PMR5 raceway.	White	1	10
<b>PMR7RAWH</b>	Right angle fitting for use with PMR7 raceway.	White	1	10
<b>PMR5DAWH</b>	Diagonal 45° angle fitting for use with PMR5 raceway.	White	1	10
<b>PMR7DAWH</b>	Diagonal 45° angle fitting for use with PMR7 raceway.	White	1	10
<b>PMR5ICWH</b>	Inside corner fitting for use with PMR5 raceway.	White	1	10
<b>PMR7ICWH</b>	Inside corner fitting for use with PMR7 raceway.	White	1	10
<b>PMR5OCWH</b>	Outside corner fitting for use with PMR5 raceway.	White	1	10
<b>PMR7OCWH</b>	Outside corner fitting for use with PMR7 raceway.	White	1	10
<b>PMR57LTEWH</b>	Left twisted elbow for 90° twist with 90° turn. For double turn at right angles from one surface to another, such as a flat run on a sidewall to a flat run on a ceiling. For use with PMR5 and PMR7 raceway.	White	1	10
<b>PMR57RTEWH</b>	Right twisted elbow for 90° twist with 90° turn. For double turn at right angles from one surface to another, such as a flat run on a sidewall to a flat run on a ceiling. For use with PMR5 and PMR7 raceway.	White	1	10
<b>PMR57TWH</b>	Tee fitting for use with PMR5 or PMR7 raceway.	White	1	10
<b>PMR57EEWH</b>	Entrance end fitting. 1/2" conduit breakouts allows entry of PMR5 or PMR7 raceway from a box, the ceiling, or a wall. Spring steel bushing included for use when connecting to a box.	White	1	10
<b>PMR57AOCWH</b>	Adjustable offset allows PMR5 or PMR7 to be mounted flush to wall when connected to surface type panel boxes. Adjustable between 5/8" and 1 3/8" from surface to center of conduit. 1/2" chase nipple and locknut included.	White	1	10
<b>PMR57CBWH</b>	Corner box for connecting PMR5 or PMR7 raceway. Each leg has 1/2" conduit breakouts and room for splicing.	White	1	10
<b>PMR57TRWH</b>	WIREMOLD* to PMR5 transition fitting. In-line transition fitting from WIREMOLD* 500 series to PMR5 raceway.	White	1	10
<b>PMR77TRWH</b>	WIREMOLD* to PMR7 Transition fitting. In-line transition fitting from WIREMOLD* 700 series to PMR7 raceway.	White	1	10
<b>PMR57EBCWH</b>	Elbow box connector used to connect PMR5 or PMR7 raceway to boxes at a right angle. Breakouts for 1/2" conduit.	White	1	10
<b>PMR57ECCWH</b>	Elbow conduit connector used to connect PMR5 or PMR7 raceway to conduit at a right angle. Breakouts for 1/2" conduit.	White	1	10
<b>PMR57JBC50-X</b>	Junction box connector used to connect PMR5 or PMR7 raceway to boxes with 1/2" conduit breakout.	White	10	100
<b>PMR57JBC75-X</b>	Junction box connector used to connect PMR5 or PMR7 raceway to boxes with 3/4" conduit breakout.	White	10	100
<b>PMR57CC50-X</b>	Conduit connector used to connect PMR5 or PMR7 raceway to 1/2" conduit.	White	10	100
<b>PMR57CC75-X</b>	Conduit connector used to connect PMR5 or PMR7 raceway to 3/4" conduit.	White	10	100

‡For other colors replace WH (White) with AL (Almond).

\*WIREMOLD is a registered trademark of the Wiremold Co.

**cUL<sup>us</sup> PMR5 and PMR7 Raceway Accessories**

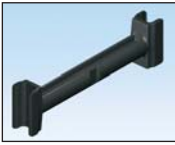

**PMR57MRT**



**PMRTUP\*\***

Part Number	Part Description	Color	Std. Pkg. Qty.	Std. Ctn. Qty.
<b>PMR57MRT</b>	Metal raceway tool. To aid in the installation and removal of PMR5 and PMR7 metal raceway base sections.	Black	1	10
<b>PMRTUPAL</b>	Touch-up paint pen. Used to repair areas of metal raceway where paint has been removed or damaged.	—	1	10
<b>PMRTUPWH</b>	Touch-up paint pen. Used to repair areas of metal raceway where paint has been removed or damaged.	—	1	10

A. System Overview

B1. Cable Ties

B2. Cable Accessories

B3. Stainless Steel Ties

C1. Wiring Duct

C2. Surface Raceway

C3. Abrasion Protection

C4. Cable Management

D1. Terminals

D2. Power Connectors

D3. Grounding Connectors

E1. Labeling Systems

E2. Labels

E3. Pre-Printed & Write-On Markers

E4. Permanent Identification

E5. Lockout/Tagout & Safety Solutions

F. Index

A. System Overview

## Cable Fill Capacities for PMR5/PMR7 Metal Raceway

B1. Cable Ties

This information is to be used as a guide in selecting the proper size raceway. The maximum amounts may vary according to the cable installation methods, straightness of cables, etc.

B2. Cable Accessories

B3. Stainless Steel Ties

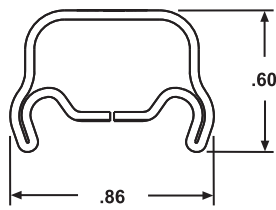

PMR5

$$A = .22 \text{ in.}^2$$



PMR7

$$A = .30 \text{ in.}^2$$

C1. Wiring Duct

C2. Surface Raceway

C3. Abrasion Protection

C4. Cable Management

**SPEC = 40% cable fill** – The recommended design in cable capacity, leaves room for future moves, adds, and changes.

**MAX for Data = 60% cable fill** – The maximum cable quantity based on cable interweaving and packing factors.

D1. Terminals

D2. Power Connectors

D3. Grounding Connectors

Raceway Type and Configuration	Fill Area (In. <sup>2</sup> )	Electrical Cables			Data Grade Cables		Data Grade Cables		Audio/Video		Fiber Optic Cable	
		14 AWG	12 AWG	10 AWG	24 AWG/UTP CM	24 AWG/UTP CM	RG6		2 Strand			
		THHN/T90			Category 6		Category 6A		Dia. = 0.275		Dia. = 0.175	
		0.111	0.130	0.164	Dia. = 0.250		Dia. = 0.330		FILL		FILL	
		MAX	MAX	MAX	SPEC	MAX	SPEC	MAX	SPEC	MAX	SPEC	MAX
PMR5	0.22	9	6	4	1	2	1	1	1	2	3	5
PMR7	0.30	12	8	5	2	3	1	2	2	3	4	7

AWG dimensions represent typical outer cable diameter in inches.

E1. Labeling Systems

E2. Labels

E3. Pre-Printed & Write-On Markers

E4. Permanent Identification

E5. Lockout/Tagout & Safety Solutions

F. Index

**UL<sup>us</sup> Pan-Way® Metal Raceway Boxes**



PMR5760

PMR5751



PMR5751-2

PMR5751-3

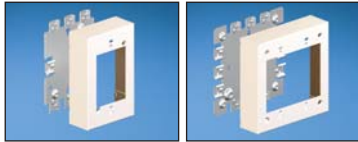

PMR5747

PMR5747-2

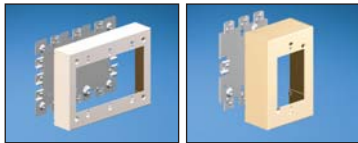

PMR5747-3

PMR5748

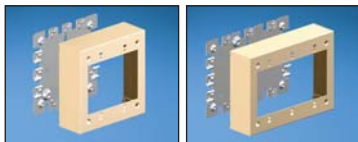

PMR5748-2

PMR5748-3

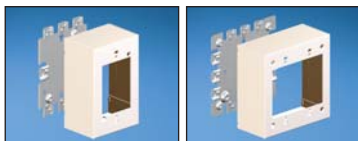

PMR5744S

PMR5744S-2

Part Number	Part Description	Color‡	Std. Pkg. Qty.	Std. Ctn. Qty.
PMR5760WH	Single gang blank extension box. For use with Pan-Way® PMR5 or PMR7 Raceway. 4.92"L x 3.17"W x 0.94"H (125.0mm x 80.5mm x 23.8mm)	White	1	10
PMR5751WH	Single gang extension box. Box accepts Pan-Way® Faceplates or any NEMA standard single gang faceplate. For use with Pan-Way® PMR5 or PMR7 Raceway. 4.92"L x 3.17"W x .94"H (125.0mm x 80.5mm x 23.8mm)	White	1	10
PMR5751-2WH	Double gang extension box. Box accepts Pan-Way® Faceplates or any standard double gang faceplate. For use with Pan-Way® PMR5 or PMR7 Raceway. 4.92"L x 4.92"W x .94"H (125.0mm x 125.0mm x 23.8mm)	White	1	10
PMR5751-3WH	Three gang extension box. Box accepts Pan-Way® Faceplates or any standard three gang faceplate. For use with Pan-Way® PMR5 or PMR7 Raceway. 4.92"L x 6.72"W x .94"H (125.0mm x 170.7mm x 23.8mm)	White	1	10
PMR5747WH	Single gang shallow outlet box. Box accepts Pan-Way® Faceplates or any NEMA standard single gang faceplate. For use with Pan-Way® PMR5 or PMR7 Raceway. Breakouts for 1/2" conduit. 4.92"L x 3.17"W x 1.38"H (125.0mm x 80.5mm x 34.9mm)	White	1	10
PMR5747-2WH	Double gang shallow outlet box. Box accepts Pan-Way® Faceplates or any standard double gang faceplate. For use with Pan-Way® PMR5 or PMR7 Raceway. Breakouts for 1/2" and 1" conduit. 4.92"L x 4.92"W x 1.38"H (125.0mm x 125.0mm x 34.9mm)	White	1	10
PMR5747-3WH	Three gang shallow outlet box. Box accepts Pan-Way® Faceplates or any standard three gang faceplate. For use with Pan-Way® PMR5 or PMR7 Raceway. Breakouts for 1/2" conduit. 4.92"L x 6.72"W x 1.38"H (125.0mm x 170.7mm x 34.9mm)	White	1	10
PMR5748WH	Single gang outlet box. Box accepts Pan-Way® Faceplates or any NEMA standard single gang faceplate. For use with Pan-Way® PMR5 or PMR7 Raceway. Breakouts for 1/2" conduit. 4.92"L x 3.17"W x 1.75"H (125.0mm x 80.5mm x 44.5mm)	White	1	10
PMR5748-2WH	Double gang outlet box. Box accepts Pan-Way® Faceplates or any standard double gang faceplate. For use with Pan-Way® PMR5 or PMR7 Raceway. Breakouts for 1/2" and 1" conduit. 4.92"L x 4.92"W x 1.75"H (125.0mm x 125.0mm x 44.5mm)	White	1	10
PMR5748-3WH	Three gang outlet box. Box accepts Pan-Way® Faceplates or any standard three gang faceplate. For use with Pan-Way® PMR5 or PMR7 Raceway. Breakouts for 1/2" conduit. 4.92"L x 6.72"W x 1.75"H (125.0mm x 170.7mm x 44.5mm)	White	1	10
PMR5744SWH	Single gang intermediate outlet box. Box accepts Pan-Way® Faceplates or any NEMA standard single gang faceplate. For use with Pan-Way® PMR5 or PMR7 Raceway. Breakouts for 1/2" conduit. 4.92"L x 3.17"W x 2.25"H (125.0mm x 80.5mm x 57.2mm)	White	1	10
PMR5744S-2WH	Double gang intermediate outlet box. Box accepts Pan-Way® Faceplates or any standard double gang faceplate. For use with Pan-Way® PMR5 or PMR7 Raceway. Breakouts for 1/2" and 1" conduit. 4.92"L x 4.92"W x 2.25"H (125.0mm x 125.0mm x 57.2mm)	White	1	10

‡For other colors replace WH (White) with AL (Almond).

Table continues on page C2.16

A. System Overview

B1. Cable Ties

B2. Cable Accessories

B3. Stainless Steel Ties

C1. Wiring Duct

C2. Surface Raceway

C3. Abrasion Protection

C4. Cable Management

D1. Terminals

D2. Power Connectors

D3. Grounding Connectors

E1. Labeling Systems

E2. Labels

E3. Pre-Printed & Write-On Markers

E4. Permanent Identification

E5. Lockout/Tagout & Safety Solutions

F. Index

A. System Overview

**cUL<sub>us</sub> Pan-Way® Metal Raceway Boxes (continued)**

B1. Cable Ties

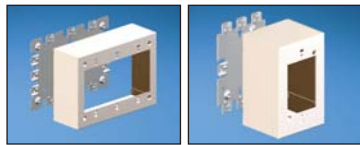

PMR5744S-3

PMR5744

B2. Cable Accessories

B3. Stainless Steel Ties

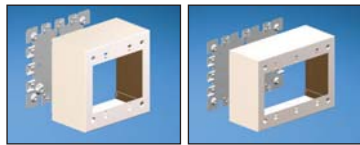

PMR5744-2

PMR5744-3

C1. Wiring Duct

C2. Surface Raceway



PMR5738

PMR5738A

C3. Abrasion Protection

C4. Cable Management



PMR5739

PMR5737

D1. Terminals

D2. Power Connectors



PMR5737A

PMR5739A

D3. Grounding Connectors

E1. Labeling Systems

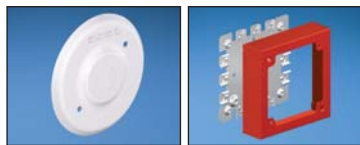

PMR5736

PMR5752

E2. Labels

E3. Pre-Printed & Write-On Markers



PMR5753

E4. Permanent Identification

E5. Lockout/Tagout & Safety Solutions

F. Index

Part Number	Part Description	Color‡	Std. Pkg. Qty.	Std. Ctn. Qty.
PMR5744S-3WH	Three gang intermediate outlet box. Box accepts Pan-Way® Faceplates or any standard three gang faceplate. For use with Pan-Way® PMR5 or PMR7 Raceway. Breakouts for 1/2" conduit. 4.92"L x 6.72"W x 2.25"H (125.0mm x 170.7mm x 57.2mm)	White	1	10
PMR5744WH	Single gang deep outlet box. Box accepts Pan-Way® Faceplates or any NEMA standard single gang faceplate. For use with Pan-Way® PMR5 or PMR7 Raceway. Breakouts for 1/2" conduit. 4.92"L x 3.17"W x 2.75"H (125.0mm x 80.5mm x 69.9mm)	White	1	10
PMR5744-2WH	Double gang deep outlet box. Box accepts Pan-Way® Faceplates or any standard double gang faceplate. For use with Pan-Way® PMR5 or PMR7 Raceway. Breakouts for 1/2" and 1" conduit. 4.92"L x 4.92"W x 2.75"H (125.0mm x 80.5mm x 69.9mm)	White	1	10
PMR5744-3WH	Three gang deep outlet box. Box accepts Pan-Way® Faceplates or any standard three gang faceplate. For use with Pan-Way® PMR5 or PMR7 Raceway. Breakouts for 1/2" conduit. 4.92"L x 6.72"W x 2.75"H (125.0mm x 170.7mm x 69.9mm)	White	1	10
PMR5738WH	Round fixture box with solid base is c-UL-us rated to accept devices up to 50 lbs. For use with Pan-Way® PMR5 or PMR7 Raceway. Base has four 1/2" conduit breakouts. Dia.= 4.77"D x 1.00"H (121.2mm x 25.4mm)	White	1	10
PMR5738AWH	Round fan or fixture box with solid base is c-UL-us rated to accept devices up to 50 lbs. For use with Pan-Way® PMR5 or PMR7 Raceway. Base has four 1/2" conduit breakouts. Dia. = 5.53"D x 1.00"H (140.5mm x 25.4mm)	White	1	10
PMR5739WH	Round fixture box with solid base is c-UL-us rated to accept devices up to 50 lbs. For use with Pan-Way® PMR5 or PMR7 Raceway. Base has four 1/2" conduit breakouts. Dia. = 6.37"D x 1.00"H (161.8mm x 25.4mm)	White	1	10
PMR5737WH	Round extension box with open base is c-UL-us rated to accept devices up to 50 lbs. For use with Pan-Way® PMR5 or PMR7 Raceway. Dia. = 4.76"D x 1.00"H (121.0mm x 25.4mm)	White	1	10
PMR5737AWH	Round extension box with open base is c-UL-us rated to accept devices up to 50 lbs. For use with Pan-Way® PMR5 or PMR7 Raceway. Dia. = 5.53"D x 1.00"H (140.5mm x 25.4mm)	White	1	10
PMR5739AWH	Round extension box with open base is c-UL-us rated to accept devices up to 50 lbs. For use with Pan-Way® PMR5 or PMR7 Raceway. Dia. = 6.37"D x 1.00"H (161.8mm x 25.4mm)	White	1	10
PMR5736WH	Round Blank Faceplate for use with Pan-Way PMR5 or PMR7 Round Outlet Boxes: PMR5737, PMR5737A, PMR5738, PMR5738A, PMR5739 and PMR5739A. Knockout for 1/2" conduit. Dia. = 4.25"D x 0.45"H (108.0mm x 11.5mm).	White	1	50
PMR5752RD	Alarm device box. Box accepts alarm devices and safety signals designed to fit 4" square back boxes. For use with Pan-Way® PMR5 or PMR7 Raceway. Breakouts for 1/2" and 1" conduit. 4.92"L x 4.92"W x 1.42" H (125.0mm x 125.0mm x 36.1mm) <b>Available in red only.</b>	Red	1	10
PMR5753RD	Deep alarm device box. Box accepts alarm devices and safety signals designed to fit 4" square back boxes. For use with Pan-Way® PMR5 or PMR7 Raceway. Breakouts for 1/2" and 1" conduit. 4.92"L x 4.92"W x 2.80"H (125.0mm x 125.0mm x 71.0mm) <b>Available in red only.</b>	Red	1	10

‡For other colors replace WH (White) with AL (Almond).



## SB® Pan-Way® Metal Raceway Faceplates

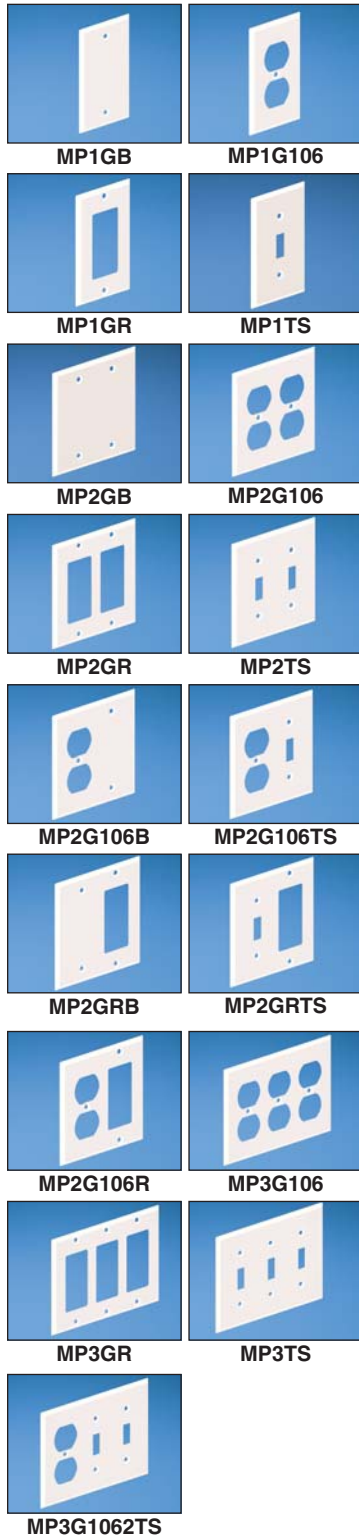

Part Number	Part Description	Color‡	Std. Pkg. Qty.	Std. Ctn. Qty.
MP1GBWH	Metal single gang blank faceplate.	White	1	10
MP1G106WH	Metal single gang 106 duplex faceplate. Covers one NEMA standard 106 duplex electrical outlet or one standard 106 communication module frame.	White	1	10
MP1GRWH	Metal single gang rectangular faceplate. Covers one NEMA standard rectangular electrical outlet or one standard rectangular communication module frame.	White	1	10
MP1TSWH	Metal single gang toggle switch faceplate. Covers one NEMA standard toggle switch.	White	1	10
MP2GBWH	Metal double gang blank faceplate.	White	1	10
MP2G106WH	Metal double gang 106 duplex faceplate. Covers two NEMA standard 106 duplex electrical outlets or two standard 106 communication module frames.	White	1	10
MP2GRWH	Metal double gang rectangular faceplate. Covers two NEMA standard rectangular electrical outlets or two standard rectangular communication module frames.	White	1	10
MP2TSWH	Metal double gang toggle switch faceplate. Covers two NEMA standard toggle switches.	White	1	10
MP2G106BWH	Metal double gang 106 duplex/blank faceplate. Covers one NEMA standard 106 duplex electrical outlet or standard 106 communication module frame with opposite side blank.	White	1	10
MP2G106TSWH	Metal double gang 106 duplex/toggle switch faceplate. Covers one NEMA standard 106 duplex outlet or standard 106 communication module frame and one NEMA standard toggle switch.	White	1	10
MP2GRBWH	Metal double gang rectangular/blank faceplate. Covers one NEMA standard rectangular electrical outlet or standard rectangular communication module frame with opposite side blank.	White	1	10
MP2GRTSWH	Metal double gang rectangular/toggle switch faceplate. Covers one NEMA standard rectangular electrical outlet or standard rectangular communication module frame and one NEMA standard toggle switch.	White	1	10
MP2G106RWH	Metal double gang 106 duplex/rectangular faceplate. Covers one NEMA standard 106 duplex outlet or standard 106 communication module frame and one NEMA standard rectangular outlet or standard rectangular communication module frame.	White	1	10
MP3G106WH	Metal three gang 106 duplex faceplate. Covers three NEMA standard 106 duplex electrical outlets or three standard 106 communication module frames.	White	1	10
MP3GRWH	Metal three gang rectangular faceplate. Covers three NEMA standard rectangular electrical outlets or three standard rectangular communication module frames.	White	1	10
MP3TSWH	Metal three gang toggle switch faceplate. Covers three NEMA standard toggle switches.	White	1	10
MP3G1062TSWH	Metal three gang 106 duplex/two toggle switch faceplate. Covers one NEMA standard 106 duplex electrical outlet or one standard 106 communication module frame and two NEMA standard toggle switches.	White	1	10

‡For other colors replace WH (White) with AL (Almond).

A.  
System  
Overview

B1.  
Cable Ties

B2.  
Cable  
Accessories

B3.  
Stainless  
Steel Ties

C1.  
Wiring  
Duct

C2.  
Surface  
Raceway

C3.  
Abrasion  
Protection

C4.  
Cable  
Management

D1.  
Terminals

D2.  
Power  
Connectors

D3.  
Grounding  
Connectors

E1.  
Labeling  
Systems

E2.  
Labels

E3.  
Pre-Printed  
& Write-On  
Markers

E4.  
Permanent  
Identification

E5.  
Lockout/  
Tagout  
& Safety  
Solutions

F.  
Index

A. System Overview

B1. Cable Ties

B2. Cable Accessories

B3. Stainless Steel Ties

C1. Wiring Duct

C2. Surface Raceway

C3. Abrasion Protection

C4. Cable Management

D1. Terminals

D2. Power Connectors

D3. Grounding Connectors

E1. Labeling Systems

E2. Labels

E3. Pre-Printed & Write-On Markers

E4. Permanent Identification

E5. Lockout/Tagout & Safety Solutions

F. Index

## PAN-WAY® NON-METALLIC SURFACE RACEWAY

Pan-Way® Non-Metallic Surface Raceways provide maximum flexibility for routing, protecting, concealing and terminating high performance copper, voice, video, fiber optic and power cabling. Panduit surface raceways are designed with attention to function and aesthetics to blend with any décor. Panduit surface raceway systems include transition fittings that facilitate seamless integration of one Panduit surface raceway system to another. Panduit Surface Raceway Systems work with all Panduit® Mini-Com® Modules for complete connectivity possibilities.



- Aesthetically pleasing
- Lightweight
- Tamper resistant
- Bend radius control
- Resists dents and conceals scratches and chips
- Ease of modifications and additions
- Lowest installed cost

Panduit surface raceway provides a variety of choices when selecting data and electrical terminations. All Panduit surface raceways include a full complement of fittings that are designed to maintain the proper bend radius control required for high performance copper and fiber optic cabling systems. All of the raceways accept either NEMA 70mm standard screw-on faceplates or superior Pan-Way® Snap-On Faceplates. Panduit surface raceway systems work with all Panduit® Mini-Com® Modules, for complete connectivity possibilities.



## PAN-WAY® TG-70 NON-METALLIC SURFACE RACEWAY

Pan-Way® TG-70 Non-Metallic Surface Raceway is a multi-channel raceway, which provides a solution for routing copper, fiber optic, and/or power cabling when maximum cable capacity is required.



- Large raceway channel provides maximum capacity
- Fittings maintain 40mm (1.6 inch) bend radius control
- Multi-channel two-piece design
- Aesthetically pleasing
- Lightweight
- Tamper resistant



The TG-70 raceway system consists of raceway base and cover, fittings, termination hardware and accessories. Pan-Way® TG-70 Raceway can mount NEMA standard screw-on faceplates or superior Pan-Way® Snap-On Faceplates directly to the channel. Fittings for TG-70 are available to transition to Pan-Way® T-45 and LD raceway.

A.  
System  
Overview

B1.  
Cable Ties

B2.  
Cable  
Accessories

B3.  
Stainless  
Steel Ties

C1.  
Wiring  
Duct

C2.  
Surface  
Raceway

C3.  
Abrasion  
Protection

C4.  
Cable  
Management

D1.  
Terminals

D2.  
Power  
Connectors

D3.  
Grounding  
Connectors

E1.  
Labeling  
Systems

E2.  
Labels

E3.  
Pre-Printed  
& Write-On  
Markers

E4.  
Permanent  
Identification

E5.  
Lockout/  
Tagout  
& Safety  
Solutions

F.  
Index

A.  
System  
Overview

## TG-70 Raceway Roadmap

B1.  
Cable Ties

B2.  
Cable  
Accessories

B3.  
Stainless  
Steel Ties

C1.  
Wiring  
Duct

C2.  
Surface  
Raceway

C3.  
Abrasion  
Protection

C4.  
Cable  
Management

D1.  
Terminals

D2.  
Power  
Connectors

D3.  
Grounding  
Connectors

E1.  
Labeling  
Systems

E2.  
Labels

E3.  
Pre-Printed  
& Write-On  
Markers

E4.  
Permanent  
Identification

E5.  
Lockout/  
Tagout  
& Safety  
Solutions

F.  
Index



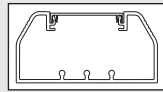

**1** TG-70\*\* – TG-70 Raceway Base and Cover (page C2.24)

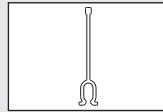

**1** TGDW – TG-70 Raceway Divider Wall (page C2.24)



**2** LD2P10\*\* – Raceway (page C2.75)

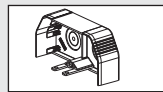

**A** TGEC\*\* – TG-70 End Cap (page C2.25)

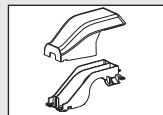

**B** TGTR\*\* – TG-70 Transition Fitting (page C2.25)

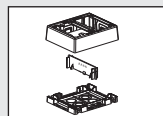

**C** JBP2FS\*\* – Fast-Snap™ Double Gang Power Rated Surface Mount Box (page C2.52)

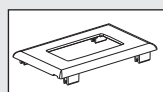

**D** T70PG\*\* – Single Gang Rectangular Electrical/Communication Snap-On Faceplate (page C2.53)



**E** T70FV2\*\* – Vertical Sloped Communication Snap-On Faceplate (page C2.52)

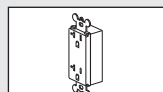

**F** ERU20\*\* – 20 A Rectangular Electrical Outlet (page C2.61)

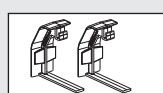

**G** TG70BC\*\* – TG-70 Base Couplers (page C2.25)

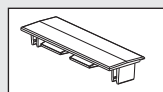

**H** T70CC\*\* – T-70 Cover Couplers (page C2.25)

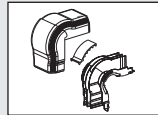

**J** TGOC\*\* – TG-70 Outside Corner Fitting (page C2.25)

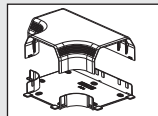

**K** TGT\*\* – TG-70 Tee Fitting (page C2.25)

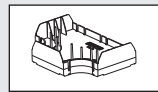

**L** TGTD – TG Tee Divider (page C2.25)

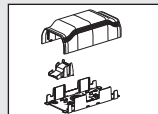

**M** TGBF\*\* – TG-70 Backfeed Fitting (page C2.25)

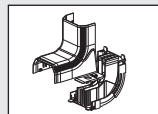

**N** TGIC\*\* – TG-70 Inside Corner Fitting (page C2.25)

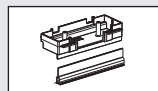

**O** TG70HB3-X – TG-70 Hanging Box with Divider Wall (page C2.26)



**P** UIT70FH4\*\* – Ultimate ID® Sloped Horizontal Snap-On Faceplate (see SA-NCCB51)

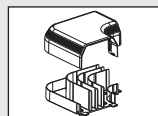

**Q** TGRA\*\* – TG-70 Right Angle Fitting (page C2.25)

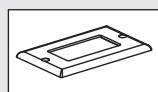

**R** CPG\*\* – Single Gang Rectangular Power and Communication Faceplate (page C2.60)

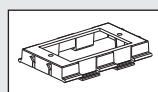

**S** T70DB-X – T-70 Device Mounting Bracket (page C2.26)



**T** TGEE\*\* – TG-70 Entrance End Fitting (page C2.25)

A. System Overview

B1. Cable Ties

B2. Cable Accessories

B3. Stainless Steel Ties

C1. Wiring Duct

C2. Surface Raceway

C3. Abrasion Protection

C4. Cable Management

D1. Terminals

D2. Power Connectors

D3. Grounding Connectors

E1. Labeling Systems

E2. Labels

E3. Pre-Printed & Write-On Markers

E4. Permanent Identification

E5. Lockout/Tagout & Safety Solutions

F. Index

A.  
System  
Overview

## TG-70 Configurations

B1.  
Cable Ties

### Exploded View 1

	Components Required	See page
A.	T70FV2 = Vertical sloped communication snap-on faceplate.	C2.52
B.	Panduit® Mini-Com® Modules.	—
C.	T70PG = Single gang rectangular electrical/communication snap-on faceplate.	C2.53
D.	ERU20 = 20 A rectangular electrical outlet (screws included).	C2.61
E.	JBP2FS = Fast-Snap™ Double Gang Power Rated Surface Mount Outlet Box.	C2.52

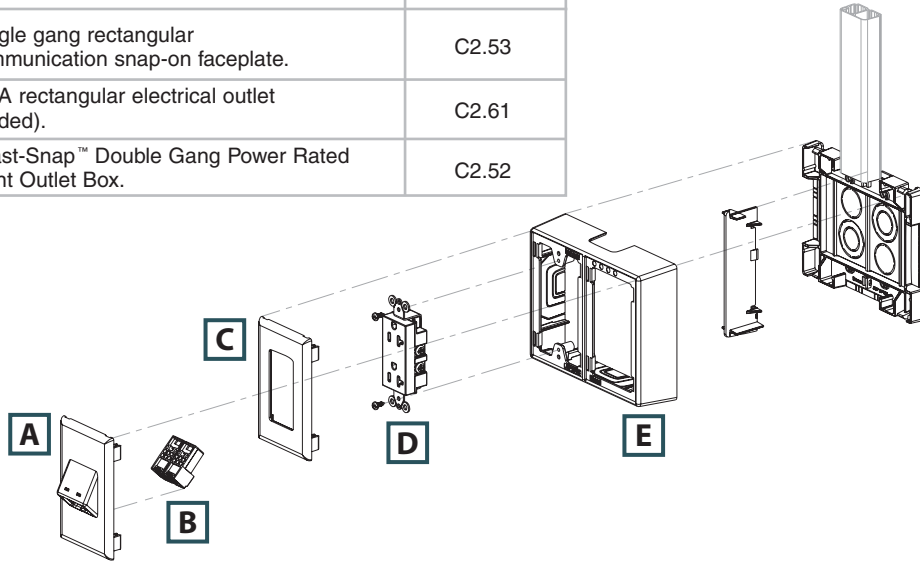

D1.  
Terminals

### Exploded View 2

	Components Required	See page
A.	T70PG = Single gang rectangular electrical/communication snap-on faceplate.	C2.53
B.	ERU20 = 20 A rectangular electrical outlet (screws included).	C2.61
C.	TG70HB3 = TG-70 3-sided hanging box.	C2.26

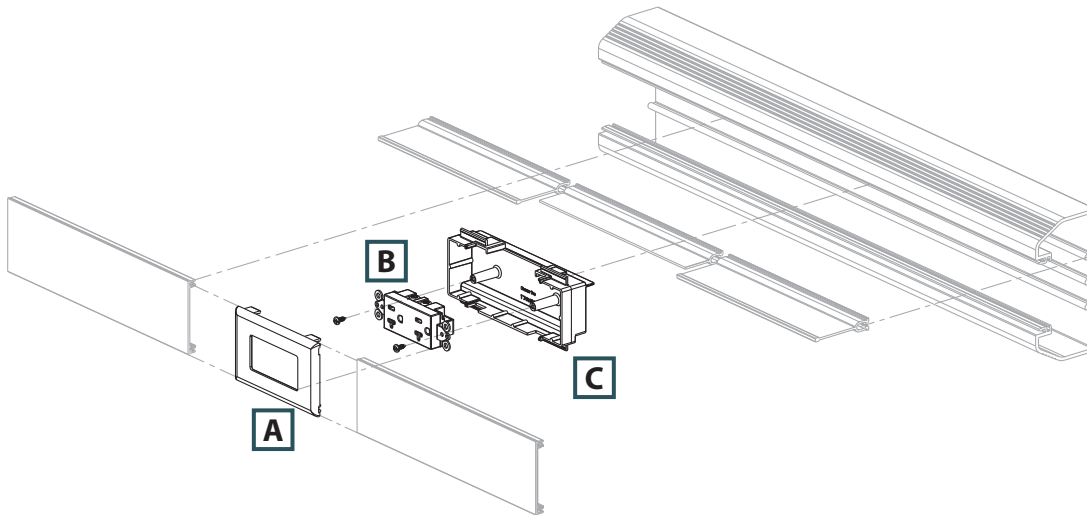

E1.  
Labeling  
Systems

E2.  
Labels

E3.  
Pre-Printed  
& Write-On  
Markers

E4.  
Permanent  
Identification

E5.  
Lockout/  
Tagout  
& Safety  
Solutions

F.  
Index

## TG-70 Configurations (continued)

### Exploded View 3

	Components Required	See page
A.	UIT70FH4 = Ultimate ID® Sloped Horizontal Snap-On Faceplate – 4-port.	—
B.	Mini-Com® Modules.	—

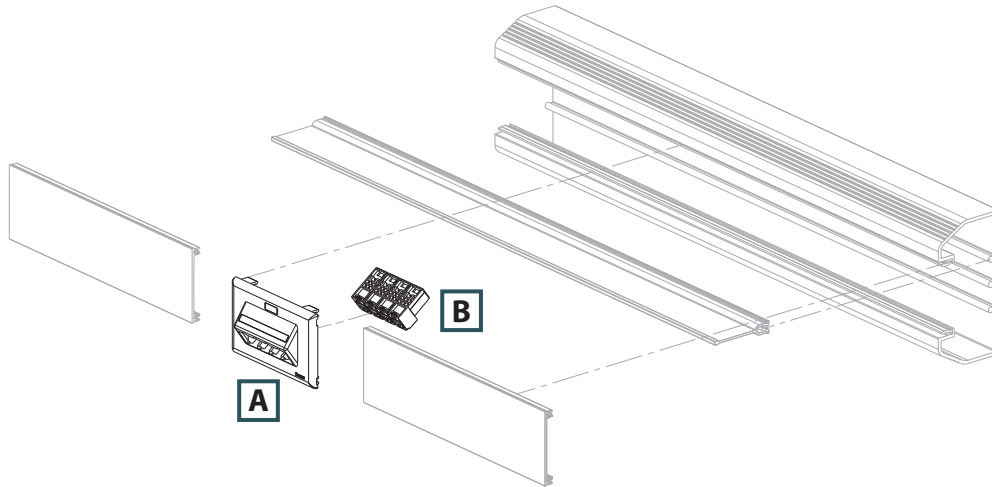

### Exploded View 4

	Components Required	See page
A.	CPG = Single gang rectangular screw-on faceplate (screws included).	C2.60
B.	CFG4 = Mini-Com® Module Frame – 4-port.	—
C.	Mini-Com® Modules.	—
D.	T70DB-X = T70 device bracket.	C2.26

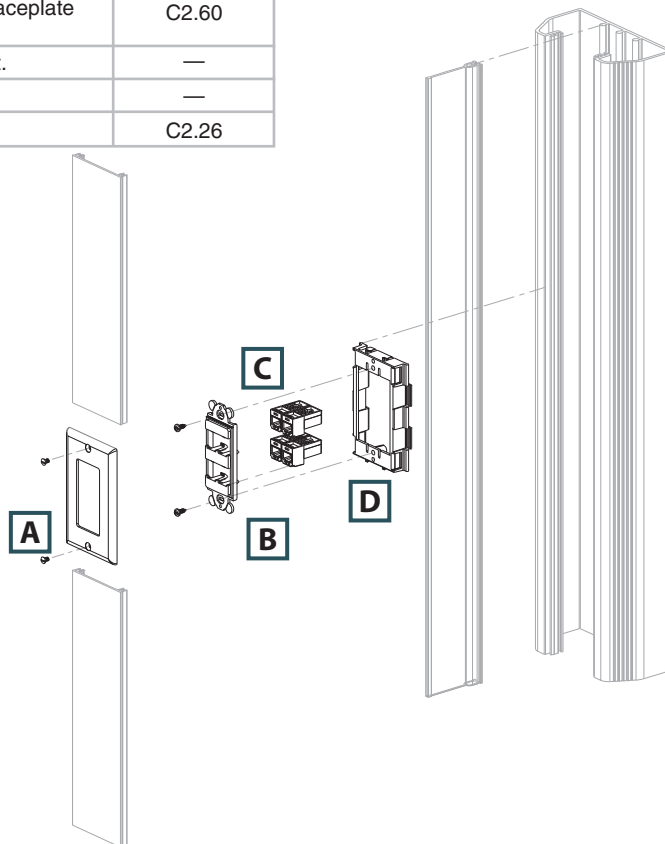

A.  
System  
Overview

B1.  
Cable Ties

B2.  
Cable  
Accessories

B3.  
Stainless  
Steel Ties

C1.  
Wiring  
Duct

C2.  
Surface  
Raceway

C3.  
Abrasion  
Protection

C4.  
Cable  
Management

D1.  
Terminals

D2.  
Power  
Connectors

D3.  
Grounding  
Connectors

E1.  
Labeling  
Systems

E2.  
Labels

E3.  
Pre-Printed  
& Write-On  
Markers

E4.  
Permanent  
Identification

E5.  
Lockout/  
Tagout/  
& Safety  
Solutions

F.  
Index

A. System Overview



## Pan-Way® TG-70 Surface Raceway System

B1. Cable Ties

- UL and CSA rated 600 V; meets UL 5A and CSA C22.2 No. 62.1-03 standards; FT4 rated
- Large cable capacity with aesthetically pleasing design
- Tamper resistant

- Compatible with NEMA standard faceplates or Pan-Way® Classic Series Snap-On Faceplates
- Transitions to Panduit T-45 and LD profile raceway
- Supplied with pre-punched mounting holes

B2. Cable Accessories

B3. Stainless Steel Ties

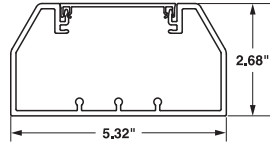

TG-70  
Internal Area = 10.85 Sq. In.

C1. Wiring Duct



TG70

Part Number	Part Description	Raceway Size	Color‡	Length (Ft.)	Std. Ctn. Qty.
<b>TG-70 Raceway Base and Cover — PACKAGED TOGETHER</b>					
<b>TG70IW8</b>	TG-70 raceway base in 8' and 10' lengths. Supplied with pre-punched mounting holes.	5.32" x 2.68" (135.0mm x 68.0mm)	Off White	8	32
<b>TG70IW10</b>				10	40

C2. Surface Raceway

C3. Abrasion Protection



T70C

<b>T-70/TG-70/Twin-70 Raceway Cover</b>					
<b>T70CIW8</b>	T-70, TG-70, or Twin-70 raceway cover in 8' and 10' lengths.	—	Off White	8	96
<b>T70CIW10</b>				10	120

C4. Cable Management

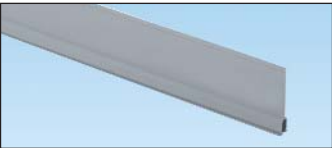

TGDW

<b>TG Raceway Divider Wall</b>					
<b>TGDW8</b>	TG raceway divider wall. Snaps onto rails in TG raceway base to create separate channels. Must use wire retainers to ensure channel separation per UL/CSA. Available in 8' and 10' lengths.	—	Gray	8	64
<b>TGDW10</b>				10	80

‡For other colors replace IW (Off White) with EI (Electric Ivory).  
Order number of feet required in multiples of standard carton quantity.

D1. Terminals

D2. Power Connectors

D3. Grounding Connectors

E1. Labeling Systems

E2. Labels

E3. Pre-Printed & Write-On Markers

E4. Permanent Identification

E5. Lockout/Tagout & Safety Solutions

F. Index



## Pan-Way® TG-70 Raceway Fittings

- TG-70 fittings are designed to exceed the TIA/EIA-568-B and 569-B required minimum bend radius for high performance copper and fiber optic cabling systems



T70CC



TG70BC

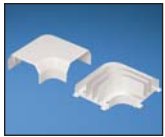

TGRA



TGIC



TGSIC



TGO



TGSOC



TGT



TGTD



TGE



TGEE



TGTR



TGBF



TGBFI

Part Number	Part Description	Color‡	Std. Pkg. Qty.	Std. Ctn. Qty.
<b>T70CCIW-X</b>	T-70 cover coupler fitting: Joins cover sections of T-70, Twin-70, and TG-70. raceway cover together.	Off White	10	100
<b>TG70BCIW-X</b>	Base coupler fitting. Each piece includes two base coupler halves for joining sections of TG-70 base together.	Off White	10	—
<b>TGRAIW</b>	Right angle fitting. Used to join sections of TG raceway at 90° flat junctions.	Off White	1	10
<b>TGICIW</b>	Inside corner fitting. Used to join sections of TG raceway at inside corners. Fittings adjust from 85° to 135° to adapt to non-square corners.	Off White	1	—
<b>TGSICIW</b>	Inside corner fitting – non-adjustable. Used to join sections of TG raceway at inside corners.	Off White	1	10
<b>TGOCIW</b>	Outside corner fitting. Used to join sections of TG raceway at outside corners. Fittings adjust from 85° to 135° to adapt to non-square corners.	Off White	1	—
<b>TGSOCIW</b>	Outside corner fitting – non-adjustable. Used to join sections of TG raceway at inside corners.	Off White	1	10
<b>TGTIW</b>	Tee fitting. Used to join sections of TG raceway at tee intersections.	Off White	1	5
<b>TGTD</b>	Tee divider insert. Mounts inside TGT tee fitting to maintain channel separation in TG raceway at tee intersections.	Gray	1	5
<b>TGECIW</b>	End cap. Used to terminate or allow entry to TG raceway. Two knockouts each for .50"(12.7mm) and 1"(25.4mm) conduit.	Off White	1	10
<b>TGEEIW</b>	Entrance end fitting. Accepts large conduit, (up to 2") in line or at a right angle. Maintains a 40mm bend radius with a removable insert and channel separation.	Off White	1	10
<b>TGTRIW</b>	Transition fitting from TG to T-45. Provides a tee transition from TG raceway to T-45 and LD series size 5 and 10. Use with RF5X3 reducer fitting to transition to LD series size 3.	Off White	1	10
<b>TGBFIW</b>	Backfeed fitting. Features breakouts to enter through the bottom of the fitting and maintains bend radius control with a removable, bend radius insert and channel separation.	Off White	1	10
<b>TGBFI</b>	Backfeed fitting insert. Removable and maintains bend radius control.	Gray	1	10

‡For other colors replace IW (Off White) with EI (Electric Ivory).

A. System Overview

B1. Cable Ties

B2. Cable Accessories

B3. Stainless Steel Ties

C1. Wiring Duct

C2. Surface Raceway

C3. Abrasion Protection

C4. Cable Management

D1. Terminals

D2. Power Connectors

D3. Grounding Connectors

E1. Labeling Systems

E2. Labels

E3. Pre-Printed & Write-On Markers

E4. Permanent Identification

E5. Lockout/Tagout & Safety Solutions

F. Index

A. System Overview



## Pan-Way® TG-70 Raceway Accessories

B1. Cable Ties

- TG-70 accessories consist of device mounting brackets, standard faceplate brackets for data, wire retainers and fiber spool brackets; the three-sided hanging box is used to mount NEMA standard single gang outlet and communications devices

B2. Cable Accessories

B3. Stainless Steel Ties

C1. Wiring Duct

C2. Surface Raceway

C3. Abrasion Protection

C4. Cable Management

D1. Terminals

D2. Power Connectors

D3. Grounding Connectors

E1. Labeling Systems

E2. Labels

E3. Pre-Printed & Write-On Markers

E4. Permanent Identification

E5. Lockout/Tagout & Safety Solutions

F. Index



T70DB-X



T70SDB-X

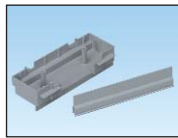

TG70HB3-X



TG70HB3GFCI-X

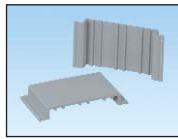

TG70WR-X

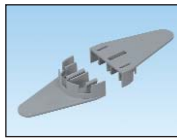

TGFSB

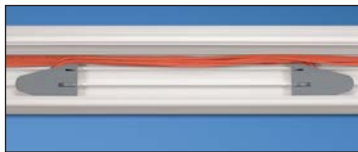

TGFSB installed in TG-70 raceway

Part Number	Part Description	Color	Std. Pkg. Qty.	Std. Ctn. Qty.
<b>T70DB-X</b>	Device mounting bracket. Used to mount NEMA standard single gang electrical outlets and communication devices with either screw-on or snap-on single gang faceplates. Can be used with T-70, Twin-70, and TG-70 raceway.	Gray	10	—
<b>T70SDB-X</b>	Standard faceplate bracket. Used to mount NEMA standard 70mm single gang screw-on faceplates. Can be used with T-70, Twin-70, TG-70 raceway and Pan-Pole™ Communication Pole.	Gray	10	—
<b>TG70HB3-X</b>	3-sided hanging box. Mounts standard electrical outlets or communication devices with either NEMA standard single gang screw-on or Panduit snap-on faceplates. When used with TGDW divider wall, box separates and fully encloses device to provide cabling separation.	Gray	10	—
<b>TG70HB3GFCI-X</b>	GFCI 3-sided hanging box. Accepts single gang U.S. GFCI (ground fault circuit interrupter) standard electrical devices. Provides increased internal area for connections and excess wire.	Gray	10	—
<b>TG70WR-X</b>	Wire retainer. Holds wires in place during installation.	Gray	10	100
<b>TGFSB</b>	Fiber spool bracket. Each piece consists of two halves that snap into base of TG raceway. Provides method to contain one meter or more of fiber slack and acts as a strain relief while maintaining a minimum 32mm bend radius. Bracket separation can be adjusted to fit the length of slack required.	Gray	1	10



## Cable Fill Capacities for TG-70 Raceway

This information is to be used as a guide in selecting the proper size raceway. The maximum amounts may vary according to the cable installation methods, straightness of cables, etc.



**A = 10.09 in.<sup>2</sup>**

**Cable fill #1:** With data only using screw-on faceplates and devices.



**A = 10.68 in.<sup>2</sup>**

**Cable fill #2:** With data only using snap-on faceplates and wire retainer.

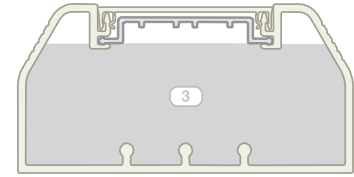

**A = 10.85 in.<sup>2</sup>**

**Cable fill #3:** With wire retainer.



**A = 3.16 in.<sup>2</sup>**

**A = 7.20 in.<sup>2</sup>**

**Cable fill #4:** Divided (see 5A and 5B for power and data applications).



**A = 3.08 in.<sup>2</sup>**

**A = 5.58 in.<sup>2</sup>**

**Cable fill #5:** With Power and data using snap-on faceplates and 3-sided power box.

Raceway Type and Configuration	Fill Area (In. <sup>2</sup> )	Electrical Cables			Data Grade Cables		Data Grade Cables		Audio/Video		Fiber Optic Cable	
		14 AWG	12 AWG	10 AWG	24 AWG/UTP CM		24 AWG/UTP CM		RG6		2 Strand	
		THHN/T90			Cat. 6		Cat. 6A					
		0.111	0.130	0.164	DIA. = 0.250		DIA. = 0.330		DIA. = 0.275		DIA. = 0.175	
		FILL			FILL		FILL		FILL		FILL	
MAX	MAX	MAX	SPEC	MAX	SPEC	MAX	SPEC	MAX	SPEC	MAX	SPEC	MAX
(UL Temp Rise Test)			(40%)	(60%)	(40%)	(60%)	(40%)	(60%)	(40%)	(60%)	(40%)	(60%)
1. TG70: Data only using screw-on faceplates and devices.	10.09	—	—	—	82	123	47	70	67	101	167	251
2. TG70: Data only using snap-on faceplates and wire retainer.	10.68	—	—	—	87	130	49	74	71	107	177	266
3. TG70: Wire retainer without devices.	10.85	40	40	38	88	132	50	76	73	109	180	270
4A. TG70: Divided power and data (A).	3.16	28	28	26	—	—	—	—	—	—	—	—
4B. TG70: Divided power and data (B).	7.20	—	—	—	58	88	33	50	48	72	119	179
5A. TG70: Power and data using snap-on faceplates and 3-sided power box (A).	3.08	28	28	26	—	—	—	—	—	—	—	—
5B. TG70: Power and data using snap-on faceplates and 3-sided power box (B).	5.58	—	—	—	45	68	26	39	37	56	92	139

AWG dimensions represent typical outer cable diameter in inches.

A.  
System  
Overview

B1.  
Cable Ties

B2.  
Cable  
Accessories

B3.  
Stainless  
Steel Ties

C1.  
Wiring  
Duct

C2.  
Surface  
Raceway

C3.  
Abrasion  
Protection

C4.  
Cable  
Management

D1.  
Terminals

D2.  
Power  
Connectors

D3.  
Grounding  
Connectors

E1.  
Labeling  
Systems

E2.  
Labels

E3.  
Pre-Printed  
& Write-On  
Markers

E4.  
Permanent  
Identification

E5.  
Lockout/  
Tagout  
& Safety  
Solutions

F.  
Index

# NOTES

## PAN-WAY® T-70 AND TWIN-70 NON-METALLIC SURFACE RACEWAY

Pan-Way® T-70 and Twin-70 Non-Metallic Surface Raceways are multi-channel raceways which provide solutions for routing copper, fiber optic, and/or power cabling along fixed perimeter walls. T-70 features the Workstation Outlet Center™ Offset Box which provides an offset solution to maximize channel capacity and outlet density. Twin-70 offers two totally independent channels maintained throughout the system for independent access to power, copper, and fiber optic cabling.

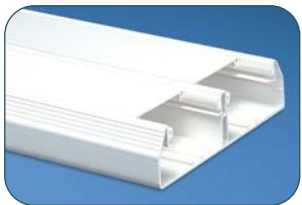

The T-70 and Twin-70 raceway systems consist of raceway base and cover, fittings, termination hardware and accessories. Pan-Way® T-70 and Twin-70 Raceway can mount NEMA standard screw-on faceplates or superior Pan-Way® Snap-On Faceplates directly to the channel. Fittings for T-70 and Twin-70 are available to transition to T-70, Twin-70, T-45 and LD raceways.

- Aesthetically pleasing
- Lightweight
- Tamper resistant
- Fittings maintain 1 inch bend radius control
- T-70 utilizes a single channel with snap-in divider wall to provide multi-channel capability
- Twin-70 utilizes two independent channels and covers to provide multi-channel capability

A.  
System  
Overview

B1.  
Cable Ties

B2.  
Cable  
Accessories

B3.  
Stainless  
Steel Ties

C1.  
Wiring  
Duct

C2.  
Surface  
Raceway

C3.  
Abrasion  
Protection

C4.  
Cable  
Management

D1.  
Terminals

D2.  
Power  
Connectors

D3.  
Grounding  
Connectors

E1.  
Labeling  
Systems

E2.  
Labels

E3.  
Pre-Printed  
& Write-On  
Markers

E4.  
Permanent  
Identification

E5.  
Lockout/  
Tagout  
& Safety  
Solutions

F.  
Index

A.  
System  
Overview

## T-70 Raceway Roadmap

B1.  
Cable Ties

B2.  
Cable  
Accessories

B3.  
Stainless  
Steel Ties

C1.  
Wiring  
Duct

C2.  
Surface  
Raceway

C3.  
Abrasion  
Protection

C4.  
Cable  
Management

D1.  
Terminals

D2.  
Power  
Connectors

D3.  
Grounding  
Connectors

E1.  
Labeling  
Systems

E2.  
Labels

E3.  
Pre-Printed  
& Write-On  
Markers

E4.  
Permanent  
Identification

E5.  
Lockout/  
Tagout  
& Safety  
Solutions

F.  
Index

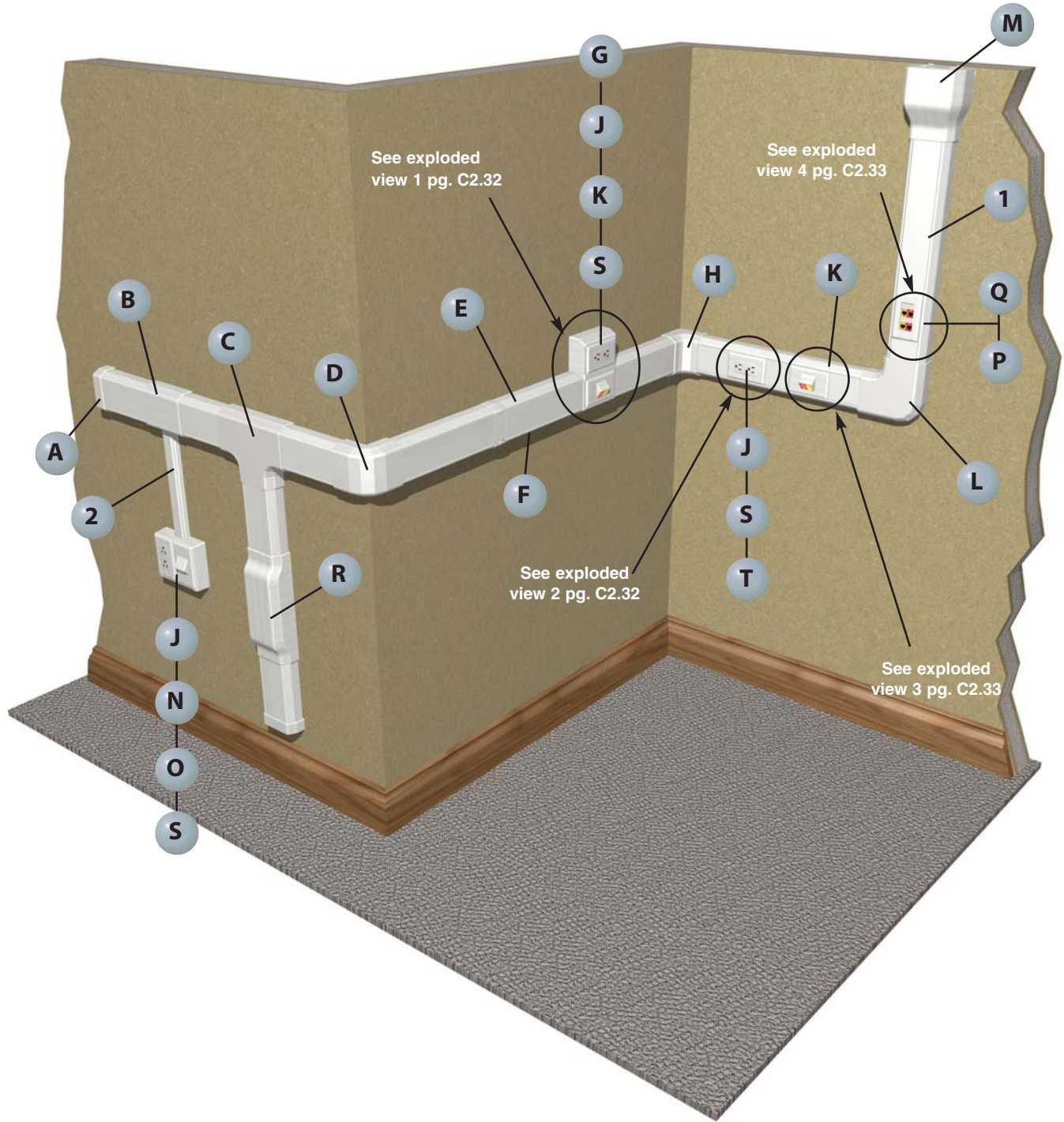

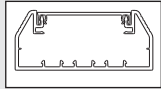

**1** T70B\*\*, T70C\*\* – T-70 Base and Cover (page C2.36)

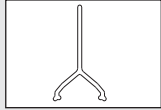

**1** T70DW – T-70 Divider Wall (page C2.36)

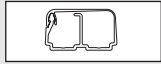

**2** LD2P10\*\* – LD2P10 Raceway (page C2.75)

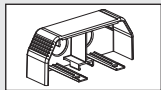

**A** T70EC\*\* – T-70 End Cap Fitting (page C2.37)

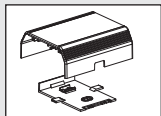

**B** T70TR\*\* – T-70 Transition Fitting (page C2.37)



**C** T70T\*\* – T-70 Tee Fitting  
T70TD – T-70 Tee Divider (page C2.37)

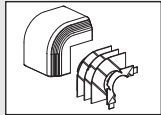
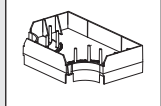

**D** T70OC\*\* – T-70 Outside Corner Fitting (page C2.37)

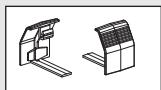

**E** T70BC\*\* – T-70 Base Coupler Fitting (page C2.36)

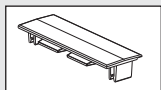

**F** T70CC\*\* – T-70 Cover Coupler Fitting (page C2.36)



**G** T70WC2\*\* – T-70 Workstation Outlet Center™ Offset Box for Snap-On Faceplates (page C2.37)

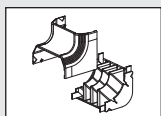

**H** T70IC\*\* – T-70 Inside Corner Fitting (page C2.36)

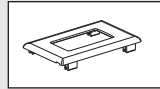

**J** T70PG\*\* – Single Gang Rectangular Electrical/Communication Snap-On Faceplate (page C2.53)

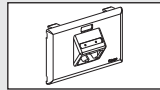

**K** UIT70FH2\*\* – Ultimate ID® Sloped Horizontal Snap-On Faceplate (see SA-NCCB51)

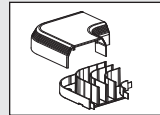

**L** T70RA\*\* – T-70 Right Angle Fitting (page C2.36)



**M** T70EE\*\* – T-70 Entrance End Fitting (page C2.37)

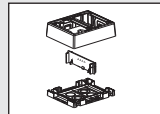

**N** JBP2FS\*\* – Fast-Snap™ Double Gang Power Rated Surface Mount Outlet Box (page C2.52)



**O** T70FV2\*\* – Vertical Sloped Communication Snap-On Faceplate (page C2.52)

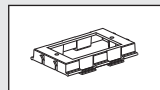

**P** T70DB-X – T-70 Device Bracket (page C2.40)

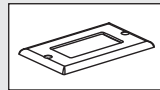

**Q** CPG\*\* – Single Gang Rectangular Screw-On Faceplate (page C2.60)

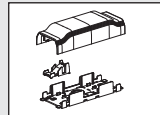

**R** T70BF\*\* – T-70 Backfeed Fitting (page C2.37)

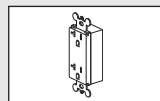

**S** ERU20\*\* – 20 A Rectangular Electrical Outlet (page C2.61)

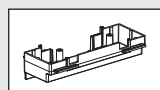

**T** T70HB3-X – 3-Sided Hanging Box (page C2.40)

A. System Overview

B1. Cable Ties

B2. Cable Accessories

B3. Stainless Steel Ties

C1. Wiring Duct

C2. Surface Raceway

C3. Abrasion Protection

C4. Cable Management

D1. Terminals

D2. Power Connectors

D3. Grounding Connectors

E1. Labeling Systems

E2. Labels

E3. Pre-Printed & Write-On Markers

E4. Permanent Identification

E5. Lockout/Tagout & Safety Solutions

F. Index

A.  
System  
Overview

## T-70 Configurations

B1.  
Cable Ties

### Exploded View 1

B2.  
Cable  
Accessories

B3.  
Stainless  
Steel Ties

C1.  
Wiring  
Duct

C2.  
Surface  
Raceway

C3.  
Abrasion  
Protection

C4.  
Cable  
Management

D1.  
Terminals

D2.  
Power  
Connectors

D3.  
Grounding  
Connectors

E1.  
Labeling  
Systems

E2.  
Labels

E3.  
Pre-Printed  
& Write-On  
Markers

E4.  
Permanent  
Identification

E5.  
Lockout/  
Tagout  
& Safety  
Solutions

F.  
Index

	Components Required	See page
A.	T70WC2 = T-70 Workstation Outlet Center™ Offset Box for snap-on faceplates.	C2.37
B.	ERU20 = 20 A rectangular electrical outlet (screws included).	C2.61
C.	Mini-Com® Modules.	—
D.	T70PG = Single gang rectangular electrical/communication snap-on faceplate.	C2.53
E.	UIT70FH2 = Ultimate ID® Sloped Horizontal Snap-On Faceplate – 2-port.	—

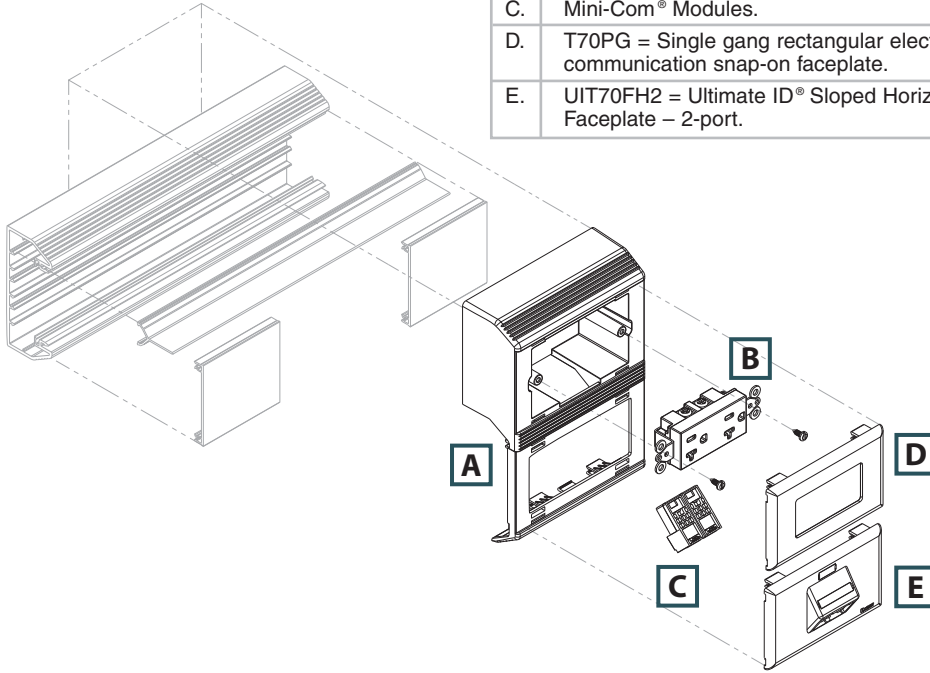

### Exploded View 2

	Components Required	See page
A.	T70PG = Single gang rectangular electrical/communication snap-on faceplate.	C2.53
B.	ERU20 = 20 A rectangular electrical outlet (screws included).	C2.61
C.	T70HB3-X = 3-Sided hanging box.	C2.40

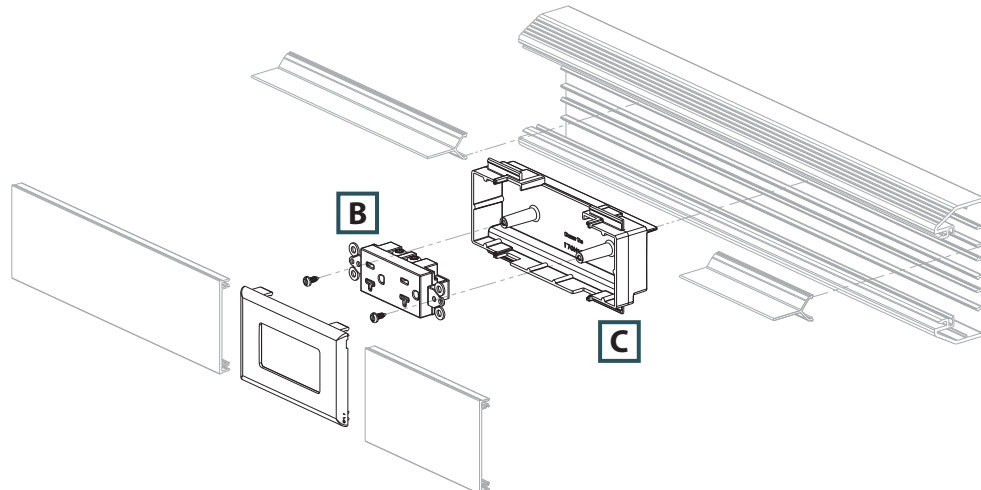

## T-70 Configurations (continued)

### Exploded View 3

	Components Required	See page
A.	UIT70FH2 = Ultimate ID® Sloped Horizontal Snap-On Faceplate – 2-port.	—
B.	Mini-Com® Modules.	—

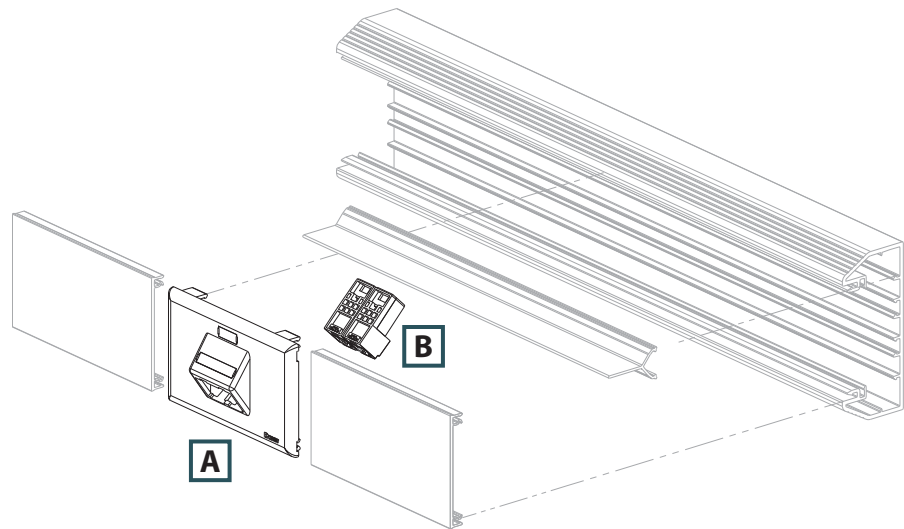

### Exploded View 4

	Components Required	See page
A.	CPG = Single gang rectangular screw-on faceplates (screws included).	C2.60
B.	CFP4 = Mini-Com® Module Frame – 4-port.	—
C.	Mini-Com® Modules.	—
D.	T70DB-X = T-70 device bracket.	C2.40

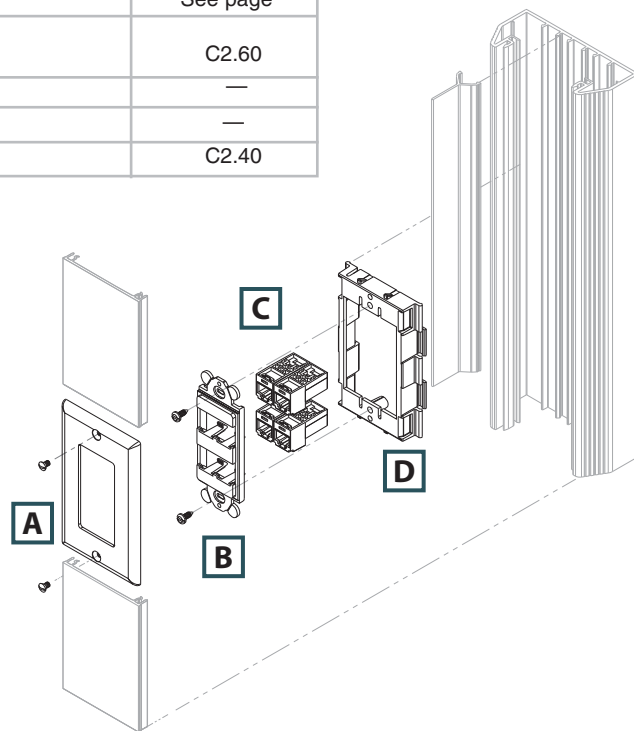

A.  
System  
Overview

B1.  
Cable Ties

B2.  
Cable  
Accessories

B3.  
Stainless  
Steel Ties

C1.  
Wiring  
Duct

C2.  
Surface  
Raceway

C3.  
Abrasion  
Protection

C4.  
Cable  
Management

D1.  
Terminals

D2.  
Power  
Connectors

D3.  
Grounding  
Connectors

E1.  
Labeling  
Systems

E2.  
Labels

E3.  
Pre-Printed  
& Write-On  
Markers

E4.  
Permanent  
Identification

E5.  
Lockout/  
Tagout  
& Safety  
Solutions

F.  
Index

A.  
System  
Overview

## Twin-70 Raceway Roadmap

B1.  
Cable Ties

B2.  
Cable  
Accessories

B3.  
Stainless  
Steel Ties

C1.  
Wiring  
Duct

C2.  
Surface  
Raceway

C3.  
Abrasion  
Protection

C4.  
Cable  
Management

D1.  
Terminals

D2.  
Power  
Connectors

D3.  
Grounding  
Connectors

E1.  
Labeling  
Systems

E2.  
Labels

E3.  
Pre-Printed  
& Write-On  
Markers

E4.  
Permanent  
Identification

E5.  
Lockout/  
Tagout  
& Safety  
Solutions

F.  
Index

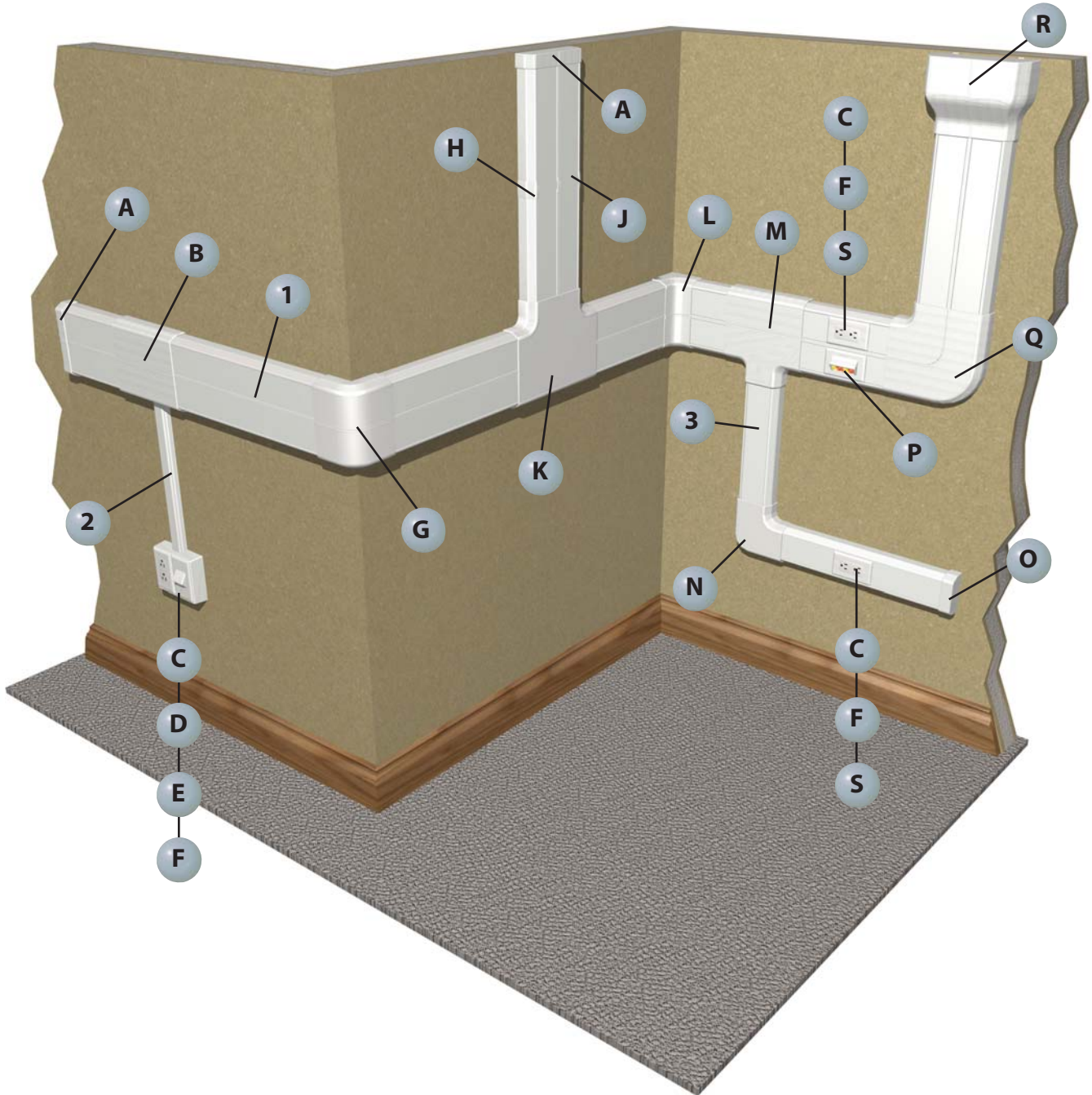





**1** T702B\*\*, T70C\*\* – Twin-70 Raceway Base and Cover (page C2.38)



**2** T45B\*\*, T45C\*\* – T-45 Raceway Base and Cover (page C2.48)



**3** T70B\*\*, T70C\*\* – T-70 Raceway Base and Cover (page C2.36)



**A** T702EC\*\* – Twin-70 End Cap Fitting (page C2.39)



**B** T702TRL\*\* – Twin-70 Transition Fitting (page C2.39)



**C** T70PG\*\* – Single Gang Rectangular Electrical/Communication Snap-On Faceplate (page C2.53)

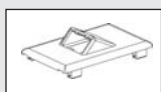

**D** T70FV2\*\* – Vertical Sloped Communication Snap-On Faceplate (page C2.52)



**E** JBP2FS\*\* – Fast-Snap™ Double Gang Power Rated Surface Mount Outlet Box (page C2.52)



**F** ERU20\*\* – 20 A Rectangular Electrical Outlet (page C2.61)



**G** T702OC\*\* – Twin-70 Outside Corner Fitting (page C2.39)



**H** T702BC\*\* – Twin-70 Base Coupler Fitting (page C2.39)

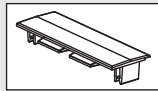

**J** T70CC\*\* – T-70 Cover Coupler Fitting (page C2.39)



**K** T702T\*\* – Twin-70 Tee Fitting (page C2.39)



**L** T702IC\*\* – Twin-70 Inside Corner Fitting (page C2.39)



**M** T702TR\*\* – Twin-70 Transition Fitting (page C2.39)



**N** T702RA\*\* – Twin-70 Right Angle Fitting (page C2.39)

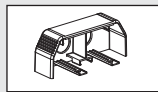

**O** T70EC\*\* – T-70 End Cap Fitting (page C2.37)



**P** UIT70FH4\*\* – Ultimate ID® Sloped Horizontal Snap-On Faceplate (see SA-NCCB51)



**Q** T702RA\*\* – Twin-70 Right Angle Fitting (page C2.39)



**R** T702EE\*\* – Twin-70 Entrance End Fitting (page C2.39)



**S** T70DB-X\*\* – T-70 Device Mounting Bracket (page C2.40)

A. System Overview

B1. Cable Ties

B2. Cable Accessories

B3. Stainless Steel Ties

C1. Wiring Duct

C2. Surface Raceway

C3. Abrasion Protection

C4. Cable Management

D1. Terminals

D2. Power Connectors

D3. Grounding Connectors

E1. Labeling Systems

E2. Labels

E3. Pre-Printed & Write-On Markers

E4. Permanent Identification

E5. Lockout/Tagout & Safety Solutions

F. Index

A. System Overview

## UL<sup>®</sup> SA LISTED SF<sup>®</sup> Pan-Way<sup>®</sup> T-70 Surface Raceway System

B1. Cable Ties

- UL and CSA rated 600 V; meets UL 5A and CSA C22.2 No. 62.1-03 standards; FT4 rated
- Large cable capacity with aesthetically pleasing design
- Tamper resistant

- Compatible with NEMA standard 70mm faceplates or Pan-Way<sup>®</sup> Classic Series Snap-On Faceplates
- Transitions to Panduit T-45 and LD profile raceway
- Supplied with pre-punched mounting holes

B2. Cable Accessories

B3. Stainless Steel Ties

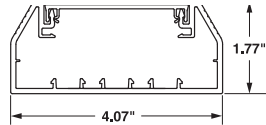

T-70  
Internal Area = 5.15 Sq. In.

C1. Wiring Duct



T70B

C2. Surface Raceway

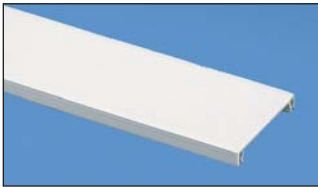

T70C

C3. Abrasion Protection

C4. Cable Management

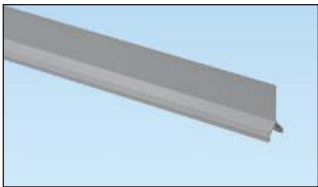

T70DW

D1. Terminals

D2. Power Connectors

D3. Grounding Connectors

Part Number	Part Description	Raceway Size	Color‡	Length (Ft.)	Std. Ctn. Qty.
-------------	------------------	--------------	--------	--------------	----------------

### T-70 Raceway Base

<b>T70BIW8</b>	T-70 raceway base in 8' and 10' lengths. Supplied with pre-punched mounting holes.	4.07" x 1.77" (103.3mm x 45.0mm)	Off White	8	48
<b>T70BIW10</b>				10	60

### T-70/TG-70/Twin-70 Raceway Cover

<b>T70CIW8</b>	T-70, TG-70, or Twin-70 raceway cover in 8' and 10' lengths.	—	Off White	8	96
<b>T70CIW10</b>				10	120

### T-70/Twin-70 Raceway Divider Wall

<b>T70DW8</b>	T-70/Twin-70 raceway divider wall. Snaps onto rails in T-70/Twin-70 raceway base to create separate channels. Must use wire retainers to ensure channel separation per UL/CSA. Available in 8' and 10' lengths.	—	Gray	8	96
<b>T70DW10</b>				10	120

‡For other colors replace IW (Off White) with EI (Electric Ivory), WH (White), BL (Black) or IG (International Gray in 8' lengths ONLY).

Order raceway base and cover separately.

Order number of feet required in multiples of standard carton quantity.

E1. Labeling Systems

## UL<sup>®</sup> SA LISTED SF<sup>®</sup> Pan-Way<sup>®</sup> T-70 Raceway Fittings

- T-70 fittings are designed to maintain the TIA/EIA-568-B and 569-B required minimum bend radius for high performance copper and fiber optic cabling systems

E2. Labels



T70CC



T70BC

E3. Pre-Printed & Write-On Markers

E4. Permanent Identification

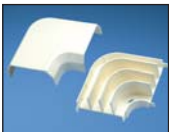

T70RA

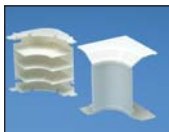

T70IC

E5. Lockout/Tagout & Safety Solutions

F. Index

Part Number	Part Description	Color‡	Std. Pkg. Qty.	Std. Ctn. Qty.
<b>T70CCIW-X</b>	T-70 cover coupler fitting: Joins cover sections of T-70, Twin-70, and TG-70. raceway cover together.	Off White	10	100
<b>T70BCIW-X</b>	Base coupler fitting. Used to join sections of T-70 raceway base together.	Off White	10	0
<b>T70RAIW</b>	Right angle fitting. Used to join sections of T-70 raceway at right angles.	Off White	1	10
<b>T70ICIW</b>	Inside corner fitting. Used to join sections of T-70 raceway at inside corners.	Off White	1	10

‡For other colors replace IW (Off White) with EI (Electric Ivory), BL (Black), IG (International Gray), or WH (White).



## Pan-Way® T-70 Raceway Fittings (continued)

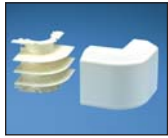

T70OC

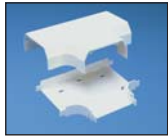

T70T



T70TD



T70EC



T70EE



T70TR  
T70TRC



T70TRI



T70WM40TR



T70BF



T70BFI



T70WC



T70WC2

Part Number	Part Description	Color‡	Std. Pkg. Qty.	Std. Ctn. Qty.
<b>T70OCIW</b>	Outside corner fitting. Used to join sections of T-70 raceway at outside corners.	Off White	1	10
<b>T70TIW</b>	Tee fitting. Used to join sections of T-70 raceway at tee intersections.	Off White	1	10
<b>T70TD</b>	T-70 tee fitting divider. Separates power and data within tee fitting. Replaces T70TDB, T70TDC, and T70TDT.	Gray	1	10
<b>T70ECIW</b>	End cap fitting. Used to terminate or allow entry to T-70 raceway with conduit breakouts of 1/2" .	Off White	1	10
<b>T70EEIW</b>	Entrance end fitting. Conduit breakouts of 1/2", 3/4", 1" and 1 1/4" which allows entry from ceiling or wall.	Off White	1	10
<b>T70TRIW</b>	Transition fitting. Used to transition to any LD profile or T-45 raceway while maintaining channel separation. Fitting includes bend radius insert.	Off White	1	10
<b>T70TRCIW</b>	Transition fitting cover. Used to transition to any LD profile or T-45 raceway.	Off White	1	10
<b>T70TRI</b>	Divided insert for T-70 to LD2P10. Maintains channel separation within T70TR fitting.	Gray	1	10
<b>T70WM40TRIW</b>	WIREMOLD* 4000 to T-70 transition fitting. In-line transition fitting from WIREMOLD 4000 to T-70 raceway.	Off White	1	10
<b>T70BFIW</b>	Backfeed fitting. Allows cable entry through the back of the T-70 raceway.	Off White	1	10
<b>T70BFI</b>	Backfeed fitting insert. Bend radius insert to be used with T70BF.	Gray	1	10
<b>T70WCIW</b>	Workstation Outlet Center™ Offset Box for screw-on faceplates. Two-piece box and bracket accept any NEMA standard screw-on faceplate.	Off White	1	10
<b>T70WC2IW</b>	Workstation Outlet Center™ Offset Box for Pan-Way® Snap-On Faceplates. Two-piece box and bracket accept any standard electrical outlet. Accepts any Pan-Way® Snap-On Electrical/Communication Faceplates.	Off White	1	10

‡For other colors replace IW (Off White) with EI (Electric Ivory), BL (Black), IG (International Gray), or WH (White).  
\*WIREMOLD is a registered trademark of the Wiremold Co.

A.  
System  
Overview

B1.  
Cable Ties

B2.  
Cable  
Accessories

B3.  
Stainless  
Steel Ties

C1.  
Wiring  
Duct

C2.  
Surface  
Raceway

C3.  
Abrasion  
Protection

C4.  
Cable  
Management

D1.  
Terminals

D2.  
Power  
Connectors

D3.  
Grounding  
Connectors

E1.  
Labeling  
Systems

E2.  
Labels

E3.  
Pre-Printed  
& Write-On  
Markers

E4.  
Permanent  
Identification

E5.  
Lockout/  
Tagout  
& Safety  
Solutions

F.  
Index

A. System Overview



## Pan-Way® Twin-70 Surface Raceway System

B1. Cable Ties

- UL and CSA rated 600 V; meets UL 5A and CSA C22.2 No. 62.1-03 standards; FT4 rated
- Separate channels allow independent access to power and communication cabling throughout the entire system
- Transitions to Panduit T-70, T-45, and LD profile raceway

- Compatible with NEMA standard 70mm faceplates or Pan-Way® Classic Series Snap-On Faceplates
- Tamper resistant
- Supplied with pre-punched mounting holes

B2. Cable Accessories

B3. Stainless Steel Ties

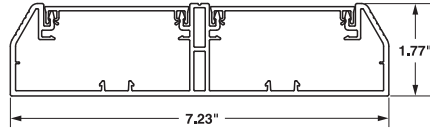

TWIN-70  
Left Internal Area = 4.59 Sq. In.  
Right Internal Area = 4.59 Sq. In.

C1. Wiring Duct



T702B

C2. Surface Raceway

C3. Abrasion Protection



T70C

C4. Cable Management

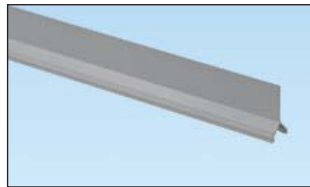

T70DW

D1. Terminals

D2. Power Connectors

D3. Grounding Connectors

E1. Labeling Systems

E2. Labels

E3. Pre-Printed & Write-On Markers

E4. Permanent Identification

E5. Lockout/Tagout & Safety Solutions

F. Index

Part Number	Part Description	Raceway Size	Color‡	Length (Ft.)	Std. Ctn. Qty.
<b>Twin-70 Raceway Base</b>					
<b>T702BIW8</b>	Twin-70 raceway base in 8' and 10' lengths. Supplied with pre-punched mounting holes.	7.23" x 1.77" (184.0mm x 45.0mm)	Off White	8	24
<b>T702BIW10</b>				10	30

<b>T-70/TG-70/Twin-70 Raceway Cover</b>					
<b>T70CIW8</b>	T-70, TG-70, or Twin-70 raceway cover in 8' and 10' lengths.	—	Off White	8	96
<b>T70CIW10</b>				10	120

<b>T-70/Twin-70 Raceway Divider Wall</b>					
<b>T70DW8</b>	T-70/Twin-70 raceway divider wall. Snaps onto rails in T-70/Twin-70 raceway base to create separate channels. Must use wire retainers to ensure channel separation per UL/CSA. Available in 8' and 10' lengths.	—	Gray	8	96
<b>T70DW10</b>				10	120

‡ For other colors replace IW (Off White) with EI (Electric Ivory) or WH (White).  
**2' of cover needed for every 1' of Twin-70 base.**  
 Order number of feet required in multiples of standard carton quantity.



## Pan-Way® Twin-70 Raceway Fittings

- Twin-70 fittings are designed to maintain the TIA/EIA-568-B and 569-B required minimum bend radius for high performance copper and fiber optic cabling systems



T70CC

T702BC

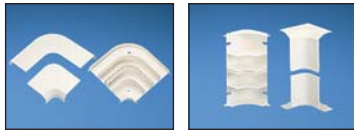

T702RA

T702IC

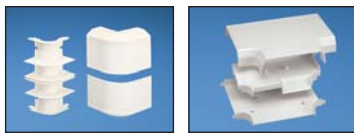

T702OC

T702T



T702EC

T702EE

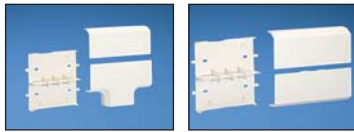

T702TR

T702TRL

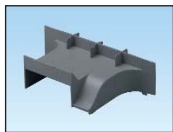

T702TRI

Part Number	Part Description	Color‡	Std. Pkg. Qty.	Std. Ctn. Qty.
<b>T70CCIW-X</b>	Cover coupler fitting. Used to join sections of cover together.	Off White	10	100
<b>T702BCIW-X</b>	Base coupler fitting. Used for joining sections of Twin-70 base together.	Off White	10	—
<b>T702RAIW</b>	Right angle fitting. Used to join sections of Twin-70 raceway at 90° flat junctions.	Off White	1	10
<b>T702ICIW</b>	Inside corner fitting. Used to join sections of Twin-70 raceway at inside corners.	Off White	1	10
<b>T702OCIW</b>	Outside corner fitting. Used to join sections of Twin-70 raceway at outside corners.	Off White	1	10
<b>T702TIW</b>	Tee fitting. Used to join sections of Twin-70 raceway at tee intersections.	Off White	1	5
<b>T702ECIW</b>	End cap fitting. Conduit breakouts of 1/2" for entry into raceway channel.	Off White	1	10
<b>T702EEIW</b>	Entrance end fitting. Conduit breakouts of 1/2", 3/4", 1", 1 1/4" and 1 1/2" for entry from ceiling or wall.	Off White	1	5
<b>T702TRIW</b>	Transition fitting. Used to transition to T-70 raceway.	Off White	1	5
<b>T702TRLIW</b>	Transition fitting. Used to transition to any LD profile or T-45 raceway.	Off White	1	5
<b>T702TRI</b>	Transition divider insert for Twin-70 to T-70 or Twin-70 to LD profile. Maintains channel separation within T702TR or T702TRL fittings.	Gray	1	10

‡For other colors replace IW (Off White) with EI (Electric Ivory) or WH (White). T702TRI available in Gray only.

A.  
System  
Overview

B1.  
Cable Ties

B2.  
Cable  
Accessories

B3.  
Stainless  
Steel Ties

C1.  
Wiring  
Duct

C2.  
Surface  
Raceway

C3.  
Abrasion  
Protection

C4.  
Cable  
Management

D1.  
Terminals

D2.  
Power  
Connectors

D3.  
Grounding  
Connectors

E1.  
Labeling  
Systems

E2.  
Labels

E3.  
Pre-Printed  
& Write-On  
Markers

E4.  
Permanent  
Identification

E5.  
Lockout/  
Tagout  
& Safety  
Solutions

F.  
Index

A. System Overview



## Pan-Way® T-70 and Twin-70 Raceway Accessories

B1. Cable Ties

- T-70 and Twin-70 raceway accessories consist of device mounting brackets, snap-on device brackets, hanging boxes and 3-sided hanging boxes used to mount NEMA standard single gang electrical outlets and/or communication devices

B2. Cable Accessories



T70DB-X



T70SDB-X

B3. Stainless Steel Ties



T70HB-X



T70HB3-X

C1. Wiring Duct

C2. Surface Raceway

C3. Abrasion Protection



T70HB3GFCI-X



T70WR-X

C4. Cable Management



T70S-X

D1. Terminals

D2. Power Connectors

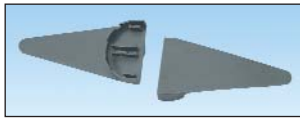

T70FSB

D3. Grounding Connectors

E1. Labeling Systems

E2. Labels

E3. Pre-Printed & Write-On Markers

E4. Permanent Identification

E5. Lockout/Tagout & Safety Solutions

F. Index

Part Number	Part Description	Color	Std. Pkg. Qty.	Std. Ctn. Qty.
<b>T70DB-X</b>	Device mounting bracket. Used to mount NEMA standard single gang electrical outlets and communication devices with either screw-on or snap-on single gang faceplates. Can be used with T-70, Twin-70, and TG-70 raceway.	Gray	10	—
<b>T70SDB-X</b>	Standard faceplate bracket. Used to mount NEMA standard 70mm single gang screw-on faceplates. Can be used with T-70, Twin-70, TG-70 raceway and Pan-Pole™ Communication Pole.	Gray	10	—
<b>T70HB-X</b>	Hanging box. Used to mount NEMA standard single gang electrical outlets and devices with either screw-on or snap-on single gang faceplates when there are communications cables in the raceway. For use in T-70 and Twin-70 raceway only.	Gray	10	—
<b>T70HB3-X</b>	3-sided hanging box. Used to mount NEMA standard single gang electrical outlets and devices with either screw-on or snap-on single gang faceplates when there are communications cables in the raceway. Box is low profile for increased channel capacity and does not require breakout removal. For use with T-70 and Twin-70 raceway only.	Gray	10	—
<b>T70HB3GFCI-X</b>	T70 GFCI 3-sided hanging box. Accepts single gang U.S. GFCI (ground fault circuit interrupter) standard electrical devices. Provides increased internal area for connections and excess wire.	Gray	10	—
<b>T70WR-X</b>	Wire retainer. Holds wires in place during installation.	Gray	10	100
<b>T70S-X</b>	Spacer plate. Used to mount the CBX4 surface mount box onto the T70DB-X or T70HB-X/T70HB3-X.	—	10	—
<b>T70FSB</b>	Fiber spool bracket. Each piece consists of two halves that snap into base of T-70 or Twin-70 raceway. Provides method to contain one meter or more of fiber slack and acts as a strain relief while maintaining a minimum 30mm bend radius. Bracket separation can be adjusted to fit the length of slack required.	Gray	1	10



Use the T70FSB with T-70 or Twin-70 raceway to contain 1m or more of fiber slack while maintaining a 30mm cable bend radius. Brackets are adjustable for slack length.



Use T70S-X spacer plate for mounting the CBX4 surface mount box on T-70 or T702.

## Cable Fill Capacities for T-70 Raceway

This information is to be used as a guide in selecting the proper size raceway. The maximum amounts may vary according to the cable installation methods, straightness of cables, etc.

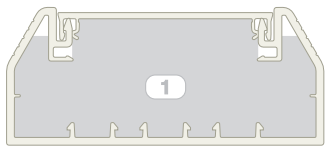

A = 5.15 in.<sup>2</sup>

**Cable fill #1:** Raceway with no devices.

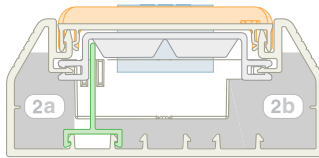

A = .86 in.<sup>2</sup>      A = 1.72 in.<sup>2</sup>

**Cable fill #2:** Power and data using 3-sided hanging box and device bracket.

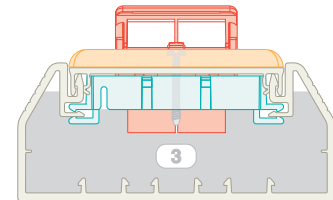

A = 3.67 in.<sup>2</sup>

**Cable fill #3:** Data only using vertical sloped screw-on communication faceplates.

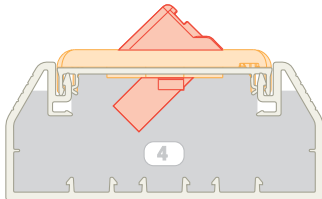

A = 4.71 in.<sup>2</sup>

**Cable fill #4:** Data only using horizontal sloped snap-on communication faceplates.

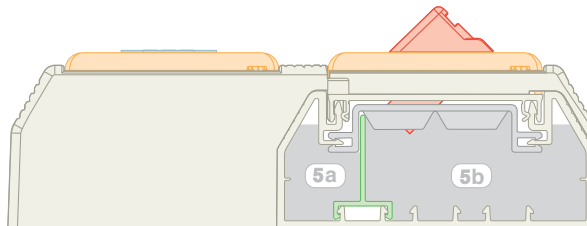

A = .91 in.<sup>2</sup>      A = 3.12 in.<sup>2</sup>

**Cable fill #5:** Power and data using the Workstation Outlet Center™ Offset Box.

**SPEC = 40% cable fill** – The recommended design in cable capacity, leaves room for future moves, adds, and changes.

**MAX for Data = 60% cable fill** – The maximum cable quantity based on cable interweaving and packing factors.

**MAX for Power cable fill** – The maximum of electrical cables based on UL temperature rise test.

Raceway Type and Configuration	Fill Area (in. <sup>2</sup> )	Electrical Cables			Data Grade Cables		Data Grade Cables		Audio/Video		Fiber Optic Cable		
		14 AWG THHN/T90	12 AWG THHN/T90	10 AWG THHN/T90	24 AWG/UTP CM Cat 6. (4-pr.)	24 AWG/UTP CM Augmented Cat. 6	RG6		2 Strand				
		0.111	0.130	0.164	DIA. = 0.250	DIA. = 0.330	DIA. = 0.275		DIA. = 0.175				
		FILL			FILL		FILL		FILL		FILL		
		MAX	MAX	MAX	SPEC	MAX	SPEC	MAX	SPEC	MAX	SPEC	MAX	MAX
		(UL Temp Rise Test)			(40%)	(60%)	(40%)	(60%)	(40%)	(60%)	(40%)	(60%)	
1. T-70: No devices.	5.15	24	20	15	41	62	24	36	34	52	85	128	
2a. T-70: Power and data using the 3-sided hanging box and device bracket.	0.86	14	11	7	—	—	—	—	—	—	—	—	
2b.	1.72	—	—	—	14	21	8	12	11	17	28	42	
3. T-70: Data only (screw-on faceplates).	3.67	—	—	—	29	44	17	25	24	37	61	91	
4. T-70: Data only (snap-on faceplates).	4.71	—	—	—	38	57	22	33	31	47	78	117	
5a. T-70: Power and data using the Workstation Outlet Center™ Offset Box.	0.91	14	11	7	—	—	—	—	—	—	—	—	
5b.	3.12	—	—	—	25	38	14	21	21	31	51	77	

AWG dimensions represent typical outer cable diameter in inches.

A. System Overview

## Cable Fill Capacities for Twin-70 Raceway

B1. Cable Ties

This information is to be used as a guide in selecting the proper size raceway. The maximum amounts may vary according to the cable installation methods, straightness of cables, etc.

B2. Cable Accessories

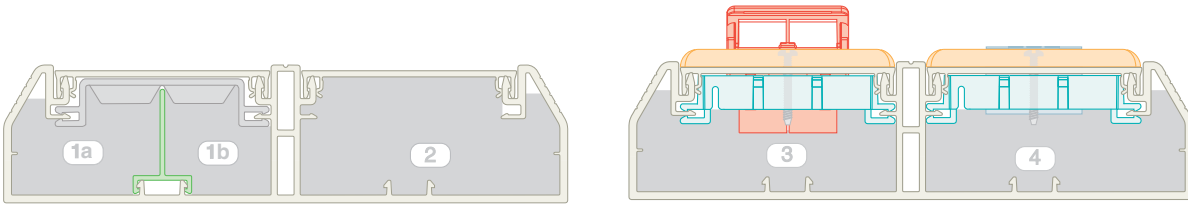

**A = 2.05 in.<sup>2</sup>**

**A = 1.43 in.<sup>2</sup>**

**A = 4.59 in.<sup>2</sup>**

**A = 3.11 in.<sup>2</sup>**

**A = 3.32 in.<sup>2</sup>**

**Cable fill #1:** Power and data with no devices.

**Cable fill #2:** One Twin-70 channel with no devices.

**Cable fill #3:** Data only using vertical sloped screw-on communication faceplates.

**Cable fill #4:** Power using device bracket and NEMA standard 70mm screw-on faceplates.

C1. Wiring Duct

C2. Surface Raceway

C3. Abrasion Protection

C4. Cable Management

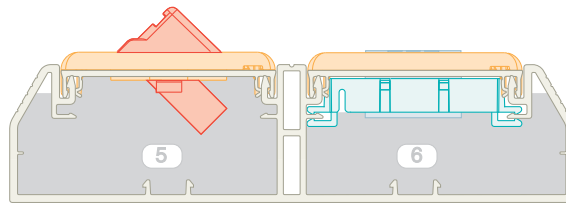

**A = 4.14 in.<sup>2</sup>**

**A = 2.33 in.<sup>2</sup>**

**Cable fill #5:** Data only using horizontal sloped snap-on communication faceplates.

**Cable fill #6:** 20 A TVSS rectangular outlet using device bracket and snap-on electrical/communication faceplate.

D1. Terminals

D2. Power Connectors

D3. Grounding Connectors

E1. Labeling Systems

E2. Labels

E3. Pre-Printed & Write-On Markers

E4. Permanent Identification

E5. Lockout/Tagout & Safety Solutions

F. Index

**SPEC = 40% cable fill** – The recommended design in cable capacity, leaves room for future moves, adds, and changes.

**MAX for Data = 60% cable fill** – The maximum cable quantity based on cable interweaving and packing factors.

**MAX for Power cable fill** – The maximum of electrical cables based on UL temperature rise test.

Raceway Type and Configuration	Fill Area (In. <sup>2</sup> )	Electrical Cables			Data Grade Cables	Data Grade Cables	Audio/Video	Fiber Optic Cable				
		14 AWG	12 AWG	10 AWG	24 AWG/UTP CM	24 AWG/UTP CM	RG6	2 Strand				
		THHN/T90			Cat 6. (4-pr.)	Augmented Cat. 6						
		0.111	0.130	0.164	DIA. = 0.250	DIA. = 0.330	DIA. = 0.275	DIA. = 0.175				
		FILL			FILL	FILL	FILL	FILL				
MAX	MAX	MAX	SPEC	MAX	SPEC	MAX	SPEC	MAX	SPEC	MAX		
(UL Temp Rise Test)			(40%)	(60%)	(40%)	(60%)	(40%)	(60%)	(40%)	(60%)		
1a. Twin-70: Power and data, no terminations.	2.05	—	—	—	16	25	9	14	13	20	34	51
1b. Twin-70: One channel no devices (data).	1.43	16	16	15	—	—	—	—	—	—	—	—
2. Twin-70: One channel no devices (data).	4.59	—	—	—	37	56	21	32	30	46	76	114
3. Twin-70: Data only (screw-on faceplate).	3.11	—	—	—	25	38	14	21	20	31	51	77
4. Twin-70: Power only (screw-on faceplate).	3.32	15	13	13	—	—	—	—	—	—	—	—
5. Twin-70: Data only (snap-on faceplate).	4.14	—	—	—	33	50	19	29	27	41	68	103
6. Twin-70: TVSS power (snap-on faceplate).	2.33	16	16	14	—	—	—	—	—	—	—	—

AWG dimensions represent typical outer cable diameter in inches.



## PAN-WAY® T-45 NON-METALLIC SURFACE RACEWAY

Pan-Way® T-45 Non-Metallic Surface Raceway is a multi-channel raceway which provides a solution for routing copper, fiber optic, and/or power cabling along fixed perimeter walls. T-45 surface raceway terminates using the T-45 hinged data and power brackets, T-45 offset box, and select Pan-Way® Surface Mount Outlet Boxes.



- Multi-directional cover hinge allows cable installation from either side
- Hinged data and power brackets provide easy access for terminating outlets
- Aesthetically pleasing
- Lightweight
- Tamper resistant
- Fittings maintain 1 inch bend radius control

Pan-Way® T-45 Surface Raceway accepts NEMA standard screw-on faceplates for superior Pan-Way® Snap-On Faceplates when terminating with the T-45 offset box and surface mount outlet boxes. Fittings for T-45 are available to transition to Pan-Way® LD Series Raceway.

A.  
System  
Overview

B1.  
Cable Ties

B2.  
Cable  
Accessories

B3.  
Stainless  
Steel Ties

C1.  
Wiring  
Duct

C2.  
Surface  
Raceway

C3.  
Abrasion  
Protection

C4.  
Cable  
Management

D1.  
Terminals

D2.  
Power  
Connectors

D3.  
Grounding  
Connectors

E1.  
Labeling  
Systems

E2.  
Labels

E3.  
Pre-Printed  
& Write-On  
Markers

E4.  
Permanent  
Identification

E5.  
Lockout/  
Tagout  
& Safety  
Solutions

F.  
Index

A.  
System  
Overview

B1.  
Cable Ties

B2.  
Cable  
Accessories

B3.  
Stainless  
Steel Ties

C1.  
Wiring  
Duct

C2.  
Surface  
Raceway

C3.  
Abrasion  
Protection

C4.  
Cable  
Management

D1.  
Terminals

D2.  
Power  
Connectors

D3.  
Grounding  
Connectors

E1.  
Labeling  
Systems

E2.  
Labels

E3.  
Pre-Printed  
& Write-On  
Markers

E4.  
Permanent  
Identification

E5.  
Lockout/  
Tagout  
& Safety  
Solutions

F.  
Index

## T-45 Raceway Roadmap

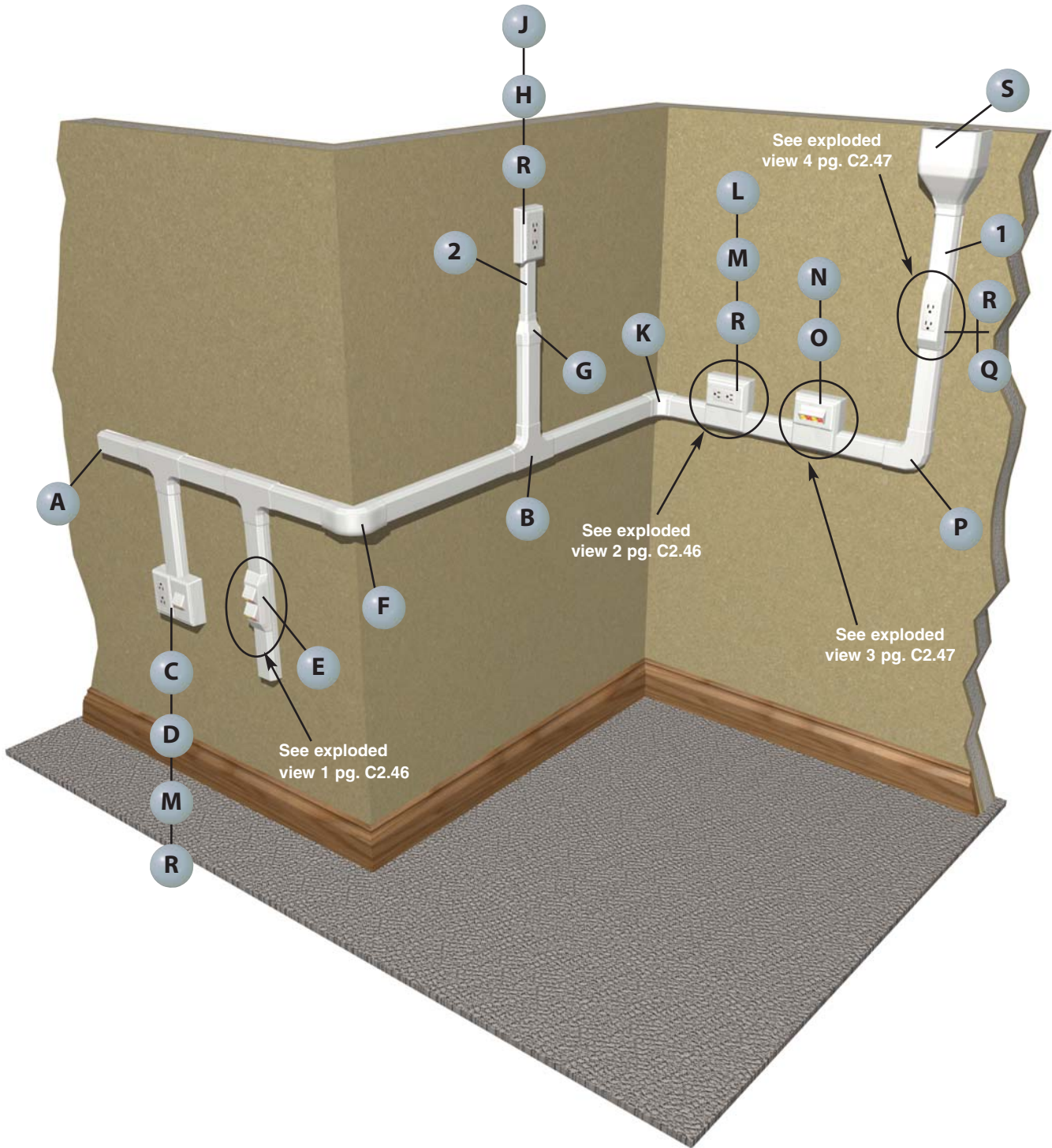

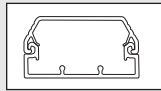

**1** T45B\*\* , T45C\*\* – T-45 Raceway Base and Cover (page C2.48)

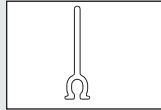

**1** T45DW\*\* – T-45 Divider Wall (page C2.48)

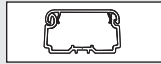

**2** LDPH10\*\* – LDPH Raceway (page C2.77)



**A** T45EC\*\* – T-45 End Cap Fitting (page C2.49)



**B** T45T\*\* and T45TD – T-45 Tee Fitting and Divider (page C2.49)

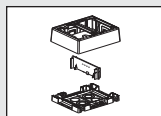

**C** JBP2FS\*\* – Fast-Snap™ Double Gang Power Rated Surface Mount Outlet Box (page C2.52)

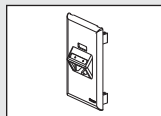

**D** UIT70FV2\*\* – Ultimate ID® Sloped Vertical Snap-On Faceplate (see SA-NCCB51)

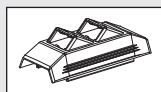

**E** T45HDB\*\* – T-45 Snap-On Hinged Data Bracket (page C2.49)

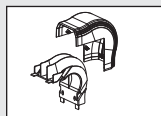

**F** T45OC\*\* – T-45 Outside Corner Fitting (page C2.49)

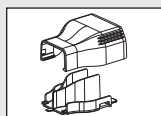

**G** T45RLD\*\* – T-45 Reducer Fitting (page C2.49)

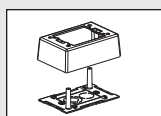

**H** JBP1\*\* – Power Rated Single Gang Two-Piece Box (page C2.58)

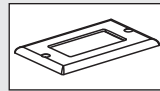

**J** CPG\*\* – Single Gang Rectangular Electrical/Communication Screw-On Faceplate (page C2.60)

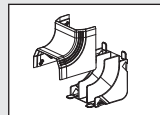

**K** T45IC\*\* – T-45 Inside Corner Fitting (page C2.49)

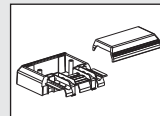

**L** T45WC\*\* – T-45 Offset Box for Screw-On Faceplates/Receptacles (page C2.49)

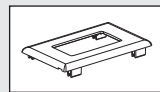

**M** T70PG\*\* – Single Gang Rectangular Electrical/Communication Snap-On Faceplate (page C2.53)

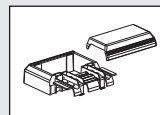

**N** T45WC2\*\* – T-45 Offset Box for Snap-On Faceplates (page C2.49)



**O** UIT70FH4\*\* – Ultimate ID® Sloped Horizontal Snap-On Faceplate (see SA-NCCB51)

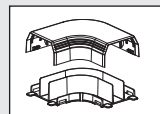

**P** T45RA\*\* – T-45 Right Angle Fitting (page C2.49)

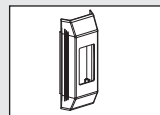

**Q** T45HEGB\*\* – T-45 Electrical Bracket (page C2.49)

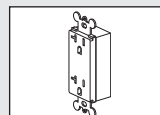

**R** ERU20\*\* – 20 A Rectangular Electrical Outlet (page C2.61)

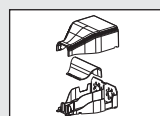

**S** T45EE\*\* – T-45 Entrance End Fitting (page C2.49)

A. System Overview

B1. Cable Ties

B2. Cable Accessories

B3. Stainless Steel Ties

C1. Wiring Duct

C2. Surface Raceway

C3. Abrasion Protection

C4. Cable Management

D1. Terminals

D2. Power Connectors

D3. Grounding Connectors

E1. Labeling Systems

E2. Labels

E3. Pre-Printed & Write-On Markers

E4. Permanent Identification

E5. Lockout/Tagout & Safety Solutions

F. Index

A.  
System  
Overview

## T-45 Configurations

B1.  
Cable Ties

### Exploded View 1

	Components Required	See page
A.	T45HDB = T-45 snap-on hinged data bracket.	C2.49
B.	Mini-Com® Modules.	—

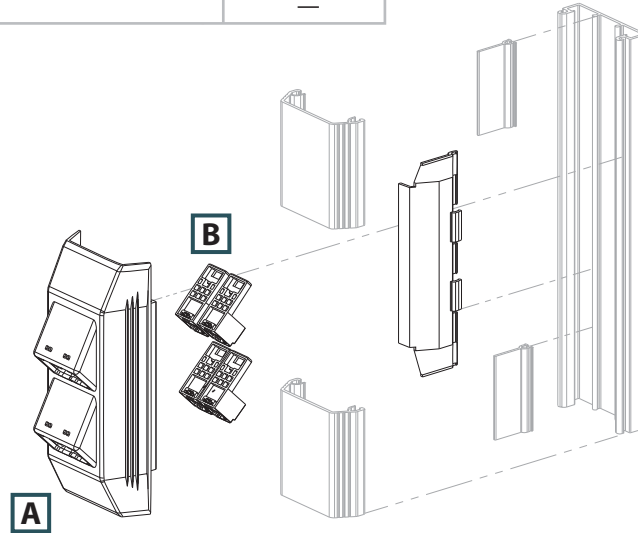

B3.  
Stainless  
Steel Ties

C1.  
Wiring  
Duct

C2.  
Surface  
Raceway

C3.  
Abrasion  
Protection

C4.  
Cable  
Management

### Exploded View 2

	Components Required	See page
A.	T70PG = Single gang rectangular electrical/communication snap-on faceplate.	C2.53
B.	ERU20 = 20 A rectangular electrical outlet (screws included).	C2.61
C.	T45WC = T-45 offset box for screw-on faceplates/receptacles.	C2.49

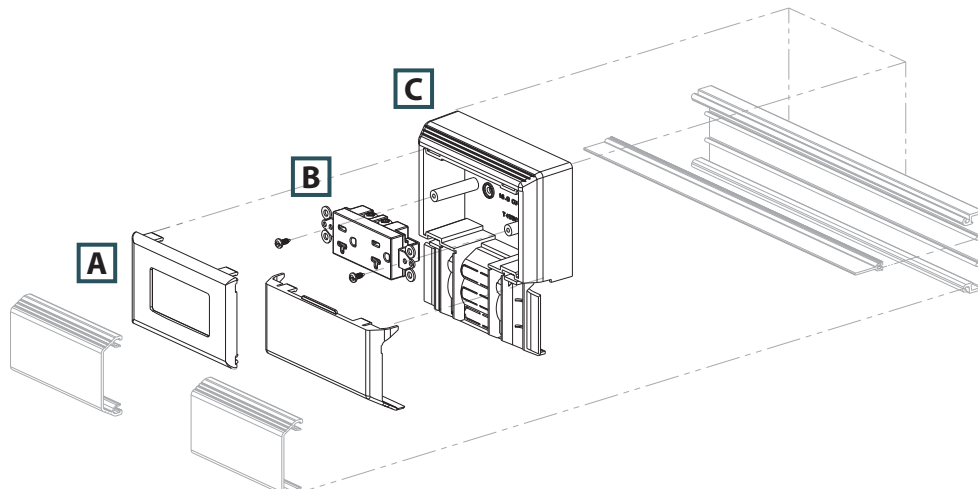

D1.  
Terminals

D2.  
Power  
Connectors

D3.  
Grounding  
Connectors

E1.  
Labeling  
Systems

E2.  
Labels

E3.  
Pre-Printed  
& Write-On  
Markers

E4.  
Permanent  
Identification

E5.  
Lockout/  
Tagout  
& Safety  
Solutions

F.  
Index

## T-45 Configurations (continued)

### Exploded View 3

	Components Required	See page
A.	UIT70FH4 = Ultimate ID® Sloped Horizontal Faceplates – 4-Port.	—
B.	Mini-Com® Modules.	—
C.	T45WC2 = T-45 offset box for snap-on faceplates.	C2.49

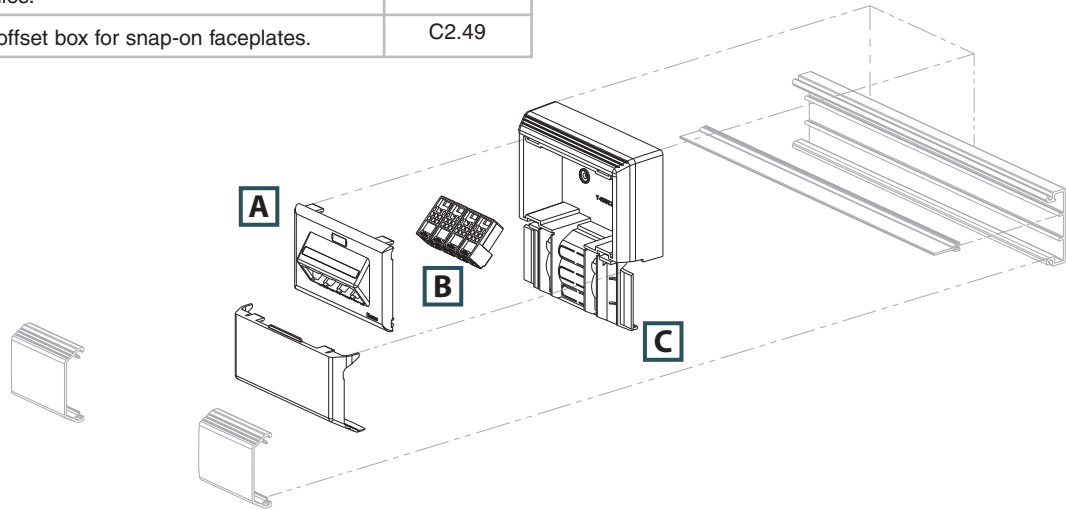

### Exploded View 4

	Components Required	See page
A.	T45HEGB = T-45 electrical bracket for rectangular outlet.	C2.49
B.	ERU20 = 20 A rectangular electrical outlet (screws included).	C2.61

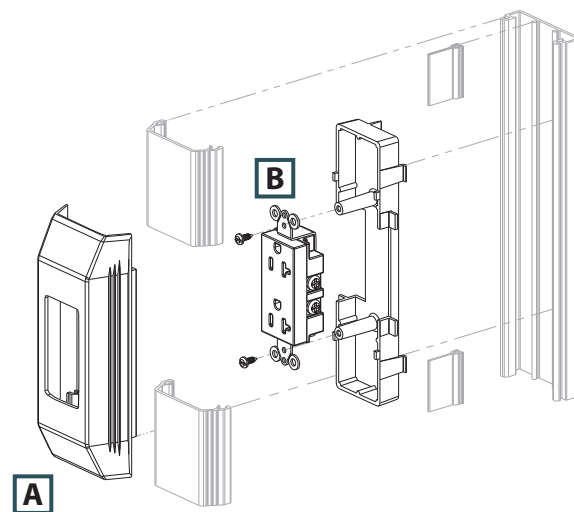

A.  
System  
Overview

B1.  
Cable Ties

B2.  
Cable  
Accessories

B3.  
Stainless  
Steel Ties

C1.  
Wiring  
Duct

C2.  
Surface  
Raceway

C3.  
Abrasion  
Protection

C4.  
Cable  
Management

D1.  
Terminals

D2.  
Power  
Connectors

D3.  
Grounding  
Connectors

E1.  
Labeling  
Systems

E2.  
Labels

E3.  
Pre-Printed  
& Write-On  
Markers

E4.  
Permanent  
Identification

E5.  
Lockout/  
Tagout  
& Safety  
Solutions

F.  
Index

A. System Overview



## Pan-Way® T-45 Surface Raceway System

B1. Cable Ties

- UL and CSA rated 600 V; meets UL 5A and CSA C22.2 No. 62.1-03 standards; FT4 rated
- Hinged cover allows easy access from either side
- Optional factory applied adhesive backing speeds installation

- Supplied with pre-punched mounting holes
- Tamper resistant
- Terminates using the T-45 hinged data or power brackets, offset box, or surface mount outlet box solutions

B2. Cable Accessories

B3. Stainless Steel Ties

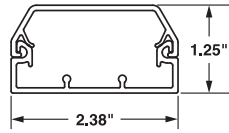

T-45  
Internal Area = 2.12 Sq. In.

C1. Wiring Duct



T45B

C2. Surface Raceway

C3. Abrasion Protection



T45C

C4. Cable Management

D1. Terminals

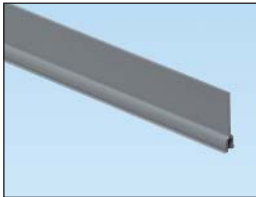

T45DW

D2. Power Connectors

D3. Grounding Connectors

E1. Labeling Systems

E2. Labels

E3. Pre-Printed & Write-On Markers

E4. Permanent Identification

E5. Lockout/Tagout & Safety Solutions

F. Index

Part Number	Part Description	Raceway Size	Color‡	Length (Ft.)	Std. Ctn. Qty.
<b>T-45 Raceway Base with Adhesive</b>					
<b>T45BIW8-A</b>	T-45 raceway base in 8' and 10' lengths with adhesive. Supplied with pre-punched mounting holes.	2.38" x 1.25" (60.3mm x 32.0mm)	Off White	8	160
<b>T45BIW10-A</b>				10	200
<b>T-45 Raceway Base without Adhesive</b>					
<b>T45BIW8</b>	T-45 raceway base in 8' and 10' lengths with adhesive. Supplied with pre-punched mounting holes.	2.38" x 1.25" (60.3mm x 32.0mm)	Off White	8	160
<b>T45BIW10</b>				10	200
<b>T-45 Raceway Cover</b>					
<b>T45CIW8</b>	T-45 raceway cover in 8' and 10' lengths. Can be hinged open on either side of T-45 base.	—	Off White	8	160
<b>T45CIW10</b>				10	200
<b>T-45 Raceway Divider Wall</b>					
<b>T45DW8</b>	T-45 divider wall. Snaps onto rails in T-45 raceway base to create separate channels. Must use wire retainers to ensure channel separation per UL/CSA. Available in 8' and 10' lengths.	—	Gray	8	0
<b>T45DW10</b>				10	200

‡For other colors replace IW (Off White) with EI (Electric Ivory) or BL (Black).  
Order base and cover separately.  
Order number of feet required in multiples of standard carton quantity.



## Pan-Way® T-45 Raceway Fittings

- T-45 fittings are designed to maintain the TIA/EIA-568-B and 569-B required minimum bend radius for high performance copper and fiber optic cabling systems



T45CC

T45RA

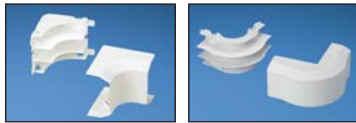

T45IC

T45OC

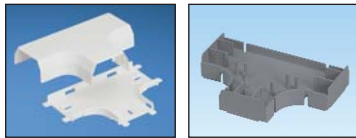

T45T

T45TD

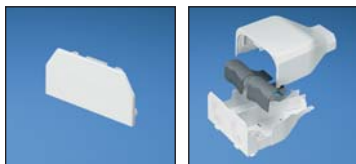

T45EC

T45EE



T45RLD

T45TRI

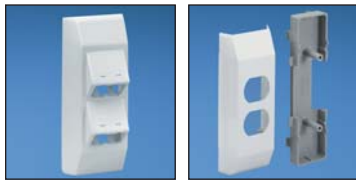

T45HDB

T45HEB

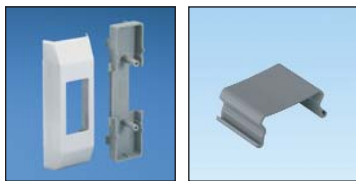

T45HEGB

T45WR-X



T45WC

T45WC2

Part Number	Part Description	Color‡	Std. Pkg. Qty.	Std. Ctn. Qty.
<b>T45CCIW-X</b>	Cover coupler fitting. Used to join two pieces of T-45 cover together.	Off White	10	100
<b>T45RAIW</b>	Right angle fitting. Used to join sections of T-45 raceway at 90° flat junction.	Off White	1	10
<b>T45ICIW</b>	Inside corner fitting. Used to join T-45 raceway at inside corner.	Off White	1	10
<b>T45OCIW</b>	Outside corner fitting. Used to join T-45 raceway at 90° outside corner.	Off White	1	10
<b>T45TIW</b>	Tee fitting. Used to join T-45 raceway at tee intersections.	Off White	1	10
<b>T45TD</b>	Divided insert. Used to separate power and data within the T45T.	Gray	1	10
<b>T45ECIW</b>	End cap fitting. Used to terminate T-45 raceway.	Off White	1	10
<b>T45EEIW</b>	Entrance end fitting. With knockouts for 1/2", 3/4", 1" and 1 1/4" conduit which allows entry from ceiling or wall.	Off White	1	10
<b>T45RLDIW</b>	Reducer fitting. Reduces from T-45 to LD10 profile raceway.	Off White	1	10
<b>T45TRI</b>	Provides bend radius control at transition from T-70 to T-45 when used with T70TR.	Gray	1	10
<b>T45HDBIW</b>	Snap-on hinged data bracket. Used for mounting Panduit® Mini-Com® Modules vertically inline within T-45 raceway. Can be hinged opened on either side of T-45 base.	Off White	1	10
<b>T45HEBIW</b>	Electrical bracket and box. Used for mounting standard duplex electrical outlets.	Off White	1	10
<b>T45HEGBIW</b>	Electrical bracket and box. Used for mounting standard rectangular style electrical outlets.	Off White	1	10
<b>T45WR-X</b>	Wire retainers. Used to hold wires in place during installation.	Gray	10	100
<b>T45WCIW</b>	Offset box. Allows for the mounting of any standard electrical or communication outlet offset from the raceway channel. Box accepts any NEMA standard screw-on faceplate or Pan-Way® Electrical Snap-On Faceplates.	Off White	1	10
<b>T45WC2IW</b>	Offset box. Box accepts any Pan-Way® Communication Snap-On Faceplates.	Off White	1	10

‡For other colors replace IW (Off White) with EI (Electric Ivory) or BL (Black). T45TD, T45TRI, and T45WR-X available in Gray only.

A. System Overview

B1. Cable Ties

B2. Cable Accessories

B3. Stainless Steel Ties

C1. Wiring Duct

C2. Surface Raceway

C3. Abrasion Protection

C4. Cable Management

D1. Terminals

D2. Power Connectors

D3. Grounding Connectors

E1. Labeling Systems

E2. Labels

E3. Pre-Printed & Write-On Markers

E4. Permanent Identification

E5. Lockout/Tagout & Safety Solutions

F. Index

A. System Overview

## Cable Fill Capacities for T-45 Raceway

This information is to be used as a guide in selecting the proper size raceway. The maximum amounts may vary according to the cable installation methods, straightness of cables, etc.

B1. Cable Ties

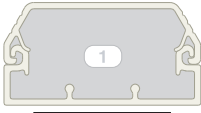

A = 2.13 in.<sup>2</sup>

**Cable fill #1:** T-45 with no devices.

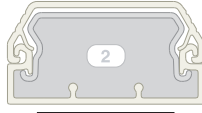

A = 1.72 in.<sup>2</sup>

**Cable fill #2:** T-45 with wire retainer.

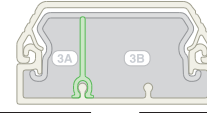

A = 0.44 in.<sup>2</sup>

B = 1.20 in.<sup>2</sup>

**Cable fill #3:** Power and data using a wire retainer and divider wall.

B2. Cable Accessories

B3. Stainless Steel Ties

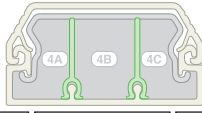

A = 0.44 in.<sup>2</sup> B = 0.68 in.<sup>2</sup> C = 0.44 in.<sup>2</sup>

**Cable fill #4:** Power and data using a wire retainer and divider walls.

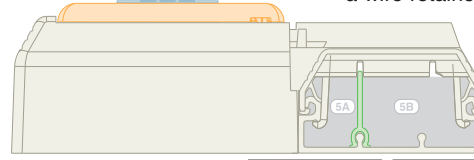

A = 0.41 in.<sup>2</sup>

B = 1.06 in.<sup>2</sup>

**Cable fill #5:** Power and data using the offset box.

C1. Wiring Duct

C2. Surface Raceway

C3. Abrasion Protection

C4. Cable Management

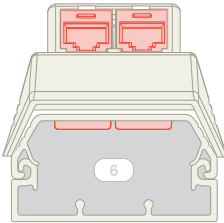

A = 2.00 in.<sup>2</sup>

**Cable fill #6:** Data only using hinged data bracket.

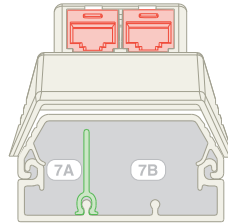

A = 0.52 in.<sup>2</sup>

B = 1.20 in.<sup>2</sup>

**Cable fill #7:** Power and data using hinged data bracket with divider insert.

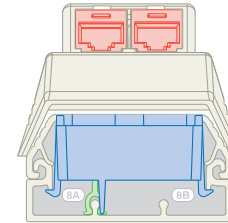

A = 0.22 in.<sup>2</sup>

B = 0.50 in.<sup>2</sup>

**Cable fill #8:** Power and data using electrical bracket/box and hinged data bracket.

D1. Terminals

D2. Power Connectors

D3. Grounding Connectors

E1. Labeling Systems

E2. Labels

E3. Pre-Printed & Write-On Markers

E4. Permanent Identification

E5. Lockout/Tagout & Safety Solutions

F. Index

**SPEC = 40% cable fill** – The recommended design in cable capacity, leaves room for future moves, adds, and changes.

**MAX for Data = 60% cable fill** – The maximum cable quantity based on cable interweaving and packing factors.

**MAX for Power cable fill** – The maximum of electrical cables based on UL temperature rise test.

Raceway Type and Configuration	Fill Area (In. <sup>2</sup> )	Electrical Cables			Data Grade Cables		Data Grade Cables		Audio/Video		Fiber Optic Cable	
		14 AWG	12 AWG	10 AWG	23/24 AWG/UTP	23 AWG/UTP CM	RG6		2 Strand			
		THHN/T90			Cat 6. (4-pr.)		Augmented Cat. 6					
		0.111	0.130	0.164	DIA. = .250		DIA. = .354		DIA. = .275		DIA. = .175	
		FILL			FILL		FILL		FILL		FILL	
MAX	MAX	MAX	SPEC	MAX	SPEC	MAX	SPEC	MAX	SPEC	MAX	MAX	
(UL Temp Rise Test)			(40%)	(60%)	(40%)	(60%)	(40%)	(60%)	(40%)	(60%)	(40%)	(60%)
1. T-45: No devices.	2.13	36	27	25	17	26	9	14	14	21	35	53
2. T-45: No devices with wire retainer.	1.72	36	27	25	14	21	8	12	11	17	28	42
3A. T-45: Power and data with wire retainer and divider wall	0.44	12	11	8	—	—	—	—	—	—	—	—
3B. (2 channels).	1.20	—	—	—	9	14	5	8	8	12	19	29
4A. T-45: Power and data with wire retainer and two divider walls (three channels).	0.44	12	11	8	3	5	2	3	2	4	7	10
4B.	0.68	—	—	—	5	8	3	4	4	6	11	16
4C.	0.44	—	—	—	3	5	2	3	2	4	7	10
5A. T-45: Power and data using the offset box.	0.41	12	11	8	—	—	—	—	—	—	—	—
5B.	1.06	—	—	—	8	12	4	7	7	10	17	26
6. T-45: Data only using data bracket.	2.00	—	—	—	16	24	9	14	13	20	33	49
7A. T-45: Power and data using hinged data bracket with divider insert.	0.52	12	11	8	—	—	—	—	—	—	—	—
7B.	1.20	—	—	—	9	14	5	8	8	12	19	29
8A. T-45: Power and data using electrical bracket and box.	0.22	9	7	4	—	—	—	—	—	—	—	—
8B.	0.50	—	—	—	4	6	2	3	3	5	8	12

AWG dimensions represent typical outer cable diameter in inches.



## PAN-WAY® SNAP-ON FACEPLATES AND SURFACE MOUNT OUTLET BOXES

Pan-Way® Snap-On Faceplates are designed for use with Panduit surface raceway systems and install faster than conventional screw-on faceplates, reducing labor costs and providing a more aesthetic appearance. Pan-Way® Snap-On Communication Faceplates are available in vertical and horizontal orientation and accept Panduit® Mini-Com® Copper and Fiber Optic Modules. Electrical outlets are available in colors to complement Panduit raceway and are available in 20 A, 106 duplex, rectangular, TVSS and GFCI.



- Snap-on faceplates install without the use of screws providing faster installation and superior aesthetics
- Fast-Snap™ Boxes assemble without the use of screws and accept Pan-Way® Snap-On Faceplates
- Snap-on communication faceplates are available in horizontal or vertical sloped outlet configurations
- Snap-on electrical faceplates are available in 106 duplex or rectangular styles

Surface mount outlet boxes are available for both power and communication applications. They are compatible with Pan-Way® LD, LDPH, LD2P10 and T-45 Raceway Systems. Pan-Way® Snap-On Faceplates mount directly to Cove, TG-70, T-70, Twin-70 raceways, Pan-Way® Fast-Snap™ Boxes and Pan-Pole™ Aluminum Outlet Poles.

A.  
System  
Overview

B1.  
Cable Ties

B2.  
Cable  
Accessories

B3.  
Stainless  
Steel Ties

C1.  
Wiring  
Duct

C2.  
Surface  
Raceway

C3.  
Abrasion  
Protection

C4.  
Cable  
Management

D1.  
Terminals

D2.  
Power  
Connectors

D3.  
Grounding  
Connectors

E1.  
Labeling  
Systems

E2.  
Labels

E3.  
Pre-Printed  
& Write-On  
Markers

E4.  
Permanent  
Identification

E5.  
Lockout/  
Tagout  
& Safety  
Solutions

F.  
Index

A. System Overview



## Pan-Way® Fast-Snap™ Surface Mount Outlet Boxes

B1. Cable Ties

- JB1FS and JBP2FS assemble without the use of screws for faster installation
- JB1FS and JBP2FS are supplied with adhesive backing to speed installation

- JB1FS and JBP2FS accept Pan-Way® Snap-on Faceplates for superior aesthetics

B2. Cable Accessories



JB1FS\*\*-A



JBP1FS\*\*

B3. Stainless Steel Ties

C1. Wiring Duct



JBP2FS\*\*

C2. Surface Raceway

C3. Abrasion Protection

C4. Cable Management



## Pan-Way® Classic Series Snap-On Faceplates for Use with Panduit® Mini-Com® Modules

- Can be used with Pan-Way® Cove, TG-70, T-70, Twin-70, T-45 Raceway Systems, Fast-Snap™ Outlet Boxes and Pan-Pole™ Aluminum Outlet Pole

D1. Terminals



T70FH2



T70FH4

D2. Power Connectors

D3. Grounding Connectors



T70FV2



T70FV4

E1. Labeling Systems

E2. Labels

E3. Pre-Printed & Write-On Markers

E4. Permanent Identification

E5. Lockout/Tagout & Safety Solutions

F. Index

Part Number	Part Description	Color‡	Std. Pkg. Qty.	Std. Ctn. Qty.
<b>JB1FSIW-A</b>	Single gang two-piece snap together outlet box with adhesive backing. Box accepts Pan-Way® Snap-On Faceplates. For use with Pan-Way® T-45 or LD profile raceway. 5.00"L x 3.26"W x 1.62"H (127.1mm x 82.7mm x 41.1mm). Breakouts for 1/2", 3/4", or 1" diameter conduit.	Off White	1	10
<b>JBP1FSIW</b>	Single gang power rated two-piece snap together outlet box. Box accepts Pan-Way® Snap-On Faceplates. For use with Pan-Way® T-45 or LD, LDP, LDPH, LDS profile raceways. 5.00"L x 3.26"W x 1.62"H (127.1mm x 82.7mm x 41.1mm). Breakouts for 1/2", 3/4", or 1" diameter conduit.	Off White	1	10
<b>JBP2FSIW</b>	Double gang power rated two-piece snap together outlet box. Box accepts Pan-Way® Snap-On Faceplates. For use with Pan-Way® T-45 or LD profile raceway. 5.00"L x 6.14"W x 1.62"H (127.1mm x 155.9mm x 41.1mm). Breakouts for 1/2", 3/4", or 1" diameter conduit.	Off White	1	10

‡For other colors replace IW (Off White) with EI (Electric Ivory), IG (International Gray), or WH (White). For complete labeling solutions and product information, reference chart below.



Part Number	Part Description	Color‡	Std. Pkg. Qty.	Std. Ctn. Qty.
<b>T70FH2IW</b>	Snap-on horizontal sloped communication faceplate. Accepts two Panduit® Mini-Com® Modules (not included). No additional mounting hardware required.	Off White	1	10
<b>T70FH4IW</b>	Snap-on horizontal sloped communication faceplate. Accepts four Panduit® Mini-Com® Modules (not included). No additional mounting hardware required.	Off White	1	10
<b>T70FV2IW</b>	Snap-on vertical sloped communication faceplate. Accepts two Panduit® Mini-Com® Modules (not included). No additional mounting hardware required.	Off White	1	10
<b>T70FV4IW</b>	Snap-on vertical sloped communication faceplate. Accepts four Panduit® Mini-Com® Modules (not included). No additional mounting hardware required.	Off White	1	10

‡For other colors replace IW (Off White) with EI (Electric Ivory), IG (International Gray), or WH (White). For complete labeling solutions and product information, reference chart below.

## Component Labels for Pan-Way® Classic Series Snap-On Faceplates for Use with Panduit® Mini-Com® Modules and Inserts

### Suggested Label Solutions for TIA/EIA-606-A Compliance

Faceplate Part Number	Laser/Ink Jet Desktop Printer Label	TDP43MY Thermal Transfer Desktop Printer Label	PanTher™ LS8E Hand-Held Printer Label	Cougar™ LS9 Hand-Held Printer Label
T70FH2IW	C125X030FJJ	C125X030YPT	C125X030FJC	T031X000FJC-BK
T70FV2IW				
T70FV4IW				
All T70B Parts				
T70FH4IW	C252X030FJJ	C252X030YPT	C252X030FJC	T031X000FJC-BK



## Pan-Way® Classic Series Snap-On Faceplates for Use with Panduit® Mini-Com® Inserts

- Single gang vertical or horizontal sloped communication faceplates accept one or two Panduit® Mini-Com® Inserts
- Can be used with Pan-Way® Cove, TG-70, T-70, Twin-70, T-45 Raceway Systems, Fast-Snap™ Outlet Boxes and Pan-Pole™ Aluminum Outlet Pole



T70BH1



T70BH2



T70B1



T70B2

Part Number	Part Description	Color‡	Std. Pkg. Qty.	Std. Ctn. Qty.
<b>T70BH1IW</b>	Snap-on horizontal communication faceplate. Accepts one 1/2-size Panduit® Mini-Com® Insert and two modules. No additional mounting hardware required.	Off White	1	10
<b>T70BH2IW</b>	Snap-on horizontal communication faceplate. Accepts two 1/2-size Panduit® Mini-Com® Inserts and four modules. No additional mounting hardware required.	Off White	1	10
<b>T70B1IW</b>	Snap-on vertical communication faceplate. Holds one 1/2-size Panduit® Mini-Com® Insert and two modules. No additional mounting hardware required.	Off White	1	10
<b>T70B2IW</b>	Snap-on vertical communication faceplate. Holds two 1/2-size Panduit® Mini-Com® Inserts and four modules. No additional mounting hardware required.	Off White	1	10

‡For other colors replace IW (Off White) with EI (Electric Ivory), IG (International Gray), or WH (White). For complete labeling solutions and product information, reference chart on previous page.



## Pan-Way® Classic Series Snap-On Faceplates for Communication/Power

- Can be used with Pan-Way® Cove, TG-70, T-70, Twin-70, T-45 Raceway Systems, Fast-Snap™ Outlet Boxes and Pan-Pole™ Aluminum Outlet Pole



T70P



T70PG



T70PS



T70PGS



T70PN

Part Number	Part Description	Color‡	Std. Pkg. Qty.	Std. Ctn. Qty.
<b>T70PIW</b>	Snap-on single gang 106 duplex electrical/communication faceplate. Used to cover one NEMA standard 106 duplex electrical outlet. In communication applications, covers one standard 106 duplex communication module frame.	Off White	1	10
<b>T70PGIW</b>	Snap-on single gang rectangular electrical/communication faceplate. Used to cover one NEMA standard rectangular electrical outlet. In communication applications, covers one standard rectangular communication module frame.	Off White	1	10
<b>T70PSIW</b>	Snap-on single gang 106 duplex communication faceplate. Used to cover one NEMA standard 106 duplex communication module frame. Module frame screw mounts directly to underside of snap-on faceplate. No mounting device needed. Supplied with one mounting screw. Note: Not for use with electrical devices.	Off White	1	10
<b>T70PGSIW</b>	Snap-on single gang rectangular communication faceplate. Used to cover one NEMA standard rectangular communication module frame. Module frame screw mounts directly to underside of snap-on faceplate. No mounting device needed. Supplied with two mounting screws. Note: Not for use with electrical devices.	Off White	1	10
<b>T70PNIW</b>	Snap-on single gang blank cover faceplate.	Off White	1	10

‡For other colors replace IW (Off White) with EI (Electric Ivory), IG (International Gray), or WH (White). Component Labels for Pan-Way® Classic Series Snap-On Faceplates for Communication and Power, please reference pg. C2.59.

A. System Overview

B1. Cable Ties

B2. Cable Accessories

B3. Stainless Steel Ties

C1. Wiring Duct

C2. Surface Raceway

C3. Abrasion Protection

C4. Cable Management

D1. Terminals

D2. Power Connectors

D3. Grounding Connectors

E1. Labeling Systems

E2. Labels

E3. Pre-Printed & Write-On Markers

E4. Permanent Identification

E5. Lockout/Tagout & Safety Solutions

F. Index

A. System Overview



## Panduit® NetKey® Snap-On Sloped Keystone Faceplates

B1. Cable Ties

- Accept all Panduit® NetKey® Keystone Copper Modules and Duplex Fiber Optic Modules
- Snap into raceway channel, requires no additional mounting hardware or adapters – greatly reducing installation time
- Lowest cost for moves, adds, and changes

- Tamper resistant
- Can be used with Pan-Way® Cove, TG-70, T70, Twin-70, T-45 Raceway Systems, Fast-Snap™ Outlet Boxes, and Pan-Pole™ Aluminum Outlet Poles

B2. Cable Accessories

B3. Stainless Steel Ties



NK2HSRF

NK4HSRF

C1. Wiring Duct



NK4VSRF

C2. Surface Raceway

C3. Abrasion Protection

C4. Cable Management

Part Number	Part Description	Color‡	Std. Pkg. Qty.	Std. Ctn. Qty.
<b>NK2HSRFIW</b>	Snap-on 2-position sloped horizontal faceplate accepts any Panduit® NetKey® Module. Compatible with Panduit® NetKey® Outlet Boxes, Surface Raceway Systems, and Pan-Pole™ Outlet Poles.	Off White	1	10
<b>NK4HSRFIW</b>	Snap-on 4-position sloped horizontal faceplate accepts any Panduit® NetKey® Module. Compatible with Panduit® NetKey® Outlet Boxes, Surface Raceway Systems, and Pan-Pole™ Outlet Poles.	Off White	1	10
<b>NK4VSRFIW</b>	Snap-on 4-position sloped vertical faceplate accepts any Panduit® NetKey® Module. Compatible with Panduit® NetKey® Outlet Boxes, Surface Raceway Systems, and Pan-Pole™ Outlet Poles.	Off White	1	10

Panduit® NetKey® faceplates are NOT compatible with Panduit® Mini-Com® Modules.

‡For other colors replace IW (Off White) with EI (Electric Ivory), IG (International Gray), or WH (White).

For complete labeling solutions, reference chart below.

D1. Terminals



## Panduit® NetKey® Snap-On Flush Universal Keystone Faceplates

- Wider module spacing to accept common manufacturers' keystone modules .900 inches wide or less

- Can be used with Pan-Way® Cove, TG-70, T70, Twin-70, T-45 Raceway Systems, Fast-Snap™ Outlet Boxes, and Pan-Pole™ Aluminum Outlet Poles

D2. Power Connectors



T70KW2

T70KW4

D3. Grounding Connectors

E1. Labeling Systems

E2. Labels

E3. Pre-Printed & Write-On Markers

E4. Permanent Identification

E5. Lockout/Tagout & Safety Solutions

F. Index

Part Number	Part Description	Color‡	Std. Pkg. Qty.	Std. Ctn. Qty.
<b>T70KW2IW</b>	Snap-on 2-position flush mount faceplate accepts any Panduit® NetKey® Module and most other manufacturers' keystone modules. Compatible with Panduit® Fast-Snap™ Outlet Boxes, Surface Raceway Systems, and Pan-Pole™ Outlet Poles.	Off White	1	10
<b>T70KW4IW</b>	Snap-on 4-position flush mount faceplate accepts any Panduit® NetKey® Module and most other manufacturers' keystone modules. Compatible with Panduit® Fast-Snap™ Outlet Boxes, Surface Raceway Systems, and Pan-Pole™ Outlet Poles.	Off White	1	10

Panduit® NetKey® faceplates are NOT compatible with Panduit® Mini-Com® Modules.

‡For other colors replace IW (Off White) with EI (Electric Ivory), IG (International Gray), or WH (White).

For complete labeling solutions, reference chart below.

### Component Labels for Snap-On “Sloped” (Keystone) Faceplates and Snap-On “Flush” Universal (Keystone) Faceplates

Suggested Label Solutions for TIA/EIA-606-A Compliance			
Faceplate Part Number	Laser/Ink Jet Desktop Printer Label	PanTher™ LS8E Hand-Held Printer Label	Cougar™ LS9 Hand-Held Printer Label
<b>NK2HSRFIW</b> <b>T70KW2IW</b>	<b>C125X030FJJ</b>	<b>C125X030FJC</b>	<b>T031X000FJC-BK</b>
<b>NK4VSRFIW</b>	<b>2-C125X030FJJ</b>	<b>2-C125X030FJC</b>	
<b>NK4HSRFIW</b> <b>T70KW4IW</b>	<b>C261X030FJJ</b>	<b>C125X030FJC</b>	



## Pan-Way® Snap-On Faceplates for SYSTIMAX® Communication Modules

- Can be used with Pan-Way® Cove, TG-70, T70, Twin-70, T-45 Raceway Systems, Fast-Snap™ Outlet Boxes, and Pan-Pole™ Aluminum Outlet Poles



T70L2



T70L4



T70LV2



T70LV4

Part Number	Part Description	Color‡	Std. Pkg. Qty.	Std. Ctn. Qty.
<b>T70L2IW</b>	Snap-on horizontal communication faceplate designed to accept two SYSTIMAX® communication modules (not included). Can be used with Panduit surface raceway systems and boxes that accept 70mm faceplates. No additional mounting hardware required.	Off White	1	10
<b>T70L4IW</b>	Snap-on horizontal communication faceplate designed to accept four SYSTIMAX® communication modules (not included). Can be used with Panduit surface raceway systems and boxes that accept 70mm faceplates. No additional mounting hardware required.	Off White	1	10
<b>T70LV2IW</b>	Snap-on vertical communication faceplate designed to accept two SYSTIMAX® communication modules (not included). Can be used with Panduit surface raceway systems and boxes that accept 70mm faceplates. No additional mounting hardware required.	Off White	1	10
<b>T70LV4IW</b>	Snap-on vertical communication faceplate designed to accept four SYSTIMAX® communication modules (not included). Can be used with Panduit surface raceway systems and boxes that accept 70mm faceplates. No additional mounting hardware required.	Off White	1	10

‡For other colors replace IW (Off White) with EI (Electric Ivory), IG (International Gray), or WH (White).  
 \*SYSTIMAX is a registered trademark of Commscope, Inc.  
 For complete labeling solutions, reference chart below.

### Component Labels for Pan-Way® Snap-On Faceplates for use with SYSTIMAX® Communication Modules

Faceplate Part Number	Suggested Label Solutions for TIA/EIA-606-A Compliance		
	Laser/Ink Jet Desktop Printer Label	PanTher™ LS8E Hand-Held Printer Label	Cougar™ LS9 Hand-Held Printer Label
T70L2IW T70LV2IW	C125X030FJJ	C125X030FJC	T031X000FJC-BK
T70LV4IW	2-C125X030FJJ	2-C125X030FJC	
T70L4IW	C261X030FJJ	C125X030FJC	

\*SYSTIMAX is a registered trademark of Commscope, Inc.

A. System Overview

B1. Cable Ties

B2. Cable Accessories

B3. Stainless Steel Ties

C1. Wiring Duct

C2. Surface Raceway

C3. Abrasion Protection

C4. Cable Management

D1. Terminals

D2. Power Connectors

D3. Grounding Connectors

E1. Labeling Systems

E2. Labels

E3. Pre-Printed & Write-On Markers

E4. Permanent Identification

E5. Lockout/Tagout & Safety Solutions

F. Index

A. System Overview



## Pan-Way® Snap-On Faceplates for Nordx/CDT\* Communication Modules

B1. Cable Ties

- Can be used with Pan-Way® Cove, TG-70, T70, Twin-70, T-45 Raceway Systems, Fast-Snap™ Outlet Boxes, and Pan-Pole™ Aluminum Outlet Poles

B2. Cable Accessories



T70N2

B3. Stainless Steel Ties



T70N4

C1. Wiring Duct

C2. Surface Raceway



T70NV2

C3. Abrasion Protection

C4. Cable Management



T70NV4

D1. Terminals

D2. Power Connectors

D3. Grounding Connectors

E1. Labeling Systems

E2. Labels

E3. Pre-Printed & Write-On Markers

E4. Permanent Identification

E5. Lockout/Tagout & Safety Solutions

F. Index

Part Number	Part Description	Color‡	Std. Pkg. Qty.	Std. Ctn. Qty.
<b>T70N2IW</b>	Snap-on horizontal communication faceplate designed to accept two Nordx/CDT* communication modules (not included). Can be used with Panduit surface raceway systems and boxes that accept 70mm faceplates. No additional mounting hardware required.	Off White	1	10
<b>T70N4IW</b>	Snap-on horizontal communication faceplate designed to accept four Nordx/CDT* communication modules (not included). Can be used with Panduit surface raceway systems and boxes that accept 70mm faceplates. No additional mounting hardware required.	Off White	1	10
<b>T70NV2IW</b>	Snap-on vertical communication faceplate designed to accept two Nordx/CDT* communication modules (not included). Can be used with Panduit surface raceway systems and boxes that accept 70mm faceplates. No additional mounting hardware required.	Off White	1	10
<b>T70NV4IW</b>	Snap-on vertical communication faceplate designed to accept two Nordx/CDT* communication modules (not included). Can be used with Panduit surface raceway systems and boxes that accept 70mm faceplates. No additional mounting hardware required.	Off White	1	10

‡For other colors replace IW (Off White) with EI (Electric Ivory).

\*Nordx/CDT is a registered trademark of Nordx/CDT, Inc.

For complete labeling solutions, reference chart below.

### Component Labels for Pan-Way® Snap-On Faceplates for use with Nordx/CDT\* Communication Modules

Suggested Label Solutions for TIA/EIA-606-A Compliance			
Faceplate Part Number	Laser/Ink Jet Desktop Printer Label	PanTher™ LS8E Hand-Held Printer Label	Cougar™ LS9 Hand-Held Printer Label
T70N2IW T70NV2IW	C125X030FJJ	C125X030FJC	T031X000FJC-BK
T70NV4IW	2-C125X030FJJ	2-C125X030FJC	
T70N4IW	C261X030FJJ	C125X030FJC	

\*Nordx/CDT is a registered trademark of Nordx/CDT, Inc.

For complete labeling solutions, reference charts on pages E2.4 and E2.5.



## Pan-Way® Low Voltage Surface Mount Outlet Boxes

- JBX3510 assembles without the use of screws for faster installation
- JB1 and JB1D are a one-piece design requiring no assembly
- JBX3510, JB1, and JB1D are supplied with adhesive backing to speed installation



**JBX3510\*\*-A**



**JB1\*\*-A**

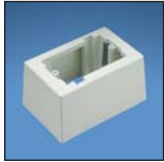

**JB1D\*\*-A**



**JBP2**



**JBP2D**



**RJBX3510**



**JBA-X**



**JB1FS\*\*-A**

Part Number	Part Description	Color‡	Std. Pkg. Qty.	Std. Ctn. Qty.
<b>JBX3510IW-A</b>	Single gang two-piece snap together outlet box with adhesive backing. Box accepts Pan-Way® Screw-On Faceplates or any NEMA standard single gang faceplate. For use with Pan-Way® T45 or LD profile raceway. 5.00"L x 3.26"W x 1.62"H (127.1mm x 82.7mm x 41.1mm). Breakouts for 1/2", 3/4", or 1" diameter conduit.	Off White	1	10
<b>JB1IW-A</b>	Single gang one-piece outlet box with adhesive backing. Box accepts Pan-Way® Screw-On Faceplates or any NEMA standard single gang faceplate. For use with Pan-Way® LD profile raceway. 5.09"L x 3.34"W x 1.75"H (129.4mm x 85.0mm x 44.4mm). Breakouts for 1/2", 3/4", or 1" diameter conduit.	Off White	1	10
<b>JB1DIW-A</b>	Single gang one-piece deep outlet box with adhesive backing. Box accepts Pan-Way® Screw-On Faceplates or any NEMA standard single gang faceplate. For use with Pan-Way® LD profile raceway. 5.23"L x 3.48"W x 2.75"H (133.0mm x 88.5mm x 69.8mm). Breakouts for 1/2", 3/4", or 1" diameter conduit.	Off White	1	10
<b>JBP2IW</b>	Double gang two-piece screw together outlet box. Box accepts Pan-Way® Screw-On Faceplates or any NEMA standard double gang faceplates. For use with Pan-Way® LD profile raceway. 5.05"L x 5.05"W x 1.62"H (128.2mm x 128.2mm x 41.1mm). Breakouts for 1/2" or 3/4" diameter conduit.	Off White	1	10
<b>JBP2DIW</b>	Double gang two-piece screw together deep outlet box. Box accepts Pan-Way® Screw-On Faceplates or any NEMA standard double gang faceplate. For use with Pan-Way® T-45 or LD profile raceway. 5.19"L x 5.19"W x 2.75"H (131.9mm x 131.9mm x 69.8mm). Breakouts for 1/2", 3/4", or 1" diameter conduit.	Off White	1	10
<b>RJBX3510IW</b>	Single gang two-piece screw together round outlet box. Box accepts UL/CSA devices not to exceed 10 lbs. (5 lbs. per CSA). For use with Pan-Way® LD profile raceway. Dia. = 5.48"D x 1.14"H (139.2mm x 29.0mm). Breakouts for 3/4" or 1" diameter conduit.	Off White	1	5
<b>JBA-X</b>	In-wall box adapter. Adapts single gang surface mount outlet boxes to in-wall conduit boxes.	—	10	100
<b>JB1FSIW-A</b>	Single gang two-piece snap together outlet box with adhesive backing. Box accepts Pan-Way® Snap-On Faceplates. For use with Pan-Way® T-45 or LD profile raceway. 5.00"L x 3.26"W x 1.62"H (127.1mm x 82.7mm x 41.1mm). Breakouts for 1/2", 3/4", or 1" diameter conduit.	Off White	1	10

‡For other colors replace IW (Off White) with EI (Electric Ivory), IG (International Gray), or WH (White).

A. System Overview

B1. Cable Ties

B2. Cable Accessories

B3. Stainless Steel Ties

C1. Wiring Duct

C2. Surface Raceway

C3. Abrasion Protection

C4. Cable Management

D1. Terminals

D2. Power Connectors

D3. Grounding Connectors

E1. Labeling Systems

E2. Labels

E3. Pre-Printed & Write-On Markers

E4. Permanent Identification

E5. Lockout/Tagout & Safety Solutions

F. Index

A. System Overview



## Pan-Way® Power Rated Surface Mount Outlet Boxes

B1. Cable Ties

- JBP1FS and JBP2FS assemble without the use of screws for faster installation
- JBP1FS and JBP2FS are supplied with adhesive backing to speed installation
- JBP1FS and JBP2FS accept Pan-Way® Snap-on Faceplates for superior aesthetics

B2. Cable Accessories

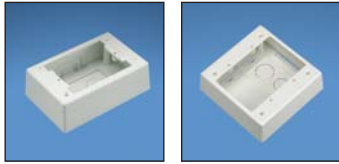

JBP1

JBP2

B3. Stainless Steel Ties

C1. Wiring Duct

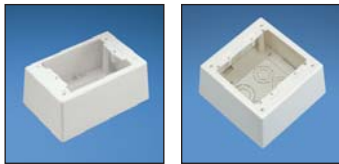

JBP1D

JBP2D

C2. Surface Raceway

C3. Abrasion Protection



JBP1E

JBP1I

C4. Cable Management

D1. Terminals

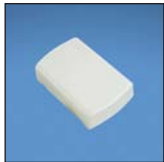

PSJBX

D2. Power Connectors

D3. Grounding Connectors

E1. Labeling Systems

E2. Labels

E3. Pre-Printed & Write-On Markers

E4. Permanent Identification

E5. Lockout/Tagout & Safety Solutions

F. Index

Part Number	Part Description	Color‡	Std. Pkg. Qty.	Std. Ctn. Qty.
<b>JBP1IW</b>	Single gang two-piece screw together outlet box. Box accepts Pan-Way® Screw-On Faceplates or any NEMA standard single gang faceplate. For use with Pan-Way® LD profile raceway. 5.19"L x 3.45"W x 1.75"H (131.9mm x 87.7mm x 44.4mm). Breakouts for 1/2", 3/4", or 1" diameter conduit.	Off White	1	10
<b>JBP2IW</b>	Double gang two-piece screw together outlet box. Box accepts Pan-Way® Screw-On Faceplates or any NEMA standard double gang faceplates. For use with Pan-Way® LD profile raceway. 5.05"L x 5.05"W x 1.62"H (128.2mm x 128.2mm x 41.1mm). Breakouts for 1/2" or 3/4" diameter conduit.	Off White	1	10
<b>JBP1DIW</b>	Single gang two-piece screw together deep outlet box. Box accepts Pan-Way® Screw-On Faceplates or any NEMA standard single gang faceplate. For use with Pan-Way® T-45, LD2P10 (when used with JBD1), or LD profile raceway. 5.19"L x 3.45"W x 2.75"H (131.9mm x 87.7mm x 69.8mm). Breakouts for 1/2", 3/4", or 1" diameter conduit.	Off White	1	10
<b>JBP2DIW</b>	Double gang two-piece screw together deep outlet box. Box accepts Pan-Way® Screw-On Faceplates or any NEMA standard double gang faceplate. For use with Pan-Way® T-45 or LD profile raceway. 5.19"L x 5.19"W x 2.75"H (131.9mm x 131.9mm x 69.8mm). Breakouts for 1/2", 3/4", or 1" diameter conduit.	Off White	1	10
<b>JBP1EIW</b>	Single gang two-piece screw together extension outlet box. Box accepts Pan-Way® Screw-On Faceplates or any NEMA standard single gang faceplate. For use with Pan-Way® LD profile raceway. 4.99"L x 3.30"W x 1.00"H (126.7mm x 83.8mm x 25.4mm). Breakouts for 1/2", 3/4", or 1" diameter conduit.	Off White	1	10
<b>JBP1IIW</b>	Single gang two-piece screw together intermediate outlet box. Box accepts Pan-Way® Screw-On Faceplates or any NEMA standard single gang faceplate. For use with Pan-Way® LD profile raceway. 5.12"L x 3.38"W x 2.27"H (130.2mm x 86.0mm x 57.7mm). Breakouts for 1/2" or 3/4" diameter conduit.	Off White	1	10
<b>PSJBXIW</b>	Single gang two-piece snap together power source box. For use with Pan-Way® LDPH3, 5, 10, or LDS3, or 5 profile raceway. 5.02"L x 3.32"W x 1.31"H (127.6mm x 83.0mm x 33.3mm). Breakouts for 1/2", 3/4", or 1" diameter conduit.	Off White	1	10

‡For other colors replace IW (Off White) with EI (Electric Ivory), IG (International Gray), or WH (White).





## Pan-Way® Power Rated Surface Mount Outlet Boxes (continued)



JBD1



JBP2S



JBD2



JBP1FS



JBP2FS



JBP1MR20



JBP1MD20



RJBX3510

Part Number	Part Description	Color‡	Std. Pkg. Qty.	Std. Ctn. Qty.
<b>JBD1</b>	Single gang pass-through divider. Allows power and communication outlets to be routed in series. For use with JBP1 or JBP1D when installing LD2P10 raceway.	Off White	1	10
<b>JBP2SIW</b>	Double gang two-piece screw together divided outlet box. Box accepts Pan-Way® Screw-On Faceplates or any NEMA standard double gang faceplate. For use with Pan-Way® T-45 or LD profile raceway. 5.05"L x 5.05"W x 1.62"H (128.2mm x 128.2mm x 41.1mm). Breakouts for 1/2" or 3/4" diameter conduit.	Off White	1	10
<b>JBD2</b>	Double gang pass-through divider. Allows power and communication outlets to be routed in series. For use with JBP2D when installing LD2P10 raceway.	Off White	1	10
<b>JBP1FSIW</b>	Single gang power rated two-piece snap together outlet box. Box accepts Pan-Way® Snap-On Faceplates. For use with Pan-Way® T-45 or LD, LDP, LDPH, LDS profile raceways. 5.00"L x 3.26"W x 1.62"H (127.1mm x 82.7mm x 41.1mm). Breakouts for 1/2", 3/4", or 1" diameter conduit.	Off White	1	10
<b>JBP2FSIW</b>	Double gang power rated two-piece snap together outlet box. Box accepts Pan-Way® Snap-On Faceplates. For use with Pan-Way® T-45 or LD profile raceway. 5.00"L x 6.14"W x 1.62"H (127.1mm x 155.9mm x 41.1mm). Breakouts for 1/2", 3/4", or 1" diameter conduit.	Off White	1	10
<b>JBP1MR20IW</b>	Single gang two-piece power rated low profile snap together outlet box. Includes 20A U.S. style rectangular electrical outlet. For use with Pan-Way® LDPH3, 5, 10 or LDS3 or 5 profile raceway only. 4.84"L x 2.90"W x 1.20"H (122.9mm x 73.6mm x 30.4mm).	Off White	1	10
<b>JBP1MD20IW</b>	Single gang two-piece power rated low profile snap together outlet box. Includes 20A U.S. style 106 duplex electrical outlet. For use with Pan-Way® LDPH3, 5, 10 or LDS3 or 5 profile raceway only. 4.84"L x 2.90"W x 1.22"H (122.9mm x 73.6mm x 30.9mm).	Off White	1	10
<b>RJBX3510IW</b>	Single gang two-piece screw together round outlet box. Box accepts UL/CSA devices not to exceed 10lbs. (5lbs. per CSA). For use with Pan-Way® LD profile raceway. Dia. = 5.48"D x 1.14"H (139.2mm x 29.0mm). Breakouts for 3/4" or 1" diameter conduit.	Off White	1	5

‡For other colors replace IW (Off White) with EI (Electric Ivory), IG (International Gray), or WH (White).

A.  
System  
Overview

B1.  
Cable Ties

B2.  
Cable  
Accessories

B3.  
Stainless  
Steel Ties

C1.  
Wiring  
Duct

C2.  
Surface  
Raceway

C3.  
Abrasion  
Protection

C4.  
Cable  
Management

D1.  
Terminals

D2.  
Power  
Connectors

D3.  
Grounding  
Connectors

E1.  
Labeling  
Systems

E2.  
Labels

E3.  
Pre-Printed  
& Write-On  
Markers

E4.  
Permanent  
Identification

E5.  
Lockout/  
Tagout  
& Safety  
Solutions

F.  
Index

A. System Overview



## Pan-Way® Classic Series Faceplates for Power and Communication Applications

B1. Cable Ties

- For use with JBP2S or JBP2D outlet boxes

B2. Cable Accessories

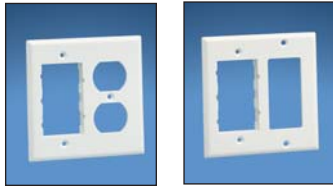

FP2DC

FP2RC

B3. Stainless Steel Ties

C1. Wiring Duct

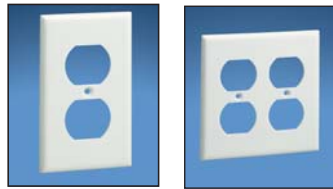

CP106

CP106\*\*-2G

C2. Surface Raceway

C3. Abrasion Protection

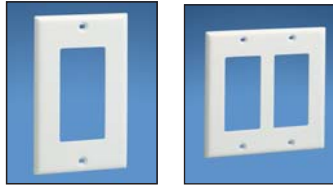

CPG

CPG\*\*-2G

C4. Cable Management

D1. Terminals



CPN

CPN\*\*-2G

D2. Power Connectors

D3. Grounding Connectors

E1. Labeling Systems

E2. Labels

E3. Pre-Printed & Write-On Markers

E4. Permanent Identification

E5. Lockout/Tagout & Safety Solutions

F. Index

Part Number	Part Description	Color‡	Std. Pkg. Qty.	Std. Ctn. Qty.
<b>FP2DCIW</b>	Covers one NEMA standard 106 duplex electrical receptacle and accepts Panduit® Mini-Com® 1/2-size, 1/3-size, and 2/3-size Inserts. For product application, please reference LD profile raceway section.	Off White	1	10
<b>FP2RCIW</b>	Covers one NEMA standard rectangular electrical receptacle and accepts Panduit® Mini-Com® 1/2-size, 1/3-size, and 2/3-size Inserts. For product application, please reference LD profile raceway section.	Off White	1	10
<b>CP106IW</b>	Screw-on single gang 106 duplex faceplate. Covers one NEMA standard 106 duplex electrical outlet or one standard 106 communication module frame.	Off White	1	10
<b>CP106IW-2G</b>	Screw-on double gang 106 duplex faceplate. Covers two NEMA standard 106 duplex electrical outlets or two standard 106 communication module frames.	Off White	1	10
<b>CPGIW</b>	Screw-on single gang rectangular faceplate. Covers one NEMA standard rectangular electrical outlet or one standard rectangular communication module frame.	Off White	1	10
<b>CPGIW-2G</b>	Screw-on double gang rectangular faceplate. Covers two NEMA standard rectangular electrical outlets or two standard rectangular communication module frames.	Off White	1	10
<b>CPNIW</b>	Screw-on single gang blank cover faceplate. Can be used with Pan-Way® Cove, TG-70, T-70, Twin-70, T-45 Raceway Systems, Fast-Snap™ Outlet Boxes and Pan-Pole™ Aluminum Outlet Pole. Supplied with two mounting screws.	Off White	1	10
<b>CPNIW-2G</b>	Screw-on double gang blank cover faceplate. For use with Pan-Way® Surface Mount Outlet Boxes. Supplied with four mounting screws.	Off White	1	10

‡For other colors replace suffix IW (Off White) with EI (Electric Ivory), IG (International Gray), WH (White), or AL (Almond).

All faceplates supplied with mounting screws.

For complete labeling solutions, reference label chart below.

## Component Labels for Pan-Way® Classic Series Faceplates for Power and Communication Applications

Faceplate Part Number	Suggested Label Solutions for TIA/EIA-606-A Compliance			
	Laser/Ink Jet Desktop Printer Label	TDP43MY Thermal Transfer Desktop Printer Label	PanTher™ LS8E Hand-Held Printer Label	Cougar™ LS9 Hand-Held Printer Label
<b>CPGIW T70PGS</b>	C125X030FJJ	C125X030YPT	C125X030FJC	T031X000FJC-BK
<b>CPGIW-2G FP2RC</b>	2-C125X030FJJ	2-C125X030YPT	2-C125X030FJC	T031X000FJC-BK
<b>T70PG</b>	C261X030FJJ	T031X000FJT	C261X030FJC	T031X000FJC-BK

**UL LISTED SP® Pan-Way® Stainless Steel Faceplates**



WPS-20

WPS-202

Part Number	Part Description	Std. Pkg. Qty.	Std. Ctn. Qty.
<b>WPS-20</b>	Stainless steel single gang 106 duplex screw-on faceplate. Covers one NEMA standard 106 duplex electrical outlet or one standard 106 communication module frame.	1	10
<b>WPS-202</b>	Stainless steel double gang 106 duplex screw-on faceplate. Covers two NEMA standard 106 duplex electrical outlets or two standard 106 communication module frames.	1	10

All faceplates supplied with mounting screws.

**UL LISTED Pan-Way® Electrical Outlets**

- Electrical outlets are standard electrical devices that fit into Pan-Way® Outlet Boxes or any NEMA standard outlet boxes



EDU20

ERU20

ETU20

EGU20

Part Number	Part Description	Color‡	Std. Pkg. Qty.
<b>EDU20IW-X</b>	20 A specification grade 106 duplex outlet.	Off White	10
<b>ERU20IW-X</b>	20 A specification grade rectangular outlet.	Off White	10
<b>ETU20IW-X</b>	20 A specification grade TVSS rectangular outlet (transient voltage surge suppressor).	Off White	10
<b>EGU20IW-X</b>	20 A specification grade GFCI rectangular outlet (ground fault circuit interrupter).	Off White	10

‡For other colors, replace IW (Off White) with EI (Electric Ivory).  
All outlets supplied with mounting screws.

**UL SA LISTED SP® Pan-Way® Surface Mount Outlet Box with 20 A Electrical Outlet**

- Supplied with a 20 A U.S. style rectangular electrical outlet and a 20 A 106 duplex electrical outlet.



JBP1MR20



JBP1MD20

Part Number	Part Description	Color‡	Std. Pkg. Qty.	Std. Ctn. Qty.
<b>JBP1MR20IW</b>	Single gang two-piece power rated low profile snap together outlet box. Includes 20 A U.S. style rectangular electrical outlet. For use with Pan-Way® LDPH3, 5, 10 or LDS3 or 5 profile raceway only. 4.84"L x 2.90"W x 1.20"H (122.9mm x 73.6mm x 30.4mm).	Off White	1	10
<b>JBP1MD20IW</b>	Single gang two-piece power rated low profile snap together outlet box. Includes 20 A U.S. style 106 duplex electrical outlet. For use with Pan-Way® LDPH3, 5, 10 or LDS3 or 5 profile raceway only. 4.84"L x 2.90"W x 1.22"H (122.9mm x 73.6mm x 30.9mm).	Off White	1	10

‡For other color replace IW (Off White) with EI (Electric Ivory).

A.  
System  
Overview

B1.  
Cable Ties

B2.  
Cable  
Accessories

B3.  
Stainless  
Steel Ties

C1.  
Wiring  
Duct

C2.  
Surface  
Raceway

C3.  
Abrasion  
Protection

C4.  
Cable  
Management

D1.  
Terminals

D2.  
Power  
Connectors

D3.  
Grounding  
Connectors

E1.  
Labeling  
Systems

E2.  
Labels

E3.  
Pre-Printed  
& Write-On  
Markers

E4.  
Permanent  
Identification

E5.  
Lockout/  
Tagout  
& Safety  
Solutions

F.  
Index

## Selection Chart for using Pan-Way® Surface Raceway with Pan-Way® Surface Mount Outlet Boxes

How to use this chart:

1. Locate the desired Pan-Way® Raceway in the left column.
2. Locate the desired Pan-Way® Outlet Box in the top row.
3. Match up the raceway with the outlet box to see if they are compatible (Y = yes, N = no).
4. Select correct surface mount outlet box.

Pan-Way® Surface Mount Outlet Boxes									
Low Voltage or Fiber Optic ONLY	Power, Low Voltage, or Fiber Optic								
JB1, JB1D JB1FS JBX3510	RJBX3510	JBP1	JBP1D	JBP1E	JBP1I JBP2	JBP2S JBP2D JBP2FS	JBP1MR20 JBP1MD20	PSJBX	
<b>Type LD (Low Voltage, or Fiber Optic ONLY)</b>									
LD3	Y	Y	Y	Y	Y	Y	Y	N	Y
LD5	Y	Y	Y	Y	Y	Y	Y	N	Y
LD10	Y	Y	Y	Y	Y	Y	Y	N	Y
<b>Type LDPH (Power, Low Voltage, or Fiber Optic)</b>									
LDPH3	Y	Y	Y	Y	Y	Y	Y	Y	Y
LDPH5	Y	Y	Y	Y	Y	Y	Y	Y	Y
LDPH10	Y	Y	Y	Y	Y	Y	Y	Y	Y
<b>Type LDS (Power, Low Voltage, or Fiber Optic)</b>									
LDS3	Y	Y	Y	Y	Y	Y	Y	Y	Y
LDS5	Y	Y	Y	Y	Y	Y	Y	Y	Y
<b>Type LD2P10 (Power, Low Voltage, or Fiber Optic)</b>									
LD2P10	N	N	N	Y w/JBD1	N	N	Y	N	N
<b>Type T-45 (Power, Low Voltage, or Fiber Optic)</b>									
T-45	Y (JB1FS and JBX3510)	N	N	Y	N	N	Y	N	N

## PAN-WAY® LD PROFILE NON-METALLIC SURFACE RACEWAY



Pan-Way® LD Profile Raceway is available in single and multi-channel styles to provide a solution for routing copper, fiber optic, and power cabling along fixed perimeter walls.

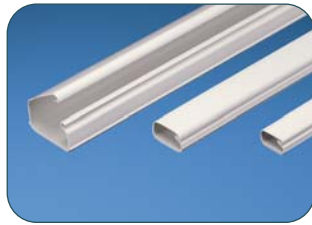

- LD2P10 features one-piece multi-channel design for both power and data applications
- LDPH is a tamper resistant two-piece latching surface raceway supplied with pre-applied adhesive backed tape
- LD features one-piece single channel design for data routing
- LDS features one-piece single channel tamper resistant design with maximum security for power OR data applications

Pan-Way® LD Profile Raceways include a full complement of fittings for standard, bend radius control, power rated and multi-channel use, and transition easily to other Panduit raceway such as Cove, TG-70, T-70, Twin-70 and T-45.

A.  
System  
Overview

B1.  
Cable Ties

B2.  
Cable  
Accessories

B3.  
Stainless  
Steel Ties

C1.  
Wiring  
Duct

C2.  
Surface  
Raceway

C3.  
Abrasion  
Protection

C4.  
Cable  
Management

D1.  
Terminals

D2.  
Power  
Connectors

D3.  
Grounding  
Connectors

E1.  
Labeling  
Systems

E2.  
Labels

E3.  
Pre-Printed  
& Write-On  
Markers

E4.  
Permanent  
Identification

E5.  
Lockout/  
Tagout  
& Safety  
Solutions

F.  
Index

A.  
System  
Overview

## LD2P10 Profile Raceway Roadmap

B1.  
Cable Ties

B2.  
Cable  
Accessories

B3.  
Stainless  
Steel Ties

C1.  
Wiring  
Duct

C2.  
Surface  
Raceway

C3.  
Abrasion  
Protection

C4.  
Cable  
Management

D1.  
Terminals

D2.  
Power  
Connectors

D3.  
Grounding  
Connectors

E1.  
Labeling  
Systems

E2.  
Labels

E3.  
Pre-Printed  
& Write-On  
Markers

E4.  
Permanent  
Identification

E5.  
Lockout/  
Tagout  
& Safety  
Solutions

F.  
Index

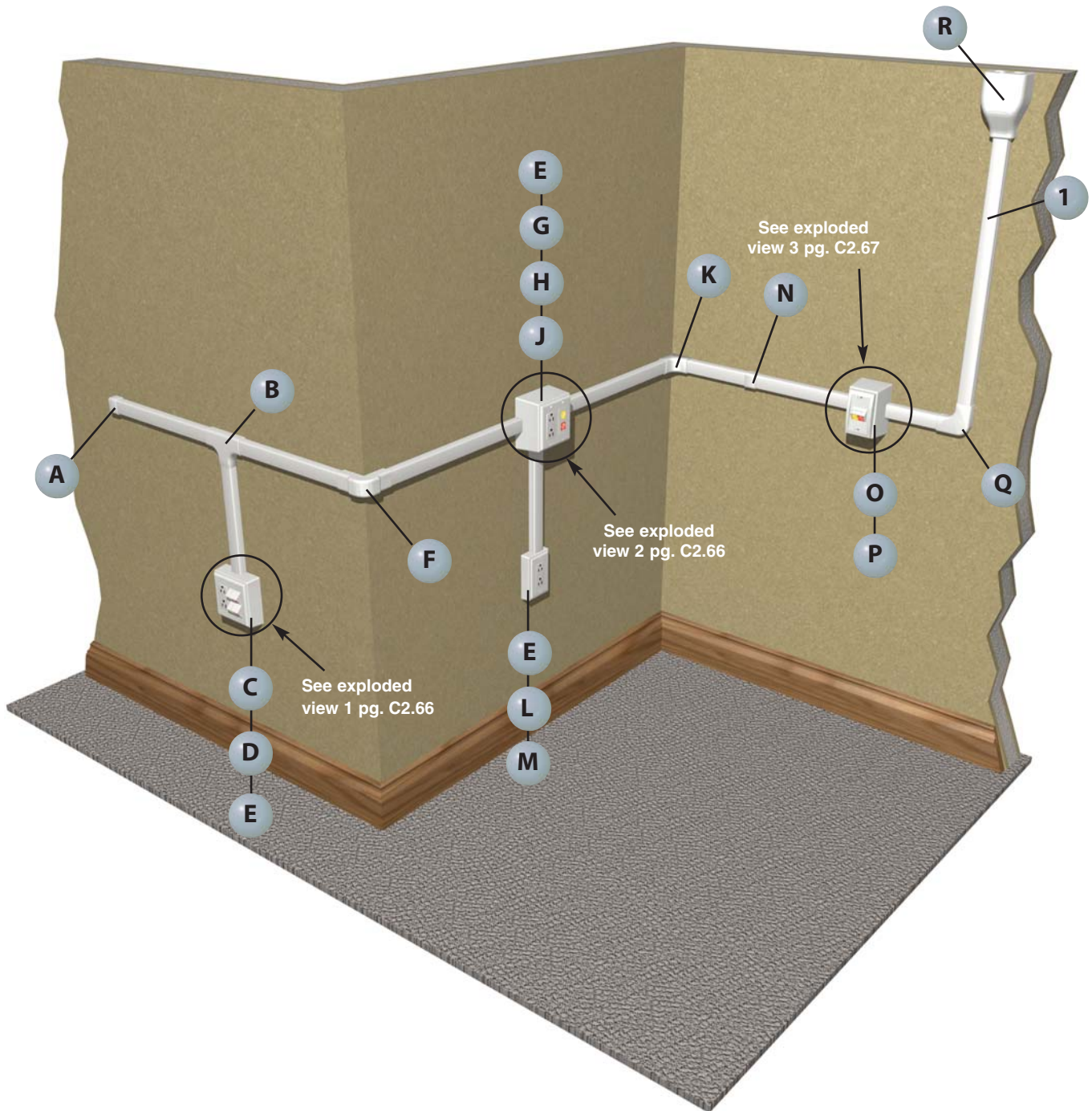

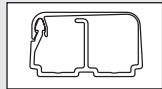

**1** LD2P10\*\* – Raceway (page C2.75)

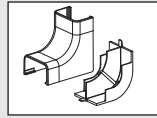

**K** ICFX10\*\* – Power Rated Inside Corner Fitting (page C2.75)

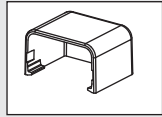

**A** ECFX10\*\* – Power Rated End Cap Fitting (page C2.75)

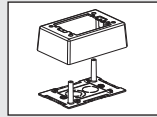

**L** JBP1\*\* – Power Rated Single Gang Two-Piece Box (page C2.58)

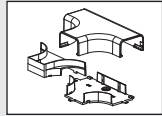

**B** TFXD10\*\* – 1 Inch Bend Radius Tee Fitting (page C2.75)

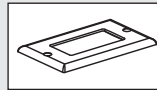

**M** CPG\*\* – Single Gang Rectangular Screw-On Faceplate (page C2.60)

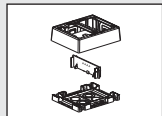

**C** JBP2S\*\* – Power Rated Double Gang Two-Piece Divided Box (page C2.59)

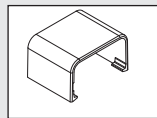

**N** CFX10\*\* – Power Rated Coupler Fitting (page C2.75)

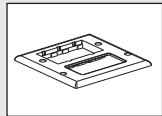

**D** FP2RC\*\* – Double Gang Rectangular Electrical and Two Communication Insert Faceplate (page C2.60)

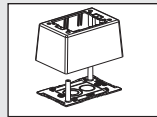

**O** JBP1D\*\* – Single Gang Two-Piece Deep Box (page C2.58)

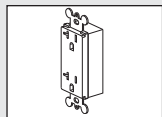

**E** ERU20\*\* – 20 A Rectangular Electrical Outlet (page C2.61)

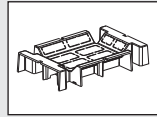

**P** JBD1 – Single Gang Pass Through Divider for LD2P10 Raceway (page C2.59)

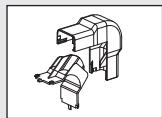

**F** OCFX10\*\* – 1 Inch Bend Radius Outside Corner Fitting (page C2.75)

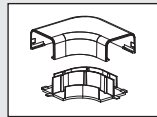

**Q** RAFX10\*\* – Power Rated Right Angle Fitting (page C2.75)

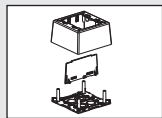

**G** JBP2D\*\* – Power Rated Double Gang Two-Piece Deep Box (page C2.58)

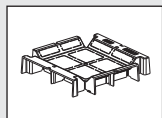

**H** JBD2 – Double Gang Pass Through and Divider for LD2P10 Raceway (page C2.59)

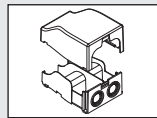

**R** EEFX\*\* – Power Rated/1 Inch Bend Radius Entrance End Fitting (page C2.75)

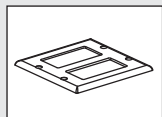

**J** CPG\*\*-2G – Double Gang Rectangular Screw-On Faceplate (page C2.60)

A. System Overview

B1. Cable Ties

B2. Cable Accessories

B3. Stainless Steel Ties

C1. Wiring Duct

C2. Surface Raceway

C3. Abrasion Protection

C4. Cable Management

D1. Terminals

D2. Power Connectors

D3. Grounding Connectors

E1. Labeling Systems

E2. Labels

E3. Pre-Printed & Write-On Markers

E4. Permanent Identification

E5. Lockout/Tagout & Safety Solutions

F. Index

A.  
System  
Overview

## LD2P10 Configurations

B1.  
Cable Ties

### Exploded View 1

	Components Required	See page
A.	Panduit® Mini-Com® Modules.	—
B.	FP2RC = Double gang rectangular electrical and two communication insert faceplate (screws included).	C2.60
C.	ERU20 = 20 A rectangular electrical outlet (screws included).	C2.61
D.	JBP2S = Power rated double gang three-piece divided box (screws included).	C2.59

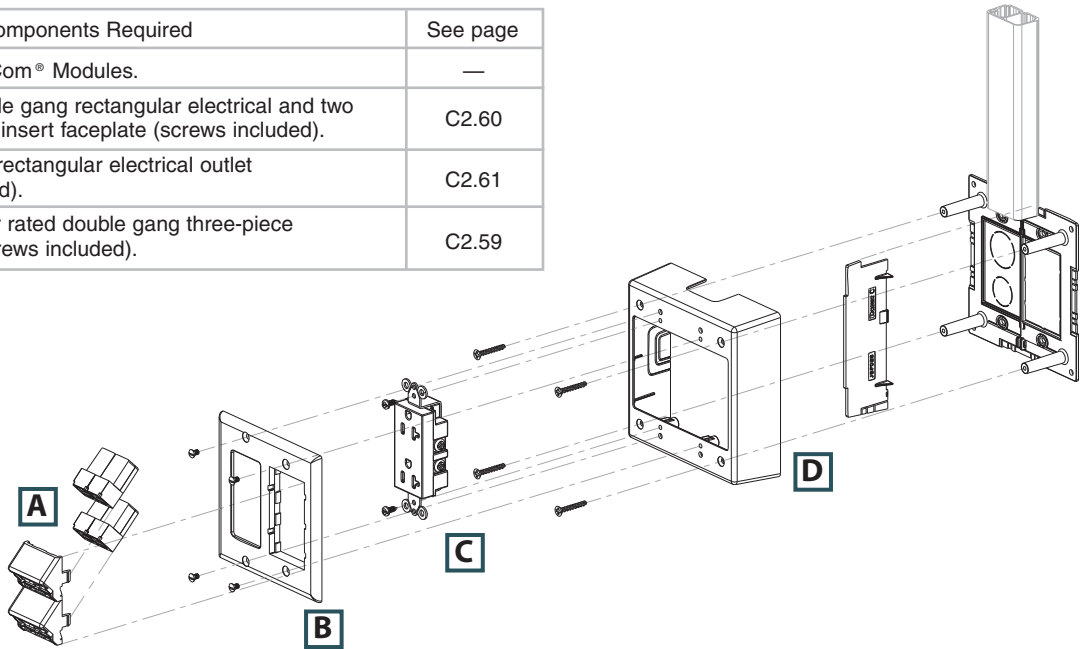

C1.  
Wiring  
Duct

C2.  
Surface  
Raceway

C3.  
Abrasion  
Protection

C4.  
Cable  
Management

D1.  
Terminals

### Exploded View 2

	Components Required	See page
A.	JBD2 = Double gang pass-through divider for LD2P10 raceway.	C2.59
B.	JBP2D = Power rated double gang two-piece deep box.	C2.58
C.	ERU20 = 20 A rectangular electrical outlet (screws included).	C2.61
D.	Panduit® Mini-Com® Modules.	—
E.	CPG2G = Double gang rectangular screw-on faceplate (screws included).	C2.60

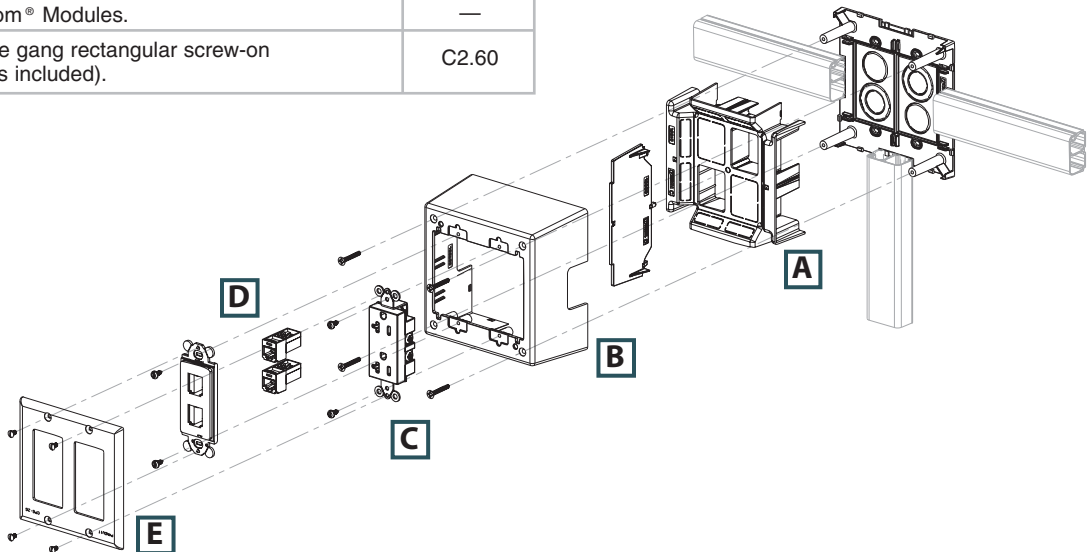

E2.  
Labels

E3.  
Pre-Printed  
& Write-On  
Markers

E4.  
Permanent  
Identification

E5.  
Lockout/  
Tagout  
& Safety  
Solutions

F.  
Index



## LD2P10 Configurations (continued)

### Exploded View 3

	Components Required	See page
A.	UICFPSE2 = Ultimate ID® Two-Position Executive Sloped Faceplate.	—
B.	Mini-Com® Modules.	—
C.	JBP1D = Power rated single gang two-piece deep box (screws included).	C2.58
D.	JBD1 = Single gang pass-through divider for LD2P10 raceway.	C2.59

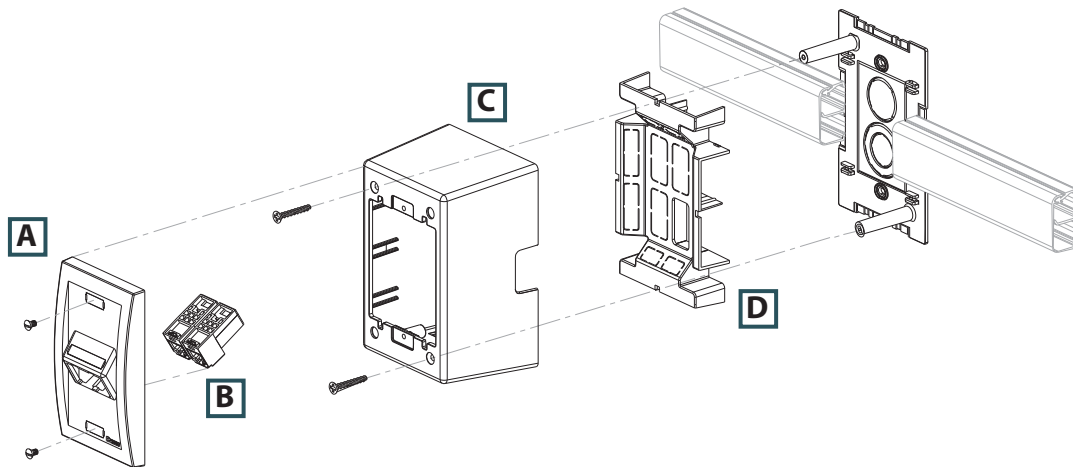

A.  
System  
Overview

B1.  
Cable Ties

B2.  
Cable  
Accessories

B3.  
Stainless  
Steel Ties

C1.  
Wiring  
Duct

C2.  
Surface  
Raceway

C3.  
Abrasion  
Protection

C4.  
Cable  
Management

D1.  
Terminals

D2.  
Power  
Connectors

D3.  
Grounding  
Connectors

E1.  
Labeling  
Systems

E2.  
Labels

E3.  
Pre-Printed  
& Write-On  
Markers

E4.  
Permanent  
Identification

E5.  
Lockout/  
Tagout  
& Safety  
Solutions

F.  
Index

A.  
System  
Overview

## LD Profile Raceway Roadmap

B1.  
Cable Ties

B2.  
Cable  
Accessories

B3.  
Stainless  
Steel Ties

C1.  
Wiring  
Duct

C2.  
Surface  
Raceway

C3.  
Abrasion  
Protection

C4.  
Cable  
Management

D1.  
Terminals

D2.  
Power  
Connectors

D3.  
Grounding  
Connectors

E1.  
Labeling  
Systems

E2.  
Labels

E3.  
Pre-Printed  
& Write-On  
Markers

E4.  
Permanent  
Identification

E5.  
Lockout/  
Tagout  
& Safety  
Solutions

F.  
Index

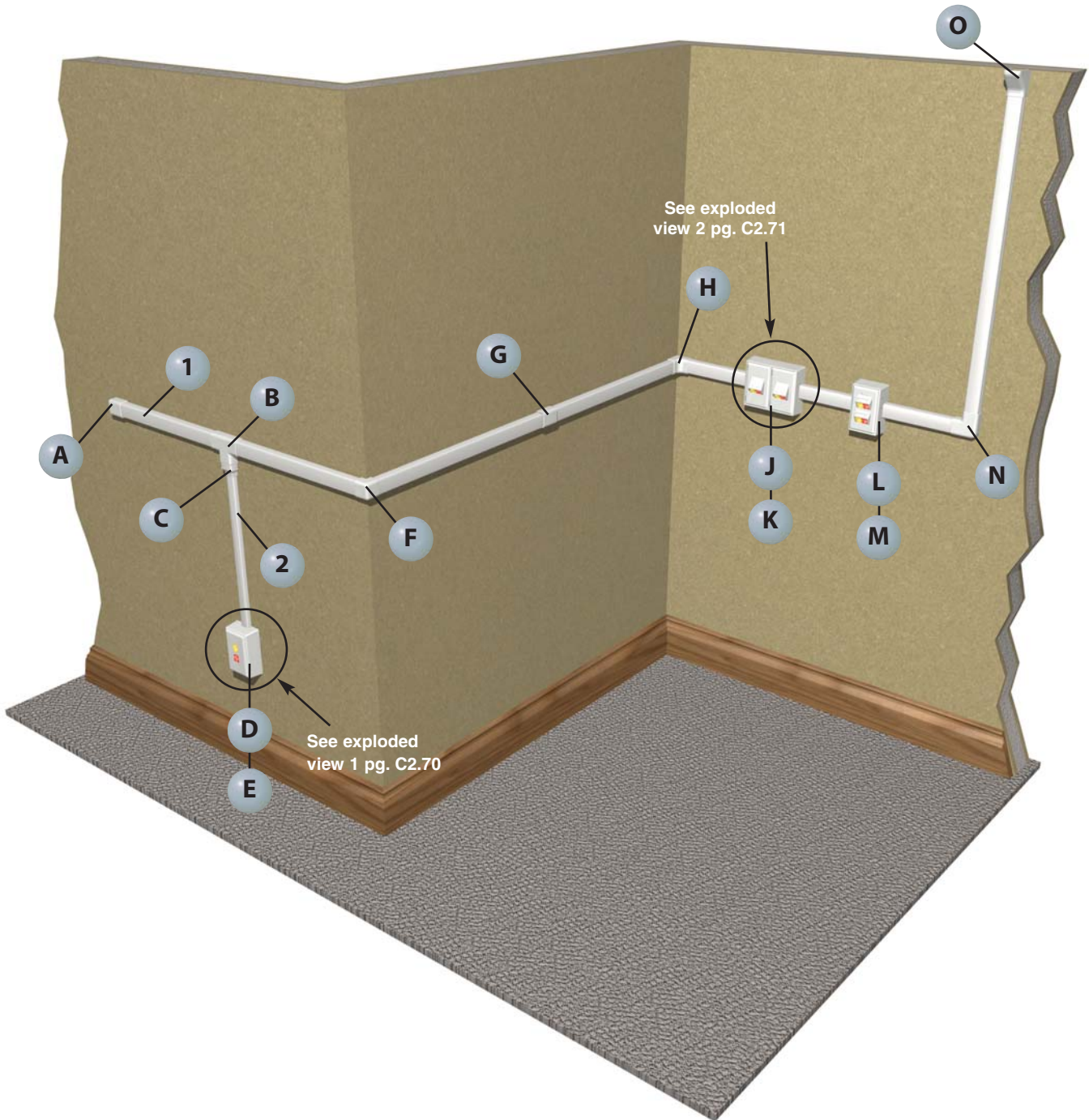

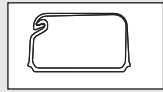

**1** LD10\*\* – Raceway (page C2.76)

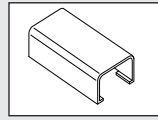

**G** CF10\*\* – Coupler Fitting (page C2.79)



**2** LD5\*\* – Raceway (page C2.76)

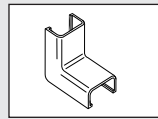

**H** ICF10\*\* – Inside Corner Fitting (page C2.79)

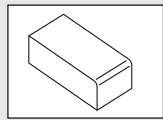

**A** ECF10\*\* – End Cap Fitting (page C2.79)

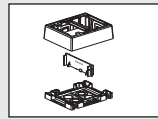

**J** JBP2FS\*\* – Fast-Snap™ Double Gang Power Rated Surface Mount Outlet Box (page C2.52)

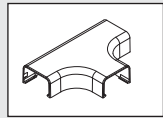

**B** TF10\*\* – Tee Fitting (page C2.79)

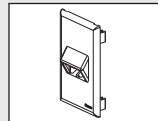

**K** T70FV2\*\* – Snap-On Vertical Sloped Communication Faceplate (page C2.52)

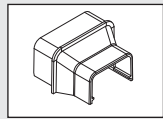

**C** RF10X5\*\* – Reducer Fitting (page C2.79)

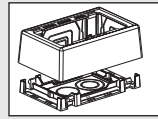

**L** JB1FS\*\* – Fast-Snap™ Single Gang Surface Mount Outlet Box (page C2.52)

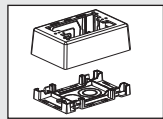

**D** JBX3510\*\* – Single Gang Two-Piece Snap-Together Box (page C2.57)

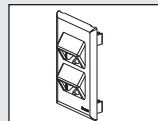

**M** T70FV4\*\* – Snap-On Vertical Sloped Communication Faceplate (page C2.52)

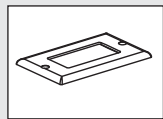

**E** CPG\*\* – Single Gang Rectangular Screw-On Faceplate (page C2.60)

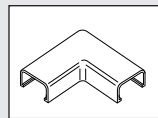

**N** RAF10\*\* – Right Angle Fitting (page C2.79)

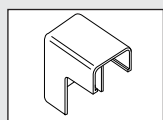

**F** OCF10\*\* – Outside Corner Fitting (page C2.79)

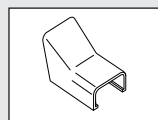

**O** DCF10\*\* – Drop Ceiling/Entrance End Fitting (page C2.79)

A. System Overview

B1. Cable Ties

B2. Cable Accessories

B3. Stainless Steel Ties

C1. Wiring Duct

C2. Surface Raceway

C3. Abrasion Protection

C4. Cable Management

D1. Terminals

D2. Power Connectors

D3. Grounding Connectors

E1. Labeling Systems

E2. Labels

E3. Pre-Printed & Write-On Markers

E4. Permanent Identification

E5. Lockout/Tagout & Safety Solutions

F. Index

A.  
System  
Overview

## LD Configurations

B1.  
Cable Ties

### Exploded View 1

B2.  
Cable  
Accessories

	Components Required	See page
A.	CPG = Single gang rectangular screw-on faceplate (screws included).	C2.60
B.	CFG2 = Mini-Com® Module Frame – 2-port.	—
C.	Mini-Com® Modules.	—
D.	JBX3510 = Single gang two-piece snap together box.	C2.57

B3.  
Stainless  
Steel Ties

C1.  
Wiring  
Duct

C2.  
Surface  
Raceway

C3.  
Abrasion  
Protection

C4.  
Cable  
Management

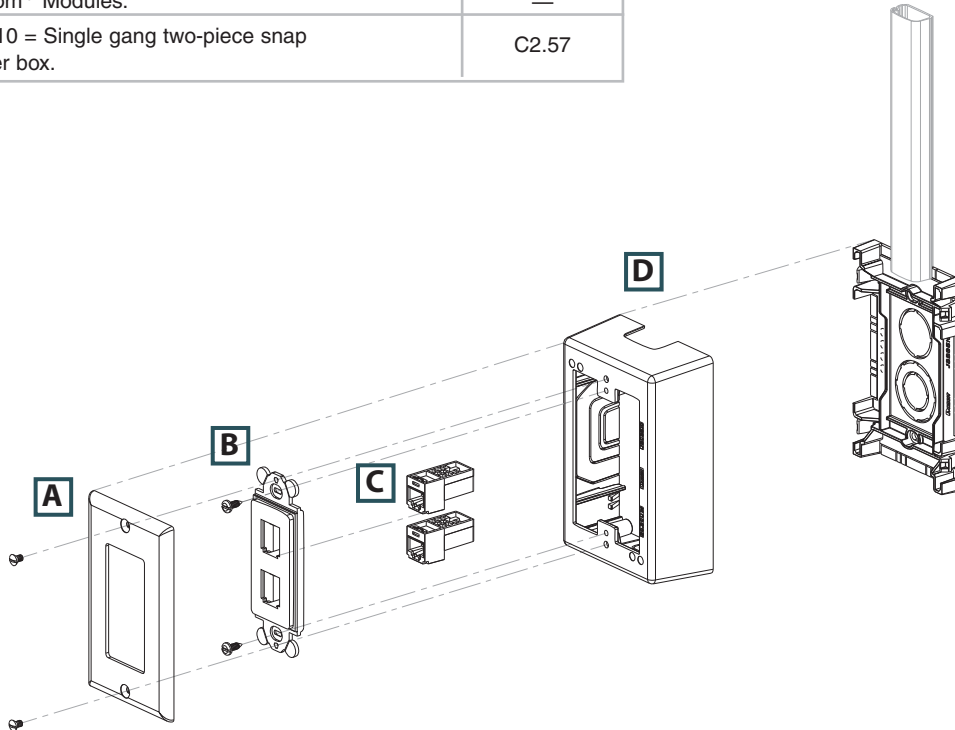

D1.  
Terminals

D2.  
Power  
Connectors

D3.  
Grounding  
Connectors

E1.  
Labeling  
Systems

E2.  
Labels

E3.  
Pre-Printed  
& Write-On  
Markers

E4.  
Permanent  
Identification

E5.  
Lockout/  
Tagout  
& Safety  
Solutions

F.  
Index

## LD Configurations (continued)

### Exploded View 2

	Components Required	See page
A.	T70FV2 = Snap-on vertical sloped communication faceplate – 2-port.	C2.52
B.	Panduit® Mini-Com® Modules.	—
C.	JBP2FS = Fast-Snap™ double gang power rated surface mount outlet box.	C2.52

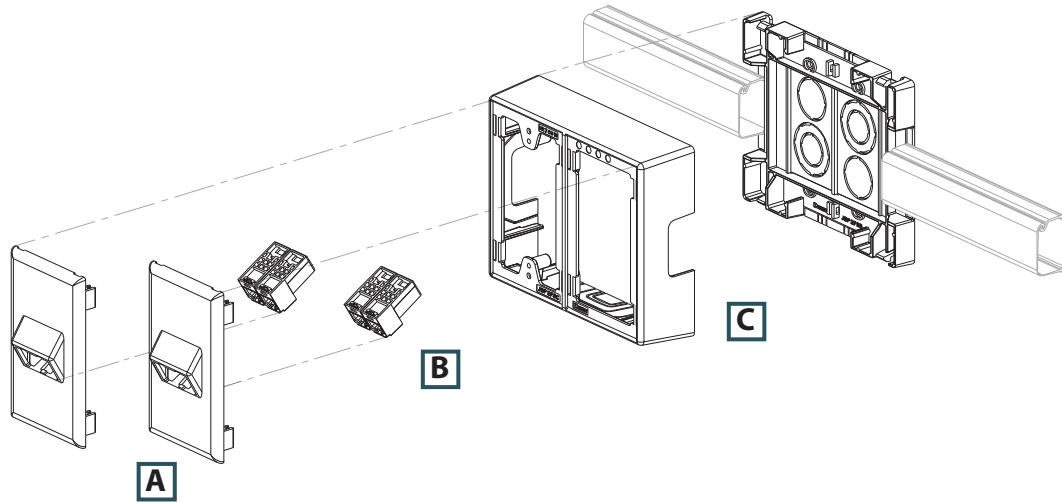

A.  
System  
Overview

B1.  
Cable Ties

B2.  
Cable  
Accessories

B3.  
Stainless  
Steel Ties

C1.  
Wiring  
Duct

C2.  
Surface  
Raceway

C3.  
Abrasion  
Protection

C4.  
Cable  
Management

D1.  
Terminals

D2.  
Power  
Connectors

D3.  
Grounding  
Connectors

E1.  
Labeling  
Systems

E2.  
Labels

E3.  
Pre-Printed  
& Write-On  
Markers

E4.  
Permanent  
Identification

E5.  
Lockout/  
Tagout  
& Safety  
Solutions

F.  
Index

A.  
System  
Overview

## LDPH Profile Raceway Roadmap

B1.  
Cable Ties

B2.  
Cable  
Accessories

B3.  
Stainless  
Steel Ties

C1.  
Wiring  
Duct

C2.  
Surface  
Raceway

C3.  
Abrasion  
Protection

C4.  
Cable  
Management

D1.  
Terminals

D2.  
Power  
Connectors

D3.  
Grounding  
Connectors

E1.  
Labeling  
Systems

E2.  
Labels

E3.  
Pre-Printed  
& Write-On  
Markers

E4.  
Permanent  
Identification

E5.  
Lockout/  
Tagout  
& Safety  
Solutions

F.  
Index

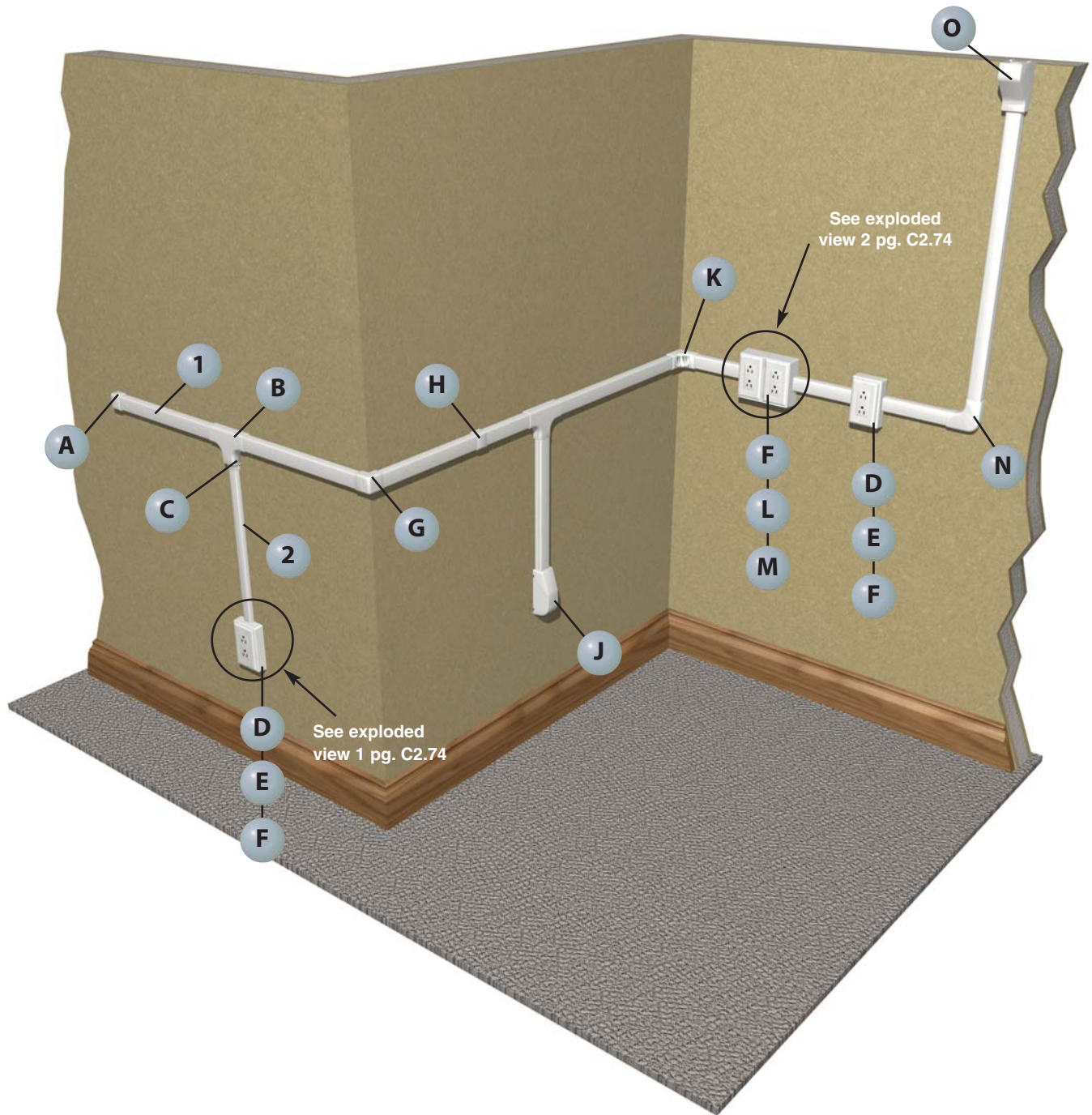

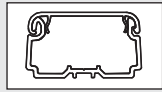

**1** LDPH10\*\* – Raceway  
(page C2.77)

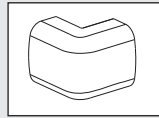

**G** OCFC10\*\* – Power Rated Outside  
Corner Fitting  
(page C2.81)

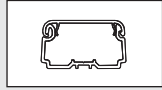

**2** LDPH5\*\* – Raceway (page C2.77)

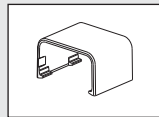

**H** CFX10\*\* – Power Rated/1 Inch  
Bend Radius Coupler Fitting  
(page C2.80)

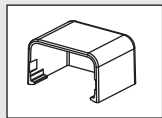

**A** ECFX10\*\* – Power Rated/1 Inch  
Bend Radius End Cap Fitting  
(page C2.80)

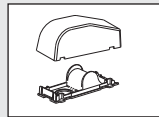

**J** RAEFX\*\* – Power Rated/1 Inch  
Bend Radius Right Angle  
Entrance End Fitting  
(page C2.81)

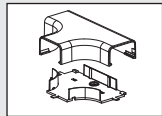

**B** TFX10\*\* – Power Rated  
Tee Fitting (page C2.81)

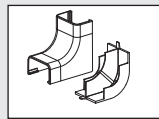

**K** ICFX10\*\* – Power Rated Inside  
Corner Fitting  
(page C2.81)

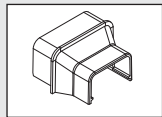

**C** RFX105\*\* – Power Rated/1 Inch  
Bend Radius Reducer Fitting  
(page C2.80, C2.81)

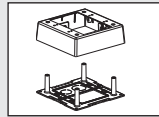

**L** JBP2\*\* – Power Rated Double  
Gang Two-Piece Box  
(page C2.58)

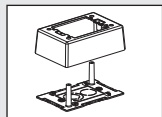

**D** JBP1\*\* – Power Rated Single  
Gang Two-Piece Box  
(page C2.58)

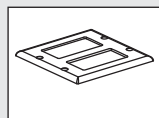

**M** CPG\*\*-2G – Double Gang  
Rectangular Screw-On Faceplates  
(page C2.60)

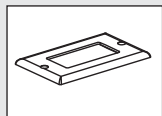

**E** CPG\*\* – Single Gang Rectangular  
Screw-On Faceplate  
(page C2.60)

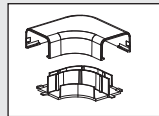

**N** RAFX10\*\* – Power Rated Right  
Angle Fitting  
(page C2.81)

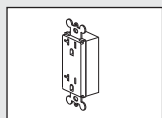

**F** ERU20\*\* – 20 A Rectangular  
Electrical Outlet  
(page C2.61)

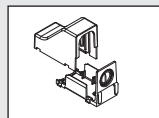

**O** DCEFX\*\* – Power Rated/1 Inch  
Bend Radius Drop Ceiling  
Entrance End Fitting  
(page C2.80)

A.  
System  
Overview

B1.  
Cable Ties

B2.  
Cable  
Accessories

B3.  
Stainless  
Steel Ties

C1.  
Wiring  
Duct

C2.  
Surface  
Raceway

C3.  
Abrasion  
Protection

C4.  
Cable  
Management

D1.  
Terminals

D2.  
Power  
Connectors

D3.  
Grounding  
Connectors

E1.  
Labeling  
Systems

E2.  
Labels

E3.  
Pre-Printed  
& Write-On  
Markers

E4.  
Permanent  
Identification

E5.  
Lockout/  
Tagout  
& Safety  
Solutions

F.  
Index

A.  
System  
Overview

## LDPH Configurations

B1.  
Cable Ties

### Exploded View 1

	Components Required	See page
A.	CPG = Single gang rectangular screw-on faceplate (screws included).	C2.60
B.	ERU20 = 20 A rectangular electrical outlet (screws included).	C2.61
C.	JBP1 = Power rated single gang two-piece box (screws included).	C2.58

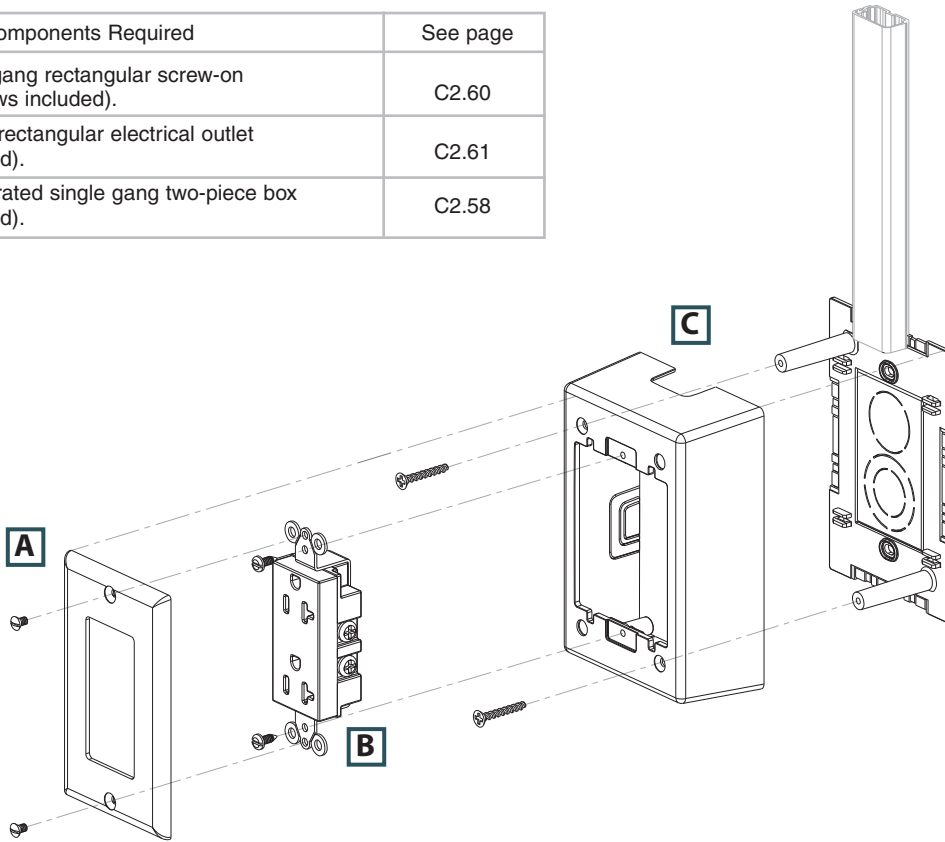

C1.  
Wiring  
Duct

C2.  
Surface  
Raceway

C3.  
Abrasion  
Protection

C4.  
Cable  
Management

D1.  
Terminals

D2.  
Power  
Connectors

### Exploded View 2

	Components Required	See page
A.	CPG**2G = Double gang rectangular screw-on faceplate (screws included).	C2.60
B.	ERU20 = 20 A rectangular electrical outlet (screws included).	C2.61
C.	JBP2 = Power rated double gang two-piece box (screws included).	C2.58

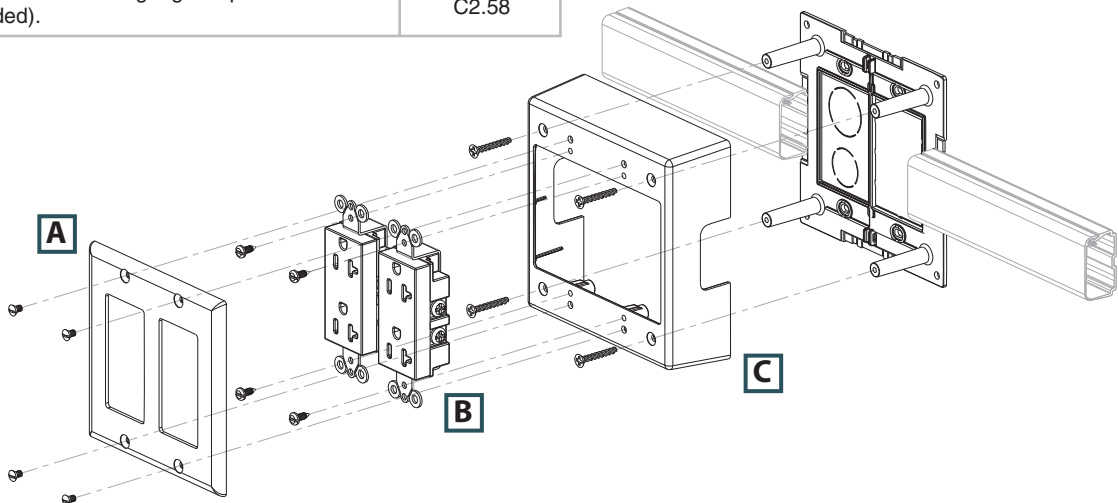

E2.  
Labels

E3.  
Pre-Printed  
& Write-On  
Markers

E4.  
Permanent  
Identification

E5.  
Lockout/  
Tagout  
& Safety  
Solutions

F.  
Index





## Pan-Way® Type LD2P10 Multi-Channel Surface Raceway System

- UL and CSA rated 600 V; meets UL 5A and CSA C22.2 No. 62.1-03 standards; FT4 rated
- Routes power and data together
- One-piece hinged design allows cables to be laid in
- Tamper resistant

- Factory applied adhesive backing speeds installation
- Terminates using JBP1D, JBP2D, JBP2FS or JBP2S surface mount outlet box solutions

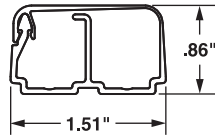

Left Internal Area = .43 Sq. In.  
Right Internal Area = .50 Sq. In.



Part Number	Part Description	Raceway Size	Color‡	Length (Ft.)	Std. Ctn. Qty.
<b>LD2P10IW8-A</b>	Two channel tamper resistant one-piece latching surface raceway. Supplied with pre-applied adhesive backed tape. Available in 8' and 10' lengths.	1.52" x .86" (39.0mm x 22.0mm)	Off White	8	160
<b>LD2P10IW10-A</b>				10	200

LD2P raceway requires screw mounting if it is being used for power cabling applications. Order number of feet required in multiples of standard length increments.

‡For other colors replace IW (Off White) with EI (Electric Ivory), IG (International Gray), or WH (White).



## Multi-Channel Fittings for LD2P10

- Multi-channel fittings for LD2P10 are designed to maintain the TIA/EIA-568-B and 569-B required minimum bend radius for high performance copper and fiber optic cabling systems



CFX10



RAFX10



ICFX10



OCFX10



TFXD10



ECFX10



EEFX

Part Number	Part Description	Color‡	Std. Pkg. Qty.
<b>CFX10IW-X</b>	Coupler fitting for use with LD10, LDPH10, and LD2P10 raceway.	Off White	10
<b>RAFX10IW-X</b>	Right angle fitting for use with LDPH10 and LD2P10 raceway.	Off White	10
<b>ICFX10IW-X</b>	Inside corner fitting for use with LDPH10 and LD2P10 raceway.	Off White	10
<b>OCFX10IW-X</b>	Outside corner fitting for use with LDPH10 and LD2P10 raceway.	Off White	10
<b>TFXD10IW-X</b>	Tee fitting with divided insert to maintain separation of power and data cabling. For use with LD2P10 raceway.	Off White	10
<b>ECFX10IW-X</b>	End cap fitting for use with LDPH10 and LD2P10 raceway.	Off White	10
<b>EEFXIW</b>	Entrance end fitting for LD2P10 raceway. Breakouts for 1/2" and 3/4" diameter conduit.	Off White	1

‡For other colors replace IW (Off White) with EI (Electric Ivory), IG (International Gray), or WH (White).

A.  
System  
Overview

B1.  
Cable Ties

B2.  
Cable  
Accessories

B3.  
Stainless  
Steel Ties

C1.  
Wiring  
Duct

C2.  
Surface  
Raceway

C3.  
Abrasion  
Protection

C4.  
Cable  
Management

D1.  
Terminals

D2.  
Power  
Connectors

D3.  
Grounding  
Connectors

E1.  
Labeling  
Systems

E2.  
Labels

E3.  
Pre-Printed  
& Write-On  
Markers

E4.  
Permanent  
Identification

E5.  
Lockout/  
Tagout  
& Safety  
Solutions

F.  
Index

A. System Overview

## Pan-Way® LD Surface Raceway System

B1. Cable Ties

- For routing data and low voltage cabling
- One-piece hinged design allows cables to be laid in
- Factory applied adhesive backing speeds installation

- FT4 rated
- Terminates using surface mount outlet box solutions or Panduit® Mini-Com® Surface Mount Boxes

B2. Cable Accessories

B3. Stainless Steel Ties

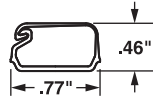

**LD3**  
Internal Area = .21 Sq. In.

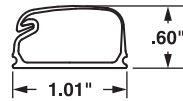

**LD5**  
Internal Area = .38 Sq. In.

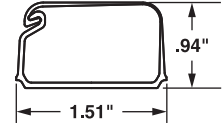

**LD10**  
Internal Area = 1.00 Sq. In.

C1. Wiring Duct



**LD3**

C2. Surface Raceway



**LD5**

C3. Abrasion Protection

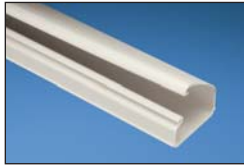

**LD10**

C4. Cable Management

D1. Terminals

D2. Power Connectors

D3. Grounding Connectors

E1. Labeling Systems

E2. Labels

E3. Pre-Printed & Write-On Markers

E4. Permanent Identification

E5. Lockout/Tagout & Safety Solutions

F. Index

Part Number	Part Description	Raceway Size	Color‡	Length (Ft.)	Std. Ctn. Qty.
<b>LD3 – Surface Raceway</b>					
<b>LD3IW6-A</b>	One-piece latching surface raceway. Supplied with pre-applied adhesive backed tape. Available in 6', 8', and 10' lengths.	.77" x .46" (20.0mm x 12.0mm)	Off White	6	120
<b>LD3IW8-A</b>				8	160
<b>LD3IW10-A</b>				10	200
<b>LD5 – Surface Raceway</b>					
<b>LD5IW6-A</b>	One-piece latching surface raceway. Supplied with pre-applied adhesive backed tape. Available in 6', 8', and 10' lengths.	1.01" x .58" (26.0mm x 15.0mm)	Off White	6	120
<b>LD5IW8-A</b>				8	160
<b>LD5IW10-A</b>				10	200
<b>LD10 – Surface Raceway</b>					
<b>LD10IW6-A</b>	One-piece latching surface raceway. Supplied with pre-applied adhesive backed tape. Available in 6', 8', and 10' lengths.	1.51" x .94" (38.4mm x 24.0mm)	Off White	6	120
<b>LD10IW8-A</b>				8	160
<b>LD10IW10-A</b>				10	200

‡For other colors replace IW (Off White) with EI (Electric Ivory), IG (International Gray), or WH (White).  
Order number of feet required in multiples of standard length increments.

## Pan-Way® LDPH Surface Raceway System

- UL and CSA rated 600 V; meets UL 5A and CSA C22.2 No. 62.1-03 standards; FT4 rated
- Two-piece hinged design allows cables to be laid in
- Tamper resistant
- Factory applied adhesive backing speeds installation
- Terminates using surface mount outlet box solutions or Panduit® Mini-Com® Surface Mount Boxes

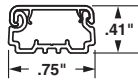

**LDPH3**  
Internal Area = .17 Sq. In.

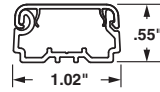

**LDPH5**  
Internal Area = .33 Sq. In.

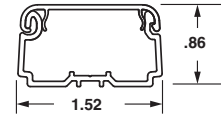

**LDPH10**  
Internal Area = .89 Sq. In.



**LDPH3**



**LDPH5**



**LDPH10**

Part Number	Part Description	Raceway Size	Color†	Length (Ft.)	Std. Ctn. Qty.
<b>LDPH3 – Surface Raceway</b>					
<b>LDPH3IW8-A</b>	Tamper resistant one-piece latching surface raceway. Supplied with pre-applied adhesive backed tape. Available in 8' and 10' lengths.	.75" x .41" (20.0mm x 10.4mm)	Off White	8	160
<b>LDPH3IW10-A</b>				10	200
<b>LDPH5 – Surface Raceway</b>					
<b>LDPH5IW8-A</b>	Tamper resistant one-piece latching surface raceway. Supplied with pre-applied adhesive backed tape. Available in 8' and 10' lengths.	1.02" x .55" (26.0mm x 14.0mm)	Off White	8	160
<b>LDPH5IW10-A</b>				10	200
<b>LDPH10 – Surface Raceway</b>					
<b>LDPH10IW8-A</b>	Tamper resistant two-piece latching surface raceway. Supplied with pre-applied adhesive backed tape. Available in 8' and 10' lengths.	1.52" x .86" (39.0mm x 22.0mm)	Off White	8	160
<b>LDPH10IW10-A</b>				10	200

LDPH raceway requires screw mounting for power cabling applications. Order number of feet required in multiples of standard length increments.

†For other colors replace IW (Off White) with EI (Electric Ivory), IG (International Gray), or WH (White).

A. System Overview

B1. Cable Ties

B2. Cable Accessories

B3. Stainless Steel Ties

C1. Wiring Duct

C2. Surface Raceway

C3. Abrasion Protection

C4. Cable Management

D1. Terminals

D2. Power Connectors

D3. Grounding Connectors

E1. Labeling Systems

E2. Labels

E3. Pre-Printed & Write-On Markers

E4. Permanent Identification

E5. Lockout/Tagout & Safety Solutions

F. Index

A. System Overview



## Pan-Way® LDS Surface Raceway System

B1. Cable Ties

• UL and CSA rated 600 V; meets UL 5A and CSA C22.2 No. 62.1-03 standards; FT4 rated

• Tamper resistant non-hinged design

• Factory applied adhesive backing speeds installation

• Type LDS is **the only non-metallic raceway that is bendable** in low voltage applications to route around and over obstructions

• LDS raceway requires screw mounting using the LMD mounting straps for power cabling installations

• Terminates using surface mount outlet box solutions or Panduit® Mini-Com® Surface Mount Boxes

B2. Cable Accessories

B3. Stainless Steel Ties

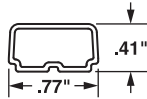

**LDS3**  
Internal Area = .21 Sq. In.

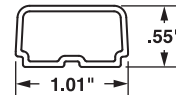

**LDS5**  
Internal Area = .38 Sq. In.

C1. Wiring Duct



**LDS3**

C2. Surface Raceway



**LDS5**

C3. Abrasion Protection

C4. Cable Management



**LMD3**  
**LMD5**

D1. Terminals

D2. Power Connectors

D3. Grounding Connectors

E1. Labeling Systems

E2. Labels

E3. Pre-Printed & Write-On Markers

E4. Permanent Identification

E5. Lockout/Tagout & Safety Solutions

F. Index

Part Number	Part Description	Raceway Size	Color‡	Length (Ft.)	Std. Ctn. Qty.
<b>LDS3 – Surface Raceway</b>					
<b>LDS3IW10-A</b>	Tamper resistant one-piece surface raceway. Supplied with pre-applied adhesive backed tape. Available in 10' lengths.	.77" x .41" (20.0mm x 10.4mm)	Off White	10	200
<b>LDS5 – Surface Raceway</b>					
<b>LDS5IW10-A</b>	Tamper resistant one-piece surface raceway. Supplied with pre-applied adhesive backed tape. Available in 10' lengths.	1.01" x .55" (26.0mm x 14.0mm)	Off White	10	200
<b>Mounting Straps</b>					
<b>LMD3IW-Q</b>	For use with LDS3 raceway.	Size 3	Off White	—	100
<b>LMD5IW-Q</b>	For use with LDS5 raceway.	Size 5	Off White	—	100

‡For other colors replace IW (Off White) with EI (Electric Ivory), IG (International Gray), or WH (White).  
Order number of feet required in multiples of standard length increments.

### Method for Bending Type LDS Raceway (Low Voltage Applications)



1) Slide 18" to 30" section of LDS Raceway into PVC pipe heating blanket.  
\*(Recommended blanket designed for bending 1/2" to 1 1/2" PVC conduit.)



2) Allow section to heat approximately 2 – 3 minutes. Raceway will be soft and pliable, but should not stretch. (Time will vary with blanket temperature and raceway size.)



3) Remove raceway section from blanket and hold in desired position until the raceway cools. Install mounting straps immediately.

\*Heating blanket not offered by Panduit.

## Standard Fittings for Low Voltage Applications

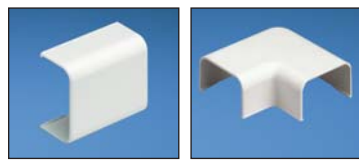

CF

RAF



ICF

OCF

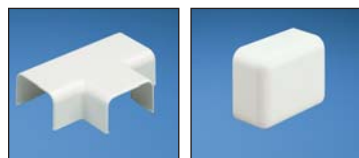

TF

ECF

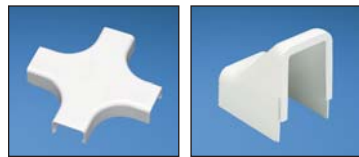

CRFC

DCF

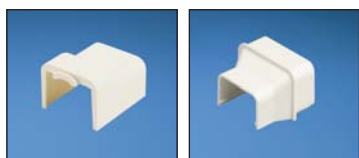

FBA

RF

Part Number	Part Description	Color‡	Std. Pkg. Qty.
<b>CF3IW-E</b>	Coupler fitting for use with LD3 raceway.	Off White	20
<b>CF5IW-E</b>	Coupler fitting for use with LD5 raceway.	Off White	20
<b>CF10IW-X</b>	Coupler fitting for use with LD10 raceway.	Off White	10
<b>RAF3IW-E</b>	Right angle fitting for use with LD3 raceway.	Off White	20
<b>RAF5IW-E</b>	Right angle fitting for use with LD5 raceway.	Off White	20
<b>RAF10IW-X</b>	Right angle fitting for use with LD10 raceway.	Off White	10
<b>ICF3IW-E</b>	Inside corner fitting for use with LD3 raceway.	Off White	20
<b>ICF5IW-E</b>	Inside corner fitting for use with LD5 raceway.	Off White	20
<b>ICF10IW-X</b>	Inside corner fitting for use with LD10 raceway.	Off White	10
<b>OCF3IW-E</b>	Outside corner fitting for use with LD3 raceway.	Off White	20
<b>OCF5IW-E</b>	Outside corner fitting for use with LD5 raceway.	Off White	20
<b>OCF10IW-X</b>	Outside corner fitting for use with LD10 raceway.	Off White	10
<b>TF3IW-E</b>	Tee fitting for use with LD3 raceway.	Off White	20
<b>TF5IW-E</b>	Tee fitting for use with LD5 raceway.	Off White	20
<b>TF10IW-X</b>	Tee fitting for use with LD10 raceway.	Off White	10
<b>ECF3IW-E</b>	End cap fitting for use with LD3 raceway.	Off White	—
<b>ECF5IW-E</b>	End cap fitting for use with LD5 raceway.	Off White	—
<b>ECF10IW-X</b>	End cap fitting for use with LD10 raceway.	Off White	—
<b>CRFC5IW-X</b>	4-way cross fitting for use with LD5, LDPH5, and LDS5 raceway.	Off White	10
<b>DCF3IW-X</b>	Drop ceiling/entrance end fitting for use with LD3 raceway.	Off White	10
<b>DCF5IW-X</b>	Drop ceiling/entrance end fitting for use with LD5 raceway.	Off White	10
<b>DCF10IW-X</b>	Drop ceiling/entrance end fitting for use with LD10 raceway.	Off White	10
<b>FBA5IW-X</b>	Fire box adapter for use with LD5/LDPH5 profile raceway. Note: For low voltage applications only.	Off White	10
<b>FBA10IW-X</b>	Fire box adapter for use with LD10/LDPH10 profile raceway. Note: For low voltage applications only.	Off White	10
<b>RF5X3IW-E</b>	Reducer fitting for LD raceway from size 5 to size 3. For use with LD5 and LD3 raceway. For in-line terminations, use with CF5**.	Off White	20
<b>RF10X3IW-X</b>	Reducer fitting for LD raceway from size 10 to size 3. For use with LD3 and LD10 raceway. For in-line terminations, use with CF10**.	Off White	10
<b>RF10X5IW-X</b>	Reducer fitting for LD raceway from size 10 to size 5. For use with LD5 and LD10 raceway. For in-line terminations, use with CF10**.	Off White	10

‡For other colors replace IW (Off White) with EI (Electric Ivory), IG (International Gray), or WH (White).

A. System Overview

B1. Cable Ties

B2. Cable Accessories

B3. Stainless Steel Ties

C1. Wiring Duct

C2. Surface Raceway

C3. Abrasion Protection

C4. Cable Management

D1. Terminals

D2. Power Connectors

D3. Grounding Connectors

E1. Labeling Systems

E2. Labels

E3. Pre-Printed &amp; Write-On Markers

E4. Permanent Identification

E5. Lockout/Tagout &amp; Safety Solutions

F. Index

A. System Overview



## One Inch Bend Radius Fittings for TIA/EIA Compliance

B1. Cable Ties

- 1 inch bend radius fittings are designed to maintain the TIA/EIA-568-B and 569-B required minimum bend radius for high performance copper and fiber optic cabling systems

B2. Cable Accessories

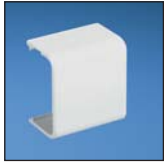

**CFX**

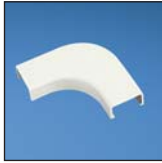

**RAFC**

B3. Stainless Steel Ties

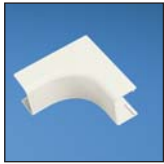

**ICFC**



**OCFX**

C1. Wiring Duct

C2. Surface Raceway



**TFC**



**CRFC5**

C3. Abrasion Protection

C4. Cable Management



**ECFX**

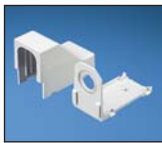

**DCEFX**

D1. Terminals

D2. Power Connectors



**RAEFX**



**RFX**

D3. Grounding Connectors

E1. Labeling Systems

E2. Labels

E3. Pre-Printed & Write-On Markers

E4. Permanent Identification

E5. Lockout/Tagout & Safety Solutions

F. Index

Part Number	Part Description	Color‡	Std. Pkg. Qty.
<b>CFX3IW-X</b>	Coupler fitting for use with LD3, LDPH3, and LDS3 raceway.	Off White	10
<b>CFX5IW-X</b>	Coupler fitting for use with LD5, LDPH5, and LDS5 raceway.	Off White	10
<b>CFX10IW-X</b>	Coupler fitting for use with LD10, LDPH10, and LD2P10 raceway.	Off White	10
<b>RAFC3IW-X</b>	Right angle fitting for use with LD3, LDPH3, and LDS3 raceway.	Off White	10
<b>RAFC5IW-X</b>	Right angle fitting for use with LD5, LDPH5, and LDS5 raceway.	Off White	10
<b>RAFC10IW-X</b>	Right angle fitting for use with LD10 and LDPH10 raceway.	Off White	10
<b>ICFC3IW-X</b>	Inside corner fitting for use with LD3, LDPH3, and LDS3 raceway.	Off White	10
<b>ICFC5IW-X</b>	Inside corner fitting for use with LD5, LDPH5, and LDS5 raceway.	Off White	10
<b>ICFC10IW-X</b>	Inside corner fitting for use with LD10 and LDPH10 raceway.	Off White	10
<b>OCFX3IW-X</b>	Outside corner fitting for use with LDPH3 and LDS3 raceway.	Off White	10
<b>OCFX5IW-X</b>	Outside corner fitting for use with LDPH5 and LDS5 raceway.	Off White	10
<b>OCFX10IW-X</b>	Outside corner fitting for use with LDPH10 and LD2P10 raceway.	Off White	10
<b>TFC3IW-X</b>	Tee fitting for use with LD3, LDPH3, and LDS3 raceway.	Off White	10
<b>TFC5IW-X</b>	Tee fitting for use with LD5, LDPH5, and LDS5 raceway.	Off White	10
<b>TFC10IW-X</b>	Tee fitting for use with LD10 and LDPH10 raceway.	Off White	10
<b>CRFC5IW-X</b>	4-way cross fitting for use with LD5, LDPH5, and LDS5 raceway.	Off White	10
<b>ECFX3IW-X</b>	End cap fitting for use with LDPH3 and LDS3 raceway.	Off White	10
<b>ECFX5IW-X</b>	End cap fitting for use with LDPH5 and LDS5 raceway.	Off White	10
<b>ECFX10IW-X</b>	End cap fitting for use with LDPH10 and LD2P10 raceway.	Off White	10
<b>DCEFXIW-X</b>	Drop ceiling/entrance end fitting for use with LD3, LDPH3, LDS3, LD5, LDPH5, LDS5, LD10 and LDPH10 raceway. Use CA3 or CA5 adapters for LD3 or LD5 profile raceway.	Off White	10
<b>RAEFXIW-X</b>	Right angle/entrance end fitting for use with LD3, LDPH3, LDS3, LD5, LDPH5, LDS5, LD10 and LDPH10 raceway. CA3 or CA5 adapters for LD3 or LD5 profile raceway.	Off White	10
<b>RFX53IW-X</b>	Reducer fitting for use with LD3, LDPH3, LDS3, LD5, LDPH5 and LDS5 raceway. For in-line terminations, use with CFX5**.	Off White	10
<b>RFX103IW-X</b>	Reducer fitting for use with LD3, LDPH3, LD10 and LDPH10 raceway. For in-line terminations, use with CFX10**.	Off White	10
<b>RFX105IW-X</b>	Reducer fitting for use with LD5, LDPH5, LDS5, LD10 and LDPH10 raceway. For in-line terminations, use with CFX10**.	Off White	10

‡For other colors replace IW (Off White) with EI (Electric Ivory), IG (International Gray), or WH (White).



## Power Rated Fittings for Power to 600 V – LDPH/LDS/LD2P Raceway Only

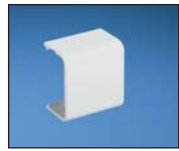

CFX

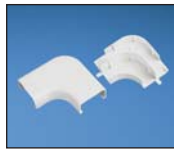

RAFX

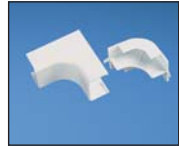

ICFX



OCFC



TFX



CRFX



CEFX



ECFX

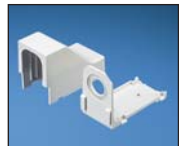

DCEFX



RAEFX



RFX

Part Number	Part Description	Color‡	Std. Pkg. Qty.
<b>CFX3IW-X</b>	Coupler fitting for use with LD3, LDPH3, and LDS3 raceway.	Off White	10
<b>CFX5IW-X</b>	Coupler fitting for use with LD5, LDPH5, and LDS5 raceway.	Off White	10
<b>CFX10IW-X</b>	Coupler fitting for use with LD10, LDPH10, and LD2P10 raceway.	Off White	10
<b>RAFX3IW-X</b>	Right angle fitting for use with LDPH3 and LDS3 raceway.	Off White	10
<b>RAFX5IW-X</b>	Right angle fitting for use with LDPH5 and LDS5 raceway.	Off White	10
<b>RAFX10IW-X</b>	Right angle fitting for use with LDPH10 and LD2P10 raceway.	Off White	10
<b>ICFX3IW-X</b>	Inside corner fitting for use with LDPH3 and LDS3 raceway.	Off White	10
<b>ICFX5IW-X</b>	Inside corner fitting for use with LDPH5 and LDS5 raceway.	Off White	10
<b>ICFX10IW-X</b>	Inside corner fitting for use with LDPH10 and LD2P10 raceway.	Off White	10
<b>OCFC3IW-X</b>	Outside corner fitting for use with LDPH3 and LDS3 raceway.	Off White	10
<b>OCFC5IW-X</b>	Outside corner fitting for use with LDPH5 and LDS5 raceway.	Off White	10
<b>OCFC10IW-X</b>	Outside corner fitting for use with LDPH10 raceway only.	Off White	10
<b>TFX3IW-X</b>	Tee fitting for use with LDPH3 and LDS3 raceway.	Off White	10
<b>TFX5IW-X</b>	Tee fitting for use with LDPH5 and LDS5 raceway.	Off White	10
<b>TFX10IW-X</b>	Tee fitting for use with LDPH10 raceway only.	Off White	10
<b>CRFX5IW-X</b>	4-way cross fitting for use with LD5, LDPH5, and LDS5 raceway.	Off White	10
<b>CEFXIW-X</b>	Conduit entrance end fitting. This power rated two-piece fitting is designed to accommodate the entrance of 1/2" conduit or align with knockouts on surface mount electrical boxes. For use with LD3/LDPH3 and has breakouts available to work with LD5/LDPH5 and LD10/LDPH10. Cover and base snap together – no hardware is required.	Off White	10
<b>ECFX3IW-X</b>	End cap fitting for use with LDPH3 and LDS3 raceway.	Off White	10
<b>ECFX5IW-X</b>	End cap fitting for use with LDPH5 and LDS5 raceway.	Off White	10
<b>ECFX10IW-X</b>	End cap fitting for use with LDPH10 and LD2P10 raceway.	Off White	10
<b>DCEFXIW-X</b>	Drop ceiling/entrance end fitting for use with LD3, LDPH3, LDS3, LD5, LDPH5, LDS5, LD10 and LDPH10 raceway. Use CA3 or CA5 adapters for LD3 or LD5 profile raceway.	Off White	10
<b>RAEFXIW-X</b>	Right angle/entrance end fitting for use with LD3, LDPH3, LDS3, LD5, LDPH5, LDS5, LD10 and LDPH10 raceway. CA3 or CA5 adapters for LD3 or LD5 profile raceway.	Off White	10
<b>RFX53IW-X</b>	Reducer fitting for use with LD3, LDPH3, LDS3, LD5, LDPH5 and LDS5 raceway. For in-line terminations, use with CFX5**.	Off White	10
<b>RFX103IW-X</b>	Reducer fitting for use with LD3, LDPH3, LD10 and LDPH10 raceway. For in-line terminations, use with CFX10**.	Off White	10
<b>RFX105IW-X</b>	Reducer fitting for use with LD5, LDPH5, LDS5, LD10 and LDPH10 raceway. For in-line terminations, use with CFX10**.	Off White	10

‡For other colors replace IW (Off White) with EI (Electric Ivory), IG (International Gray), or WH (White).

A. System Overview

B1. Cable Ties

B2. Cable Accessories

B3. Stainless Steel Ties

C1. Wiring Duct

C2. Surface Raceway

C3. Abrasion Protection

C4. Cable Management

D1. Terminals

D2. Power Connectors

D3. Grounding Connectors

E1. Labeling Systems

E2. Labels

E3. Pre-Printed & Write-On Markers

E4. Permanent Identification

E5. Lockout/Tagout & Safety Solutions

F. Index

A. System Overview

## Raceway Adapters for LD Raceway

B1. Cable Ties

- Fit into universal breakout of DCEFX or RAEFX fittings
- For use with types LD3, LDPH3, LDS3, LD5, LDPH5 and LDS5 raceway

B2. Cable Accessories



CA3  
CA5

B3. Stainless Steel Ties

Part Number	Part Description	Color‡	Std. Pkg. Qty.	Std. Ctn. Qty.
<b>CA3IW-X</b>	Adapter fits into universal breakout of DCEFX or RAEFX fittings. For use LD3, LDPH3, and LDS3 raceway.	Off White	10	50
<b>CA5IW-X</b>	Adapter fits into universal breakout of DCEFX or RAEFX fittings. For use LD5, LDPH5, and LDS5 raceway.	Off White	10	50

‡For other colors replace IW (Off White) with EI (Electric Ivory), IG (International Gray), or WH (White).

C1. Wiring Duct

C2. Surface Raceway

## Cable Fill Capacities for LD Profile Raceway

This information is to be used as a guide in selecting the proper size raceway. The maximum amounts may vary according to the cable installation methods, straightness of cables, etc.

C3. Abrasion Protection

C4. Cable Management



LD3	LD5	LD10
.21 in. <sup>2</sup>	.38 in. <sup>2</sup>	1.00 in. <sup>2</sup>



LDPH3	LDPH5	LDPH10
.17 in. <sup>2</sup>	.33 in. <sup>2</sup>	.98 in. <sup>2</sup>

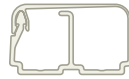

LD2P10 – Left	LD2P10 – Right
.43 in. <sup>2</sup>	.50 in. <sup>2</sup>



LDS3	LDS5
.21 in. <sup>2</sup>	.38 in. <sup>2</sup>

D1. Terminals

D2. Power Connectors

**SPEC = 40% cable fill** – The recommended design in cable capacity, leaves room for future moves, adds, and changes.

**MAX for Data = 60% cable fill** – The maximum cable quantity based on cable interweaving and packing factors.

**MAX for Power cable fill** – The maximum of electrical cables based on UL temperature rise test.

D3. Grounding Connectors

E1. Labeling Systems

E2. Labels

E3. Pre-Printed & Write-On Markers

E4. Permanent Identification

E5. Lockout/Tagout & Safety Solutions

F. Index

Raceway Type and Configuration	Fill Area (In. <sup>2</sup> )	Electrical Cables			Data Grade Cables		Data Grade Cables		Audio/Video		Fiber Optic Cable	
		14 AWG	12 AWG	10 AWG	23/24 AWG/UTP		23 AWG/UTP CM		RG6		2 Strand	
		THHN/T90			Category 6 (4-pr.)		Augmented Category 6					
		0.111	0.130	0.164	Dia. = 0.250		Dia. = 0.354		Dia. = 0.275		Dia. = 0.175	
		FILL			FILL		FILL		FILL		FILL	
MAX	MAX	MAX	SPEC	MAX	SPEC	MAX	SPEC	MAX	SPEC	MAX	SPEC	
(UL Temp Rise Test)			(40%)	(60%)	(40%)	(60%)	(40%)	(60%)	(40%)	(60%)	(40%)	(60%)
<b>LD3</b>	0.21	—	—	—	1	2	0	1	1	2	3	5
<b>LD5</b>	0.38	—	—	—	3	4	1	2	2	3	6	9
<b>LD10</b>	1.00	—	—	—	8	12	4	7	6	10	16	24
<b>LDPH3</b>	0.17	9	7	4	1	2	0	1	1	1	2	4
<b>LDPH5</b>	0.33	14	12	8	2	4	1	2	2	3	5	8
<b>LDPH10</b>	0.89	18	18	16	7	10	4	6	5	8	14	22
<b>LD2P10 – Left channel</b>	0.43	14	11	8	—	—	—	—	—	—	—	—
<b>LD2P10 – Right channel</b>	0.50	—	—	—	4	6	2	3	3	5	8	12
<b>LDS3</b>	0.21	9	6	4	1	2	0	1	1	2	3	5
<b>LDS5</b>	0.38	10	8	5	3	4	1	2	2	3	6	9

AWG dimensions represent typical outer cable diameter in inches.





## Floor Guard

- Accessory to route cables over carpet, concrete, or tile to prevent tripping
- Flexible vinyl material can be easily cut to specific lengths
- Cables route through underside of product



FG1  
FG3  
FG5

Part Number	Part Description	Color‡	Std. Pkg. Qty.
FG1EI5.0-A	Flexible vinyl material used to route cabling over carpet, tile, and concrete. Product available in 5' strips.	Electric Ivory	5
FG1EI50.0-A	Flexible vinyl material used to route cabling over carpet, tile, and concrete. Product available in 50' rolls.	Electric Ivory	50
FG3EI5.0-A	Flexible vinyl material used to route cabling over carpet, tile, and concrete. Product available in 5' strips.	Electric Ivory	5
FG3EI50.0-A	Flexible vinyl material used to route cabling over carpet, tile, and concrete. Product available in 50' rolls.	Electric Ivory	50
FG5EI5.0-A	Flexible vinyl material used to route cabling over carpet, tile, and concrete. Product available in 5' strips.	Electric Ivory	5
FG5EI25.0-A	Flexible vinyl material used to route cabling over carpet, tile, and concrete. Product available in 25' rolls.	Electric Ivory	25

Standard Package Quantity listed is in Feet.

‡For other colors replace EI (Electric Ivory) with BR (Brown), YL (Safety Yellow), or BL (Black).

## Pan-Way® Surface Raceway Cutting Tool



Part Number	Part Description	Std. Pkg. Qty.	Std. Ctn. Qty.
SRT	Used to cut all LD profile raceway. Leaves a clean burr-free finish on raceway. Can also be used to cut plastic conduit.	1	10

A.  
System  
Overview

B1.  
Cable Ties

B2.  
Cable  
Accessories

B3.  
Stainless  
Steel Ties

C1.  
Wiring  
Duct

C2.  
Surface  
Raceway

C3.  
Abrasion  
Protection

C4.  
Cable  
Management

D1.  
Terminals

D2.  
Power  
Connectors

D3.  
Grounding  
Connectors

E1.  
Labeling  
Systems

E2.  
Labels

E3.  
Pre-Printed  
& Write-On  
Markers

E4.  
Permanent  
Identification

E5.  
Lockout/  
Tagout  
& Safety  
Solutions

F.  
Index

A.  
System  
Overview

## Foam Tape

B1.  
Cable Ties

• Acrylic foam tape – Recommended for high temperature and outdoor applications (180°F) and exposure to UV light

• Rubber foam tape – Excellent quick tack designed for long term shear loads in indoor applications up to 120°F

B2.  
Cable  
Accessories



**P32W2A2**  
**P32W2R1**

B3.  
Stainless  
Steel Ties

C1.  
Wiring  
Duct

C2.  
Surface  
Raceway

C3.  
Abrasion  
Protection

C4.  
Cable  
Management

D1.  
Terminals

D2.  
Power  
Connectors

D3.  
Grounding  
Connectors

E1.  
Labeling  
Systems

E2.  
Labels

E3.  
Pre-Printed  
& Write-On  
Markers

E4.  
Permanent  
Identification

E5.  
Lockout/  
Tagout  
& Safety  
Solutions

F.  
Index

Part Number	Part Description	Color	Std. Pkg. Qty.	Std. Ctn. Qty.
<b>1/32" Thick White Acrylic Adhesive</b>				
<b>P32W2A2-50-7</b>	Foam tape, 1/32" (thick) x .50" (wide) x 7 yards, acrylic adhesive.	White	1	100
<b>P32W2A2-75-7</b>	Foam tape, 1/32" (thick) x .75" (wide) x 7 yards, acrylic adhesive.	White	1	60
<b>P32W2A2-100-7</b>	Foam tape, 1/32" (thick) x 1" (wide) x 7 yards, acrylic adhesive.	White	1	50
<b>P32W2A2-50-72</b>	Foam tape, 1/32" (thick) x .50" (wide) x 72 yards, acrylic adhesive.	White	1	9
<b>P32W2A2-75-72</b>	Foam tape, 1/32" (thick) x .75" (wide) x 72 yards, acrylic adhesive.	White	1	7
<b>P32W2A2-100-72</b>	Foam tape, 1/32" (thick) x 1" (wide) x 72 yards, acrylic adhesive.	White	1	5
<b>1/32" Thick White Rubber Adhesive</b>				
<b>P32W2R1-50-7</b>	Foam tape, 1/32" (thick) x .50" (wide) x 7 yards, rubber adhesive.	White	1	100
<b>P32W2R1-75-7</b>	Foam tape, 1/32" (thick) x .75" (wide) x 7 yards, rubber adhesive.	White	1	60
<b>P32W2R1-100-7</b>	Foam tape, 1/32" (thick) x 1" (wide) x 7 yards, rubber adhesive.	White	1	50
<b>P32W2R1-50-72</b>	Foam tape, 1/32" (thick) x .50" (wide) x 72 yards, rubber adhesive.	White	1	9
<b>P32W2R1-75-72</b>	Foam tape, 1/32" (thick) x .75" (wide) x 72 yards, rubber adhesive.	White	1	7
<b>P32W2R1-100-72</b>	Foam tape, 1/32" (thick) x 1" (wide) x 72 yards, rubber adhesive.	White	1	5
<b>P32W2R1-150-72</b>	Foam tape, 1/32" (thick) x 1.5" (wide) x 72 yards, rubber adhesive.	White	1	4

## PAN-WAY® COVE RACEWAY

Pan-Way® Cove Raceway is a full line of NEC and TIA/EIA compliant raceway, which has the appearance of architectural molding; that allows you to route, conceal, protect and terminate copper, voice, video, fiber optic or power cabling. This offering adds elegance to any room or work area by softening the horizontal angles between the wall and ceiling or the vertical angles between two walls.

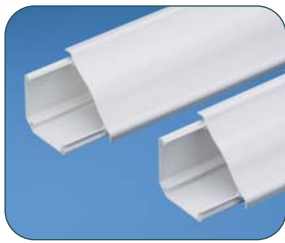

- UL and CSA rated 600 V
- Bend radius control is maintained throughout the entire system as required by TIA/EIA-568-B and 569-B
- Product mounts high out of reach for increased tamper resistance
- Divided channel system allows for routing and terminations of both power and data cabling
- Raceway and fitting covers may be painted to match any décor



Pan-Way® Cove Raceway includes a full complement of fittings and transitions easily to other Panduit raceway such as LD, LDPH, LD2P10, T-45 and T-70.

A.  
System  
Overview

B1.  
Cable Ties

B2.  
Cable  
Accessories

B3.  
Stainless  
Steel Ties

C1.  
Wiring  
Duct

C2.  
Surface  
Raceway

C3.  
Abrasion  
Protection

C4.  
Cable  
Management

D1.  
Terminals

D2.  
Power  
Connectors

D3.  
Grounding  
Connectors

E1.  
Labeling  
Systems

E2.  
Labels

E3.  
Pre-Printed  
& Write-On  
Markers

E4.  
Permanent  
Identification

E5.  
Lockout/  
Tagout  
& Safety  
Solutions

F.  
Index

A.  
System  
Overview

## Cove Raceway Roadmap

B1.  
Cable Ties

B2.  
Cable  
Accessories

B3.  
Stainless  
Steel Ties

C1.  
Wiring  
Duct

C2.  
Surface  
Raceway

C3.  
Abrasion  
Protection

C4.  
Cable  
Management

D1.  
Terminals

D2.  
Power  
Connectors

D3.  
Grounding  
Connectors

E1.  
Labeling  
Systems

E2.  
Labels

E3.  
Pre-Printed  
& Write-On  
Markers

E4.  
Permanent  
Identification

E5.  
Lockout/  
Tagout  
& Safety  
Solutions

F.  
Index

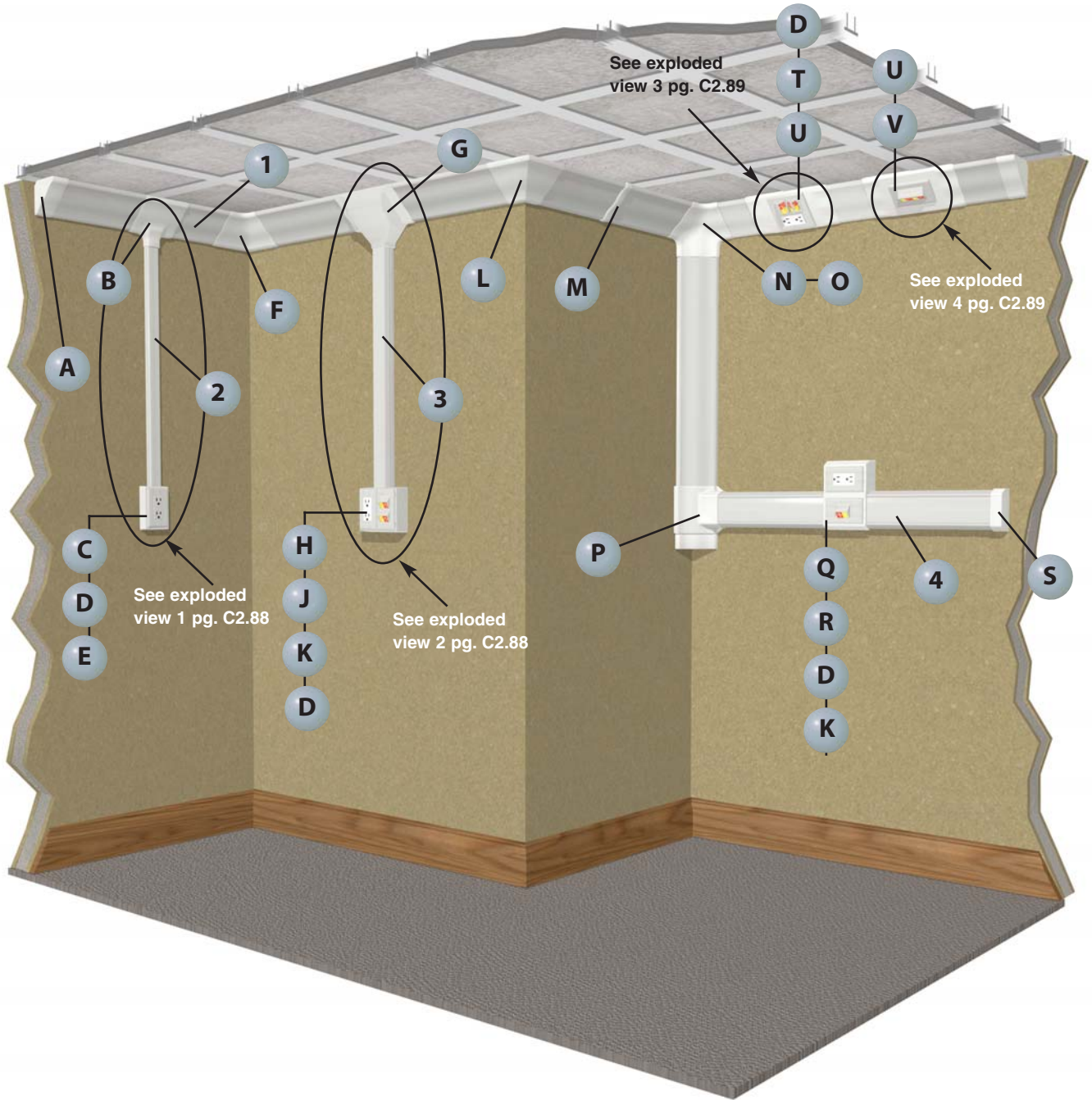

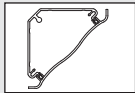

**1** WCM35BIW, WCM35CIW – Cove Raceway Base and Cover (page C2.90)

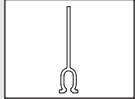

**1** WCM35DW – Cove Raceway Divider Wall (page C2.90)

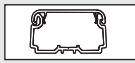

**2** LDPH10\*\* – LDPH10 Raceway (page C2.77)

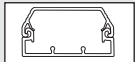

**3** T45B\*\*, T45C\*\* – T-45 Raceway Base and Cover (page C2.48)

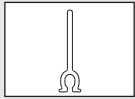

**3** T45DW – T-45 Raceway Divider Wall (page C2.48)

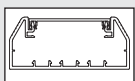

**4** T70B\*\*, T70C\*\* – T-70 Raceway Base and Cover (page C2.36)

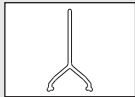

**4** T70DW – T-70 Raceway Divider Wall (page C2.36)

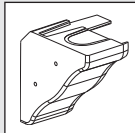

**A** WCM35ECIW – Cove Raceway End Cap (page C2.91)

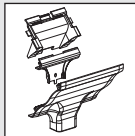

**B** WCM35TR10IW – Cove Raceway Low Profile Transition Fitting for LD/LDPH10 Raceway (page C2.91)

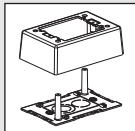

**C** JBP1\*\* – Power Rated Single Gang Two-Piece Box (page C2.58)

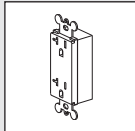

**D** ERU20\*\* – 20 A Rectangular Outlet (page C2.61)

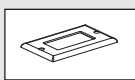

**E** CPG\*\* – Single Gang Rectangular Electrical/Communication Screw-On Faceplate (page C2.60)

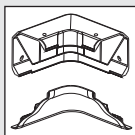

**F** WCM35ICIW – Cove Raceway Inside Corner Fitting (page C2.91)



**G** WCM35TRIW – Cove Raceway Transition Fitting for T-45 and LD Series Raceways (page C2.91)

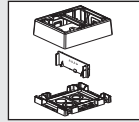

**H** JBP2F5\*\* – Fast-Snap™ Double Gang Power Rated Surface Mount Outlet Box (page C2.52)

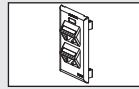

**J** UIT70FV4\*\* – Ultimate ID® Sloped Vertical Snap-On Faceplate (see SA-NCCB51)

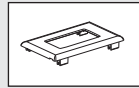

**K** T70PG\*\* – Single Gang Rectangular Electrical/Communication Snap-On Faceplate (page C2.53)

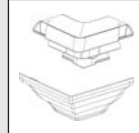

**L** WCM35OCIW – Cove Raceway Outside Corner Fitting (page C2.91)



**M** WCM35CCIW – Cove Raceway Cover Coupler Fitting (page C2.91)

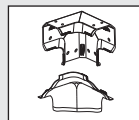

**N** WCM35TIW – Cove Raceway Tee Fitting (page C2.91)

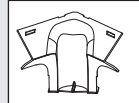

**O** WCM35TI – Cove Raceway Tee Fitting Insert (page C2.91)

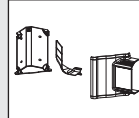

**P** WCM35TR70IW – Cove Raceway Low Profile Transition Fitting for T-70 Raceway (page C2.91)

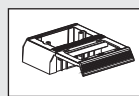

**Q** T70WC2\*\* – T-70 Workstation Outlet Center™ Offset Box for Snap-On Faceplates (page C2.37)

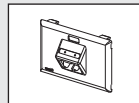

**R** UIT70FH2\*\* – Ultimate ID® Horizontal Snap-On Faceplate (see SA-NCCB51)



**S** T70EC\*\* – T70 Raceway End Cap Fitting (page C2.37)

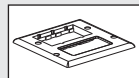

**T** FP2RC\*\* – Double Gang Rectangular Electrical and Communication Faceplate (page C2.60)

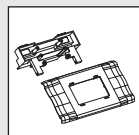

**U** WCM35DBFIW – Cove Raceway Device Box and Faceplate Adapter (page C2.91)

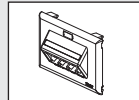

**V** UIT70FH4\*\* – Ultimate ID® Horizontal Snap-On Faceplate (see SA-NCCB51)

A.  
System  
Overview

## Cove Configurations

B1.  
Cable Ties

### Exploded View 1

	Components Required	See page
A.	WCM35TR10 = Cove raceway low profile transition fitting for LD/LDP10 raceway.	C2.91
B.	JBP1 = Power rated single gang two-piece box.	C2.58
C.	ERU20 = 20 A rectangular electrical outlet (screws included).	C2.61
D.	CPG = Screw-on single gang rectangular faceplate.	C2.60

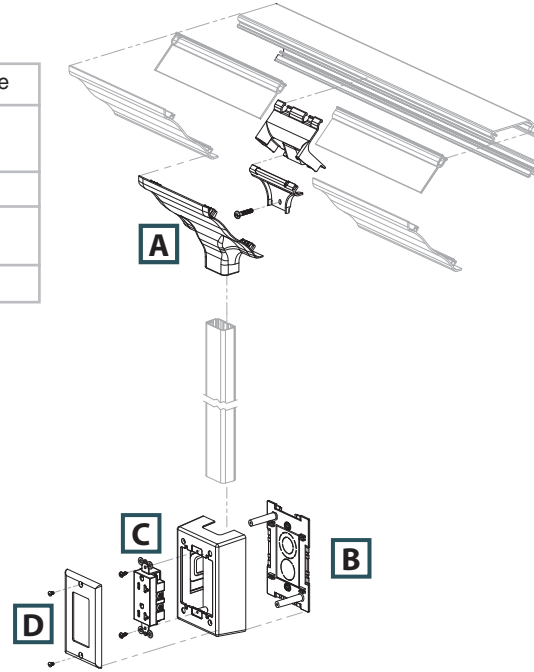

C1.  
Wiring  
Duct

C2.  
Surface  
Raceway

C3.  
Abrasion  
Protection

C4.  
Cable  
Management

### Exploded View 2

	Components Required	See page
A.	WCM35TR = Cove raceway transition fitting.	C2.91
B.	JBP2FS = Fast-Snap™ Double Gang Power Rated Surface Mount Outlet Box.	C2.52
C.	Mini-Com® Modules.	—
D.	T70PG = Single gang rectangular electrical/communication snap-on faceplate.	C2.53
E.	UIT70FV4 = Ultimate ID® Sloped Vertical Snap-On Faceplate.	—
F.	ERU20 = 20 A rectangular electrical outlet (screws included).	C2.61

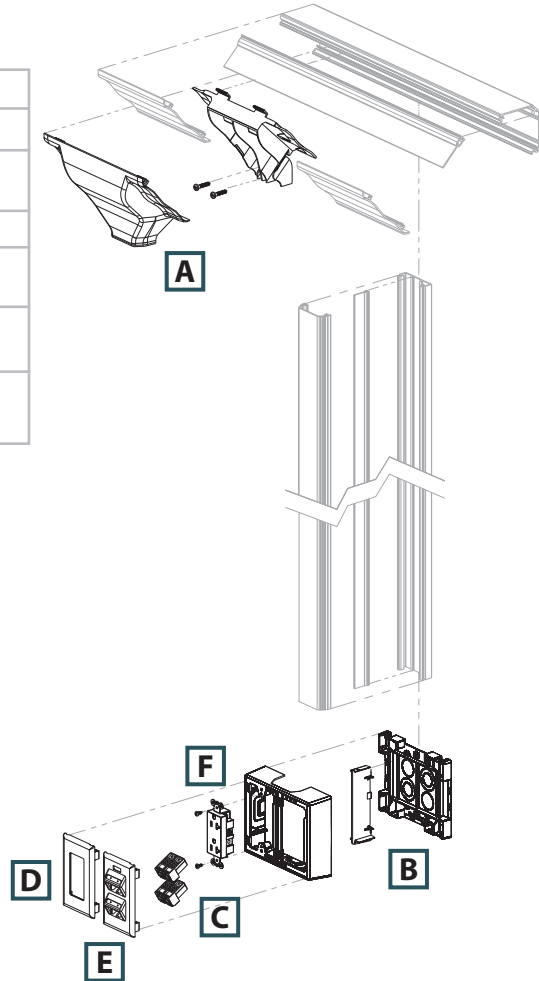

D1.  
Terminals

D2.  
Power  
Connectors

D3.  
Grounding  
Connectors

E1.  
Labeling  
Systems

E2.  
Labels

E3.  
Pre-Printed  
& Write-On  
Markers

E4.  
Permanent  
Identification

E5.  
Lockout/  
Tagout  
& Safety  
Solutions

F.  
Index

## Cove Configurations (continued)

### Exploded View 3

	Components Required	See page
A.	WCM35DBF = Cove raceway device box and faceplate adapter.	C2.91
B.	FP2RC = Pan-Way® Classic Series Faceplates for power and communication.	C2.60
C.	Mini-Com® Modules.	—
D.	ERU20 = 20 A rectangular electrical outlet (screws included).	C2.61

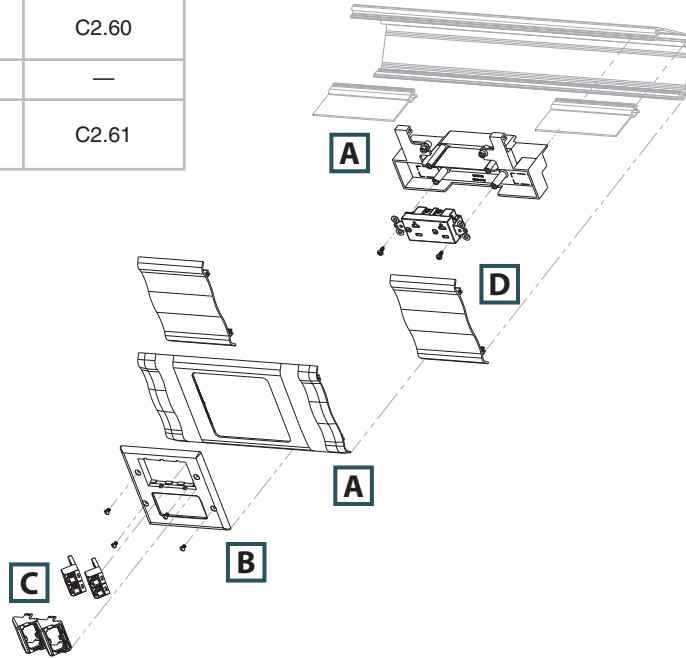

### Exploded View 4

	Components Required	See page
A.	WCM35DBF = Cove raceway device box and faceplate adapter.	C2.91
B.	Mini-Com® Modules.	—
C.	UIT70FH4 = Ultimate ID® Horizontal Snap-On Faceplate.	—

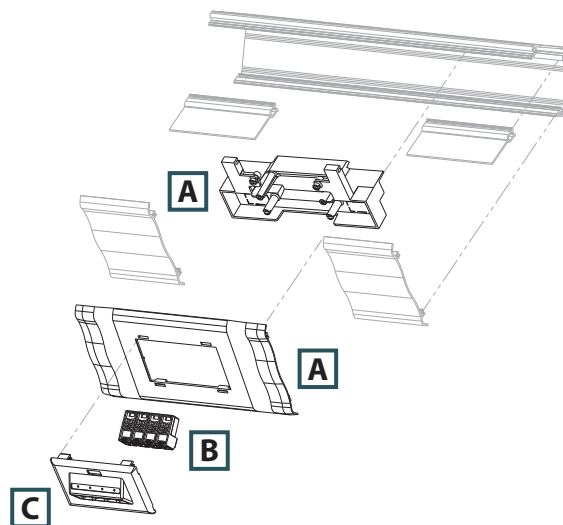

A.  
System  
Overview

B1.  
Cable Ties

B2.  
Cable  
Accessories

B3.  
Stainless  
Steel Ties

C1.  
Wiring  
Duct

C2.  
Surface  
Raceway

C3.  
Abrasion  
Protection

C4.  
Cable  
Management

D1.  
Terminals

D2.  
Power  
Connectors

D3.  
Grounding  
Connectors

E1.  
Labeling  
Systems

E2.  
Labels

E3.  
Pre-Printed  
& Write-On  
Markers

E4.  
Permanent  
Identification

E5.  
Lockout/  
Tagout  
& Safety  
Solutions

F.  
Index

A. System Overview



## Pan-Way® Cove Raceway System

B1. Cable Ties

- UL and CSA rated 600 V; meets UL 5A and CSA C22.2 No. 62.1-03 standards; FT4 rated
- Bend radius control is maintained throughout the entire cove raceway system as required by TIA/EIA-568-B and 569-B

- Tamper resistant
- Transitions to Panduit T-70, T-45, and LD profile raceway
- Cove raceway and fittings may be painted to blend with any decor
- Supplied with pre-punched mounting holes

B2. Cable Accessories

B3. Stainless Steel Ties

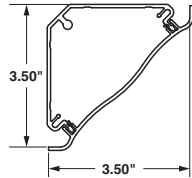

COVE RACEWAY  
Internal Area = 5.40 Sq. In.  
(3484 Sq. mm)

C1. Wiring Duct

C2. Surface Raceway



WCM35B

C3. Abrasion Protection

C4. Cable Management



WCM35C

D1. Terminals

D2. Power Connectors

D3. Grounding Connectors

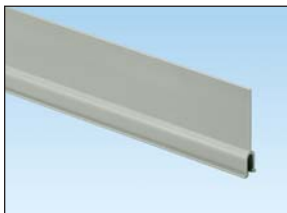

WCM35DW

E1. Labeling Systems

E2. Labels

E3. Pre-Printed & Write-On Markers

E4. Permanent Identification

E5. Lockout/Tagout & Safety Solutions

F. Index

Part Number	Part Description	Raceway Size	Color†	Length (Ft.)	Std. Ctn. Qty.
<b>Cove Raceway Base</b>					
<b>WCM35BIW8</b>	Cove raceway base is available in 8' lengths and is used for mounting in the horizontal corner between the ceiling and wall or vertical corner between walls.	3.50" x 3.50" (89.0mm x 89.0mm)	Off White	8	64
<b>Cove Raceway Cover</b>					
<b>WCM35CIW8</b>	Cove raceway cover available in 8' lengths.	—	Off White	8	64
<b>Cove Raceway Divider Wall</b>					
<b>WCM35DW8</b>	Cove raceway divider wall. Snaps onto rails in cove raceway base to create separate channels. Must use wire retainers to ensure channel separation per UL/CSA. Available in 8' lengths.	—	Gray	8	64







†All parts available in IW (Off White) only except for WCM35DW8 which is available in gray only.  
Order number of feet required in multiples of standard carton quantity.  
Order raceway base and cover separately.





## Pan-Way® Cove Raceway Fittings

- Cove raceway fittings are designed to maintain the TIA/EIA-568-B and 569-B required minimum bend radius for high performance copper and fiber optic cabling systems

Image	Part Number	Part Description	Color‡	Std. Pkg. Qty.	Std. Ctn. Qty.
	<b>WCM35CC</b> <b>WCM35IC</b>	<b>WCM35CCIW-X</b> Cover coupler fittings. Used to join two pieces of cove raceway cover together.	Off White	10	100
	<b>WCM35OC</b> <b>WCM35T</b>	<b>WCM35ICIW</b> Inside corner fitting. Used to join cove raceway at inside corners. Maintains a minimum 1" bend radius of cabling. <b>WCM35OCIW</b> Outside corner fitting. Used to join cove raceway at outside corners. Maintains a minimum 1" bend radius of cabling.	Off White	1	10
	<b>WCM35TI</b> <b>WCM35EC</b>	<b>WCM35TIW</b> Tee fitting. Used to join sections of cove raceway to form a "tee" junction. Maintains a minimum 1" bend radius of cabling. <b>WCM35TI</b> Tee fitting insert. Mounts inside cove raceway tee fitting to maintain channel separation at tee junctions. Maintains a minimum 1" bend radius of cabling.	Off White Gray	1	10
	<b>WCM35TR</b> <b>WCM35TR5</b>	<b>WCM35ECIW</b> End cap fitting. Used to terminate or enter cove raceway. Includes breakouts for 1/2" and 3/4" conduit. <b>WCM35TRIW</b> Transition fitting. Used to transition from cove raceway to Pan-Way® T-45 raceway or LD profile raceway.	Off White	1	10
	<b>WCM35TR10</b> <b>WCM35TR70</b>	<b>WCM35TR5IW</b> Low profile transition fitting. Used to transition from cove raceway to LD/LDPH5. <b>WCM35TR10IW</b> Low profile transition fitting. Used to transition from cove raceway to LD/LDPH10. <b>WCM35TR70IW</b> Low profile transition fitting. Used to transition from cove raceway to T-70.	Off White	1	10
	<b>WCM35DBF</b> <b>WCM35BF</b>	<b>WCM35DBFIW</b> Device box and faceplate adapter. Used in cove raceway to install single or double gang power and/or data devices in-line. Will accept snap-on or screw-on single gang faceplate or screw-on double gang faceplate. Note: Will accept GFCI or TVSS outlets in single gang configuration only. <b>WCM35BFIW</b> Backfeed fitting. Inserts allow cable entry and exit through the back of the raceway and conduit. Breakouts include 1/2", 3/4", and 1".	Off White	1	10
	<b>WCM35WR-X</b>	<b>WCM35WR-X</b> Wire retainer. Holds wires in place. Will not interfere with cover installation.	Gray	10	—

‡All parts available in IW (Off White) only except WCM35WR-X and WCM35TI which are available in gray only.

A.  
System  
Overview

B1.  
Cable Ties

B2.  
Cable  
Accessories

B3.  
Stainless  
Steel Ties

C1.  
Wiring  
Duct

C2.  
Surface  
Raceway

C3.  
Abrasion  
Protection

C4.  
Cable  
Management

D1.  
Terminals

D2.  
Power  
Connectors

D3.  
Grounding  
Connectors

E1.  
Labeling  
Systems

E2.  
Labels

E3.  
Pre-Printed  
& Write-On  
Markers

E4.  
Permanent  
Identification

E5.  
Lockout/  
Tagout  
& Safety  
Solutions

F.  
Index

A. System Overview

## Cable Fill Capacities for Cove Raceway

This information is to be used as a guide in selecting the proper size raceway. The maximum amounts may vary according to the cable installation methods, straightness of cables, etc.

B1. Cable Ties

B2. Cable Accessories

B3. Stainless Steel Ties

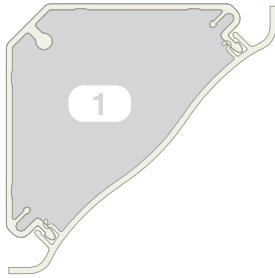

A = 5.4 in.<sup>2</sup>

**Cable fill #1:** Open channel without devices.



A = 5.0 in.<sup>2</sup>

**Cable fill #2:** Open channel with wire retainer.



3A = 2.4 in.<sup>2</sup>    3B = 2.4 in.<sup>2</sup>

**Cable fill #3:** Divided channel (power and data) with wire retainer and divider wall.

C2. Surface Raceway

C3. Abrasion Protection

C4. Cable Management

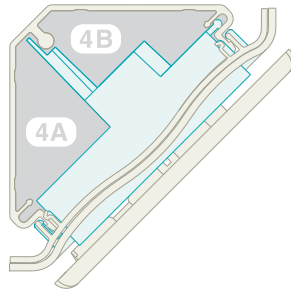

A = 1.6 in.<sup>2</sup>

A = 1.4 in.<sup>2</sup>

**Cable fill #4:** Divided channel (power and data) with device box and faceplate.



A = 1.8 in.<sup>2</sup>

A = 2.4 in.<sup>2</sup>

**Cable fill #5:** Divided channel (power and data) with low profile transition insert.

D1. Terminals

D2. Power Connectors

D3. Grounding Connectors

**SPEC = 40% cable fill** – The recommended design in cable capacity, leaves room for future moves, adds, and changes.

**MAX for Data = 60% cable fill** – The maximum cable quantity based on cable interweaving and packing factors.

**MAX for Power cable fill** – The maximum of electrical cables based on UL temperature rise test.

E1. Labeling Systems

E2. Labels

E3. Pre-Printed & Write-On Markers

E4. Permanent Identification

E5. Lockout/Tagout & Safety Solutions

F. Index

	Raceway Type and Configuration	Fill Area (In. <sup>2</sup> )	Electrical Cables			Data Grade Cables		Data Grade Cables		Audio/Video		Fiber Optic Cable			
			14 AWG	12 AWG	10 AWG	24 AWG/UTP CM		24 AWG/UTP CM		RG6		2 Strand			
			THHN/T90			Category 6		Category 6A							
			0.111	0.130	0.164	Dia. = 0.250		Dia. = 0.330		Dia. = 0.275		Dia. = 0.175			
			FILL			FILL		FILL		FILL		FILL		FILL	
MAX			MAX		SPEC		SPEC		SPEC		SPEC				
(UL Temp Rise Test)			(40%)		(60%)		(40%)		(60%)		(40%)		(60%)		
1.	WCM35: No devices.	5.4	50	40	30	44	66	25	37	36	54	89	134		
2.	WCM35: Using wire retainer – no devices.	5.0	50	40	30	40	61	23	35	33	50	83	124		
3A.	WCM35: Power and data using wire retainer and divider wall.	2.4	—	—	—	19	29	11	16	16	24	39	59		
3B.		2.4	30	25	20	—	—	—	—	—	—	—	—		
4A.	WCM35: Power and data using device box and faceplate adapter.	1.6	—	—	—	13	19	7	11	10	16	26	39		
4B.		1.4	25	25	20	—	—	—	—	—	—	—	—		
5A.	WCM35: Power and data using low profile transition insert.	1.8	25	25	20	—	—	—	—	—	—	—	—		
5B.		2.4	—	—	—	20	30	11	17	16	25	41	62		

AWG dimensions represent typical outer cable diameter in inches.

## PAN-WAY® OFFICE FURNITURE RACEWAY

Pan-Way® Office Furniture Raceway is a one-piece single channel system designed to route data cabling along the top of office furniture partitions. Outlets can be positioned at any point along the partition at desk level or in the corner at the intersection of two partitions. Office furniture raceway has a tamper resistant closure design, which protects sensitive cabling from accidental damage and discourages unauthorized access, yet the system is accessible by a qualified installer for moves, adds, and changes.



- Designed for desktop terminations which utilize the typically unused area of the cubicle
- Fittings meet TIA/EIA bend radius requirements preventing cable performance degradation, yet maintain original aesthetic "squared corner" styling of furniture
- Designed to work with major office furniture manufacturer's panels (such as STEELCASE\*, HERMAN MILLER™ and others)
- Robust design includes a one-piece hinge and tamper resistant closure design which increases product stability and reduces inadvertent or unauthorized access to data cabling
- Designed for use with Panduit connectivity; also accepts common manufacturers' connectivity with use of a NEMA standard 70mm faceplate or module frame

The system includes a full complement of fittings, accessories, and termination options. Pan-Way® Office Furniture Raceway is available in four popular colors to blend with most office furniture systems and creates a virtually invisible cost effective routing solution.

\*STEELCASE is a registered trademark of Steelcase Development, Inc.

™HERMAN MILLER is a registered trademark of Herman Miller, Inc., Zeeland MI.

A.  
System  
Overview

B1.  
Cable Ties

B2.  
Cable  
Accessories

B3.  
Stainless  
Steel Ties

C1.  
Wiring  
Duct

C2.  
Surface  
Raceway

C3.  
Abrasion  
Protection

C4.  
Cable  
Management

D1.  
Terminals

D2.  
Power  
Connectors

D3.  
Grounding  
Connectors

E1.  
Labeling  
Systems

E2.  
Labels

E3.  
Pre-Printed  
& Write-On  
Markers

E4.  
Permanent  
Identification

E5.  
Lockout/  
Tagout  
& Safety  
Solutions

F.  
Index

A.  
System  
Overview

## Office Furniture Raceway Roadmap

B1.  
Cable Ties

B2.  
Cable  
Accessories

B3.  
Stainless  
Steel Ties

C1.  
Wiring  
Duct

C2.  
Surface  
Raceway

C3.  
Abrasion  
Protection

C4.  
Cable  
Management

D1.  
Terminals

D2.  
Power  
Connectors

D3.  
Grounding  
Connectors

E1.  
Labeling  
Systems

E2.  
Labels

E3.  
Pre-Printed  
& Write-On  
Markers

E4.  
Permanent  
Identification

E5.  
Lockout/  
Tagout  
& Safety  
Solutions

F.  
Index



Note: Office furniture raceway is designed to blend with its environment. Shown in white on office slate furniture for illustration purposes only.

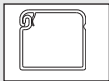

**1** OFR20\*\*6 – Office Furniture Raceway  
(page C2.98)

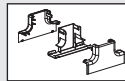

**L** OFR20MPT\*\* – Mid Panel Tee Fitting  
(page C2.100)

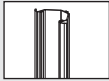

**A** OFCR70\*\*6 – Corner Raceway Base  
(page C2.98)

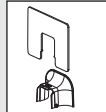

**M** OFR20WE\*\* – Wall Entrance Fitting  
(page C2.100)

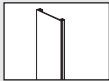

**B** OFCRC70\*\*6 – Corner Raceway Cover  
(page C2.98)

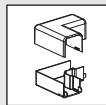

**N** OFR20RA\*\* – Right Angle Fitting  
(page C2.100)

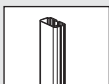

**C** OFVR5\*\*6 – Vertical Raceway  
(page C2.98)

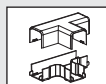

**O** OFR20T\*\* – Tee Fitting (page C2.100)

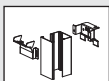

**D** OFR20CP\*\*8 – Communication Pole  
(page C2.99)

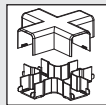

**P** OFR20CR\*\* – Cross Fitting  
(page C2.100)

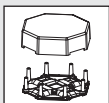

**E** OFR20OFCR70\*\*4 – Four Cubicle Drop  
Fitting (page C2.99)

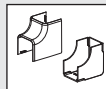

**Q** OFR20IC\*\* – Inside Corner Fitting  
(page C2.101)

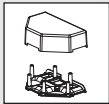

**F** OFR20OFCR70\*\*2 – Two Cubicle Drop  
Fitting (page C2.99)

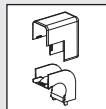

**R** OFR20OC\*\* – Outside Corner Fitting  
(page C2.101)

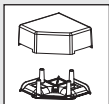

**G** OFR20OFCR70\*\*1 – One Cubicle Drop  
Fitting (page C2.99)



**S** OFR20CC\*\* – Coupler Fitting  
(page C2.101)

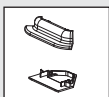

**H** OFCR70EC\*\* – End Cap Fitting  
(page C2.100)

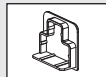

**T** OFR20EC\*\* – End Cap Fitting  
(page C2.101)

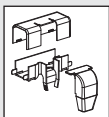

**J** OFR20SO\*\* – Spill-Over Fitting  
(page C2.100)

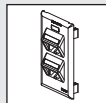

**U** OF70FV4\*\* – Vertical Sloped  
Communication Snap-On Faceplate  
(page C2.101)

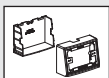

**K** OFR20DMB\*\* – Desk Mount Box  
(page C2.100)

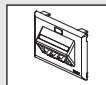

**V** OF70FH4\*\* – Horizontal Sloped  
Communication Snap-On Faceplate  
(page C2.101)

A.  
System  
Overview

## Office Furniture Configurations

B1.  
Cable Ties

### Exploded View 1

B2.  
Cable  
Accessories

	Components Required	See page
A.	OFR20OFCR70**4 = Four cubicle drop fitting.	C2.99
B.	OFCR70**6 = Corner raceway base.	C2.98
C.	OFCR70EC = End cap fitting.	C2.100
D.	OF70FV4 = Vertical sloped communication snap-on faceplate.	C2.100
E.	Mini-Com® Modules.	—
F.	OFCRC70**6 = Corner raceway cover.	C2.98

B3.  
Stainless  
Steel Ties

C1.  
Wiring  
Duct

C2.  
Surface  
Raceway

C3.  
Abrasion  
Protection

C4.  
Cable  
Management

D1.  
Terminals

D2.  
Power  
Connectors

D3.  
Grounding  
Connectors

E1.  
Labeling  
Systems

E2.  
Labels

E3.  
Pre-Printed  
& Write-On  
Markers

E4.  
Permanent  
Identification

E5.  
Lockout/  
Tagout  
& Safety  
Solutions

F.  
Index

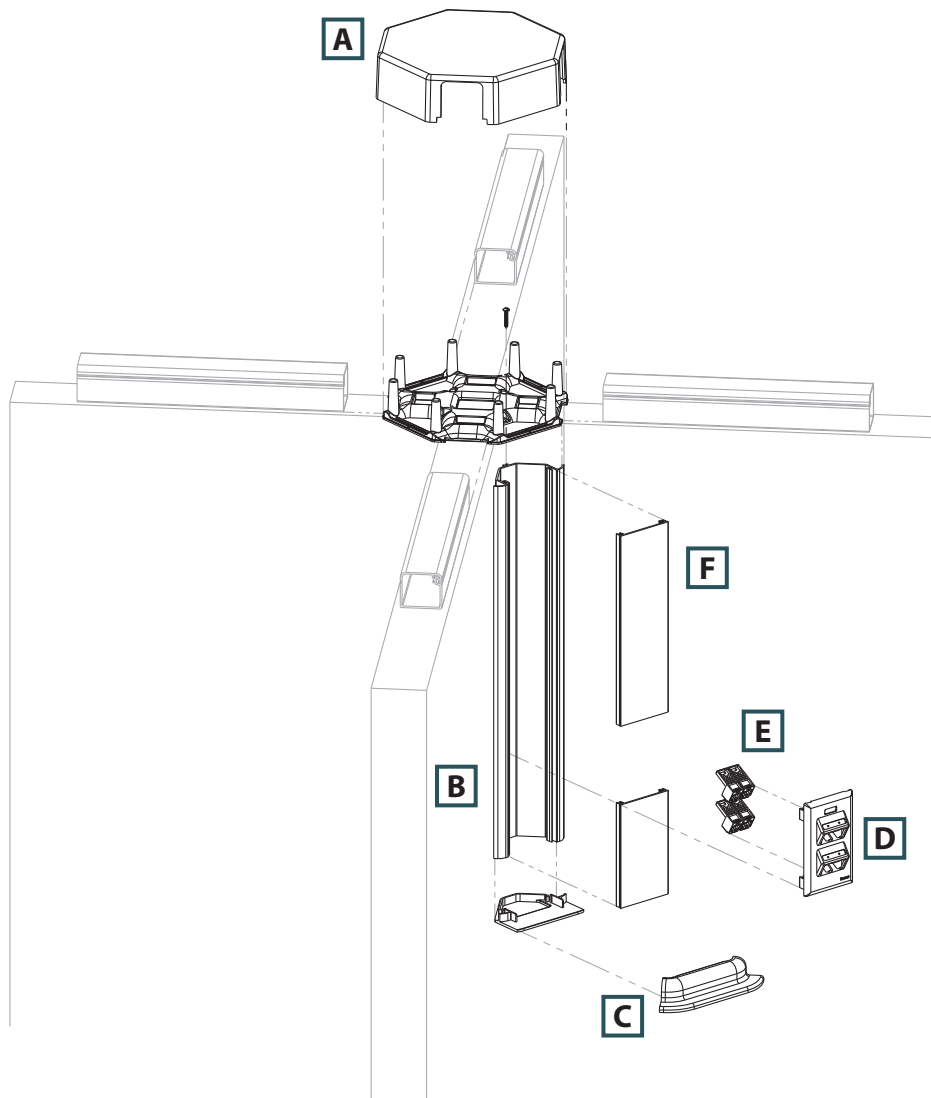

## Office Furniture Configurations (continued)

### Exploded View 2

	Components Required	See page
A.	OFR20SO** = Spill-over fitting.	C2.100
B.	OFVR5**6 = Vertical raceway.	C2.98
C.	OFR20DMB = Desk mount box.	C2.100
D.	Mini-Com® Modules.	—
E.	OF70FH4** = Horizontal sloped communication snap-on faceplate.	C2.101

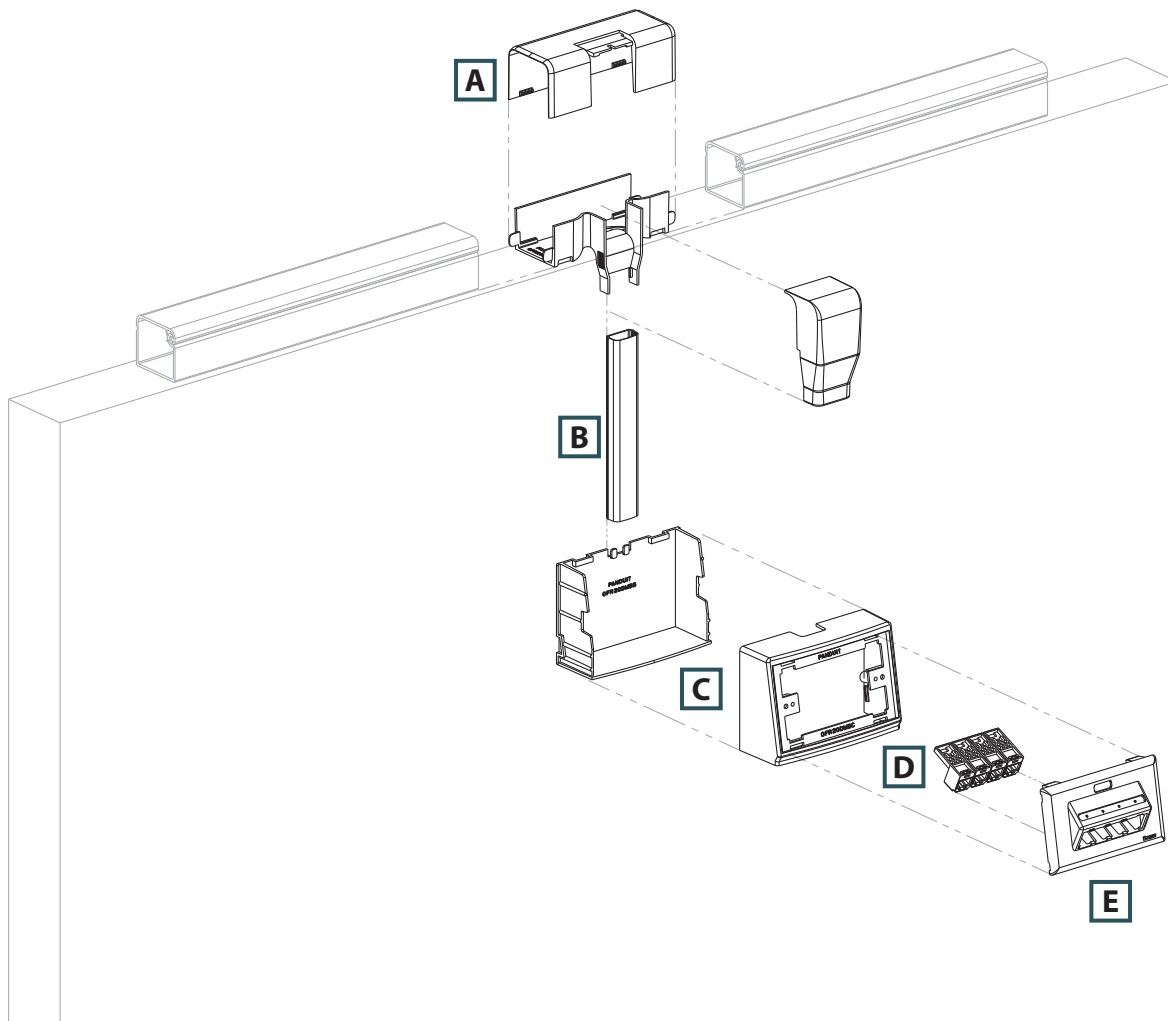

A.  
System  
Overview

B1.  
Cable Ties

B2.  
Cable  
Accessories

B3.  
Stainless  
Steel Ties

C1.  
Wiring  
Duct

C2.  
Surface  
Raceway

C3.  
Abrasion  
Protection

C4.  
Cable  
Management

D1.  
Terminals

D2.  
Power  
Connectors

D3.  
Grounding  
Connectors

E1.  
Labeling  
Systems

E2.  
Labels

E3.  
Pre-Printed  
& Write-On  
Markers

E4.  
Permanent  
Identification

E5.  
Lockout/  
Tagout  
& Safety  
Solutions

F.  
Index

A. System Overview

## Pan-Way® Office Furniture Raceway System

B1. Cable Ties

B2. Cable Accessories

B3. Stainless Steel Ties

C1. Wiring Duct

C2. Surface Raceway

C3. Abrasion Protection

C4. Cable Management

D1. Terminals

D2. Power Connectors

D3. Grounding Connectors

E1. Labeling Systems

E2. Labels

E3. Pre-Printed & Write-On Markers

E4. Permanent Identification

E5. Lockout/Tagout & Safety Solutions

F. Index

- UL listed in accordance with UL 5C requirements for Class 2 Communication Cable Management Systems
- Maintains bend radius control throughout the entire office furniture raceway system as required by TIA/EIA-568-B and 569-B
- Faceplates are compliant with the labeling requirements of the TIA/EIA-606-A standard
- Robust design and tamper resistant closure increases product stability and prevents damage to cabling during and after installation
- Product supplied with adhesive backing for fast and easy installation
- Creates a virtually invisible solution for routing data cables on panels from all common manufacturers with a top cap width between 1.88 and 2.30 inches
- Designed for use with Pan-Net® Connectivity, also accepts all common manufacturers' connectivity with use of a NEMA standard 70mm faceplate or module frame

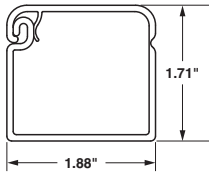

OFFICE FURNITURE RACEWAY  
Internal Area = 2.31 Sq. In.



Office Beige (OB)



Office Gray (OG)

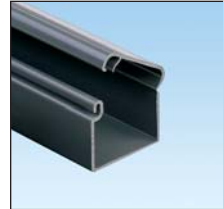

Office Slate (OS)



Medium Tone (MT)



OFR20

Part Number	Part Description	Raceway Size	Color‡	Length (Ft.)	Std. Pkg. Qty.	Std. Ctn. Qty.
<b>OFR20OB6</b>	One-piece single channel low voltage raceway with adhesive tape backing for data cable routing along top of modular furniture partitions. Available in 6' lengths.	1.88" x 1.71" (48.0mm x 44.0mm)	Office Beige	6	6	48
<b>OFR20OB8</b>	One-piece single channel low voltage raceway with adhesive tape backing for data cable routing along top of modular furniture partitions. Available in 8' lengths.	1.88" x 1.71" (48.0mm x 44.0mm)	Office Beige	8	8	64

‡For other colors, replace OB (Office Beige) with OS (Office Slate), OG (Office Gray), or MT (Medium Tone). Order number of feet required in multiples of standard carton quantity.

## Pan-Way® Office Furniture Raceway Fittings

- Office furniture raceway fittings have been designed to maintain the TIA/EIA required 1 inch minimum bend radius for high performance copper and fiber optic cabling systems

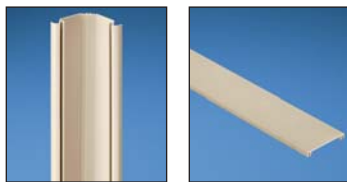

OFCR70

OFCRC70



OFVR5

Part Number	Part Description	Labels Required	Color‡	Std. Pkg. Qty.	Std. Ctn. Qty.
<b>OFCR70OB6</b>	Office furniture corner raceway base. Used to terminate low voltage data cabling in the corner at the intersection of modular office furniture panels. Accepts 70mm standard faceplates. Available in 6' lengths.	—	Office Beige	6	48
<b>OFCRC70OB6</b>	Office furniture corner raceway cover. Available in 6' lengths.	—	Office Beige	6	48
<b>OFVR5OB6</b>	Office furniture vertical raceway. One-piece single channel raceway used to connect OFR20**6 or OFR20**8 to desk mount box (OFR20DMB**) and must be used with OFR20SO** or OFR20DSO**. Available in 6' lengths.	—	Office Beige	6	120

‡For other colors, replace OB (Office Beige) with OS (Office Slate), OG (Office Gray), or MT (Medium Tone). Computer printable labels found on pages E2.4 and E2.5





## Pan-Way® Office Furniture Raceway Fittings (continued)

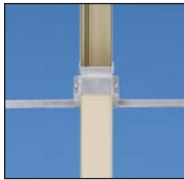

OFR20CP



OFR20OFCR70\*\*4

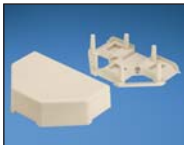

OFR20OFCR70\*\*2



OFR20OFCR70\*\*1



OFR20OFCR70\*\*1P



OFR20OFCR70\*\*2P



OFR20OFCR70\*\*4P

Part Number	Part Description	Labels Required	Color‡	Std. Pkg. Qty.	Std. Ctn. Qty.
<b>OFR20CPOB8</b>	Communication pole. Allows for data cable entry into office furniture raceway from suspended ceiling. 8' pole allows maximum 7' distance from top of furniture partition to ceiling. Must be used with OFR20MPT**. Note: Not intended for use at intersection of furniture panels.	—	Office Beige	1	—
<b>OFR20OFCR70OB4</b>	Four cubicle drop fitting. Allows the transition from office furniture raceway run horizontally along partition wall to office furniture corner raceway mounted vertically in four cubicles at the intersection of partitions. Fitting maintains 1" minimum bend radius of cabling. Supplied with adhesive tape.	—	Office Beige	1	10
<b>OFR20OFCR70OB2</b>	Two cubicle drop fitting. Allows the transition from office furniture raceway run horizontally along partition wall to office furniture corner raceway mounted vertically in two cubicles at the intersection of partitions. Fitting maintains 1" minimum bend radius of cabling. Supplied with adhesive tape.	—	Office Beige	1	10
<b>OFR20OFCR70OB1</b>	One cubicle drop fitting. Allows the transition from office furniture raceway run horizontally along partition wall to office furniture corner raceway mounted vertically in one cubicle at the intersection of partitions. Fitting maintains 1" minimum bend radius of cabling. Supplied with adhesive tape.	—	Office Beige	1	10
<b>OFR20OFCR70OB1P</b>	One cubicle drop bypass fitting. Allows the transition from office furniture raceway run horizontally along partition wall, around existing furniture pole, to office furniture corner raceway mounted vertically in one cubicle at the intersection of partitions. Fitting maintains 1" minimum bend radius of cabling. Supplied with adhesive tape.	—	Office Beige	1	10
<b>OFR20OFCR70OB2P</b>	Two cubicle drop bypass fitting. Allows the transition from office furniture raceway run horizontally along partition wall, around existing furniture pole, to office furniture corner raceway mounted vertically in two cubicles at the intersection of partitions. Fitting maintains 1" minimum bend radius of cabling. Supplied with adhesive tape.	—	Office Beige	1	10
<b>OFR20OFCR70OB4P</b>	Four cubicle drop bypass fitting. Allows the transition from office furniture raceway run horizontally along partition wall, around existing furniture pole, to office furniture corner raceway mounted vertically in four cubicles at the intersection of partitions. Fitting maintains 1" minimum bend radius of cabling. Supplied with adhesive tape.	—	Office Beige	1	10

‡For other colors, replace OB (Office Beige) with OS (Office Slate), OG (Office Gray), or MT (Medium Tone).  
Computer printable labels found on pages E2.4 and E2.5

Table continues on page C2.100

A.  
System  
Overview

B1.  
Cable Ties

B2.  
Cable  
Accessories

B3.  
Stainless  
Steel Ties

C1.  
Wiring  
Duct

C2.  
Surface  
Raceway

C3.  
Abrasion  
Protection

C4.  
Cable  
Management

D1.  
Terminals

D2.  
Power  
Connectors

D3.  
Grounding  
Connectors

E1.  
Labeling  
Systems

E2.  
Labels

E3.  
Pre-Printed  
& Write-On  
Markers

E4.  
Permanent  
Identification

E5.  
Lockout/  
Tagout/  
& Safety  
Solutions

F.  
Index

A. System Overview

B1. Cable Ties

B2. Cable Accessories

B3. Stainless Steel Ties

C1. Wiring Duct

C2. Surface Raceway

C3. Abrasion Protection

C4. Cable Management

D1. Terminals

D2. Power Connectors

D3. Grounding Connectors

E1. Labeling Systems

E2. Labels

E3. Pre-Printed & Write-On Markers

E4. Permanent Identification

E5. Lockout/Tagout & Safety Solutions

F. Index



## Pan-Way® Office Furniture Raceway Fittings (continued)



**OFRCR70EC**



**OFR20SO**



**OFR20DSO**



**OFR20DMB**



**OFR20MPT**



**OFR20WE**



**OFR20RA**



**OFR20T**



**OFR20CR**

Part Number	Part Description	Labels Required	Color‡	Std. Pkg. Qty.	Std. Ctn. Qty.
<b>OFCR70ECOB</b>	Corner raceway end cap fitting. Opening allows cord passage through fitting such as monitor and keyboard cables. Supplied with adhesive tape.	—	Office Beige	1	10
<b>OFR20SOOB</b>	Spill-over fitting. Allows transition from office furniture raceway run horizontally along partition wall to office furniture vertical raceway in one location. Adjustable fitting maintains 1" minimum bend radius of cabling and works with various panel widths between 1.88"– 2.30" (47.7mm - 58mm). Supplied with adhesive tape.	—	Office Beige	1	10
<b>OFR20DSOOB</b>	Double spill-over fitting. Fitting is used to spill over both sides of the furniture partitions at the same location. Incorporates a built-in, yet removable end cap that eliminates the need for additional raceway and fittings to terminate the pathway.	—	Office Beige	1	10
<b>OFR20DMBOB</b>	Desk mount box. Box accepts office furniture snap-on faceplates as well as 70mm NEMA standard screw-on faceplates. Designed for use with OFVR5**6 raceway and OFR20SO**, OFR20DSO** spill-over fittings. Supplied with adhesive tape.	—	Office Beige	1	10
<b>OFR20MPTOB</b>	Mid-panel tee fitting. Used to connect communication pole to office furniture raceway run horizontally along partition wall. Supplied with adhesive tape. Note: not intended for use at intersection of furniture panels.	—	Office Beige	1	10
<b>OFR20WEOB</b>	Wall entrance fitting. Allows entry from wall to office furniture raceway run horizontally along partition walls. Fitting includes bend radius protection and trim plate to cover wall opening. Requires minimum wall opening of 4.5"W x 3.0"H (114.3mm x 76.2mm). Supplied with adhesive tape.	—	Office Beige	1	10
<b>OFR20RAOB</b>	Right angle fitting. Used to join sections of office furniture raceway at 90° flat junction. Supplied with adhesive tape.	—	Office Beige	1	10
<b>OFR20TOB</b>	Tee fitting. Used to create an undivided tee junction between sections of office furniture raceway. Supplied with adhesive tape.	—	Office Beige	1	10
<b>OFR20CROB</b>	Cross fitting. Used to join sections of office furniture raceway at four corners. Supplied with adhesive tape.	—	Office Beige	1	10

‡For other colors, replace OB (Office Beige) with OS (Office Slate), OG (Office Gray), or MT (Medium Tone).  
Computer printable labels found on pages E2.4 and E2.5



## Pan-Way® Office Furniture Raceway Fittings (continued)

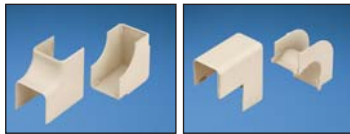

OFR20IC

OFR20OC



OFR20CC

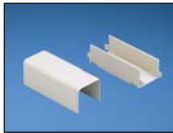

OFR20LC



OFR20EC

OF70FH2



OF70FV2

OF70FH4

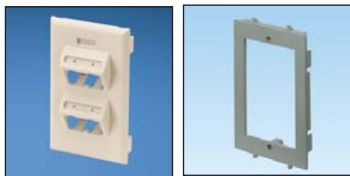

OF70FV4

T70SDB-X

Part Number	Part Description	Labels Required	Color‡	Std. Pkg. Qty.	Std. Ctn. Qty.
<b>OFR20ICOB</b>	Inside corner fitting. Used to join sections of office furniture raceway at inside corner. Supplied with adhesive tape.	—	Office Beige	1	10
<b>OFR20OCOB</b>	Outside corner fitting. Used to join sections of office furniture raceway at outside corner. Supplied with adhesive tape.	—	Office Beige	1	10
<b>OFR20CCOB-X</b>	Coupler fitting. For use with office furniture raceway.	—	Office Beige	10	100
<b>OFR20LCOB</b>	Long coupler fitting (with base). Used to bridge office furniture raceway between panel sections. Can also be used to fill void left by spill-over fitting, when furniture partitions are reconfigured. Supplied with adhesive tape.	—	Office Beige	1	10
<b>OFR20ECOB</b>	End cap fitting. Used to terminate office furniture raceway. Supplied with adhesive tape.	—	Office Beige	1	10
<b>OF70FH2OB</b>	Snap-on single gang horizontal sloped communication faceplate. Accepts up to two Panduit® Mini-Com® Modules (not included). No additional mounting hardware required. TIA/EIA-606-A compliant.	1-One Port 1-Two Port	Office Beige	1	10
<b>OF70FV2OB</b>	Snap-on single gang vertical sloped communication faceplate. Accepts up to two Panduit® Mini-Com® Modules (not included). No additional mounting hardware required. TIA/EIA-606-A compliant.	1-One Port 1-Two Port	Office Beige	1	10
<b>OF70FH4OB</b>	Snap-on single gang horizontal sloped communication faceplate. Accepts up to four Panduit® Mini-Com® Modules (not included). No additional mounting hardware required. TIA/EIA-606-A compliant.	1-One Port 1-Four Port	Office Beige	1	10
<b>OF70FV4OB</b>	Snap-on single gang vertical sloped communication faceplate. Accepts up to four Panduit® Mini-Com® Modules (not included). No additional mounting hardware required. TIA/EIA-606-A compliant.	1-One Port 2-Two Port	Office Beige	1	10
<b>T70SDB-X</b>	Standard faceplate bracket. Used to mount NEMA standard 70mm single gang screw-on faceplates. Can be used with T-70, Twin-70, TG-70 raceway and Pan-Pole™ Communication Pole.	—	Gray	10	—

‡For other colors, replace OB (Office Beige) with OS (Office Slate), OG (Office Gray), or MT (Medium Tone).  
Computer printable labels found on pages E2.4 and E2.5

A.  
System  
Overview

B1.  
Cable Ties

B2.  
Cable  
Accessories

B3.  
Stainless  
Steel Ties

C1.  
Wiring  
Duct

C2.  
Surface  
Raceway

C3.  
Abrasion  
Protection

C4.  
Cable  
Management

D1.  
Terminals

D2.  
Power  
Connectors

D3.  
Grounding  
Connectors

E1.  
Labeling  
Systems

E2.  
Labels

E3.  
Pre-Printed  
& Write-On  
Markers

E4.  
Permanent  
Identification

E5.  
Lockout/  
Tagout  
& Safety  
Solutions

F.  
Index

A.  
System  
Overview

## Cable Fill Capacities for Office Furniture Raceway

B1.  
Cable Ties

This information is to be used as a guide in selecting the proper size raceway. The maximum amounts may vary according to the cable installation methods, straightness of cables, etc.

B2.  
Cable  
Accessories

B3.  
Stainless  
Steel Ties



**A = 2.31 in.<sup>2</sup>**

**Cable fill #1:** Open channel without devices

C1.  
Wiring  
Duct

C2.  
Surface  
Raceway

C3.  
Abrasion  
Protection

**SPEC = 40% cable fill** – The recommended design in cable capacity, leaves room for future moves, adds, and changes.

**MAX for Data = 60% cable fill** – The maximum cable quantity based on cable interweaving and packing factors.

C4.  
Cable  
Management

D1.  
Terminals

D2.  
Power  
Connectors

D3.  
Grounding  
Connectors

E1.  
Labeling  
Systems

E2.  
Labels

E3.  
Pre-Printed  
& Write-On  
Markers

E4.  
Permanent  
Identification

E5.  
Lockout/  
Tagout  
& Safety  
Solutions

F.  
Index

Raceway Type and Configuration	Fill Area (In. <sup>2</sup> )	Electrical Cables			Data Grade Cables		Data Grade Cables		Audio/Video		Fiber Optic Cable	
		14 AWG	12 AWG	10 AWG	24 AWG/UTP CM	24 AWG/UTP CM	RG6		2 Strand			
		THHN/T90			Cat. 6		Cat. 6A		DIA. = 0.275		DIA. = 0.175	
		0.111	0.130	0.164	DIA. = 0.250		DIA. = 0.330		DIA. = 0.275		DIA. = 0.175	
		FILL			FILL		FILL		FILL		FILL	
		MAX	MAX	MAX	SPEC	MAX	SPEC	MAX	SPEC	MAX	SPEC	MAX
OFR20	2.3	—	—	—	18	28	10	16	15	23	38	57

AWG dimensions represent typical outer cable diameter in inches.

## PAN-POLE™ POWER AND COMMUNICATION POLES

Pan-Pole™ Power and Communication Poles provide industry-leading solutions for cable routing in the open office environment. Available with pre-terminated electrical outlets with divided channel for power and communication applications or as an open channel communication pole.



- Tamper resistant cover
- Bend radius control fitting (above ceiling) as required by TIA/EIA-568-B and 569-B.
- Complete with ceiling and floor mounting hardware

Pan-Pole™ Power and Communication Poles accept NEMA standard 70mm screw-on faceplates or superior Pan-Way® Snap-On Faceplates.

A.  
System  
Overview

B1.  
Cable Ties

B2.  
Cable  
Accessories

B3.  
Stainless  
Steel Ties

C1.  
Wiring  
Duct

C2.  
Surface  
Raceway

C3.  
Abrasion  
Protection

C4.  
Cable  
Management

D1.  
Terminals

D2.  
Power  
Connectors

D3.  
Grounding  
Connectors

E1.  
Labeling  
Systems

E2.  
Labels

E3.  
Pre-Printed  
& Write-On  
Markers

E4.  
Permanent  
Identification

E5.  
Lockout/  
Tagout  
& Safety  
Solutions

F.  
Index

A. System Overview



## Pan-Pole™ Power Pole

B1. Cable Ties

- Dual channel aluminum pole is equipped with pre-terminated electrical outlets and provides channel separation for the installation of communication cabling and modules

B2. Cable Accessories

- UL and CSA rated 600 V
- Available in 11 or 13 foot lengths and supplied with a non-metallic cover
- Electrical outlets are pre-wired

B3. Stainless Steel Ties

Pre-installed components include:

1. Blank non-metallic cover
2. Two 20 A factory wired rectangular outlets with wiring fed through power channel to base of power entry box

C1. Wiring Duct

C2. Surface Raceway

C3. Abrasion Protection

C4. Cable Management

D1. Terminals

D2. Power Connectors

D3. Grounding Connectors

E1. Labeling Systems

E2. Labels

E3. Pre-Printed & Write-On Markers

E4. Permanent Identification

E5. Lockout/Tagout & Safety Solutions

F. Index

3. Power entry with 1/2" and 3/4" conduit breakouts
4. Removable plate for power wiring connections
5. Ground screw pre-mounted behind removable plate

Supplied mounting hardware includes:

1. Entry end bend radius fitting
2. Ceiling T-bar bracket
3. Ceiling tile trim plate
4. End cap
5. End cap floor grip pad

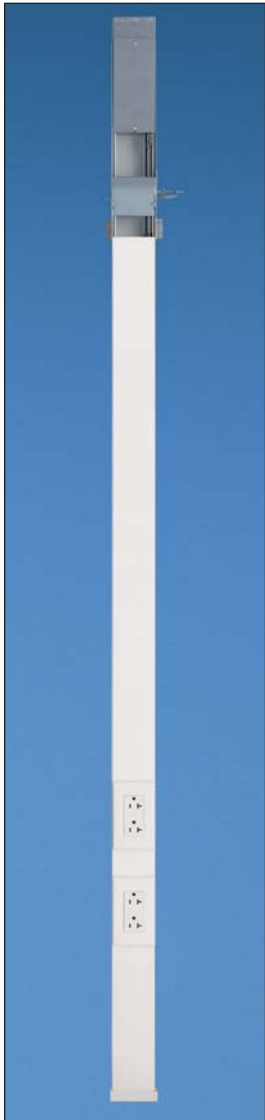

**PCPA11R20**  
**PCPA13R20**

Part Number	Part Description	Color‡	Std. Pkg. Qty.
<b>PCPA11R20IW</b>	Pan-Pole™ Power Pole assembly is supplied in 11' length for maximum ceiling height of 10'. Dual channel design allows for the installation of communication outlets.	Off White	1
<b>PCPA13R20IW</b>	Pan-Pole™ Power Pole assembly is supplied in 13' length for maximum ceiling heights of 12'. Dual channel design allows for the installation of communication outlets.	Off White	1

Communication components sold separately.

‡For other colors replace IW (Off White) with EI (Electric Ivory).

## Installation of Communication Outlets on Pan-Pole™ Power Pole

### Utilizing Standard Screw-On Faceplates

	Components Required	See page
A.	CPG** = Single gang rectangular screw-on faceplate (screws included).	C2.60
B.	CFG2** = Mini-Com® Module Frame – 2-port.	—
C.	Mini-Com® Modules.	—
D.	T70SDB-X = Standard faceplate bracket.	C2.40
E.	PCPA**R20 power pole.	C2.104

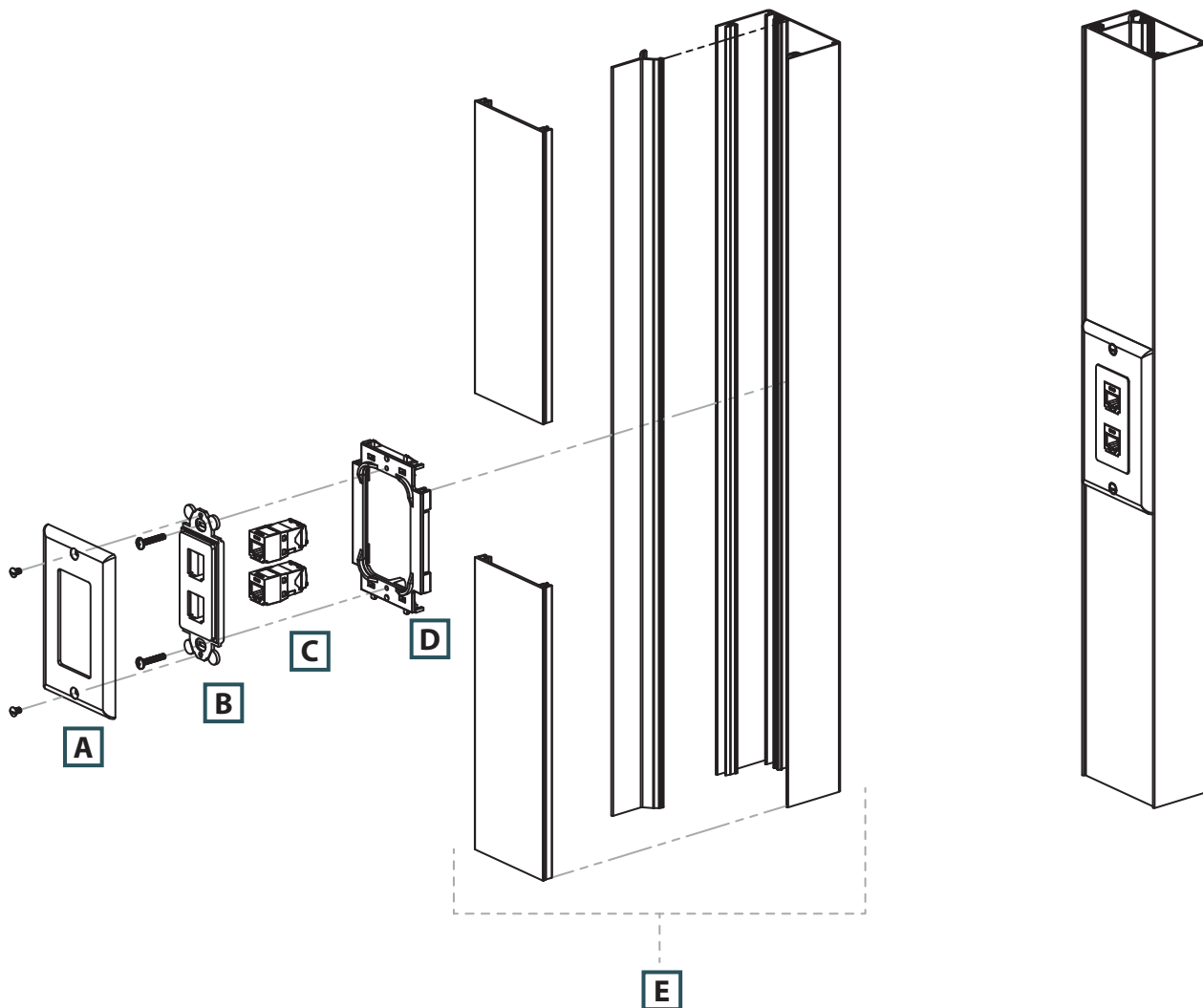

A.  
System  
Overview

B1.  
Cable Ties

B2.  
Cable  
Accessories

B3.  
Stainless  
Steel Ties

C1.  
Wiring  
Duct

C2.  
Surface  
Raceway

C3.  
Abrasion  
Protection

C4.  
Cable  
Management

D1.  
Terminals

D2.  
Power  
Connectors

D3.  
Grounding  
Connectors

E1.  
Labeling  
Systems

E2.  
Labels

E3.  
Pre-Printed  
& Write-On  
Markers

E4.  
Permanent  
Identification

E5.  
Lockout/  
Tagout  
& Safety  
Solutions

F.  
Index

A.  
System  
Overview

## Installation of Communication Outlets on Pan-Pole™ Power Pole (continued)

B1.  
Cable Ties

### Utilizing Panduit Snap-On Faceplates

B2.  
Cable  
Accessories

	Components Required	See page
A.	UIT70FV2** = Single gang vertical sloped communication snap-on faceplate.	—
B.	Mini-Com® Modules.	—
C.	PCPA**R20 power pole.	C2.104

B3.  
Stainless  
Steel Ties

C1.  
Wiring  
Duct

C2.  
Surface  
Raceway

C3.  
Abrasion  
Protection

C4.  
Cable  
Management

D1.  
Terminals

D2.  
Power  
Connectors

D3.  
Grounding  
Connectors

E1.  
Labeling  
Systems

E2.  
Labels

E3.  
Pre-Printed  
& Write-On  
Markers

E4.  
Permanent  
Identification

E5.  
Lockout/  
Tagout  
& Safety  
Solutions

F.  
Index

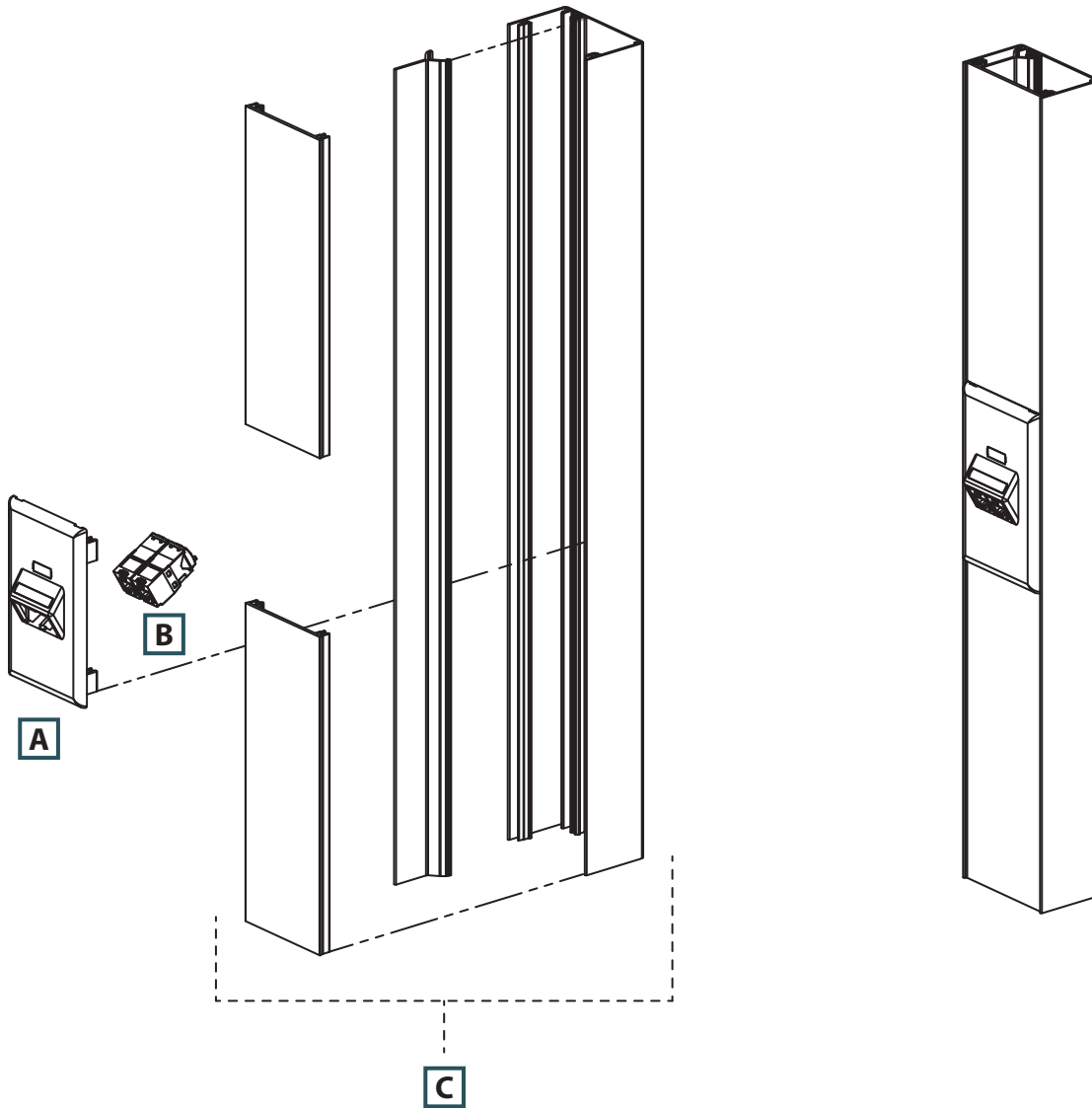



## Pan-Pole™ Communication Pole

- Single channel aluminum pole for routing low voltage communication cabling only
- Poles are available in 11 or 13 foot lengths and are supplied with a non-metallic cover

Supplied mounting hardware includes:

1. Entry end bend radius fitting
2. Ceiling T-bar bracket
3. Ceiling tile trim plate
4. End cap
5. End cap floor grip pad

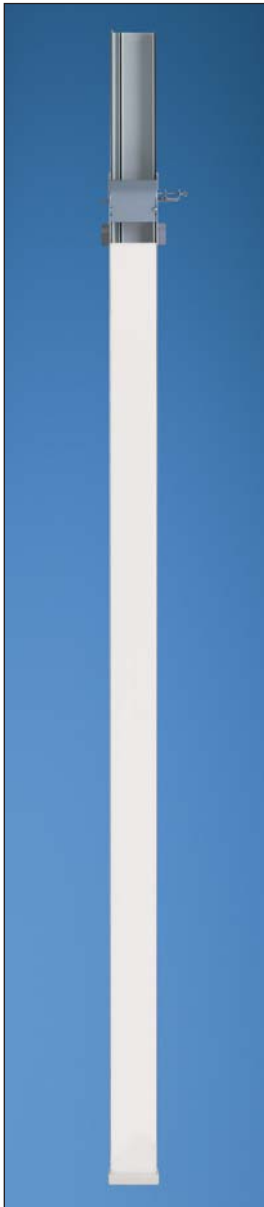

**PCPA11**  
**PCPA13**

Part Number	Part Description	Color‡	Std. Pkg. Qty.
<b>PCPA11IW</b>	Pan-Pole™ Communication Pole assembly is supplied in 11' length for maximum ceiling height of 10'.	Off White	1
<b>PCPA13IW</b>	Pan-Pole™ Communication Pole assembly is supplied in 13' length for maximum ceiling height of 12'.	Off White	1

Communication components sold separately.

‡For other colors replace IW (Off White) with EI (Electric Ivory).

A.  
System  
Overview

B1.  
Cable Ties

B2.  
Cable  
Accessories

B3.  
Stainless  
Steel Ties

C1.  
Wiring  
Duct

C2.  
Surface  
Raceway

C3.  
Abrasion  
Protection

C4.  
Cable  
Management

D1.  
Terminals

D2.  
Power  
Connectors

D3.  
Grounding  
Connectors

E1.  
Labeling  
Systems

E2.  
Labels

E3.  
Pre-Printed  
& Write-On  
Markers

E4.  
Permanent  
Identification

E5.  
Lockout/  
Tagout  
& Safety  
Solutions

F.  
Index

A.  
System  
Overview

## Installation of Communication Outlets on Pan-Pole™ Communication Pole

B1.  
Cable Ties

### Utilizing Standard Screw-On Faceplates

B2.  
Cable  
Accessories

	Components Required	See page
A.	CPG** = Single gang rectangular screw-on faceplate (screws included).	C2.60
B.	CFG2** = Mini-Com® Module Frame – 2-port.	—
C.	Mini-Com® Modules.	—
D.	T70SDB-X = Standard faceplate bracket.	C2.40
E.	PCPA** = Communication pole.	C2.107

B3.  
Stainless  
Steel Ties

C1.  
Wiring  
Duct

C2.  
Surface  
Raceway

C3.  
Abrasion  
Protection

C4.  
Cable  
Management

D1.  
Terminals

D2.  
Power  
Connectors

D3.  
Grounding  
Connectors

E1.  
Labeling  
Systems

E2.  
Labels

E3.  
Pre-Printed  
& Write-On  
Markers

E4.  
Permanent  
Identification

E5.  
Lockout/  
Tagout  
& Safety  
Solutions

F.  
Index

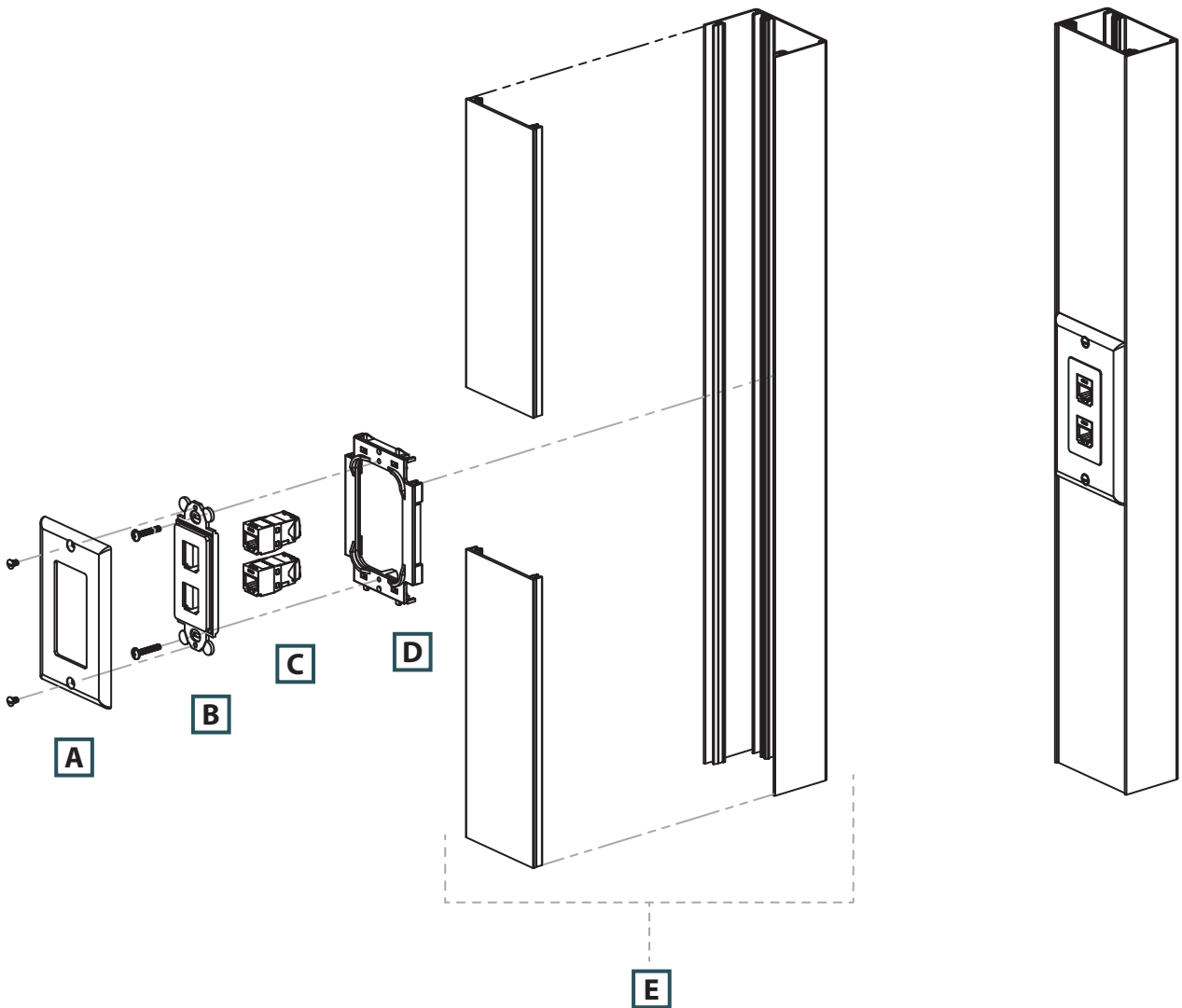

## Installation of Communication Outlets on Pan-Pole™ Communication Pole (continued)

### Utilizing Panduit Snap-On Faceplates

	Components Required	See page
A.	UIT70FV2** = Single gang vertical sloped communication snap-on faceplate.	—
B.	Mini-Com® Modules.	—
C.	PCPA** = Communication pole.	C2.107

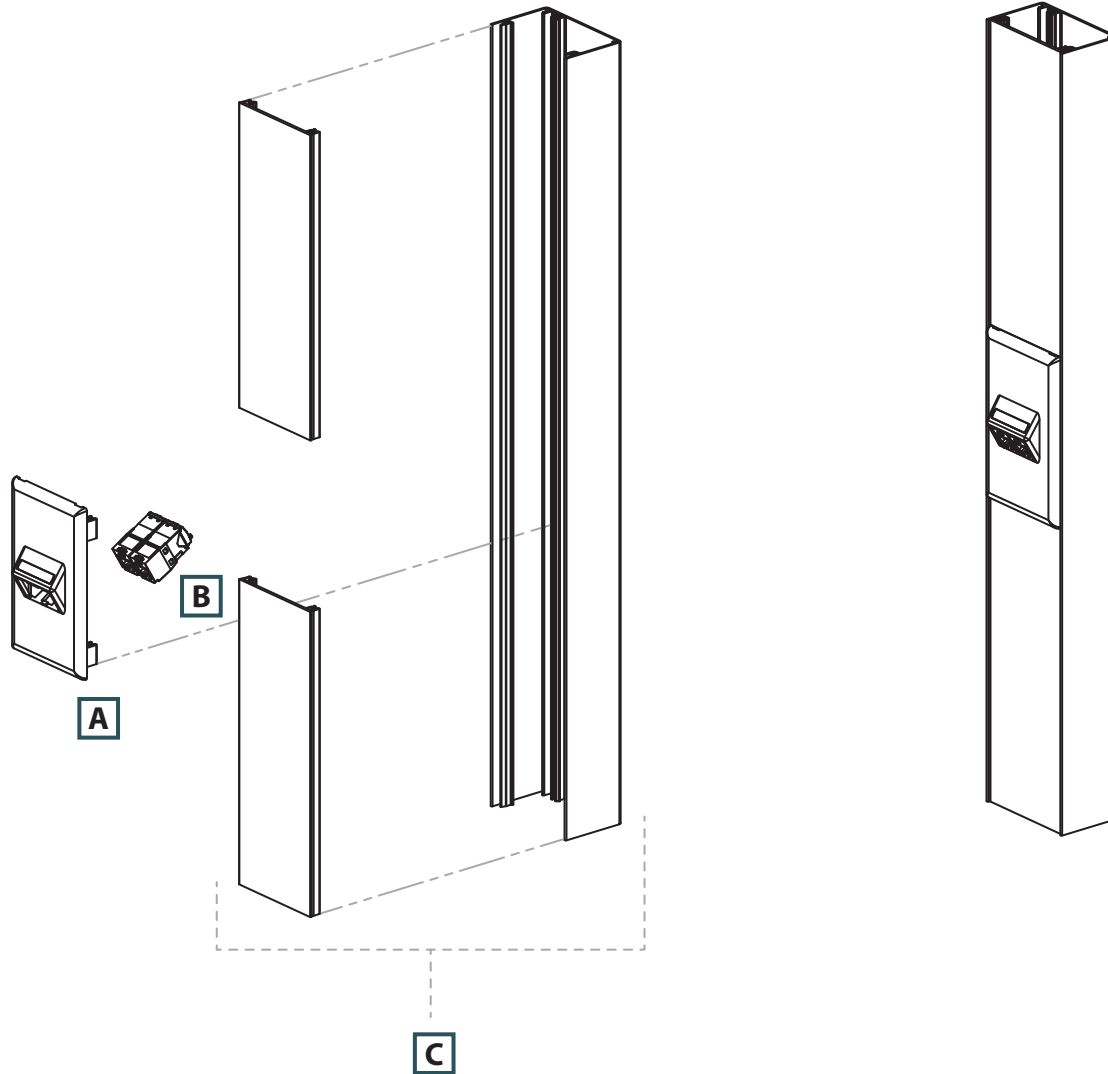

A.  
System  
Overview

B1.  
Cable Ties

B2.  
Cable  
Accessories

B3.  
Stainless  
Steel Ties

C1.  
Wiring  
Duct

C2.  
Surface  
Raceway

C3.  
Abrasion  
Protection

C4.  
Cable  
Management

D1.  
Terminals

D2.  
Power  
Connectors

D3.  
Grounding  
Connectors

E1.  
Labeling  
Systems

E2.  
Labels

E3.  
Pre-Printed  
& Write-On  
Markers

E4.  
Permanent  
Identification

E5.  
Lockout/  
Tagout  
& Safety  
Solutions

F.  
Index

A. System Overview



## Pan-Pole™ Extension Kits

B1. Cable Ties

B2. Cable Accessories

B3. Stainless Steel Ties

C1. Wiring Duct

C2. Surface Raceway

C3. Abrasion Protection

C4. Cable Management

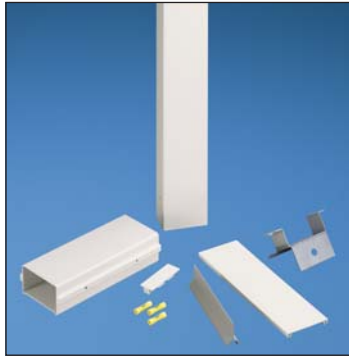

**PCPAK22**  
**PCPAK16**

Part Number	Part Description	Color‡	Std. Pkg. Qty.
<b>PCPAK22IW</b>	Pan-Pole™ Extension Kit. To extend the 11' pole to 22'. Extension kit includes: Fully assembled 11' pole with brace/coupler, additional wiring, and screws. Note: Customer needs to purchase a separate standard 11' pole to make the required length.	Off White	1
<b>PCPAK16IW</b>	Pan-Pole™ Extension Kit. To extend the 13' pole to 16'. Extension kit includes: fully assembled 3' pole with brace/coupler, additional wiring, and screws. Note: Customer needs to purchase a separate standard 13' pole to make the required length.	Off White	1

‡All product color is (IW) Off White.



## Pan-Pole™ Power Addition Kits and Standard Faceplate Bracket

- Power addition kits (UL listed for field installation) provide for the addition of power outlets
- Allow for the installation of up to three additional duplex outlets (five outlets max.)

- Outlets may be added to the existing factory wired circuit or one additional circuit may be added

D1. Terminals

D2. Power Connectors

D3. Grounding Connectors

E1. Labeling Systems

E2. Labels

E3. Pre-Printed & Write-On Markers

E4. Permanent Identification

E5. Lockout/Tagout & Safety Solutions

F. Index



**PCPAKR20**

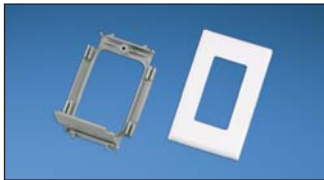

**PCPAKR**



**T70SDB-X**

Part Number	Part Description	Color‡	Std. Pkg. Qty.	Std. Ctn. Qty.
<b>PCPAKR20IW</b>	Power addition kit includes 20 A rectangular outlet with two mounting screws, outlet mounting bracket with one mounting screw, and snap-on faceplate.	Off White	1	10
<b>PCPAKR1W</b>	Power addition kit includes outlet mounting bracket with one mounting screw and snap-on faceplate. <i>Rectangular power outlet purchased separately.</i>	Off White	1	10
<b>T70SDB-X</b>	Standard faceplate bracket. Used to mount NEMA standard 70mm single gang screw-on faceplates. Can be used with T-70, Twin-70, TG-70 raceway and Pan-Pole™ Communication Pole.	Gray	10	—

‡For other colors replace IW (Off White) with EI (Electric Ivory).

When purchasing power addition kit with 20A outlet, use with Pan-Pole™ Power Pole, PCPA11R20IW and PCPA13R20IW.

When purchasing power addition it without outlet, rectangular power outlet needs to be purchased separately. Use with Pan-Pole™ Power Pole, PCPA11R20EI and PCPA13R20EI.



## Pan-Pole™ Replacement Parts



PCPKIT



PCPTP



PCPEC



PCPBRC

Part Number	Part Description	Color	Std. Pkg. Qty.	Std. Ctn. Qty.
<b>PCPKITIW</b>	Replacement parts include: bend radius control ramp, two thumb screws, one two-piece ceiling trim plate and one end cap with floor grip pad. Also available in EI (Electric Ivory).	Off White	1	5
<b>PCPTPIW</b>	Replacement ceiling trim plate.	Off White	1	—
<b>PCPECIW</b>	Replacement end cap with floor grip pad. Also available in EI (Electric Ivory).	Off White	1	—
<b>PCPBRC</b>	Replacement bend radius control ramp with T-bar bracket for attaching pole to T-bar. Includes mounting screws.	Gray	1	—

A.  
System  
Overview

B1.  
Cable Ties

B2.  
Cable  
Accessories

B3.  
Stainless  
Steel Ties

C1.  
Wiring  
Duct

C2.  
Surface  
Raceway

C3.  
Abrasion  
Protection

C4.  
Cable  
Management

D1.  
Terminals

D2.  
Power  
Connectors

D3.  
Grounding  
Connectors

E1.  
Labeling  
Systems

E2.  
Labels

E3.  
Pre-Printed  
& Write-On  
Markers

E4.  
Permanent  
Identification

E5.  
Lockout/  
Tagout  
& Safety  
Solutions

F.  
Index

A. System Overview

## Cable Fill Capacities for Pan-Pole™ Power and Communication Poles

The maximum amounts may vary according to the cable installation methods, straightness of cables, etc.

B1. Cable Ties

B2. Cable Accessories

B3. Stainless Steel Ties

C1. Wiring Duct

C2. Surface Raceway

C3. Abrasion Protection

C4. Cable Management

D1. Terminals

D2. Power Connectors

D3. Grounding Connectors

E1. Labeling Systems

E2. Labels

E3. Pre-Printed & Write-On Markers

E4. Permanent Identification

E5. Lockout/Tagout & Safety Solutions

F. Index

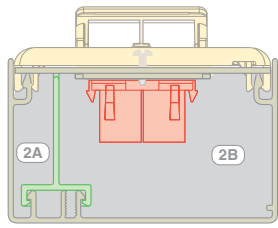

A = .47 in.<sup>2</sup>    A = 2.75 in.<sup>2</sup>

**Cable fill #1:** Power pole with data terminals using vertical sloped snap-on communication faceplate.

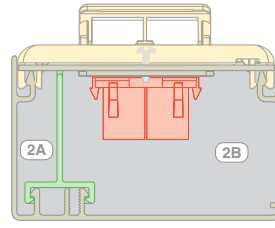

A = .43 in.<sup>2</sup>    A = 2.15 in.<sup>2</sup>

**Cable fill #2:** Power pole with data terminals using sloped screw-on communication faceplate.

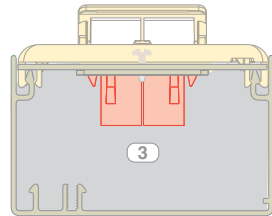

A = 3.47 in.<sup>2</sup>

**Cable fill #3:** Communication pole using vertical sloped snap-on communication faceplate.

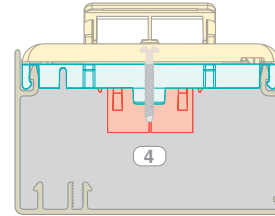

A = 2.83 in.<sup>2</sup>

**Cable fill #4:** communication pole using sloped screw-on communication faceplate.

**SPEC = 40% cable fill** – The recommended design in cable capacity, leaves room for future moves, adds, and changes.

**MAX for Data = 60% cable fill** – The maximum cable quantity based on cable interweaving and packing factors.

**MAX for Power cable fill** – The maximum of electrical cables based on UL temperature rise test.

	Raceway Type and Configuration	Fill Area (In. <sup>2</sup> )	Electrical Cables			Data Grade Cables		Data Grade Cables		Audio/Video		Fiber Optic Cable	
			14 AWG	12 AWG	10 AWG	24 AWG/UTP CM		24 AWG/UTP CM		RG6		2 Strand	
			THHN/T90			Cat. 6 (4-pr.)		Augmented Cat. 6					
			0.111	0.130	0.164	DIA. = 0.250		DIA. = 0.354		DIA. = 0.275		DIA. = 0.175	
			FILL			FILL		FILL		FILL		FILL	
			MAX	MAX	MAX	SPEC	MAX	SPEC	MAX	SPEC	MAX	SPEC	MAX
			(UL Temp Rise Test)			(40%)	(60%)	(40%)	(60%)	(40%)	(60%)	(40%)	(60%)
1A.	Power and communication: snap-on faceplates (power).	0.47	—	11	—	—	—	—	—	32	4	7	11
1B.	Communication.	2.75	—	—	—	22	33	12	19	18	27	45	68
2A.	Power and communication: Screw-on faceplates (power).	0.43	—	11	—	—	—	—	—	2	4	7	10
2B.	Communication.	2.15	—	—	—	17	26	10	15	14	21	35	53
3.	Communication only Snap-on faceplate.	3.47	—	—	—	28	42	16	24	23	35	57	86
4.	Communication only: Screw-on faceplates.	2.83	—	—	—	23	34	13	19	19	28	47	70

AWG dimensions represent typical outer cable diameter in inches.

## ABRASION PROTECTION

Panduit abrasion protection products provide an economical and easy way to insulate, protect, bundle and color-code components and cable. A wide variety of sizes and materials are available to meet a broad range of indoor and outdoor applications. To help assure optimum quality, Panduit abrasion protection products are designed and manufactured to meet applicable quality standards including International, UL, Military, ISO, and Aerospace.



- **Pan-Wrap™ Split Harness Wrap** features a patented slot pattern to improve flexibility and abrasion protection
- **Spiral wrap** bundles and protects wire and cable while providing the largest variety of colors, materials, and sizes to meet a variety of needs
- **Grommet edging** protects wire and cable from damage caused by sharp panel edges
- **Heat shrink** is available in many different materials and sizes to meet a variety of needs
- **Corrugated loom tubing** is crush, impact, and abrasion resistant to reduce the risk of damage to wire and cable
- **Braided expandable sleeving** provides continuous abrasion resistance and lightweight durable protection, with a flexible open weave that will not trap heat or humidity

Panduit abrasion protection products provide quality at the lowest installed cost. With a continued focus on new product development, Panduit continues to meet customer needs.

A.  
System  
Overview

B1.  
Cable Ties

B2.  
Cable  
Accessories

B3.  
Stainless  
Steel Ties

C1.  
Wiring  
Duct

C2.  
Surface  
Raceway

C3.  
Abrasion  
Protection

C4.  
Cable  
Management

D1.  
Terminals

D2.  
Power  
Connectors

D3.  
Grounding  
Connectors

E1.  
Labeling  
Systems

E2.  
Labels

E3.  
Pre-Printed  
& Write-On  
Markers

E4.  
Permanent  
Identification

E5.  
Lockout/  
Tagout  
& Safety  
Solutions

F.  
Index

A. System Overview

B1. Cable Ties

B2. Cable Accessories

B3. Stainless Steel Ties

C1. Wiring Duct

C2. Surface Raceway

C3. Abrasion Protection

C4. Cable Management

D1. Terminals

D2. Power Connectors

D3. Grounding Connectors

E1. Labeling Systems

E2. Labels

E3. Pre-Printed & Write-On Markers

E4. Permanent Identification

E5. Lockout/Tagout & Safety Solutions

F. Index

## Part Number System for Pan-Wrap™

<b>PW</b>	<b>50</b>	<b>F</b>	-	<b>C</b>	<b>20</b>
Type	Outside Diameter	Material		Package Size	Color Suffix
PW = Pan-Wrap™	38 = 3/8" 50 = 1/2" 75 = 3/4" 100 = 1" 150 = 1 1/2"	F = Polyethylene FR = Flame Retardant Polyethylene		L = 50' (15.2m) C = 100' (30.5m) T = 200' (61.0m) TL = 250' (76.2m)	Leave Blank = Natural 20 = Black Polyethylene 3 = Orange 4 = Yellow

## Pan-Wrap™ Split Harness Wrap



- Patented slot pattern provides improved flexibility and abrasion protection in any application
- Unique wall design provides for easy cable breakouts
- Innovative design maintains uniform bundle protection in dynamic applications
- Considerably reduces installation time
- Large overlap accommodates a wide range of bundle diameters
- Packaged on a reel for easy handling and dispensing of product

Part Number	Material	Color	Length Per Reel		Max. Bundle Diameter		Min. Bundle Diameter‡		Temperature Range	Nominal I.D.		Std. Pkg. Qty.*
			Ft.	m	In.	mm	In.	mm		In.	mm	
PW38F-TL	Polyethylene	Natural	250	76.2	0.43	10.9	0.25	6.4	-40°F – 122°F (-40°C – 50°C)	0.38	9.5	1
PW38F-TL20	Polyethylene	Black	250	76.2	0.43	10.9	0.25	6.4		0.38	9.5	1
PW38FR-TLY	Flame Retardant Polyethylene	Natural	250	76.2	0.43	10.9	0.25	6.4	-4°F – 167°F (-20°C – 75°C)	0.38	9.5	1
PW38FR-TL20Y	Flame Retardant Polyethylene	Black	250	76.2	0.43	10.9	0.25	6.4		0.38	9.5	1
PW50F-T	Polyethylene	Natural	200	61.0	0.55	14.0	0.43	10.9	-40°F – 122°F (-40°C – 50°C)	0.50	12.7	1
PW50F-T20	Polyethylene	Black	200	61.0	0.55	14.0	0.43	10.9		0.50	12.7	1
PW50F-T3	Polyethylene	Orange	200	61.0	0.55	14.0	0.43	10.9		0.50	12.7	1
PW50F-T4	Polyethylene	Yellow	200	61.0	0.55	14.0	0.43	10.9		0.50	12.7	1
PW50FR-TY	Flame Retardant Polyethylene	Natural	200	61.0	0.55	14.0	0.43	10.9		0.50	12.7	1
PW50FR-T20Y	Flame Retardant Polyethylene	Black	200	61.0	0.55	14.0	0.43	10.9	-4°F – 167°F (-20°C – 75°C)	0.50	12.7	1
PW75F-C	Polyethylene	Natural	100	30.5	0.81	20.6	0.55	14.0		0.75	19.1	1
PW75F-C20	Polyethylene	Black	100	30.5	0.81	20.6	0.55	14.0	-40°F – 122°F (-40°C – 50°C)	0.75	19.1	1
PW75F-C3	Polyethylene	Orange	100	30.5	0.81	20.6	0.55	14.0		0.75	19.1	1
PW75F-C4	Polyethylene	Yellow	100	30.5	0.81	20.6	0.55	14.0		0.75	19.1	1
PW75FR-CY	Flame Retardant Polyethylene	Natural	100	30.5	0.81	20.6	0.55	14.0	-4°F – 167°F (-20°C – 75°C)	0.75	19.1	1
PW75FR-C20Y	Flame Retardant Polyethylene	Black	100	30.5	0.81	20.6	0.55	14.0		0.75	19.1	1
PW100F-C	Polyethylene	Natural	100	30.5	1.13	28.6	0.81	20.6	-40°F – 122°F (-40°C – 50°C)	1.00	25.4	1
PW100F-C20	Polyethylene	Black	100	30.5	1.13	28.6	0.81	20.6		1.00	25.4	1
PW100F-C3	Polyethylene	Orange	100	30.5	1.13	28.6	0.81	20.6		1.00	25.4	1
PW100F-C4	Polyethylene	Yellow	100	30.5	1.13	28.6	0.81	20.6		1.00	25.4	1
PW100FR-CY	Flame Retardant Polyethylene	Natural	100	30.5	1.13	28.6	0.81	20.6	-4°F – 167°F (-20°C – 75°C)	1.00	25.4	1
PW100FR-C20Y	Flame Retardant Polyethylene	Black	100	30.5	1.13	28.6	0.81	20.6		1.00	25.4	1
PW150F-L	Polyethylene	Natural	50	15.2	1.63	41.3	1.13	28.6	-40°F – 122°F (-40°C – 50°C)	1.50	38.1	1
PW150F-L20	Polyethylene	Black	50	15.2	1.63	41.3	1.13	28.6		1.50	38.1	1
PW150F-L3	Polyethylene	Orange	50	15.2	1.63	41.3	1.13	28.6		1.50	38.1	1
PW150F-L4	Polyethylene	Yellow	50	15.2	1.63	41.3	1.13	28.6		1.50	38.1	1
PW150FR-LY	Flame Retardant Polyethylene	Natural	50	15.2	1.63	41.3	1.13	28.6		1.50	38.1	1
PW150FR-L20Y	Flame Retardant Polyethylene	Black	50	15.2	1.63	41.3	1.13	28.6	-4°F – 167°F (-20°C – 75°C)	1.50	38.1	1

‡Diameter can be further reduced with the use of Panduit cable ties.

\*Order number of reels required.



## Pan-Wrap™ Installation Tools

- Patented installation tool with 180° opening allows easy loading of maximum bundle diameters to speed installation, providing the lowest installed cost



Part Number	Color	For Use With	Std. Pkg. Qty.**
PWT38	White	PW38F- Series	1
PWT50	White	PW50F- Series	1
PWT75	White	PW75F- Series	1
PWT100	White	PW100F- Series	1
PWT150	White	PW150F- Series	1

\*\*Order number of tools required.

## Part Number System for Spiral Wrap

T	25	F	-	C	16
Type	Outside Diameter	Material		Package Size	Color Suffix
T = Spiral Wrap	12 = 1/8" 19 = 3/16" 25 = 1/4" 38 = 3/8" 50 = 1/2" 62 = 5/8" 75 = 3/4" 100 = 1"	F = Polyethylene R = Fire Resistant Polyethylene FR = Flame Retardant Polyethylene N = Nylon T = TFE <sup>^</sup> P = Weather Resistant Polypropylene		X = 10' Q = 25' L = 50' C = 100' T = 200' TL = 250' D = 500' M = 1,000'	See Table Below

Color	Color Suffix	Material Availability					
		Polyethylene	Fire Resistant Polyethelene	Flame Retardant Polyethelene	Nylon 6.6	Weather Resistant Polypropylene	TEFLON <sup>^</sup>
Natural*	No Suffix Will be Listed	✓	✓	✓	✓		✓
Weather Resistant Black	0	✓			✓	✓	
Brown	1	✓					
Red	2	✓					
Orange	3	✓					
Yellow	4	✓					
Green	5	✓					
Blue	6	✓					
Purple	7	✓					
Gray	8	✓					
White	10	✓					
Pink	16	✓					
Black	20	✓	✓	✓	✓		

<sup>^</sup>TFE is Polytetrafluorethylene material.

\*Natural can range from transparent, opaque, to white.

A. System Overview

**RU** Spiral Wrap

B1. Cable Ties

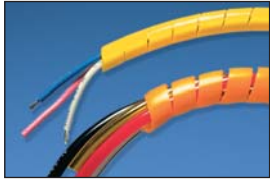

B2. Cable Accessories

B3. Stainless Steel Ties

C1. Wiring Duct

C2. Surface Raceway

C3. Abrasion Protection

C4. Cable Management

D1. Terminals

D2. Power Connectors

D3. Grounding Connectors

E1. Labeling Systems

E2. Labels

E3. Pre-Printed & Write-On Markers

E4. Permanent Identification

E5. Lockout/Tagout & Safety Solutions

F. Index

- Harness multiple cables into a single manageable bundle
- Allows breakouts of single/multiple cables
- Provides abrasion protection for wire, cables, hoses, and tubing
- Multiple colors allow easy identification of cable bundles
- Installation tool supplied in each package
- Available in multiple materials
- Reusable

Part Number	Material*	Color	Length Per Reel		Bundle Diameter Range		Outside Diameter		Temperature Range	Wall Thickness		Std. Pkg. Qty.‡
			Ft.	m	In.	mm	In.	mm		In.	mm	
T12F-C	Polyethylene	Natural	100	30.5	1/16 – 1/2	1.6 – 12.7	0.12	3.2	-40°F – 122°F (-40°C – 50°C)	0.030	0.76	1
T12F-D	Polyethylene	Natural	500	152.4	1/16 – 1/2	1.6 – 12.7	0.12	3.2	-40°F – 122°F (-40°C – 50°C)	0.030	0.76	1
T19F-C	Polyethylene	Natural	100	30.5	1/8 – 1	3.2 – 25.4	0.19	4.8	-40°F – 122°F (-40°C – 50°C)	0.035	0.89	1
T19F-M	Polyethylene	Natural	1,000	304.8	1/8 – 1	3.2 – 25.4	0.19	4.8	-40°F – 122°F (-40°C – 50°C)	0.035	0.89	1
T25F-C	Polyethylene	Natural	100	30.5	3/16 – 2	4.8 – 50.8	0.25	6.4	-40°F – 122°F (-40°C – 50°C)	0.040	1.02	1
T25F-C1	Polyethylene	Brown	100	30.5	3/16 – 2	4.8 – 50.8	0.25	6.4	-40°F – 122°F (-40°C – 50°C)	0.040	1.02	1
T25F-C2	Polyethylene	Red	100	30.5	3/16 – 2	4.8 – 50.8	0.25	6.4	-40°F – 122°F (-40°C – 50°C)	0.040	1.02	1
T25F-C3Y	Polyethylene	Orange	100	30.5	3/16 – 2	4.8 – 50.8	0.25	6.4	-40°F – 122°F (-40°C – 50°C)	0.040	1.02	1
T25F-C4Y	Polyethylene	Yellow	100	30.5	3/16 – 2	4.8 – 50.8	0.25	6.4	-40°F – 122°F (-40°C – 50°C)	0.040	1.02	1
T25F-C5	Polyethylene	Green	100	30.5	3/16 – 2	4.8 – 50.8	0.25	6.4	-40°F – 122°F (-40°C – 50°C)	0.040	1.02	1
T25F-C6	Polyethylene	Blue	100	30.5	3/16 – 2	4.8 – 50.8	0.25	6.4	-40°F – 122°F (-40°C – 50°C)	0.040	1.02	1
T25F-C7	Polyethylene	Purple	100	30.5	3/16 – 2	4.8 – 50.8	0.25	6.4	-40°F – 122°F (-40°C – 50°C)	0.040	1.02	1
T25F-C8	Polyethylene	Gray	100	30.5	3/16 – 2	4.8 – 50.8	0.25	6.4	-40°F – 122°F (-40°C – 50°C)	0.040	1.02	1
T25F-C10	Polyethylene	White	100	30.5	3/16 – 2	4.8 – 50.8	0.25	6.4	-40°F – 122°F (-40°C – 50°C)	0.040	1.02	1
T25F-C16	Polyethylene	Pink	100	30.5	3/16 – 2	4.8 – 50.8	0.25	6.4	-40°F – 122°F (-40°C – 50°C)	0.040	1.02	1
T25F-M	Polyethylene	Natural	1,000	304.8	3/16 – 2	4.8 – 50.8	0.25	6.4	-40°F – 122°F (-40°C – 50°C)	0.040	1.02	1
T38F-C	Polyethylene	Natural	100	30.5	5/16 – 3	7.9 – 76.2	0.38	9.5	-40°F – 122°F (-40°C – 50°C)	0.055	1.40	1
T38F-TL	Polyethylene	Natural	250	76.2	5/16 – 3	7.9 – 76.2	0.38	9.5	-40°F – 122°F (-40°C – 50°C)	0.055	1.40	1
T50F-X	Polyethylene	Natural	10	3.1	3/8 – 4	9.5 – 101.6	0.50	12.7	-40°F – 122°F (-40°C – 50°C)	0.060	1.52	1
T50F-C	Polyethylene	Natural	100	30.5	3/8 – 4	9.5 – 101.6	0.50	12.7	-40°F – 122°F (-40°C – 50°C)	0.060	1.52	1
T50F-C1	Polyethylene	Brown	100	30.5	3/8 – 4	9.5 – 101.6	0.50	12.7	-40°F – 122°F (-40°C – 50°C)	0.060	1.52	1
T50F-C2	Polyethylene	Red	100	30.5	3/8 – 4	9.5 – 101.6	0.50	12.7	-40°F – 122°F (-40°C – 50°C)	0.060	1.52	1
T50F-C3Y	Polyethylene	Orange	100	30.5	3/8 – 4	9.5 – 101.6	0.50	12.7	-40°F – 122°F (-40°C – 50°C)	0.060	1.52	1
T50F-C4Y	Polyethylene	Yellow	100	30.5	3/8 – 4	9.5 – 101.6	0.50	12.7	-40°F – 122°F (-40°C – 50°C)	0.060	1.52	1
T50F-C5	Polyethylene	Green	100	30.5	3/8 – 4	9.5 – 101.6	0.50	12.7	-40°F – 122°F (-40°C – 50°C)	0.060	1.52	1
T50F-C6	Polyethylene	Blue	100	30.5	3/8 – 4	9.5 – 101.6	0.50	12.7	-40°F – 122°F (-40°C – 50°C)	0.060	1.52	1
T50F-C7	Polyethylene	Purple	100	30.5	3/8 – 4	9.5 – 101.6	0.50	12.7	-40°F – 122°F (-40°C – 50°C)	0.060	1.52	1
T50F-C8	Polyethylene	Gray	100	30.5	3/8 – 4	9.5 – 101.6	0.50	12.7	-40°F – 122°F (-40°C – 50°C)	0.060	1.52	1
T50F-C10	Polyethylene	White	100	30.5	3/8 – 4	9.5 – 101.6	0.50	12.7	-40°F – 122°F (-40°C – 50°C)	0.060	1.52	1
T50F-C16	Polyethylene	Pink	100	30.5	3/8 – 4	9.5 – 101.6	0.50	12.7	-40°F – 122°F (-40°C – 50°C)	0.060	1.52	1

\*Flame retardant products are manufactured from a material that is rated UL 94V-0.

‡Reel packaging may contain splices. Contact Panduit Customer Service for further information.

## Spiral Wrap (continued)

Part Number	Material	Color	Length Per Reel		Bundle Diameter Range		Outside Diameter		Temperature Range	Wall Thickness		Std. Pkg. Qty.†
			Ft.	m	In.	mm	In.	mm		In.	mm	
T50F-TL	Polyethylene	Natural	250	76.2	3/8 – 4	9.5 – 101.6	0.50	12.7	-40°F – 122°F (-40°C – 50°C)	0.060	1.52	1
T50F-TL4Y	Polyethylene	Yellow	250	76.2	3/8 – 4	9.5 – 101.6	0.50	12.7	-40°F – 122°F (-40°C – 50°C)	0.060	1.52	1
T62F-C	Polyethylene	Natural	100	30.5	1/2 – 4 1/2	12.7 – 114.3	0.62	15.9	-40°F – 122°F (-40°C – 50°C)	0.062	1.57	1
T62F-TL	Polyethylene	Natural	250	76.2	1/2 – 4 1/2	12.7 – 114.3	0.62	15.9	-40°F – 122°F (-40°C – 50°C)	0.062	1.57	1
T75F-C	Polyethylene	Natural	100	30.5	5/8 – 5	15.9 – 127.0	0.75	19.1	-40°F – 122°F (-40°C – 50°C)	0.065	1.65	1
T75F-T	Polyethylene	Natural	200	61.0	5/8 – 5	15.9 – 127.0	0.75	19.1	-40°F – 122°F (-40°C – 50°C)	0.065	1.65	1
T100F-C	Polyethylene	Natural	100	30.5	7/8 – 6	22.2 – 152.4	1.00	25.4	-40°F – 122°F (-40°C – 50°C)	0.070	1.78	1
T12F-C0	Weather Resistant Polyethylene	Black	100	30.5	1/16 – 1/2	1.6 – 12.7	0.12	3.2	-40°F – 122°F (-40°C – 50°C)	0.030	0.76	1
T12F-D0	Weather Resistant Polyethylene	Black	500	152.4	1/16 – 1/2	1.6 – 12.7	0.12	3.2	-40°F – 122°F (-40°C – 50°C)	0.030	0.76	1
T19F-C0	Weather Resistant Polyethylene	Black	100	30.5	1/8 – 1	3.2 – 25.4	0.19	4.8	-40°F – 122°F (-40°C – 50°C)	0.035	0.89	1
T25F-X0	Weather Resistant Polyethylene	Black	10	3.1	3/16 – 2	4.8 – 50.8	0.25	6.4	-40°F – 122°F (-40°C – 50°C)	0.040	1.02	1
T25F-C0	Weather Resistant Polyethylene	Black	100	30.5	3/16 – 2	4.8 – 50.8	0.25	6.4	-40°F – 122°F (-40°C – 50°C)	0.040	1.02	1
T25F-M0	Weather Resistant Polyethylene	Black	1,000	304.8	3/16 – 2	4.8 – 50.8	0.25	6.4	-40°F – 122°F (-40°C – 50°C)	0.040	1.02	1
T38F-C0	Weather Resistant Polyethylene	Black	100	30.5	5/16 – 3	7.9 – 76.2	0.38	9.5	-40°F – 122°F (-40°C – 50°C)	0.055	1.40	1
T38F-TL0	Weather Resistant Polyethylene	Black	250	76.2	5/16 – 3	7.9 – 76.2	0.38	9.5	-40°F – 122°F (-40°C – 50°C)	0.055	1.40	1
T50F-X0	Weather Resistant Polyethylene	Black	10	3.1	3/8 – 4	9.5 – 101.6	0.50	12.7	-40°F – 122°F (-40°C – 50°C)	0.060	1.52	1
T50F-C0	Weather Resistant Polyethylene	Black	100	30.5	3/8 – 4	9.5 – 101.6	0.50	12.7	-40°F – 122°F (-40°C – 50°C)	0.060	1.52	1
T50F-TL0	Weather Resistant Polyethylene	Black	250	76.2	3/8 – 4	9.5 – 101.6	0.50	12.7	-40°F – 122°F (-40°C – 50°C)	0.060	1.52	1
T62F-C0	Weather Resistant Polyethylene	Black	100	30.5	1/2 – 4 1/2	12.7 – 114.3	0.62	15.9	-40°F – 122°F (-40°C – 50°C)	0.062	1.57	1
T62F-TL0	Weather Resistant Polyethylene	Black	250	76.2	1/2 – 4 1/2	12.7 – 114.3	0.62	15.9	-40°F – 122°F (-40°C – 50°C)	0.062	1.57	1
T75F-C0	Weather Resistant Polyethylene	Black	100	30.5	5/8 – 5	15.9 – 127.0	0.75	19.1	-40°F – 122°F (-40°C – 50°C)	0.065	1.65	1
T75F-T0	Weather Resistant Polyethylene	Black	200	61.0	5/8 – 5	15.9 – 127.0	0.75	19.1	-40°F – 122°F (-40°C – 50°C)	0.065	1.65	1
T100F-C0	Weather Resistant Polyethylene	Black	100	30.5	7/8 – 6	22.2 – 152.4	1.00	25.4	-40°F – 122°F (-40°C – 50°C)	0.070	1.78	1
T12R-CY	Fire Resistant Polyethylene	Natural	100	30.5	1/16 – 1/2	1.6 – 12.7	0.12	3.2	-40°F – 122°F (-40°C – 50°C)	0.030	0.76	1
T19R-CY	Fire Resistant Polyethylene	Natural	100	30.5	1/8 – 1	3.2 – 25.4	0.19	4.8	-40°F – 122°F (-40°C – 50°C)	0.035	0.89	1
T25R-CY	Fire Resistant Polyethylene	Natural	100	30.5	3/16 – 2	4.8 – 50.8	0.25	6.4	-40°F – 122°F (-40°C – 50°C)	0.040	1.02	1
T25R-C20Y	Fire Resistant Polyethylene	Black	100	30.5	3/16 – 2	4.8 – 50.8	0.25	6.4	-40°F – 122°F (-40°C – 50°C)	0.040	1.02	1

\*Flame retardant products are manufactured from a material that is rated UL 94V-0.

†Reel packaging may contain splices. Contact Panduit Customer Service for further information.

Table continues on page C3.6

A. System Overview

## Spiral Wrap (continued)

B1. Cable Ties

B2. Cable Accessories

B3. Stainless Steel Ties

C1. Wiring Duct

C2. Surface Raceway

C3. Abrasion Protection

C4. Cable Management

D1. Terminals

D2. Power Connectors

D3. Grounding Connectors

E1. Labeling Systems

E2. Labels

E3. Pre-Printed & Write-On Markers

E4. Permanent Identification

E5. Lockout/Tagout & Safety Solutions

F. Index

Part Number	Material*	Color	Length Per Reel		Bundle Diameter Range		Outside Diameter		Temperature Range	Wall Thickness		Std. Pkg. Qty.‡
			Ft.	m	In.	mm	In.	mm		In.	mm	
T25R-MY	Fire Resistant Polyethylene	Natural	1,000	304.8	3/16 – 2	4.8 – 50.8	0.25	6.4	-40°F – 122°F (-40°C – 50°C)	0.040	1.02	1
T25R-M20Y	Fire Resistant Polyethylene	Black	1,000	304.8	3/16 – 2	4.8 – 50.8	0.25	6.4	-40°F – 122°F (-40°C – 50°C)	0.040	1.02	1
T38R-CY	Fire Resistant Polyethylene	Natural	100	30.5	5/16 – 3	7.9 – 76.2	0.38	9.5	-40°F – 122°F (-40°C – 50°C)	0.055	1.40	1
T38R-TLY	Fire Resistant Polyethylene	Natural	250	76.2	5/16 – 3	7.9 – 76.2	0.38	9.5	-40°F – 122°F (-40°C – 50°C)	0.055	1.40	1
T50R-CY	Fire Resistant Polyethylene	Natural	100	30.5	3/8 – 4	9.5 – 101.6	0.50	12.7	-40°F – 122°F (-40°C – 50°C)	0.060	1.52	1
T50R-TLY	Fire Resistant Polyethylene	Natural	250	76.2	3/8 – 4	9.5 – 101.6	0.50	12.7	-40°F – 122°F (-40°C – 50°C)	0.060	1.52	1
T62R-CY	Fire Resistant Polyethylene	Natural	100	30.5	1/2 – 4 1/2	12.7 – 114.3	0.62	15.9	-40°F – 122°F (-40°C – 50°C)	0.062	1.57	1
T75R-CY	Fire Resistant Polyethylene	Natural	100	30.5	5/8 – 5	15.9 – 127.0	0.75	19.1	-40°F – 122°F (-40°C – 50°C)	0.065	1.65	1
T100R-CY	Fire Resistant Polyethylene	Natural	100	30.5	7/8 – 6	22.2 – 152.4	1.00	25.4	-40°F – 122°F (-40°C – 50°C)	0.070	1.78	1
T12FR-CY	Flame Retardant Polyethylene	Natural	100	30.5	1/16 – 1/2	1.6 – 12.7	0.12	3.2	-4°F – 167°F (-20°C – 75°C)	0.030	0.76	1
T12FR-C20Y	Flame Retardant Polyethylene	Black	100	30.5	1/16 – 1/2	1.6 – 12.7	0.12	3.2	-4°F – 167°F (-20°C – 75°C)	0.030	0.76	1
T19FR-CY	Flame Retardant Polyethylene	Natural	100	30.5	1/8 – 1	3.2 – 25.4	0.19	4.8	-4°F – 167°F (-20°C – 75°C)	0.035	0.89	1
T19FR-C20Y	Flame Retardant Polyethylene	Black	100	30.5	1/8 – 1	3.2 – 25.4	0.19	4.8	-4°F – 167°F (-20°C – 75°C)	0.035	0.89	1
T25FR-CY	Flame Retardant Polyethylene	Natural	100	30.5	3/16 – 2	4.8 – 50.8	0.25	6.4	-4°F – 167°F (-20°C – 75°C)	0.040	1.02	1
T25FR-C20Y	Flame Retardant Polyethylene	Black	100	30.5	3/16 – 2	4.8 – 50.8	0.25	6.4	-4°F – 167°F (-20°C – 75°C)	0.040	1.02	1
T25FR-MY	Flame Retardant Polyethylene	Natural	1,000	304.8	3/16 – 2	4.8 – 50.8	0.25	6.4	-4°F – 167°F (-20°C – 75°C)	0.040	1.02	1
T25FR-M20Y	Flame Retardant Polyethylene	Black	1,000	304.8	3/16 – 2	4.8 – 50.8	0.25	6.4	-4°F – 167°F (-20°C – 75°C)	0.040	1.02	1
T38FR-CY	Flame Retardant Polyethylene	Natural	100	30.5	5/16 – 3	7.9 – 76.2	0.38	9.5	-4°F – 167°F (-20°C – 75°C)	0.055	1.40	1
T38FR-C20Y	Flame Retardant Polyethylene	Black	100	30.5	5/16 – 3	7.9 – 76.2	0.38	9.5	-4°F – 167°F (-20°C – 75°C)	0.055	1.40	1
T38FR-TLY	Flame Retardant Polyethylene	Natural	250	76.2	5/16 – 3	7.9 – 76.2	0.38	9.5	-4°F – 167°F (-20°C – 75°C)	0.055	1.40	1
T50FR-CY	Flame Retardant Polyethylene	Natural	100	30.5	3/8 – 4	9.5 – 101.6	0.50	12.7	-4°F – 167°F (-20°C – 75°C)	0.060	1.52	1
T50FR-C20Y	Flame Retardant Polyethylene	Black	100	30.5	3/8 – 4	9.5 – 101.6	0.50	12.7	-4°F – 167°F (-20°C – 75°C)	0.060	1.52	1
T50FR-TLY	Flame Retardant Polyethylene	Natural	250	76.2	3/8 – 4	9.5 – 101.6	0.50	12.7	-4°F – 167°F (-20°C – 75°C)	0.060	1.52	1
T62FR-CY	Flame Retardant Polyethylene	Natural	100	30.5	1/2 – 4 1/2	12.7 – 114.3	0.62	15.9	-4°F – 167°F (-20°C – 75°C)	0.062	1.57	1
T62FR-C20Y	Flame Retardant Polyethylene	Black	100	30.5	1/2 – 4 1/2	12.7 – 114.3	0.62	15.9	-4°F – 167°F (-20°C – 75°C)	0.062	1.57	1
T75FR-CY	Flame Retardant Polyethylene	Natural	100	30.5	5/8 – 5	15.9 – 127.0	0.75	19.1	-4°F – 167°F (-20°C – 75°C)	0.065	1.65	1
T75FR-C20Y	Flame Retardant Polyethylene	Black	100	30.5	5/8 – 5	15.9 – 127.0	0.75	19.1	-4°F – 167°F (-20°C – 75°C)	0.065	1.65	1
T75FR-TY	Flame Retardant Polyethylene	Natural	200	61.0	5/8 – 5	15.9 – 127.0	0.75	19.1	-4°F – 167°F (-20°C – 75°C)	0.065	1.65	1
T100FR-CY	Flame Retardant Polyethylene	Natural	100	30.5	7/8 – 6	22.2 – 152.4	1.00	25.4	-4°F – 167°F (-20°C – 75°C)	0.070	1.78	1
T100FR-C20Y	Flame Retardant Polyethylene	Black	100	30.5	7/8 – 6	22.2 – 152.4	1.00	25.4	-4°F – 167°F (-20°C – 75°C)	0.070	1.78	1

\*Flame retardant products are manufactured from a material that is rated UL 94V-0.

‡Reel packaging may contain splices. Contact Panduit Customer Service for further information.

## Spiral Wrap (continued)

Part Number	Material*	Color	Length Per Reel		Bundle Diameter Range		Outside Diameter		Temperature Range	Wall Thickness		Std. Pkg. Qty. ‡
			Ft.	m	In.	mm	In.	mm		In.	mm	
T12N-C	Nylon 6.6	Natural	100	30.5	1/16 – 1/2	1.6 – 12.7	0.12	3.2	-40°F – 149°F (-40°C – 65°C)	0.015	0.38	1
T19N-C	Nylon 6.6	Natural	100	30.5	1/8 – 1	3.2 – 25.4	0.19	4.8	-40°F – 149°F (-40°C – 65°C)	0.020	0.51	1
T25N-C	Nylon 6.6	Natural	100	30.5	3/16 – 2	4.8 – 50.8	0.25	6.4	-40°F – 149°F (-40°C – 65°C)	0.023	0.58	1
T38N-C	Nylon 6.6	Natural	100	30.5	5/16 – 3	7.9 – 76.2	0.38	9.5	-40°F – 149°F (-40°C – 65°C)	0.030	0.76	1
T50N-C	Nylon 6.6	Natural	100	30.5	3/8 – 4	9.5 – 101.6	0.50	12.7	-40°F – 149°F (-40°C – 65°C)	0.032	0.81	1
T62N-C	Nylon 6.6	Natural	100	30.5	1/2 – 4 1/2	12.7 – 114.3	0.62	15.9	-40°F – 149°F (-40°C – 65°C)	0.035	0.89	1
T75N-C	Nylon 6.6	Natural	100	30.5	5/8 – 5	15.9 – 127.0	0.75	19.1	-40°F – 149°F (-40°C – 65°C)	0.040	1.02	1
T100N-C	Nylon 6.6	Natural	100	30.5	7/8 – 6	22.2 – 152.4	1.00	25.4	-40°F – 149°F (-40°C – 65°C)	0.045	1.14	1
T12N-C0	Weather Resistant Nylon 6.6	Black	100	30.5	1/16 – 1/2	1.6 – 12.7	0.12	3.2	-40°F – 149°F (-40°C – 65°C)	0.015	0.38	1
T19N-C0	Weather Resistant Nylon 6.6	Black	100	30.5	1/8 – 1	3.2 – 25.4	0.19	4.8	-40°F – 149°F (-40°C – 65°C)	0.020	0.51	1
T25N-C0	Weather Resistant Nylon 6.6	Black	100	30.5	3/16 – 2	4.8 – 50.4	0.25	6.4	-40°F – 149°F (-40°C – 65°C)	0.023	0.58	1
T38N-C0	Weather Resistant Nylon 6.6	Black	100	30.5	5/16 – 3	7.9 – 76.2	0.38	9.5	-40°F – 149°F (-40°C – 65°C)	0.030	0.76	1
T50N-C0	Weather Resistant Nylon 6.6	Black	100	30.5	3/8 – 4	9.5 – 101.6	0.50	12.7	-40°F – 149°F (-40°C – 65°C)	0.032	0.81	1
T62N-C0	Weather Resistant Nylon 6.6	Black	100	30.5	1/2 – 4 1/2	12.7 – 114.3	0.62	15.9	-40°F – 149°F (-40°C – 65°C)	0.035	0.89	1
T75N-C0	Weather Resistant Nylon 6.6	Black	100	30.5	5/8 – 5	15.9 – 127.0	0.75	19.1	-40°F – 149°F (-40°C – 65°C)	0.040	1.02	1
T100N-C0	Weather Resistant Nylon 6.6	Black	100	30.5	7/8 – 6	22.2 – 152.4	1.00	25.4	-40°F – 149°F (-40°C – 65°C)	0.045	1.14	1
T38P-C0	Weather Resistant Polypropylene	Black	100	30.5	5/16 – 3	7.9 – 76.2	0.38	9.5	-40°F – 239°F (-40°C – 115°C)	0.030	0.76	1
T50P-C0	Weather Resistant Polypropylene	Black	100	30.5	3/8 – 4	9.5 – 101.6	0.50	12.7	-40°F – 239°F (-40°C – 115°C)	0.030	0.76	1
T100P-C0	Weather Resistant Polypropylene	Black	100	30.5	7/8 – 6	22.2 – 152.4	1.00	25.4	-40°F – 239°F (-40°C – 115°C)	0.030	0.76	1
T12T-C	TFE^	Natural	100	30.5	1/16 – 1/2	1.6 – 12.7	0.12	3.2	-454°F – 500°F (-270°C – 260°C)	0.020	0.51	1
T19T-C	TFE^	Natural	100	30.5	1/8 – 1	3.2 – 25.4	0.19	4.8	-454°F – 500°F (-270°C – 260°C)	0.030	0.76	1
T25T-L	TFE^	Natural	50	15.2	3/16 – 2	4.8 – 50.8	0.25	6.4	-454°F – 500°F (-270°C – 260°C)	0.030	0.76	1
T25T-L0	TFE^	Black	50	15.2	3/16 – 2	4.8 – 50.8	0.25	6.4	-454°F – 500°F (-270°C – 260°C)	0.030	0.76	1
T38T-L	TFE^	Natural	50	15.2	5/16 – 3	7.9 – 76.2	0.38	9.5	-454°F – 500°F (-270°C – 260°C)	0.030	0.76	1
T50T-Q	TFE^	Natural	25	7.6	3/8 – 4	9.5 – 101.6	0.50	12.7	-454°F – 500°F (-270°C – 260°C)	0.030	0.76	1
T62T-Q	TFE^	Natural	25	7.6	1/2 – 4 1/2	12.7 – 114.3	0.62	15.9	-454°F – 500°F (-270°C – 260°C)	0.030	0.76	1
T75T-X	TFE^	Natural	10	3.1	5/8 – 5	15.9 – 127.0	0.75	19.1	-454°F – 500°F (-270°C – 260°C)	0.030	0.76	1
T100T-X	TFE^	Natural	10	3.1	7/8 – 6	22.2 – 152.4	1.00	25.4	-454°F – 500°F (-270°C – 260°C)	0.040	1.02	1

\*Flame retardant products are manufactured from a material that is rated UL 94V-0.

‡Reel packaging may contain splices. Contact Panduit Customer Service for further information.

^TFE is Polytetrafluorethylene material.



A.  
System  
Overview

B1.  
Cable  
Ties

B2.  
Cable  
Accessories

B3.  
Stainless  
Steel Ties

C1.  
Wiring  
Duct

C2.  
Surface  
Raceway

C3.  
Abrasion  
Protection

C4.  
Cable  
Management

D1.  
Terminals

D2.  
Power  
Connectors

D3.  
Grounding  
Connectors

E1.  
Labeling  
Systems

E2.  
Labels

E3.  
Pre-Printed  
& Write-On  
Markers

E4.  
Permanent  
Identification

E5.  
Lockout/  
Tagout  
& Safety  
Solutions

F.  
Index

A. System Overview

## Part Number System for Grommet Edging

B1. Cable Ties

**GEE**

**36**

**F**

**-**

**A**

**-**

**C**

**0**

B2. Cable Accessories

**Type**

**Max. Panel Thickness**

**Material**

**Adhesive**

**Package Size**

**Color Suffix**

GE = Grommet Edging Strips  
 36 = 0.036" thickness  
 62 = 0.062" thickness  
 GEE = Slotted Grommet Edging  
 99 = 0.099" thickness  
 GES = Solid Grommet Edging  
 144 = 0.144" thickness  
 189 = 0.189" thickness

F = Polyethylene  
 N = Nylon 6.6  
 FR = Flame Retardant Polyethylene

A = Adhesive Lined  
 Leave Blank = Non-Adhesive

Q = 25'  
 L = 50'  
 C = 100'

0 = Weather Resistant Black  
 Leave Blank = Natural

B3. Stainless Steel Ties

C1. Wiring Duct

C2. Surface Raceway

C3. Abrasion Protection

## Grommet Edging

- Use slotted product on irregularly shaped and round panel holes
- Solid product is used only on straight edges
- Provided in 0.030" (0.8mm) thick material making it highly flexible

C4. Cable Management

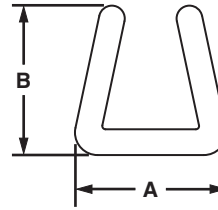

D1. Terminals

D2. Power Connectors

D3. Grounding Connectors

Part Number	Width A		Height B		Panel Thickness Range		Material	Color	Temperature Range	Std. Pkg. Qty.‡
	In.	mm	In.	mm	In.	mm				
<b>Slotted</b>										
GEE36F-C	0.11	2.7	0.12	3.0	0.026 – 0.036	0.7 – 0.9	Polyethylene	Natural	-40°F – 122°F (-40°C – 50°C)	1
GEE36F-C0	0.11	2.7	0.12	3.0	0.026 – 0.036	0.7 – 0.9	Weather Resistant Polyethylene	Black		1
GEE62F-C	0.13	3.3	0.16	4.1	0.036 – 0.062	0.9 – 1.6	Polyethylene	Natural		1
GEE62F-C0	0.13	3.3	0.16	4.1	0.036 – 0.062	0.9 – 1.6	Weather Resistant Polyethylene	Black		1
GEE99F-C	0.17	4.3	0.19	4.7	0.062 – 0.099	1.6 – 2.5	Polyethylene	Natural		1
GEE99F-C0	0.17	4.3	0.19	4.7	0.062 – 0.099	1.6 – 2.5	Weather Resistant Polyethylene	Black		1
GEE144F-C	0.21	5.4	0.22	5.6	0.099 – 0.144	2.5 – 3.7	Polyethylene	Natural		1
GEE144F-C0	0.21	5.4	0.22	5.6	0.099 – 0.144	2.5 – 3.7	Weather Resistant Polyethylene	Black		1

‡Reel packaging may contain splices. Contact Panduit Customer Service for further information.

E5. Lockout/Tagout & Safety Solutions

F. Index

## Grommet Edging (continued)

Part Number	Width A		Height B		Panel Thickness Range		Material	Color	Temperature Range	Std. Pkg. Qty.‡
	In.	mm	In.	mm	In.	mm				
<b>Solid – Use on straight edges only</b>										
GES36F-C	0.11	2.7	0.12	3.0	0.026 – 0.036	0.7 – 0.9	Polyethylene	Natural	-40°F – 122°F (-40°C – 50°C)	1
GES36F-C0	0.11	2.7	0.12	3.0	0.026 – 0.036	0.7 – 0.9	Weather Resistant Polyethylene	Black		1
GES62F-C	0.13	3.3	0.16	4.1	0.036 – 0.062	0.9 – 1.6	Polyethylene	Natural		1
GES62F-C0	0.13	3.3	0.16	4.1	0.036 – 0.062	0.9 – 1.6	Weather Resistant Polyethylene	Black		1
GES99F-C	0.17	4.3	0.19	4.7	0.062 – 0.099	1.6 – 2.5	Polyethylene	Natural		1
GES99F-C0	0.17	4.3	0.19	4.7	0.062 – 0.099	1.6 – 2.5	Weather Resistant Polyethylene	Black		1
GES144F-C	0.21	5.4	0.22	5.6	0.099 – 0.144	2.5 – 3.7	Polyethylene	Natural		1
GES144F-C0	0.21	5.4	0.22	5.6	0.099 – 0.144	2.5 – 3.7	Weather Resistant Polyethylene	Black		1
GES189F-C	0.30	7.6	0.30	7.6	0.144 – 0.189	3.7 – 4.8	Polyethylene	Natural		1
GES189F-C0	0.30	7.6	0.30	7.6	0.144 – 0.189	3.7 – 4.8	Weather Resistant Polyethylene	Black		1
<b>Slotted Adhesive Lined</b>										
GEE62F-A-C	0.13	3.3	0.16	4.1	0.036 – 0.062	0.9 – 1.6	Polyethylene	Natural	-40°F – 122°F (-40°C – 50°C)	1
GEE62F-A-C0	0.13	3.3	0.16	4.1	0.036 – 0.062	0.9 – 1.6	Weather Resistant Polyethylene	Black		1
GEE99F-A-C	0.17	4.3	0.19	4.7	0.062 – 0.099	1.6 – 2.5	Polyethylene	Natural		1
GEE99F-A-C0	0.17	4.3	0.19	4.7	0.062 – 0.099	1.6 – 2.5	Weather Resistant Polyethylene	Black		1
GEE144F-A-C	0.21	5.4	0.22	5.6	0.099 – 0.144	2.5 – 3.7	Polyethylene	Natural		1
GEE144F-A-C0	0.21	5.4	0.22	5.6	0.099 – 0.144	2.5 – 3.7	Weather Resistant Polyethylene	Black		1
<b>Solid Adhesive Lined – Use on straight edges only</b>										
GES62F-A-C	0.13	3.3	0.16	4.1	0.036 – 0.062	0.9 – 1.6	Polyethylene	Natural	-40°F – 122°F (-40°C – 50°C)	1
GES62F-A-C0	0.13	3.3	0.16	4.1	0.036 – 0.062	0.9 – 1.6	Weather Resistant Polyethylene	Black		1
GES99F-A-C	0.17	4.3	0.19	4.7	0.062 – 0.099	1.6 – 2.5	Polyethylene	Natural		1
GES99F-A-C0	0.17	4.3	0.19	4.7	0.062 – 0.099	1.6 – 2.5	Weather Resistant Polyethylene	Black		1
GES144F-A-C	0.21	5.4	0.22	5.6	0.099 – 0.144	2.5 – 3.7	Polyethylene	Natural		1
GES144F-A-C0	0.21	5.4	0.22	5.6	0.099 – 0.144	2.5 – 3.7	Weather Resistant Polyethylene	Black		1
<b>Slotted Flame Retardant</b>										
GEE36FR-CY	0.11	2.7	0.12	3.0	0.026 – 0.036	0.7 – 0.9	Flame Retardant Polyethylene	Natural	-4°F – 167°F (-20°C – 75°C)	1
GEE62FR-CY	0.13	3.3	0.16	4.1	0.036 – 0.062	0.9 – 1.6	Flame Retardant Polyethylene	Natural		1
GEE99FR-CY	0.17	4.3	0.19	4.7	0.062 – 0.099	1.6 – 2.5	Flame Retardant Polyethylene	Natural		1
GEE144FR-CY	0.21	5.4	0.22	5.6	0.099 – 0.144	2.5 – 3.7	Flame Retardant Polyethylene	Natural		1

‡Reel packaging may contain splices. Contact Panduit Customer Service for further information.

Table continues on page C3.10

A.  
System  
Overview

B1.  
Cable  
Ties

B2.  
Cable  
Accessories

B3.  
Stainless  
Steel Ties

C1.  
Wiring  
Duct

C2.  
Surface  
Raceway

C3.  
Abrasion  
Protection

C4.  
Cable  
Management

D1.  
Terminals

D2.  
Power  
Connectors

D3.  
Grounding  
Connectors

E1.  
Labeling  
Systems

E2.  
Labels

E3.  
Pre-Printed  
& Write-On  
Markers

E4.  
Permanent  
Identification

E5.  
Lockout/  
Tagout  
& Safety  
Solutions

F.  
Index

A.  
System  
Overview

## Grommet Edging (continued)

B1.  
Cable Ties

Part Number	Width A		Height B		Panel Thickness Range		Material	Color	Temperature Range	Std. Pkg. Qty.‡
	In.	mm	In.	mm	In.	mm				

B2.  
Cable  
Accessories

### Solid Flame Retardant – Used on straight edges only

GES36FR-CY	0.11	2.7	0.12	3.0	0.026 – 0.036	0.7 – 0.9	Flame Retardant Polyethylene	Natural	-4°F – 167°F (-20°C – 75°C)	1
GES62FR-CY	0.13	3.3	0.16	4.1	0.036 – 0.062	0.9 – 1.6	Flame Retardant Polyethylene	Natural		1
GES99FR-CY	0.17	4.3	0.19	4.7	0.062 – 0.099	1.6 – 2.5	Flame Retardant Polyethylene	Natural		1
GES144FR-CY	0.21	5.4	0.22	5.6	0.099 – 0.144	2.5 – 3.7	Flame Retardant Polyethylene	Natural		1

B3.  
Stainless  
Steel Ties

C1.  
Wiring  
Duct

### Slotted Nylon

GEE47N-C	0.13	3.2	0.14	3.6	0.039 – 0.055	1.0 – 1.4	Nylon 6	Natural	-40°F – 149°F (-40°C – 65°C)	1
GEE55N-C	0.13	3.4	0.14	3.6	0.047 – 0.063	1.2 – 1.6	Nylon 6	Natural		1
GEE71N-C	0.15	3.8	0.14	3.6	0.063 – 0.079	1.6 – 2.0	Nylon 6	Natural		1
GEE98N-C	0.18	4.6	0.14	3.6	0.091 – 0.106	2.3 – 2.7	Nylon 6	Natural		1
GEE134N-C	0.21	5.3	0.14	3.6	0.126 – 0.142	3.2 – 3.6	Nylon 6	Natural		1

C2.  
Surface  
Raceway

C3.  
Abrasion  
Protection

C4.  
Cable  
Management

### Military Standard MS21266 in 12 3/4" Lengths

GE52-C	0.15	3.8	0.16	3.9	0.015 – 0.052	0.4 – 1.3	Nylon 6.6	Natural	-40°F – 149°F (-40°C – 65°C)	100
GE52-C69*	0.15	3.8	0.16	3.9	0.015 – 0.052	0.4 – 1.3	Flame Retardant Nylon 6.6	Natural		100
GE85-C	0.18	4.5	0.16	3.9	0.052 – 0.085	1.3 – 2.2	Nylon 6.6	Natural		100
GE85-C69*	0.18	4.5	0.16	3.9	0.052 – 0.085	1.3 – 2.2	Flame Retardant Nylon 6.6	Natural		100
GE128-C	0.22	5.6	0.16	3.9	0.085 – 0.128	2.2 – 3.3	Nylon 6.6	Natural		100
GE128-C69*	0.22	5.6	0.16	3.9	0.085 – 0.128	2.2 – 3.3	Flame Retardant Nylon 6.6	Natural		100
GE192-L	0.33	8.3	0.23	5.8	0.128 – 0.192	3.3 – 4.9	Nylon 6.6	Natural		50
GE192-L69*	0.33	8.3	0.23	5.8	0.128 – 0.192	3.3 – 4.9	Flame Retardant Nylon 6.6	Natural		50
GE255-L	0.39	9.8	0.24	6.1	0.192 – 0.255	4.9 – 6.5	Nylon 6.6	Natural		50
GE318-L	0.46	11.3	0.26	6.5	0.255 – 0.318	6.5 – 8.1	Nylon 6.6	Natural		50
GE380-Q	0.52	13.1	0.26	6.5	0.318 – 0.380	8.1 – 9.7	Nylon 6.6	Natural	25	
GE510-Q	0.64	16.3	0.26	6.5	0.380 – 0.510	9.7 – 13.0	Nylon 6.6	Natural	25	

‡Reel packaging may contain splices. Contact Panduit Customer Service for further information.

\*This material is not listed under Military Standard MS21266.

E4.  
Permanent  
Identification

E5.  
Lockout/  
Tagout/  
& Safety  
Solutions

F.  
Index



## Part Number System for Corrugated Loom Tubing

CLT	100	N	-	C	630
Type	Bundle Diameter	Material		Package Size	Color Suffix
CLT = Slit Wall CLTS = Solid Wall	25 = 1/4" 35 = 5/16" 38 = 3/8" 50 = 1/2" 62 = 5/8" 75 = 3/4" 100 = 1" 125 = 1 1/4" 150 = 1 1/2" 188 = 1 7/8"	N = Heat Stabilized Nylon F = Polyethylene		X = 10' L = 50' C = 100' T = 200' D = 500' .75M = 750' 125M = 1,250' 2M = 2,000' 2.5M = 2,500' 4M = 4,000' 5M = 5,000' 7M = 7,000' 10M = 10,000'	630 = Heat Stabilized Black Nylon 6 20 = Black Polyethylene 3 = Orange Polyethylene 4 = Yellow Polyethylene

## Corrugated Loom Tubing – Slit

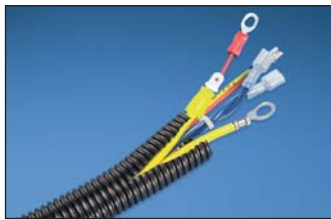

- Provides protection for cables
- Packaged on a reel for easy handling and dispensing of product
- For indoor use only
- Available in Nylon or Polyethylene, this product features a lengthwise slit which makes it easy to install onto a bundle of wires or a pre-assembled harness assembly
- Crush, impact and abrasion resistant

Part Number	Material	Color	Length Per Reel		Inside Diameter		Outside Diameter		Temperature Range	Std. Pkg. Qty.*
			Ft.	m	In.	mm	In.	mm		
<b>Slit Wall</b>										
CLT25F-C3	Polyethylene	Orange	100	30.5	0.28	7.0	0.40	10.1	-40°F – 122°F (-40°C – 50°C)	1
CLT25F-C4	Polyethylene	Yellow	100	30.5	0.28	7.0	0.40	10.1	-40°F – 122°F (-40°C – 50°C)	1
CLT25F-C20	Polyethylene	Black	100	30.5	0.28	7.0	0.40	10.1	-40°F – 122°F (-40°C – 50°C)	1
CLT25F-10M20	Polyethylene	Black	10,000	3048.0	0.28	7.0	0.40	10.1	-40°F – 122°F (-40°C – 50°C)	1
CLT35F-C3	Polyethylene	Orange	100	30.5	0.35	8.9	0.50	12.7	-40°F – 122°F (-40°C – 50°C)	1
CLT35F-C4	Polyethylene	Yellow	100	30.5	0.35	8.9	0.50	12.7	-40°F – 122°F (-40°C – 50°C)	1
CLT35F-C20	Polyethylene	Black	100	30.5	0.35	8.9	0.50	12.7	-40°F – 122°F (-40°C – 50°C)	1
CLT35F-7M20	Polyethylene	Black	7,000	2133.6	0.35	8.9	0.50	12.7	-40°F – 122°F (-40°C – 50°C)	1
CLT38F-C3	Polyethylene	Orange	100	30.5	0.42	10.5	0.56	14.1	-40°F – 122°F (-40°C – 50°C)	1
CLT38F-C4	Polyethylene	Yellow	100	30.5	0.42	10.5	0.56	14.1	-40°F – 122°F (-40°C – 50°C)	1
CLT38F-C20	Polyethylene	Black	100	30.5	0.42	10.5	0.56	14.1	-40°F – 122°F (-40°C – 50°C)	1
CLT38F-5M20	Polyethylene	Black	5,000	1524.0	0.42	10.5	0.56	14.1	-40°F – 122°F (-40°C – 50°C)	1
CLT50F-C3	Polyethylene	Orange	100	30.5	0.51	12.8	0.67	17.0	-40°F – 122°F (-40°C – 50°C)	1
CLT50F-C4	Polyethylene	Yellow	100	30.5	0.51	12.8	0.67	17.0	-40°F – 122°F (-40°C – 50°C)	1
CLT50F-C20	Polyethylene	Black	100	30.5	0.51	12.8	0.67	17.0	-40°F – 122°F (-40°C – 50°C)	1
CLT50F-4M20	Polyethylene	Black	4,000	1219.2	0.51	12.8	0.67	17.0	-40°F – 122°F (-40°C – 50°C)	1
CLT62F-C3	Polyethylene	Orange	100	30.5	0.65	16.5	0.82	20.7	-40°F – 122°F (-40°C – 50°C)	1
CLT62F-C4	Polyethylene	Yellow	100	30.5	0.65	16.5	0.82	20.7	-40°F – 122°F (-40°C – 50°C)	1
CLT62F-C20	Polyethylene	Black	100	30.5	0.65	16.5	0.82	20.7	-40°F – 122°F (-40°C – 50°C)	1
CLT62F-2.5M20	Polyethylene	Black	2,500	762.0	0.65	16.5	0.82	20.7	-40°F – 122°F (-40°C – 50°C)	1
CLT75F-C3	Polyethylene	Orange	100	30.5	0.76	19.3	0.94	23.8	-40°F – 122°F (-40°C – 50°C)	1

\*Reel packaging may contain splices. Contact Panduit Customer Service for further information.

Table continues on page C3.12

A.  
System  
Overview

## Corrugated Loom Tubing – Slit (continued)

B1.  
Cable Ties

B2.  
Cable  
Accessories

B3.  
Stainless  
Steel Ties

C1.  
Wiring  
Duct

C2.  
Surface  
Raceway

C3.  
Abrasion  
Protection

C4.  
Cable  
Management

Part Number	Material	Color	Length Per Reel		Inside Diameter		Outside Diameter		Temperature Range	Std. Pkg. Qty.*
			Ft.	m	In.	mm	In.	mm		
CLT75F-C4	Polyethylene	Yellow	100	30.5	0.76	19.3	0.94	23.8	-40°F – 122°F (-40°C – 50°C)	1
CLT75F-C20	Polyethylene	Black	100	30.5	0.76	19.3	0.94	23.8	-40°F – 122°F (-40°C – 50°C)	1
CLT75F-2M20	Polyethylene	Black	2,000	609.6	0.76	19.3	0.94	23.8	-40°F – 122°F (-40°C – 50°C)	1
CLT100F-X4	Polyethylene	Yellow	10	3.1	0.92	23.2	1.09	27.7	-40°F – 122°F (-40°C – 50°C)	1
CLT100F-C3	Polyethylene	Orange	100	30.5	0.92	23.2	1.09	27.7	-40°F – 122°F (-40°C – 50°C)	1
CLT100F-C4	Polyethylene	Yellow	100	30.5	0.92	23.2	1.09	27.7	-40°F – 122°F (-40°C – 50°C)	1
CLT100F-C20	Polyethylene	Black	100	30.5	0.92	23.2	1.09	27.7	-40°F – 122°F (-40°C – 50°C)	1
CLT100F-125M20	Polyethylene	Black	1,250	381.0	0.92	23.2	1.09	27.7	-40°F – 122°F (-40°C – 50°C)	1
CLT125F-L3	Polyethylene	Orange	50	15.2	1.29	32.8	1.50	38.1	-40°F – 122°F (-40°C – 50°C)	1
CLT125F-L4	Polyethylene	Yellow	50	15.2	1.29	32.8	1.50	38.1	-40°F – 122°F (-40°C – 50°C)	1
CLT125F-L20	Polyethylene	Black	50	15.2	1.29	32.8	1.50	38.1	-40°F – 122°F (-40°C – 50°C)	1
CLT125F-.75M20	Polyethylene	Black	750	228.6	1.29	32.8	1.50	38.1	-40°F – 122°F (-40°C – 50°C)	1
CLT150F-X3	Polyethylene	Orange	10	3.1	1.48	37.6	1.73	43.9	-40°F – 122°F (-40°C – 50°C)	1
CLT150F-X4	Polyethylene	Yellow	10	3.1	1.48	37.6	1.73	43.9	-40°F – 122°F (-40°C – 50°C)	1
CLT150F-T20	Polyethylene	Black	200	61.0	1.48	37.6	1.73	43.9	-40°F – 122°F (-40°C – 50°C)	1
CLT150F-D3	Polyethylene	Orange	500	152.4	1.48	37.6	1.73	43.9	-40°F – 122°F (-40°C – 50°C)	1
CLT150F-D4	Polyethylene	Yellow	500	152.4	1.48	37.6	1.73	43.9	-40°F – 122°F (-40°C – 50°C)	1
CLT150F-D20	Polyethylene	Black	500	152.4	1.48	37.6	1.73	43.9	-40°F – 122°F (-40°C – 50°C)	1
CLT188F-X3	Polyethylene	Orange	10	3.1	1.88	47.8	2.17	55.1	-40°F – 122°F (-40°C – 50°C)	1
CLT188F-X4	Polyethylene	Yellow	10	3.1	1.88	47.8	2.17	55.1	-40°F – 122°F (-40°C – 50°C)	1
CLT188F-X20	Polyethylene	Black	10	3.1	1.88	47.8	2.17	55.1	-40°F – 122°F (-40°C – 50°C)	1

### Solid Wall

CLTS25F-C	Polyethylene	Black	100	30.5	0.28	7.0	0.40	10.1	-40°F – 122°F (-40°C – 50°C)	1
CLTS25F-C3	Polyethylene	Orange	100	30.5	0.28	7.0	0.40	10.1	-40°F – 122°F (-40°C – 50°C)	1
CLTS25F-10M	Polyethylene	Black	10,000	3048.0	0.28	7.0	0.40	10.1	-40°F – 122°F (-40°C – 50°C)	1
CLTS35F-C	Polyethylene	Black	100	30.5	0.35	8.9	0.50	12.7	-40°F – 122°F (-40°C – 50°C)	1
CLTS35F-C3	Polyethylene	Orange	100	30.5	0.35	8.9	0.50	12.7	-40°F – 122°F (-40°C – 50°C)	1
CLTS38F-C	Polyethylene	Black	100	30.5	0.42	10.5	0.56	14.1	-40°F – 122°F (-40°C – 50°C)	1
CLTS38F-C3	Polyethylene	Orange	100	30.5	0.42	10.5	0.56	14.1	-40°F – 122°F (-40°C – 50°C)	1
CLTS50F-C	Polyethylene	Black	100	30.5	0.51	12.8	0.67	17.0	-40°F – 122°F (-40°C – 50°C)	1
CLTS50F-C3	Polyethylene	Orange	100	30.5	0.51	12.8	0.67	17.0	-40°F – 122°F (-40°C – 50°C)	1
CLTS62F-C	Polyethylene	Black	100	30.5	0.65	16.5	0.82	20.7	-40°F – 122°F (-40°C – 50°C)	1
CLTS62F-C3	Polyethylene	Orange	100	30.5	0.65	16.5	0.82	20.7	-40°F – 122°F (-40°C – 50°C)	1
CLTS75F-C	Polyethylene	Black	100	30.5	0.76	19.3	0.94	23.8	-40°F – 122°F (-40°C – 50°C)	1
CLTS75F-C3	Polyethylene	Orange	100	30.5	0.76	19.3	0.94	23.8	-40°F – 122°F (-40°C – 50°C)	1
CLTS75F-2M	Polyethylene	Black	2,000	609.6	0.76	19.3	0.94	23.8	-40°F – 122°F (-40°C – 50°C)	1
CLTS100F-C	Polyethylene	Black	100	30.5	0.92	23.2	1.09	27.7	-40°F – 122°F (-40°C – 50°C)	1
CLTS100F-C3	Polyethylene	Orange	100	30.5	0.92	23.2	1.09	27.7	-40°F – 122°F (-40°C – 50°C)	1
CLTS100F-1.25M	Polyethylene	Black	1,250	381.0	0.92	23.2	1.09	27.7	-40°F – 122°F (-40°C – 50°C)	1
CLTS150F-D	Polyethylene	Black	500	152.4	1.48	37.6	1.73	43.9	-40°F – 122°F (-40°C – 50°C)	1
CLTS150F-D3	Polyethylene	Orange	500	152.4	1.48	39.1	1.73	43.9	-40°F – 122°F (-40°C – 50°C)	1

\*Reel packaging may contain splices. Contact Panduit Customer Service for further information.

E4.  
Permanent  
Identification

E5.  
Lockout/  
Tagout  
& Safety  
Solutions

F.  
Index

## Corrugated Loom Tubing – Slit (continued)

Part Number	Material	Color	Length Per Reel		Inside Diameter		Outside Diameter		Temperature Range	Std. Pkg. Qty.*
			Ft.	m	In.	mm	In.	mm		
<b>Nylon Slit</b>										
CLT25N-C630	Heat Stabilized Nylon 6	Black	100	30.5	0.28	7.0	0.40	10.1	-40°F – 230°F (-40°C – 110°C)	1
CLT25N-10M630	Heat Stabilized Nylon 6	Black	10,000	3048.0	0.28	7.0	0.40	10.1	-40°F – 230°F (-40°C – 110°C)	1
CLT35N-C630	Heat Stabilized Nylon 6	Black	100	30.5	0.35	8.9	0.50	12.7	-40°F – 230°F (-40°C – 110°C)	1
CLT38N-C630	Heat Stabilized Nylon 6	Black	100	30.5	0.42	10.5	0.56	14.1	-40°F – 230°F (-40°C – 110°C)	1
CLT38N-5M630	Heat Stabilized Nylon 6	Black	5,000	1524.0	0.42	10.5	0.56	14.1	-40°F – 230°F (-40°C – 110°C)	1
CLT50N-C630	Heat Stabilized Nylon 6	Black	100	30.5	0.51	12.8	0.67	17.0	-40°F – 230°F (-40°C – 110°C)	1
CLT50N-4M630	Heat Stabilized Nylon 6	Black	4,000	1219.2	0.51	12.8	0.67	17.0	-40°F – 230°F (-40°C – 110°C)	1
CLT62N-C630	Heat Stabilized Nylon 6	Black	100	30.5	0.65	16.5	0.82	20.7	-40°F – 230°F (-40°C – 110°C)	1
CLT62N-2.5M630	Heat Stabilized Nylon 6	Black	2,500	762.0	0.65	16.5	0.82	20.7	-40°F – 230°F (-40°C – 110°C)	1
CLT75N-C630	Heat Stabilized Nylon 6	Black	100	30.5	0.76	19.3	0.94	23.8	-40°F – 230°F (-40°C – 110°C)	1
CLT75N-2M630	Heat Stabilized Nylon 6	Black	2,000	609.6	0.76	19.3	0.94	23.8	-40°F – 230°F (-40°C – 110°C)	1
CLT100N-C630	Heat Stabilized Nylon 6	Black	100	30.5	0.92	23.2	1.09	27.7	-40°F – 230°F (-40°C – 110°C)	1
CLT100N-125M630	Heat Stabilized Nylon 6	Black	1,250	381.0	0.92	23.2	1.09	27.7	-40°F – 230°F (-40°C – 110°C)	1
CLT125N-L630	Heat Stabilized Nylon 6	Black	50	15.2	1.29	32.8	1.50	38.1	-40°F – 230°F (-40°C – 110°C)	1
CLT125N-.75M630	Heat Stabilized Nylon 6	Black	750	228.6	1.29	32.8	1.50	38.1	-40°F – 230°F (-40°C – 110°C)	1
CLT150N-D630	Heat Stabilized Nylon 6	Black	500	152.4	1.48	37.6	1.73	43.9	-40°F – 230°F (-40°C – 110°C)	1
CLT188N-6C630	Heat Stabilized Nylon 6	Black	600	182.9	1.88	47.8	2.17	55.1	-40°F – 230°F (-40°C – 110°C)	1
<b>Nylon Solid</b>										
CLTS25N-C	Heat Stabilized Nylon 6	Black	100	30.5	0.28	7.0	0.40	10.1	-40°F – 230°F (-40°C – 110°C)	1
CLTS25N-10M	Heat Stabilized Nylon 6	Black	10,000	3048.0	0.28	7.0	0.40	10.1	-40°F – 230°F (-40°C – 110°C)	1
CLTS35N-C	Heat Stabilized Nylon 6	Black	100	30.5	0.35	8.9	0.50	12.7	-40°F – 230°F (-40°C – 110°C)	1
CLTS38N-C	Heat Stabilized Nylon 6	Black	100	30.5	0.42	10.5	0.56	14.1	-40°F – 230°F (-40°C – 110°C)	1
CLTS50N-C	Heat Stabilized Nylon 6	Black	100	30.5	0.51	12.8	0.67	17.0	-40°F – 230°F (-40°C – 110°C)	1
CLTS62N-C	Heat Stabilized Nylon 6	Black	100	30.5	0.65	16.5	0.82	20.7	-40°F – 230°F (-40°C – 110°C)	1
CLTS75N-C	Heat Stabilized Nylon 6	Black	100	30.5	0.76	19.3	0.94	23.8	-40°F – 230°F (-40°C – 110°C)	1
CLTS75N-2M	Heat Stabilized Nylon 6	Black	2,000	609.6	0.76	19.3	0.94	23.8	-40°F – 230°F (-40°C – 110°C)	1
CLTS100N-C	Heat Stabilized Nylon 6	Black	100	30.5	0.92	23.2	1.09	27.7	-40°F – 230°F (-40°C – 110°C)	1
CLTS125N-L	Heat Stabilized Nylon 6	Black	50	15.2	1.29	32.8	1.50	38.1	-40°F – 230°F (-40°C – 110°C)	1

\*Reel packaging may contain splices. Contact Panduit Customer Service for further information.

A.  
System  
Overview

B1.  
Cable  
Ties

B2.  
Cable  
Accessories

B3.  
Stainless  
Steel Ties

C1.  
Wiring  
Duct

C2.  
Surface  
Raceway

C3.  
Abrasion  
Protection

C4.  
Cable  
Management

D1.  
Terminals

D2.  
Power  
Connectors

D3.  
Grounding  
Connectors

E1.  
Labeling  
Systems

E2.  
Labels

E3.  
Pre-Printed  
& Write-On  
Markers

E4.  
Permanent  
Identification

E5.  
Lockout/  
Tagout  
& Safety  
Solutions

F.  
Index

A.  
System  
Overview

## Corrugated Loom Tubing Fittings

B1.  
Cable Ties

- Provide a secure way to join CLT at junctions and breakouts while improving the appearance of wire harnesses
- Color: Black
- Material: Polypropylene

B2.  
Cable  
Accessories



B3.  
Stainless  
Steel Ties

Part Number	Branch Diameter		Trunk Diameter		Std. Pkg. Qty.	Std. Ctn. Qty.
	In.	mm	In.	mm		
CF382538F-Q	0.38	9.5	0.25	6.4	25	100
CF502550F-Q	0.50	12.7	0.25	6.4	25	100
CF503850F-Q	0.50	12.7	0.38	9.5	25	100
CF752575F-Q	0.75	19.1	0.25	6.4	25	100
CF753875F-Q	0.75	19.1	0.38	9.5	25	100

C1.  
Wiring  
Duct

C2.  
Surface  
Raceway

C3.  
Abrasion  
Protection

C4.  
Cable  
Management

## Part Number System for Braided Expandable Sleeving

D1.  
Terminals

D2.  
Power  
Connectors

D3.  
Grounding  
Connectors

E1.  
Labeling  
Systems

E2.  
Labels

E3.  
Pre-Printed  
& Write-On  
Markers

E4.  
Permanent  
Identification

E5.  
Lockout/  
Tagout/  
& Safety  
Solutions

F.  
Index

<u>SE</u>	<u>25</u>	<u>PFR</u>	-	<u>M</u>	<u>R</u>	<u>0</u>
Type	Nominal I.D. Size	Material		Package Size	R = Reel	Color Suffix
SE = Sleeving Expandable	12 = 1/8" (3.2mm) 25 = 1/4" (6.4mm) 38 = 3/8" (9.5mm) 50 = 1/2" (12.7mm) 75 = 3/4" (19.1mm) 125 = 1 1/4" (31.8mm) 150 = 1 1/2" (38.1mm) 175 = 1 3/4" (44.5mm)	P = Polyethylene Terephthalate (PET) PFR = Polyethylene Terephthalate (PET) Flame Retardant PSC = Fray Resistant Polyethylene Terephthalate (PET)		L = 50' (15.2m) C = 100' (30.5m) T = 200' (61.0m) D = 500' (152.4m) M = 1000' (304.8m)		0 = Black 8 = Gray 10 = White



## Braided Expandable Sleeving – Polyethylene Terephthalate (PET)

- Provides continuous abrasion protection for wires, cables, hoses and tubing
- Highly flexible open weave will not trap heat or humidity
- Allows for use with irregular shapes

- Lightweight, durable protection
- Rated for use up to 257°F (125°C)
- Compliant with U.S. and European passenger rail standards



Part Number	Color	Nominal I.D.		Nominal Diameter Range		Length per reel		Std. Pkg. Qty.	Std. Ctn. Qty.
		In.	mm	In.	mm	Ft.	m		
SE12P-TR0	Black	0.12	3.2	0.094 – 0.250	2.4 – 6.4	200	61.0	1	4
SE12P-TR8	Gray	0.12	3.2	0.094 – 0.250	2.4 – 6.4	200	61.0	1	4
SE12P-MR0	Black	0.12	3.2	0.094 – 0.250	2.4 – 6.4	1000	304.8	1	2
SE12P-MR8	Gray	0.12	3.2	0.094 – 0.250	2.4 – 6.4	1000	304.8	1	2
SE12P-MR10	White	0.12	3.2	0.094 – 0.250	2.4 – 6.4	1000	304.8	1	2
SE25P-TR0	Black	0.25	6.4	0.125 – 0.375	3.2 – 9.5	200	61.0	1	4
SE25P-TR8	Gray	0.25	6.4	0.125 – 0.375	3.2 – 9.5	200	61.0	1	4
SE25P-MR0	Black	0.25	6.4	0.125 – 0.375	3.2 – 9.5	1000	304.8	1	2
SE25P-MR8	Gray	0.25	6.4	0.125 – 0.375	3.2 – 9.5	1000	304.8	1	2
SE25P-MR10	White	0.25	6.4	0.125 – 0.375	3.2 – 9.5	1000	304.8	1	2
SE38P-TR0	Black	0.38	9.5	0.188 – 0.500	4.8 – 15.9	200	61.0	1	4
SE38P-TR8	Gray	0.38	9.5	0.188 – 0.500	4.8 – 15.9	200	61.0	1	4
SE38P-MR0	Black	0.38	9.5	0.188 – 0.500	4.8 – 15.9	1000	304.8	1	2
SE38P-MR8	Gray	0.38	9.5	0.188 – 0.500	4.8 – 15.9	1000	304.8	1	2
SE38P-MR10	White	0.38	9.5	0.188 – 0.500	4.8 – 15.9	1000	304.8	1	2
SE50P-CR0	Black	0.50	12.7	0.250 – 0.750	6.4 – 19.1	100	30.5	1	4
SE50P-CR8	Gray	0.50	12.7	0.250 – 0.750	6.4 – 19.1	100	30.5	1	4
SE50P-DR0	Black	0.50	12.7	0.250 – 0.750	6.4 – 19.1	500	152.4	1	2
SE50P-DR8	Gray	0.50	12.7	0.250 – 0.750	6.4 – 19.1	500	152.4	1	2
SE50P-DR10	White	0.50	12.7	0.250 – 0.750	6.4 – 19.1	500	152.4	1	2
SE75P-CR0	Black	0.75	19.1	0.500 – 1.25	12.7 – 31.8	100	30.5	1	4
SE75P-CR8	Gray	0.75	19.1	0.500 – 1.25	12.7 – 31.8	100	30.5	1	4
SE75P-DR0	Black	0.75	19.1	0.500 – 1.25	12.7 – 31.8	500	152.4	1	2
SE75P-DR8	Gray	0.75	19.1	0.500 – 1.25	12.7 – 31.8	500	152.4	1	2
SE75P-DR10	White	0.75	19.1	0.500 – 1.25	12.7 – 31.8	500	152.4	1	2
SE125P-LR0	Black	1.25	31.8	0.750 – 1.50	19.1 – 38.1	50	15.2	1	4
SE125P-LR8	Gray	1.25	31.8	0.750 – 1.50	19.1 – 38.1	50	15.2	1	4
SE125P-TR0	Black	1.25	31.8	0.750 – 1.50	19.1 – 38.1	200	61.0	1	2
SE125P-TR8	Gray	1.25	31.8	0.750 – 1.50	19.1 – 38.1	200	61.0	1	2
SE125P-TR10	White	1.25	31.8	0.750 – 1.50	19.1 – 38.1	200	61.0	1	2
SE150P-LR0	Black	1.50	38.1	1.00 – 2.13	25.4 – 54.0	50	15.2	1	4
SE150P-LR8	Gray	1.50	38.1	1.00 – 2.13	25.4 – 54.0	50	15.2	1	4
SE150P-TR0	Black	1.50	38.1	1.00 – 2.13	25.4 – 54.0	200	61.0	1	2
SE150P-TR8	Gray	1.50	38.1	1.00 – 2.13	25.4 – 54.0	200	61.0	1	2
SE150P-TR10	White	1.50	38.1	1.00 – 2.13	25.4 – 54.0	200	61.0	1	2
SE175P-TR0	Black	1.75	44.5	1.25 – 2.75	31.8 – 69.9	200	61.0	1	2

Reel packaging may contain splices. Contact Panduit Customer Service for further information.

A.  
System  
Overview

B1.  
Cable Ties

B2.  
Cable  
Accessories

B3.  
Stainless  
Steel Ties

C1.  
Wiring  
Duct

C2.  
Surface  
Raceway

C3.  
Abrasion  
Protection

C4.  
Cable  
Management

D1.  
Terminals

D2.  
Power  
Connectors

D3.  
Grounding  
Connectors

E1.  
Labeling  
Systems

E2.  
Labels

E3.  
Pre-Printed  
& Write-On  
Markers

E4.  
Permanent  
Identification

E5.  
Lockout/  
Tagout/  
& Safety  
Solutions

F.  
Index

A. System Overview



## Braided Expandable Sleeving – Flame Retardant Polyethylene Terephthalate

B1. Cable Ties

- Provides continuous abrasion protection for wires, cables, hoses and tubing
- Highly flexible open weave will not trap heat or humidity
- Rated for use up to 257°F (125°C)
- Allows for use with irregular shapes
- Flammability: Meets UL 1441 VW-1
- Compliant with U.S. and European passenger rail standards

B2. Cable Accessories



B3. Stainless Steel Ties

C1. Wiring Duct

C2. Surface Raceway

C3. Abrasion Protection

C4. Cable Management

D1. Terminals

D2. Power Connectors

D3. Grounding Connectors

E1. Labeling Systems

E2. Labels

E3. Pre-Printed & Write-On Markers

E4. Permanent Identification

E5. Lockout/Tagout & Safety Solutions

F. Index

Part Number	Color	Nominal I.D.		Nominal Diameter Range		Length per reel		Std. Pkg. Qty.	Std. Ctn. Qty.
		In.	mm	In.	mm	Ft.	m		
SE12PFR-TR0	Black	0.12	3.2	0.094 – 0.250	2.4 – 6.4	200	61.0	1	4
SE12PFR-MR0	Black	0.12	3.2	0.094 – 0.250	2.4 – 6.4	1000	304.8	1	2
SE12PFR-TR8	Gray	0.12	3.2	0.094 – 0.250	2.4 – 6.4	200	61.0	1	4
SE12PFR-MR8	Gray	0.12	3.2	0.094 – 0.250	2.4 – 6.4	1000	304.8	1	2
SE12PFR-MR10	White	0.12	3.2	0.094 – 0.250	2.4 – 6.4	1000	304.8	1	2
SE25PFR-TR0	Black	0.25	6.4	0.125 – 0.375	3.2 – 9.5	200	61.0	1	4
SE25PFR-MR0	Black	0.25	6.4	0.125 – 0.375	3.2 – 9.5	1000	304.8	1	2
SE25PFR-TR8	Gray	0.25	6.4	0.125 – 0.375	3.2 – 9.5	200	61.0	1	4
SE25PFR-MR8	Gray	0.25	6.4	0.125 – 0.375	3.2 – 9.5	1000	304.8	1	2
SE25PFR-MR10	White	0.25	6.4	0.125 – 0.375	3.2 – 9.5	1000	304.8	1	2
SE38PFR-MR0	Black	0.38	9.5	0.188 – 0.625	4.8 – 15.9	1000	304.8	1	2
SE38PFR-TR0	Black	0.38	9.5	0.188 – 0.625	4.8 – 15.9	200	61.0	1	4
SE38PFR-TR8	Gray	0.38	9.5	0.188 – 0.625	4.8 – 15.9	200	61.0	1	4
SE38PFR-MR8	Gray	0.38	9.5	0.188 – 0.500	4.8 – 12.7	1000	304.8	1	2
SE38PFR-MR10	White	0.38	9.5	0.188 – 0.500	4.8 – 12.7	1000	304.8	1	2
SE50PFR-CR0	Black	0.50	12.7	0.250 – 0.750	6.4 – 19.1	100	30.5	1	4
SE50PFR-CR8	Gray	0.50	12.7	0.250 – 0.750	6.4 – 19.1	100	30.5	1	4
SE50PFR-DR0	Black	0.50	12.7	0.250 – 0.750	6.4 – 19.1	500	152.4	1	2
SE50PFR-DR8	Gray	0.50	12.7	0.250 – 0.750	6.4 – 19.1	500	152.4	1	2
SE50PFR-DR10	White	0.50	12.7	0.250 – 0.750	6.4 – 19.1	500	152.4	1	2
SE75PFR-CR0	Black	0.75	19.1	0.500 – 1.25	12.7 – 31.8	100	30.5	1	4
SE75PFR-CR8	Gray	0.75	19.1	0.500 – 1.25	12.7 – 31.8	100	30.5	1	4
SE75PFR-DR0	Black	0.75	19.1	0.500 – 1.25	12.7 – 31.8	500	152.4	1	2
SE75PFR-DR8	Gray	0.75	19.1	0.500 – 1.25	12.7 – 31.8	500	152.4	1	2
SE75PFR-DR10	White	0.75	19.1	0.500 – 1.25	12.7 – 31.8	500	152.4	1	2
SE125PFR-LR0	Black	1.25	31.8	0.750 – 1.50	19.1 – 38.1	50	15.2	1	4
SE125PFR-LR8	Gray	1.25	31.8	0.750 – 1.50	19.1 – 38.1	50	15.2	1	4
SE125PFR-TR0	Black	1.25	31.8	0.750 – 1.50	19.1 – 38.1	200	61.0	1	2
SE125PFR-TR8	Gray	1.25	31.8	0.750 – 1.50	19.1 – 38.1	200	61.0	1	2
SE125PFR-TR10	White	1.25	31.8	0.750 – 1.50	19.1 – 38.1	200	61.0	1	2
SE150PFR-LR0	Black	1.50	38.1	1.00 – 2.13	25.4 – 54.0	50	15.2	1	4
SE150PFR-LR8	Gray	1.50	38.1	1.00 – 2.13	25.4 – 54.0	50	15.2	1	4
SE150PFR-TR0	Black	1.50	38.1	1.00 – 2.13	25.4 – 54.0	200	61.0	1	2
SE150PFR-TR8	Gray	1.50	38.1	1.00 – 2.13	25.4 – 54.0	200	61.0	1	2
SE150PFR-TR10	White	1.50	38.1	1.00 – 2.13	25.4 – 54.0	200	61.0	1	2
SE175PFR-TR0	Black	1.75	44.5	1.25 – 2.75	31.8 – 69.9	200	61.0	1	2

### Tooling Head

- Sleeving cutter/end sealer blade – used with popular soldering guns to cut and seal sleeving



Part Number	Description	Std. Pkg. Qty.
HKBS	For dual straight shank soldering guns with .500" spacing typical guns: WELLER Straight Shank Model 8200; WEN Model 199 or 100 (Replace tip holding screws with (2) screws included).	1

## Fray Resistant Braided Expandable Sleeving

- Fray-resistant design resists fraying when cut with scissors
- Provides continuous abrasion protection resistance for wires, cables, and tubing
- For indoor use only
- Rated for use up to 257°F (125°C)
- Material: Polyethylene Terephthalate

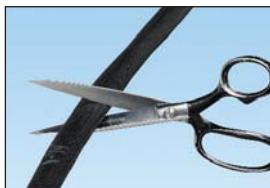

Part Number	Color	Nominal I.D.		Nominal Diameter Range		Length Per Reel‡		Std. Pkg. Qty.	Std. Ctn. Qty.
		In.	mm	In.	mm	Ft.	m		
SE12PSC-TR0	Black	0.12	3.2	0.13 – 0.25	3.2 – 6.4	200	61.0	1	4
SE25PSC-TR0	Black	0.25	6.4	0.16 – 0.44	4.0 – 11.1	200	61.0	1	4
SE38PSC-TR0	Black	0.38	9.5	0.19 – 0.63	4.8 – 15.9	200	61.0	1	4
SE50PSC-CR0	Black	0.50	12.7	0.25 – 0.75	6.4 – 19.1	100	30.5	1	4
SE75PSC-CR0	Black	0.75	19.1	0.63 – 1.0	15.9 – 25.4	100	30.5	1	4
SE125PSC-LR0	Black	1.25	31.8	1.0 – 1.5	25.4 – 38.1	50	15.2	1	4
SE150PSC-LR0	Black	1.50	38.1	1.3 – 2.0	31.8 – 50.8	50	15.2	1	4

‡Reel packaging may contain splices. Contact Panduit Customer Service for further information.

A.  
System  
Overview

B1.  
Cable Ties

B2.  
Cable  
Accessories

B3.  
Stainless  
Steel Ties

C1.  
Wiring  
Duct

C2.  
Surface  
Raceway

C3.  
Abrasion  
Protection

C4.  
Cable  
Management

D1.  
Terminals

D2.  
Power  
Connectors

D3.  
Grounding  
Connectors

E1.  
Labeling  
Systems

E2.  
Labels

E3.  
Pre-Printed  
& Write-On  
Markers

E4.  
Permanent  
Identification

E5.  
Lockout/  
Tagout/  
& Safety  
Solutions

F.  
Index

A. System Overview

## Part Number System for Non-Shrink PVC Tubing

**TV105**      **—**      **12**      **M**

B1. Cable Ties

Type

TV105 = PVC Tubing

Nominal Size

- 12 = 12 AWG
- 6 = 6 AWG
- 3 = 3 AWG
- 1 = 1 AWG
- 0.38 = 3/8"
- 0.50 = 1/2"
- 0.75 = 3/4"
- 1.0 = 1"

Package Quantity

- C = 100' (30.5m)
- TL = 250' (76.2m)
- D = 500' (152.4m)
- M = 1000' (304.8m)

Color Suffix

- Leave Blank = Clear
- 20 = Black

B2. Cable Accessories

B3. Stainless Steel Ties

C1. Wiring Duct

## Non-Shrink PVC Tubing

- Provides insulation and protection for lead wires, wire harness assemblies, soldered joints and components in electrical and electronic equipment

- All purpose flexible and non-shrinkable
- Resistant to heat and moisture
- Flammability: Meets UL 224 VW-1

- Voltage rating: 300 V and 600 V

- ASTM D-922 Grade CFR
- MIL-I-631 Type F, Form U, Grade C- Class 1 Category 1
- Material: Polyvinyl chloride (PVC)
- UL oil resistant class 1 rating
- Continuous use temperature range: -4°F – 221°F (-20°C – 105°C)

C2. Surface Raceway

C3. Abrasion Protection



C4. Cable Management

D1. Terminals

D2. Power Connectors

D3. Grounding Connectors

E1. Labeling Systems

E2. Labels

E3. Pre-Printed & Write-On Markers

E4. Permanent Identification

E5. Lockout/Tagout & Safety Solutions

F. Index

Part Number	Color	Nominal Size	Length Per Reel		Max. Inside Diameter		Wall Thickness		Max. Voltage Rating	Std. Pkg. Qty.	Std. Ctn. Qty.
			Ft.	m	In	mm	In	mm			
TV105-12MY	Clear	12 AWG	1000	304.8	0.089	2.26	0.016	0.41	300 V	1	2
TV105-12M20Y	Black	12 AWG	1000	304.8	0.089	2.26	0.016	0.41	300 V	1	2
TV105-6MY	Clear	6 AWG	1000	304.8	0.178	4.52	0.020	0.51	300 V	1	2
TV105-6M20Y	Black	6 AWG	1000	304.8	0.178	4.52	0.020	0.51	300 V	1	2
TV105-3MY	Clear	3 AWG	1000	304.8	0.249	6.32	0.020	0.51	300 V	1	2
TV105-3M20Y	Black	3 AWG	1000	304.8	0.249	6.32	0.020	0.51	300 V	1	2
TV105-1MY	Clear	1 AWG	1000	304.8	0.311	7.89	0.020	0.51	300 V	1	—
TV105-1M20Y	Black	1 AWG	1000	304.8	0.311	7.89	0.020	0.51	300 V	1	—
TV105-.38DY	Clear	3/8	500	152.4	0.399	10.13	0.025	0.64	600 V	1	—
TV105-.38D20Y	Black	3/8	500	152.4	0.399	10.13	0.025	0.64	600 V	1	—
TV105-.50DY	Clear	1/2	500	152.4	0.524	13.30	0.025	0.64	600 V	1	—
TV105-.50D20Y	Black	1/2	500	152.4	0.524	13.30	0.025	0.64	600 V	1	—
TV105-.75TLY	Clear	3/4	250	76.2	0.786	19.96	0.035	0.89	600 V	1	—
TV105-.75TL20Y	Black	3/4	250	76.2	0.786	19.96	0.035	0.89	600 V	1	—
TV105-1.0CY	Clear	1	100	30.5	1.036	26.31	0.035	0.89	600 V	1	2
TV105-1.0C20Y	Black	1	100	30.5	1.036	26.31	0.035	0.89	600 V	1	2

## Duct Seal – Sealing Compounds

- Seals irregular openings from air, dust, or water
- Non-hardening sealant that adheres to metal, masonry, wood or plastic
- Provides vibration dampening

- Safe and easy to use, non-corrosive, non-toxic, no asbestos, will not stain or harm hands, and no unpleasant odor.
- Dielectric strength: 200 V/Mil, Min .030" thick



Part Number	Description	Std. Pkg. Qty.
DS1	Duct seal (sealing compound) 1 lb. package	1
DS5	Duct seal (sealing compound) 5 lb. package	1



## Flammability Tests and Classification

### Abrasion Protection Products Flammability Tests and Classifications



- A number of test procedures have been developed which can be used for the evaluation and comparison of various materials to support combustion
- Review the following classifications to find which category is designed to suit your abrasion and protection applications

### UL 94 Vertical Burning Test

Test samples of material, with dimension  $125 \pm 5\text{mm}$  by  $13.0 \pm 5\text{mm}$  and provided in the minimum and maximum thickness of the intended end use product, are tested in an unconditioned (as manufactured) state and in a conditioned state (7 days at  $168\text{F}^\circ$ ,  $75^\circ\text{C}$ ). The test requires the placement of a precisely controlled flame under a vertically supported specimen for a 10 second period. The flame is removed and the duration of flaming is recorded. If the flame extinguishes, the specimen is immediately subjected to a second 10 second ignition period. Duration of flaming is again recorded. A piece of 100% cotton is placed under the specimen. Also observed and documented is if the sample drips flaming particles that ignite the cotton indicator below.

#### Materials Classification

Criteria Conditions	V-0	V-1	V-2
Afterflame time for each individual specimen $t_1$ or $t_2$	$\leq 10\text{s}$	$\leq 30\text{s}$	$\leq 30\text{s}$
Total Afterflame time for any condition set ( $t_1$ plus $t_2$ for the 5 specimens)	$\leq 50\text{s}$	$\leq 250\text{s}$	$\leq 250\text{s}$
Afterflame plus afterglow time for each individual specimen after the second flame application ( $t_2 + t_3$ )	$\leq 30\text{s}$	$\leq 60\text{s}$	$\leq 60\text{s}$
Afterflame or afterglow of any specimen up to the holding clamp	No	No	No
Cotton indicator ignited by flaming particles or drops	No	No	Yes

$t_1$	Afterflame time after first flame application
$t_2$	Afterflame time after second flame application
$t_3$	Afterglow time after second flame application

### MATERIALS CLASSIFIED UL 94 HB

- Specimens shall have a maximum burn rate of  $<1.5$  in./min over 3 inches of thickness of .120 inches to .5 inches
- Specimens shall have a maximum burn rate of  $<30$  in./min over 3 inches for a thickness less than .120 inches

### UL 224 VERTICAL WIRE FLAME TEST

Samples of fully recovered tubing are placed over a length of fine spring steel music wire. The test requires the precise placement of a controlled flame that contacts the heat shrink tubing. The flame is applied in five 15 second intervals with a time period between applications. If the flame extinguishes immediately after the first flame removal, subsequent flame applications are made to the tubing. Duration of specimen flaming is noted. A piece of surgical cotton is placed under the specimen. If a flaming or glowing piece of tubing drips and ignites the cotton, this is also noted.

### MATERIALS CLASSIFIED AS VW-1 SHALL:

- Not flame or glow longer than 60 seconds following any of the five applications of the flame
- Not ignite or damage more than 25% of kraft paper flag that is placed around the top of the tubing
- Not have any specimens which drip flaming particles and ignite the surgical cotton located 9 1/2 inches below the test specimen

A.  
System  
Overview

B1.  
Cable Ties

B2.  
Cable  
Accessories

B3.  
Stainless  
Steel Ties

C1.  
Wiring  
Duct

C2.  
Surface  
Raceway

C3.  
Abrasion  
Protection

C4.  
Cable  
Management

D1.  
Terminals

D2.  
Power  
Connectors

D3.  
Grounding  
Connectors

E1.  
Labeling  
Systems

E2.  
Labels

E3.  
Pre-Printed  
& Write-On  
Markers

E4.  
Permanent  
Identification

E5.  
Lockout/  
Tagout  
& Safety  
Solutions

F.  
Index

A. System Overview

B1. Cable Ties

B2. Cable Accessories

B3. Stainless Steel Ties

C1. Wiring Duct

C2. Surface Raceway

C3. Abrasion Protection

C4. Cable Management

D1. Terminals

D2. Power Connectors

D3. Grounding Connectors

E1. Labeling Systems

E2. Labels

E3. Pre-Printed & Write-On Markers

E4. Permanent Identification

E5. Lockout/Tagout & Safety Solutions

F. Index

## Abrasion Protection Materials Technical Data

	Ratings and Approvals			Physical Properties				Chemical Resistance			
	UL Temperature Index	Flammability (UL 94)	Melting Temperature	Abrasion Resistance (Lower number is better)	Specific Gravity (D792)	Minimum Tensile @23°C (psi) (D368)	Water Absorption (Max. 24 hrs.)	Organic Solvents	Alkalies	Acids	Petro-Chemicals
<b>Natural Polyethylene</b> Lowest cost material for indoor use up to 122°F. Natural is available in all sizes.	-40°F (-40°C) to 122°F (50°C)	HB	239°F (115°C)	22 mg	0.91 – 0.93	1400 (D368)	0.01%	Resistant below 140°F (60°C) except to chlorinated solvents	Resistant	Resistant except to oxidizing acids	Some Discoloration
<b>Weather Resistant Polyethylene</b> This material has the same properties as natural polyethylene, and also has additives which allow it to resist the effects of ultraviolet light and acid rain in an outdoor environment. This product is available in black only.	-40°F (-40°C) to 122°F (50°C)	HB	239°F (115°C)	20 mg	0.93 – 1.09	2000 (D368)	0.03%	Resistant below 140°F (60°C) except to chlorinated solvents	Resistant	Resistant except to oxidizing acids	No Discoloration
<b>Fire Resistant Polyethylene*</b> UL94-V-2 Rating This material is self extinguishing and passes the UL 94 flame retardant test with V-2 rating.	-40°F (-40°C) to 122°F (50°C)	V-2	239°F (115°C)	27 mg	1.00 – 1.30	1400 (D368)	0.02%	Resistant below 140°F (60°C) except to chlorinated solvents	Resistant	Resistant except to oxidizing acids	Some Discoloration
<b>Flame Retardant Polyethylene*</b> UL94-V-0 Rating. This material is self extinguishing and passes the UL94 flame retardant test with a V-0 rating.	-4°F (-20°C) to 167°F (75°C)	V-0	270°F (132°C)	22 mg	1.23 – 1.37	1500 (D368)	0.02%	Resistant except to halogenated hydrocarbons	Resistant	Resistant	Resistant Some Discoloration
<b>Weather Resistant Polypropylene</b> This material is resistant to chemical attack and is suitable for harsh environment applications requiring UV/weather resistance and withstanding high temperatures.	-40°F (-40°C) to 239°F (115°C)	HB	334°F (168°C)	—	0.902	4000 (D638)	0.1%	Resistant except to halogenated hydrocarbons	Resistant	Resistant	Resistant No Discoloration
<b>Nylon 6.6</b> Nylon is strong, durable material for indoor use up to 149°F. It offers a combination of lightweight, wide temperature range, and high abrasion resistance. This material is suitable for applications where heavy vibration or stress exists on the wiring or tubing.	-40°F (-40°C) to 149°F (65°C)	HB	505°F (263°C)	7 mg	1.13 – 1.15	12,400 (D368)	1.2%	Resistant except to halogenated hydrocarbons	Resistant	Not recommended	Resistant No Discoloration
<b>Weather Resistant Nylon 6.6</b> This material has the same properties as natural Nylon and also has additives which allow it to resist the effects of ultraviolet light in an outdoor environment. This product is available in black only.	-40°F (-40°C) to 149°F (65°C)	HB	505°F (263°C)	7 mg	1.13 – 1.15	12,400 (D368)	1.2%	Resistant except to halogenated hydrocarbons	Resistant	Not recommended	Resistant No Discoloration
<b>TFE†</b> This material is a non-flammable, fluorocarbon resin material. Highly resistant to most chemicals, high resistance to UV exposure, wide operating temperature range, can be used in cryogenic applications. Color: Opaque to Translucent.	-454°F (-270°C) to 500°F (260°C)	V-0	648°F (342°C)	7 mg	2.13 – 2.22	3000 (D876)	0.01%	Resistant	Resistant	Resistant	Resistant No Discoloration
<b>Natural Polyethylene</b> Lowest cost material for indoor use up to 122°C. Natural is available in all sizes.	-40°F (-40°C) to 122°F (50°C)	HB	239°F (115°C)	22 mg	0.91 – 0.93	1400 (D638)	0.01%	Resistant below 140°F (60°C) except to chlorinated solvents	Resistant	Resistant except to oxidizing acids	Some Discoloration
<b>Flame Retardant Polyethylene*</b> UL94-V-0 Rating. This material is self extinguishing and passes the UL94 flame retardant test with a V-0 rating.	-4°F (-20°C) to 167°F (75°C)	V-0	270°F (132°C)	22 mg	1.15	1500 (D876)	0.02%	Resistant except to halogenated hydrocarbons	Resistant	Resistant	Resistant Some Discoloration

SPIRAL WRAP

PAN-WRAP™

Note: Typical operating temperature ranges are extended based on end use application and specific environment tests.

†TFE is Polytetrafluoroethylene material.

\*Contains halogens. Other materials are halogen free.

## Abrasion Protection Materials Technical Data (continued)

	Ratings and Approvals			Physical Properties				Chemical Resistance			
	UL Temperature Index	Flammability (UL 94)	Melting Temperature	Abrasion Resistance (Lower number is better)	Specific Gravity (D792)	Minimum Tensile @ 23°C (psi)	Water Absorption (Max. 24 hrs.)	Organic Solvents	Alkalies	Acids	Petro-Chemicals
<b>SLEEVING</b>	<b>Polyethylene Terephthalate (PET)</b> This material is a thermoplastic polyester material designed for indoor applications. It is rated for use up to 257°F and will tolerate short-term exposure up to 446°F. Colors: Black, White and Gray.	HB	500°F (260°C)	—	1.39	100,000 (D876)	0.08%	Resistant to some solvents	Resistant to most weak bases	Resistant	Some Discoloration
	<b>Flame Retardant Polyethylene* Terephthalate (PET)</b> This material is a self-extinguishing thermoplastic polyester that can be used indoors. It is also rated for use up to 257°F and will tolerate short term exposure up to 446°F. It is provided with tracers to identify the flame retardant material.	UL 1441 VW-1	469°F (243°C)	—	1.39	39,295 (D876)	0.08%	Resistant to some solvents	Resistant to most weak bases	Resistant	Resistant Some Discoloration
<b>CLT</b>	<b>Black Polypropylene</b> Lowest cost material is for use up to 122°F. Other colors may be available.	HB	—	—	0.926 – 0.940	1500 (D638)	—	Resistant except to halogenated hydrocarbons	Resistant	Resistant	Resistant No Discoloration
	<b>Nylon 6</b> Nylon is a strong, impact modified, heat stabilized, durable high abrasion resistant material.	HB	410°F (211°C)	—	1.06 – 1.16	8000 (D638)	—	Resistant except to halogenated hydrocarbons	Resistant	Not recommended	Resistant No Discoloration
<b>PVC</b>	<b>PVC Non-Shrink Tubing*</b> This material provides insulation and protection for continuous use at temperature -4°F (-20°C) to 221°F (105°C).	UL 224 VW-1	—	—	1.35	2500 (D876)	—	Resistant except to aromatic hydrocarbons, ketones and esters	Resistant	Resistant	Resistant No Discoloration
<b>CLT FITTINGS</b>	<b>Black Polyethylene</b> Lowest cost material is for use up to 122°F. Other colors may be available.	UL94 HB	—	—	1.04	3,900 (D638)	0.02 – 0.03%	Resistant except to halogenated hydrocarbons	Resistant	Resistant except to oxidizing acids	Resistant Some Discoloration
	<b>Natural Polyethylene</b> Lowest cost material for indoor use up to 122° F. Natural is available in all sizes.	HB	239°F (115°C)	22 mg	0.91 – 1.09	1400 (D638)	—	Resistant below 140°F (60°C) except to chlorinated solvents	Resistant	Resistant except to oxidizing acids	Some Discoloration
<b>GROMMET EDGING</b>	<b>Weather Resistant Polyethylene</b> This material has the same properties as natural polyethylene, and also has additives which allow it to resist the effects of ultraviolet light and acid rain in an outdoor environment. This product is available in black only.	HB	239°F (115°C)	20 mg	0.93 – 1.09	2000 (D638)	0.03%	Resistant below 140°F (60°C) except to chlorinated solvents	Resistant	Resistant except to oxidizing acids	No Discoloration
	<b>Flame Retardant Polyethylene*</b> UL94-V-0 Rating This material is self-extinguishing and passes the UL94 flame retardant test with a V-0 rating.	V-0	270°F (132°C)	22 mg	1.23 – 1.37	1200	0.02%	Resistant below 194°F (90°C) except to chlorinated solvents	Resistant	Resistant except to oxidizing acids	Some Discoloration
	<b>Nylon</b> Nylon is strong, durable, self-extinguishing material for indoor use up to 149°F. It offers a combination of lightweight, wide temperature range, and high abrasion resistance. This material is suitable for applications where heavy vibration or stress exists on the wiring or tubing.	V-2	491°F (255°C)	7 mg	1.03 – 1.15	12,400 (D638)	1.5%	Resistant except to phenols and formic acid	Resistant	Resistant to most weak acids	No Discoloration

Note: Typical operating temperature ranges are extended based on end use application and specific environment tests.

\*Contains halogens. Other materials are halogen free.

A. System Overview

B1. Cable Ties

B2. Cable Accessories

B3. Stainless Steel Ties

C1. Wiring Duct

C2. Surface Raceway

C3. Abrasion Protection

C4. Cable Management

D1. Terminals

D2. Power Connectors

D3. Grounding Connectors

E1. Labeling Systems

E2. Labels

E3. Pre-Printed & Write-On Markers

E4. Permanent Identification

E5. Lockout/Tagout & Safety Solutions

F. Index

A. System Overview

## Panduit Heat Shrink Tubing Heat Shrink Tubing Quick Selection Guide

B1. Cable Ties

Quick reference for Panduit Heat Shrink for specific location applications

B2. Cable Accessories

B3. Stainless Steel Ties

C1. Wiring Duct

C2. Surface Raceway

C3. Abrasion Protection

C4. Cable Management

D1. Terminals

D2. Power Connectors

D3. Grounding Connectors

E1. Labeling Systems

E2. Labels

E3. Pre-Printed & Write-On Markers

E4. Permanent Identification

E5. Lockout/Tagout & Safety Solutions

F. Index



**CHARACTERISTICS**

	HSTT	HSTTV	HSTTN	HSTTK	HSTTT	HSTTP	HSTTPN	HSTTV A	HSTTR A	HSTTA	HSTTA A	HST	HSEC	HSECFR
U.L. Listed												X		
UL Recognized	X‡	X		X		X	X				X	X		X
CSA Certified	X‡	X		X		X	X					X		
VW-1-Rated		X		X		X	X	X^	X^	X^	X^	X		
Very Flexible		X	X											
Flexible	X					X	X	X		X				
Semi-Rigid				X	X		X		X				X	
Thin Wall	X	X	X	X	X	X	X	X	X	X	X			
Thick Wall												X	X	X
Cross-Linked Material	X	X	X	X		X		X	X	X	X	X	X	X
Colors Available	X	X										X*		
Shrink Ratio	2:1	2:1	2:1	2:1	2:1	2:1	2:1	2:1	2.5:1 min.	3:1	4:1	3:1	2.5:1	3:1
Flame Retardant	X‡	X	X	X	X	X	X	X	X	X	X	X		X
Adhesive Lined (Dual Wall)								X	X	X	X	X	X	X
Meets Military Specifications	X■	X■	X	X■	X		X	X■	X■	X■	X■	X		
Below Ground Application												X		
High Temp Applications (>250°F)				X	X									
Highly Chemical Resistant			X	X	X									
Low Coefficient of Friction					X									
Custom Cut Lengths	X	X	X	X	X	X		X	X	X		X		
Standard 6" pieces	X	X						X		X				
Standard 4' lengths	X	X		X	X			X	X	X	X	X		
Small 25' Reels	X	X	X			X								
Large Reels	X	X	X			X	X							
UV Resistant	X#	X#	X#	X	X	X#		X#	X#	X#	X#	X#	X#	X#
Shrink Temperature	194°F	194°F	275°F	275°F	644°F	212°F	212°F	248°F	257°F	248°F	248°F	248°F	248°F	248°F
Shelf Life (years)	5	5	5**	5	4	1	1	5	5	5	5	10	5	5
Found on Page...	C3.24–C3.27	C3.28–C3.31	C3.33	C3.35	C3.34	C3.32	C3.33	C3.35–C3.36	C3.37	C3.36	C3.37	C3.38	C3.39	C3.39

\*Black/Red  
 \*\*Excluding HSTTN300 which is 2 years.  
 ‡Except Clear  
 ^Outer Wall  
 ■Material Performance only  
 #Black only

## Part Number System for Thin Wall Heat Shrink

### HSTT

Type	Expanded Diameter	Tube Length	Package Quantity	Color
HSTT = Thin Wall	05 = 3/64" (1.2mm)	3 = 3" (76.2mm)	(If Tube Length Specified)	NONE = Black
HSTTV = Thin Wall VW-1	06 = 1/16" (1.6mm)	6 = 6" (152.4mm)	1 = 1 pc.	C = Clear
HSTTN = Thin Wall Neoprene	09 = 3/32" (2.4mm)	9 = 9" (228.6mm)	2 = 2 Pcs.	2 = Red
HSTTK = Thin Wall PVDF KYNAR ▲	12 = 1/8" (3.2mm)	12 = 12" (304.8mm)	3 = 3 Pcs.	4 = Yellow
HSTTT = Thin Wall TFE ‡	19 = 3/16" (4.8mm)	48 = 48" (1.2m)	5 = 5 Pcs.	5 = Green
HSTTP = Thin Wall PVC	25 = 1/4" (6.4mm)	NONE = REEL	X = 10 Pcs.	6 = Blue
HSTTPN = Crystal Clear Thin Wall PVC	38 = 3/8" (9.5mm)		Q = 25 Pcs.	10 = White
HSTTVA = Flexible Adhesive Lined	50 = 1/2" (12.7mm)		LQ = 75 Pcs.	45 = Yellow/ Green
HSTTRA = Semi-Rigid Adhesive Lined	75 = 3/4" (19.1mm)		CQ = 125 Pcs.	
HSTTA = Thin Wall Adhesive Lined	100 = 1" (25.4mm)		T = 200 Pcs.	
HSTT4A = 4:1 Thin Wall Adhesive Lined	150 = 1 1/2" (38.1mm)		TL = 250 Pcs.	
HST = Thick Wall Adhesive Lined	200 = 2" (50.8mm)		Y = 6" Pcs.	
HSEC = Heat Shrink End Caps Adhesive Lined	300 = 3" (76.2mm)			
HSECFR = Heat Shrink End Caps Flame Retardant Adhesive Lined	400 = 4" (101.6mm)			
	0.4 = .40" (10.2mm)		<b>Reels</b> (If No Tube Length Specified)	
	0.5 = .47" (11.9mm)		Q = 25' (7.6m)	
	0.8 = .80" (20.3mm)		L = 50' (15.2m)	
	1.0 = 1.0" (25.4mm)		C = 100' (30.5m)	
	1.1 = 1.1" (27.9mm)		T = 200' (61.0m)	
	1.5 = 1.5" (38.1mm)		D = 500' (152.4m)	
	2.0 = 2.0" (50.8mm)		M = 1000' (304.8m)	
	3.0 = 3.0" (76.2mm)			
	4.0 = 4.0" (101.6mm)			

For Standard Packages containing 6" (152.4mm) lengths, refer to individual pages for complete part number offering.

Note: The above information is to be used as a guide. For specific part number offerings review individual pages for verification.

▲KYNAR is a registered trademark of Atofina Chemicals, Inc.

‡TFE is Polytetrafluoroethylene material.

- A. System Overview
- B1. Cable Ties
- B2. Cable Accessories
- B3. Stainless Steel Ties
- C1. Wiring Duct
- C2. Surface Raceway
- C3. Abrasion Protection
- C4. Cable Management
- D1. Terminals
- D2. Power Connectors
- D3. Grounding Connectors
- E1. Labeling Systems
- E2. Labels
- E3. Pre-Printed & Write-On Markers
- E4. Permanent Identification
- E5. Lockout/Tagout & Safety Solutions
- F. Index

A.  
System  
Overview

## HSTT Heat Shrink 4 Foot Pieces and Reels

B1.  
Cable Ties

- Applications include insulating, protecting, and color coding wires and cables

- UL Recognized, CSA Certified

- Voltage: 600 V

- Mil Spec: AMS-DTL-23053/5 Class 1 (Colors) Class 2 (Clear)

- Shrink ratio: 2:1

- Temperature range: -67°F to 275°F (-55°C to 135°C)

- Flammability: Flame retardant EXCEPT clear

- For dry locations

- Material: Black cross-linked Polyolefin

B2.  
Cable  
Accessories

B3.  
Stainless  
Steel Ties



C1.  
Wiring  
Duct



C2.  
Surface  
Raceway

C3.  
Abrasion  
Protection

C4.  
Cable  
Management

D1.  
Terminals

D2.  
Power  
Connectors

D3.  
Grounding  
Connectors

E1.  
Labeling  
Systems

E2.  
Labels

E3.  
Pre-Printed  
& Write-On  
Markers

E4.  
Permanent  
Identification

E5.  
Lockout/  
Tagout  
& Safety  
Solutions

F.  
Index

Part Number*	Nominal Diameter		Min. Expanded I.D.		Max. Recovered I.D.		Nominal Recovered Wall Thickness		Length		Length per Reel		Std. Pkg. Qty.	Std Ctn. Qty.
	In.	mm	In.	mm	In.	mm	In.	mm	Ft.	m	Ft.	m		
HSTT05-48-Q	0.046	1.2	0.046	1.2	0.023	0.6	0.016	0.4	4	1.2	—	—	25	—
HSTT05-48-TL	0.046	1.2	0.046	1.2	0.023	0.6	0.016	0.4	4	1.2	—	—	250	—
HSTT05-C‡	0.046	1.2	0.046	1.2	0.023	0.6	0.016	0.4	—	—	100	30.5	1	10
HSTT05-M‡	0.046	1.2	0.046	1.2	0.023	0.6	0.016	0.4	—	—	1000	304.8	1	2
HSTT06-48-Q	0.063	1.6	0.063	1.6	0.031	0.8	0.017	0.4	4	1.2	—	—	25	—
HSTT06-48-TL	0.063	1.6	0.063	1.6	0.031	0.8	0.017	0.4	4	1.2	—	—	250	—
HSTT06-C‡	0.063	1.6	0.063	1.6	0.031	0.8	0.017	0.4	—	—	100	30.5	1	10
HSTT06-M‡	0.063	1.6	0.063	1.6	0.031	0.8	0.017	0.4	—	—	1000	304.8	1	2
HSTT09-48-Q	0.093	2.4	0.093	2.4	0.046	1.2	0.020	0.5	4	1.2	—	—	25	—
HSTT09-48-TL	0.093	2.4	0.093	2.4	0.046	1.2	0.020	0.5	4	1.2	—	—	250	—
HSTT09-C‡	0.093	2.4	0.093	2.4	0.046	1.2	0.020	0.5	—	—	100	30.5	1	10
HSTT09-M‡	0.093	2.4	0.093	2.4	0.046	1.2	0.020	0.5	—	—	1000	304.8	1	2
HSTT12-48-Q	0.125	3.2	0.125	3.2	0.062	1.6	0.020	0.5	4	1.2	—	—	25	—
HSTT12-48-TL	0.125	3.2	0.125	3.2	0.062	1.6	0.020	0.5	4	1.2	—	—	250	—
HSTT12-C‡	0.125	3.2	0.125	3.2	0.062	1.6	0.020	0.5	—	—	100	30.5	1	10
HSTT12-M‡	0.125	3.2	0.125	3.2	0.062	1.6	0.020	0.5	—	—	1000	304.8	1	2
HSTT19-48-Q	0.187	4.8	0.187	4.8	0.093	2.4	0.020	0.5	4	1.2	—	—	25	—
HSTT19-48-TL	0.187	4.8	0.187	4.8	0.093	2.4	0.020	0.5	4	1.2	—	—	250	—
HSTT19-C‡	0.187	4.8	0.187	4.8	0.093	2.4	0.020	0.5	—	—	100	30.5	1	10
HSTT19-M‡	0.187	4.8	0.187	4.8	0.093	2.4	0.020	0.5	—	—	1000	304.8	1	2
HSTT25-48-Q	0.250	6.4	0.250	6.4	0.125	3.2	0.025	0.6	4	1.2	—	—	25	—
HSTT25-48-TL	0.250	6.4	0.250	6.4	0.125	3.2	0.025	0.6	4	1.2	—	—	250	—
HSTT25-C‡	0.250	6.4	0.250	6.4	0.125	3.2	0.025	0.6	—	—	100	30.5	1	10
HSTT25-D‡	0.250	6.4	0.250	6.4	0.125	3.2	0.025	0.6	—	—	500	152.4	1	2
HSTT38-48-Q	0.375	9.5	0.375	9.5	0.187	4.8	0.025	0.6	4	1.2	—	—	25	—
HSTT38-48-TL	0.375	9.5	0.375	9.5	0.187	4.8	0.025	0.6	4	1.2	—	—	250	—
HSTT38-C‡	0.375	9.5	0.375	9.5	0.187	4.8	0.025	0.6	—	—	100	30.5	1	10
HSTT38-T‡	0.375	9.5	0.375	9.5	0.187	4.8	0.025	0.6	—	—	200	61.0	1	2

\*For colors, add C (Clear), 2 (Red), 4 (Yellow), 45 (Yellow/Green), 5 (Green), 6 (Blue) and 10 (White) to end of part number.

‡Part sold per reel

## RA® SP® HSTT Heat Shrink 4 Foot Pieces and Reels (continued)



Part Number*	Nominal Diameter		Min. Expanded I.D.		Max. Recovered I.D.		Nominal Recovered Wall Thickness		Length		Length per Reel		Std. Pkg. Qty.	Std. Ctn. Qty.
	In.	mm	In.	mm	In.	mm	In.	mm	Ft.	m	Ft.	m		
HSTT50-48-5	0.500	12.7	0.500	12.7	0.250	6.4	0.025	0.6	4	1.2	—	—	5	—
HSTT50-48-Q	0.500	12.7	0.500	12.7	0.250	6.4	0.025	0.6	4	1.2	—	—	25	—
HSTT50-48-T	0.500	12.7	0.500	12.7	0.250	6.4	0.025	0.6	4	1.2	—	—	200	—
HSTT50-C‡	0.500	12.7	0.500	12.7	0.250	6.4	0.025	0.6	—	—	100	30.5	1	10
HSTT50-T‡	0.500	12.7	0.500	12.7	0.250	6.4	0.025	0.6	—	—	200	61.0	1	2
HSTT75-48-5	0.750	19.1	0.750	19.1	0.375	9.5	0.030	0.8	4	1.2	—	—	5	—
HSTT75-48-CQ	0.750	19.1	0.750	19.1	0.375	9.5	0.030	0.8	4	1.2	—	—	125	—
HSTT75-C‡	0.750	19.1	0.750	19.1	0.375	9.5	0.030	0.8	—	—	100	30.5	1	10
HSTT75-T‡	0.750	19.1	0.750	19.1	0.375	9.5	0.030	0.8	—	—	200	61.0	1	2
HSTT100-48-5	1.00	25.4	1.00	25.4	0.500	12.7	0.035	0.9	4	1.2	—	—	5	—
HSTT100-48-LQ	1.00	25.4	1.00	25.4	0.500	12.7	0.035	0.9	4	1.2	—	—	75	—
HSTT100-C‡	1.00	25.4	1.00	25.4	0.500	12.7	0.035	0.9	—	—	100	30.5	1	2
HSTT150-48-5	1.50	38.1	1.50	38.1	0.750	19.1	0.040	1.0	4	1.2	—	—	5	—
HSTT150-C‡	1.50	38.1	1.50	38.1	0.750	19.1	0.040	1.0	—	—	100	30.5	1	2
HSTT200-48-5	2.00	50.8	2.00	50.8	1.00	25.4	0.045	1.1	4	1.2	—	—	5	—
HSTT200-L‡	2.00	50.8	2.00	50.8	1.00	25.4	0.045	1.1	—	—	50	15.2	1	2
HSTT300-48-2	3.00	76.2	3.00	76.2	1.50	38.1	0.050	1.3	4	1.2	—	—	2	—
HSTT300-L‡	3.00	76.2	3.00	76.2	1.50	38.1	0.050	1.3	—	—	50	15.2	1	0
HSTT400-48-2	4.00	101.6	4.00	101.6	2.00	50.8	0.055	1.4	4	1.2	—	—	2	—
HSTT400-L‡	4.00	101.6	4.00	101.6	2.00	50.8	0.055	1.4	—	—	50	15.2	1	0

\*For colors, add C (Clear), 2 (Red), 4 (Yellow), 45 (Yellow/Green), 5 (Green), 6 (Blue) and 10 (White) to end of part number.

‡Part sold per reel

## RA® SP® HSTT Heat Shrink on 25 Foot Reels

- Applications include insulating and protecting wires and cables
- Voltage: 600 V
- Shrink ratio: 2:1
- Flammability: Flame retardant EXCEPT clear
- UL Recognized, CSA Certified
- Mil Spec: AMS-DTL-23053/5 Class 1 (Black) Class 2 (Clear)
- Temperature range: -67°F to 275°F (-55°C to 135°C)
- For dry locations
- Material: Cross-linked Polyolefin



Part Number*	Nominal Diameter		Min. Expanded I.D.		Max. Recovered I.D.		Nominal Recovered Wall Thickness		Std. Pkg. Qty.	Std. Ctn. Qty.
	In.	mm	In.	mm	In.	mm	In.	mm		
HSTT05-Q	0.046	1.2	0.046	1.2	0.023	0.6	0.016	0.4	1	10
HSTT06-Q	0.063	1.6	0.063	1.6	0.031	0.8	0.017	0.4	1	10
HSTT09-Q	0.093	2.4	0.093	2.4	0.046	1.2	0.020	0.5	1	10
HSTT12-Q	0.125	3.2	0.125	3.2	0.062	1.6	0.020	0.5	1	10
HSTT19-Q	0.187	4.8	0.187	4.8	0.093	2.4	0.020	0.5	1	10
HSTT25-Q	0.250	6.4	0.250	6.4	0.125	3.2	0.025	0.6	1	10
HSTT38-Q	0.375	9.5	0.375	9.5	0.187	4.8	0.025	0.6	1	10
HSTT50-Q	0.500	12.7	0.500	12.7	0.250	6.4	0.025	0.6	1	10
HSTT75-Q	0.750	19.1	0.750	19.1	0.375	9.5	0.030	0.8	1	10

\* For clear, add C to end of part number.

A.  
System  
Overview

B1.  
Cable  
Ties

B2.  
Cable  
Accessories

B3.  
Stainless  
Steel Ties

C1.  
Wiring  
Duct

C2.  
Surface  
Raceway

C3.  
Abrasion  
Protection

C4.  
Cable  
Management

D1.  
Terminals

D2.  
Power  
Connectors

D3.  
Grounding  
Connectors

E1.  
Labeling  
Systems

E2.  
Labels

E3.  
Pre-Printed  
& Write-On  
Markers

E4.  
Permanent  
Identification

E5.  
Lockout/  
Tagout  
& Safety  
Solutions

F.  
Index

A. System Overview

## Heat Shrink in 6 Inch Pieces; Black, Single Diameter

- Applications include insulating, protecting, and color coding wires and cables
- Voltage: 600 V
- Shrink ratio: 2:1
- Flammability: Flame retardant
- UL Recognized, CSA Certified
- Mil Spec: AMS-DTL-23053/5 Class 1
- Temperature range: -67°F to 275°F (-55°C to 135°C)
- For dry locations
- Material: Cross-linked Polyolefin



B1. Cable Ties

B2. Cable Accessories

B3. Stainless Steel Ties



Part Number	Nominal Diameter		Min. Expanded I.D.		Max. Recovered I.D.		Nominal Recovered Wall Thickness		Total No. Pcs.	Std. Pkg. Qty.	Std. Ctn. Qty.
	In.	mm	In.	mm	In.	mm	In.	mm			
HSTT06-Y	0.063	1.6	0.063	1.6	0.031	0.8	0.017	0.4	26	1	10
HSTT09-Y	0.093	2.4	0.093	2.4	0.046	1.2	0.020	0.5	24	1	10
HSTT12-Y	0.125	3.2	0.125	3.2	0.062	1.6	0.020	0.5	20	1	10
HSTT19-Y	0.187	4.8	0.187	4.8	0.093	2.4	0.020	0.5	18	1	10
HSTT25-Y	0.250	6.4	0.250	6.4	0.125	3.2	0.025	0.6	14	1	10
HSTT38-Y	0.375	9.5	0.375	9.5	0.187	4.8	0.025	0.6	12	1	10
HSTT50-Y	0.500	12.7	0.500	12.7	0.250	6.4	0.025	0.6	10	1	10
HSTT75-Y	0.750	19.1	0.750	19.1	0.375	9.5	0.030	0.8	8	1	10
HSTT100-Y	1.00	25.4	1.00	25.4	0.500	12.7	0.035	0.9	6	1	10

C1. Wiring Duct

C2. Surface Raceway

C3. Abrasion Protection

C4. Cable Management

D1. Terminals

## Heat Shrink in 6 Inch Pieces; Multi-Color, Single Diameter

- Applications include insulating, protecting, and color coding wires and cables
- Voltage: 600 V
- Shrink ratio: 2:1
- Flammability: Flame retardant EXCEPT clear
- UL Recognized, CSA Certified
- Mil Spec: AMS-DTL-23053/5 Class 1 (Colors) Class 2 (Clear)
- Temperature range: -67°F to 275°F (-55°C to 135°C)
- For dry locations
- Material: Cross-linked Polyolefin
- Colors include: clear, red, yellow, green, blue and white



E1. Labeling Systems



E2. Labels

E3. Pre-Printed & Write-On Markers

E4. Permanent Identification

E5. Lockout/Tagout & Safety Solutions

F. Index

Part Number	Nominal Diameter		Min. Expanded I.D.		Max. Recovered I.D.		Total No. Pcs.	Black No. of Pieces	Each Color No. of Pieces	Std. Pkg. Qty.	Std. Ctn. Qty.
	In.	mm	In.	mm	In.	mm					
HSTT06-YK1	0.063	1.6	0.063	1.6	0.031	0.8	26	8	3	1	10
HSTT09-YK1	0.093	2.4	0.093	2.4	0.046	1.2	24	6	3	1	10
HSTT12-YK1	0.125	3.2	0.125	3.2	0.062	1.6	20	2	3	1	10
HSTT19-YK1	0.187	4.8	0.187	4.8	0.093	2.4	18	6	2	1	10
HSTT25-YK1	0.250	6.4	0.250	6.4	0.125	3.2	14	2	2	1	10
HSTT38-YK1	0.375	9.5	0.375	9.5	0.187	4.8	12	6	1	1	10
HSTT50-YK1	0.500	12.7	0.500	12.7	0.250	6.4	10	4	1	1	10
HSTT75-YK1	0.750	19.1	0.750	19.1	0.375	9.5	8	2	1	1	10
HSTT100-YK1	1.00	25.4	1.00	25.4	0.500	12.7	7	1	1	1	10



## Heat Shrink in 6 Inch Pieces; Black, Multiple Diameters

- Applications include insulating and protecting wires and cables
- Voltage: 600 V
- Shrink ratio: 2:1
- UL Recognized, CSA Certified
- Mil Spec: AMS-DTL-23053/5 Class 1
- Temperature range: -67°F to 275°F (-55°C to 135°C)
- For dry locations
- Material: Cross-linked Polyolefin



Part Number	Nominal Diameter	No. of Pieces by Diameter	Total No. Pcs.	Std. Pkg. Qty.	Std. Ctn. Qty.
HSTT-YK1	Various – Smaller Range	Two pcs. each 1/8", 1/16", 3/32", 1/4", 3/16", 3/8", 1/2"	14	1	10
HSTT-YK2	Various – Larger Range	Two pcs. each 3/8", 1/2", 3/4", 1"	8	1	10

## Heat Shrink in 6 Inch Pieces; Yellow/Green Stripe, Multiple Diameters

- Applications include insulating, protecting, and color coding wires and cables
- Voltage: 600 V
- Shrink ratio: 2:1
- Flammability: Flame retardant
- UL Recognized, CSA Certified
- Mil Spec: AMS-DTL-23053/5 Class 1
- Temperature range: -67°F to 275°F (-55°C to 135°C)
- For dry locations
- Material: Cross-linked Polyolefin



Part Number	Nominal Diameter	No. of Pieces by Diameter	Total No. Pcs.	Std. Pkg. Qty.	Std. Ctn. Qty.
HSTT-YK1-45	Various – Smaller Range	Two pcs. each 1/8", 3/16", 1/4", 3/8"	8	1	10
HSTT-YK2-45	Various – Larger Range	Two pcs. each 3/8", 1/2", 3/4"	6	1	10

A.  
System  
Overview

B1.  
Cable Ties

B2.  
Cable  
Accessories

B3.  
Stainless  
Steel Ties

C1.  
Wiring  
Duct

C2.  
Surface  
Raceway

C3.  
Abrasion  
Protection

C4.  
Cable  
Management

D1.  
Terminals

D2.  
Power  
Connectors

D3.  
Grounding  
Connectors

E1.  
Labeling  
Systems

E2.  
Labels

E3.  
Pre-Printed  
& Write-On  
Markers

E4.  
Permanent  
Identification

E5.  
Lockout/  
Tagout  
& Safety  
Solutions

F.  
Index

A.  
System  
Overview

## HSTTV Heat Shrink 4 Foot Pieces

B1.  
Cable Ties

- Applications include insulating and protecting wires and cables
- Fast shrink time
- Voltage: 600 V
- Shrink ratio: 2:1
- Flammability: Meets UL 224 VW-1
- UL Recognized, CSA Certified
- Mil Spec: AMS-DTL-23053/5 Class 3
- Temperature range: -67°F to 275°F (-55°C to 135°C)
- For dry locations
- Material: Black cross-linked Polyolefin

B2.  
Cable  
Accessories

B3.  
Stainless  
Steel Ties



C1.  
Wiring  
Duct



C2.  
Surface  
Raceway

C3.  
Abrasion  
Protection

C4.  
Cable  
Management

D1.  
Terminals

D2.  
Power  
Connectors

D3.  
Grounding  
Connectors

E1.  
Labeling  
Systems

E2.  
Labels

E3.  
Pre-Printed  
& Write-On  
Markers

E4.  
Permanent  
Identification

E5.  
Lockout/  
Tagout  
& Safety  
Solutions

F.  
Index

Part Number	Nominal Diameter		Min. Expanded I.D.		Max. Recovered I.D.		Nominal Recovered Wall Thickness		Std. Pkg. Qty.	Std. Ctn. Qty.
	In.	mm	In.	mm	In.	mm	In.	mm		
HSTTV05-48-Q	0.046	1.2	0.046	1.2	0.023	0.6	0.016	0.4	25	—
HSTTV05-48-TL	0.046	1.2	0.046	1.2	0.023	0.6	0.016	0.4	250	—
HSTTV06-48-Q	0.063	1.6	0.063	1.6	0.031	0.8	0.017	0.4	25	—
HSTTV06-48-TL	0.063	1.6	0.063	1.6	0.031	0.8	0.017	0.4	250	—
HSTTV09-48-Q	0.093	2.4	0.093	2.4	0.046	1.2	0.020	0.5	25	—
HSTTV09-48-TL	0.093	2.4	0.093	2.4	0.046	1.2	0.020	0.5	250	—
HSTTV12-48-Q	0.125	3.2	0.125	3.2	0.062	1.6	0.020	0.5	25	—
HSTTV12-48-TL	0.125	3.2	0.125	3.2	0.062	1.6	0.020	0.5	250	—
HSTTV19-48-Q	0.187	4.8	0.187	4.8	0.093	2.4	0.020	0.5	25	—
HSTTV19-48-TL	0.187	4.8	0.187	4.8	0.093	2.4	0.020	0.5	250	—
HSTTV25-48-Q	0.250	6.4	0.250	6.4	0.125	3.2	0.025	0.6	25	—
HSTTV25-48-TL	0.250	6.4	0.250	6.4	0.125	3.2	0.025	0.6	250	—
HSTTV38-48-Q	0.375	9.5	0.375	9.5	0.187	4.8	0.025	0.6	25	—
HSTTV38-48-TL	0.375	9.5	0.375	9.5	0.187	4.8	0.025	0.6	250	—
HSTTV50-48-Q	0.500	12.7	0.500	12.7	0.250	6.4	0.025	0.6	25	—
HSTTV50-48-T	0.500	12.7	0.500	12.7	0.250	6.4	0.025	0.6	200	—
HSTTV75-48-5	0.750	19.1	0.750	19.1	0.375	9.5	0.030	0.8	5	—
HSTTV75-48-CQ	0.750	19.1	0.750	19.1	0.375	9.5	0.030	0.8	125	—
HSTTV100-48-5	1.00	25.4	1.00	25.4	0.500	12.7	0.035	0.9	5	—
HSTTV100-48-LQ	1.00	25.4	1.00	25.4	0.500	12.7	0.035	0.9	75	—
HSTTV150-48-5	1.50	38.1	1.50	38.1	0.750	19.1	0.040	1.0	5	—

## HSTTV Heat Shrink on 100 Foot Reels

- Applications include insulating and protecting wires and cables
- Fast shrink time
- Voltage: 600 V
- Shrink ratio: 2:1
- Flammability: Meets UL 224 VW-1

- UL Recognized, CSA Certified
- Mil Spec: AMS-DTL-23053/5 Class 3
- Temperature range: -67°F to 275°F (-55°C to 135°C)
- For dry locations
- Material: Black Cross-linked Polyolefin



Part Number	Nominal Diameter		Min. Expanded I.D.		Max. Recovered I.D.		Nominal Recovered Wall Thickness		Std. Pkg. Qty.	Std. Ctn. Qty.
	In.	mm	In.	mm	In.	mm	In.	mm		
HSTTV05-C	0.046	1.2	0.046	1.2	0.023	0.6	0.016	0.4	1	10
HSTTV06-C	0.063	1.6	0.063	1.6	0.031	0.8	0.017	0.4	1	10
HSTTV09-C	0.093	2.4	0.093	2.4	0.046	1.2	0.020	0.5	1	10
HSTTV12-C	0.125	3.2	0.125	3.2	0.062	1.6	0.020	0.5	1	10
HSTTV19-C	0.187	4.8	0.187	4.8	0.093	2.4	0.020	0.5	1	10
HSTTV25-C	0.250	6.4	0.250	6.4	0.125	3.2	0.025	0.6	1	10
HSTTV38-C	0.375	9.5	0.375	9.5	0.187	4.8	0.025	0.6	1	10
HSTTV50-C	0.500	12.7	0.500	12.7	0.250	6.4	0.025	0.6	1	10
HSTTV75-C	0.750	19.1	0.750	19.1	0.375	9.5	0.030	0.8	1	10
HSTTV100-C	1.00	25.4	1.00	25.4	0.500	12.7	0.035	0.9	1	2
HSTTV100-C5*	1.00	25.4	1.00	25.4	0.500	12.7	0.035	0.9	1	2
HSTTV150-C	1.50	38.1	1.50	38.1	0.750	19.1	0.040	1.0	1	2

\*Green.

A.  
System  
Overview

B1.  
Cable Ties

B2.  
Cable  
Accessories

B3.  
Stainless  
Steel Ties

C1.  
Wiring  
Duct

C2.  
Surface  
Raceway

C3.  
Abrasion  
Protection

C4.  
Cable  
Management

D1.  
Terminals

D2.  
Power  
Connectors

D3.  
Grounding  
Connectors

E1.  
Labeling  
Systems

E2.  
Labels

E3.  
Pre-Printed  
& Write-On  
Markers

E4.  
Permanent  
Identification

E5.  
Lockout/  
Tagout  
& Safety  
Solutions

F.  
Index

A.  
System  
Overview

## HSTTV Heat Shrink on Bulk Reels

B1.  
Cable Ties

• Applications include insulating, protecting, and color coding wires and cables

• UL Recognized, CSA Certified

• Fast shrink time

• Mil Spec: AMS-DTL-23053/5 Class 3

• Voltage: 600 V

• Temperature range: -67°F to 275°F (-55°C to 135°C)

• Shrink ratio: 2:1

• For dry locations

• Flammability: Meets UL 224 VW-1

• Material: Cross-linked Polyolefin

B2.  
Cable  
Accessories

B3.  
Stainless  
Steel Ties



C1.  
Wiring  
Duct



C2.  
Surface  
Raceway

Part Number	Nominal Diameter		Min. Expanded I.D.		Max. Recovered I.D.		Nominal Recovered Wall Thickness		Length Per Reel		Color	Std. Pkg. Qty.	Std. Ctn. Qty.
	In.	mm	In.	mm	In.	mm	In.	mm	Ft.	m			
HSTTV05-M	0.046	1.2	0.046	1.2	0.023	0.6	0.016	0.4	1000	304.8	Black	1	2
HSTTV05-M2	0.046	1.2	0.046	1.2	0.023	0.6	0.016	0.4	1000	304.8	Red	1	2
HSTTV05-M4	0.046	1.2	0.046	1.2	0.023	0.6	0.016	0.4	1000	304.8	Yellow	1	2
HSTTV05-M6	0.046	1.2	0.046	1.2	0.023	0.6	0.016	0.4	1000	304.8	Blue	1	2
HSTTV06-M	0.063	1.6	0.063	1.6	0.031	0.8	0.017	0.4	1000	304.8	Black	1	2
HSTTV06-M2	0.063	1.6	0.063	1.6	0.031	0.8	0.017	0.4	1000	304.8	Red	1	2
HSTTV06-M4	0.063	1.6	0.063	1.6	0.031	0.8	0.017	0.4	1000	304.8	Yellow	1	2
HSTTV06-M6	0.063	1.6	0.063	1.6	0.031	0.8	0.017	0.4	1000	304.8	Blue	1	2
HSTTV09-M	0.093	2.4	0.093	2.4	0.046	1.2	0.020	0.5	1000	304.8	Black	1	2
HSTTV09-M2	0.093	2.4	0.093	2.4	0.046	1.2	0.020	0.5	1000	304.8	Red	1	2
HSTTV09-M4	0.093	2.4	0.093	2.4	0.046	1.2	0.020	0.5	1000	304.8	Yellow	1	2
HSTTV09-M6	0.093	2.4	0.093	2.4	0.046	1.2	0.020	0.5	1000	304.8	Blue	1	2
HSTTV12-M	0.125	3.2	0.125	3.2	0.062	1.6	0.020	0.5	1000	304.8	Black	1	2
HSTTV12-M2	0.125	3.2	0.125	3.2	0.062	1.6	0.020	0.5	1000	304.8	Red	1	2
HSTTV12-M4	0.125	3.2	0.125	3.2	0.062	1.6	0.020	0.5	1000	304.8	Yellow	1	2
HSTTV12-M6	0.125	3.2	0.125	3.2	0.062	1.6	0.020	0.5	1000	304.8	Blue	1	2
HSTTV19-M	0.187	4.8	0.187	4.8	0.093	2.4	0.020	0.5	1000	304.8	Black	1	2
HSTTV19-M2	0.187	4.8	0.187	4.8	0.093	2.4	0.020	0.5	1000	304.8	Red	1	2
HSTTV19-M4	0.187	4.8	0.187	4.8	0.093	2.4	0.020	0.5	1000	304.8	Yellow	1	2
HSTTV19-M6	0.187	4.8	0.187	4.8	0.093	2.4	0.020	0.5	1000	304.8	Blue	1	2
HSTTV25-D	0.250	6.4	0.250	6.4	0.125	3.2	0.025	0.6	500	152.4	Black	1	2
HSTTV25-D2	0.250	6.4	0.250	6.4	0.125	3.2	0.025	0.6	500	152.4	Red	1	2
HSTTV25-D4	0.250	6.4	0.250	6.4	0.125	3.2	0.025	0.6	500	152.4	Yellow	1	2
HSTTV25-D6	0.250	6.4	0.250	6.4	0.125	3.2	0.025	0.6	500	152.4	Blue	1	2
HSTTV38-T	0.375	9.5	0.375	9.5	0.187	4.8	0.025	0.6	200	61.1	Black	1	2
HSTTV38-T2	0.375	9.5	0.375	9.5	0.187	4.8	0.025	0.6	200	61.1	Red	1	2
HSTTV38-T4	0.375	9.5	0.375	9.5	0.187	4.8	0.025	0.6	200	61.1	Yellow	1	2
HSTTV38-T6	0.375	9.5	0.375	9.5	0.187	4.8	0.025	0.6	200	61.1	Blue	1	2
HSTTV50-T	0.500	12.7	0.500	12.7	0.250	6.4	0.025	0.6	200	61.1	Black	1	2
HSTTV50-T2	0.500	12.7	0.500	12.7	0.250	6.4	0.025	0.6	200	61.1	Red	1	2
HSTTV50-T4	0.500	12.7	0.500	12.7	0.250	6.4	0.025	0.6	200	61.1	Yellow	1	2
HSTTV50-T6	0.500	12.7	0.500	12.7	0.250	6.4	0.025	0.6	200	61.1	Blue	1	2
HSTTV75-T	0.750	19.1	0.750	19.1	0.375	9.5	0.030	0.8	200	61.1	Black	1	2
HSTTV75-T2	0.750	19.1	0.750	19.1	0.375	9.5	0.030	0.8	200	61.1	Red	1	2
HSTTV75-T4	0.750	19.1	0.750	19.1	0.375	9.5	0.030	0.8	200	61.1	Yellow	1	2
HSTTV75-T6	0.750	19.1	0.750	19.1	0.375	9.5	0.030	0.8	200	61.1	Blue	1	2

C3.  
Abrasion  
Protection

C4.  
Cable  
Management

D1.  
Terminals

D2.  
Power  
Connectors

D3.  
Grounding  
Connectors

E1.  
Labeling  
Systems

E2.  
Labels

E3.  
Pre-Printed  
& Write-On  
Markers

E4.  
Permanent  
Identification

E5.  
Lockout/  
Tagout  
& Safety  
Solutions

F.  
Index

## UL® SP® HSTTV Heat Shrink on 25 Foot Reels

- Applications include insulating and protecting wires and cables
- Fast shrink time
- Voltage: 600 V
- Shrink ratio: 2:1
- Flammability: Meets UL 224 VW-1
- UL Recognized, CSA Certified
- Mil Spec: AMS-DTL-23053/5 Class 3
- Temperature range: -67°F to 275°F (-55°C to 135°C)
- For dry locations
- Material: Black cross-linked Polyolefin



Part Number	Nominal Diameter		Min. Expanded I.D.		Max. Recovered I.D.		Nominal Recovered Wall Thickness		Std. Pkg. Qty.	Std. Ctn. Qty.
	In.	mm	In.	mm	In.	mm	In.	mm		
HSTTV05-Q	0.046	1.2	0.046	1.2	0.023	0.6	0.016	0.4	1	10
HSTTV06-Q	0.063	1.6	0.063	1.6	0.031	0.8	0.017	0.4	1	10
HSTTV09-Q	0.093	2.4	0.093	2.4	0.046	1.2	0.020	0.5	1	10
HSTTV12-Q	0.125	3.2	0.125	3.2	0.062	1.6	0.020	0.5	1	10
HSTTV19-Q	0.187	4.8	0.187	4.8	0.093	2.4	0.020	0.5	1	10
HSTTV25-Q	0.250	6.4	0.250	6.4	0.125	3.2	0.025	0.6	1	10
HSTTV38-Q	0.375	9.5	0.375	9.5	0.187	4.8	0.025	0.6	1	10
HSTTV50-Q	0.500	12.7	0.500	12.7	0.250	6.4	0.025	0.6	1	10
HSTTV75-Q	0.750	19.1	0.750	19.1	0.375	9.5	0.030	0.8	1	10
HSTTV100-Q	1.00	25.4	1.00	25.4	0.500	12.7	0.035	0.9	1	2

## UL® SP® HSTTV Heat Shrink 6 Inch Pieces

- Applications include insulating and protecting wires and cables
- Fast shrink time
- Voltage: 600 V
- Shrink ratio: 2:1
- Flammability: Meets UL 224 VW-1
- UL Recognized, CSA Certified
- Mil Spec: AMS-DTL-23053/5 Class 3
- Temperature range: -67°F to 275°F (-55°C to 135°C)
- For dry locations
- Material: Black cross-linked Polyolefin



Part Number	Nominal Diameter / Size		Min. Expanded I.D.		Max. Recovered I.D.		Pieces Per Package	Std. Pkg. Qty.	Std. Ctn. Qty.
	In.	mm	In.	mm	In.	mm			
HSTTV05-Y	0.046	1.2	0.046	1.2	0.023	0.6	26	1	10
HSTTV06-Y	0.063	1.6	0.063	1.6	0.031	0.8	26	1	10
HSTTV09-Y	0.093	2.4	0.093	2.4	0.046	1.2	24	1	10
HSTTV12-Y	0.125	3.2	0.125	3.2	0.062	1.6	20	1	10
HSTTV19-Y	0.187	4.8	0.187	4.8	0.093	2.4	18	1	10
HSTTV25-Y	0.250	6.4	0.250	6.4	0.125	3.2	14	1	10
HSTTV38-Y	0.375	9.5	0.375	9.5	0.187	4.8	12	1	10
HSTTV50-Y	0.500	12.7	0.500	12.7	0.250	6.4	10	1	10
HSTTV75-Y	0.750	19.1	0.750	19.1	0.375	9.5	8	1	10
HSTTV100-Y	1.00	25.4	1.00	25.4	0.500	12.7	6	1	10

A.  
System  
Overview

## HSTTP PVC Heat Shrink

B1.  
Cable Ties

- Applications include insulating and protecting wires and cables
- Good resistance to most fuels and oils
- Voltage: 600 V
- Shrink ratio: 2:1
- Flammability: Meets UL 224 VW-1

- UL Recognized, CSA Certified
- Temperature range: -4°F to 221°F (-20°C to 105°C)
- For dry locations
- Material: Black cross-linked Polyvinyl Chloride
- Mil Spec: AMS-DTL-23053/2 Class 1

B2.  
Cable  
Accessories

B3.  
Stainless  
Steel Ties



C1.  
Wiring  
Duct

C2.  
Surface  
Raceway

C3.  
Abrasion  
Protection

C4.  
Cable  
Management

D1.  
Terminals

D2.  
Power  
Connectors

D3.  
Grounding  
Connectors

E1.  
Labeling  
Systems

E2.  
Labels

E3.  
Pre-Printed  
& Write-On  
Markers

E4.  
Permanent  
Identification

E5.  
Lockout/  
Tagout  
& Safety  
Solutions

F.  
Index



Part Number	Nominal Diameter		Min. Expanded I.D.		Max. Recovered I.D.		Nominal Recovered Wall Thickness		Length Per Reel		Std. Pkg. Qty.	Std. Ctn. Qty.
	In.	mm	In.	mm	In.	mm	In.	mm	Ft.	m		
HSTTP05-QY	0.046	1.2	0.046	1.2	0.023	0.6	0.02	0.5	25	7.6	1	10
HSTTP05-CY	0.046	1.2	0.046	1.2	0.023	0.6	0.02	0.5	100	30.5	1	2
HSTTP05-MY	0.046	1.2	0.046	1.2	0.023	0.6	0.02	0.5	1000	304.8	1	2
HSTTP06-QY	0.063	1.6	0.063	1.6	0.031	0.8	0.02	0.5	25	7.6	1	10
HSTTP06-CY	0.063	1.6	0.063	1.6	0.031	0.8	0.02	0.5	100	30.5	1	2
HSTTP06-MY	0.063	1.6	0.063	1.6	0.031	0.8	0.02	0.5	1000	304.8	1	2
HSTTP09-QY	0.093	2.4	0.093	2.4	0.046	1.2	0.025	0.6	25	7.6	1	10
HSTTP09-CY	0.093	2.4	0.093	2.4	0.046	1.2	0.025	0.6	100	30.5	1	2
HSTTP09-MY	0.093	2.4	0.093	2.4	0.046	1.2	0.025	0.6	1000	304.8	1	2
HSTTP12-QY	0.125	3.2	0.125	3.2	0.062	1.6	0.025	0.6	25	7.6	1	10
HSTTP12-CY	0.125	3.2	0.125	3.2	0.062	1.6	0.025	0.6	100	30.5	1	2
HSTTP12-MY	0.125	3.2	0.125	3.2	0.062	1.6	0.025	0.6	1000	304.8	1	2
HSTTP19-QY	0.187	4.8	0.187	4.8	0.093	2.4	0.025	0.6	25	7.6	1	10
HSTTP19-CY	0.187	4.8	0.187	4.8	0.093	2.4	0.025	0.6	100	30.5	1	2
HSTTP19-MY	0.187	4.8	0.187	4.8	0.093	2.4	0.025	0.6	1000	304.8	1	2
HSTTP25-QY	0.250	6.4	0.250	6.4	0.125	3.2	0.025	0.6	25	7.6	1	10
HSTTP25-CY	0.250	6.4	0.250	6.4	0.125	3.2	0.025	0.6	100	30.5	1	2
HSTTP25-DY	0.250	6.4	0.250	6.4	0.125	3.2	0.025	0.6	500	152.4	1	2
HSTTP38-QY	0.375	9.5	0.375	9.5	0.187	4.8	0.03	0.8	25	7.6	1	10
HSTTP38-CY	0.375	9.5	0.375	9.5	0.187	4.8	0.03	0.8	100	30.5	1	2
HSTTP38-TY	0.375	9.5	0.375	9.5	0.187	4.8	0.03	0.8	200	61.0	1	2
HSTTP50-QY	0.500	12.7	0.500	12.7	0.250	6.4	0.03	0.8	25	7.6	1	10
HSTTP50-CY	0.500	12.7	0.500	12.7	0.250	6.4	0.03	0.8	100	30.5	1	2
HSTTP75-QY	0.750	19.1	0.750	19.1	0.375	9.5	0.035	0.9	25	7.6	1	10
HSTTP75-CY	0.750	19.1	0.750	19.1	0.375	9.5	0.035	0.9	100	30.5	1	2
HSTTP100-QY	1.00	25.4	1.00	25.4	0.500	12.7	0.04	1.0	25	7.6	1	2
HSTTP100-CY	1.00	25.4	1.00	25.4	0.500	12.7	0.04	1.0	100	30.5	1	2
HSTTP150-QY	1.50	38.1	1.50	38.1	0.750	19.1	0.045	1.1	25	7.6	1	2
HSTTP150-CY	1.50	38.1	1.50	38.1	0.750	19.1	0.045	1.1	100	30.5	1	2
HSTTP200-QY	2.00	50.8	2.00	50.8	1.00	25.4	0.05	1.3	25	7.6	1	2

## RA® SP® HSTTPN Crystal Clear PVC Heat Shrink



- Low shrink temperature (store below 90°F) to speed installation
- Crystal clear material ensures easy to read labels and splice inspections
- Voltage: 600 V
- Shrink ratio of 2:1 insulates a wide range of diameters and irregular shapes
- Highly flame retardant product manufactured from a material that is rated UL 224 VW-1
- Temperature range: -4°F to 221°F (-20°C to 105°C)
- For dry locations
- Material: Clear Polyvinyl Chloride
- Mil Spec: AMS-DTL-23053/2 Class 2



Part Number	Nominal Diameter		Min. Expanded I.D.		Max. Recovered I.D.		Nominal Recovered Wall Thickness		Length		Length Per Reel		Std. Pkg. Qty.	Std. Ctn. Qty.
	In.	mm	In.	mm	In.	mm	In.	mm	In.	mm	Ft.	m		
HSTTPN50-438-L	0.46	11.7	0.46	11.7	0.25	6.4	0.022	0.6	4.38	111.3	—	—	50	500
HSTTPN50-713-Q	0.46	11.7	0.46	11.7	0.25	6.4	0.022	0.6	7.13	181.1	—	—	25	250
HSTTPN62-750-Q	0.56	14.3	0.56	14.3	0.31	8.0	0.027	0.7	7.50	190.5	—	—	25	250
HSTTPN75-775-Q	0.70	17.7	0.70	17.7	0.38	9.5	0.027	0.7	7.75	196.9	—	—	25	250
HSTTPN100-775-Q	0.90	22.9	0.90	22.9	0.50	12.7	0.030	0.8	7.75	196.9	—	—	25	250
HSTTPN150-925-X	1.40	35.4	1.40	35.4	0.75	19.1	0.030	0.8	9.25	235.0	—	—	10	100
HSTTPN200-950-X	1.80	45.7	1.80	45.7	1.00	25.4	0.039	1.0	9.50	241.3	—	—	10	100
HSTTPN50-CC	0.46	11.7	0.46	11.7	0.25	6.4	0.022	0.6	—	—	100	30.5	1	2
HSTTPN62-CC	0.56	14.3	0.56	14.3	0.31	8.0	0.027	0.7	—	—	100	30.5	1	2
HSTTPN75-CC	0.70	17.7	0.70	17.7	0.38	9.5	0.027	0.7	—	—	100	30.5	1	2
HSTTPN100-CC	0.90	22.9	0.90	22.9	0.50	12.7	0.030	0.8	—	—	100	30.5	1	2
HSTTPN150-CC	1.40	35.4	1.40	35.4	0.75	19.1	0.030	0.8	—	—	100	30.5	1	2
HSTTPN200-CC	1.80	45.7	1.80	45.7	1.00	25.4	0.039	1.0	—	—	100	30.5	1	2

## HSTTN Neoprene Heat Shrink

- Applications include insulating, protecting, and color coding wires and cables
- Excellent chemical resistance especially to fuels and oils
- Voltage: 600 V
- Shrink ratio: 2:1
- Mil Spec: AMS-DTL-23053/1 Class 2
- Temperature range: -94°F to 250°F (-70°C to 121°C)
- For dry locations
- Material: Black cross-linked Neoprene



Part Number	Nominal Diameter		Min. Expanded I.D.		Max. Recovered I.D.		Nominal Recovered Wall Thickness		Length per Reel		Std. Pkg. Qty.	Std. Ctn. Qty.
	In.	mm	In.	mm	In.	mm	In.	mm	Ft.	m		
HSTTN25-CY	0.250	6.4	0.250	6.4	0.143	3.6	0.035	0.9	100	30.5	1	2
HSTTN38-CY	0.375	9.5	0.375	9.5	0.211	5.4	0.040	1.0	100	30.5	1	2
HSTTN50-CY	0.500	12.7	0.500	12.7	0.286	7.3	0.048	1.2	100	30.5	1	2
HSTTN63-CY	0.625	15.9	0.625	15.9	0.357	9.1	0.052	1.3	100	30.5	1	2
HSTTN75-CY	0.750	19.1	0.750	19.1	0.428	10.9	0.057	1.5	100	30.5	1	2
HSTTN88-CY	0.875	22.2	0.875	22.2	0.500	12.7	0.065	1.7	100	30.5	1	2
HSTTN100-CY	1.00	25.4	1.00	25.4	0.570	14.5	0.070	1.8	100	30.5	1	2
HSTTN125-CY	1.25	31.8	1.25	31.8	0.714	18.1	0.087	2.2	100	30.5	1	2
HSTTN150-CY	1.50	38.1	1.50	38.1	0.857	21.8	0.095	2.4	100	30.5	1	2
HSTTN175-CY	1.75	44.5	1.75	44.5	1.00	25.4	0.107	2.7	100	30.5	1	1
HSTTN200-QY	2.00	50.8	2.00	50.8	1.14	29.0	0.110	2.8	25	7.6	1	2
HSTTN300-QY	3.00	76.2	3.00	76.2	1.71	43.4	0.125	3.8	25	7.6	1	2

A.  
System  
Overview

## TFE Heat Shrink 4 Foot Pieces

B1.  
Cable Ties

- Applications include insulating and protecting wires and cables
- Voltage: 600 V
- Shrink ratio: 2:1
- Mil Spec: AMS-DTL-23053/12 Class 3
- Temperature range: -88°F to 482°F (-67°C to 250°C)

- Color: Opaque
- For dry locations
- Material: Polytetrafluoroethylene (TFE)
- High temperature; resists corrosive atmosphere
- See page C3.42 for shrink instructions

B2.  
Cable  
Accessories

B3.  
Stainless  
Steel Ties



C1.  
Wiring  
Duct

C2.  
Surface  
Raceway

C3.  
Abrasion  
Protection

C4.  
Cable  
Management

D1.  
Terminals

D2.  
Power  
Connectors

D3.  
Grounding  
Connectors

E1.  
Labeling  
Systems

E2.  
Labels

E3.  
Pre-Printed  
& Write-On  
Markers

E4.  
Permanent  
Identification

E5.  
Lockout/  
Tagout/  
& Safety  
Solutions

F.  
Index



Part Number	Nominal Diameter		Min. Expanded I.D.		Max. Recovered I.D.		Nominal Recovered Wall Thickness		Length		Std. Pkg. Qty.
	In.	mm	In.	mm	In.	mm	In.	mm	Ft.	m	
HSTTT03-48-Q	30 AWG	0.9	0.034	0.9	0.015	0.4	0.009	0.2	4	1.2	25
HSTTT04-48-Q	28 AWG	1.0	0.038	1.0	0.018	0.5	0.009	0.2	4	1.2	25
HSTTT046-48-Q	26 AWG	1.2	0.046	1.2	0.022	0.5	0.010	0.3	4	1.2	25
HSTTT05-48-Q	24 AWG	1.3	0.050	1.3	0.027	0.7	0.010	0.3	4	1.2	25
HSTTT055-48-Q	22 AWG	1.4	0.055	1.4	0.032	0.8	0.012	0.3	4	1.2	25
HSTTT06-48-Q	20 AWG	1.5	0.060	1.5	0.039	1.0	0.012	0.3	4	1.2	25
HSTTT08-48-Q	18 AWG	1.9	0.076	1.9	0.049	1.2	0.012	0.3	4	1.2	25
HSTTT09-48-Q	16 AWG	2.3	0.093	2.3	0.061	1.6	0.012	0.3	4	1.2	25
HSTTT12-48-Q	14 AWG	3.0	0.120	3.0	0.072	1.8	0.012	0.3	4	1.2	25
HSTTT15-48-Q	12 AWG	3.8	0.150	3.8	0.089	2.3	0.012	0.3	4	1.2	25
HSTTT19-48-Q	10 AWG	4.9	0.191	4.9	0.112	2.8	0.012	0.3	4	1.2	25
HSTTT24-48-Q	8 AWG	6.0	0.240	6.0	0.141	3.6	0.015	0.4	4	1.2	25
HSTTT30-48-Q	6 AWG	7.7	0.302	7.7	0.178	4.5	0.015	0.4	4	1.2	25
HSTTT37-48-Q	4 AWG	9.4	0.370	9.4	0.224	5.7	0.015	0.4	4	1.2	25
HSTTT43-48-Q	2 AWG	10.9	0.430	10.9	0.278	7.0	0.015	0.4	4	1.2	25
HSTTT47-48-Q	0 AWG	11.9	0.470	11.9	0.347	8.8	0.015	0.4	4	1.2	25
HSTTT56-48-5	9/16	14.2	0.560	14.2	0.399	10.1	0.015	0.4	4	1.2	5
HSTTT66-48-5	5/8	16.6	0.655	16.6	0.462	11.7	0.018	0.5	4	1.2	5
HSTTT75-48-5	3/4	19.1	0.750	19.0	0.524	13.3	0.018	0.5	4	1.2	5
HSTTT93-48-5	15/16	23.6	0.930	23.6	0.655	16.6	0.020	0.5	4	1.2	5
HSTTT112-48-5	1 1/8	28.6	1.12	28.6	0.786	20.0	0.025	0.6	4	1.2	5
HSTTT131-48-2	1 5/16	33.3	1.31	33.3	0.911	23.1	0.030	0.8	4	1.2	2
HSTTT150-48-2	1 1/2	38.1	1.50	38.1	1.036	26.3	0.030	0.8	4	1.2	2



## **RU** **SP** HSTTK Kynar\* Heat Shrink 4 Foot Pieces

- Applications include insulating and protecting wires and cables
- Excellent chemical and abrasion resistance
- Use in high temperature or solvent rich environment
- Voltage: 600 V
- Shrink ratio: 2:1
- Flammability: Meets UL 224 VW-1
- Mil Spec: AMS-DTL-23053/8
- Temperature range: -67°F to 347°F (-55°C to 175°C)
- For dry locations
- Material: Clear Cross-linked Polyvinylidene Fluoride (PVDF)



Part Number	Nominal Diameter		Min. Expanded I.D.		Max. Recovered I.D.		Nominal Recovered Wall Thickness		Std. Pkg. Qty.
	In.	mm	In.	mm	In.	mm	In.	mm	
HSTTK05-48-Q	0.046	1.2	0.046	1.2	0.023	0.6	0.010	0.3	25
HSTTK06-48-Q	0.063	1.6	0.063	1.6	0.031	0.8	0.010	0.3	25
HSTTK09-48-Q	0.093	2.4	0.093	2.4	0.046	1.2	0.010	0.3	25
HSTTK12-48-Q	0.125	3.2	0.125	3.2	0.062	1.6	0.010	0.3	25
HSTTK19-48-Q	0.187	4.8	0.187	4.8	0.093	2.4	0.010	0.3	25
HSTTK25-48-Q	0.250	6.4	0.250	6.4	0.125	3.2	0.012	0.3	25
HSTTK38-48-Q	0.375	9.5	0.375	9.5	0.187	4.8	0.012	0.3	25
HSTTK50-48-5	0.500	12.7	0.500	12.7	0.250	6.4	0.012	0.3	5
HSTTK75-48-5	0.750	19.1	0.750	19.1	0.375	9.5	0.017	0.4	5
HSTTK100-48-5	1.00	25.4	1.00	25.4	0.500	12.7	0.019	0.5	5

\*KYNAR is a registered trademark of Atofina Chemicals, Inc.

## **RU** HSTTVA Heat Shrink 4 Foot and 6 Inch Pieces

- Applications include insulating and protecting wires and cables
- Flexible tubing with an adhesive inner wall which seals and protects components from moisture and corrosion
- Voltage rating: 600 V
- Shrink ratio: 2:1
- Flammability: Outer wall flame retardant
- Mil Spec: AMS-DTL-23053/4 Class 2
- Temperature range: -67°F to 230°F (-55°C to 110°C)
- For damp locations
- Material: Adhesive lined black cross-linked Polyolefin



Part Number	Nominal Diameter		Min. Expanded I.D.		Max. Recovered I.D.		Nominal Recovered Wall Thickness		Std. Pkg. Qty.
	In.	mm	In.	mm	In.	mm	In.	mm	
<b>4' (1.22m) Pieces</b>									
HSTTVA12-48-Q	0.125	3.2	0.125	3.2	0.062	1.6	0.021	0.5	25
HSTTVA19-48-Q	0.187	4.8	0.187	4.8	0.093	2.4	0.023	0.6	25
HSTTVA25-48-Q	0.250	6.4	0.250	6.4	0.125	3.2	0.029	0.7	25
HSTTVA38-48-Q	0.375	9.5	0.375	9.5	0.187	4.8	0.029	0.7	25
HSTTVA50-48-5	0.500	12.7	0.500	12.7	0.250	6.4	0.030	0.8	5
HSTTVA75-48-5	0.750	19.1	0.750	19.1	0.375	9.5	0.035	0.9	5
HSTTVA100-48-5	1.00	25.4	1.00	25.4	0.500	12.7	0.042	1.1	5
HSTTVA150-48-5	1.50	38.1	1.50	38.1	0.750	19.1	0.047	1.2	5

Table continues on page C3.36

A. System Overview

B1. Cable Ties

B2. Cable Accessories

B3. Stainless Steel Ties

C1. Wiring Duct

C2. Surface Raceway

C3. Abrasion Protection

C4. Cable Management

D1. Terminals

D2. Power Connectors

D3. Grounding Connectors

E1. Labeling Systems

E2. Labels

E3. Pre-Printed & Write-On Markers

E4. Permanent Identification

E5. Lockout/Tagout & Safety Solutions

F. Index

A. System Overview

## HSTTVA Heat Shrink 4 Foot and 6 Inch Pieces (continued)

B1. Cable Ties

Part Number	Nominal Diameter		Min. Expanded I.D.		Max. Recovered I.D.		Nominal Recovered Wall Thickness		Std. Pkg. Qty.	Pieces per Package
	In.	mm	In.	mm	In.	mm	In.	mm		
<b>6" (152.4mm) Pieces</b>										
HSTTVA12-Y	0.125	3.2	0.125	3.2	0.062	1.6	0.020	0.5	1	7
HSTTVA19-Y	0.187	4.8	0.187	4.8	0.093	2.4	0.022	0.6	1	7
HSTTVA25-Y	0.250	6.4	0.250	6.4	0.125	3.2	0.030	0.8	1	5
HSTTVA38-Y	0.375	9.5	0.375	9.5	0.187	4.8	0.031	0.8	1	4
HSTTVA50-Y	0.500	12.7	0.500	12.7	0.250	6.4	0.032	0.8	1	4
HSTTVA75-Y	0.750	19.1	0.750	19.1	0.375	9.5	0.037	0.9	1	3
HSTTVA100-Y	1.00	25.4	1.00	25.4	0.500	12.7	0.046	1.2	1	2

B2. Cable Accessories

B3. Stainless Steel Ties

C1. Wiring Duct

## HSTTA Heat Shrink 4 Foot and 6 Inch Pieces

- Applications include insulating and protecting wires and cables
- Flexible tubing with an adhesive inner wall which seals and protects components from moisture and corrosion
- Voltage rating: 600 V
- Shrink ratio: 3:1
- Flammability: Outer wall flame retardant
- Mil Spec: AMS-DTL-23053/4 Class 3
- Temperature range: -67°F to 230°F (-55°C to 110°C)
- For damp locations
- Material: Adhesive lined black cross-linked Polyolefin



C2. Surface Raceway

C3. Abrasion Protection

C4. Cable Management



D1. Terminals

D2. Power Connectors

D3. Grounding Connectors

E1. Labeling Systems

E2. Labels

E3. Pre-Printed & Write-On Markers

E4. Permanent Identification

E5. Lockout/Tagout & Safety Solutions

F. Index

Part Number	Nominal Diameter		Min. Expanded I.D.		Max. Recovered I.D.		Nominal Recovered Wall Thickness		Std. Pkg. Qty.	Std. Ctn. Qty.
	In.	mm	In.	mm	In.	mm	In.	mm		
<b>4' (1.22m) Pieces</b>										
HSTTA19-48-Q	0.187	4.8	0.187	4.8	0.062	1.6	0.040	1.0	25	—
HSTTA25-48-Q	0.250	6.4	0.250	6.4	0.080	2.0	0.040	1.0	25	—
HSTTA25-48-TL	0.250	6.4	0.250	6.4	0.080	2.0	0.040	1.0	250	—
HSTTA38-48-Q	0.375	9.5	0.375	9.5	0.120	3.0	0.055	1.4	25	—
HSTTA38-48-TL	0.375	9.5	0.375	9.5	0.120	3.0	0.055	1.4	250	—
HSTTA50-48-5	0.500	12.7	0.500	12.7	0.160	4.1	0.070	1.8	5	—
HSTTA50-48-T	0.500	12.7	0.500	12.7	0.160	4.1	0.070	1.8	200	—
HSTTA75-48-5	0.750	19.1	0.750	19.1	0.250	6.4	0.085	2.2	5	—
HSTTA75-48-C	0.750	19.1	0.750	19.1	0.250	6.4	0.085	2.2	100	—
HSTTA100-48-5	1.00	25.4	1.00	25.4	0.320	8.1	0.100	2.5	5	—
HSTTA100-48-L	1.00	25.4	1.00	25.4	0.320	8.1	0.100	2.5	50	—
HSTTA150-48-5	1.50	38.1	1.50	38.1	0.510	12.9	0.100	2.5	5	—
HSTTA150-48-Q	1.50	38.1	1.50	38.1	0.510	12.9	0.100	2.5	25	—

Part Number	Nominal Diameter		Min. Expanded I.D.		Max. Recovered I.D.		Nominal Recovered Wall Thickness		Std. Pkg. Qty.	Std. Ctn. Qty.	Pieces per Package
	In.	mm	In.	mm	In.	mm	In.	mm			
<b>6" (152.4mm) Pieces</b>											
HSTTA19-Y	0.187	4.8	0.187	4.8	0.062	1.6	0.040	1.0	1	10	6
HSTTA25-Y	0.250	6.4	0.250	6.4	0.080	2.0	0.040	1.0	1	10	4
HSTTA38-Y	0.375	9.5	0.375	9.5	0.120	3.0	0.055	1.4	1	10	3
HSTTA50-Y	0.500	12.7	0.500	12.7	0.160	4.1	0.070	1.8	1	10	3
HSTTA75-Y	0.750	19.1	0.750	19.1	0.250	6.4	0.085	2.2	1	10	2
HSTTA100-Y	1.00	25.4	1.00	25.4	0.320	8.1	0.100	2.5	1	10	2
HSTTA150-Y	1.50	38.1	1.50	38.1	0.510	12.9	0.100	2.5	1	10	1

## HSTT4A Heat Shrink 4 Foot Pieces

- Applications include insulating and protecting oversized electrical and electronic components, cables, terminals and connectors
- Flexible tubing with an adhesive inner wall which seals and protects components from moisture and corrosion
- Voltage: 600 V
- Shrink ratio: 4:1

- Flammability: Flame retardant outer wall meets UL 224 VW-1
- Mil Spec: AMS-DTL-23053/4 Class 3
- Temperature range: -67°F to 257°F (-55°C to 125°C)
- For damp locations
- Material: Adhesive lined black cross-linked Polyolefin



Part Number	Nominal Diameter		Min. Expanded I.D.		Max. Recovered I.D.		Nominal Recovered Wall Thickness		Length		Std. Pkg. Qty.
	In.	mm	In.	mm	In.	mm	In.	mm	Ft.	m	
HSTT4A15-48-Q	0.158	4.0	0.158	4.0	0.039	1.0	0.043	1.10	4	1.2	25
HSTT4A31-48-Q	0.315	8.0	0.315	8.0	0.079	2.0	0.043	1.10	4	1.2	25
HSTT4A47-48-Q	0.472	12.0	0.472	12.0	0.118	3.0	0.055	1.40	4	1.2	25
HSTT4A62-48-5	0.630	16.0	0.630	16.0	0.158	4.0	0.070	1.80	4	1.2	5
HSTT4A94-48-5	0.945	24.0	0.945	24.0	0.236	6.0	0.088	2.25	4	1.2	5
HSTT4A125-48-5	1.26	32.0	1.26	32.0	0.315	8.0	0.100	2.54	4	1.2	5
HSTT4A200-48-5	2.05	52.0	2.05	52.0	0.512	13.0	0.100	2.54	4	1.2	5

## HSTTRA Heat Shrink 4 Foot Pieces

- Applications include insulating and protecting wires and cables
- Semi-rigid tubing with an adhesive inner wall seals and protects components from moisture and corrosion
- Voltage rating: 600 V
- Shrink ratio: 2.5:1 Minimum

- Mil Spec: AMS-DTL-23053/4 Class 1
- Temperature range: -67°F to 230°F (-55°C to 110°C)
- For damp locations
- Material: Adhesive lined black cross-linked Polyolefin



Part Number	Nominal Diameter		Min. Expanded I.D.		Max. Recovered I.D.		Nominal Recovered Wall Thickness		Std. Pkg. Qty.
	In.	mm	In.	mm	In.	mm	In.	mm	
HSTTRA12-48-Q	0.125	3.2	0.125	3.2	0.023	0.6	0.038	1.0	25
HSTTRA19-48-Q	0.187	4.8	0.187	4.8	0.060	1.5	0.043	1.1	25
HSTTRA25-48-Q	0.250	6.4	0.250	6.4	0.080	2.0	0.047	1.2	25
HSTTRA38-48-Q	0.375	9.5	0.375	9.5	0.135	3.4	0.050	1.3	25
HSTTRA50-48-5	0.500	12.7	0.500	12.7	0.195	5.0	0.055	1.4	5
HSTTRA75-48-5	0.750	19.1	0.750	19.1	0.313	8.0	0.065	1.7	5
HSTTRA100-48-5	1.00	25.4	1.00	25.4	0.400	10.2	0.075	1.9	5

A. System Overview

B1. Cable Ties

B2. Cable Accessories

B3. Stainless Steel Ties

C1. Wiring Duct

C2. Surface Raceway

C3. Abrasion Protection

C4. Cable Management

D1. Terminals

D2. Power Connectors

D3. Grounding Connectors

E1. Labeling Systems

E2. Labels

E3. Pre-Printed & Write-On Markers

E4. Permanent Identification

E5. Lockout/Tagout & Safety Solutions

F. Index

A. System Overview

 **Thick Wall Polyolefin Heat Shrink**

B1. Cable Ties

- Applications include insulating and protecting wires and cables
- Adhesive-lined inner wall seals and protects against moisture
- Thick wall suitable for direct burial according to UL 486D and provides excellent protection

- UL Listed, UL Recognized and CSA Certified (Except HST3.0 and HST3.5)
- Mil Spec: AMS-DTL-23053/15
- Temperature range: -67°F to 230°F (-55°C to 110°C)
- For wet locations
- Suitable for outdoor, direct sunlight applications (Black only)
- Material: Adhesive lined black and red cross-linked Polyolefin

B2. Cable Accessories

- Voltage rating: UL 486D Listed for 600 V 90°C continuous use
- Shrink ratio: 3:1
- Flammability: Flame retardant outer wall meets UL 224 VW-1

B3. Stainless Steel Ties



C1. Wiring Duct

C2. Surface Raceway

C3. Abrasion Protection

C4. Cable Management

D1. Terminals

D2. Power Connectors

D3. Grounding Connectors

E1. Labeling Systems

E2. Labels

E3. Pre-Printed & Write-On Markers

E4. Permanent Identification

E5. Lockout/Tagout & Safety Solutions

F. Index



Part Number	Min. Expanded I.D.		Max. Recovered I.D.		Nominal Recovered Wall Thickness		Length		Std. Pkg. Qty.	Std. Ctn. Qty.
	In.	mm	In.	mm	In.	mm	In.	mm		
HST0.4-3-Q2Y*	0.40	10.2	0.16	4.1	0.08	2.0	3.0	76.2	25	100
HST0.4-3-QY*	0.40	10.2	0.16	4.1	0.08	2.0	3.0	76.2	25	100
HST0.4-48-5-2Y*	0.40	10.2	0.16	4.1	0.08	2.0	48.0	1219.2	5	20
HST0.4-48-5Y*	0.40	10.2	0.16	4.1	0.08	2.0	48.0	1219.2	5	20
HST0.4-6-3Y*	0.40	10.2	0.16	4.1	0.08	2.0	6.0	152.4	3	30
HST0.4-6-X2Y*	0.40	10.2	0.16	4.1	0.08	2.0	6.0	152.4	10	100
HST0.4-6-XY*	0.40	10.2	0.16	4.1	0.08	2.0	6.0	152.4	10	100
HST0.8-12-5-2Y*	0.75	19.1	0.22	5.6	0.09	2.3	12.0	304.8	5	50
HST0.8-12-5Y*	0.75	19.1	0.22	5.6	0.09	2.3	12.0	304.8	5	50
HST0.8-48-5-2Y*	0.75	19.1	0.22	5.6	0.09	2.3	48.0	1219.2	5	20
HST0.8-48-5Y*	0.75	19.1	0.22	5.6	0.09	2.3	48.0	1219.2	5	20
HST0.8-6-3Y*	0.75	19.1	0.22	5.6	0.09	2.3	6.0	152.4	3	30
HST0.8-6-X2Y*	0.75	19.1	0.22	5.6	0.09	2.3	6.0	152.4	10	100
HST0.8-6-XY*	0.75	19.1	0.22	5.6	0.09	2.3	6.0	152.4	10	100
HST0.8-9-X2Y*	0.75	19.1	0.22	5.6	0.09	2.3	9.0	228.6	10	100
HST0.8-9-XY*	0.75	19.1	0.22	5.6	0.09	2.3	9.0	228.6	10	100
HST1.1-12-5-2Y	1.10	27.9	0.38	9.5	0.12	3.0	12.0	304.8	5	50
HST1.1-12-5Y	1.10	27.9	0.38	9.5	0.12	3.0	12.0	304.8	5	50
HST1.1-48-5-2Y	1.10	27.9	0.38	9.5	0.12	3.0	48.0	1219.2	5	20
HST1.1-48-5Y	1.10	27.9	0.38	9.5	0.12	3.0	48.0	1219.2	5	20
HST1.1-6-3Y	1.10	27.9	0.38	9.5	0.12	3.0	6.0	152.4	3	30
HST1.1-6-X2Y	1.10	27.9	0.38	9.5	0.12	3.0	6.0	152.4	10	100
HST1.1-6-XY	1.10	27.9	0.38	9.5	0.12	3.0	6.0	152.4	10	100
HST1.1-9-2Y	1.10	27.9	0.38	9.5	0.12	3.0	9.0	228.6	2	20
HST1.1-9-X2Y	1.10	27.9	0.38	9.5	0.12	3.0	9.0	228.6	10	100
HST1.1-9-XY	1.10	27.9	0.38	9.5	0.12	3.0	9.0	228.6	10	100
HST1.5-12-1Y	1.50	38.1	0.50	12.7	0.16	4.1	12.0	304.8	1	10
HST1.5-12-5Y	1.50	38.1	0.50	12.7	0.16	4.1	12.0	304.8	5	50
HST1.5-48-5-2Y	1.50	38.1	0.50	12.7	0.16	4.1	48.0	1219.2	5	15
HST1.5-48-5Y	1.50	38.1	0.50	12.7	0.16	4.1	48.0	1219.2	5	15
HST1.5-9-XY	1.50	38.1	0.50	12.7	0.16	4.1	9.0	228.6	10	100
HST2.0-12-2Y	2.00	50.8	0.67	16.9	0.16	4.1	12.0	304.8	2	20
HST2.0-48-2Y	2.00	50.8	0.67	16.9	0.16	4.1	48.0	1219.2	2	8
HST2.0-9-5Y	2.00	50.8	0.67	16.9	0.16	4.1	9.0	228.6	5	50
HST2.7-12-2Y	2.70	68.6	0.87	22.1	0.16	4.1	12.0	304.8	2	20
HST2.7-48-2Y	2.70	68.6	0.87	22.1	0.16	4.1	48.0	1219.2	2	8
HST3.0-12-2	3.00	76.2	1.00	25.4	0.16	4.1	12.0	304.8	2	20
HST3.0-48-2	3.00	76.2	1.00	25.4	0.16	4.1	48.0	1219.2	2	8
HST3.5-12-2Y	3.50	88.9	1.20	30.5	0.16	4.1	12.0	304.8	2	20
HST3.5-48-2Y	3.50	88.9	1.20	30.5	0.16	4.1	48.0	1219.2	2	6

\*Product meets performance requirements of AMS-DTL-23053/15; some dimensions differ from specification.

## Heat Shrink End Caps

- Applications include insulating and protecting wires and cables
- Adhesive lined inner wall seals and provides excellent protection against moisture
- Voltage rating of 600 V
- Shrink ratio: 2.5:1 (HSEC); 3:1 (HSECFR)
- Temperature range: -67°F to 230°F (-55°C to 110°C)
- For wet locations
- Material: Adhesive lined black cross-linked Polyolefin; HSECFR = Flame retardant



HSEC



HSECFR



Part Number	Min. Expanded I.D.		Max. Recovered I.D.		Nominal Recovered Wall Thickness		Cap Length		Std. Pkg. Qty.	Std. Ctn. Qty.
	In.	mm	In.	mm.	In.	mm	In.	mm		
HSEC0.5-X	0.47	11.9	0.18	4.6	0.10	2.5	1.4	35.1	10	100
HSEC0.8-X	0.79	20.1	0.30	7.6	0.10	2.5	2.1	54.1	10	100
HSEC1.0-X	1.02	25.9	0.45	11.4	0.10	2.5	3.2	82.0	10	100
HSEC1.5-5	1.58	40.1	0.68	17.3	0.11	2.8	3.9	98.0	5	50
HSEC2.0-5	2.25	57.2	0.87	22.1	0.15	3.8	5.5	140.2	5	50
HSEC4.0-2	4.14	105.2	1.78	45.2	0.15	3.8	6.9	175.3	2	10

### Heat Shrink End Caps – Flame Retardant

HSECFR0.5-XY	0.51	13.0	0.16	4.1	0.09	2.3	2.5	63.5	10	100
HSECFR0.8-XY	0.75	19.1	0.24	6.1	0.09	2.3	2.5	63.5	10	100
HSECFR1.0-XY	1.10	27.9	0.35	8.9	0.12	3.0	3.0	76.2	10	100
HSECFR1.5-5Y	1.50	38.1	0.47	11.9	0.16	4.1	3.5	88.9	5	50
HSECFR2.0-5Y	2.00	50.8	0.63	16.0	0.16	4.1	3.5	88.9	5	50

A.  
System  
Overview

B1.  
Cable Ties

B2.  
Cable  
Accessories

B3.  
Stainless  
Steel Ties

C1.  
Wiring  
Duct

C2.  
Surface  
Raceway

C3.  
Abrasion  
Protection

C4.  
Cable  
Management

D1.  
Terminals

D2.  
Power  
Connectors

D3.  
Grounding  
Connectors

E1.  
Labeling  
Systems

E2.  
Labels

E3.  
Pre-Printed  
& Write-On  
Markers

E4.  
Permanent  
Identification

E5.  
Lockout/  
Tagout  
& Safety  
Solutions

F.  
Index

A.  
System  
Overview

## Plastic Heat Shrink Tubing Kit Boxes – For Dry Locations

B1.  
Cable Ties



B2.  
Cable  
Accessories

B3.  
Stainless  
Steel Ties

C1.  
Wiring  
Duct

C2.  
Surface  
Raceway

C3.  
Abrasion  
Protection

C4.  
Cable  
Management

D1.  
Terminals

D2.  
Power  
Connectors

D3.  
Grounding  
Connectors

E1.  
Labeling  
Systems

E2.  
Labels

E3.  
Pre-Printed  
& Write-On  
Markers

E4.  
Permanent  
Identification

E5.  
Lockout/  
Tagout/  
& Safety  
Solutions

F.  
Index

Part Number	Part Description	Contents	Std. Pkg. Qty.
KP-HSTT1	Heat shrink kit box – plastic case, various sizes. Black only.	35 ea. of 3/32", 1/8" 21 ea. of 3/16", 1/4" 7 ea. of 3/8", 1/2"	1
KP-HSTT2	Heat shrink kit box – plastic case, various sizes, various colors.	35 ea. (5 ea. color) 3/32", 1/8" 21 ea. (3 ea. color) 3/16", 1/4" 7 ea. (1 ea. color) 3/8", 1/2"	1
KP-HSTTA	Dual Wall Adhesive Lined Thin Wall Heat Shrink: Plastic Kit Box – Black only.	14 ea. 3/16" 12 ea. 1/4" 10 ea. 3/8" 6 ea. 1/2" 3 ea. 3/4" 2 ea. 1"	1



## Heat Shrink Tools and Accessories



Part Number	Part Description	Std. Pkg. Qty.	Std. Ctn. Qty.
HSG-115V-650	Heat gun with stand. Temperature range of 650°F (343°C) to 900°F (482°C) plus stand. (Case and accessories not included).	1	–
HSG-A1	Shrink tube reflector for tubing up to 3/4" inside diameter. Directs heat around tubing to reduce shrink time.	1	10
HSG-A2	Shrink tube reflector for tubing up to 1 1/2" inside diameter. Directs heat around tubing to reduce shrink time.	1	10
HSG-A4	Black polyethylene case stores heat gun, stand, and both accessories.	1	–
HSG-P1	Replacement brush / spring kit.	1	5
HSG-P2	Replacement switch 20 Amp.	1	5
HSG-P3	Replacement bearing kit.	1	5
HSG-P7	Replacement heat element 650°F.	1	–

## Heat Shrink Process Defined

### Extrusion/Material

Various thermoplastic materials that will repeatedly melt and flow, such as polyolefin, PVC, etc., are extruded into tube form. If examined at a molecular level, the material would resemble long thin strands weakly connected at various points by crystalline structure. If left in this state, the performance of the tube would be limited to that of the base material.

### Cross Linking

Cross-linking creates high strength bonds between the molecular strands, in addition to the crystalline bonds. This is done with a high voltage or chemical treatment of the material. The cross-link bonds will not break down with heat; this transforms the material from a thermoplastic to a thermoset material that will not melt and flow. The result is a material with superior electrical and mechanical properties.

### Expansion

The cross-linked tube is heated and the crystalline bonds dissolve, however, the cross-link bonds remain. The tube now is softer and can be expanded. This causes the cross-link bonds to stretch when cooled quickly, the crystalline bonds reform, freezing the tube in the expanded size. The tubing has now completed the manufacturing process.

### Recovery

With the proper type and size of tube selected, the tube is placed over the object to be covered. Heat is now applied. This causes the crystalline bonds to dissolve again and the tube softens. The stretched cross-link bonds now return to their original length and the tube shrinks to the diameter it had when cross-linked, unless it encounters an object larger than this diameter. In this case, it conforms tightly to this object.



Extrusion



Cross-Link



Expansion

A.  
System  
Overview

B1.  
Cable Ties

B2.  
Cable  
Accessories

B3.  
Stainless  
Steel Ties

C1.  
Wiring  
Duct

C2.  
Surface  
Raceway

C3.  
Abrasion  
Protection

C4.  
Cable  
Management

D1.  
Terminals

D2.  
Power  
Connectors

D3.  
Grounding  
Connectors

E1.  
Labeling  
Systems

E2.  
Labels

E3.  
Pre-Printed  
& Write-On  
Markers

E4.  
Permanent  
Identification

E5.  
Lockout/  
Tagout  
& Safety  
Solutions

F.  
Index

A.  
System  
Overview

## Heat Shrink Installation Instructions

B1.  
Cable Ties

### General Instructions

Position heat shrink over the object to be covered. Using a heat gun, soft yellow flame torch, infrared heat source or oven, evenly heat the tubing until it has fully recovered and conforms to the object. Use caution not to char or burn the tubing.

B2.  
Cable  
Accessories

### Special Instructions for HSTTT

TFE Heat Shrink is the most difficult to recover due to its high shrink temperature. TFE shrink tubing must be heated to the gel state 621°F (327°C) to completely recover. This can be recognized when the tubing changes from milky white to clear. Because of the unique characteristics of this material, a controlled temperature oven will achieve the most reliable results – it is difficult to consistently recover this product using a high-temp heat gun or similar heat source. These methods have a tendency to overheat the tube in one area while other areas remain cool.

B3.  
Stainless  
Steel Ties

C1.  
Wiring  
Duct

When recovering onto objects, use a temperature controlled oven set at 660°F – 680°F (349°C – 360°C) for approximately 10 minutes is recommended. It is best to place the product on a fiberglass mat or suspend as opposed to contacting the oven rack. Do NOT heat the product above 700°F (371°C), or degradation damage to the TFE polymer will occur.

C2.  
Surface  
Raceway

### Size Selection for Heat Shrink Tubing

Generally, the largest tube that shrinks down tightly onto an object should be chosen. This allows the heat shrink tubing maximum stress relief and this will yield the longest service life.

C3.  
Abrasion  
Protection

#### Example:

A multi-conductor cable needs to be covered with HSTT Type Dry-Shrink™ Heat Shrink. The area to be covered has a measured outside diameter of .700" (17.8mm). The two possibilities are HSTT75-48-5 and HSTT100-48-5.

C4.  
Cable  
Management

Part Number	Expanded I.D In. (mm)	Recovered I.D. In. (mm)
HSTT75-48-5	.750 (19.1)	.375 (9.5)
HSTT100-48-5	1.00 (25.4)	.500 (12.7)

D1.  
Terminals

D2.  
Power  
Connectors

The proper choice is HSTT100-48-5 since the tube will recover more than HSTT75-48-5. The HSTT75-48-5 will fit over the .700 inch (17.8mm) outside diameter; however, this is not the proper choice since it is smaller than the HSTT100-48-5. In general, heat shrink should recover at least 10% – 20% to reduce stress and yield the longest service life.

D3.  
Grounding  
Connectors

E1.  
Labeling  
Systems

E2.  
Labels

E3.  
Pre-Printed  
& Write-On  
Markers

E4.  
Permanent  
Identification

E5.  
Lockout/  
Tagout  
& Safety  
Solutions

F.  
Index



## Recommended Tubing Size for Common Wire Types Based on Location For Insulated Wire, Non-Insulated Wire, and Insulated Wire with Copper Connectors

### Instructions for Tube Selection:

1) Determine location type.

#### LOCATION:

**DRY:** A location not normally subject to dampness or wetness. A location classified as dry may be temporarily subject to dampness or wetness, as in the case of a building under construction.

**DAMP:** Partially protected locations under canopies, marquees, roofed open porches and like locations, and interior locations subject to moderate degrees of moisture, such as some basements, barns, and cold-storage warehouses.

**WET:** Installations underground or in concrete slabs or masonry in direct contact with the earth, and locations subject to saturation with water or other liquids, such as vehicle washing areas, and locations exposed to weather and unprotected.

- 2) Match wire size to location type under required application – insulated wire, non-insulated wire, or insulated wire with copper connectors.
- 3) Read corresponding part number.
- 4) Part numbers with “-Y” are packages containing 6 inch pieces. Part numbers with “-48” are 48 inch pieces.
- 5) Part numbers shown below are for black heat shrink.

Wire Size	Insulated Wire with Copper Connector			Uninsulated Wire		
	Dry-Shrink™	Damp-Shrink™	Wet-Shrink™	Dry-Shrink™	Damp-Shrink™	Wet-Shrink™
24	HSTT09-Y	HSTTA19-Y	—	—	—	—
22	HSTT09-Y	HSTTA19-Y	—	HSTT05-Y	—	—
20	HSTT12-Y	HSTTA19-Y	—	HSTT05-Y	—	—
18	HSTT12-Y	HSTTA19-Y	—	HSTT06-Y	—	—
16	HSTT19-Y	HSTTA25-Y	—	HSTT09-Y	—	—
14	HSTT19-Y	HSTTA25-Y	—	HSTT09-Y	HSTTA19-Y	—
12	HSTT25-Y	HSTTA38-Y	—	HSTT012-Y	HSTTA19-Y	—
10	HSTT25-Y	HSTTA38-Y	HST0.4-48-5Y	HSTT19-Y	HSTTA25-Y	—
8	HSTT38-Y	HSTTA50-Y	HST0.4-48-5Y	HSTT19-Y	HSTTA25-Y	—
6	HSTT50-Y	HSTTA50-Y	HST0.8-48-5Y	HSTT25-Y	HSTTA38-Y	HST0.4-48-5Y
4	HSTT50-Y	HSTTA75-Y	HST0.8-48-5Y	HSTT38-Y	HSTTA50-Y	HST0.4-48-5Y
3	HSTT50-Y	HSTTA75-Y	HST0.8-48-5Y	HSTT38-Y	HSTTA50-Y	HST0.4-48-5Y
2	HSTT75-Y	HSTTA100-Y	HST1.1-48-5Y	HSTT38-Y	HSTTA50-Y	HST0.8-48-5Y
1	HSTT75-Y	HSTTA100-Y	HST1.1-48-5Y	HSTT50-Y	HSTTA75-Y	HST0.8-48-5Y
1/0	HSTT75-Y	HSTTA100-Y	HST1.1-48-5Y	HSTT50-Y	HSTTA75-Y	HST0.8-48-5Y
2/0	HSTT100-Y	HSTTA150-Y	HST1.5-48-5Y	HSTT50-Y	HSTTA100-Y	HST0.8-48-5Y
3/0	HSTT100-Y	HSTTA150-Y	HST1.5-48-5Y	HSTT75-Y	HSTTA100-Y	HST1.1-48-5Y
4/0	HSTT100-Y	HSTTA150-Y	HST1.5-48-5Y	HSTT75-Y	HSTTA100-Y	HST1.1-48-5Y
250	HSTT100-Y	HSTTA150-Y	HST2.0-48-2Y	HSTT100-Y	HSTTA100-Y	HST1.1-48-5Y
300	HSTT150-48-5	HSTTA150-Y	HST2.0-48-2Y	HSTT100-Y	HSTTA150-Y	HST1.5-48-5Y
350	HSTT150-48-5	HSTTA150-Y	HST2.0-48-2Y	HSTT100-Y	HSTTA150-Y	HST1.5-48-5Y
400	HSTT150-48-5	HSTTA150-Y	HST2.0-48-2Y	HSTT100-Y	HSTTA150-Y	HST1.5-48-5Y
500	HSTT150-48-5	HSTTA150-Y	HST2.0-48-2Y	HSTT100-Y	HSTTA150-Y	HST1.5-48-5Y
600	HSTT200-48-5	HSTTA150-Y	HST2.0-48-2Y	HSTT150-48-5	HSTTA150-Y	HST2.0-48-2Y
700	HSTT200-48-5	HSTTA150-Y	HST2.0-48-2Y	HSTT150-48-5	HSTTA150-Y	HST2.0-48-2Y
750	HSTT200-48-5	HSTTA150-Y	HST3.0-48-2Y	HSTT150-48-5	HSTTA150-Y	HST2.0-48-2Y
800	HSTT200-48-5	HSTTA150-Y	HST3.0-48-2Y	HSTT150-48-5	HSTTA150-Y	HST2.0-48-2Y
900	HSTT200-48-5	—	HST3.0-48-2Y	HSTT150-48-5	HSTTA150-Y	HST2.0-48-2Y
1000	HSTT200-48-5	—	HST3.0-48-2Y	HSTT150-48-5	HSTTA150-Y	HST2.0-48-2Y
1250	HSTT200-48-2	—	HST3.0-48-2Y	HSTT200-48-5	HSTTA150-Y	HST2.0-48-2Y
1500	HSTT300-48-2	—	HST3.0-48-2Y	HSTT200-48-5	—	HST2.0-48-2Y
1750	HSTT300-48-2	—	HST3.0-48-2Y	HSTT200-48-5	—	HST2.0-48-2Y
2000	HSTT300-48-2	—	HST3.0-48-2Y	HSTT200-48-5	—	HST2.0-48-2Y

Sizing information is based on the following wire types: MTW, THHN, THWN, TFN, THW, TW, TF, RHW, RH, RHH and UL 1015.

THHN is the most common wire type.

Portions reprinted with permission from NFPA, the National Electrical Code\* Handbook, Copyright 1996, National Fire Protection Association, Quincy, MA 02269.

\*All rights reserved. National Electrical Code and NEC are registered trademarks of the National Fire Protection Association, Inc., Quincy, MA 02269.

A.  
System  
Overview

B1.  
Cable Ties

B2.  
Cable  
Accessories

B3.  
Stainless  
Steel Ties

C1.  
Wiring  
Duct

C2.  
Surface  
Raceway

C3.  
Abrasion  
Protection

C4.  
Cable  
Management

D1.  
Terminals

D2.  
Power  
Connectors

D3.  
Grounding  
Connectors

E1.  
Labeling  
Systems

E2.  
Labels

E3.  
Pre-Printed  
& Write-On  
Markers

E4.  
Permanent  
Identification

E5.  
Lockout/  
Tagout  
& Safety  
Solutions

F.  
Index

## Dry-Shrink™, Damp-Shrink™, and Wet-Shrink™ Heat Shrink Tubing

### Technical Data

#### General Information

Product Type	Typical Applications	Specific Gravity	Flammability	Water Absorption	Dielectric Strength
<b>HSTT</b>	Economical and easy way to insulate, protect, harness and identify electrical and electronic components in a wide variety of applications. Black is U.V. Resistant. Suitable for use in dry locations.	Class 1, 1.35 Class 2, 1.0 ASTM D792	Class 1 Self Extinguishing ASTM D2671 Procedure B	.5% MAX. ASTM D570	500 V/MIL. (19.7 Kv/mm) min. ASTM D2671
<b>HSTTV</b>	Use where UL recognition with VW-1 rating is required. Use where the wire component cannot tolerate higher shrink temperatures, reduces application time to insulate, protect, identify, etc. Black is U.V. Resistant. Suitable for use in dry locations.	1.50 ASTM D792	VW-1 per UL 224	.5% MAX. ASTM D570	500 V/MIL. (19.7 Kv/mm) min. ASTM D2671
<b>HSTTP</b>	Ripple free conformance around sharp bends as in appliance handles and bus bars. Good cut through and solder-iron resistance. Black is U.V. Resistant. Suitable for use in dry locations.	1.35 MAX.	VW-1 per UL 224	1.0% MAX. ASTM D570	400 V/MIL. (15.8 Kv/mm) min. ASTM D2671
<b>HSTTPN</b>	Crystal clear product that is excellent for protecting wire and cable markers and continuous inspection of splices. Suitable for use in dry locations.	N/A	VW-1 per UL 224	1.0% MAX. ASTM D570	400 V/MIL. (15.8 Kv/mm) min. ASTM D2671
<b>HSTTN</b>	Insulation and abrasion resistance, extensive military uses on vehicles and ship-board. Excellent chemical resistance especially to fuels and oils. Black is U.V. Resistant. Suitable for use in dry locations.	1.30 ASTM D792	Self Extinguishing ASTM D876	1.0% MAX. ASTM D570	300 V/MIL. (11.8 Kv/mm) min. ASTM D2671
<b>HSTTT</b>	High insulation and abrasion resistance. High temperature, strain relief, resists corrosive atmosphere, self lubrication and non-wetting. Can be used with fiber optics and as a strain relief for high density connectors. U.V. Resistant. Suitable for use in dry locations.	2.2 MAX. ASTM D792	VW-1 per UL 224	.01% MAX. ASTM D570	800 V/MIL. (31.5 Kv/mm) min. ASTM D2671
<b>HSTTK</b>	Protection and strain relief for wires or connectors in a high temperature or solvent rich environment. Insulation of heater leads. Suitable for use in dry locations.	1.8 MAX. ASTM D792	VW-1 per UL 224	.5% MAX. ASTM D570	Size to (12.7mm) 800 V/MIL. (31.5 Kv/mm) min Over (12.7mm) 600 V/MIL. (23.6 Kv/mm) min ASTM D2671
<b>HSTTVA</b>	Seals and protects components from moisture and corrosion. Use where a flexible tubing is needed. Suitable for damp locations.	N/A	Self Extinguishing ASTM D2671 Procedure B	.5% MAX. ASTM D570	500 V/MIL. (19.7 Kv/mm) min. ASTM D2671
<b>HSTTA</b>	Environmentally seals and protects components. The 3:1 shrink ratio is a benefit when working with connector to cable transitions. Suitable for damp locations.	N/A	Self Extinguishing ASTM D2671 Procedure B	1.0% MAX. ASTM D570	300 V/MIL. (11.8 Kv/mm) min. ASTM D2671
<b>HSTT4A</b>	Seals and protects components from moisture and corrosion. The 4:1 shrink ratio is a benefit when working with large transitions. Use where a flexible tubing is needed. Suitable for damp locations.	N/A	VW-1 per UL 224	1.0% MAX. ASTM D570	500 V/MIL. (19.7 Kv/mm) min. ASTM D2671
<b>HSTTRA</b>	Environmentally seals and protects components forming a rugged and heavy duty covering. The 2.5:1 shrink ratio is a benefit when working with connector to cable transitions. Suitable for damp locations.	N/A	N/A	.5% MAX. ASTM D570	500 V/MIL. (19.7 Kv/mm) min. ASTM D2671
<b>HST</b>	Seals and protects electrical connections and splices above or below ground, 3:1 shrink ratio. Suitable for outdoor and wet locations.	1.2 MAX.	VW-1 per UL 224	.5% MAX. ASTM D570	200 V/MIL. (7.9 Kv/mm) min. ASTM D2671

## CABLE MANAGEMENT

Panduit offers a complete line of cable management products and accessories to route and secure cable. These products are an essential part of a clean, professional installation, which help improve quality and increase system performance.



- Maintains bend radius control and cable performance while bundling and securing cable to prevent snags and stress from over bending
- Provides attractive installations and allows for easier moves, adds, and changes while reducing stress on cable
- Organizes cable in a variety of applications where depth is critical or space is limited

Panduit solutions provide the options necessary to handle the most demanding installations while providing the flexibility to facilitate system upgrades now and in the future.

A.  
System  
Overview

B1.  
Cable Ties

B2.  
Cable  
Accessories

B3.  
Stainless  
Steel Ties

C1.  
Wiring  
Duct

C2.  
Surface  
Raceway

C3.  
Abrasion  
Protection

C4.  
Cable  
Management

D1.  
Terminals

D2.  
Power  
Connectors

D3.  
Grounding  
Connectors

E1.  
Labeling  
Systems

E2.  
Labels

E3.  
Pre-Printed  
& Write-On  
Markers

E4.  
Permanent  
Identification

E5.  
Lockout/  
Tagout  
& Safety  
Solutions

F.  
Index

A. System Overview

## Cool Boot™ Raised Floor Assembly PATENTED

B1. Cable Ties

B2. Cable Accessories

B3. Stainless Steel Ties

C1. Wiring Duct

C2. Surface Raceway

C3. Abrasion Protection

C4. Cable Management

- Patented design with air tight fabric minimizes bypass of air through cutouts in the raised floor to decrease energy costs in hot aisle/cold aisle data center designs
- Ultra-Cinch™ Tie closes top of fabric to prevent air from escaping around cable bundles
- Electrostatic dissipative material provides a pathway to ground reducing the chance of damaging network equipment with electric shock
- Vertical Hook and Loop Cable Tie closure system allows for installation on existing cable bundles
- Horizontal Hook and Loop Cable Tie closure system allows two or more bundles to be separated in existing or new installations

- Flexible polycarbonate outer ring houses fabric to allow user to secure product to raised floor tile; slit allows outer ring to flex so entire cable bundle can be inserted to allow for retrofit installations even when vertical cable managers are already in place
- Low profile polycarbonate outer ring allows compatibility with vertical cable managers
- Self-tapping #6 screws (included) allow a secure fastening method to top of raised floor tile that also provides a pathway to ground
- Color: Black polycarbonate outer ring with navy blue fabric
- Manufactured from flame retardant material



RFG\*X\*SMY

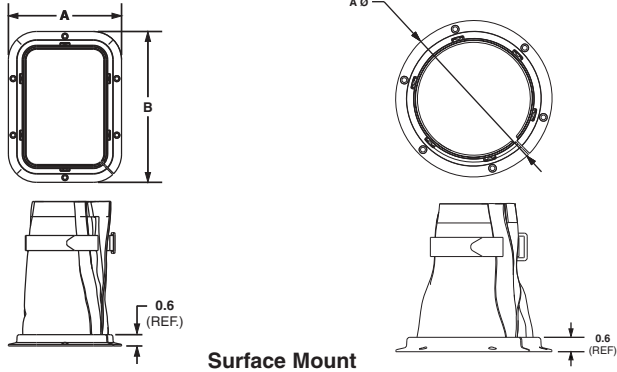

Surface Mount

Part Number	Material	Length		Width		Diameter		Max. Bundle Diameter		Std. Pkg. Qty.	Std. Ctn. Qty.
		In.	mm	In.	mm	In.	mm	In.	mm		
<b>Surface Mount</b>											
<b>RFG6X8SMY</b>	Flame Retardant Electrostatic Dissipative Polycarbonate with an Electrostatic Dissipative Fabric	8.0	203.2	6.0	152.4	—	—	4.2 x 6.2	106.7 x 157.4	1	10
<b>RFG8X8SMY</b>	Flame Retardant Electrostatic Dissipative Polycarbonate with an Electrostatic Dissipative Fabric	8.0	203.2	8.0	203.2	—	—	6.2 x 6.2	157.4 x 157.4	1	10
<b>RFG10X8SMY</b>	Flame Retardant Electrostatic Dissipative Polycarbonate with an Electrostatic Dissipative Fabric	8.0	203.2	10.0	254.0	—	—	8.2 x 6.2	208.3 x 157.4	1	10
<b>RFG12X4SMY</b>	Flame Retardant Electrostatic Dissipative Polycarbonate with an Electrostatic Dissipative Fabric	4.0	101.6	12.0	304.8	—	—	10.2 x 2.2	259.1 x 55.9	1	10
<b>RFG12X8SMY</b>	Flame Retardant Electrostatic Dissipative Polycarbonate with an Electrostatic Dissipative Fabric	8.0	203.2	12.0	304.8	—	—	10.2 x 6.2	259.1 x 157.4	1	10
<b>RFG3DSMY</b>	Flame Retardant Electrostatic Dissipative Polycarbonate with an Electrostatic Dissipative Fabric	—	—	—	—	4.5	114.3	2.7	68.6	1	10
<b>RFG5DSMY</b>	Flame Retardant Electrostatic Dissipative Polycarbonate with an Electrostatic Dissipative Fabric	—	—	—	—	6.5	165.1	4.7	119.4	1	10

Product complies with Article 645 Section 5(D)(4) of the 2005 National Electrical Code.  
 Compatible with NetRunner™ and PatchRunner™ Cable Managers, and Panduit Net-Access™ and NetServ™ Cabinets to create a complete cable management system.

\*Integral products include a flexible sub-grommet to prevent damage to cable from sharp edges of cut floor tile.

## Cool Boot™ Raised Floor Assembly (continued)



RFG\*X\*Y

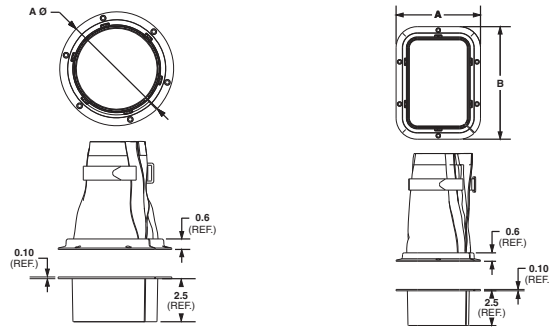

Integral Mount

Part Number	Material	Length		Width		Diameter		Max. Bundle Diameter		Std. Pkg. Qty.	Std. Ctn. Qty.
		In.	mm	In.	mm	In.	mm	In.	mm		
<b>Integral Mount*</b>											
<b>RFG6X8Y</b>	Flame Retardant Electrostatic Dissipative Polycarbonate with an Electrostatic Dissipative Fabric and Thermoplastic Elastomer	8.0	203.2	6.0	152.4	—	—	4.2 x 6.2	106.7 x 157.4	1	10
<b>RFG8X8Y</b>	Flame Retardant Electrostatic Dissipative Polycarbonate with an Electrostatic Dissipative Fabric and Thermoplastic Elastomer	8.0	203.2	8.0	203.2	—	—	6.2 x 6.2	157.4 x 157.4	1	10
<b>RFG10X8Y</b>	Flame Retardant Electrostatic Dissipative Polycarbonate with an Electrostatic Dissipative Fabric and Thermoplastic Elastomer	8.0	203.2	10.0	254.0	—	—	8.2 x 6.2	208.3 x 157.4	1	10
<b>RFG12X4Y</b>	Flame Retardant Electrostatic Dissipative Polycarbonate with an Electrostatic Dissipative Fabric and Thermoplastic Elastomer	4.0	101.6	12.0	304.8	—	—	10.2 x 2.2	259.1 x 55.9	1	10
<b>RFG12X8Y</b>	Flame Retardant Electrostatic Dissipative Polycarbonate with an Electrostatic Dissipative Fabric and Thermoplastic Elastomer	8.0	203.2	12.0	304.8	—	—	10.2 x 6.2	259.1 x 157.4	1	10
<b>RFG3DY</b>	Flame Retardant Electrostatic Dissipative Polycarbonate with an Electrostatic Dissipative Fabric and Thermoplastic Elastomer	—	—	—	—	4.5	114.3	3.0	68.6	1	10
<b>RFG5DY</b>	Flame Retardant Electrostatic Dissipative Polycarbonate with an Electrostatic Dissipative Fabric and Thermoplastic Elastomer	—	—	—	—	6.5	165.1	4.7	119.4	1	10

Product complies with Article 645 Section 5(D)(4) of the 2005 National Electrical Code.

Compatible with NetRunner™ and PatchRunner™ Cable Managers, and Panduit Net-Access™ and NetServ™ Cabinets to create a complete cable management system.

\*Integral products include a flexible sub-grommet to prevent damage to cable from sharp edges of cut floor tile.

A. System Overview

B1. Cable Ties

B2. Cable Accessories

B3. Stainless Steel Ties

C1. Wiring Duct

C2. Surface Raceway

C3. Abrasion Protection

C4. Cable Management

D1. Terminals

D2. Power Connectors

D3. Grounding Connectors

E1. Labeling Systems

E2. Labels

E3. Pre-Printed & Write-On Markers

E4. Permanent Identification

E5. Lockout/Tagout & Safety Solutions

F. Index

A. System Overview



## J-Pro™ Cable Support System PATENTED

B1. Cable Ties

B2. Cable Accessories

B3. Stainless Steel Ties

C1. Wiring Duct

C2. Surface Raceway

C3. Abrasion Protection

C4. Cable Management

D1. Terminals

D2. Power Connectors

D3. Grounding Connectors

E1. Labeling Systems

E2. Labels

E3. Pre-Printed & Write-On Markers

E4. Permanent Identification

E5. Lockout/Tagout & Safety Solutions

F. Index

- Patented design provides complete horizontal and vertical 1" (25.4mm) bend radius control that helps prevent degradation of cable performance
- UL 2043 and CAN/ULC S102.2 listed and suitable for use in air handling spaces
- Pre-rieveted assemblies allow for attachment to walls, ceilings, beams, threaded rods, drop wires and underfloor supports to meet requirements of a variety of applications

- Wide cable support base prevents pinch points that could cause damage to cables
- Cable tie channel allows user to easily install 3/4" Tak-Ty® Cable Ties to retain cable bundle
- Durable non-metallic J Hook materials provide the ability to manage and support a large number of cables
- Standard product is black. For color options see page C4.7



JP2W-L20



JP2WP-L20



JP2CM-L20



JP2DW-L20

Part Number*	Part Description	Max. Bundle Capacity		Max. Cable Capacity			Std. Pkg. Qty.
		In.	mm	Cat. 6A (.310")	Cat. 6 (.236")	Cat. 5e (.193")	
<b>Wall Mount</b>							
<b>JP75W-L20</b>	J Hook for wall mount applications. One 1/4" (M6) mounting hole for user supplied screw.	0.75	19.0	4	8	12	50
<b>JP131W-L20</b>		1.31	33.3	14	28	40	50
<b>JP2W-L20</b>		2.00	50.8	30	50	70	50
<b>JP4W-X20</b>		4.00	101.6	115	210	280	10
<b>Wall Mount with Bracket</b>							
<b>JP75WP-L20</b>	J Hook for powder actuated installation on walls. One 5/32" (M4) mounting hole for user supplied fasteners.	0.75	19.0	4	8	12	50
<b>JP131WP-L20</b>		1.31	33.3	14	28	40	50
<b>JP2WP-L20</b>		2.00	50.8	30	50	70	50
<b>JP4WP-X20</b>		4.00	101.6	115	210	280	10
<b>Ceiling Mount</b>							
<b>JP75CM-L20</b>	J Hook with ceiling mount bracket that has one 3/16" (M5), 1/4" (M6), and 3/8" (M10) mounting hole.	0.75	19.0	4	8	12	50
<b>JP131CM-L20</b>		1.31	33.3	14	28	40	50
<b>JP2CM-L20</b>		2.00	50.8	30	50	70	50
<b>JP4CM-X20</b>		4.00	101.6	115	210	280	10
<b>Drop Wire and Threaded Rod Clip</b>							
<b>JP75DW-L20</b>	J Hook with clip for use with #12 wire, threaded rod up to 1/4" (6.4mm) in diameter, or 1/8" – 1/4" (3.2mm – 6.4mm) thick flanges.	0.75	19.0	4	8	12	50
<b>JP131DW-L20</b>		1.31	33.3	14	28	40	50
<b>JP2DW-L20</b>		2.00	50.8	30	50	70	50

\*Suitable for use in air handling spaces in accordance with Sec. 300-22(c) and (d) of the National Electrical Code. JP4 family of parts suitable for use in single unit configurations. Listed in accordance with CAN/ULC S102.2 when mounted as single units or in pairs. Minimum spacing of 4' (1220mm) required between mount points. (Flame spread rating = 0, Smoke developed classification = 30)



## J-Pro™ Cable Support System (continued)



JP2SBC50R-L20



JP2SBC50-L20



JP2SBC87R-L20



JP2SBC87R-L20



JP2HBC25R-L20

JP2HBC50R-L20

JP2HBC75R-L20

Part Number*	Part Description	Max. Bundle Capacity		Max. Cable Capacity			Std. Pkg. Qty.
		In.	mm	Cat 6A (.310")	Cat 6 (.236")	Cat 5e (.193")	
<b>Screw-On Beam Clamps</b>							
JP75SBC50-L20	J Hook with screw-on beam clamp for use with flanges up to 1/2" (12.7mm) thick.	0.75	19.0	4	8	12	50
JP131SBC50-L20		1.31	33.3	14	28	40	50
JP2SBC50-L20		2.00	50.8	30	50	70	50
JP4SBC50-X20		4.00	101.6	115	210	280	10
JP75SBC50R-L20	J Hook with screw-on beam clamp for use with flanges up to 1/2" (12.7mm) thick. Rotates 360 degrees.	0.75	19.0	4	8	12	50
JP131SBC50R-L20		1.31	33.3	14	28	40	50
JP2SBC50R-L20		2.00	50.8	30	50	70	50
JP4SBC50R-X20		4.00	101.6	115	210	280	10
JP75SBC87-L20	J Hook with screw-on beam clamp for use with flanges up to 3/4" (19.1mm) thick.	0.75	19.0	4	8	12	50
JP131SBC87-L20		1.31	33.3	14	28	40	50
JP2SBC87-L20		2.00	50.8	30	50	70	50
JP4SBC87-X20		4.00	101.6	115	210	280	10
JP75SBC87R-L20	J Hook with screw-on beam clamp for use with flanges up to 3/4" (19.1mm) thick. Rotates 360 degrees.	0.75	19.0	4	8	12	50
JP131SBC87R-L20		1.31	33.3	14	28	40	50
JP2SBC87R-L20		2.00	50.8	30	50	70	50
JP4SBC87R-X20		4.00	101.6	115	210	280	10
<b>Hammer-On Beam Clamps</b>							
JP75HBC25R-L20	J Hook with hammer-on beam clamp for use with flanges 1/8" – 1/4" (3.2mm – 6.4mm) thick. Rotates 360 degrees.	0.75	19.0	4	8	12	50
JP131HBC25R-L20		1.31	33.3	14	28	40	50
JP2HBC25R-L20		2.00	50.8	30	50	70	50
JP4HBC25R-X20		4.00	101.6	115	210	280	10
JP75HBC50R-L20	J Hook with hammer-on beam clamp for use with flanges 5/16" – 1/2" (7.9mm – 12.7mm) thick. Rotates 360 degrees.	0.75	19.0	4	8	12	50
JP131HBC50R-L20		1.31	33.3	14	28	40	50
JP2HBC50R-L20		2.00	50.8	30	50	70	50
JP4HBC50R-X20		4.00	101.6	115	210	280	10
JP75HBC75R-L20	J Hook with hammer-on beam clamp for use with flanges 9/16" – 3/4" (14.3mm – 19.1mm) thick. Rotates 360 degrees.	0.75	19.0	4	8	12	50
JP131HBC75R-L20		1.31	33.3	14	28	40	50
JP2HBC75R-L20		2.00	50.8	30	50	70	50
JP4HBC75R-X20		4.00	101.6	115	210	280	10

\*Suitable for use in air handling spaces in accordance with Sec. 300-22(c) and (d) of the National Electrical Code. JP4 family of parts suitable for use in single unit configurations. Listed in accordance with CAN/ULC S102.2 when mounted as single units or in pairs. Minimum spacing of 4' (1220mm) required between mount points. (Flame spread rating = 0, Smoke developed classification = 30)

Table continues on page C4.6

A. System Overview

B1. Cable Ties

B2. Cable Accessories

B3. Stainless Steel Ties

C1. Wiring Duct

C2. Surface Raceway

C3. Abrasion Protection

C4. Cable Management

D1. Terminals

D2. Power Connectors

D3. Grounding Connectors

E1. Labeling Systems

E2. Labels

E3. Pre-Printed & Write-On Markers

E4. Permanent Identification

E5. Lockout/Tagout & Safety Solutions

F. Index

A. System Overview



## J-Pro™ Cable Support System (continued)

B1. Cable Ties

B2. Cable Accessories

B3. Stainless Steel Ties

C1. Wiring Duct

C2. Surface Raceway

C3. Abrasion Protection

C4. Cable Management

D1. Terminals

D2. Power Connectors

D3. Grounding Connectors

E1. Labeling Systems

E2. Labels

E3. Pre-Printed & Write-On Markers

E4. Permanent Identification

E5. Lockout/Tagout & Safety Solutions

F. Index



**JP2ZP-L20**



**JP2CP-L20**



**JP2UF100-L20**

Part Number*	Part Description	Max. Bundle Capacity		Max. Cable Capacity			Std. Pkg. Qty.
		In.	mm	Cat. 6A (.310")	Cat. 6 (.236")	Cat. 5e (.193")	
<b>Z-Purlin Clips</b>							
<b>JP75ZP-L20</b>	J Hook with z-purlin clip for use with angled flanges up to 1/4" (6.4mm) thick.	0.75	19.0	4	8	12	50
<b>JP131ZP-L20</b>		1.31	33.3	14	28	40	50
<b>JP2ZP-L20</b>		2.00	50.8	30	50	70	50
<b>JP4ZP-X20</b>		4.00	101.6	115	210	280	10
<b>C-Purlin Clips</b>							
<b>JP75CP-L20</b>	J Hook with c-purlin clip for use with vertical flanges up to 1/4" (6.4mm) thick.	0.75	19.0	4	8	12	50
<b>JP131CP-L20</b>		1.31	33.3	14	28	40	50
<b>JP2CP-L20</b>		2.00	50.8	30	50	70	50
<b>JP4CP-X20</b>		4.00	101.6	115	210	280	10
<b>Underfloor Pedestal Support Clamp</b>							
<b>JP75UF100-L20</b>	J Hook with underfloor clamp for use with pedestal support 7/8" square or 1 1/8" – 1 3/8" in diameter.	0.75	19.0	4	8	12	50
<b>JP131UF100-L20</b>		1.31	33.3	14	28	40	50
<b>JP2UF100-L20</b>		2.00	50.8	30	50	70	50
<b>JP4UF100-X20</b>		4.00	101.6	115	210	280	10

\*Suitable for use in air handling spaces in accordance with Sec. 300-22(c) and (d) of the National Electrical Code. JP4 family of parts suitable for use in single unit configurations. Listed in accordance with CAN/ULC S102.2 when mounted as single units or in pairs. Minimum spacing of 4' (1220mm) required between mount points. (Flame spread rating = 0, Smoke developed classification = 30)



## Color Selection Guide

Base Part Number	Black	Red	Blue	White	Green	Orange
JP75W	-L20	-L2			-L5	-L3
JP75WP	-L20	-L2				
JP75CM	-L20	-L2				
JP75DW	-L20	-L2	-L6			
JP75ZP	-L20					
JP75CP	-L20					
JP75SBC50	-L20					
JP75SBC87	-L20					
JP75SBC50R	-L20	-L2		-L		
JP75SBC87R	-L20					
JP75HBC25R	-L20					
JP75HBC50R	-L20	-L2		-L		
JP75HBC75R	-L20					
JP75UF100	-L20					
JP131W	-L20		-L6		-L5	-L3
JP131WP	-L20					
JP131CM	-L20					
JP131DW	-L20		-L6			
JP131ZP	-L20					
JP131CP	-L20					
JP131SBC50	-L20					
JP131SBC87	-L20					
JP131SBC50R	-L20	-L2		-L		
JP131SBC87R	-L20					
JP131HBC25R	-L20					
JP131HBC50R	-L20	-L2		-L		
JP131HBC75R	-L20					
JP131UF100	-L20					
JP2W	-L20	-L2	-L6	-L	-L5	-L3
JP2WP	-L20		-L6			
JP2CM	-L20	-L2				
JP2DW	-L20	-L2	-L6	-L		
JP2ZP	-L20					
JP2CP	-L20					
JP2SBC50	-L20			-L		
JP2SBC87	-L20					
JP2SBC50R	-L20	-L2		-L		
JP2SBC87R	-L20	-L2				
JP2HBC25R	-L20					
JP2HBC50R	-L20	-L2		-L		
JP2HBC75R	-L20					
JP2UF100	-L20					
JP4W	-X20	-X2	-X6	-X		
JP4WP	-X20	-X2	-X6	-X		
JP4CM	-X20					
JP4ZP	-X20					
JP4CP	-X20					
JP4SBC50	-X20			-X		
JP4SBC87	-X20					
JP4SBC50R	-X20	-X2		-X		
JP4SBC87R	-X20					
JP4HBC25R	-X20					
JP4HBC50R	-X20	-X2		-X		
JP4HBC75R	-X20					
JP4UF100	-X20					

A.  
System  
Overview

B1.  
Cable Ties

B2.  
Cable  
Accessories

B3.  
Stainless  
Steel Ties

C1.  
Wiring  
Duct

C2.  
Surface  
Raceway

C3.  
Abrasion  
Protection

C4.  
Cable  
Management

D1.  
Terminals

D2.  
Power  
Connectors

D3.  
Grounding  
Connectors

E1.  
Labeling  
Systems

E2.  
Labels

E3.  
Pre-Printed  
& Write-On  
Markers

E4.  
Permanent  
Identification

E5.  
Lockout/  
Tagout  
& Safety  
Solutions

F.  
Index

A. System Overview



## J-Mod® Cable Support System PATENTED

B1. Cable Ties

- Modular design allows flexibility to assemble system in multiple configurations
- Unique chaining bracket design creates a strong metal backbone and allows expansion of the system without disturbance of an existing installation

- Brackets allow for attachment to ceilings, beams, threaded rods and drop wires to meet requirements of a variety of applications
- Manufactured from materials that meet UL 2043 and are suitable for use in air handling spaces
- Complete horizontal and vertical 1" bend radius control
- Cables do not come in contact with metal

B2. Cable Accessories



JMJH2W-X20

JMJH2-X20

B3. Stainless Steel Ties

C1. Wiring Duct



JMCB-X

JMCMB25-1-X

C2. Surface Raceway

C3. Abrasion Protection

C4. Cable Management

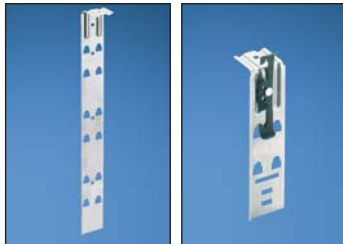

JMCMB25-3-X

JMDWB-1-X

D1. Terminals

D2. Power Connectors



JMDWB-3-X

JMTRB38-1-X

D3. Grounding Connectors

E1. Labeling Systems

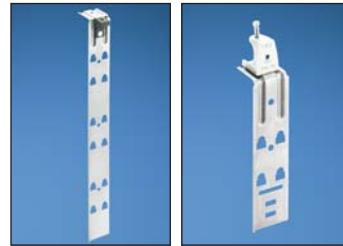

JMTRB38-3-X

JMSBCB87-1-X

E2. Labels

E3. Pre-Printed & Write-On Markers



JMSBCB87-3-X

E4. Permanent Identification

E5. Lockout/Tagout & Safety Solutions

F. Index

Part Number	Part Description	Material*	Std. Pkg. Qty.	Std. Ctn. Qty.
<b>J Hook with Maximum 2" Bundle Capacity</b>				
JMJH2W-X20*	J Hook for wall mount applications only. Two 1/4" (M6) mounting holes for user supplied screws.	Nylon 6.6	10	50
JMJH2-X20*	J Hook with snap lock attachments for use with all brackets listed below.	Nylon 6.6	10	50

### Chaining Bracket

JMCB-X	Chaining bracket to extend J-Mod® capacity one level. Capacity: three levels maximum. For use with all single-level mounting brackets listed below.	Zinc Plated Steel	10	50
--------	---	-------------------	----	----

### Ceiling Mount Brackets

JMCMB25-1-X	Single-level ceiling mount bracket with one 1/4" (M6) mounting hole.	Galvanized Steel	10	50
JMCMB25-3-X**	Three-level ceiling mount bracket with one 1/4" (M6) mounting hole. Maximum capacity of six J Hooks.	Galvanized Steel	10	50

### Drop Wire Brackets

JMDWB-1-X	Single-level drop wire bracket. Attaches to #12 wire or 1/4" (6.4mm) plain rod. Maximum capacity of one J Hook per level.	Galvanized Steel with Metal Attachments	10	50
JMDWB-3-X**	Three-level drop wire bracket. Attaches to #12 wire or 1/4" (6.4mm) plain rod. Maximum capacity of one J Hook for each of three levels. Maximum static load of 40 pounds.	Galvanized Steel with Metal Attachments	10	50

### Threaded Rod Brackets

JMTRB38-1-X	Single-level threaded rod bracket. Accepts 1/4" – 3/8" (6.4mm – 9.5mm) threaded rod.	Galvanized Steel with Metal Attachments	10	50
JMTRB38-3-X**	Three-level threaded rod bracket. Accepts 1/4" – 3/8" (6.4mm – 9.5mm) threaded rod. Maximum capacity of six J Hooks.	Galvanized Steel with Metal Attachments	10	50

### Screw-On Beam Clamp Brackets

JMSBCB87-1-X	Single-level screw-on beam clamp bracket for use with flanges up to 3/4" (19.1mm) thick.	Galvanized Steel with Metal Attachments	10	50
JMSBCB87-3-X**	Three-level screw-on beam clamp bracket for use with flanges up to 3/4" (19.1mm) thick. Maximum capacity of six J Hooks.	Galvanized Steel with Metal Attachments	10	50

\*Suitable for use in air handling spaces and listed in accordance with UL 2043 and CAN/ULC S102.2 when mounted as single units or in pairs. Maximum spacing of 4' (1220mm) required between mount points. (Flame Spread Rating = 0, Smoke Developed Classification = 30)

\*\*Not for use with chaining brackets.

	Maximum Cable Capacity		
	Cat. 6A (.310")	Cat. 6 (.236")	Cat. 5e (.193")
JMJH2W or JMJH2	30	50	70

## Bridle Rings and Fastening Clip

- Multiple diameters, thread sizes, and configurations
- Threaded and non-threaded sizes are compatible with spring steel clip (BR-MPCL) clamp providing a solid securing point for the bridle ring
- Other unique labor saving assemblies differentiate from competition – including pre-assemblies with powder actuated fasteners, toggle wings, and clearance holes for user supplied fasteners



Non-Threaded #8 Wire



Threaded



Wood Screw Thread



Power Actuated Fastener



User Supplied Nail or Fastener



Integrated Toggle Screw

Part Number	Part Description	Std. Pkg. Qty.
<b>Bridle Rings</b>		
BR-.50	Bridle ring, .50" dia., non-threaded #8 wire (.162).	100
BR-.75	Bridle ring, .75" dia., non-threaded #8 wire (.162).	100
BR-1.25	Bridle ring, 1.25" dia., non-threaded #8 wire (.162).	100
BR-2.0	Bridle ring, 2.00" dia., non-threaded #8 wire (.162).	100
BR-.50-10-24	Bridle ring, .50" dia., 10 – 24 threaded.	100
BR-.75-10-24	Bridle ring, .75" dia., 10 – 24 threaded.	100
BR-1.25-10-24	Bridle ring, 1.25" dia., 10 – 24 threaded.	100
BR-2.0-10-24	Bridle ring, 2.00" dia., 10 – 24 threaded.	100
BR-1.25-1/4-20	Bridle ring, 1.25" dia., 1/4 – 20 threaded.	100
BR-2.0-1/4-20	Bridle ring, 2.00" dia., 1/4 – 20 threaded.	100
BR-4.0-1/4-20	Bridle ring, 4.00" dia., 1/4 – 20 threaded.	50
BR-1.25-14WS	Bridle ring, 1.25" dia., 16 wood screw thread.	100
BR-2.0-14WS	Bridle ring, 2.00" dia., 16 wood screw thread.	100
BR-1.5-PAF	Bridle ring, 1.50" dia., with powder actuated fastener.	50
BR-2.0-PAF	Bridle ring, 2.00" (50.8mm) dia., with powder actuated fastener.	50
BR-1.5-SN	Bridle ring, 1.50" dia., user supplied nail or fastener.	100
BR-2.0-SN	Bridle ring, 2.00" dia., user supplied nail or fastener.	100
BR-1.5-TW	Bridle ring, 1.50" dia., with integrated toggle screw.	25
BR-2.0-TW	Bridle ring, 2.00" dia., with integrated toggle screw.	25
<b>General Purpose Clip</b>		
BR-MPCL	Multi-purpose clip; accommodates beam flange from 1/8" to 1/2", standard 1/4 – 20 or #10 – 24 threaded bridle rings, standard drive rings, as well as non-threaded #8 wire bridle rings.	100

## Low Voltage Mounting Brackets

- Choose design styles for new install or retrofit install
- Available in both single and double gang configurations



New Install

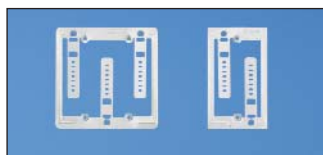

Retrofit Install

Part Number	Part Description	Std. Pkg. Qty.
LV-S-1G	Low voltage integral mounting bracket for new installations, single gang stud bracket.	25
LV-S-2G	Low voltage integral mounting bracket for new installations, double gang stud bracket.	25
LV-W-1G	Low voltage mounting bracket for retrofit installations; single gang box with screws; suitable for wall material thicknesses of 1/2" to 1 1/2".	100
LV-W-2G	Low voltage mounting bracket for retrofit installations; double gang box with screws; suitable for wall material thicknesses of 1/2" to 1 1/2".	50

A. System Overview

B1. Cable Ties

B2. Cable Accessories

B3. Stainless Steel Ties

C1. Wiring Duct

C2. Surface Raceway

C3. Abrasion Protection

C4. Cable Management

D1. Terminals

D2. Power Connectors

D3. Grounding Connectors

E1. Labeling Systems

E2. Labels

E3. Pre-Printed & Write-On Markers

E4. Permanent Identification

E5. Lockout/Tagout & Safety Solutions

F. Index

A. System Overview

## Metal Stud Accessories

B1. Cable Ties

- Metal stud grommets and cable support manager support and protect cable within the building structure

- Metal Stud Punching Tool punches a 1-11/32" (34.1mm) round hole in 25 GA. min. to 20 GA max. mild steel studs; contoured handle; lightweight aluminum head; automatic hole centering on standard width (3.625") studs; replaceable punch and dies; self-stripping design that eliminates punch hang-ups

B2. Cable Accessories

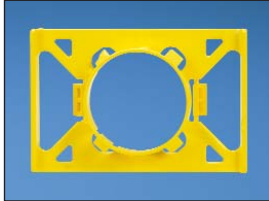

MSG-1.3-C

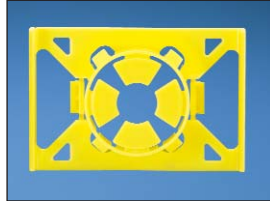

MSGV-1.3-C

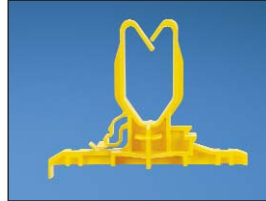

CSM-1.25-C



MSPT-1.3

B3. Stainless Steel Ties

C1. Wiring Duct

C2. Surface Raceway

C3. Abrasion Protection

C4. Cable Management

Part Number	Part Description	Std. Pkg. Qty.	Std. Ctn. Qty.
MSG-1.3-C	Metal stud grommet, 1-11/32" hole.	100	1000
MSGV-1.3-C	Metal stud grommet, 1-11/32" hole, anti-vibration for 1/2" to 1" pipe.	100	1000
CSM-1.25-C	Cable stud manager for 1.25" cable spacing.	100	1000
MSPT-1.3	Metal stud punch tool with contoured handle for increased leverage.	1	—

D1. Terminals



## Conduit Waterfall



D2. Power Connectors

- Helps prevent pinch points and over bending that could cause damage to cable
- Suitable for use in air handling spaces per UL 2043
- UL listed per UL 1565

- Unique patented design allows for use in both new and retrofit applications
- Allows user to install 3/4" Tak-Ty® Cable Ties to provide a method to retain and manage the cable bundle
- Material: Black nylon meets UL 94V-0 specifications

D3. Grounding Connectors



E1. Labeling Systems

E2. Labels

E3. Pre-Printed & Write-On Markers

E4. Permanent Identification

E5. Lockout/Tagout & Safety Solutions

F. Index

Part Number	Part Description	Std. Pkg. Qty.	Std. Ctn. Qty.
<b>CWF400</b>	Provides bend radius control for cables entering/exiting 4" EMT conduit. Secure to conduit without tools utilizing integral thumb screw and captive nut.	1	10

## Waterfall Accessories PATENTED

- Patented bend radius control product
- Product available as a kit (includes base, two wings, and cable ties) or purchased separately
- Easy to install waterfall kit maintains bend radius control in both vertical and horizontal directions to provide a TIA/EIA-568-B compliant installation

- Base attaches to either the rung or stringer on most standard ladder racks for a variety of installations/configurations
- Modular components allow user to custom configure each location where cable management is required
- Material: Black Glass-Filled Nylon 6.6 meets UL 94V-0 specifications



CMW-KIT



CMWB



CMWW

Part Number	Part Description	Color*	Std. Pkg. Qty.	Std. Ctn. Qty.
<b>CMW-KIT</b>	Cable management waterfall kit. Provides bend radius control when transferring cables from standard ladder rack. Kit includes CMWB, two CMWW, and cable ties.	Black	1	10
<b>CMWB</b>	Cable management waterfall base. Used to maintain 1.75" bend radius control vertically when transferring cable off of ladder rack. Mounts to ladder rack rung or stringer with standard cross section cable ties (included).		1	10
<b>CMWW</b>	Cable management waterfall wing. Used in conjunction with CMWB to maintain 1.00" bend radius control horizontally when transferring cable off ladder rack.		1	10

\*For white, include suffix of 10. For example: CMW-KIT10.

## Double Waterfall Accessory

- Double waterfall base attaches to the rung on most standard ladder racks to allow bend radius control for cables coming from either direction
- UL 94V-0 Rated Material

- Easy to install double waterfall base maintains bend radius control in a vertical direction to provide a TIA/EIA-568-B compliant installation



Part Number	Part Description	Color	Std. Pkg. Qty.	Std. Ctn. Qty.
<b>CMW2B</b>	Cable management double waterfall base. Used to maintain 1.75" bend radius control vertically when transferring cable off either side of ladder rack rung. Mounts to ladder rack rung with standard cross section cable ties (included).	Black	1	10

A. System Overview

B1. Cable Ties

B2. Cable Accessories

B3. Stainless Steel Ties

C1. Wiring Duct

C2. Surface Raceway

C3. Abrasion Protection

C4. Cable Management

D1. Terminals

D2. Power Connectors

D3. Grounding Connectors

E1. Labeling Systems

E2. Labels

E3. Pre-Printed & Write-On Markers

E4. Permanent Identification

E5. Lockout/Tagout & Safety Solutions

F. Index

A.  
System  
Overview

## Stackable Cable Rack Spacers **PATENTED**

B1.  
Cable Ties

B2.  
Cable  
Accessories

B3.  
Stainless  
Steel Ties

C1.  
Wiring  
Duct

C2.  
Surface  
Raceway

C3.  
Abrasion  
Protection

C4.  
Cable  
Management

D1.  
Terminals

D2.  
Power  
Connectors

D3.  
Grounding  
Connectors

E1.  
Labeling  
Systems

E2.  
Labels

E3.  
Pre-Printed  
& Write-On  
Markers

E4.  
Permanent  
Identification

E5.  
Lockout/  
Tagout  
& Safety  
Solutions

F.  
Index

- Patented ladder rack accessories
- Separate and support cable and prevent pinch points between the bottom row of cable and the rung as a result of the weight of multiple cable layers applied on top of each other
- Mount to ladder rack with standard cross section cable ties
- Maximize rack space by stacking products for maximum cable capacity
- Provide an alternative to lacing cord by allowing user to secure cable to spacer to prevent movement of cable
- Color: Black



CRS6-X



CRS1-X



CRS4-125-X



CRS1-125-X

Part Number	Part Description	Width		Std. Pkg. Qty.	Std. Ctn. Qty.
		In.	mm		
<b>CRS6-X</b>	Six space stackable cable rack spacer. Accepts cable up to .80" diameter.	5.25	133.4	10	100
<b>CRS1-X</b>	One space stackable cable rack spacer. Use with CRS6 to fill width of ladder rack. Accepts cable up to .80" diameter.	1.13	28.58	10	100
<b>CRS4-125-X</b>	Four space stackable cable rack spacer. Accepts cable up to 1.25" diameter.	5.24	133.1	10	100
<b>CRS1-125-X</b>	One space stackable cable rack spacer. Use with CRS4 to fill width of ladder rack. Accepts cable up to 1.25" diameter.	1.55	39.4	10	100

## Threaded Rod Cover

- Protects cable from abrasion caused by contact with threaded rod
- Material meets UL 94V-0 specifications
- Available in 18" lengths
- Accept 1/2" to 5/8" threaded rod
- For indoor use only
- Material: Gray or Black Polyethylene

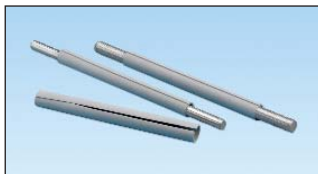

Part Number	Part Description	Std. Pkg. Qty.	Std. Ctn. Qty.
<b>TRC18FR-X8Y</b>	Used to protect cabling from threaded rod. Flexible material with vertical slit allows easy installation. Gray.	10	100
<b>TRC18FR-X20Y</b>	Used to protect cabling from threaded rod. Flexible material with vertical slit allows easy installation. Black.	10	100

## Vertical D-Rings PATENTED

- Patented cable manager ring
- Standard EIA hole spacing allows product to be mounted to any standard rack
- Flexible material allows arm to rotate so entire cable bundle can be inserted and removed

- 1/4" mounting holes allow for a variety of screws to secure the D-ring to a surface
- Material: Black Polycarbonate



Part Number	Part Description	Fiber	ScTP	UTP	Std. Pkg. Qty.	Std. Ctn. Qty.
<b>CMVDR1</b>	Vertical D-ring. Outside dimensions 5.70"L x 2.00"W.	252	48	96	1	10
<b>CMVDR1S</b>	Vertical D-ring. Outside dimensions 3.30"L x 2.00"W.	132	32	52	1	10
<b>CMVDR2</b>	Vertical D-ring. Outside dimensions 5.70"L x 3.00"W.	504	96	192	1	10
<b>CMVDR2S</b>	Vertical D-ring. Outside dimensions 3.30"L x 3.00"W.	252	48	96	1	10
<b>CMVDRC</b>	Center mounted vertical D-ring for routing cables between two adjacent racks. Requires 8.25" spacing between the center lines of the adjacent rack's mounting holes. Outside dimensions 5.60"L x 8.00"W.	1000	200	400	1	10

All product color is black.

## Tak-Ty® Hook & Loop Cable Tie Mounts

- For use with hook and loop cable ties, see page B1.87, B1.88
- Unique cradle design provides maximum stability for cable bundle
- For indoor use only

- Dimensions: 1.10"L x 1.12"W x 0.34"H (27.9mm x 28.4mm x 8.6mm)

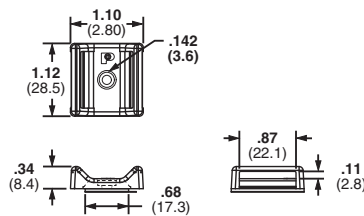

Part Number	Used with Cable Ties‡	Material	Color	Max. Static Load		Mounting Method*	Std. Pkg. Qty.	Std. Ctn. Qty.	
				Lbs.	g				
<b>ABMT-A-C</b>	HLS, HLT, TTS, UCT	Nylon 6.6	Natural	0.38	174	Pre-installed Rubber Adhesive	100	1000	
<b>ABMT-A-C20</b>			Black						
<b>ABMT-S6-C</b>			Natural	—	—		#6 (M3) Screw	100	1000
<b>ABMT-S6-C20</b>			Black						
<b>ABMT-S6-C60</b>		Black	Flame Retardant Nylon 6.6	Natural	100	1000			
<b>ABMT-S6-C69</b>		Natural		100	1000				

‡Cable tie cross section sizes: HLT = Tak-Ty™ Hook & Loop Ties, HLS = Tak-Ty™ Hook & Loop Strip Tie, TTS = Tak-Tape™ Roll, UCT = Ultra-Cinch™ Tie.  
\*For proper selection of adhesives see page B2.53.

A. System Overview

## Flat Pan-Post™ Standoffs

B1. Cable Ties

- Standard EIA hole spacing allows product to be mounted with user supplied screws up to 1/4" diameter
- Organize cables in standard cabinets and racks
- Mounting method: 1/4" (M6) screw
- Use where space is limited
- For indoor use only

B2. Cable Accessories



B3. Stainless Steel Ties

C1. Wiring Duct

C2. Surface Raceway

C3. Abrasion Protection

C4. Cable Management

Part Number	Part Description	Std. Pkg. Qty.	Std. Ctn. Qty.
<b>PPF2S-S25-V</b>	Nylon 6.6 flat Pan-Post™ Standoff. Use with miniature, intermediate, and standard cross section cable ties. Dimensions 5.42"L x 1.50"H x 0.19"W (137.7mm x 38.1mm x 4.8mm).	5	100
<b>PPF2S-S25-V69</b>	Flame retardant nylon 6.6 flat Pan-Post™ Standoff. Use with miniature, intermediate, and standard cross section cable ties. Material meets UL 94V-0 specifications. Dimensions 5.42"L x 1.50"H x 0.19"W (137.7mm x 38.1mm x 4.8mm).	5	100
<b>PPF2SV-S25-V</b>	Nylon 6.6 flat Pan-Post™ Standoff. Use with Tak-Ty® Hook & Loop Cable Ties. Dimensions 5.60"L x 1.62"H x 0.19"W (142.2mm x 41.3mm x 4.8mm).	5	100
<b>PPF2SV-S25-V69</b>	Flame retardant nylon 6.6 flat Pan-Post™ Standoff. Use with Tak-Ty® Hook & Loop Cable Ties. Material meets UL 94V-0 specifications. Dimensions 5.60"L x 1.62"H x 0.19"W (142.2mm x 41.3mm x 4.8mm).	5	100

## Communication Cable Management Kit for Cabinets

D1. Terminals

- Kit of cable management accessories specifically designed for use in a network cabinet or enclosure

D2. Power Connectors

D3. Grounding Connectors

E1. Labeling Systems

E2. Labels

E3. Pre-Printed & Write-On Markers

E4. Permanent Identification

E5. Lockout/Tagout & Safety Solutions

F. Index



Part Number	Part Description	Std. Pkg. Qty.	Std. Ctn. Qty.
<b>CCMKIT1</b>	Kit includes the following: 1 roll 15' (4.6m) length .33" (8.4mm) Tak-Ty® Cable Ties 24 nylon cable ties 12 adhesive backed cable tie mounts 6 push style cable tie mounts 4 vertical wire saddles 8 flat Pan-Post™ Standoffs for use with std. nylon cable ties	1	100
<b>CCMKIT2</b>	Kit includes the following: 1 roll 15' (4.6m) length .75" (19.1mm) Tak-Ty® Cable Ties 12 nylon cable ties 6 adhesive backed cable tie mounts 6 adhesive backed mounts for .75" (19.1mm) Tak-Ty® Cable Ties 6 screw mounts for .75" (19.1mm) Tak-Ty® Cable Ties 4 vertical wire saddles 6 flat Pan-Post™ Standoffs for use with .75" (19.1mm) Tak-Ty® Cable Ties	1	100

Order the number of kits required.



## PAN-TERM® TERMINALS

Panduit® Pan-Term® Terminals are designed and manufactured for fast assembly, and reliable performance. Panduit provides an extensive line of tooling designed specifically to provide optimum performance. As the demand for loose piece terminals increases, it becomes essential to provide a complete system for termination products.



- Funnel entry available on vinyl and nylon insulated terminals and disconnects, speeds insertion, and minimizes turned back wire strands
- Made of electrolytic copper to provide an optimum combination of crimp forming and high conductivity properties to provide superior terminations
- Available in sizes from #26 – 2 AWG and stud hole diameters from #2 – 1/2 inch; non-insulated tubular terminals sizes from #8 – 250 kcmil
- Applicable sizes are UL Listed and CSA Certified, RoHS compliant, ABS (American Bureau of Shipping) Approved, Class IE Nuclear Rated, DFARS 252.225-7014 Compliant and meet Military Specifications MS25036 and MS20659 as noted
- Wide assortment of manual, controlled cycle, battery operated hydraulic and pneumatic crimping tools for reliable connections at the lowest installed cost
- Standard pack terminals are now offered in a new ergonomic, reusable, clear plastic bottle with color-coded flip top lids for easy product selection, dispensing and size identification
- New Convenience Packs offer premium terminal products in a clear, resealable, 20 piece package, designed for quick product selection and identification

Panduit continually provides new designs to meet the application challenges encountered by our customers. Panduit offers a wide assortment of Pan-Term® termination products to meet customer needs at the lowest installed cost.

A.  
System  
Overview

B1.  
Cable Ties

B2.  
Cable  
Accessories

B3.  
Stainless  
Steel Ties

C1.  
Wiring  
Duct

C2.  
Surface  
Raceway

C3.  
Abrasion  
Protection

C4.  
Cable  
Management

D1.  
Terminals

D2.  
Power  
Connectors

D3.  
Grounding  
Connectors

E1.  
Labeling  
Systems

E2.  
Labels

E3.  
Pre-Printed  
& Write-On  
Markers

E4.  
Permanent  
Identification

E5.  
Lockout/  
Tagout  
& Safety  
Solutions

F.  
Index

A. System Overview

## Features and Benefits – Pan-Term® Terminals

B1. Cable Ties

All Panduit terminals feature high quality materials made with electrolytic copper for high conductivity and are tin-plated for corrosion resistance.

B2. Cable Accessories

### Non-Insulated Terminals Type P

Maximum recommended operating temperature 302°F (150°C)

Product markings provide easy identification of wire size



Extended barrel length assures a good quality crimp and makes crimping easier

Internal barrel serrations assure good wire contact and maximum tensile strength

Brazed seam assures crimp reliability

Internally beveled barrel for quick easy wire insertion



UL and CSA rated up to 2000 V per UL 486A/B. Nickel plated terminals rated up to 650°F (343°C) maximum operating temperature.

### Nylon Insulated Terminals with Insulation Grip Sleeve Type PN or PNF

Internal barrel serrations assure good wire contact and maximum tensile strength

Insulation grip sleeve provides a superior insulation crimp for high vibration and high strain relief applications

Funnel entry for faster insertion and lower installed cost



Maximum insulation temperature 221°F (105°C)

Sleeved barrel assures crimp reliability

Color coded insulation identifies wire range



UL and CSA rated up to 600 V per UL 486A/B. Flammability – UL 94V-2/HB. Proprietary blend of UL 94V-2 and UL 94HB flammability rated materials.

D1. Terminals

### Vinyl Insulated Terminals With Insulation Support Type PV

Internal barrel serrations assure good wire contact and maximum tensile strength

Insulation crimp provides insulation support to protect electrical crimp

Funnel entry for faster insertion and lower installed cost



Maximum insulation temperature 221°F (105°C)

Brazed seam assures crimp reliability

Color coded insulation identifies wire range



UL and CSA rated up to 600 V per UL 486A/B. Flammability – UL 94V-0.

### Non-Insulated Seamless Tubular Terminals Type S

Internally beveled barrel for quick easy wire insertion

Seamless tubular barrel provides consistent, high performance, quality crimps

Maximum recommended operating temperature 302°F (150°C)

Inspection hole allows visual inspection for proper wire insertion

Product markings provide easy identification of wire sizes

Double thickness provides a strong ring tongue



UL and CSA rated up to 2000 V per UL 486A/B.

D2. Power Connectors

D3. Grounding Connectors

E1. Labeling Systems

E2. Labels

E3. Pre-Printed & Write-On Markers

E4. Permanent Identification

E5. Lockout/Tagout & Safety Solutions

F. Index



Panduit extensive line of tooling is specifically designed for optimum crimping performance.

See pages D1.83 – D1.89.



Panduit designs and manufactures a full line of labeling products, software and printers to assist you with your labeling requirements.

See pages E1.1 – E2.28.

## Selection Guide – Pan-Term® Ring Terminals

Insulation Material		Style	Feature	Type	Page Number
Ring Terminals	Nylon	Standard Ring	Insulation Grip	PN-R	D1.6
			Funnel Entry	PNF-R	D1.7
			Expanded Insulation	PN-RX	D1.8
			Heavy Duty	PN-HDR	D1.13
		Multiple Stud	Insulation Grip	PN-610R	D1.8
	Vinyl	Standard Ring	Insulation Support	PV-R	D1.9
			Expanded Insulation	PV-RX	D1.10
			Heavy Duty	PV-HDR	D1.14
		Multiple Stud	Large Wire, Insulation Support	PV-R/X	D1.15
			Expanded Insulation, Insulation Support	PV-RX	D1.16
Insulation Support			PV-610R	D1.11	
Heat Shrink	Standard Ring	Heat Shrink Insulation	PH-R	D1.13	
KYNAR® Insulated	Standard Ring	Insulation Grip	PK-R	D1.12	
Non-Insulated	Standard Ring	Brazed Seam	P-R	D1.17	
		High Temp, Brazed Seam	P-RHT	D1.19	
		Heavy Duty	P-HDR	D1.20	
		Large Wire	P-R	D1.20	
	Multiple Stud	Brazed Seam	P-610R	D1.18	
	Tubular Ring	Large Wire, Seamless Barrel	S-R	D1.20	



®KYNAR is a registered trademark of Atofina Chemicals, Inc.

A. System Overview

B1. Cable Ties

B2. Cable Accessories

B3. Stainless Steel Ties

C1. Wiring Duct

C2. Surface Raceway

C3. Abrasion Protection

C4. Cable Management

D1. Terminals

D2. Power Connectors

D3. Grounding Connectors

E1. Labeling Systems

E2. Labels

E3. Pre-Printed & Write-On Markers

E4. Permanent Identification

E5. Lockout/Tagout & Safety Solutions

F. Index

A. System Overview

B1. Cable Ties

B2. Cable Accessories

B3. Stainless Steel Ties

C1. Wiring Duct

C2. Surface Raceway

C3. Abrasion Protection

C4. Cable Management

D1. Terminals

D2. Power Connectors

D3. Grounding Connectors

E1. Labeling Systems

E2. Labels

E3. Pre-Printed & Write-On Markers

E4. Permanent Identification

E5. Lockout/Tagout & Safety Solutions

F. Index

## Selection Guide – Pan-Term® Fork Terminals

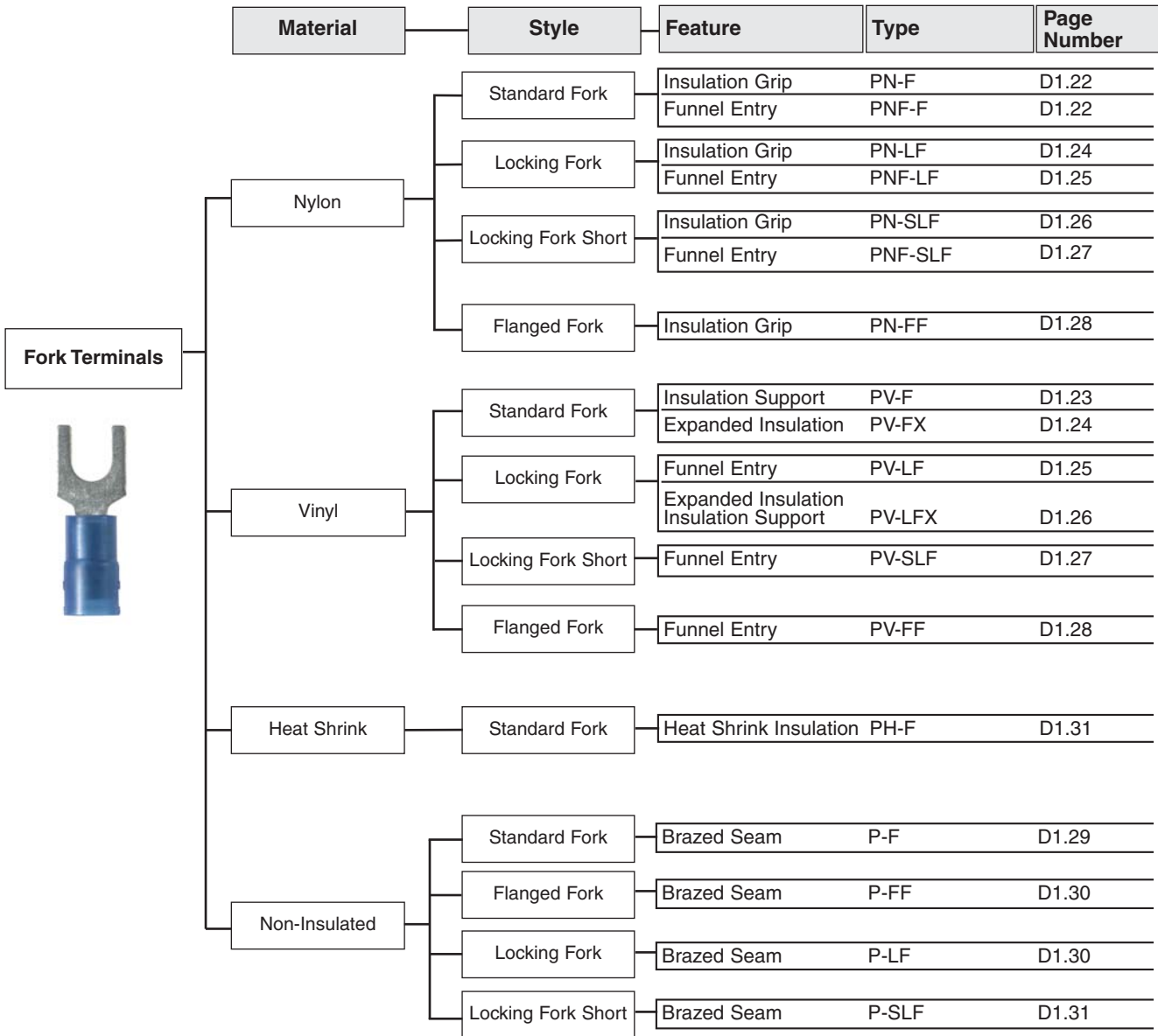

## Part Number System for Pan-Term® Terminals

<b>P</b>	<b>N</b>	<b>14</b>	<b>4</b>	<b>R</b>	<b>X</b>	<b>C</b>
Type	Insulation	Wire Range	Stud Size	Tongue Configuration	Special Configuration	Std. Pkg. Size
P = Seamed Barrel S = Seamless Tubular Barrel	H = Heat Shrink K = KYNAR <sup>®</sup> Insulated N = Nylon Insulated NF = Nylon Insulated Funnel Entry V = Vinyl Insulated = Non-Ins. (leave blank)	22 = #26 – 22 18 = #22 – 18 14 = #16 – 14 12 = #16 – 12 10 = #12 – 10 8 = #8 6 = #6 4 = #4 2 = #2 1 = #1 1/0 = 1/0 2/0 = 2/0 3/0 = 3/0 4/0 = 4/0 250 = 250kcmil	2 = #2 4 = #4 5 = #5 6 = #6 8 = #8 10 = #10 14 = 1/4" 56 = 5/16" 38 = 3/8" 76 = 7/16" 12 = 1/2"	HDR = Heavy Duty Ring F = Fork FF = Flanged Fork LF = Locking Fork R = Ring SLF = Short Locking Fork	HT6 = High Temperature N = Narrow Tongue W = Wide Tongue X = Expanded Insulation = Non-Expanded Insulation (leave blank)	5 = 5 X = 10 E = 20 Q = 25 L = 50 C = 100 T = 200 D = 500 M = 1000

▪KYNAR is a registered trademark of Atofina Chemicals, Inc.

A.  
System  
Overview

B1.  
Cable Ties

B2.  
Cable  
Accessories

B3.  
Stainless  
Steel Ties

C1.  
Wiring  
Duct

C2.  
Surface  
Raceway

C3.  
Abrasion  
Protection

C4.  
Cable  
Management

D1.  
Terminals

D2.  
Power  
Connectors

D3.  
Grounding  
Connectors

E1.  
Labeling  
Systems

E2.  
Labels

E3.  
Pre-Printed  
& Write-On  
Markers

E4.  
Permanent  
Identification

E5.  
Lockout/  
Tagout  
& Safety  
Solutions

F.  
Index

A. System Overview

B1. Cable Ties

B2. Cable Accessories

B3. Stainless Steel Ties

C1. Wiring Duct

C2. Surface Raceway

C3. Abrasion Protection

C4. Cable Management

D1. Terminals

D2. Power Connectors

D3. Grounding Connectors

E1. Labeling Systems

E2. Labels

E3. Pre-Printed & Write-On Markers

E4. Permanent Identification

E5. Lockout/Tagout & Safety Solutions

F. Index



## Ring Terminal, Nylon Insulated

### Type PN-R

- Ring tongue design assures a secure connection in high vibration applications
- Metal insulation grip sleeve crimps to wire insulation, providing protection to the crimp joint during high vibration applications
- Internal barrel serrations assure good wire contact and maximum tensile strength
- UL Flammability UL 94V-2/HB, maximum insulation temperature 221°F (105°C)
- UL and CSA rated up to 600 V per UL 486A/B

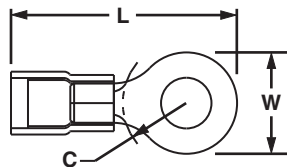

Part Number	Wire Range	Color Code	Stock Thickness (In.)	Max. Ins. (In.)	Stud Size	Figure Dimensions (In.)			Recommended Installation Tool	Std. Pkg. Qty.**	Std. Ctn. Qty.
						L	W	C			
<b>PN22-2R-C*</b>	26 – 22 AWG	Yellow	0.02	0.090	#2	0.69	0.20	0.18	CT-600-A, CT-1525, CT-2500	100	1000
<b>PN22-4R-C*</b>			0.02	0.090	#4	0.69	0.20	0.18			
<b>PN22-6R-C*</b>			0.02	0.090	#6	0.69	0.20	0.18			
<b>PN22-8R-C*</b>			0.02	0.090	#8	0.78	0.26	0.26			
<b>PN22-10R-C*</b>			0.02	0.090	#10	0.78	0.31	0.24		100	1000
<b>PN18-4RN-C^</b>	22 – 18 AWG	Red	0.03	0.145	#4	0.74	0.22	0.18	CT-100A‡, CT-600-A‡, CT-1550‡, CT-1551‡, CT-2500‡	100	500
<b>PN18-4R-C</b>			0.03	0.145	#4	0.80	0.25	0.22			
<b>PN18-6RN-C^</b>			0.03	0.145	#6	0.77	0.22	0.18			
<b>PN18-6R-C^</b>			0.03	0.145	#6	0.80	0.25	0.22			
<b>PN18-8R-C^</b>			0.03	0.145	#8	0.86	0.31	0.25			
<b>PN18-10R-C^</b>			0.03	0.145	#10	0.88	0.31	0.25			
<b>PN18-14R-C^</b>			0.03	0.145	1/4"	1.09	0.45	0.38			
<b>PN18-56R-C^</b>			0.03	0.145	5/16"	1.09	0.46	0.38			
<b>PN18-38R-C^</b>			0.03	0.145	3/8"	1.17	0.53	0.43			
<b>PN18-12R-L</b>			0.03	0.145	1/2"	1.35	0.72	0.53			
<b>PN14-4R-C^</b>	18 – 14 AWG	Blue	0.03	0.162	#4	0.78	0.25	0.20	CT-100A‡, CT-600-A‡, CT-1550‡, CT-1551‡, CT-2500‡	100	500
<b>PN14-6RN-C^</b>			0.03	0.162	#6	0.76	0.25	0.20			
<b>PN14-6R-C^</b>			0.03	0.162	#6	0.85	0.31	0.25			
<b>PN14-8R-C^</b>			0.03	0.162	#8	0.85	0.31	0.25			
<b>PN14-10R-C^</b>			0.03	0.162	#10	0.85	0.31	0.25			
<b>PN14-14R-C^</b>			0.03	0.162	1/4"	1.05	0.46	0.38			
<b>PN14-56R-C^</b>			0.03	0.162	5/16"	1.05	0.46	0.38			
<b>PN14-38R-L^</b>			0.03	0.162	3/8"	1.14	0.53	0.43			
<b>PN14-12R-Q</b>			0.03	0.162	1/2"	1.35	0.72	0.53			
<b>PN10-6R-L^</b>			12 – 10 AWG	Yellow	0.04	0.225	#6	1.06			
<b>PN10-8R-L^</b>	0.04	0.225			#8	1.06	0.37	0.31			
<b>PN10-10R-L^</b>	0.04	0.225			#10	1.06	0.38	0.31			
<b>PN10-14R-L^</b>	0.04	0.225			1/4"	1.21	0.52	0.38			
<b>PN10-56R-L^</b>	0.04	0.225			5/16"	1.21	0.52	0.38			
<b>PN10-38R-L^</b>	0.04	0.225			3/8"	1.29	0.58	0.43			
<b>PN10-12R-Q</b>	0.04	0.225			1/2"	1.47	0.72	0.53			

\*Wire sizes #26-22 AWG, are not UL Listed or CSA Certified.

\*\*Bulk packaging may be available, contact Panduit Customer Service for additional information.

^For military specification cross reference see page D1.96.

‡UL and CSA approved tooling/product combinations. For crimping tool information, see pages D1.83, D1.84, D1.86 and D1.88.



## Ring Terminal, Nylon Insulated – Funnel Entry

### Type PNF-R

- Ring tongue design assures a secure connection in high vibration applications
- Metal insulation grip sleeve crimps to wire insulation, providing protection to the crimp joint during high vibration applications
- Internal barrel serrations assure good wire contact and maximum tensile strength
- UL Flammability UL 94V-2/HB, maximum insulation temperature 221°F (105°C)
- UL and CSA rated up to 600 V per UL 486A/B

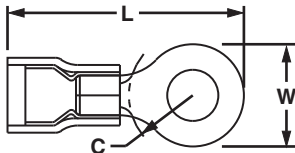
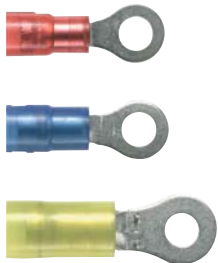

Part Number	Wire Range	Color Code	Stock Thickness (In.)	Max. Ins. (In.)	Stud Size	Figure Dimensions (In.)			Recommended Installation Tool	Std. Pkg. Qty.**	Std. Ctn. Qty.			
						L	W	C						
<b>PNF18-4R-C</b>	22 – 18 AWG	Red	0.03	0.136	#4	0.77	0.25	0.20	CT-100A‡, CT-600-A‡, CT-1550‡, CT-1551‡, CT-2500‡	100	500			
<b>PNF18-6RN-C^</b>			0.03	0.136	#6	0.76	0.22	0.18		100	500			
<b>PNF18-6R-C^</b>			0.03	0.136	#6	0.77	0.25	0.20		100	500			
<b>PNF18-8R-C^</b>			0.03	0.136	#8	0.87	0.31	0.24		100	500			
<b>PNF18-10R-C^</b>			0.03	0.136	#10	0.87	0.32	0.25		100	500			
<b>PNF18-14R-C^</b>			0.03	0.136	1/4"	1.08	0.46	0.38		100	500			
<b>PNF18-56R-C^</b>			0.03	0.136	5/16"	1.08	0.46	0.39		100	500			
<b>PNF18-38R-C^</b>			0.03	0.136	3/8"	1.16	0.53	0.41		100	500			
<b>PNF14-4R-C^</b>			16 – 14 AWG	Blue	0.03	0.162	#4	0.78		0.25	0.18	CT-100A‡, CT-600-A‡, CT-1550‡, CT-1551‡, CT-2500‡	100	500
<b>PNF14-6RN-C^</b>					0.03	0.162	#6	0.78		0.25	0.18		100	500
<b>PNF14-6R-C^</b>	0.03	0.162			#6	0.87	0.31	0.24	100	500				
<b>PNF14-8R-C^</b>	0.03	0.162			#8	0.87	0.31	0.25	100	500				
<b>PNF14-10R-C^</b>	0.03	0.162			#10	0.85	0.31	0.29	100	500				
<b>PNF14-14R-C^</b>	0.03	0.162			1/4"	1.06	0.46	0.40	100	500				
<b>PNF14-56R-C^</b>	0.03	0.162			5/16"	1.06	0.46	0.40	100	500				
<b>PNF14-38R-L^</b>	0.03	0.162			3/8"	1.14	0.53	0.45	50	500				
<b>PNF10-6R-L^</b>	12 – 10 AWG	Yellow			0.04	0.225	#6	1.06	0.37	0.31	CT-100A‡, CT-600-A‡, CT-1550‡, CT-1551‡, CT-2500‡		50	500
<b>PNF10-8R-L^</b>					0.04	0.225	#8	1.06	0.37	0.31			50	500
<b>PNF10-10R-L^</b>			0.04	0.225	#10	1.06	0.37	0.31	50	500				
<b>PNF10-14R-L^</b>			0.04	0.225	1/4"	1.21	0.52	0.38	50	500				
<b>PNF10-56R-L^</b>			0.04	0.225	5/16"	1.21	0.52	0.38	50	500				
<b>PNF10-38R-L^</b>			0.04	0.225	3/8"	1.29	0.58	0.43	50	500				

\*\*Bulk packaging may be available, contact Panduit Customer Service for additional information.

^For military specification cross reference see page D1.96.

‡UL and CSA approved tooling/product combinations. For crimping tool information, see pages D1.83, D1.84, D1.86 and D1.88.

A. System Overview

B1. Cable Ties

B2. Cable Accessories

B3. Stainless Steel Ties

C1. Wiring Duct

C2. Surface Raceway

C3. Abrasion Protection

C4. Cable Management

D1. Terminals

D2. Power Connectors

D3. Grounding Connectors

E1. Labeling Systems

E2. Labels

E3. Pre-Printed & Write-On Markers

E4. Permanent Identification

E5. Lockout/Tagout & Safety Solutions

F. Index

A. System Overview

B1. Cable Ties

B2. Cable Accessories

B3. Stainless Steel Ties

C1. Wiring Duct

C2. Surface Raceway

C3. Abrasion Protection

C4. Cable Management

D1. Terminals

D2. Power Connectors

D3. Grounding Connectors

E1. Labeling Systems

E2. Labels

E3. Pre-Printed & Write-On Markers

E4. Permanent Identification

E5. Lockout/Tagout & Safety Solutions

F. Index



## Ring Terminal, Nylon Insulated – Expanded Insulation

### Type PN-RX

- Expanded wire entry designed to accommodate wire with a larger insulation thickness
- Ring tongue design assures a secure connection in high vibration applications
- Metal insulation grip sleeve crimps to wire insulation, providing protection to the crimp joint during high vibration applications
- Internal barrel serrations assure good wire contact and maximum tensile strength
- UL Flammability UL 94V-2/HB, maximum insulation temperature 221°F (105°C)
- UL and CSA rated up to 600 V per UL 486A/B

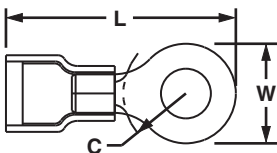

Part Number	Wire Range	Color Code	Stock Thickness (In.)	Max. Ins. (In.)	Stud Size	Figure Dimensions (In.)			Recommended Installation Tool	Std. Pkg. Qty.**	Std. Ctn. Qty.
						L	W	C			
<b>PN14-6RX-C</b>	16 – 14 AWG	Blue	0.03	0.200	#6	0.93	0.31	0.25	CT-100A‡, CT-600-A‡, CT-1550‡, CT-1551‡, CT-2500‡	100	500
<b>PN14-8RX-C</b>			0.03	0.200	#8	0.93	0.31	0.25			
<b>PN14-10RX-C</b>			0.03	0.200	#10	0.93	0.31	0.25			
<b>PN14-14RX-L</b>			0.03	0.200	1/4"	1.13	0.46	0.38			
<b>PN10-6RX-L</b>	12 – 10 AWG	Yellow	0.04	0.265	#6	1.13	0.37	0.33	CT-100A‡, CT-600-A‡, CT-1550‡, CT-1551‡, CT-2500‡	50	500
<b>PN10-8RX-L</b>			0.04	0.265	#8	1.13	0.37	0.33			
<b>PN10-10RX-L</b>			0.04	0.265	#10	1.13	0.37	0.33			
<b>PN10-14RX-L</b>			0.04	0.265	1/4"	1.27	0.52	0.42			
<b>PN10-56RX-L</b>			0.04	0.265	5/16"	1.27	0.52	0.42			
<b>PN10-38RX-L</b>			0.04	0.265	3/8"	1.35	0.58	0.46			

\*\*Bulk packaging may be available, contact Panduit Customer Service for additional information.

‡UL and CSA approved tooling/product combinations. For crimping tool information, see pages D1.83, D1.84, D1.86 and D1.88.



## Multiple Stud Terminal, Nylon Insulated

### Type PN-610R

- Teardrop shaped mounting hole of multiple stud terminals permits use with #6, #8, or #10 size studs
- Ring tongue design assures a secure connection in high vibration applications
- Metal insulation grip sleeve crimps to wire insulation, providing protection to the crimp joint during high vibration applications
- Internal barrel serrations assure good wire contact and maximum tensile strength
- UL Flammability UL 94V-2/HB, maximum insulation temperature 221°F (105°C)
- UL and CSA rated up to 600 V per UL 486A/B

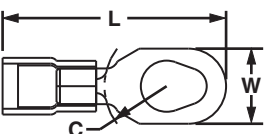

Part Number	Wire Range	Color Code	Stock Thickness (In.)	Max. Ins. (In.)	Stud Size	Figure Dimensions (In.)			Recommended Installation Tool	Std. Pkg. Qty.**	Std. Ctn. Qty.
						L	W	C			
<b>PN18-610R-C</b>	22 – 18 AWG	Red	0.03	0.145	#6, #8, #10	0.95	0.31	0.25	CT-100A‡, CT-600-A‡, CT-1550‡, CT-1551‡, CT-2500‡, CT-400	100	500
<b>PN14-610R-C</b>	16 – 14 AWG	Blue	0.03	0.165		0.95	0.31	0.25			
<b>PN10-610R-L</b>	12 – 10 AWG	Yellow	0.04	0.225		1.17	0.37	0.33			

\*\*Bulk packaging may be available, contact Panduit Customer Service for additional information.

‡UL and CSA approved tooling/product combinations. For crimping tool information, see pages D1.83, D1.84, D1.86 and D1.88.





## Ring Terminal, Vinyl Insulated – Funnel Entry

### Type PV-R

- Insulation support helps to prevent wire damage in bending applications
- Ring tongue design assures a secure connection in high vibration applications
- Brazed seam protects terminal barrel from splitting during the crimp process

- Internal barrel serrations assure good wire contact and maximum tensile strength
- UL Flammability UL 94V-0, maximum insulation temperature 221°F (105°C)
- UL and CSA rated up to 600 V per UL 486A/B

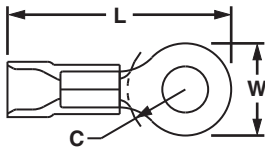

Part Number	Wire Range	Color Code	Stock Thickness (In.)	Max. Ins. (In.)	Stud Size	Figure Dimensions (In.)			Recommended Installation Tool	Std. Pkg. Qty.**	Std. Ctn. Qty.
						L	W	C			
PV22-2R-CY*	26 – 22 AWG	Yellow	0.02	0.110	#2	0.68	0.21	0.18	CT-600-A, CT-1525, CT-2500	100	1000
PV22-4R-CY*			0.02	0.110	#4	0.68	0.21	0.18		100	1000
PV22-6R-CY*			0.02	0.110	#6	0.68	0.21	0.18		100	1000
PV22-8R-CY*			0.02	0.110	#8	0.78	0.26	0.26		100	1000
PV22-10R-CY*			0.02	0.110	#10	0.78	0.32	0.24		100	1000
PV18-4R-CY	22 – 18 AWG	Red	0.03	0.150	#4	0.84	0.25	0.22	CT-100A‡, CT-600-A‡, CT-1550‡, CT-1551‡, CT-2500‡	100	500
PV18-6R-CY			0.03	0.150	#6	0.86	0.25	0.22		100	500
PV18-8R-CY			0.03	0.150	#8	0.91	0.31	0.26		100	500
PV18-10R-CY			0.03	0.150	#10	0.94	0.31	0.27		100	500
PV18-14R-CY			0.03	0.150	1/4"	1.11	0.46	0.37		100	500
PV18-56R-CY			0.03	0.150	5/16"	1.11	0.46	0.39		100	500
PV18-38R-LY			0.03	0.150	3/8"	1.19	0.53	0.42		50	500
PV18-12R-LY	0.03	0.150	1/2"	1.42	0.72	0.53	50	500			
PV14-4R-C	16 – 14 AWG	Blue	0.03	0.170	#4	0.84	0.25	0.19	CT-100A‡, CT-600-A‡, CT-1550‡, CT-1551‡, CT-2500‡	100	500
PV14-6RN-C			0.03	0.170	#6	0.84	0.25	0.19		100	500
PV14-6R-C			0.03	0.170	#6	0.92	0.31	0.25		100	500
PV14-8R-C			0.03	0.170	#8	0.92	0.31	0.25		100	500
PV14-10R-C			0.03	0.170	#10	0.92	0.31	0.25		100	500
PV14-14R-C			0.03	0.170	1/4"	1.12	0.46	0.38		100	500
PV14-56R-C			0.03	0.170	5/16"	1.12	0.46	0.38		100	500
PV14-38R-L	0.03	0.170	3/8"	1.21	0.53	0.43	50	500			
PV14-12R-L	0.03	0.170	1/2"	1.42	0.72	0.53	50	500			
PV10-6R-L	12 – 10 AWG	Yellow	0.04	0.225	#6	1.05	0.31	0.31	CT-100A‡, CT-600-A‡, CT-1550‡, CT-1551‡, CT-2500‡	50	500
PV10-8R-L			0.04	0.225	#8	1.05	0.31	0.31		50	500
PV10-10R-L			0.04	0.225	#10	1.05	0.31	0.31		50	500
PV10-14R-L			0.04	0.225	1/4"	1.23	0.52	0.38		50	500
PV10-56R-L			0.04	0.225	5/16"	1.23	0.52	0.38		50	500
PV10-38R-L			0.04	0.225	3/8"	1.31	0.58	0.41		50	500
PV10-12R-Q			0.04	0.225	1/2"	1.46	0.72	0.53		25	250

\*Wire sizes #26 – 22 AWG, are not UL Listed or CSA Certified.

\*\*Bulk packaging may be available, contact Panduit Customer Service for additional information.

‡UL and CSA approved tooling/product combinations. For crimping tool information, see pages D1.83, D1.84, D1.86 and D1.88.

A. System Overview

B1. Cable Ties

B2. Cable Accessories

B3. Stainless Steel Ties

C1. Wiring Duct

C2. Surface Raceway

C3. Abrasion Protection

C4. Cable Management

D1. Terminals

D2. Power Connectors

D3. Grounding Connectors

E1. Labeling Systems

E2. Labels

E3. Pre-Printed & Write-On Markers

E4. Permanent Identification

E5. Lockout/Tagout & Safety Solutions

F. Index

A. System Overview

B1. Cable Ties

B2. Cable Accessories

B3. Stainless Steel Ties

C1. Wiring Duct

C2. Surface Raceway

C3. Abrasion Protection

C4. Cable Management

D1. Terminals

D2. Power Connectors

D3. Grounding Connectors

E1. Labeling Systems

E2. Labels

E3. Pre-Printed & Write-On Markers

E4. Permanent Identification

E5. Lockout/Tagout & Safety Solutions

F. Index



## Ring Terminal, Vinyl Expanded Insulation

### Type PV-RX

- Expanded wire entry designed to accommodate wire with a larger insulation thickness
- Ring tongue design assures a secure connection in high vibration applications
- Insulation support helps to prevent wire damage in bending applications
- Brazed seam protects terminal barrel from splitting during the crimp process
- Internal barrel serrations assure good wire contact and maximum tensile strength
- UL Flammability UL 94V-0, maximum insulation temperature 221°F (105°C)
- UL and CSA rated up to 600 V per UL 486A/B

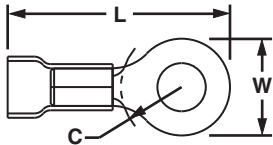

Part Number	Wire Range	Color Code	Stock Thickness (In.)	Max. Ins. (In.)	Stud Size	Figure Dimensions (In.)			Recommended Installation Tool	Std. Pkg. Qty.**	Std. Ctn. Qty.
						L	W	C			
PV18-4RX-CY	22 – 18 AWG	Red	0.03	0.170	#4	0.88	0.25	0.22	CT-100A‡, CT-600-A‡, CT-1550‡, CT-1551‡, CT-2500‡	100	500
PV18-6RX-CY			0.03	0.170	#6	0.89	0.25	0.22			
PV18-8RX-CY			0.03	0.170	#8	0.97	0.31	0.27			
PV18-10RX-CY			0.03	0.170	#10	0.96	0.31	0.27			
PV18-14RX-CY			0.03	0.170	1/4"	1.17	0.46	0.40			
PV18-56RX-LY			0.03	0.170	5/16"	1.17	0.46	0.40			
PV18-38RX-LY			0.03	0.170	3/8"	1.25	0.53	0.45			
PV14-4RX-C	16 – 14 AWG	Blue	0.03	0.200	#4	0.87	0.25	0.19	CT-100A‡, CT-600-A‡, CT-1550‡, CT-1551‡, CT-2500‡	100	500
PV14-6RX-C			0.03	0.200	#6	0.96	0.31	0.25			
PV14-8RX-C			0.03	0.200	#8	0.96	0.31	0.25			
PV14-10RX-C			0.03	0.200	#10	0.96	0.31	0.25			
PV14-14RX-L			0.03	0.200	1/4"	1.16	0.46	0.37			
PV14-56RX-L			0.03	0.200	5/16"	1.16	0.46	0.37			
PV14-38RX-L			0.03	0.200	3/8"	1.25	0.53	0.42			
PV10-6RX-L	12 – 10 AWG	Yellow	0.04	0.250	#6	1.10	0.31	0.30	CT-100A‡, CT-600-A‡, CT-1550‡, CT-1551‡, CT-2500‡	50	500
PV10-8RX-L			0.04	0.250	#8	1.10	0.31	0.30			
PV10-10RX-L			0.04	0.250	#10	1.10	0.31	0.30			
PV10-14RX-L			0.04	0.250	1/4"	1.29	0.52	0.39			
PV10-56RX-L			0.04	0.250	5/16"	1.29	0.52	0.42			
PV10-38RX-L			0.04	0.250	3/8"	1.39	0.58	0.46			

\*\*Bulk packaging may be available, contact Panduit Customer Service for additional information.

‡UL and CSA approved tooling/product combinations. For crimping tool information, see pages D1.83, D1.84, D1.86 and D1.88.



## Multiple Stud Terminal, Vinyl Insulated – Funnel Entry

### Type PV-610R

- Teardrop shaped mounting hole of multiple stud terminals permits use with #6, #8, or #10 size studs
- Ring tongue design assures a secure connection in high vibration applications
- Insulation support helps to prevent wire damage in bending applications
- Brazed seam protects terminal barrel from splitting during the crimp process
- Internal barrel serrations assure good wire contact and maximum tensile strength
- UL Flammability UL 94V-0, maximum insulation temperature 221°F (105°C)
- UL and CSA rated up to 600 V per UL 486A/B

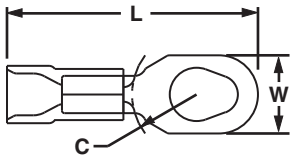

Part Number	Wire Range	Color Code	Stock Thickness (In.)	Max. Ins. (In.)	Stud Size	Figure Dimensions (In.)			Recommended Installation Tool	Std. Pkg. Qty.**	Std. Ctn. Qty.
						L	W	C			
<b>PV18-610R-CY</b>	22 – 18 AWG	Red	0.03	0.150	#6, #8, #10	1.00	0.31	0.25	CT-100A, CT-600-A‡, CT-1550‡, CT-1551‡, CT-2500‡	100	500
<b>PV14-610R-C</b>	16 – 14 AWG	Blue	0.03	0.170		1.00	0.31	0.25		100	500
<b>PV10-610R-L</b>	12 – 10 AWG	Yellow	0.04	0.225		1.17	0.37	0.31		50	500

\*\*Bulk packaging may be available, contact Panduit Customer Service for additional information.  
 ‡UL and CSA approved tooling/product combinations. For crimping tool information, see pages D1.83, D1.84, D1.86 and D1.88.

A. System Overview

B1. Cable Ties

B2. Cable Accessories

B3. Stainless Steel Ties

C1. Wiring Duct

C2. Surface Raceway

C3. Abrasion Protection

C4. Cable Management

D1. Terminals

D2. Power Connectors

D3. Grounding Connectors

E1. Labeling Systems

E2. Labels

E3. Pre-Printed & Write-On Markers

E4. Permanent Identification

E5. Lockout/Tagout & Safety Solutions

F. Index

A. System Overview

B1. Cable Ties

B2. Cable Accessories

B3. Stainless Steel Ties

C1. Wiring Duct

C2. Surface Raceway

C3. Abrasion Protection

C4. Cable Management

D1. Terminals

D2. Power Connectors

D3. Grounding Connectors

E1. Labeling Systems

E2. Labels

E3. Pre-Printed & Write-On Markers

E4. Permanent Identification

E5. Lockout/Tagout & Safety Solutions

F. Index



## Ring Terminal, KYNAR® Insulated

### Type PK-R

- For nuclear containment areas and high temperature to 300°F (150°C) applications
- Color code: natural with appropriate color stripe to identify wire range
- Ring tongue design assures a secure connection in high vibration applications

- UL and CSA rated up to 600 V per UL 486A/B

**Note: For PK18 – PK10 Terminals the following applies:**

- Classified as Class 1E in accordance with IEEE 323-2003
- Metal insulation grip sleeve crimps to wire insulation, providing protection to the crimp joint during high vibration applications



Part Number	Wire Range	Color Code	Stock Thickness (In.)	Max. Ins. (In.)	Stud Size	Figure Dimensions (In.)			Recommended Installation Tool	Std. Pkg. Qty.**	Std. Ctn. Qty.
						L	W	C			
PK18-4R-C	22 – 16 AWG	Red Stripe	0.03	0.145	#4	0.80	0.25	0.22	CT-100A, CT-600-A‡, CT-1550‡, CT-1551‡, CT-2500‡	100	500
PK18-6R-C			0.03	0.145	#6	0.80	0.25	0.22		100	500
PK18-8R-C			0.03	0.145	#8	0.89	0.31	0.29		100	500
PK18-10R-C			0.03	0.145	#10	0.89	0.31	0.29		100	500
PK18-14R-C			0.03	0.145	1/4"	1.10	0.46	0.40		100	500
PK18-38R-C			0.03	0.145	3/8"	1.18	0.53	0.45		100	500
PK18-56R-C	18 – 14 AWG	Blue Stripe	0.03	0.145	5/16"	1.10	0.46	0.40	CT-100A, CT-600-A‡, CT-1550‡, CT-1551‡, CT-2500‡	100	500
PK14-4R-C			0.03	0.162	#4	0.78	0.25	0.22		100	500
PK14-6R-C			0.03	0.162	#6	0.87	0.31	0.29		100	500
PK14-8R-C			0.03	0.162	#8	0.87	0.31	0.29		100	500
PK14-10R-C			0.03	0.162	#10	0.87	0.31	0.29		100	500
PK14-14R-C			0.03	0.162	1/4"	1.08	0.46	0.40		100	500
PK14-38R-C	12 – 10 AWG	Yellow Stripe	0.03	0.162	3/8"	1.15	0.53	0.43	CT-100A, CT-600-A‡, CT-1550‡, CT-1551‡, CT-2500‡	100	500
PK14-56R-C			0.03	0.162	5/16"	1.08	0.46	0.40		100	500
PK10-6R-L			0.04	0.225	#6	1.06	0.37	0.33		50	500
PK10-8R-L			0.04	0.225	#8	1.06	0.37	0.33		50	500
PK10-10R-L			0.04	0.225	#10	1.06	0.37	0.33		50	500
PK10-14R-L			0.04	0.225	1/4"	1.25	0.38	0.42		50	500
PK10-38R-Q			0.04	0.225	3/8"	1.34	0.58	0.42	25	125	



### Large Wire, KYNAR® Insulated

PK8-8R-T	8 AWG	Red Stripe	0.04	0.326	#8	1.50	0.42	0.43	CT-2600, CD-2600-8‡	200	1200
PK8-10R-T			0.04	0.326	#10	1.52	0.47	0.43		200	1200
PK8-14R-T			0.04	0.326	1/4"	1.52	0.47	0.43		200	1200
PK8-56R-T			0.04	0.326	5/16"	1.63	0.59	0.51		200	1200
PK8-38R-T	6 AWG	Blue Stripe	0.04	0.326	3/8"	1.63	0.59	0.51	CT-2600, CD-2600-6‡	200	1200
PK8-12R-T			0.04	0.326	1/2"	1.73	0.82	0.51		200	1200
PK6-8R-T			0.05	0.360	#8	1.59	0.47	0.43		200	1200
PK6-10R-T			0.05	0.360	#10	1.60	0.47	0.43		200	1200
PK6-14R-T	4 AWG	Yellow Stripe	0.05	0.360	1/4"	1.63	0.47	0.48	CT-2600, CD-2600-4‡	200	1200
PK6-56R-T			0.05	0.360	5/16"	1.72	0.62	0.53		200	1200
PK6-38R-T			0.05	0.360	3/8"	1.72	0.62	0.51		200	1200
PK6-12R-T			0.05	0.360	1/2"	1.82	0.82	0.51		200	1200
PK4-10R-T	2 AWG	Red Stripe	0.05	0.450	#10	1.86	0.55	0.50	CT-2600, CD-2600-4‡	200	1200
PK4-14R-T			0.05	0.450	1/4"	1.86	0.55	0.50		200	1200
PK4-56R-T			0.05	0.450	5/16"	1.93	0.68	0.50		200	1200
PK4-38R-T			0.05	0.450	3/8"	1.93	0.68	0.50		200	1200
PK4-12R-T			0.05	0.450	1/2"	2.02	0.86	0.50	CT-2600, CD-2600-2‡	200	1200
PK2-10R-T			0.06	0.550	#10	1.95	0.68	0.58		200	1200
PK2-14R-T			0.06	0.550	1/4"	1.95	0.68	0.58		200	1200
PK2-56R-T			0.06	0.550	5/16"	1.95	0.68	0.58		200	1200
PK2-38R-T			0.06	0.550	3/8"	1.95	0.68	0.58		200	1200
PK2-12R-T			0.06	0.550	1/2"	2.04	0.86	0.58		200	1200

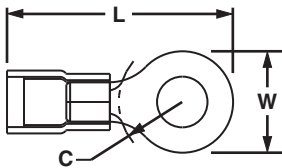

\*KYNAR is a registered trademark of Atofina Chemicals, Inc.

‡UL approved tooling/product combinations. For crimping tool information, see pages D1.83, D1.84, D1.86, D1.88, and D1.89.

**UL LISTED** **CSA CERTIFIED** **Heat Shrink, Ring Terminal**

**Type PH-R**

- Heat shrink sleeving forms a protective barrier to provide environmentally sealed terminations ideal for high moisture applications
- Ring tongue design assures a secure connection in high vibration applications
- Brazed seam protects terminal barrel from splitting during the crimp process

- Heat shrink installation is completed with a standard heat gun
- Minimum continuous operating temperature -65°F (-55°C)
- Maximum continuous operation temperature 230°F (110°C)
- Shrink temperature 300°F (150°C)
- UL and CSA rated up to 600 V per UL 486A/B

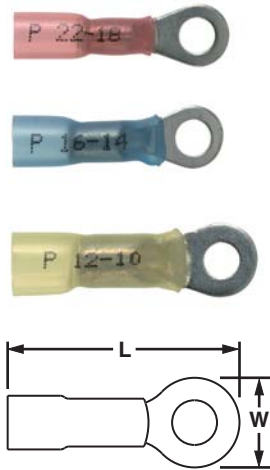

Part Number	Wire Range	Color Code	Max. Ins. (In.)	Stud Size (In.)	Figure Dimensions (In.)			Wire Strip Length (In.)	Recommended Installation Tool	Std. Pkg. Qty.	Std. Ctn. Qty.
					L	W	C				
PH18-6R-Q	22 – 18 AWG	Red	0.170	#6	1.05	0.25		5/16	CT-310	25	125
PH18-8R-Q			0.170	#8	1.08	0.31		5/16		25	125
PH18-10R-Q			0.170	#10	1.08	0.31		5/16		25	125
PH18-14R-Q			0.170	1/4"	1.24	0.47		5/16		25	125
PH14-6R-Q	16 – 14 AWG	Blue	0.190	#6	1.06	0.31		5/16	CT-310	25	125
PH14-8R-Q			0.190	#8	1.03	0.31		5/16		25	125
PH14-10R-Q			0.190	#10	1.05	0.32		5/16		25	125
PH14-14R-Q			0.190	1/4"	1.24	0.46		5/16		25	125
PH14-56R-Q			0.190	5/16"	1.24	0.46		5/16		25	125
PH14-38R-Q			0.190	3/8"	1.24	0.53		5/16		25	125
PH10-8R-E	12 – 10 AWG	Yellow	0.240	#8	1.22	0.37		5/16	CT-310	20	100
PH10-10R-E			0.240	#10	1.20	0.37		5/16		20	100
PH10-14R-E			0.240	1/4"	1.20	0.52		5/16		20	100
PH10-38R-E			0.240	3/8"	1.20	0.59		5/16		20	100
PH10-12R-E			0.240	1/2"	1.54	0.72		5/16		20	100

For crimping tool information, see page D1.85.

**UL LISTED** **CSA CERTIFIED** **Ring Terminal, Heavy Duty, Nylon Insulated**

**Type PN-HDR**

- Manufactured from stock 56% thicker than a standard #16 – #14 AWG terminal for use in heavy-duty applications
- Insulation housing is marked with "HDR" to signify heavy-duty ring
- Ring tongue design assures a secure connection in high vibration applications
- Metal insulation grip sleeve crimps to wire insulation, providing protection to the crimp joint during high vibration applications

- Internal barrel serrations assure good wire contact and maximum tensile strength
- UL Flammability UL 94V-2/HB, maximum insulation temperature 221°F (105°C)
- UL and CSA rated up to 600 V per UL 486A/B

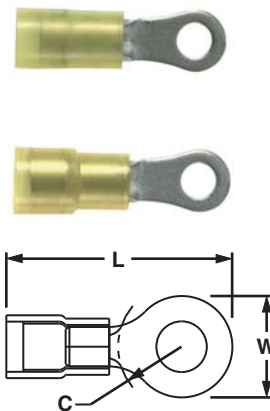

Part Number	Wire Range	Color Code	Stock Thickness (In.)	Max. Ins. (In.)	Stud Size	Figure Dimensions (In.)			Recommended Installation Tool	Std. Pkg. Qty.**	Std. Ctn. Qty.
						L	W	C			
PN12-8HDR-L	16 – 12 AWG	Yellow	0.05	0.225	#8	1.06	0.31	0.35	CT-1550‡, CT-1551‡, CT-2500‡	50	500
PN12-10HDR-L			0.05	0.225	#10	1.09	0.37	0.33		50	500
PN12-14HDR-L			0.05	0.225	1/4"	1.24	0.52	0.42		50	500
PN12-56HDR-L			0.05	0.225	5/16"	1.24	0.52	0.42		50	500
PN12-38HDR-L			0.05	0.225	3/8"	1.30	0.58	0.46		50	500

\*\*Bulk packaging may be available, contact Panduit Customer Service for additional information.

‡UL and CSA approved tooling/product combinations. For crimping tool information, see pages D1.84 and D1.88.

A. System Overview

B1. Cable Ties

B2. Cable Accessories

B3. Stainless Steel Ties

C1. Wiring Duct

C2. Surface Raceway

C3. Abrasion Protection

C4. Cable Management

D1. Terminals

D2. Power Connectors

D3. Grounding Connectors

E1. Labeling Systems

E2. Labels

E3. Pre-Printed & Write-On Markers

E4. Permanent Identification

E5. Lockout/Tagout & Safety Solutions

F. Index

A. System Overview

B1. Cable Ties



## Ring Terminal, Heavy Duty, Vinyl Insulated – Funnel Entry

### Type PV-HDR

- Manufactured from stock 56% thicker than a standard #16 – 14 AWG terminal for use in heavy-duty applications
- Insulation housing is marked with “HDR” to signify heavy-duty ring
- Ring tongue design assures a secure connection in high vibration applications
- Insulation support helps to prevent wire damage in bending applications
- Brazed seam protects terminal barrel from splitting during the crimp process
- Internal barrel serrations assure good wire contact and maximum tensile strength
- UL Flammability UL 94V-0, maximum insulation temperature 221°F (105°C)
- UL and CSA rated up to 600 V per UL 486A/B

C1. Wiring Duct



C2. Surface Raceway



C3. Abrasion Protection

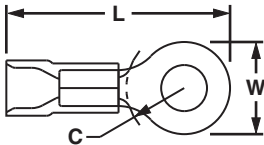

C4. Cable Management

Part Number	Wire Range	Color Code	Stock Thickness (In.)	Max. Ins. (In.)	Stud Size	Figure Dimensions (In.)			Recommended Installation Tool	Std. Pkg. Qty.**	Std. Ctn. Qty.
						L	W	C			

#### Standard Heavy Duty Insulation

PV12-6HDR-L	16 – 12 AWG	Yellow	0.05	0.225	#6	1.05	0.31	0.35	CT-600-A‡, CT-1550‡, CT-1551‡, CT-2500‡	50	500
PV12-8HDR-L			0.05	0.225	#8	1.05	0.31	0.35		50	500
<b>PV12-10HDR-L</b>			0.05	0.225	#10	1.08	0.37	0.33		50	500
<b>PV12-14HDR-L</b>			0.05	0.225	1/4"	1.23	0.52	0.42		50	500
PV12-56HDR-L			0.05	0.225	5/16"	1.23	0.52	0.42		50	500
PV12-38HDR-L			0.05	0.225	3/8"	1.31	0.58	0.46		50	500

#### Expanded Heavy Duty Insulation\*

PV12-6HDRX-L	16 – 12 AWG	Yellow	0.05	0.250	#6	1.05	0.31	0.35	CT-600-A‡, CT-1550‡, CT-1551‡, CT-2500‡	50	500
PV12-8HDRX-L			0.05	0.250	#8	1.05	0.31	0.35		50	500
<b>PV12-10HDRX-L</b>			0.05	0.250	#10	1.08	0.37	0.33		50	500
<b>PV12-14HDRX-L</b>			0.05	0.250	1/4"	1.23	0.52	0.42		50	500
PV12-56HDRX-L			0.05	0.250	5/16"	1.23	0.52	0.42		50	500
PV12-38HDRX-L			0.05	0.250	3/8"	1.31	0.58	0.46		50	500

\*Expanded insulation parts do not have funnel entry.

\*\*Bulk packaging may be available, contact Panduit Customer Service for additional information.

‡UL and CSA approved tooling/product combinations. For tooling information, see pages D1.84, D1.86, and D1.88.

D1. Terminals

D2. Power Connectors

D3. Grounding Connectors

E1. Labeling Systems

E2. Labels

E3. Pre-Printed & Write-On Markers

E4. Permanent Identification

E5. Lockout/Tagout & Safety Solutions

F. Index

## Ring Terminal, Large Wire, Vinyl Insulated

### Type PV-R

- Ring tongue design assures a secure connection in high vibration applications
- Insulation support helps to prevent wire damage in bending applications
- Brazed seam protects terminal barrel from splitting during the crimp process
- Internal barrel serrations assure good wire contact and maximum tensile strength
- UL Flammability UL 94V-0, maximum insulation temperature 221°F (105°C)
- UL rated up to 600 V per UL 486A/B

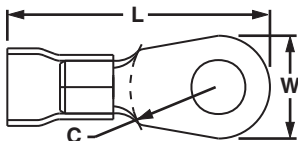
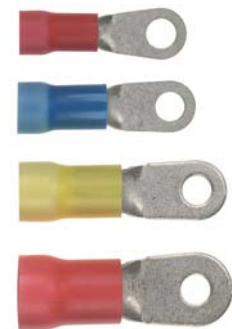

Part Number	Wire Range	Color Code	Stock Thickness (In.)	Max. Ins. (In.)	Stud Size	Figure Dimensions (In.)			Recommended Installation Tool	Std. Pkg. Qty.**	Std. Ctn. Qty.
						L	W	C			
PV8-8R-QY	8 AWG	Red	0.04	0.280	#8	1.51	0.42	0.43	CT-720, CD-720PV8-2‡, CT-2600, CD-2600-PV8‡	25	250
PV8-10R-QY			0.04	0.280	#10	1.53	0.47	0.43		25	250
PV8-14R-QY			0.04	0.280	1/4"	1.53	0.47	0.43		25	250
PV8-56R-QY			0.04	0.280	5/16"	1.64	0.59	0.49		25	250
PV8-38R-QY			0.04	0.280	3/8"	1.64	0.59	0.51		25	250
PV8-12R-XY			0.04	0.280	1/2"	1.74	0.82	0.51		10	100
PV6-8R-E	6 AWG	Blue	0.05	0.340	#8	1.61	0.47	0.43	CT-720, CD-720PV8-2‡, CT-2600, CD-2600-PV6‡	20	200
PV6-10R-X			0.05	0.340	#10	1.62	0.47	0.43		10	100
PV6-14R-X			0.05	0.340	1/4"	1.65	0.47	0.48		10	100
PV6-56R-X			0.05	0.340	5/16"	1.74	0.62	0.53		10	100
PV6-38R-X			0.05	0.340	3/8"	1.74	0.62	0.51		10	100
PV6-12R-X			0.05	0.340	1/2"	1.84	0.82	0.51		10	100
PV4-10R-E	4 AWG	Yellow	0.05	0.450	#10	1.88	0.55	0.50	CT-720, CD-720PV8-2‡, CT-2600, CD-2600-PV4‡	20	200
PV4-14R-E			0.05	0.450	1/4"	1.88	0.55	0.50		20	200
PV4-56R-E			0.05	0.450	5/16"	1.95	0.68	0.50		20	200
PV4-38R-E			0.05	0.450	3/8"	1.95	0.68	0.50		20	200
PV4-12R-E			0.05	0.450	1/2"	2.04	0.86	0.50		20	200
PV2-10R-XY	2 AWG	Red	0.06	0.560	#10	1.96	0.68	0.58	CT-720, CD-720PV8-2‡, CT-2600, CD-2600-PV2‡	10	100
PV2-14R-XY			0.06	0.560	1/4"	1.96	0.68	0.58		10	100
PV2-56R-XY			0.06	0.560	5/16"	1.96	0.68	0.58		10	100
PV2-38R-XY			0.06	0.560	3/8"	1.96	0.68	0.58		10	100
PV2-12R-XY			0.06	0.560	1/2"	2.05	0.86	0.58		10	100
					1/2"	2.05	0.86	0.58		10	100

\*\*Bulk packaging may be available, contact Panduit Customer Service for additional information.  
‡UL approved tooling/product combinations. For crimping tool information, see page D1.87 and D1.89.

A.  
System  
Overview

B1.  
Cable Ties

B2.  
Cable  
Accessories

B3.  
Stainless  
Steel Ties

C1.  
Wiring  
Duct

C2.  
Surface  
Raceway

C3.  
Abrasion  
Protection

C4.  
Cable  
Management

D1.  
Terminals

D2.  
Power  
Connectors

D3.  
Grounding  
Connectors

E1.  
Labeling  
Systems

E2.  
Labels

E3.  
Pre-Printed  
& Write-On  
Markers

E4.  
Permanent  
Identification

E5.  
Lockout/  
Tagout  
& Safety  
Solutions

F.  
Index

A. System Overview

B1. Cable Ties



## Ring Terminal, Large Wire, Vinyl Expanded Insulation

### Type PV-RX

- Ring tongue design assures a secure connection in high vibration applications
- Expanded wire entry designed to accommodate wire with a larger insulation thickness
- Insulation support helps to prevent wire damage in bending applications
- Brazed seam protects terminal barrel from splitting during the crimp process
- Internal barrel serrations assure good wire contact and maximum tensile strength
- UL Flammability UL 94V-0, maximum insulation temperature 221°F (105°C)
- UL rated up to 600 V per UL 486A/B

C1. Wiring Duct



C2. Surface Raceway



C3. Abrasion Protection



C4. Cable Management



D1. Terminals

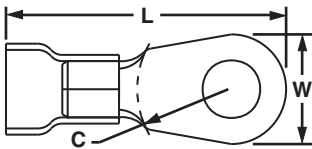

D2. Power Connectors

D3. Grounding Connectors

E1. Labeling Systems

E2. Labels

E3. Pre-Printed & Write-On Markers

E4. Permanent Identification

E5. Lockout/Tagout & Safety Solutions

F. Index

Part Number	Wire Range	Color Code	Stock Thickness (In.)	Max. Ins. (In.)	Stud Size	Figure Dimensions (In.)			Recommended Installation Tool	Std. Pkg. Qty.**	Std. Ctn. Qty.
						L	W	C			
PV8-8RX-QY	8 AWG	Red	0.04	0.360	#8	1.50	0.42	0.43	CT-720, CD-720PV8-2‡, CT-2600, CD-2600-PV8‡	25	250
PV8-10RX-QY			0.04	0.360	#10	1.52	0.47	0.43		25	250
PV8-14RX-QY			0.04	0.360	1/4"	1.52	0.47	0.43		25	250
PV8-56RX-QY			0.04	0.360	5/16"	1.62	0.59	0.51		25	250
PV8-38RX-QY			0.04	0.360	3/8"	1.62	0.59	0.51		25	250
PV8-12RX-XY			0.04	0.360	1/2"	1.74	0.82	0.51		10	100
PV6-8RX-E	6 AWG	Blue	0.05	0.436	#8	1.61	0.47	0.43	CT-720, CD-720PV8-2‡, CT-2600, CD-2600-PV6‡	20	200
PV6-10RX-X			0.05	0.436	#10	1.61	0.47	0.43		10	100
PV6-14RX-X			0.05	0.436	1/4"	1.61	0.47	0.43		10	100
PV6-56RX-X			0.05	0.436	5/16"	1.73	0.62	0.51		10	100
PV6-38RX-X			0.05	0.436	3/8"	1.73	0.62	0.53		10	100
PV4-10RX-E	4 AWG	Yellow	0.05	0.515	#10	1.87	0.55	0.53	CT-720, CD-720PV8-2‡, CT-2600, CD-2600-PV4‡	20	200
PV4-14RX-E			0.05	0.515	1/4"	1.87	0.55	0.53		20	200
PV4-56RX-E			0.05	0.515	5/16"	1.94	0.68	0.53		20	200
PV4-38RX-E			0.05	0.515	3/8"	1.94	0.68	0.53		20	200
PV4-12RX-E			0.05	0.515	1/2"	2.03	0.86	0.53		20	200
PV2-10RX-XY	2 AWG	Red	0.06	0.632	#10	1.94	0.68	0.58	CT-720, CD-720PV8-2‡, CT-2600, CD-2600-PV2‡	10	100
PV2-14RX-XY			0.06	0.632	1/4"	1.94	0.68	0.58		10	100
PV2-56RX-XY			0.06	0.632	5/16"	1.94	0.68	0.58		10	100
PV2-38RX-XY			0.06	0.632	3/8"	1.94	0.68	0.58		10	100
PV2-12RX-XY			0.06	0.632	1/2"	2.03	0.86	0.58		10	100

\*\*Bulk packaging may be available, contact Panduit Customer Service for additional information.

‡UL approved tooling/product combinations. For crimping tool information, see page D1.87 and D1.89.



**UL LISTED** **CSA CERTIFIED** **Ring Terminal, Non-Insulated**

**Type P-R**

- Ring tongue design assures a secure connection in high vibration applications
- Internal barrel serrations assure good wire contact and maximum tensile strength
- Brazed seam protects terminal barrel from splitting during the crimp process

- Barrel of terminal internally beveled to provide quick and easy wire insertion
- Maximum recommended operating temperature 302°F (150°C)
- UL and CSA rated up to 2000 V per UL 486A/B

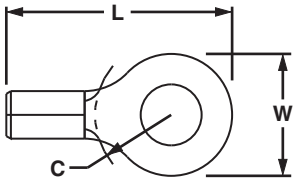

Part Number	Wire Range	Stock Thickness (In.)	Stud Size	Figure Dimensions (In.)			Recommended Installation Tool	Std. Pkg. Qty.**	Std. Ctn. Qty.		
				L	W	C					
<b>P22-2R-C*</b>	26 – 22 AWG	0.02	#2	0.52	0.20	0.16	CT-200	100	1000		
<b>P22-4R-C*</b>		0.02	#4	0.52	0.20	0.16		100	1000		
<b>P22-6R-C*</b>		0.02	#6	0.52	0.20	0.16		100	1000		
<b>P22-8R-C*</b>		0.02	#8	0.63	0.26	0.25		100	1000		
<b>P22-10R-C*</b>		0.02	#10	0.63	0.31	0.22		100	1000		
<b>P18-4R-C</b>	22 – 16 AWG	0.03	#4	0.62	0.25	0.21	CT-100A‡, CT-200‡, CT-600-A‡, CT-1570‡, CT-2500‡	100	1000		
<b>P18-6RN-C</b>		0.03	#6	0.60	0.22	0.19		100	1000		
<b>P18-6R-C</b>		0.03	#6	0.62	0.25	0.21		100	1000		
<b>P18-8R-C</b>		0.03	#8	0.71	0.31	0.25		100	1000		
<b>P18-10R-C</b>		0.03	#10	0.71	0.31	0.25		100	1000		
<b>P18-14R-C</b>		0.03	1/4"	0.91	0.46	0.38		100	1000		
<b>P18-56R-C</b>		0.03	5/16"	0.91	0.46	0.38		100	1000		
<b>P18-38R-C</b>		0.03	3/8"	1.0	0.53	0.43		100	1000		
<b>P18-12R-C</b>		0.03	1/2"	1.20	0.72	0.53		100	1000		
<b>P14-4R-C</b>		18 – 14 AWG	0.03	#4	0.62	0.25		0.20	CT-100A‡, CT-200‡, CT-600-A‡, CT-1570‡, CT-2500‡	100	1000
<b>P14-6R-C</b>	0.03		#6	0.62	0.25	0.20	100	1000			
<b>P14-8R-C</b>	0.03		#8	0.71	0.31	0.25	100	1000			
<b>P14-10R-C</b>	0.03		#10	0.71	0.31	0.25	100	1000			
<b>P14-14R-C</b>	0.03		1/4"	0.91	0.46	0.38	100	1000			
<b>P14-56R-C</b>	0.03		5/16"	0.91	0.46	0.38	100	1000			
<b>P14-38R-C</b>	0.03		3/8"	1.0	0.53	0.43	100	1000			
<b>P14-12R-L</b>	0.03		1/2"	1.20	0.72	0.53	50	500			
<b>P10-6R-L^</b>	14 – 10 AWG		0.04	#6	0.78	0.31	0.31	CT-100A‡, CT-200‡, CT-600-A‡, CT-1570‡, CT-1701‡, CT-2500‡		50	500
<b>P10-8R-L</b>			0.04	#8	0.78	0.31	0.31			50	500
<b>P10-10R-L^</b>		0.04	#10	0.81	0.38	0.31	50		500		
<b>P10-14R-L</b>		0.04	1/4"	0.96	0.52	0.38	50		500		
<b>P10-56R-L^</b>		0.04	5/16"	0.95	0.52	0.38	50		500		
<b>P10-38R-L^</b>		0.04	3/8"	1.05	0.58	0.44	50		500		
<b>P10-12R-L</b>		0.04	1/2"	1.20	0.72	0.53	50		500		

\*Wire sizes #26 – 22 AWG are not UL Listed or CSA Certified.

\*\*Bulk packaging may be available, contact Panduit Customer Service for additional information.

^For military specification cross reference see page D1.96.

‡UL and CSA approved tooling/product combinations. For crimping tool information, see pages D1.83, D1.84, D1.86 and D1.88.

A. System Overview

B1. Cable Ties

B2. Cable Accessories

B3. Stainless Steel Ties

C1. Wiring Duct

C2. Surface Raceway

C3. Abrasion Protection

C4. Cable Management

D1. Terminals

D2. Power Connectors

D3. Grounding Connectors

E1. Labeling Systems

E2. Labels

E3. Pre-Printed & Write-On Markers

E4. Permanent Identification

E5. Lockout/Tagout & Safety Solutions

F. Index

A. System Overview

B1. Cable Ties

B2. Cable Accessories

B3. Stainless Steel Ties

C1. Wiring Duct

C2. Surface Raceway

C3. Abrasion Protection

C4. Cable Management

D1. Terminals

D2. Power Connectors

D3. Grounding Connectors

E1. Labeling Systems

E2. Labels

E3. Pre-Printed & Write-On Markers

E4. Permanent Identification

E5. Lockout/Tagout & Safety Solutions

F. Index



## Multiple Stud Terminal, Non-Insulated

### Type P-610R

- Ring tongue design assures a secure connection in high vibration applications
- Teardrop shaped mounting hole of multiple stud terminals permits use with #6, #8, or #10 size studs
- Internal barrel serrations assure good wire contact and maximum tensile strength
- Brazed seam protects terminal barrel from splitting during the crimp process
- Barrel of terminal internally beveled to provide quick and easy wire insertion
- Maximum recommended operating temperature 302°F (150°C)
- UL and CSA rated up to 2000 V per UL 486A/B



Part Number	Wire Range	Stock Thickness (In.)	Stud Size	Figure Dimensions (In.)			Recommended Installation Tool	Std. Pkg. Qty.**	Std. Ctn. Qty.
				L	W	C			
<b>P18-610R-C</b>	22 – 16 AWG	0.03	#6, #8, #10	0.80	0.31	0.25	CT-100A‡, CT-200‡, CT-600-A‡, CT-1570‡, CT-1701‡, CT-2500‡	100	500
<b>P14-610R-C</b>	18 – 14 AWG	0.03		0.80	0.31	0.25		100	500
<b>P10-610R-L</b>	14 – 10 AWG	0.04		0.90	0.37	0.31	50	500	

\*\*Bulk packaging may be available, contact Panduit Customer Service for additional information.  
‡UL and CSA approved tooling/product combinations. For tooling information, see pages D1.83, D1.84, D1.86 and D1.88.

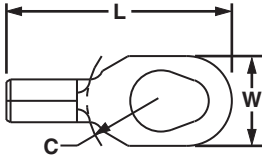

## Ring Terminal, Non-Insulated – High Temperature

### Type P-RHT

- Ring tongue design assures a secure connection in high vibration applications
- Nickel plated copper for temperatures up to 650°F (343°C)
- Internal barrel serrations assure good wire contact and maximum tensile strength
- Brazed seam protects terminal barrel from splitting during the crimp process
- Barrel of terminal internally beveled to provide quick and easy wire insertion
- Rated up to 2000 V



Part Number	Wire Range	Stock Thickness (In.)	Stud Size	Figure Dimensions (In.)			Recommended Installation Tool	Std. Pkg. Qty.	Std. Ctn. Qty.
				L	W	C			
<b>P18-6RHT6-C</b>	22 – 16 AWG	0.03	#6	0.62	0.25	0.21	CT-100A, CT-200, CT-600-A, CT-1570, CT-2500	100	1000
<b>P18-8RHT6-C</b>		0.03	#8	0.71	0.31	0.25		100	1000
<b>P18-10RHT6-C</b>		0.03	#10	0.71	0.31	0.25		100	1000
<b>P14-6RHT6-C</b>	18 – 14 AWG	0.03	#6	0.62	0.25	0.20	CT-100A, CT-200, CT-600-A, CT-1570, CT-2500	100	1000
<b>P14-8RHT6-C</b>		0.03	#8	0.71	0.31	0.25		100	1000
<b>P14-10RHT6-C</b>		0.03	#10	0.71	0.31	0.25		100	1000
<b>P10-6RHT6-L</b>	12 – 10 AWG	0.04	#6	0.78	0.31	0.35	CT-100A, CT-200, CT-600-A, CT-1570, CT-1701, CT-2500	50	500
<b>P10-8RHT6-L</b>		0.04	#8	0.78	0.31	0.35		50	500
<b>P10-10RHT6-L</b>		0.04	#10	0.81	0.38	0.33		50	500
<b>P10-14RHT6-L</b>		0.04	1/4"	0.96	0.53	0.42		50	500



### Large Wire, Non-Insulated - High Temperature



<b>P8-8RHT6-Q</b>	8 AWG	0.04	#8	1.12	0.42	0.43	CT-2600, CD-2600-8‡	25	250
<b>P8-10RHT6-Q</b>		0.04	#10	1.14	0.42	0.43		25	250
<b>P8-14RHT6-Q</b>		0.04	1/4"	1.14	0.47	0.43		25	250
<b>P8-56RHT6-Q</b>		0.04	5/16"	1.25	0.59	0.51		25	250
<b>P8-38RHT6-Q</b>		0.04	3/8"	1.25	0.59	0.51		25	250
<b>P8-12RHT6-Q</b>	6 AWG	0.04	1/2"	1.36	0.82	0.54	CT-2600, CD-2600-6‡	25	250
<b>P6-8RHT6-E</b>		0.05	#8	1.21	0.47	0.43		20	200
<b>P6-10RHT6-E</b>		0.05	#10	1.21	0.47	0.43		20	200
<b>P6-14RHT6-E</b>		0.05	1/4"	1.21	0.47	0.43		20	200
<b>P6-56RHT6-E</b>		0.05	5/16"	1.33	0.62	0.51		20	200
<b>P6-38RHT6-E</b>	4 AWG	0.05	3/8"	1.33	0.62	0.51	CT-2600, CD-2600-4‡	20	200
<b>P6-12RHT6-E</b>		0.05	1/2"	1.43	0.82	0.51		20	200
<b>P4-10RHT6-E</b>		0.05	#10	1.40	0.55	0.50		20	200
<b>P4-14RHT6-E</b>		0.05	1/4"	1.40	0.55	0.50		20	200
<b>P4-56RHT6-E</b>		0.05	5/16"	1.46	0.68	0.50		20	200
<b>P4-38RHT6-E</b>	2 AWG	0.05	3/8"	1.46	0.68	0.50	CT-2600, CD-2600-2‡	20	200
<b>P4-12RHT6-E</b>		0.05	1/2"	1.55	0.86	0.53		20	200
<b>P2-10RHT6-X</b>		0.06	#10	1.46	0.68	0.58		10	100
<b>P2-14RHT6-X</b>		0.06	1/4"	1.46	0.68	0.58		10	100
<b>P2-56RHT6-X</b>		0.06	5/16"	1.46	0.68	0.58		10	100
<b>P2-38RHT6-X</b>	2 AWG	0.06	3/8"	1.46	0.68	0.58	CT-2600, CD-2600-2‡	10	100
<b>P2-12RHT6-X</b>		0.06	1/2"	1.55	0.86	0.58		10	100

\*\*Bulk packaging may be available, contact Panduit Customer Service for additional information. For crimping tool information, see pages D1.83, D1.84, D1.86, D1.88, and D1.89.

A. System Overview

B1. Cable Ties

B2. Cable Accessories

B3. Stainless Steel Ties

C1. Wiring Duct

C2. Surface Raceway

C3. Abrasion Protection

C4. Cable Management

D1. Terminals

D2. Power Connectors

D3. Grounding Connectors

E1. Labeling Systems

E2. Labels

E3. Pre-Printed & Write-On Markers

E4. Permanent Identification

E5. Lockout/Tagout & Safety Solutions

F. Index

A. System Overview

B1. Cable Ties

B2. Cable Accessories

B3. Stainless Steel Ties

C1. Wiring Duct

C2. Surface Raceway

C3. Abrasion Protection

C4. Cable Management

D1. Terminals

D2. Power Connectors

D3. Grounding Connectors

E1. Labeling Systems

E2. Labels

E3. Pre-Printed & Write-On Markers

E4. Permanent Identification

E5. Lockout/Tagout & Safety Solutions

F. Index



## Ring Terminal, Heavy Duty Non-Insulated

### Type P-HDR

- Ring tongue design assures a secure connection in high vibration applications
- Manufactured from stock 56% thicker than a standard #16 – 14 AWG terminal for use in heavy-duty applications
- Internal barrel serrations assure good wire contact and maximum tensile strength
- Brazed seam protects terminal barrel from splitting during the crimp process
- Barrel of terminal internally beveled to provide quick and easy wire insertion
- Maximum recommended operating temperature 302°F (150°C)
- UL and CSA rated up to 2000 V per UL 486A/B

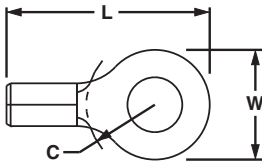

Part Number	Wire Range	Stock Thickness (In.)	Stud Size	Figure Dimensions (In.)			Recommended Installation Tool	Std. Pkg. Qty.**	Std. Ctn. Qty.
				L	W	C			
<b>P12-6HDR-L</b>	16 – 12 AWG	0.05	#6	0.78	0.31	0.36	CT-100A, CT-200, CT-1570‡, CT-2500‡	50	500
<b>P12-8HDR-L</b>		0.05	#8	0.78	0.31	0.36		50	500
<b>P12-10HDR-L</b>		0.05	#10	0.81	0.37	0.36		50	500
<b>P12-14HDR-L</b>		0.05	1/4"	0.96	0.52	0.43		50	500
<b>P12-56HDR-L</b>		0.05	5/16"	0.96	0.52	0.43		50	500
<b>P12-38HDR-L</b>		0.05	3/8"	1.04	0.58	0.48		50	500

\*\*Bulk packaging may be available, contact Panduit Customer Service for additional information.  
‡UL and CSA approved tooling/product combinations. For crimping tool information, see pages D1.83, D1.84, and D1.88.



## Ring Terminal, Large Wire Non-Insulated

### Type P-R

- Designed for use with #8 - #2 AWG copper wire
- Ring tongue design assures a secure connection in high vibration applications
- Internal barrel serrations assure good wire contact and maximum tensile strength
- Brazed seam protects terminal barrel from splitting during the crimp process
- Barrel of terminal internally beveled to provide quick and easy wire insertion
- Maximum recommended operating temperature 302°F (150°C)
- UL and CSA rated up to 2000 V per UL 486A/B

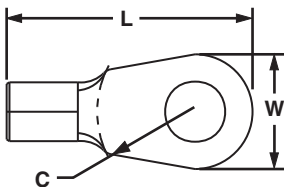

Part Number	Wire Range	Stock Thickness (In.)	Stud Size	Figure Dimensions (In.)			Recommended Installation Tool	Std. Pkg. Qty.**	Std. Ctn. Qty.
				L	W	C			
<b>P8-8R-Q</b>	8 AWG	0.04	#8	1.12	0.42	0.43	CT-1701‡, CT-2600, CD-2600-8‡	25	250
<b>P8-10R-Q</b>		0.04	#10	1.14	0.47	0.43		25	250
<b>P8-14R-Q</b>		0.04	1/4"	1.14	0.47	0.43		25	250
<b>P8-56R-Q</b>		0.04	5/16"	1.25	0.59	0.51		25	250
<b>P8-38R-Q</b>		0.04	3/8"	1.25	0.59	0.51		25	250
<b>P8-12R-Q</b>		0.04	1/2"	1.36	0.82	0.54		25	250
<b>P6-8R-E</b>	6 AWG	0.05	#8	1.21	0.47	0.43	CT-1701‡, CT-2600, CD-2600-6‡	20	200
<b>P6-10R-E</b>		0.05	#10	1.21	0.47	0.43		20	200
<b>P6-14R-E</b>		0.05	1/4"	1.21	0.47	0.43		20	200
<b>P6-56R-E</b>		0.05	5/16"	1.33	0.62	0.51		20	200
<b>P6-38R-E</b>		0.05	3/8"	1.33	0.62	0.51		20	200
<b>P6-12R-E</b>		0.05	1/2"	1.43	0.82	0.51		20	200
<b>P4-10R-E</b>	4 AWG	0.05	#10	1.40	0.55	0.50	CT-1701‡, CT-2600, CD-2600-4‡	20	200
<b>P4-14R-E</b>		0.05	1/4"	1.40	0.55	0.50		20	200
<b>P4-56R-E</b>		0.05	5/16"	1.46	0.68	0.50		20	200
<b>P4-38R-E</b>		0.05	3/8"	1.46	0.68	0.50		20	200
<b>P4-12R-E</b>	0.05	1/2"	1.55	0.86	0.53	20	200		
<b>P2-10R-X</b>	2 AWG	0.06	#10	1.46	0.68	0.58	CT-1701‡, CT-2600, CD-2600-2‡	10	100
<b>P2-14R-X</b>		0.06	1/4"	1.46	0.68	0.58		10	100
<b>P2-56R-X</b>		0.06	5/16"	1.46	0.68	0.58		10	100
<b>P2-38R-X</b>		0.06	3/8"	1.46	0.68	0.58		10	100
<b>P2-12R-X*</b>		0.06	1/2"	1.55	0.86	0.58		10	100

\*Not CSA Certified.  
\*\*Bulk packaging may be available, contact Panduit Customer Service for additional information.  
‡UL and CSA approved tooling/product combinations. For crimping tool information, see page D1.84 and D1.89.



## Tubular Ring Terminal, Non-Insulated

### Type S-R

- Seamless tubular barrel provides a consistent high performance quality crimp
- Round double thick tongue for reliable power applications
- Barrel of terminal internally beveled to provide quick and easy wire insertion
- Inspection window allows visual inspection of proper wire insertion
- Maximum recommended operating temperature 302°F (150°C)
- UL and CSA rated up to 2000 V per UL 486A – 486B

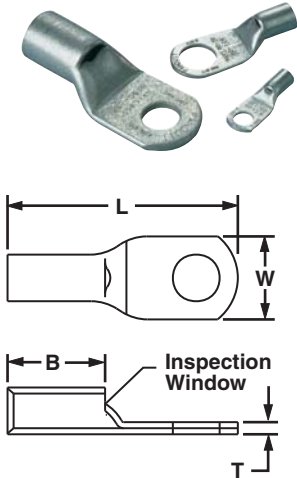

Min. Tensile Strength of Tubular Ring Terminals			
#8	#6	#4	#2
90	100	140	180

Part Number	Wire Range	Stud Hole Size	Tongue Width (In.)	Figure Dimensions (In.)			Recommended Installation Tool	Std. Pkg. Qty.**	Std. Ctn. Qty.
				W	L	B			
S8-10R-Q	8 AWG	#10	0.41	1.10	0.40	0.08	CT-1700, CT-720, CT-930, CT-930CH, CT-940CH, CT-2001, CT-2002, CT-2931, CT-2940	25	250
S8-14R-Q		1/4"	0.48	1.20	0.40	0.07		25	–
S8-56R-Q		5/16"	0.60	1.30	0.40	0.05		25	250
S8-38R-Q		3/8"	0.60	1.40	0.40	0.05		25	250
S6-10R-E	6 AWG	#10	0.45	1.20	0.48	0.09		20	200
S6-14R-E		1/4"	0.48	1.30	0.48	0.08		20	–
S6-56R-E		5/16"	0.56	1.40	0.48	0.07		20	200
S6-38R-E		3/8"	0.62	1.50	0.48	0.06		20	200
S4-10R-E	4 AWG	#10	0.55	1.20	0.48	0.09		20	200
S4-14R-E		1/4"	0.55	1.30	0.48	0.09		20	200
S4-56R-E		5/16"	0.55	1.40	0.48	0.09		20	200
S4-38R-E		3/8"	0.62	1.50	0.48	0.07		20	200
S2-10R-X	1 – 2 AWG	#10	0.70	1.60	0.59	0.11	10	100	
S2-14R-X		1/4"	0.70	1.60	0.59	0.11	10	100	
S2-56R-X		5/16"	0.70	1.70	0.59	0.11	10	100	
S2-38R-X		3/8"	0.70	1.70	0.59	0.11	10	100	
S2-12R-X		1/2"	0.79	1.90	0.59	0.09	10	100	
S1/0-14R-X	1/0 AWG	1/4"	0.76	1.60	0.58	0.12	10	100	
S1/0-56R-X		5/16"	0.76	1.70	0.58	0.12	10	100	
S1/0-38R-X		3/8"	0.76	1.70	0.58	0.12	10	100	
S1/0-12R-X		1/2"	0.82	1.90	0.58	0.12	10	100	
S2/0-14R-X	2/0 AWG	1/4"	0.85	1.90	0.66	0.13	10	100	
S2/0-56R-X		5/16"	0.85	1.90	0.66	0.13	10	100	
S2/0-38R-X		3/8"	0.85	1.90	0.66	0.13	10	100	
S2/0-76R-X		7/16"	0.85	2.10	0.66	0.13	10	100	
S2/0-12R-X		1/2"	0.85	2.10	0.66	0.13	10	100	
S3/0-14R-5	3/0 AWG	1/4"	0.96	2.10	0.83	0.13	5	50	
S3/0-56R-5		5/16"	0.96	2.10	0.83	0.13	5	50	
S3/0-38R-5		3/8"	0.96	2.10	0.83	0.13	5	50	
S3/0-76R-5		7/16"	0.96	2.30	0.83	0.13	5	50	
S3/0-12R-5		1/2"	0.96	2.30	0.83	0.13	5	50	
S4/0-56R-5	4/0 AWG	5/16"	1.06	2.30	0.91	0.14	5	50	
S4/0-38R-5		3/8"	1.06	2.30	0.91	0.14	5	50	
S4/0-76R-5		7/16"	1.06	2.50	0.91	0.14	5	50	
S4/0-12R-5		1/2"	1.06	2.50	0.91	0.14	5	50	
S250-56R-5	250 kcmil	5/16"	1.17	2.50	1.01	0.14	5	50	
S250-38R-5		3/8"	1.17	2.50	1.01	0.14	5	50	
S250-76R-5		7/16"	1.17	2.60	1.01	0.14	5	50	
S250-12R-5		1/2"	1.17	2.60	1.01	0.14	5	50	

For crimping tool information, see pages D1.84, D1.87, D3.37 – D3.46.

\*\*Bulk packaging may be available, contact Panduit Customer Service for additional information.

A.  
System  
Overview

B1.  
Cable Ties

B2.  
Cable  
Accessories

B3.  
Stainless  
Steel Ties

C1.  
Wiring  
Duct

C2.  
Surface  
Raceway

C3.  
Abrasion  
Protection

C4.  
Cable  
Management

D1.  
Terminals

D2.  
Power  
Connectors

D3.  
Grounding  
Connectors

E1.  
Labeling  
Systems

E2.  
Labels

E3.  
Pre-Printed  
& Write-On  
Markers

E4.  
Permanent  
Identification

E5.  
Lockout/  
Tagout  
& Safety  
Solutions

F.  
Index

A. System Overview

B1. Cable Ties

B2. Cable Accessories

B3. Stainless Steel Ties

C1. Wiring Duct

C2. Surface Raceway

C3. Abrasion Protection

C4. Cable Management

D1. Terminals

D2. Power Connectors

D3. Grounding Connectors

E1. Labeling Systems

E2. Labels

E3. Pre-Printed & Write-On Markers

E4. Permanent Identification

E5. Lockout/Tagout & Safety Solutions

F. Index



## Fork Terminal, Nylon Insulated

### Type PN-F

- Fork design provides for fast and easy installation, without the need to remove fastener
- Metal insulation grip sleeve crimps to wire insulation, providing protection to the crimp joint during high vibration applications

- Internal barrel serrations assure good wire contact and maximum tensile strength
- UL Flammability UL 94V-2/HB, maximum insulation temperature 221°F (105°C)
- UL and CSA rated up to 600 V per UL 486A/B



Part Number	Wire Range	Color Code	Stock Thickness (In.)	Max. Ins. (In.)	Stud Size	Figure Dimensions (In.)			Recommended Installation Tool	Std. Pkg. Qty.**	Std. Ctn. Qty.
						L	W	C			
<b>PN22-2F-C*</b>	26 – 22 AWG	Yellow	0.02	0.090	#2	0.66	0.20	0.19	CT-600-A, CT-1525, CT-2500	100	1000
<b>PN22-4F-C*</b>			0.02	0.090	#4	0.67	0.20	0.21			
<b>PN22-6F-C*</b>			0.02	0.090	#6	0.77	0.25	0.26			
<b>PN18-6FN-C*</b>	22 – 18 AWG	Red	0.03	0.145	#6	0.78	0.24	0.20	CT-100A‡, CT-600-A‡, CT-1550‡, CT-1551‡, CT-2500‡	100	500
<b>PN18-6F-C</b>			0.03	0.145	#6	0.78	0.30	0.20			
<b>PN18-8F-C</b>			0.03	0.145	#8	0.85	0.32	0.23			
<b>PN18-10FN-C*</b>			0.03	0.145	#10	0.86	0.31	0.25			
<b>PN18-10F-C</b>			0.03	0.145	#10	0.86	0.35	0.25			
<b>PN18-14F-C</b>			0.03	0.145	1/4"	1.03	0.44	0.33			
<b>PN14-6FN-C*</b>	18 – 14 AWG	Blue	0.03	0.162	#6	0.79	0.24	0.19	CT-100A‡, CT-600-A‡, CT-1550‡, CT-1551‡, CT-2500‡	100	500
<b>PN14-6F-C</b>			0.03	0.162	#6	0.79	0.28	0.19			
<b>PN14-8F-C</b>			0.03	0.162	#8	0.85	0.31	0.23			
<b>PN14-10FN-C*</b>			0.03	0.162	#10	0.87	0.31	0.24			
<b>PN14-10F-C</b>			0.03	0.162	#10	0.87	0.34	0.24			
<b>PN14-14F-C</b>			0.03	0.162	1/4"	1.02	0.44	0.32			
<b>PN10-6F-L</b>	12 – 10 AWG	Yellow	0.04	0.225	#6	1.00	0.31	0.22	CT-100A‡, CT-600-A‡, CT-1550‡, CT-1551‡, CT-2500‡	50	500
<b>PN10-8F-L</b>			0.04	0.225	#8	1.03	0.37	0.22			
<b>PN10-10F-L</b>			0.04	0.225	#10	1.04	0.37	0.22			
<b>PN10-14F-L</b>			0.04	0.225	1/4"	1.14	0.49	0.30			

\*Not UL Listed or CSA Certified.

\*\*Bulk packaging may be available, contact Panduit Customer Service for additional information.

‡UL and CSA approved tooling/product combinations. For crimping tool information, see pages D1.83, D1.84, D1.86 and D1.88.



## Fork Terminal, Nylon Insulated – Funnel Entry

### Type PNF-F

- Fork design provides for fast and easy installation, without the need to remove fastener
- Metal insulation grip sleeve crimps to wire insulation, providing protection to the crimp joint during high vibration applications

- Internal barrel serrations assure good wire contact and maximum tensile strength
- UL Flammability UL 94V-2/HB, maximum insulation temperature 221°F (105°C)
- UL and CSA rated up to 600 V per UL 486A/B



Part Number	Wire Range	Color Code	Stock Thickness (In.)	Max. Ins. (In.)	Stud Size	Figure Dimensions (In.)			Recommended Installation Tool	Std. Pkg. Qty.**	Std. Ctn. Qty.
						L	W	C			
<b>PNF18-6F-C</b>	22 – 18 AWG	Red	0.03	0.136	#6	0.80	0.30	0.22	CT-100A‡, CT-600-A‡, CT-1550‡, CT-1551‡, CT-2500‡	100	500
<b>PNF18-8F-C</b>			0.03	0.136	#8	0.86	0.31	0.25			
<b>PNF18-10F-C</b>			0.03	0.136	#10	0.87	0.34	0.26			
<b>PNF18-14F-C</b>			0.03	0.136	1/4"	1.05	0.44	0.35			
<b>PNF14-6F-C</b>	16 – 14 AWG	Blue	0.03	0.162	#6	0.80	0.28	0.22	CT-100A‡, CT-600-A‡, CT-1550‡, CT-1551‡, CT-2500‡	100	500
<b>PNF14-8F-C</b>			0.03	0.162	#8	0.85	0.31	0.25			
<b>PNF14-10F-C</b>			0.03	0.162	#10	0.87	0.34	0.26			
<b>PNF14-14F-C</b>			0.03	0.162	1/4"	1.05	0.44	0.35			
<b>PNF10-6F-L</b>	12 – 10 AWG	Yellow	0.04	0.225	#6	1.01	0.31	0.24	CT-100A‡, CT-600-A‡, CT-1550‡, CT-1551‡, CT-2500‡	50	500
<b>PNF10-8F-L</b>			0.04	0.225	#8	1.02	0.37	0.24			
<b>PNF10-10F-L</b>			0.04	0.225	#10	1.04	0.37	0.24			
<b>PNF10-14F-L</b>			0.04	0.225	1/4"	1.15	0.50	0.31			

\*\*Bulk packaging may be available, contact Panduit Customer Service for additional information.

‡UL and CSA approved tooling/product combinations. For crimping tool information, see pages D1.83, D1.84, D1.86 and D1.88.



## Fork Terminal, Vinyl Insulated – Funnel Entry

### Type PV-F

- Fork design provides for fast and easy installation, without the need to remove fastener
- Insulation support helps to prevent wire damage in bending applications
- Brazed seam protects terminal barrel from splitting during the crimp process
- Internal barrel serrations assure good wire contact and maximum tensile strength
- UL Flammability UL 94V-0, maximum insulation temperature 221°F (105°C)
- UL and CSA rated up to 600 V per UL 486A/B

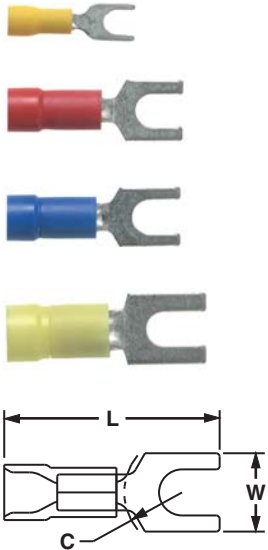

Part Number	Wire Range	Color Code	Stock Thickness (In.)	Max. Ins. (In.)	Stud Size	Figure Dimensions (In.)			Recommended Installation Tool	Std. Pkg. Qty.**	Std. Ctn. Qty.
						L	W	C			
PV22-2F-CY*	26 – 22 AWG	Yellow	0.02	0.110	#2	0.61	0.20	0.19	CT-600-A, CT-1525, CT-2500	100	1000
PV22-4F-CY*			0.02	0.110	#4	0.67	0.20	0.21		100	1000
PV22-6F-CY*			0.02	0.110	#6	0.76	0.25	0.26		100	1000
PV18-6FN-CY*	22 – 16 AWG	Red	0.03	0.150	#6	0.85	0.24	0.21	CT-100A‡, CT-600-A‡, CT-1550‡, CT-1551‡, CT-2500‡	100	500
PV18-6F-CY			0.03	0.150	#6	0.86	0.30	0.21		100	500
PV18-8F-CY			0.03	0.150	#8	0.93	0.32	0.25		100	500
PV18-10FN-CY*			0.03	0.150	#10	0.93	0.31	0.25		100	500
PV18-10F-CY			0.03	0.150	#10	0.93	0.35	0.25		100	500
PV14-6FN-C*	16 – 14 AWG	Blue	0.03	0.170	#6	0.84	0.24	0.19	CT-100A‡, CT-600-A‡, CT-1550‡, CT-1551‡, CT-2500‡	100	500
PV14-6F-C			0.03	0.170	#6	0.84	0.28	0.19		100	500
PV14-8F-C			0.03	0.170	#8	0.90	0.31	0.23		100	500
PV14-10FN-C*			0.03	0.170	#10	0.92	0.31	0.24		100	500
PV14-10F-C			0.03	0.170	#10	0.92	0.34	0.24		100	500
PV14-14F-C			0.03	0.170	1/4"	1.09	0.44	0.32		100	1000
PV10-6F-L			14 – 10 AWG	Yellow	0.04	0.225	#6	1.01		0.31	0.25
PV10-8F-L	0.04	0.225			#8	1.04	0.37	0.25	50	500	
PV10-10F-L	0.04	0.225			#10	1.04	0.37	0.25	50	500	
PV10-14F-L	0.04	0.225			1/4"	1.14	0.49	0.32	50	500	

\*Not UL Listed or CSA Certified.

\*\*Bulk packaging may be available, contact Panduit Customer Service for additional information.

‡UL and CSA approved tooling/product combinations. For crimping tool information, see pages D1.83, D1.84, D1.86 and D1.88.

A. System Overview

B1. Cable Ties

B2. Cable Accessories

B3. Stainless Steel Ties

C1. Wiring Duct

C2. Surface Raceway

C3. Abrasion Protection

C4. Cable Management

D1. Terminals

D2. Power Connectors

D3. Grounding Connectors

E1. Labeling Systems

E2. Labels

E3. Pre-Printed & Write-On Markers

E4. Permanent Identification

E5. Lockout/Tagout & Safety Solutions

F. Index

A. System Overview

B1. Cable Ties

B2. Cable Accessories

B3. Stainless Steel Ties

C1. Wiring Duct

C2. Surface Raceway

C3. Abrasion Protection

C4. Cable Management

D1. Terminals

D2. Power Connectors

D3. Grounding Connectors

E1. Labeling Systems

E2. Labels

E3. Pre-Printed & Write-On Markers

E4. Permanent Identification

E5. Lockout/Tagout & Safety Solutions

F. Index



## Fork Terminal, Vinyl Insulated – Expanded Insulation

### Type PV-FX

- Expanded wire entry designed to accommodate wire with a larger insulation thickness
- Fork design provides for fast and easy installation, without the need to remove fastener
- Insulation support helps to prevent wire damage in bending applications
- Brazed seam protects terminal barrel from splitting during the crimp process
- Internal barrel serrations assure good wire contact and maximum tensile strength
- UL Flammability UL 94V-0, maximum insulation temperature 221°F (105°C)
- UL and CSA rated up to 600 V per UL 486A/B

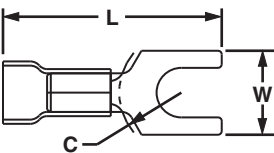

Part Number	Wire Range	Color Code	Stock Thickness (In.)	Max. Ins. (In.)	Stud Size	Figure Dimensions (In.)			Recommended Installation Tool	Std. Pkg. Qty.**	Std. Ctn. Qty.
						L	W	C			
PV18-6FX-CY	22 – 18 AWG	Red	0.03	0.170	#6	0.83	0.30	0.21	CT-100A‡, CT-600-A‡, CT-1550‡, CT-1551‡, CT-2500‡	100	500
PV18-8FX-CY			0.03	0.170	#8	0.89	0.32	0.25			
PV18-10FX-CY			0.03	0.170	#10	0.91	0.35	0.25			
PV14-6FX-C	18 – 14 AWG	Blue	0.03	0.200	#6	0.89	0.28	0.16	CT-100A‡, CT-600-A‡, CT-1550‡, CT-1551‡, CT-2500‡	100	500
PV14-8FX-C			0.03	0.200	#8	0.96	0.31	0.20			
PV14-10FX-C			0.03	0.200	#10	0.97	0.34	0.22			
PV10-8FX-L	12 – 10 AWG	Yellow	0.04	0.250	#8	1.11	0.37	0.24	CT-100A‡, CT-600-A‡, CT-1550‡, CT-1551‡, CT-2500‡	50	500
PV10-10FX-L			0.04	0.250	#10	1.11	0.37	0.24			
PV10-14FX-L			0.04	0.250	1/4"	1.22	0.50	0.32			

\*\*Bulk packaging may be available, contact Panduit Customer Service for additional information.  
 ‡UL and CSA approved tooling/product combinations. For crimping tool information, see pages D1.83, D1.84, D1.86 and D1.88.



## Locking Fork Terminal, Nylon Insulated

### Type PN-LF

- Locks in place for secure connection
- Fork design provides for fast and easy installation, without the need to remove fastener
- Metal insulation grip sleeve crimps to wire insulation, providing protection to the crimp joint during high vibration applications
- Internal barrel serrations assure good wire contact and maximum tensile strength
- UL Flammability UL 94V-2/HB, maximum insulation temperature 221°F (105°C)
- UL and CSA rated up to 600 V per UL 486A/B

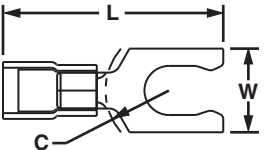

Part Number	Wire Range	Color Code	Stock Thickness (In.)	Max. Ins. (In.)	Stud Size	Figure Dimensions (In.)			Recommended Installation Tool	Std. Pkg. Qty.**	Std. Ctn. Qty.
						L	W	C			
PN18-6LF-C	22 – 18 AWG	Red	0.03	0.145	#6	0.82	0.27	0.22	CT-100A‡, CT-600-A‡, CT-1550‡, CT-1551‡, CT-2500‡	100	500
PN18-6LFW-C			0.03	0.145	#6	0.85	0.29	0.22			
PN18-8LF-C			0.03	0.145	#8	0.89	0.29	0.25			
PN18-10LF-C			0.03	0.145	#10	0.89	0.33	0.25			
PN18-10LFN-C*			0.03	0.145	#10	0.91	0.29	0.25			
PN14-6LF-C	18 – 14 AWG	Blue	0.03	0.162	#6	0.86	0.25	0.22	CT-100A‡, CT-600-A‡, CT-1550‡, CT-1551‡, CT-2500‡	100	500
PN14-6LFW-C			0.03	0.162	#6	0.84	0.29	0.22			
PN14-8LF-C			0.03	0.162	#8	0.92	0.29	0.25			
PN14-10LF-C			0.03	0.162	#10	0.91	0.33	0.25			
PN14-10LFN-C*			0.03	0.162	#10	0.91	0.28	0.25			
PN10-6LF-L	12 – 10 AWG	Yellow	0.04	0.225	#6	1.02	0.30	0.23	CT-100A‡, CT-600-A‡, CT-1550‡, CT-1551‡, CT-2500‡	50	500
PN10-8LF-L			0.04	0.225	#8	1.05	0.30	0.23			
PN10-10LF-L			0.04	0.225	#10	1.05	0.34	0.23			
PN10-14LF-L			0.04	0.225	1/4"	1.17	0.46	0.32			

\*Not UL Listed or CSA Certified.  
 \*\*Bulk packaging may be available, contact Panduit Customer Service for additional information.  
 ‡UL and CSA approved tooling/product combinations. For crimping tool information, see pages D1.83, D1.84, D1.86 and D1.88.





## Locking Fork Terminal, Nylon Insulated – Funnel Entry

### Type PNF-LF

- Locks in place for secure connection
- Fork design provides for fast and easy installation, without the need to remove fastener
- Metal insulation grip sleeve crimps to wire insulation, providing protection to the crimp joint during high vibration applications

- Internal barrel serrations assure good wire contact and maximum tensile strength
- UL Flammability UL 94V-2/HB, maximum insulation temperature 221°F (105°C)
- UL and CSA rated up to 600 V per UL 486A/B

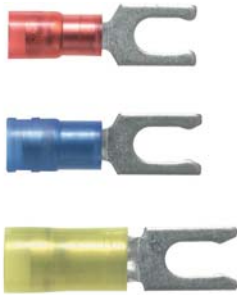

Part Number	Wire Range	Color Code	Stock Thickness (In.)	Max. Ins. (In.)	Stud Size	Figure Dimensions (In.)			Recommended Installation Tool	Std. Pkg. Qty.**	Std. Ctn. Qty.
						L	W	C			
<b>PNF18-6LF-C</b>	22 – 18 AWG	Red	0.03	0.145	#6	0.82	0.27	0.20	CT-100A‡, CT-600-A‡, CT-1550‡, CT-1551‡, CT-2500‡	100	500
<b>PNF18-6LFW-C</b>			0.03	0.145	#6	0.85	0.29	0.20			
<b>PNF18-8LF-C</b>			0.03	0.145	#8	0.89	0.29	0.26			
<b>PNF18-10LF-C</b>	18 – 14 AWG	Blue	0.03	0.145	#10	0.89	0.33	0.25	CT-100A‡, CT-600-A‡, CT-1550‡, CT-1551‡, CT-2500‡	100	500
<b>PNF14-6LF-C</b>			0.03	0.162	#6	0.87	0.25	0.20			
<b>PNF14-6LFW-C</b>			0.03	0.162	#6	0.84	0.29	0.20			
<b>PNF14-8LF-C</b>	12 – 10 AWG	Yellow	0.03	0.162	#8	0.93	0.29	0.25	CT-100A‡, CT-600-A‡, CT-1550‡, CT-1551‡, CT-2500‡	100	500
<b>PNF14-10LF-C</b>			0.03	0.162	#10	0.93	0.33	0.25			
<b>PNF10-6LF-L</b>			0.04	0.225	#6	1.02	0.30	0.20			
<b>PNF10-8LF-L</b>	12 – 10 AWG	Yellow	0.04	0.225	#8	1.05	0.30	0.20	CT-100A‡, CT-600-A‡, CT-1550‡, CT-1551‡, CT-2500‡	50	500
<b>PNF10-10LF-L</b>			0.04	0.225	#10	1.05	0.34	0.22			
<b>PNF10-14LF-L</b>			0.04	0.225	1/4"	1.19	0.46	0.33			

\*\*Bulk packaging may be available, contact Panduit Customer Service for additional information.

‡UL and CSA approved tooling/product combinations. For crimping tool information, see pages D1.83, D1.84, D1.86 and D1.88.



## Locking Fork Terminal, Vinyl Insulated – Funnel Entry

### Type PV-LF

- Locks in place for secure connection
- Fork design provides for fast and easy installation, without the need to remove fastener
- Insulation support helps to prevent wire damage in bending applications

- Internal barrel serrations assure good wire contact and maximum tensile strength
- UL Flammability UL 94V-0, maximum insulation temperature 221°F (105°C)
- UL and CSA rated up to 600 V per UL 486A/B



Part Number	Wire Range	Color Code	Stock Thickness (In.)	Max. Ins. (In.)	Stud Size	Figure Dimensions (In.)			Recommended Installation Tool	Std. Pkg. Qty.**	Std. Ctn. Qty.
						L	W	C			
<b>PV18-6LF-CY</b>	22 – 18 AWG	Red	0.03	0.150	#6	0.90	0.27	0.22	CT-100A‡, CT-600-A‡, CT-1550‡, CT-1551‡, CT-2500‡	100	500
<b>PV18-6LFW-CY</b>			0.03	0.150	#6	0.90	0.29	0.22			
<b>PV18-8LF-CY</b>			0.03	0.150	#8	0.97	0.29	0.25			
<b>PV18-10LF-CY</b>	18 – 14 AWG	Blue	0.03	0.150	#10	0.97	0.33	0.25	CT-100A‡, CT-600-A‡, CT-1550‡, CT-1551‡, CT-2500‡	100	500
<b>PV18-10LFN-CY*</b>			0.03	0.150	#10	0.97	0.29	0.25			
<b>PV14-6LF-C</b>			0.03	0.170	#6	0.90	0.25	0.22			
<b>PV14-6LFW-C</b>	12 – 10 AWG	Yellow	0.03	0.170	#6	0.90	0.29	0.22	CT-100A‡, CT-600-A‡, CT-1550‡, CT-1551‡, CT-2500‡	100	500
<b>PV14-8LF-C</b>			0.03	0.170	#8	0.97	0.29	0.25			
<b>PV14-10LF-C</b>			0.03	0.170	#10	0.97	0.33	0.25			
<b>PV14-10LFN-C*</b>	12 – 10 AWG	Yellow	0.03	0.170	#10	0.97	0.29	0.25	CT-100A‡, CT-600-A‡, CT-1550‡, CT-1551‡, CT-2500‡	100	500
<b>PV10-6LF-L</b>			0.04	0.225	#6	1.03	0.30	0.23			
<b>PV10-8LF-L</b>			0.04	0.225	#8	1.05	0.30	0.23			
<b>PV10-10LF-L</b>	12 – 10 AWG	Yellow	0.04	0.225	#10	1.04	0.34	0.23	CT-100A‡, CT-600-A‡, CT-1550‡, CT-1551‡, CT-2500‡	50	500
<b>PV10-14LF-L</b>			0.04	0.225	1/4"	1.19	0.46	0.36			

\*Not UL Listed or CSA Certified.

\*\*Bulk packaging may be available, contact Panduit Customer Service for additional information.

‡UL and CSA approved tooling/product combinations. For crimping tool information, see pages D1.83, D1.84, D1.86 and D1.88.

A. System Overview

B1. Cable Ties

B2. Cable Accessories

B3. Stainless Steel Ties

C1. Wiring Duct

C2. Surface Raceway

C3. Abrasion Protection

C4. Cable Management

D1. Terminals

D2. Power Connectors

D3. Grounding Connectors

E1. Labeling Systems

E2. Labels

E3. Pre-Printed & Write-On Markers

E4. Permanent Identification

E5. Lockout/Tagout & Safety Solutions

F. Index

A. System Overview

B1. Cable Ties

B2. Cable Accessories

B3. Stainless Steel Ties

C1. Wiring Duct

C2. Surface Raceway

C3. Abrasion Protection

C4. Cable Management

D1. Terminals

D2. Power Connectors

D3. Grounding Connectors

E1. Labeling Systems

E2. Labels

E3. Pre-Printed & Write-On Markers

E4. Permanent Identification

E5. Lockout/Tagout & Safety Solutions

F. Index



## Locking Fork Terminal, Vinyl Insulated – Expanded Insulation

### Type PV-LFX

- Fork design provides for fast and easy installation, without the need to remove fastener
- Expanded wire entry designed to accommodate wire with a larger insulation thickness
- Locks in place for secure connection
- Insulation support helps to prevent wire damage in bending applications
- Brazed seam protects terminal barrel from splitting during the crimp process
- Internal barrel serrations assure good wire contact and maximum tensile strength
- UL Flammability UL 94V-0, maximum insulation temperature 221°F (105°C)
- UL and CSA rated up to 600 V per UL 486A/B



Part Number	Wire Range	Color Code	Stock Thickness (In.)	Max. Ins. (In.)	Stud Size	Figure Dimensions (In.)			Recommended Installation Tool	Std. Pkg. Qty.**	Std. Ctn. Qty.
						L	W	C			
<b>PV18-6LFX-CY</b>	22 – 16 AWG	Red	0.03	0.170	#6	0.95	0.27	0.20	CT-100A‡, CT-600-A‡, CT-1550‡, CT-1551‡, CT-2500‡	100	500
<b>PV18-8LFX-CY</b>			0.03	0.170	#8	1.01	0.29	0.20			
<b>PV18-10LFX-CY</b>			0.03	0.170	#10	1.04	0.33	0.23			
<b>PV14-6LFX-C</b>	18 – 14 AWG	Blue	0.03	0.200	#6	0.95	0.25	0.20	CT-100A‡, CT-600-A‡, CT-1550‡, CT-1551‡, CT-2500‡	100	500
<b>PV14-8LFX-C</b>			0.03	0.200	#8	1.01	0.29	0.23			
<b>PV14-10LFX-C</b>			0.03	0.200	#10	1.01	0.33	0.23			
<b>PV10-6LFX-L</b>	12 – 10 AWG	Yellow	0.04	0.250	#6	1.09	0.30	0.23	CT-100A‡, CT-600-A‡, CT-1550‡, CT-1551‡, CT-2500‡	50	500
<b>PV10-8LFX-L</b>			0.04	0.250	#8	1.12	0.30	0.23			
<b>PV10-10LFX-L</b>			0.04	0.250	#10	1.12	0.34	0.23			
<b>PV10-14LFX-L</b>			0.04	0.250	1/4"	1.25	0.46	0.32			

\*\*Bulk packaging may be available, contact Panduit Customer Service for additional information.  
 ‡UL and CSA approved tooling/product combinations. For crimping tool information, see pages D1.83, D1.84, D1.86 and D1.88.



## Short Locking Fork Terminal, Nylon Insulated

### Type PN-SLF

- Locks in place for a secure connection in limited spaces
- Fork design provides for fast and easy installation, without the need to remove fastener
- Metal insulation grip sleeve crimps to wire insulation, providing protection to the crimp joint during high vibration applications
- Internal barrel serrations assure good wire contact and maximum tensile strength
- UL Flammability UL 94V-2/HB, maximum insulation temperature 221°F (105°C)
- UL and CSA rated up to 600 V per UL 486A/B

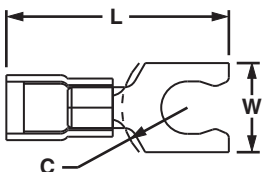

Part Number	Wire Range	Color Code	Stock Thickness (In.)	Max. Ins. (In.)	Stud Size	Figure Dimensions (In.)			Recommended Installation Tool	Std. Pkg. Qty.**	Std. Ctn. Qty.
						L	W	C			
<b>PN18-5SLF-C</b>	22 – 18 AWG	Red	0.03	0.145	#5	0.75	0.26	0.19	CT-1550, CT-1551, CT-2500	100	500
<b>PN18-6SLF-C</b>			0.03	0.145	#6	0.75	0.27	0.19			
<b>PN18-8SLF-C</b>			0.03	0.145	#8	0.80	0.29	0.23			
<b>PN18-10SLF-C</b>	16 – 14 AWG	Blue	0.03	0.145	#10	0.81	0.33	0.23	CT-1550, CT-1551, CT-2500	100	500
<b>PN14-5SLF-C</b>			0.03	0.162	#5	0.75	0.25	0.19			
<b>PN14-6SLF-C</b>			0.03	0.162	#6	0.75	0.25	0.19			
<b>PN14-8SLF-C</b>			0.03	0.162	#8	0.80	0.29	0.23			
<b>PN14-10SLF-C</b>	12 – 10 AWG	Yellow	0.03	0.162	#10	0.81	0.33	0.23	CT-1550, CT-1551, CT-2500	100	500
<b>PN14-14SLF-C</b>			0.03	0.162	1/4"	0.90	0.44	0.28			
<b>PN10-5SLF-L</b>			0.04	0.225	#5	0.86	0.25	0.22			
<b>PN10-6SLF-L</b>			0.04	0.225	#6	0.86	0.25	0.22			
<b>PN10-8SLF-L</b>			0.04	0.225	#8	0.92	0.29	0.26			
<b>PN10-10SLF-L</b>	12 – 10 AWG	Yellow	0.04	0.225	#10	0.92	0.33	0.26	CT-1550, CT-1551, CT-2500	50	500
<b>PN10-14SLF-L</b>			0.04	0.225	1/4"	1.01	0.45	0.33			

\*\*Bulk packaging may be available, contact Panduit Customer Service for additional information.  
 For crimping tool information, see pages D1.84 and D1.88.



## Short Locking Fork Terminal, Nylon Insulated – Funnel Entry

### Type PNF-SLF

- Locks in place for a secure connection in limited spaces
- Fork design provides for fast and easy installation, without the need to remove fastener
- Metal insulation grip sleeve crimps to wire insulation, providing protection to the crimp joint during high vibration applications

- Internal barrel serrations assure good wire contact and maximum tensile strength
- UL Flammability UL 94V-2/HB, maximum insulation temperature 221°F (105°C)
- UL and CSA rated up to 600 V per UL 486A/B



Part Number	Wire Range	Color Code	Stock Thickness (In.)	Max. Ins. (In.)	Stud Size	Figure Dimensions (In.)			Recommended Installation Tool	Std. Pkg. Qty.**	Std. Ctn. Qty.
						L	W	C			
PNF18-5SLF-C	22 – 18 AWG	Red	0.03	0.145	#5	0.75	0.26	0.19	CT-1550, CT-1551, CT-2500	100	500
PNF18-6SLF-C			0.03	0.145	#6	0.75	0.27	0.19			
PNF18-8SLF-C			0.03	0.145	#8	0.80	0.29	0.23			
PNF18-10SLF-C			0.03	0.145	#10	0.81	0.33	0.23			
PNF14-5SLF-C	16 – 14 AWG	Blue	0.03	0.162	#5	0.75	0.25	0.19	CT-1550, CT-1551, CT-2500	100	500
PNF14-6SLF-C			0.03	0.162	#6	0.75	0.25	0.19			
PNF14-8SLF-C			0.03	0.162	#8	0.82	0.29	0.23			
PNF14-10SLF-C			0.03	0.162	#10	0.81	0.33	0.23			
PNF14-14SLF-C			0.03	0.162	1/4"	0.91	0.44	0.28			
PNF10-6SLF-L	12 – 10 AWG	Yellow	0.04	0.225	#6	0.91	0.25	0.17	CT-1550, CT-1551, CT-2500	50	500
PNF10-8SLF-L			0.04	0.225	#8	0.92	0.29	0.22			
PNF10-10SLF-L			0.04	0.225	#10	0.93	0.33	0.22			
PNF10-14SLF-L			0.04	0.225	1/4"	1.02	0.45	0.28			

\*\*Bulk packaging may be available, contact Panduit Customer Service for additional information. For crimping tool information, see pages D1.84 and D1.88.



## Short Locking Fork Terminal, Vinyl Insulated – Funnel Entry

### Type PV-SLF

- Locks in place for a secure connection in limited spaces
- Fork design provides for fast and easy installation, without the need to remove fastener
- Insulation support helps to prevent wire damage in bending applications

- Internal barrel serrations assure good wire contact and maximum tensile strength
- UL Flammability UL 94V-0, maximum insulation temperature 221°F (105°C)
- UL and CSA rated up to 600 V per UL 486A/B



Part Number	Wire Range	Color Code	Stock Thickness (In.)	Max. Ins. (In.)	Stud Size	Figure Dimensions (In.)			Recommended Installation Tool	Std. Pkg. Qty.**	Std. Ctn. Qty.
						L	W	C			
PV18-5SLF-CY^	22 – 18 AWG	Red	0.03	0.150	#5	0.82	0.26	0.19	CT-1550, CT-1551, CT-2500	100	500
PV18-6SLF-CY^			0.03	0.150	#6	0.82	0.27	0.19			
PV18-8SLF-CY^			0.03	0.150	#8	0.87	0.29	0.23			
PV18-10SLF-CY^			0.03	0.150	#10	0.88	0.33	0.23			
PV14-5SLF-C*	16 – 14 AWG	Blue	0.03	0.175	#5	0.80	0.25	0.22	CT-1550, CT-1551, CT-2500	100	1000
PV14-6SLF-C*			0.03	0.175	#6	0.80	0.25	0.22			
PV14-8SLF-C*			0.03	0.175	#8	0.85	0.29	0.26			
PV14-10SLF-C*			0.03	0.175	#10	0.86	0.33	0.26			
PV14-14SLF-C*			0.03	0.175	1/4"	0.95	0.44	0.33			
PV10-5SLF-L	12 – 10 AWG	Yellow	0.04	0.225	#5	0.86	0.25	0.22	CT-1550, CT-1551, CT-2500	50	500
PV10-6SLF-L			0.04	0.225	#6	0.87	0.25	0.22			
PV10-8SLF-L			0.04	0.225	#8	0.92	0.29	0.26			
PV10-10SLF-L			0.04	0.225	#10	0.92	0.33	0.26			
PV10-14SLF-L			0.04	0.225	1/4"	1.02	0.45	0.33			

\*Not UL Listed or CSA Certified.

\*\*Bulk packaging may be available, contact Panduit Customer Service for additional information. For crimping tool information, see pages D1.84 and D1.88.

^CSA Certified only.

A. System Overview

B1. Cable Ties

B2. Cable Accessories

B3. Stainless Steel Ties

C1. Wiring Duct

C2. Surface Raceway

C3. Abrasion Protection

C4. Cable Management

D1. Terminals

D2. Power Connectors

D3. Grounding Connectors

E1. Labeling Systems

E2. Labels

E3. Pre-Printed & Write-On Markers

E4. Permanent Identification

E5. Lockout/Tagout & Safety Solutions

F. Index

A. System Overview

B1. Cable Ties

B2. Cable Accessories

B3. Stainless Steel Ties

C1. Wiring Duct

C2. Surface Raceway

C3. Abrasion Protection

C4. Cable Management

D1. Terminals

D2. Power Connectors

D3. Grounding Connectors

E1. Labeling Systems

E2. Labels

E3. Pre-Printed & Write-On Markers

E4. Permanent Identification

E5. Lockout/Tagout & Safety Solutions

F. Index



## Flanged Fork Terminal, Nylon Insulated

### Type PN-FF

- Fork design provides for fast and easy installation, without the need to remove fastener
- Flange design provides extra secure connection on a variety of applications
- Metal insulation grip sleeve crimps to wire insulation, providing protection to the crimp joint during high vibration applications

- Internal barrel serrations assure good wire contact and maximum tensile strength
- UL Flammability UL 94V-2/HB, maximum insulation temperature 221°F (105°C)
- UL and CSA rated up to 600 V per UL 486A/B

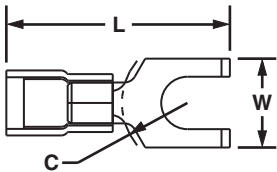

Part Number	Wire Range	Color Code	Stock Thickness (In.)	Max. Ins. (In.)	Stud Size	Figure Dimensions (In.)			Recommended Installation Tool	Std. Pkg. Qty.**	Std. Ctn. Qty.
						L	W	C			
<b>PN18-6FF-C</b>	22 – 16 AWG	Red	0.03	0.136	#6	0.81	0.28	0.20	CT-100A‡, CT-600-A‡, CT-1550‡, CT-1551‡, CT-2500‡	100	500
<b>PN18-8FF-C</b>			0.03	0.136	#8	0.88	0.31	0.23			
<b>PN18-10FF-C</b>			0.03	0.136	#10	0.86	0.35	0.23			
<b>PN14-6FF-C</b>	18 – 14 AWG	Blue	0.03	0.162	#6	0.79	0.28	0.20	CT-100A‡, CT-600-A‡, CT-1550‡, CT-1551‡, CT-2500‡	100	500
<b>PN14-8FF-C</b>			0.03	0.162	#8	0.86	0.31	0.23			
<b>PN14-10FF-C</b>			0.03	0.162	#10	0.86	0.36	0.23			
<b>PN10-8FF-L</b>	12 – 10 AWG	Yellow	0.04	0.225	#8	1.05	0.37	0.28	CT-100A‡, CT-600-A‡, CT-1550‡, CT-1551‡, CT-2500‡	50	500
<b>PN10-10FF-L</b>			0.04	0.225	#10	1.05	0.37	0.28			

\*\*Bulk packaging may be available, contact Panduit Customer Service for additional information.

‡UL and CSA approved tooling/product combinations. For crimping tool information, see pages D1.83, D1.84, D1.86 and D1.88.



## Flanged Fork Terminal, Vinyl Insulated – Funnel Entry

### Type PV-FF

- Fork design provides for fast and easy installation, without the need to remove fastener
- Flange design provides extra secure connection on a variety of applications
- Insulation support helps to prevent wire damage in bending applications
- Brazed seam protects terminal barrel from splitting during the crimp process

- Internal barrel serrations assure good wire contact and maximum tensile strength
- UL Flammability UL 94V-0, maximum insulation temperature 221°F (105°C)
- UL and CSA rated up to 600 V per UL 486A/B

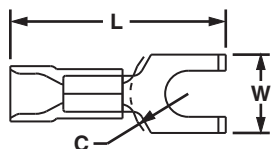

Part Number	Wire Range	Color Code	Stock Thickness (In.)	Max. Ins. (In.)	Stud Size	Figure Dimensions (In.)			Recommended Installation Tool	Std. Pkg. Qty.**	Std. Ctn. Qty.
						L	W	C			
<b>PV18-6FF-CY</b>	22 – 16 AWG	Red	0.03	0.150	#6	0.87	0.28	0.19	CT-100A‡, CT-600-A‡, CT-1550‡, CT-1551‡, CT-2500‡	100	500
<b>PV18-8FF-CY</b>			0.03	0.150	#8	0.94	0.31	0.23			
<b>PV18-10FF-CY</b>			0.03	0.150	#10	0.93	0.35	0.23			
<b>PV14-6FF-C</b>	16 – 14 AWG	Blue	0.03	0.165	#6	0.88	0.28	0.19	CT-100A‡, CT-600-A‡, CT-1550‡, CT-1551‡, CT-2500‡	100	500
<b>PV14-8FF-C</b>			0.03	0.165	#8	0.94	0.31	0.23			
<b>PV14-10FF-C</b>			0.03	0.165	#10	0.94	0.35	0.23			
<b>PV10-8FF-L</b>	14 – 10 AWG	Yellow	0.04	0.225	#8	1.03	0.37	0.22	CT-100A‡, CT-600-A‡, CT-1550‡, CT-1551‡, CT-2500‡	50	500
<b>PV10-10FF-L</b>			0.04	0.225	#10	1.03	0.37	0.22			

\*\*Bulk packaging may be available, contact Panduit Customer Service for additional information.

‡UL and CSA approved tooling/product combinations. For crimping tool information, see pages D1.83, D1.84, D1.86 and D1.88.



## Fork Terminal, Non-Insulated

### Type P-F

- Fork design provides for fast and easy installation, without the need to remove fastener
- Internal barrel serrations assure good wire contact and maximum tensile strength
- Brazed seam protects terminal barrel from splitting during the crimp process

- Barrel of terminal internally beveled to provide quick and easy wire insertion
- Maximum recommended operating temperature 302°F (150°C)
- UL and CSA rated up to 2000 V per UL 486A/B



Part Number	Wire Range	Stock Thickness (In.)	Stud Size	Figure Dimensions (In.)			Recommended Installation Tool	Std. Pkg. Qty.**	Std. Ctn. Qty.	
				L	W	C				
P22-2F-C*	26 – 22 AWG	0.02	#2	0.49	0.19	0.19	CT-200	100	1000	
P22-4F-C*		0.02	#4	0.49	0.20	0.19		100	1000	
P22-6F-C*		0.02	#6	0.59	0.25	0.26		100	1000	
P18-6FN-C*	22 – 16 AWG	0.03	#6	0.63	0.24	0.19	CT-100A‡, CT-200‡, CT-600-A‡, CT-1570‡, CT-2500‡	100	1000	
P18-6F-C		0.03	#6	0.63	0.30	0.21		100	1000	
P18-8F-C		0.03	#8	0.69	0.32	0.25		100	1000	
P18-10FN-C*		0.03	#10	0.71	0.31	0.25		100	1000	
P18-10F-C		0.03	#10	0.71	0.35	0.25		100	1000	
P18-14F-C		0.03	1/4"	0.88	0.44	0.33		100	1000	
P14-6FN-C		0.03	#6	0.63	0.24	0.20		CT-100A‡, CT-200‡, CT-600-A‡, CT-1570‡, CT-2500‡	100	1000
P14-6F-C	18 – 14 AWG	0.03	#6	0.63	0.28	0.20	100		1000	
P14-8F-C		0.03	#8	0.69	0.31	0.23	100		1000	
P14-10FN-C		0.03	#10	0.71	0.31	0.25	100		1000	
P14-10F-C		0.03	#10	0.71	0.34	0.25	100		1000	
P14-14F-C		0.03	1/4"	0.88	0.44	0.33	100		1000	
P10-6F-L		12 – 10 AWG	0.04	#6	0.75	0.31	0.22		CT-100A‡, CT-200‡, CT-600-A‡, CT-1570‡, CT-1701‡, CT-2500‡	50
P10-8F-L			0.04	#8	0.78	0.37	0.22	50		500
P10-10F-L	0.04		#10	0.78	0.37	0.23	50	500		
P10-14F-L	0.04		1/4"	0.89	0.50	0.30	50	500		

\*Not UL Listed or CSA Certified.

\*\*Bulk packaging may be available, contact Panduit Customer Service for additional information.

‡UL and CSA approved tooling/product combinations. For crimping tool information, see pages D1.83, D1.84, D1.86 and D1.88.

A. System Overview

B1. Cable Ties

B2. Cable Accessories

B3. Stainless Steel Ties

C1. Wiring Duct

C2. Surface Raceway

C3. Abrasion Protection

C4. Cable Management

D1. Terminals

D2. Power Connectors

D3. Grounding Connectors

E1. Labeling Systems

E2. Labels

E3. Pre-Printed & Write-On Markers

E4. Permanent Identification

E5. Lockout/Tagout & Safety Solutions

F. Index

A. System Overview

B1. Cable Ties

B2. Cable Accessories

B3. Stainless Steel Ties

C1. Wiring Duct

C2. Surface Raceway

C3. Abrasion Protection

C4. Cable Management



## Flanged Fork Terminal, Non-Insulated

### Type P-FF

- Fork design provides for fast and easy installation, without the need to remove fastener
- Flange design provides extra secure connection on a variety of applications
- Internal barrel serrations assure good wire contact and maximum tensile strength
- Brazed seam protects terminal barrel from splitting during the crimp process
- Barrel of terminal internally beveled to provide quick and easy wire insertion
- Maximum recommended operating temperature 302°F (150°C)
- UL and CSA rated up to 2000 V per UL 486A/B

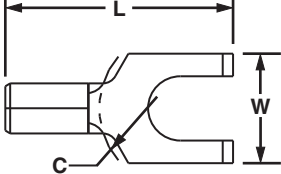

Part Number	Wire Range	Stock Thickness (In.)	Stud Size	Figure Dimensions (In.)			Recommended Installation Tool	Std. Pkg. Qty.**	Std. Ctn. Qty.
				L	W	C			
P18-8FF-C	22 – 16 AWG	0.03	#8	0.72	0.31	0.25	CT-100A‡, CT-200‡, CT-600-A‡, CT-1570‡, CT-2500‡	100	500
P14-6FF-C	16 – 14 AWG	0.03	#6	0.65	0.28	0.22		100	500
P14-8FF-C		0.03	#8	0.72	0.31	0.25		100	500
P10-10FF-L	12 – 10 AWG	0.04	#10	0.80	0.38	0.28	CT-100A‡, CT-200‡, CT-600-A‡, CT-1570‡, CT-1701‡, CT-2500‡	50	500

\*\*Bulk packaging may be available, contact Panduit Customer Service for additional information.

‡UL and CSA approved tooling/product combinations. For crimping tool information, see pages D1.83, D1.84, D1.86 and D1.88.



## Locking Fork Terminal, Non-Insulated

### Type P-LF

- Locks in place for secure connection
- Fork design provides for fast and easy installation, without the need to remove fastener
- Internal barrel serrations assure good wire contact and maximum tensile strength
- Brazed seam protects terminal barrel from splitting during the crimp process
- Barrel of terminal internally beveled to provide quick and easy wire insertion
- Maximum recommended operating temperature 302°F (150°C)
- UL and CSA rated up to 2000 V per UL 486A/B

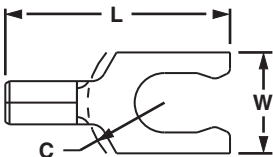

Part Number	Wire Range	Stock Thickness (In.)	Stud Size	Figure Dimensions (In.)			Recommended Installation Tool	Std. Pkg. Qty.**	Std. Ctn. Qty.
				L	W	C			
P18-6LF-C	22 – 16 AWG	0.03	#6	0.68	0.27	0.22	CT-100A‡, CT-200‡, CT-600-A‡, CT-1570‡, CT-2500‡	100	500
P18-6LFW-C		0.03	#6	0.70	0.29	0.22		100	500
P18-8LF-C		0.03	#8	0.74	0.29	0.23		100	500
P18-10LFN-C*		0.03	#10	0.74	0.28	0.23		100	500
P18-10LF-C		0.03	#10	0.74	0.33	0.23		100	500
P14-6LF-C	18 – 14 AWG	0.03	#6	0.70	0.25	0.22	CT-100A‡, CT-200‡, CT-600-A‡, CT-1570‡, CT-2500‡	100	500
P14-6LFW-C		0.03	#6	0.70	0.29	0.22		100	500
P14-8LF-C		0.03	#8	0.77	0.29	0.27		100	500
P14-10LFN-C*		0.03	#10	0.77	0.29	0.27		100	500
P14-10LF-C		0.03	#10	0.77	0.33	0.27		100	500
P10-6LF-L	14 – 10 AWG	0.04	#6	0.77	0.30	0.23	CT-100A‡, CT-200‡, CT-600-A‡, CT-1570‡, CT-1701‡, CT-2500‡	50	500
P10-8LF-L		0.04	#8	0.79	0.30	0.23		50	500
P10-10LF-L		0.04	#10	0.79	0.34	0.23		50	500
P10-14LF-L		0.04	1/4"	0.92	0.46	0.33		50	500

\*Not UL Listed or CSA Certified.

\*\*Bulk packaging may be available, contact Panduit Customer Service for additional information.

‡UL and CSA approved tooling/product combinations. For crimping tool information, see pages D1.83, D1.84, D1.86 and D1.88.



## Short Locking Fork Terminal, Non-Insulated

### Type P-SLF

- Locks in place for a secure connection in limited spaces
- Fork design provides for fast and easy installation, without the need to remove fastener
- Internal barrel serrations assure good wire contact and maximum tensile strength
- Brazed seam protects terminal barrel from splitting during the crimp process
- Barrel of terminal internally beveled to provide quick and easy wire insertion
- Maximum recommended operating temperature 302°F (150°C)
- UL and CSA rated up to 2000 V per UL 486A/B

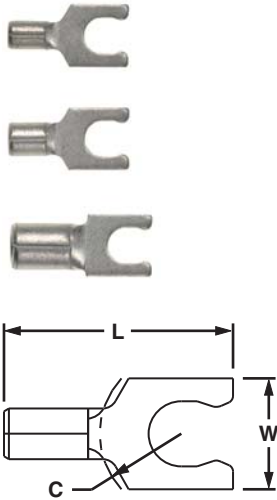

Part Number	Wire Range	Stock Thickness (In.)	Stud Size	Figure Dimensions (In.)			Recommended Installation Tool	Std. Pkg. Qty.**	Std. Ctn. Qty.
				L	W	C			
P18-6SLF-C	22 – 16 AWG	0.03	#6	0.51	0.27	0.22	CT-100A‡, CT-200‡, CT-600-A‡, CT-1570‡, CT-2500‡	100	1000
P18-8SLF-C		0.03	#8	0.56	0.29	0.25		100	1000
P18-10SLF-C		0.03	#10	0.57	0.33	0.25		100	1000
P14-6SLF-C	16 – 14 AWG	0.03	#6	0.51	0.25	0.22	CT-100A‡, CT-200‡, CT-600-A‡, CT-1570‡, CT-2500‡	100	1000
P14-8SLF-C		0.03	#8	0.56	0.29	0.25		100	1000
P14-10SLF-C		0.03	#10	0.57	0.33	0.25		100	1000
P14-14SLF-C		0.03	1/4"	0.66	0.44	0.35		100	1000
P10-5SLF-L	14 – 10 AWG	0.04	#5	0.60	0.25	0.19	CT-100A‡, CT-200‡, CT-600-A‡, CT-1570‡, CT-1701‡, CT-2500‡	50	500
P10-8SLF-L		0.04	#8	0.66	0.29	0.23		50	500
P10-10SLF-L		0.04	#10	0.67	0.33	0.23		50	500
P10-14SLF-L		0.04	1/4"	0.76	0.45	0.28		50	500

\*\*Bulk packaging may be available, contact Panduit Customer Service for additional information.  
 ‡UL and CSA approved tooling/product combinations. For crimping tool information, see pages D1.83, D1.84, D1.86 and D1.88.



## Heat Shrink, Fork Terminal

### Type PH-F

- Heat shrink sleeving forms a protective barrier to provide environmentally sealed terminations ideal for high moisture applications
- Fork design provides for fast and easy installation, without the need to remove fastener
- Brazed seam protects terminal barrel from splitting during the crimp process
- Heat shrink insulation is completed with a standard heat gun
- Minimum continuous operating temperature -65°F (-55°C)
- Maximum continuous operation temperature 230°F (110°C)
- Shrink temperature 300°F (150°C)
- UL and CSA rated up to 600 V per UL 486A/B



Part Number	Wire Range	Color Code	Max. Ins. (In.)	Stud Size	Figure Dimensions (In.)		Wire Strip Length	Recommended Installation Tool	Std. Pkg. Qty.	Std. Ctn. Qty.
					L	W				
PH18-6F-Q	22 – 18 AWG	Red	0.170	#6	1.04	0.32	5/16	CT-310	25	125
PH18-8F-Q			0.170	#8	1.04	0.32	5/16		25	125
PH18-10F-Q			0.170	#10	1.04	0.32	5/16		25	125
PH14-6F-Q	16 – 14 AWG	Blue	0.190	#6	1.07	0.38	5/16	CT-310	25	125
PH14-8F-Q			0.190	#8	1.07	0.38	5/16		25	125
PH14-10F-Q			0.190	#10	1.07	0.38	5/16		25	125
PH10-8F-E	12 – 10 AWG	Yellow	0.240	#8	1.20	0.38	5/16	CT-310	20	100
PH10-10F-E			0.240	#10	1.20	0.38	5/16		20	100

For crimping tool information, see page D1.85.

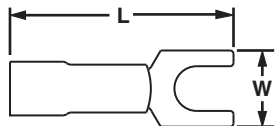

A. System Overview

B1. Cable Ties

B2. Cable Accessories

B3. Stainless Steel Ties

C1. Wiring Duct

C2. Surface Raceway

C3. Abrasion Protection

C4. Cable Management

D1. Terminals

D2. Power Connectors

D3. Grounding Connectors

E1. Labeling Systems

E2. Labels

E3. Pre-Printed & Write-On Markers

E4. Permanent Identification

E5. Lockout/Tagout & Safety Solutions

F. Index

A. System Overview

## Features and Benefits – Pan-Term® Metric Terminals

All Panduit terminals feature high quality materials made with electrolytic copper for high conductivity and are tin-plated for corrosion resistance.

B1. Cable Ties

B2. Cable Accessories

B3. Stainless Steel Ties

C1. Wiring Duct

C2. Surface Raceway

C3. Abrasion Protection

C4. Cable Management

### Nylon Insulated Terminals with Insulation Grip Sleeve Type PMN or PMNF

Internal barrel serrations assure good wire contact and maximum tensile strength

Maximum insulation temperature 221°F (105°C)



Sleeved barrel assures crimp reliability

Insulation grip sleeve provides a superior insulation crimp for high vibration and high strain relief applications

Color-coded insulation identifies wire range

Funnel entry for faster insertion and lower installed cost

Rated up to 600 V.

Flammability – UL 94V-2/HB

Proprietary blend of UL 94V-2 and UL 94HB flammability related materials.

### Vinyl Insulated Terminals with Insulation Support Type PMV

Internal barrel serrations assure good wire contact and maximum tensile strength

Maximum insulation temperature 221°F (105°C)



Color-coded insulation identifies wire range

Brazed seam assures crimp reliability

Insulation crimp provides insulation support to protect electrical crimp

Funnel entry for faster insertion and lower installed cost

Rated up to 600 V.

Flammability – UL 94V-0.

D1. Terminals

D2. Power Connectors

D3. Grounding Connectors

E1. Labeling Systems

E2. Labels

E3. Pre-Printed & Write-On Markers

E4. Permanent Identification

E5. Lockout/Tagout & Safety Solutions

F. Index

### Non-Insulated Terminals Type PM

Maximum recommended operating temperature 302°F (150°C)



Product markings provide easy identification of wire size

Extended barrel length assures a good quality crimp and makes crimping easier

Brazed seam assures crimp reliability

Internal barrel serrations assure good wire contact and maximum tensile strength

Internally beveled barrel for quick easy wire insertion

Rated up to 2000 V.



Panduit extensive line of tooling is specifically designed for optimum crimping performance.

See pages D1.83 – D1.89.



Panduit designs and manufactures a full line of labeling products, software, and printers to assist you with your labeling requirements.

See pages E1.1 – E2.28.



## Part Number System for Pan-Term® Metric Terminals

PM	V	1	—	3	R	—	B	—	C
Type	Insulation	Wire Range		Stud Size	Tongue Configuration		Special Configuration		Std. Pkg. Size
PM = Pan-Term® Metric	N = Nylon NF = Nylon Funnel V = Vinyl	1 = 0.5 – 1.0mm <sup>2</sup> (22 – 18 AWG) 2 = 1.5 – 2.5mm <sup>2</sup> (16 – 14 AWG) 6 = 4.0 – 6.0mm <sup>2</sup> (12 – 10 AWG)	—	3 = M3 (#6) 4 = M4 (#8) 5 = M5 (#10) 6 = M6 (1/4) 8 = M8 (5/16)	R = Ring F = Fork	—	B = Butted Seam	—	X = 10 E = 20 Q = 25 L = 50 C = 100

## Metric Ring Terminal, Nylon Insulated – Funnel Entry

### Type PMNF-R

- Ring tongue design assures a secure connection in high vibration applications
- Internal barrel serrations assure good wire contact and maximum tensile strength
- Maximum insulation temperature 221°F (105°C)
- Rated up to 600 V
- Metal insulation grip sleeve crimps to wire insulation, providing protection to the crimp joint during high vibration applications

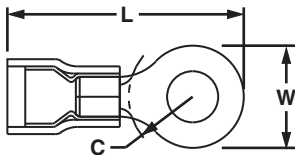

Part Number	Wire Range (mm <sup>2</sup> )	Color Code	Max. Ins. (mm)	Stud Size	Figure Dimensions (mm)			Recommended Installation Tool	Std. Pkg. Qty.	Std. Ctn. Qty.
					L	W	C			
PMNF1-3R-C	0.5 – 1.0	Red	3.76	M3	19.3	5.8	5.3	CT-1550, CT-2500	100	500
PMNF1-4R-C			3.76	M4	21.6	7.9	6.4		100	500
PMNF1-5R-C			3.76	M5	21.8	8.9	6.4		100	500
PMNF1-6R-C			3.76	M6	26.7	10.9	9.7		100	500
PMNF2-3R-C	1.5 – 2.5	Blue	4.11	M3	19.4	5.9	4.8	CT-1550, CT-2500	100	500
PMNF2-4R-C			4.11	M4	21.8	7.9	7.4		100	500
PMNF2-5R-C			4.11	M5	22.4	8.9	7.4		100	500
PMNF2-6R-L			4.11	M6	26.5	10.9	10.7		50	500
PMNF6-3R-L	4.0 – 6.0	Yellow	5.94	M3	26.7	5.8	9.1	CT-1550, CT-2500	50	250
PMNF6-4R-L			5.94	M4	27.4	7.9	9.1		50	250
PMNF6-5R-L			5.94	M5	27.4	9.7	9.1		50	250
PMNF6-6R-L			5.94	M6	30.2	10.9	10.9		50	250
PMNF6-8R-L			5.94	M8	31.5	13.2	10.9		50	250

For crimping tool information, see pages D1.84 and D1.88.

A. System Overview

B1. Cable Ties

B2. Cable Accessories

B3. Stainless Steel Ties

C1. Wiring Duct

C2. Surface Raceway

C3. Abrasion Protection

C4. Cable Management

D1. Terminals

D2. Power Connectors

D3. Grounding Connectors

E1. Labeling Systems

E2. Labels

E3. Pre-Printed & Write-On Markers

E4. Permanent Identification

E5. Lockout/Tagout & Safety Solutions

F. Index

A. System Overview

## Metric Ring Terminal, Vinyl Insulated – Funnel Entry

B1. Cable Ties

### Type PMV-R

- Ring tongue design assures a secure connection in high vibration applications
- Insulation support helps to prevent wire damage in bending applications
- Brazed seam protects terminal barrel from splitting during the crimp process
- Internal barrel serrations assure good wire contact and maximum tensile strength
- Maximum insulation temperature 221°F (105°C)
- Rated up to 600 V

B2. Cable Accessories

B3. Stainless Steel Ties



C1. Wiring Duct



C2. Surface Raceway



C3. Abrasion Protection

C4. Cable Management

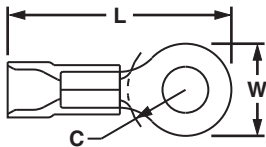

Part Number	Wire Range (mm <sup>2</sup> )	Color Code	Max. Ins. (mm)	Stud Size	Figure Dimensions (mm)			Recommended Installation Tool	Std. Pkg. Qty.	Std. Ctn. Qty.
					L	W	C			
PMV1-3RB-CY	0.5 – 1.0	Red	4.01	M3	20.8	5.8	5.6	CT-1550, CT-2500	100	500
PMV1-4RB-CY			4.01	M4	23.1	7.9	7.4		100	500
PMV1-5RB-CY			4.01	M5	23.1	8.9	7.4		100	500
PMV1-6RB-CY			4.01	M6	28.2	10.9	10.7		100	500
PMV2-3RB-C	1.5 – 2.5	Blue	4.70	M3	20.5	5.8	6.4	CT-1550, CT-2500	100	500
PMV2-4RB-C			4.70	M4	23.1	7.9	6.4		100	500
PMV2-5RB-C			4.70	M5	23.8	8.9	6.4		100	500
PMV2-6RB-C			4.70	M6	25.7	10.9	9.7		100	500
PMV6-3R-L	4.0 – 6.0	Yellow	6.10	M3	26.1	5.8	7.9	CT-1550, CT-2500	50	250
PMV6-4R-L			6.10	M4	26.5	7.9	7.9		50	250
PMV6-5R-L			6.10	M5	27.1	9.5	7.9		50	250
PMV6-6R-L			6.10	M6	30.3	10.9	9.7		50	250
PMV6-8R-L			6.10	M8	31.4	13.2	9.7		50	250

For crimping tool information, see page D1.84 and D1.88.

D1. Terminals

D2. Power Connectors

## Metric Ring Terminal, Non-Insulated

### Type PM-R

- Ring tongue design assures a secure connection in high vibration applications
- Internal barrel serrations assure good wire contact and maximum tensile strength
- Brazed seam protects terminal barrel from splitting during the crimp process
- Barrel of terminal internally beveled to provide quick and easy wire insertion
- Maximum recommended operating temperature 302°F (150°C)
- Rated up to 2000 V

D3. Grounding Connectors

E1. Labeling Systems



E2. Labels



E3. Pre-Printed & Write-On Markers



E4. Permanent Identification

E5. Lockout/Tagout & Safety Solutions

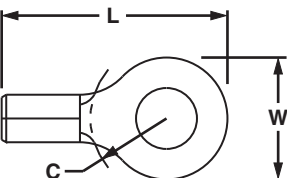

Part Number	Wire Range (mm <sup>2</sup> )	Stud Size	Figure Dimensions (mm)			Recommended Installation Tool	Std. Pkg. Qty.	Std. Ctn. Qty.
			L	W	C			
PM1-3R-C	0.5 – 1.5	M3	15.8	5.8	5.6	CT-1570, CT-2500	100	500
PM1-4R-C		M4	18.0	7.9	7.4		100	500
PM1-5R-C		M5	18.0	8.9	7.4		100	500
PM2-3R-C	1.0 – 2.5	M3	15.8	5.8	5.6	CT-1570, CT-2500	100	500
PM2-4R-C		M4	18.0	7.9	7.4		100	500
PM2-5R-C		M5	18.0	8.9	7.4		100	500
PM6-3R-L	2.5 – 6.0	M3	19.2	5.8	7.9	CT-1570, CT-2500	50	250
PM6-4R-L		M4	19.8	7.9	7.9		50	250
PM6-5R-L		M5	20.6	9.5	7.9		50	250
PM6-6R-L		M6	23.5	10.9	9.7		50	250
PM6-8R-L		M8	24.7	13.3	9.7		50	250

For crimping tool information, see pages D1.84 and D1.88.

## Metric Fork Terminal, Nylon Insulated – Funnel Entry

### Type PMNF-F

- Fork design provides for fast and easy installation, without the need to remove fastener
- Metal insulation grip sleeve crimps to wire insulation, providing protection to the crimp joint during high vibration applications
- Internal barrel serrations assure good wire contact and maximum tensile strength
- Maximum insulation temperature 221°F (105°C)
- Rated up to 600 V

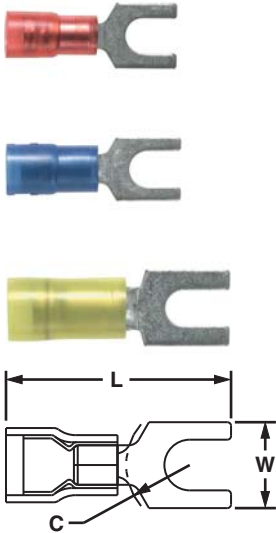

Part Number	Wire Range (mm²)	Color Code	Max. Ins. (mm)	Stud Size	Figure Dimensions (mm)			Recommended Installation Tool	Std. Pkg. Qty.	Std. Ctn. Qty.
					L	W	C			
PMNF1-3F-C	0.5 – 1.0	Red	3.76	M3	21.1	5.9	5.1	CT-1550, CT-2500	100	500
PMNF1-4F-C			3.76	M4	22.6	8.1	5.8		100	500
PMNF1-5F-C			3.76	M5	22.9	8.9	6.4		100	500
PMNF1-6F-C			3.76	M6	27.4	11.2	8.4		100	500
PMNF2-3F-C	1.5 – 2.5	Blue	4.11	M3	19.8	5.9	5.1	CT-1550, CT-2500	100	500
PMNF2-4F-C			4.11	M4	21.3	7.9	5.9		100	500
PMNF2-5F-C			4.11	M5	21.9	8.6	6.4		100	500
PMNF2-6F-C			4.11	M6	26.2	11.2	8.5		100	500
PMNF6-4F-L	4.0 – 6.0	Yellow	5.94	M4	27.2	7.9	6.2	CT-1550, CT-2500	50	250
PMNF6-5F-L			5.94	M5	26.9	9.5	6.2		50	250
PMNF6-6F-L			5.94	M6	29.0	11.0	8.2		50	250

For crimping tool information, see pages D1.84 and D1.88.

## Metric Fork Terminal, Vinyl Insulated – Funnel Entry

### Type PMV-F

- Fork design provides for fast and easy installation, without the need to remove fastener
- Insulation support helps to prevent wire damage in bending applications
- Brazed seam protects terminal barrel from splitting during the crimp process
- Internal barrel serrations assure good wire contact and maximum tensile strength
- Maximum insulation temperature 221°F (105°C)
- Rated up to 600 V

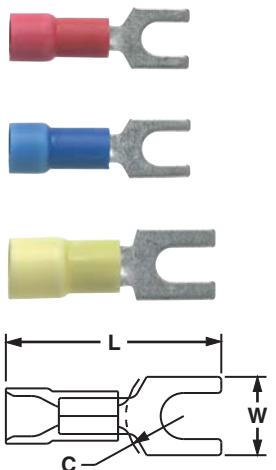

Part Number	Wire Range (mm²)	Color Code	Max. Ins. (mm)	Stud Size	Figure Dimensions (mm)			Recommended Installation Tool	Std. Pkg. Qty.	Std. Ctn. Qty.
					L	W	C			
PMV1-3FB-CY	0.5 – 1.0	Red	4.01	M3	21.6	5.8	4.8	CT-1550, CT-2500	100	500
PMV1-4FB-CY			4.01	M4	23.1	8.1	5.8		100	500
PMV1-5FB-CY			4.01	M5	23.6	9.1	6.1		100	500
PMV1-6FB-CY			4.01	M6	27.9	11.2	8.1		100	500
PMV2-3FB-C	1.5 – 2.5	Blue	4.70	M3	21.3	5.8	4.8	CT-1550, CT-2500	100	500
PMV2-4FB-C			4.70	M4	22.9	7.9	5.8		100	500
PMV2-5FB-C			4.70	M5	23.4	8.6	6.1		100	500
PMV2-6FB-C			4.70	M6	27.7	11.2	8.1		100	500
PMV6-4F-L	2.5 – 6.0	Yellow	6.10	M4	26.4	8.1	5.6	CT-1550, CT-2500	50	250
PMV6-5F-L			6.10	M5	26.4	9.7	5.6		50	250
PMV6-6F-L			6.10	M6	29.5	10.9	8.1		50	250

For crimping tool information, see pages D1.84 and D1.88.

A. System Overview

## Metric Fork Terminal, Non-Insulated

B1. Cable Ties

### Type PM-F

- Fork design provides for fast and easy installation, without the need to remove fastener
- Internal barrel serrations assure good wire contact and maximum tensile strength
- Brazed seam protects terminal barrel from splitting during the crimp process
- Barrel of terminal internally beveled to provide quick and easy wire insertion
- Maximum recommended operating temperature 302°F (150°C)
- Rated up to 2000 V

B2. Cable Accessories

B3. Stainless Steel Ties



C1. Wiring Duct



C2. Surface Raceway



C3. Abrasion Protection

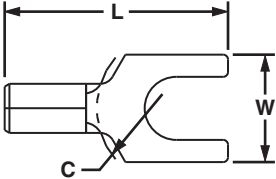

Part Number	Wire Range (mm <sup>2</sup> )	Stud Size	Figure Dimensions (mm)			Recommended Installation Tool	Std. Pkg. Qty.	Std. Ctn. Qty.
			L	W	C			
<b>PM1-3F-C</b>	0.5 – 1.5	M3	16.0	5.8	5.6	CT-1570, CT-2500	100	500
<b>PM1-4F-C</b>		M4	17.5	8.1	6.4		100	500
<b>PM1-5F-C</b>		M5	18.0	8.8	6.6		100	500
<b>PM2-3F-C</b>	1.0 – 2.5	M3	16.0	5.8	5.6	CT-1570, CT-2500	100	500
<b>PM2-4F-C</b>		M4	17.5	7.9	6.4		100	500
<b>PM2-5F-C</b>		M5	18.0	8.6	6.9		100	500
<b>PM6-5F-L</b>	4.0 – 6.0	M5	19.4	9.5	7.1	CT-1570, CT-2500	50	250
<b>PM6-6F-L</b>		M6	22.6	10.9	8.6		50	250

For crimping tool information, see pages D1.84 and D1.88.

C4. Cable Management

### Plastic Box Terminal Kits

- Ideal for maintenance and construction wiring
- Positive latching case prevents accidental opening
- With the case top closed, parts remain in their compartments
- Case features a hanging tab for storage

D1. Terminals



KP-1075Y

D2. Power Connectors

D3. Grounding Connectors



KP-1165Y

Part Number	Part Description	Std. Pkg. Qty.
<b>KP-1075Y</b>	Terminal kit without crimping tool. Includes the following: (20) PV18-8R; PV18-6F; PV14-8F; PV14-10R; (10) PV10-8R; PV10-10R; DNF14-250; DNF18-250; BSV18X; BSV14X; BSV10X; (10) JN418-212.	1
<b>KP-1000</b>	Empty plastic box, twelve terminal compartments and one tool compartment, measures 11" wide x 6 3/4" deep x 1 3/4" high. Positive latch prevents accidental opening. Once top is closed, terminals remain in their compartments.	1
<b>KP-1165Y</b>	Includes the following: (18) PV18-8R; PV14-10R; PV18-6F; PV14-8F; (10) PV10-8R; PV10-10R; BSV18X; BSV14X; BSV10X; DV18-250B; DV14-188B; (5) JN418-212; (1) CT-160 Tool; KP-1000 box.	1
<b>KP-1166</b>	Includes the following: (18) P18-8R; P14-10R; P18-6F; P14-8F; (10) P10-8R; P10-10R; BS18; BS14; BS10; D18-250; D14-188; (5) JN218-216; (1) CT-160 tool; KP-1000 box.	1

E1. Labeling Systems

E2. Labels

### **NEW!** Fabric Terminal Kit

- Versatile fabric kit stores up to five standard packs of terminals
- Kit includes pocket for storage of an installation tool or cable ties
- Zipper closure prevents accidental opening
- Kit features a hanging tab for storage



Terminal parts sold separately



Part Number	Part Description	Std. Pkg. Qty.
<b>KF-1005</b>	Empty fabric kit, 5 terminal compartments and one tool compartment, measures 5 1/2" wide x 2 1/2" deep x 11 1/2" high.	1

E4. Permanent Identification

E5. Lockout/Tagout & Safety Solutions

F. Index

## Steel Kit Boxes

- Latch prevents accidental opening
- Once lid is closed, terminals remain in their compartments
- Handle for portability or as drawer pull when used in rack



- Drop-in label area on front measures: 2.13"H x 13.75"W x 9.75"D (54.0mm x 349.3mm x 247.7mm)

Part Number	Part Description	Std. Pkg. Qty.
K-1000	Empty steel box, 20 terminal compartments and one tool compartment, dimensions: 2.00"H x 13.33"W x 9.33"D (50.8mm x 338.6mm x 237.0mm).	1
K-1001	Empty steel kit box, 15 terminal compartments and two tool compartments, box dimensions: 2.00"H x 13.33"W x 9.33"D (50.8mm x 338.6mm x 237.0mm).	1
K-1100	Steel box and CT-100A crimping tool.	1
K-1102Y	Includes the following: (100) PV18-6LF; PV18-8LF; PV14-8LF; PV14-10LF; BSV18X; BSV14X; (50) PV10-10LF; BSV10X; (1) CT-100A tool; K-1000 box.	1
K-1103Y	Includes the following: (100) DV18-250B; DV14-250B; DV14-250MB; D18-250; D14-250; (50) DV10-250; D10-250; (1) CT-100A tool; K-1000 box.	1
K-1104	Includes the following: (50) PN18-10R; PN14-6R; PN14-10R; PN18-6F; PN14-6F; PN14-10F; (25) PN10-10R; PN10-56R; PN10-10F; BSN14; BSN10; JN418-212; (1) CT-100A tool; K-1000 box.	1

## Steel Slide Racks

- Steel boxes for cable tie kits and K-1000 terminal kits
- Steel boxes, storage slide racks, and base can be combined for neat and organized storage of cable ties and terminals

- Rugged and durable steel construction
- Empty boxes, full kits, slide racks and base are purchased according to your application needs



Part Number	Part Description	Std. Pkg. Qty.
SR2	2-drawer slide rack to hold K-504 cable tie kit or K-1000 series terminal kit. Dimensions: 6.25"H x 15.25"W x 11.75"D (158.7mm x 387.4mm x 298.5mm)	1
SR4	4-drawer slide rack to hold K-1000 series terminal kit. Dimensions: 11.25"H x 15.25"W x 11.75"D (285.8mm x 387.4mm x 298.5mm)	1
SR6	6-drawer slide rack to hold K-1000 series terminal kit. Dimensions: 16.38"H x 15.25"W x 11.75"D (416.1mm x 387.4mm x 298.5mm)	1

Slide racks will accommodate the following Panduit kits:	
K-1000	K-1103Y
K-1001	K-1104
K-1100	K1-PNKIT
K-1102Y	K2-PVKITY

A. System Overview

B1. Cable Ties

B2. Cable Accessories

B3. Stainless Steel Ties

C1. Wiring Duct

C2. Surface Raceway

C3. Abrasion Protection

C4. Cable Management

D1. Terminals

D2. Power Connectors

D3. Grounding Connectors

E1. Labeling Systems

E2. Labels

E3. Pre-Printed & Write-On Markers

E4. Permanent Identification

E5. Lockout/Tagout & Safety Solutions

F. Index

A. System Overview

## Industrial Maintenance Kits

B1. Cable Ties

- Steel kits have individual compartments for storage of terminals
- Once top is closed, terminals remain in their compartments
- Convenient carrying handle

B2. Cable Accessories

B3. Stainless Steel Ties

C1. Wiring Duct

C2. Surface Raceway

C3. Abrasion Protection

C4. Cable Management



K1-PNKIT



K2-PVKITY



K-205

D1. Terminals

D2. Power Connectors

D3. Grounding Connectors

E1. Labeling Systems

E2. Labels

E3. Pre-Printed & Write-On Markers

E4. Permanent Identification

E5. Lockout/Tagout & Safety Solutions

F. Index

Part Number	Part Description	Std. Pkg. Qty.
K1-PNKIT	<p>Kit contains:</p> <ul style="list-style-type: none"> <li>(1) K-1001 steel kit box</li> <li>(1) CT-260 installation tool</li> </ul> <p><u>Cable Ties</u></p> <ul style="list-style-type: none"> <li>(100) PLT2S cable ties</li> </ul> <p><u>Terminals</u></p> <ul style="list-style-type: none"> <li>(100) PN14-610R multi-stud terminals</li> <li>(100) PN18-610R multi-stud terminals</li> <li>(100) PN18-6LF locking fork terminals</li> <li>(100) PN14-8LF locking fork terminals</li> <li>(50) PN10-10LF locking fork terminals</li> <li>(100) PN18-8F fork terminals</li> <li>(100) PN14-10R ring terminals</li> <li>(50) PN10-10R ring terminals</li> </ul> <p><u>Disconnects</u></p> <ul style="list-style-type: none"> <li>(100) DNF18-250 disconnects</li> <li>(100) DNF14-250 disconnects</li> <li>(50) DV10-250 disconnects</li> </ul> <p><u>Splices</u></p> <ul style="list-style-type: none"> <li>(50) BSN18 butt splices</li> <li>(50) BSN14 butt splices</li> <li>(25) BSN10 butt splices</li> </ul> <p><u>Marking System</u></p> <ul style="list-style-type: none"> <li>(1) PMD-0-9 marking dispenser and tape</li> <li>(100) MP150 marker tags</li> <li>(1) PX-0 marker</li> </ul>	1
K2-PVKITY	<p>Kit contains:</p> <ul style="list-style-type: none"> <li>(1) K-1001 steel kit box</li> <li>(1) CT-260 installation tool</li> </ul> <p><u>Cable Ties</u></p> <ul style="list-style-type: none"> <li>(100) PLT2S cable ties</li> </ul> <p><u>Terminals</u></p> <ul style="list-style-type: none"> <li>(100) PV18-8F fork terminals</li> <li>(100) PV18-6LF locking fork terminals</li> <li>(100) PV14-8LF locking fork terminals</li> <li>(50) PV10-10LF locking fork terminals</li> <li>(100) PV18-610R multi-stud terminals</li> <li>(100) PV14-10R ring terminals</li> <li>(50) PV10-10R ring terminals</li> </ul> <p><u>Disconnects</u></p> <ul style="list-style-type: none"> <li>(100) DNF18-250 disconnects</li> <li>(100) DV14-250B disconnects</li> <li>(50) DV10-250 disconnects</li> </ul> <p><u>Splices</u></p> <ul style="list-style-type: none"> <li>(50) BSV18X butt splices</li> <li>(50) BSV14X butt splices</li> <li>(25) BSV10X butt splices</li> </ul> <p><u>Wire Joints</u></p> <ul style="list-style-type: none"> <li>(30) JN224-318</li> <li>(15) JN314-412</li> </ul> <p><u>Marking System</u></p> <ul style="list-style-type: none"> <li>(1) PMD-0-9 marking dispenser and tape</li> </ul>	1
K-205*	<p><b>Kit for Indoor Use</b></p> <p>Pan-Ty® Cable Ties, cable tie installation tool, terminals, splices and crimp tool:</p> <ul style="list-style-type: none"> <li>(1) GTS tool</li> <li>(1) CT-100A crimp tool</li> </ul> <p><u>Natural Nylon 6.6 Cable Ties</u></p> <ul style="list-style-type: none"> <li>(100) PLT1M</li> <li>(100) PLT1.5I</li> <li>(100) PLT2S</li> </ul> <p><u>Terminals</u></p> <ul style="list-style-type: none"> <li>(100) PV18-6LF</li> <li>(100) PV14-8LF</li> <li>(100) PV14-10LF</li> <li>(50) PV10-10LF</li> </ul> <p><u>Splices</u></p> <ul style="list-style-type: none"> <li>(50) BSV10X</li> <li>(100) BSV14X</li> <li>(100) BSV18X</li> </ul>	1

\*The K-205 does not fit into the SR2, SR4, or SR6.

## PAN-TERM® DISCONNECTS

Panduit® Pan-Term® Disconnects are designed and precision made to function as a reliable method of making quick, repeatable interconnections. Available with nylon, premium nylon, vinyl insulation or non-insulated.



- Fully insulated design provides excellent protection from electrical shorts and provides additional installer protection for safety from electrical shocks
- Funnel entry speeds insertion and minimizes turned back wire strands
- Integrated metal insulation grip provides double crimp insulation grip for high vibration or conductor strain environments on select **Supra-Grip™ Disconnects** and **Disco-Lok™ Disconnects** and **DiscoGrip™ Disconnects**
- Applicable sizes are UL Listed and CSA Certified, as noted
- Wide assortment of manual, controlled cycle, battery operated hydraulic and pneumatic crimping tools for reliable connections at the lowest installed cost

Panduit continually provides new designs to meet the application challenges encountered by our customers. Panduit offers a wide assortment of Pan-Term® termination products at the lowest installed cost.

A.  
System  
Overview

B1.  
Cable Ties

B2.  
Cable  
Accessories

B3.  
Stainless  
Steel Ties

C1.  
Wiring  
Duct

C2.  
Surface  
Raceway

C3.  
Abrasion  
Protection

C4.  
Cable  
Management

D1.  
Terminals

D2.  
Power  
Connectors

D3.  
Grounding  
Connectors

E1.  
Labeling  
Systems

E2.  
Labels

E3.  
Pre-Printed  
& Write-On  
Markers

E4.  
Permanent  
Identification

E5.  
Lockout/  
Tagout  
& Safety  
Solutions

F.  
Index

A. System Overview

## Features and Benefits – Pan-Term® Disconnects

Pan-Term® Disconnects are fabricated from brass and are electro tin-plated for a long, corrosion resistant operating life.

B1. Cable Ties

B2. Cable Accessories

B3. Stainless Steel Ties

C1. Wiring Duct

C2. Surface Raceway

C3. Abrasion Protection

C4. Cable Management

### Nylon Fully Insulated Female Receptacles and Male Tabs Type DNF-FIB

Available in tab sizes to accommodate .110", .187", .205" or .250" tabs

Fully insulated design provides protection from electrical shorts

Expanded wire entry (on select sizes) accommodates large insulation or multiple wires

Maximum insulation temperature 221°F (105°C)

Insulation support restricts excessive wire movement to minimize stress on crimp joint

Funnel entry for faster wire insertion and lower installed cost



UL and CSA rated up to 600 V per UL 310. Flammability – UL 94V-2/HB.

### Disco-Grip™ Premium Nylon Fully Insulated Female Receptacles and Male Tabs Type DPF

Available in tab sizes to accommodate .110", .187", .205" or .250" tabs

Fully insulated design provides protection from electrical shorts

Maximum insulation temperature 221°F (105°C)

Funnel entry for faster wire insertion and lower installed cost



UL and CSA rated up to 600 V per UL 310. Flammability – UL 94V-2. Male products available .250" width in standard and oversized housing configurations.

D1. Terminals

D2. Power Connectors

D3. Grounding Connectors

E1. Labeling Systems

E2. Labels

E3. Pre-Printed & Write-On Markers

E4. Permanent Identification

E5. Lockout/Tagout & Safety Solutions

F. Index

### Supra-Grip™ Nylon Fully Insulated Female Disconnects Type DNG-FB

Available in tab sizes to accommodate .187" or .250" tabs

Fully insulated design provides protection from electrical shorts

Maximum insulation temperature 221°F (105°C)

Funnel entry for faster wire insertion and lower installed cost

Fully integrated metal insulation grip for high vibration, high strain relief, and double crimp requirements



UL and CSA rated up to 600 V per UL 310. Flammability – UL 94V-2/HB.

### Disco-Lok™ Nylon Fully Insulated Locking Female Disconnects Type DNG-FL

Available in tab sizes to accommodate .250" tabs

Unique locking mechanism allows for low insertion forces (mating) and positive locking for secure connections

Maximum insulation temperature 221°F (105°C)

Funnel entry for faster wire insertion and lower installed cost

Insulation grip sleeve provides a superior insulation crimp for high vibration and high strain relief applications



UL and CSA rated up to 300 V per UL 310. Flammability – UL 94V-2/HB.



Panduit extensive line of tooling is specifically designed for optimum crimping performance.

See pages D1.83 – D1.89.



Panduit designs and manufactures a full line of labeling products, software, and printers to assist you with your labeling requirements.

See pages E1.1 – E2.28.



## Features and Benefits – Pan-Term® Disconnects (continued)

### Nylon Barrel Insulated Female Receptacles and Male Tabs Type DNF

Available in tab sizes to accommodate .110", .187", .205" or .250" tabs

Maximum insulation temperature 194°F (90°C)



Insulation grip sleeve provides a superior insulation crimp for high vibration and high strain relief applications

Funnel entry for faster wire insertion and lower installed cost



UL and CSA rated up to 300 V per UL 310.  
Flammability – UL 94V-2/HB.  
Male products available .250" width.

### Vinyl Barrel Insulated Female Receptacles and Male Tabs Type DV and DVF

Available in tab sizes to accommodate .187", .205", or .250" tabs

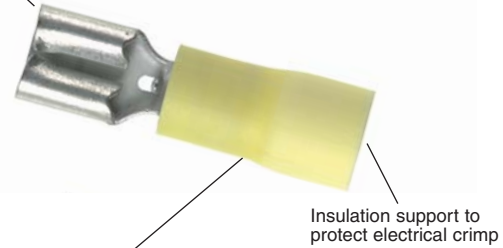

Insulation grip sleeve provides a superior insulation crimp for high vibration and high strain relief applications

Insulation support to protect electrical crimp



UL and CSA rated up to 300 V per UL 310.  
Male products available .250" width.  
Flammability – UL 94V-0.

### Non-Insulated Female Receptacles and Male Tabs Type D

Available in tab sizes to accommodate .187" or .250" tabs

Sleeved barrel assures crimp reliability

Maximum recommended operating temperature 302°F (150°C)



UL and CSA rated up to 2000 V per UL 310.  
Male products available .250" width.

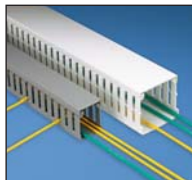

Panduit wiring duct offers a wide variety of sizes and types to meet the wire capacity needs and space constraints of the smallest wall mounted to the largest integrated systems.

See pages C1.1 – C1.52.



A comprehensive selection of cable ties used to bundle, mount, and identify wire and cable.

See pages B1.1 – B1.120.

A.  
System  
Overview

B1.  
Cable Ties

B2.  
Cable  
Accessories

B3.  
Stainless  
Steel Ties

C1.  
Wiring  
Duct

C2.  
Surface  
Raceway

C3.  
Abrasion  
Protection

C4.  
Cable  
Management

D1.  
Terminals

D2.  
Power  
Connectors

D3.  
Grounding  
Connectors

E1.  
Labeling  
Systems

E2.  
Labels

E3.  
Pre-Printed  
& Write-On  
Markers

E4.  
Permanent  
Identification

E5.  
Lockout/  
Tagout  
& Safety  
Solutions

F.  
Index

## Selection Guide – Pan-Term® Disconnects

A. System Overview

B1. Cable Ties

B2. Cable Accessories

B3. Stainless Steel Ties

C1. Wiring Duct

C2. Surface Raceway

C3. Abrasion Protection

C4. Cable Management

D1. Terminals

D2. Power Connectors

D3. Grounding Connectors

E1. Labeling Systems

E2. Labels

E3. Pre-Printed & Write-On Markers

E4. Permanent Identification

E5. Lockout/Tagout & Safety Solutions

F. Index

Material	Style	Design	Feature	Type	Page Number
Nylon	Fully Insulated	Female	Funnel Entry, Ins. Grip	DNG-FB	D1.43
		Female	Funnel, Ins. Grip, Locking	DNG-FL	D1.44
		Female	Funnel, Ins. Support, Two-Pc.	DNF-FIB	D1.45
		Female	Funnel, Ins. Support, Three-Pc.	DNF-FI	D1.45
		Female	Funnel Entry, Premium Nylon	DPF-FIB	D1.46
		Male	Funnel, Ins. Support, Two-Pc.	DNF-FIM	D1.44
		Male	Premium Nylon	DPF-FIM	D1.46
		Female Right Angle	Funnel Entry, Ins. Support	DNFR-FIB	D1.49
		Female Right Angle	Funnel Entry, Open Top	DNFR-B	D1.50
		Nylon	Barrel Insulated	Female	Funnel Entry, Ins. Grip
Male	Funnel Entry, Ins. Grip			DNF-M	D1.52
Vinyl	Barrel Insulated	Female	Funnel Entry, Ins. Grip, Three-Pc.	DVF	D1.48
		Female	Funnel Entry, Butted Seam, Two-Pc.	DV-B	D1.48
		Male	Funnel Entry, Butted Seam, Two-Pc.	DV-MB	D1.52
		Piggyback	Funnel Entry, Ins. Grip	DV-P	D1.51
Heat Shrink	Fully Insulated	Female	Heat Shrink Insulated	DNH-FIB	D1.47
		Male	Heat Shrink Insulated	DNH-FIM	D1.47
Non-Insulated		Female	Sleeved Barrel	D	D1.49
		Female Right Angle	Sleeved Barrel	DR	D1.50
		Female Right Angle	Butted Seam	DR-B	D1.51
		Male	Butted Seam	D-MB	D1.53
		Adapter	Two Female to One Male	D-A	D1.51

Disconnects



## Part Number System for Pan-Term® Disconnects

D	NF	—	14	250	FIB	—	M
Type	Insulation		Wire Range	Tab Size	Special Configuration		Standard Package Size
D = Disconnects	N = Nylon		18 = #22 – 18	110 = 0.110 x 0.032	A = Adapter		L = 50
	NF = Nylon, Funnel Entry		14 = #16 – 14	111 = 0.110 x 0.020	B = Butted Seam		C = 100
	NFR = Nylon, Funnel Entry, Right Angle		10 = #12 – 10	145 = 0.145 x 0.032	FB = Metal Insulation Grip, Female		D = 500
	NG = Nylon, Funnel Entry, Metal Insulation Grip			187 = 0.187 x 0.032	FI = Fully Insulated, Female		M = 1000
	NH = Heat Shrink			188 = 0.187 x 0.020	FIB = Fully Insulated, Butted Seam, Female		
	PF = Premium Grade Nylon, Funnel Entry			205 = 0.187/0.205 x 0.032	FIM = Fully Insulated, Male		
	R = Non-insulated, Right Angle			206 = 0.187/0.205 x 0.020	FIMB = Fully Insulated, Male with Oversized Housing		
	V = Vinyl			250 = 0.250 x 0.032	FL = Locking, Metal Insulation Grip, Female		
	VF = Vinyl Funnel Entry				M = Male		
	= Non-Insulated (leave blank)				MB = Butted, Male		
					P = Piggyback		
					= Female (leave blank)		

## Supra-Grip™ Female Disconnect, Nylon Fully Insulated – Funnel Entry

### Type DNG-FB

- Disconnect can be inserted and removed from the male tab without the use of tools for lower installed cost
- Flared barrel extension integrated into stamping to provide insulation grip for double crimp requirements
- Fully insulated design provides protection from electrical shorts
- Internal barrel serrations assure good wire contact and maximum tensile strength
- Internal wire stop assures proper length of insertion into terminal barrel, providing a higher-quality connection
- Mates with DNF-FIMB family
- UL Flammability UL 94V-2/HB, maximum insulation temperature 221°F (105°C)
- UL and CSA rated up to 600 V per UL 310



Part Number	Wire Range	Color Code	Max. Ins. (In.)	Figure Dimensions (In.)			Tab Size (In.)	Recommended Installation Tool	Std. Pkg. Qty.**	Std. Ctn. Qty.
				L	W	H				
DNG18-187FB-C	22 – 18 AWG	Red	0.126	0.89	0.29	0.22	0.187 x 0.032	CT-1015	100	1000
DNG18-188FB-C			0.126	0.89	0.29	0.22	0.187 x 0.020		100	1000
DNG18-250FB-L			0.126	0.93	0.35	0.22	0.250 x 0.032		50	250
DNG14-187FB-L*	16 – 14 AWG	Blue	0.153	0.89	0.29	0.25	0.187 x 0.032	CT-1015	50	250
DNG14-188FB-L*			0.153	0.89	0.29	0.25	0.187 x 0.020		50	250
DNG14-250FB-L			0.153	0.93	0.35	0.25	0.250 x 0.032		50	250

\*UL Recognized for use with copper alloy tabs.

\*\*Bulk packaging may be available, contact Panduit Customer Service for additional information.

For crimping tool information, see page D1.84.

A. System Overview

## Disco-Lok™ Female Disconnect, Nylon Fully Insulated – Funnel Entry

B1. Cable Ties

### Type DNG-FL

- Disconnect can be inserted and removed from the male tab without the use of tools for lower installed cost
- Unique locking mechanism design allows for low insertion forces (mating) and positive lock for high vibration applications where a secure connection is mandatory
- Fully insulated design provides protection from electrical shorts
- Flared barrel extension integrated into stamping to provide insulation grip for double crimp requirements
- Insulation housing moves back and forth to engage and disengage locking mechanism for repeated use.
- Specialty tool required to install this disconnect (CT-1014)
- Mates with DNF-FIMB family
- UL Flammability UL 94V-2/HB, maximum insulation temperature 221°F (105°C)
- UL and CSA rated up to 300 V per UL 310

B2. Cable Accessories

B3. Stainless Steel Ties



Part Number	Wire Range	Color Code	Max. Ins. (In.)	Figure Dimensions (In.)			Tab Size (In.)	Recommended Installation Tool	Std. Pkg. Qty.**	Std. Ctn. Qty.
				L	W	H				
<b>DNG18-250FL-L</b>	22 – 18 AWG	Red	0.126	0.97	0.36	0.24	0.250 x 0.032	CT-1014	50	250
<b>DNG14-250FL-L</b>	16 – 14 AWG	Blue	0.150	0.97	0.36	0.25	0.250 x 0.032	CT-1014	50	250

C1. Wiring Duct

C2. Surface Raceway



\*\*Bulk packaging may be available, contact Panduit Customer Service for additional information. For crimping tool information, see page D1.84.

C3. Abrasion Protection

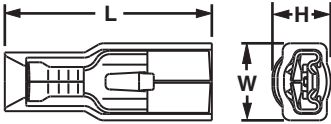

C4. Cable Management

## Male/Female Coupler, Nylon Fully Insulated – Funnel Entry

### Type DNF

- Disconnect can be inserted and removed from the male tab without the use of tools for lower installed cost
- Fully insulated design provides protection from electrical shorts
- Internal barrel serrations assure good wire contact and maximum tensile strength
- Internal wire stop assures proper length of insertion into terminal barrel, providing a higher quality connection
- Coupler, male, and female parts sold separately
- UL Flammability UL 94V-2/HB, maximum insulation temperature 221°F (105°C)
- UL and CSA rated up to 600 V per UL 310

D1. Terminals

D2. Power Connectors

D3. Grounding Connectors



MALE



FEMALE

Part Number	Wire Range	Color Code	Max. Ins. (In.)	Figure Dimensions (In.)			Tab Size (In.)	Recommended Installation Tool	Std. Pkg. Qty.**	Std. Ctn. Qty.
				L	W	H				
<b>DNF18-250FIM-L Male</b>	22 – 18 AWG	Red	0.133	0.90	0.42	0.27	0.250 x 0.032	CT-100A‡, CT-600-A, CT-1525‡, CT-2500‡	50	250
<b>DNF18-250FIMB-L Male</b>			0.136	0.91	0.45	0.34	0.250 x 0.032			
<b>DNF18-250FIB-C Female</b>			0.136	0.84	0.35	0.22	0.250 x 0.032		100	1000
<b>DNF14-250FIM-L Male</b>	16 – 14 AWG	Blue	0.158	0.90	0.42	0.27	0.250 x 0.032	CT-600-A, CT-1525‡, CT-2500‡	50	250
<b>DNF14-250FIMB-Q Male</b>			0.160	0.91	0.45	0.34	0.250 x 0.032			
<b>DNF14-250FIB-C Female</b>			0.160	0.84	0.35	0.22	0.250 x 0.032		100	1000
<b>DNF10-250FIMB-Q Male</b>	12 – 10 AWG	Yellow	0.220	0.96	0.45	0.36	0.250 x 0.032	CT-600-A‡, CT-1550‡, CT-1551‡, CT-2500‡	25	125
<b>DNF10-250FI-L Female</b>			0.220	0.95	0.36	0.27	0.250 x 0.032			

E1. Labeling Systems

E2. Labels

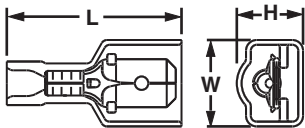

MALE

E3. Pre-Printed & Write-On Markers

E4. Permanent Identification

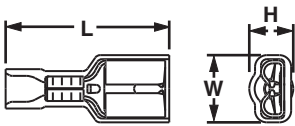

FEMALE

E5. Lockout/Tagout & Safety Solutions

F. Index

\*\*Bulk packaging may be available, contact Panduit Customer Service for additional information. ‡UL and CSA approved tooling/product combinations. For crimping tool information, see pages D1.83, D1.84, D1.86 and D1.88.



## Female Disconnect, Nylon Fully Insulated – Funnel Entry

### Type DNF-FIB

- Disconnect can be inserted and removed from the male tab without the use of tools for lower installed cost
- Fully insulated design provides protection from electrical shorts
- Internal wire stop assures proper length of insertion into terminal barrel, providing a higher quality connection
- UL Flammability UL 94V-2/HB, maximum insulation temperature 221°F (105°C)
- UL and CSA rated up to 600 V per UL 310



Part Number	Wire Range	Color Code	Max. Ins. (In.)	Figure Dimensions (In.)			Tab Size (In.)	Recommended Installation Tool	Std. Pkg. Qty.**	Std. Ctn. Qty.
				L	W	H				
<b>DNF18-110FIB-C</b>	22 – 18 AWG	Red	0.120	0.71	0.19	0.16	0.110 x 0.032	CT-100A, CT-600-A, CT-1525‡, CT-2500‡	100	1000
<b>DNF18-111FIB-C</b>			0.120	0.71	0.19	0.16	0.110 x 0.020		100	1000
<b>DNF18-187FIB-C</b>			0.136	0.78	0.29	0.16	0.187 x 0.032		100	1000
<b>DNF18-188FIB-C</b>			0.136	0.78	0.29	0.16	0.187 x 0.020		100	1000
<b>DNF18-205FIB-L</b>			0.136	0.78	0.31	0.22	0.205/0.187 x 0.032		50	250
<b>DNF18-206FIB-L</b>			0.136	0.78	0.31	0.22	0.205/0.187 x 0.020		50	250
<b>DNF18-250FIB-C</b>			0.136	0.84	0.35	0.22	0.250 x 0.032		100	1000
<b>DNF14-187FIB-C</b>	16 – 14 AWG	Blue	0.160	0.78	0.29	0.18	0.187 x 0.032	CT-100A, CT-600-A, CT-1525‡, CT-2500‡	100	1000
<b>DNF14-188FIB-C</b>			0.160	0.78	0.29	0.18	0.187 x 0.020		100	1000
<b>DNF14-205FIB-C</b>			0.160	0.78	0.31	0.22	0.205/0.187 x 0.032		100	1000
<b>DNF14-206FIB-C</b>			0.160	0.78	0.31	0.22	0.205/0.187 x 0.020		100	1000
<b>DNF14-250FIB-C</b>			0.160	0.84	0.35	0.22	0.250 x 0.032		100	1000
<b>DNF10-250FIB-L</b>	12 – 10 AWG	Yellow	0.220	0.96	0.35	0.23	0.250 x 0.032	CT-1525‡, CT-2500‡	50	500

### Female Disconnect Nylon Insulated – Expanded Entry

<b>DNF18205FIBX-L</b>	22 – 18 AWG	Red	0.210	0.87	0.31	0.22	0.205/0.187 x 0.032	CT-100A	50	250
<b>DNF18206FIBX-L</b>			0.210	0.87	0.31	0.22	0.205/0.187 x 0.020		50	250
<b>DNF18250FIBX-L</b>			0.210	0.93	0.35	0.22	0.250 x 0.032		50	250
<b>DNF14206FIBX-L</b>	16 – 14 AWG	Blue	0.240	0.87	0.31	0.22	0.205/0.187 x 0.020	CT-100A	50	250
<b>DNF14250FIBX-L</b>			0.240	0.93	0.35	0.22	0.250 x 0.032		50	250

\*\*Bulk packaging may be available, contact Panduit Customer Service for additional information.

‡UL and CSA approved tooling/product combinations. For crimping tool information, see pages D1.83, D1.84, D1.86 and D1.88.



## Female Disconnect, Nylon Fully Insulated – Funnel Entry, Metal Collar

### Type DNF-FI

- Disconnect can be inserted and removed from the male tab without the use of tools for lower installed cost
- Fully insulated design provides protection from electrical shorts
- Internal wire stop assures proper length of insertion into terminal barrel, providing a higher quality connection
- Barrel design with larger outside diameter for use with more common hand tools
- UL Flammability UL 94V-2/HB, maximum insulation temperature 221°F (105°C)
- UL and CSA rated up to 600 V per UL 310

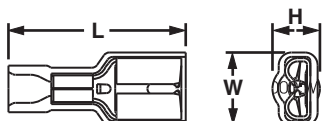

Part Number	Wire Range	Color Code	Max. Ins. (In.)	Figure Dimensions (In.)			Tab Size (In.)	Recommended Installation Tool	Std. Pkg. Qty.**	Std. Ctn. Qty.
				L	W	H				
<b>DNF18-250FI-L</b>	22 – 18 AWG	Red	0.140	0.94	0.36	0.21	0.250 x 0.032	CT-100A, CT-600-A, CT-1550, CT-1551, CT-2500	50	250
<b>DNF14-250FI-L</b>	16 – 14 AWG	Blue	0.160	0.94	0.36	0.24	0.250 x 0.032	CT-100A‡, CT-600-A‡, CT-1550‡, CT-1551‡, CT-2500‡	50	250
<b>DNF10-250FI-L</b>	12 – 10 AWG	Yellow	0.220	0.95	0.36	0.27	0.250 x 0.032	CT-100A‡, CT-600-A‡, CT-1550‡, CT-1551‡, CT-2500‡	50	500

\*\*Bulk packaging may be available, contact Panduit Customer Service for additional information.

‡UL and CSA approved tooling/product combination. For crimping tool information, see pages D1.83, D1.84, D1.86 and D1.88.

A. System Overview

B1. Cable Ties

B2. Cable Accessories

B3. Stainless Steel Ties

C1. Wiring Duct

C2. Surface Raceway

C3. Abrasion Protection

C4. Cable Management

D1. Terminals

D2. Power Connectors

D3. Grounding Connectors

E1. Labeling Systems

E2. Labels

E3. Pre-Printed & Write-On Markers

E4. Permanent Identification

E5. Lockout/Tagout & Safety Solutions

F. Index

A. System Overview

B1. Cable Ties

B2. Cable Accessories

B3. Stainless Steel Ties

C1. Wiring Duct

C2. Surface Raceway

C3. Abrasion Protection

C4. Cable Management

D1. Terminals

D2. Power Connectors

D3. Grounding Connectors

E1. Labeling Systems

E2. Labels

E3. Pre-Printed & Write-On Markers

E4. Permanent Identification

E5. Lockout/Tagout & Safety Solutions

F. Index

## DiscoGrip™ Male Disconnect, Premium Nylon Fully Insulated – Funnel Entry

### Type DPF-FIM

- Disconnect can be inserted and removed from the male tab without the use of tools for lower installed cost
- Premium nylon insulation retains its shape when crimped and provides a tight grip around the wire insulation for maximum strain relief
- Fully insulated design provides protection from electrical shorts
- Oversized housing designed for maximum versatility to mate with most commercially available fully insulated female disconnects
- Internal wire stop assures proper length of insertion into terminal barrel, providing a higher quality connection
- UL Flammability UL 94V-2, maximum insulation temperature 221°F (105°C)
- UL and CSA rated up to 600 V per UL 310

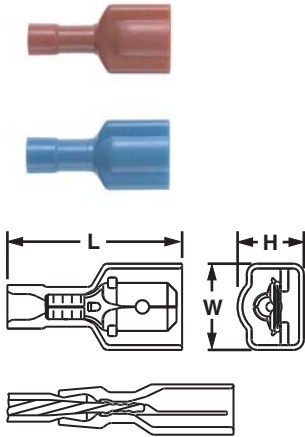

Part Number	Wire Range	Color Code	Max. Ins. (In.)	Figure Dimensions (In.)			Tab Size (In.)	Recommended Installation Tool	Std. Pkg. Qty.**	Std. Ctn. Qty.
				L	W	H				
<b>DPF18-250FIM-L</b>	22 – 18 AWG	Red	0.133	0.90	0.41	0.29	0.250 x 0.032	CT-600-A, CT-1525, CT-2500	50	250
<b>DPF14-250FIM-L</b>	16 – 14 AWG	Blue	0.156	0.90	0.41	0.29	0.250 x 0.032		50	250
<b>DPF18-250FIMB-L*</b>	22 – 18 AWG	Red	0.133	0.92	0.46	0.34	0.250 x 0.032		50	500
<b>DPF14-250FIMB-Q*</b>	16 – 14 AWG	Blue	0.156	0.92	0.46	0.34	0.250 x 0.032		25	125

\*Oversized housing design will mate with receptacles up to .390" wide and .235" (.285" high for parts with orientation bump).

\*\*Bulk packaging may be available, contact Panduit Customer Service for additional information. For crimping tool information, see pages D1.84, D1.86, and D1.88.

## DiscoGrip™ Female Disconnect, Premium Nylon Fully Insulated – Funnel Entry

### Type DPF-FIB

- Disconnect can be inserted and removed from the male tab without the use of tools for lower installed cost
- Premium nylon insulation retains its shape when crimped and provides a tight grip around the wire insulation for maximum strain relief
- Fully insulated design provides protection from electrical shorts
- Internal wire stop assures proper length of insertion into terminal barrel, providing a higher quality connection
- UL Flammability UL 94V-2, maximum insulation temperature 221°F (105°C)
- UL and CSA rated up to 600 V per UL 310

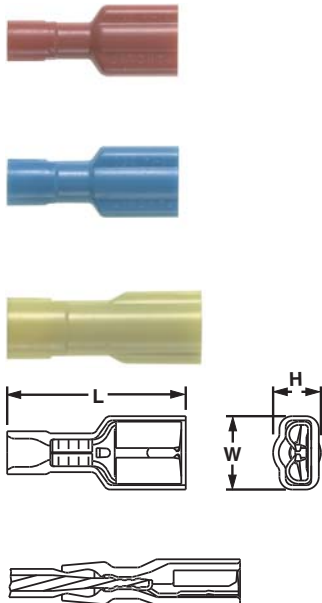

Part Number	Wire Range	Color Code	Max. Ins. (In.)	Figure Dimensions (In.)			Tab Size (In.)	Recommended Installation Tool	Std. Pkg. Qty.**	Std. Ctn. Qty.
				L	W	H				
<b>DPF18-110FIB-C</b>	22 – 18 AWG	Red	0.132	0.71	0.19	0.16	0.110 x 0.032	CT-600-A‡, CT-1525‡, CT-2500‡	100	1000
<b>DPF18-111FIB-C</b>			0.132	0.71	0.19	0.16	0.110 x 0.020		100	1000
<b>DPF18-205FIB-C</b>			0.133	0.78	0.31	0.22	0.205/0.187 x 0.032		100	1000
<b>DPF18-206FIB-C</b>			0.133	0.78	0.31	0.22	0.205/0.187 x 0.020		100	1000
<b>DPF18-250FIB-C</b>			0.133	0.84	0.35	0.22	0.250 x 0.032		100	1000
<b>DPF14-205FIB-C</b>	16 – 14 AWG	Blue	0.156	0.78	0.31	0.22	0.205/0.187 x 0.032	CT-600-A‡, CT-1525‡, CT-2500‡	100	1000
<b>DPF14-206FIB-C</b>			0.156	0.78	0.31	0.22	0.205/0.187 x 0.020		100	1000
<b>DPF14-250FIB-C</b>			0.156	0.84	0.35	0.22	0.250 x 0.032		100	1000
<b>DPF10-250FI-L*</b>	12 – 10 AWG	Yellow	0.218	0.95	0.36	0.27	0.250 x 0.032	CT-600-A, CT-1525, CT-2500	50	500
<b>DPF10-250FIB-L</b>			0.220	0.96	0.35	0.23	0.250 x 0.032		50	500

\*Not UL listed or CSA approved.

\*\*Bulk packaging may be available, contact Panduit Customer Service for additional information.

‡UL and CSA approved tooling/product combinations. For crimping tool information, see pages D1.84, D1.86, and D1.88.

## Heat Shrink Disconnects, Fully Insulated – Funnel Entry

### Type DNH

- Disconnect can be inserted and removed from the male tab without the use of tools for lower installed cost
- Fully insulated design provides protection from electrical shorts
- Heat shrink sleeving forms a protective barrier to provide environmentally sealed terminations ideal for high moisture applications
- Heat shrink sleeving provides additional level of strain relief for the wire
- Minimum continuous operating temperature -65°F (-55°C)
- Maximum continuous operation temperature 230°F (110°C)
- Shrink temperature 300°F (150°C)
- Rated up to 600 V

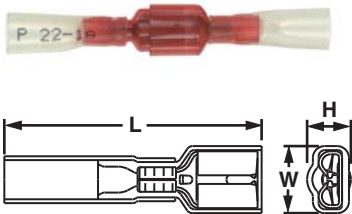

Part Number	Wire Range	Color Code	Max. Ins. (In.)	Figure Dimensions (In.)			Type	Tab Size (In.)	Recommended Installation Tool	Std. Pkg. Qty.	Std. Ctn. Qty.
				L	W	H					
DNH18-250FIM-Q	22 – 18 AWG	Red	0.133	1.50	0.41	0.31	Male	0.250 x 0.032	CT-310	25	125
DNH18-250FIB-Q			0.132	1.44	0.35	0.22	Female				
DNH14-250FIM-Q	16 – 14 AWG	Blue	0.158	1.50	0.41	0.31	Male			25	125
DNH14-250FIB-Q			0.156	1.44	0.35	0.22	Female				
DNH10-250FI-E	12 – 10 AWG	Yellow	0.230	1.44	0.35	0.27	Female			20	100

For crimping tool information, see page D1.85.



## Female Disconnect, Nylon Barrel Insulated – Funnel Entry

### Type DNF

- Disconnect can be inserted and removed from the male tab without the use of tools for lower installed cost
- Metal insulation grip sleeve crimps to wire insulation, providing protection to the crimp joint during high vibration applications
- Internal barrel serrations assure good wire contact and maximum tensile strength
- Internal wire stop assures proper length of insertion into terminal barrel, providing a higher quality connection
- UL Flammability UL 94V-2/HB, maximum insulation temperature 194°F (90°C)
- UL and CSA rated up to 300 V per UL 310

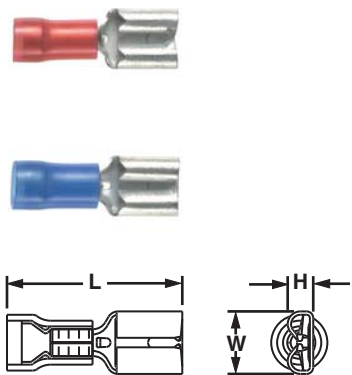

Part Number	Wire Range	Color Code	Max. Ins. (In.)	Figure Dimensions (In.)			Tab Size (In.)	Recommended Installation Tool	Std. Pkg. Qty.**	Std. Ctn. Qty.		
				L	W	H						
DNF18-110-C	22 – 18 AWG	Red	0.100	0.69	0.15	0.08	0.110 x 0.032	CT-600-A‡, CT-1525‡, CT-2500‡	100	500		
DNF18-111-C			0.100	0.69	0.15	0.07	0.110 x 0.020					
DNF18-187-C			0.137	0.76	0.23	0.10	0.187 x 0.032					
DNF18-188-C			0.137	0.76	0.23	0.10	0.187 x 0.020	CT-600-A‡, CT-1550, CT-1551, CT-2500	100	500		
DNF18-205-C			0.137	0.76	0.25	0.12	0.205/0.187 x 0.032					
DNF18-206-C			0.137	0.76	0.25	0.12	0.205/0.187 x 0.020					
DNF18-250-C			0.138	0.81	0.29	0.12	0.250 x 0.032					
DNF14-110-C*			16 – 14 AWG	Blue	0.162	0.75	0.15	0.08	0.110 x 0.032	CT-1525, CT-2500	100	500
DNF14-111-C*					0.162	0.75	0.15	0.07	0.110 x 0.020			
DNF14-187-C					0.162	0.76	0.23	0.10	0.187 x 0.032	CT-600-A‡, CT-1550, CT-1551, CT-2500	100	500
DNF14-188-C	0.162	0.76			0.23	0.10	0.187 x 0.020					
DNF14-205-C	0.162	0.76			0.25	0.12	0.205/0.187 x 0.032					
DNF14-206-C	0.162	0.76			0.25	0.12	0.205/0.187 x 0.020					
DNF14-250-C	0.162	0.83			0.29	0.12	0.250 x 0.032					

\*Not UL Listed or CSA Certified.

\*\*Bulk packaging may be available, contact Panduit Customer Service for additional information.

‡UL and CSA approved tooling/product combinations. For crimping tool information, see pages D1.84, D1.86, and D1.88.

A. System Overview

B1. Cable Ties

B2. Cable Accessories

B3. Stainless Steel Ties

C1. Wiring Duct

C2. Surface Raceway

C3. Abrasion Protection

C4. Cable Management

D1. Terminals

D2. Power Connectors

D3. Grounding Connectors

E1. Labeling Systems

E2. Labels

E3. Pre-Printed & Write-On Markers

E4. Permanent Identification

E5. Lockout/Tagout & Safety Solutions

F. Index

A. System Overview

B1. Cable Ties

B2. Cable Accessories

B3. Stainless Steel Ties

C1. Wiring Duct

C2. Surface Raceway

C3. Abrasion Protection

C4. Cable Management

D1. Terminals

D2. Power Connectors

D3. Grounding Connectors

E1. Labeling Systems

E2. Labels

E3. Pre-Printed & Write-On Markers

E4. Permanent Identification

E5. Lockout/Tagout & Safety Solutions

F. Index



## Female Disconnect, Vinyl Barrel Insulated – Funnel Entry

### Type DVF

- Disconnect can be inserted and removed from the male tab without the use of tools for lower installed cost
- Metal insulation grip sleeve crimps to wire insulation, providing protection to the crimp joint during high vibration applications
- Internal barrel serrations assure good wire contact and maximum tensile strength
- Internal wire stop assures proper length of insertion into terminal barrel, providing a higher quality connection
- UL Flammability UL 94V-0, maximum insulation temperature 194°F (90°C)
- UL and CSA rated up to 300 V per UL 310

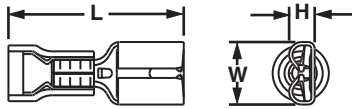

Part Number	Wire Range	Color Code	Max. Ins. (In.)	Figure Dimensions (In.)			Tab Size (In.)	Recommended Installation Tool	Std. Pkg. Qty.**	Std. Ctn. Qty.
				L	W	H				
DVF18-187-CY	22–18 AWG	Red	0.137	0.76	0.23	0.10	0.187 x 0.032	CT-1550‡, CT-1551‡, CT-2500‡	100	500
DVF18-188-CY			0.137	0.76	0.23	0.10	0.187 x 0.020		100	500
DVF18-205-CY			0.137	0.76	0.25	0.12	0.205/0.187 x 0.032		100	500
DVF18-206-CY			0.137	0.76	0.25	0.12	0.205/0.187 x 0.020		100	500
DVF18-250-CY			0.137	0.81	0.29	0.12	0.250 x 0.032		100	500
DVF14-187-C	16–14 AWG	Blue	0.162	0.76	0.23	0.10	0.187 x 0.032	CT-1550‡, CT-1551‡, CT-2500‡	100	500
DVF14-188-C			0.162	0.76	0.23	0.10	0.187 x 0.020		100	500
DVF14-205-C			0.162	0.76	0.25	0.12	0.205/0.187 x 0.032		100	500
DVF14-206-C			0.162	0.76	0.25	0.12	0.205/0.187 x 0.020		100	500
DVF14-250-C			0.162	0.81	0.29	0.12	0.250 x 0.032		100	500

\*\*Bulk packaging may be available, contact Panduit Customer Service for additional information.  
‡UL and CSA approved tooling/product combinations. For crimping tool information, see pages D1.84 and D1.88.



## Female Disconnect, Vinyl Barrel Insulated – Butted Seam

### Type DV-B

- Disconnect can be inserted and removed from the male tab without the use of tools for lower installed cost
- Internal barrel serrations assure good wire contact and maximum tensile strength
- Internal wire stop assures proper length of insertion into terminal barrel, providing a higher quality connection
- UL Flammability UL 94V-0, maximum insulation temperature 221°F (105°C)
- UL and CSA rated up to 600 V per UL 310

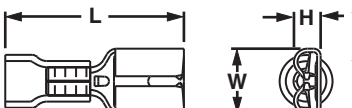

Part Number	Wire Range	Color Code	Max. Ins. (In.)	Figure Dimensions (In.)			Tab Size (In.)	Recommended Installation Tool	Std. Pkg. Qty.**	Std. Ctn. Qty.
				L	W	H				
DV18-187B-CY	22–18 AWG	Red	0.150	0.75	0.23	0.10	0.187 x 0.032	CT-1525‡, CT-2500‡	100	500
DV18-188B-CY			0.150	0.76	0.23	0.10	0.187 x 0.020		100	500
DV18-205B-CY			0.150	0.75	0.25	0.12	0.187/0.205 x 0.032		100	500
DV18-206B-CY			0.150	0.75	0.25	0.12	0.187/0.205 x 0.020		100	500
DV18-250B-CY	16–14 AWG	Blue	0.150	0.81	0.29	0.12	0.250 x 0.032	CT-1525^, CT-2500	100	500
DV14-187B-C			0.170	0.75	0.23	0.10	0.187 x 0.032		100	500
DV14-188B-C			0.162	0.79	0.23	0.10	0.187 x 0.020		100	500
DV14-205B-C			0.170	0.75	0.25	0.12	0.187/0.205 x 0.032		100	500
DV14-206B-C			0.170	0.75	0.25	0.12	0.187/0.205 x 0.020		100	500
DV14-250B-C	12–10 AWG	Yellow	0.170	0.81	0.29	0.12	0.250 x 0.032	CT-600-A, CT-1550^, CT-1551^, CT-2500	100	500
DV10-250-L*			0.229	1.03	0.30	0.13	0.250 x 0.032		50	500

\*Sleeved barrel, maximum insulation temperature 194°F (90°C).  
\*\*Bulk packaging may be available, contact Panduit Customer Service for additional information.  
‡UL and CSA approved tooling/product combinations. For crimping tool information, see pages D1.84 and D1.88.  
^CSA approved tooling/product combinations.  
\*UL Recognized only.





## Female Disconnect, Non-Insulated – Metal Sleeve

### Type D

- Disconnect can be inserted and removed from the male tab without the use of tools for lower installed cost
- Sleeved barrel helps to facilitate high mechanical and electrical performance when crimping
- Barrel of terminal internally beveled to provide quick and easy wire insertion
- Internal barrel serrations assure good wire contact and maximum tensile strength
- Internal wire stop assures proper length of insertion into terminal barrel, providing a higher quality connection
- Maximum recommended operating temperature 302°F (150°C)
- UL and CSA rated up to 2000 V per UL 310

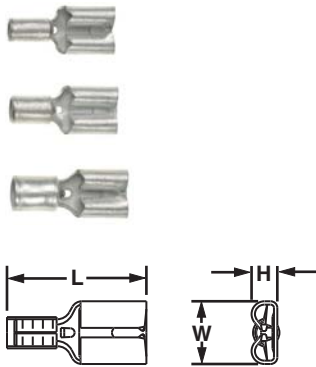

Part Number	Wire Range	Figure Dimensions (In.)			Tab Size (In.)	Recommended Installation Tool	Std. Pkg. Qty.**	Std. Ctn. Qty.
		L	W	H				
<b>D18-187-C</b>	22 – 18 AWG	0.58	0.23	0.10	0.187 x 0.032	CT-100A‡, CT-200‡, CT-1570‡, CT-2500‡	100	500
<b>D18-188-C</b>		0.58	0.23	0.10	0.187 x 0.020		100	500
<b>D18-250-C</b>		0.66	0.30	0.12	0.250 x 0.032		100	500
▲ <b>D14-187-C</b>	16 – 14 AWG	0.58	0.23	0.10	0.187 x 0.032	CT-100A, CT-200, CT-600-A, CT-1570, CT-2500	100	500
▲ <b>D14-188-C</b>		0.58	0.23	0.10	0.187 x 0.020		100	500
▲ <b>D14-250-C</b>		0.66	0.30	0.12	0.250 x 0.032		100	500
<b>D10-250-L</b>	12 – 10 AWG	0.72	0.30	0.12	0.250 x 0.032	CT-600-A‡, CT-1570‡, CT-1701‡, CT-2500‡	50	500

\*\*Bulk packaging may be available, contact Panduit Customer Service for additional information.  
 ‡UL and CSA approved tooling/product combinations. For crimping tool information, see pages D1.83, D1.84, D1.86 and D1.88.  
 \*UL Recognized only.



## Right Angle Female Disconnect, Nylon Fully Insulated – Funnel Entry

### Type DNFR-FIB

- Right angle design for use in limited space applications
- Fully insulated design provides protection from electrical shorts
- Internal wire stop assures proper length of insertion into terminal barrel, providing a higher quality connection
- Disconnect can be inserted and removed from the male tab without the use of tools for lower installed cost
- UL Flammability UL 94V-2/HB, maximum insulation temperature 221°F (105°C)
- UL and CSA rated up to 600 V per UL 310

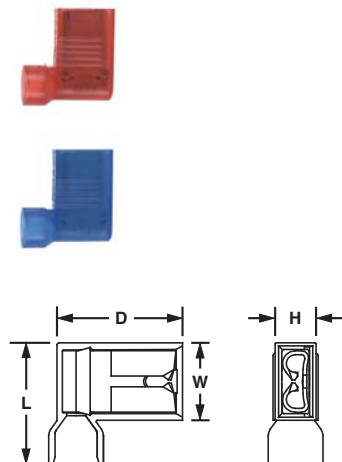

Part Number	Wire Range	Color Code	Max. Ins. (In.)	Figure Dimensions (In.)				Tab Size (In.)	Recommended Installation Tool	Std. Pkg. Qty.**	Std. Ctn. Qty.	
				L	W	H	D					
<b>DNFR18-205FIB-L</b>	22 – 18 AWG	Red	0.178	0.58	0.37	0.21	0.60	0.205/0.187 x 0.032	CT-300-1	50	250	
<b>DNFR18-206FIB-L</b>				0.178	0.58	0.37	0.21	0.60		0.205/0.187 x 0.020	50	250
<b>DNFR18-250FIB-L</b>				0.178	0.58	0.37	0.21	0.60		0.250 x 0.032	50	250
<b>DNFR14-205FIB-L</b>	16 – 14 AWG	Blue	0.178	0.58	0.37	0.21	0.60	0.205/0.187 x 0.032	CT-300-1	50	250	
<b>DNFR14-206FIB-L</b>				0.178	0.58	0.37	0.21	0.60		0.205/0.187 x 0.020	50	250
<b>DNFR14-250FIB-L</b>				0.178	0.58	0.37	0.21	0.60		0.250 x 0.032	50	250

\*\*Bulk packaging may be available, contact Panduit Customer Service for additional information.  
 For crimping tool information, see page D1.85.

A. System Overview

B1. Cable Ties

B2. Cable Accessories

B3. Stainless Steel Ties

C1. Wiring Duct

C2. Surface Raceway

C3. Abrasion Protection

C4. Cable Management

D1. Terminals

D2. Power Connectors

D3. Grounding Connectors

E1. Labeling Systems

E2. Labels

E3. Pre-Printed & Write-On Markers

E4. Permanent Identification

E5. Lockout/Tagout & Safety Solutions

F. Index

A. System Overview

B1. Cable Ties

B2. Cable Accessories

B3. Stainless Steel Ties

C1. Wiring Duct

C2. Surface Raceway

C3. Abrasion Protection

C4. Cable Management

D1. Terminals

D2. Power Connectors

D3. Grounding Connectors

E1. Labeling Systems

E2. Labels

E3. Pre-Printed & Write-On Markers

E4. Permanent Identification

E5. Lockout/Tagout & Safety Solutions

F. Index



## Right Angle Female Disconnect, Nylon Insulated – Funnel Entry

### Type DNFR-B

- Right angle design for use in limited space applications
- Disconnect can be inserted and removed from the male tab without the use of tools for lower installed cost
- Longer barrel design for use with Panduit standard disconnect tool
- UL Flammability UL 94V-2/HB, maximum insulation temperature 221°F (105°C)
- UL and CSA rated up to 600 V per UL 310

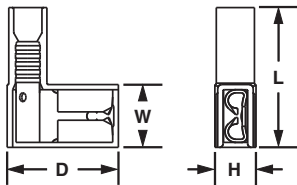

Part Number	Wire Range	Color Code	Max. Ins. (In.)	Figure Dimensions (In.)				Tab Size (In.)	Recommended Installation Tool	Std. Pkg. Qty.	Std. Ctn. Qty.
				L	W	H	D				
DNFR18-205B-L	22 – 18 AWG	Red	0.130	0.78	0.36	0.20	0.62	0.205/0.187 x 0.032	CT-1525‡, CT-2500‡	50	500
DNFR18-206B-L			0.130	0.78	0.36	0.20	0.62	0.205/0.187 x 0.020		50	500
DNFR18-250B-L			0.130	0.78	0.36	0.20	0.62	0.250 x 0.032		50	500
DNFR14-205B-L	16 – 14 AWG	Blue	0.155	0.78	0.36	0.20	0.63	0.205/0.187 x 0.032	CT-1525‡, CT-2500‡	50	500
DNFR14-206B-L			0.155	0.78	0.36	0.20	0.63	0.205/0.187 x 0.020		50	500
DNFR14-250B-L			0.155	0.78	0.36	0.20	0.63	0.250 x 0.032		50	500

\*\*Bulk packaging may be available, contact Panduit Customer Service for additional information.

‡UL and CSA approved tooling/product combinations. For crimping tool information, see pages D1.84 and D1.88.



## Right Angle Female Disconnect, Non-Insulated – Metal Sleeve

### Type DR

- Right angle design for use in limited space applications
- Disconnect can be inserted and removed from the male tab without the use of tools for lower installed cost
- Sleeved barrel helps to facilitate high mechanical and electrical performance when crimping
- Barrel of terminal internally beveled to provide quick and easy wire insertion
- Internal barrel serrations assure good wire contact and maximum tensile strength
- Maximum recommended operating temperature 302°F (150°C)
- UL and CSA rated up to 2000 V per UL 310

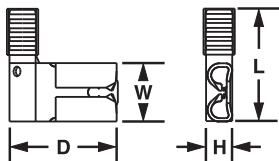

Part Number	Wire Range	Figure Dimensions (In.)				Tab Size (In.)	Recommended Installation Tool	Std. Pkg. Qty.	Std. Ctn. Qty.
		L	W	H	D				
DR18-205-C	22 – 18 AWG	0.54	0.25	0.12	0.53	0.205/0.187 x 0.032	CT-100A‡, CT-200‡, CT-600-A‡, CT-1570‡, CT-2500‡	100	1000
DR18-206-C		0.54	0.25	0.12	0.53	0.205/0.187 x 0.020		100	1000
DR18-250-C		0.57	0.30	0.12	0.54	0.250 x 0.032		100	1000
DR14-205-C	16 – 14 AWG	0.54	0.25	0.12	0.55	0.205/0.187 x 0.032	CT-100A‡, CT-200‡, CT-600-A‡, CT-1570‡, CT-2500‡	100	1000
DR14-206-C		0.54	0.25	0.12	0.55	0.205/0.187 x 0.020		100	1000
<b>DR14-250-C</b>		0.57	0.30	0.12	0.55	0.250 x 0.032		100	1000
<b>DR10-250-L</b>	12 – 10 AWG	0.61	0.30	0.12	0.57	0.250 x 0.032	CT-100A‡, CT-200‡, CT-600-A‡, CT-1570‡, CT-1701‡, CT-2500‡	50	500

\*\*Bulk packaging may be available, contact Panduit Customer Service for additional information.

‡UL and CSA approved tooling/product combinations. For crimping tool information, see pages D1.83, D1.84, D1.86 and D1.88.

\*UL Recognized only.

## Right Angle Female Disconnect Non-Insulated

### Type DR-B

- Disconnect can be inserted and removed from the male tab without the use of tools for lower installed cost
- Barrel of terminal internally beveled to provide quick and easy wire insertion
- Internal barrel serrations assure good wire contact and maximum tensile strength
- For use in limited space applications
- Maximum recommended operating temperature 302°F (150°C)
- Rated up to 2000 V



Part Number	Wire Range	Figure Dimensions (In.)				Tab Size (In.)	Recommended Installation Tool	Std. Pkg. Qty.**	Std. Ctn. Qty.
		L	W	H	D				
DR18-205B-C	22 – 18 AWG	0.54	0.25	0.12	0.53	0.205/0.187 x 0.032	CT-100A, CT-200	100	1000
DR18-206B-C		0.54	0.25	0.12	0.53	0.205/0.187 x 0.020		100	1000
DR18-250B-C		0.55	0.30	0.12	0.53	0.250 x 0.032		100	1000
DR14-205B-C*	16 – 14 AWG	0.54	0.25	0.12	0.55	0.205/0.187 x 0.032	CT-100A, CT-200	100	1000
DR14-206B-C*		0.54	0.25	0.12	0.55	0.205/0.187 x 0.020		100	1000
DR14-250B-C		0.55	0.30	0.12	0.55	0.250 x 0.032		100	1000

\*Not CSA Certified.

\*\*Bulk packaging may be available, contact Panduit Customer Service for additional information. For crimping tool information, see page D1.83.

## Piggyback Disconnect, Vinyl Insulated

### Type DV-P

- Disconnect can be inserted and removed from the male tab without the use of tools for lower installed cost
- Combination of female disconnect and male tab allows versatility in points of connection
- Multiple connection points allow additional circuits to be added to existing equipment without expensive rework
- Metal insulation grip sleeve crimps to wire insulation, providing protection to the crimp joint during high vibration applications
- UL Flammability UL 94V-2/HB, maximum insulation temperature 194°F (90°C)
- Rated up to 300 V



Part Number	Wire Range	Color Code	Max. Ins. (In.)	Figure Dimensions (In.)		Tab Size (In.)	Recommended Installation Tool	Std. Pkg. Qty.**	Std. Ctn. Qty.
				L	W				
DV18-250P-LY	22 – 18 AWG	Red	0.130	0.88	0.29	0.250 x 0.032	CT-100A, CT-260, CT-1550, CT-1551, CT-2500	50	250
DV14-250P-L	16 – 14 AWG	Blue	0.160	0.88	0.29	0.250 x 0.032		50	250

\*\*Bulk packaging may be available, contact Panduit Customer Service for additional information. For crimping tool information, see pages D1.83, D1.84, and D1.88.

## Disconnect Adapter, Non-Insulated

### Type D-A

- Couples two female disconnects to one male disconnect (all 0.250 x 0.032)
- Multiple connection points allow additional circuits to be added to existing equipment without expensive rework
- Disconnect can be inserted and removed from the male tab without the use of tools for lower installed cost
- Maximum recommended operating temperature 302°F (150°C)
- Rated up to 2000 V



Part Number	Figure Dimensions (In.)		Tab Size (In.)	Std. Pkg. Qty.**	Std. Ctn. Qty.
	L	W			
D-250A-C	0.82	0.57	0.250 x 0.032	100	1000

\*\*Bulk packaging may be available, contact Panduit Customer Service for additional information.

A. System Overview

B1. Cable Ties

B2. Cable Accessories

B3. Stainless Steel Ties

C1. Wiring Duct

C2. Surface Raceway

C3. Abrasion Protection

C4. Cable Management

D1. Terminals

D2. Power Connectors

D3. Grounding Connectors

E1. Labeling Systems

E2. Labels

E3. Pre-Printed & Write-On Markers

E4. Permanent Identification

E5. Lockout/Tagout & Safety Solutions

F. Index

A. System Overview

B1. Cable Ties

B2. Cable Accessories

B3. Stainless Steel Ties

C1. Wiring Duct

C2. Surface Raceway

C3. Abrasion Protection

C4. Cable Management

D1. Terminals

D2. Power Connectors

D3. Grounding Connectors

E1. Labeling Systems

E2. Labels

E3. Pre-Printed & Write-On Markers

E4. Permanent Identification

E5. Lockout/Tagout & Safety Solutions

F. Index



## Male Disconnect, Nylon Barrel Insulated – Funnel Entry

### Type DNF-M

- Male tab couples with (all 0.250 x 0.032) female disconnects
- Male tab can be inserted and removed from the female disconnect without the use of tools for lower installed cost
- Metal insulation grip sleeve crimps to wire insulation, providing protection to the crimp joint during high vibration applications
- Internal barrel serrations assure good wire contact and maximum tensile strength
- UL Flammability UL 94V-2/HB, maximum insulation temperature 221°F (105°C)
- Rated up to 600 V

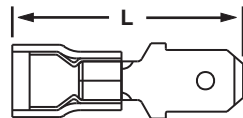

Part Number	Wire Range	Color Code	Max. Ins. (In.)	Figure Dimensions (In.)		Tab Size (In.)	Recommended Installation Tool	Std. Pkg. Qty.**	Std. Ctn. Qty.
				L					
<b>DNF18-250M-C</b>	22 – 18 AWG	Red	0.136	0.90		0.250 x 0.032	CT-1550, CT-1551, CT-2500	100	1000
<b>DNF14-250M-C</b>	16 – 14 AWG	Blue	0.162	0.90		0.250 x 0.032		100	1000
<b>DNF10-250M-L*</b>	12 – 10 AWG	Yellow	0.230	1.03		0.250 x 0.032		50	500

\*Not UL Listed or CSA Certified.

\*\*Bulk packaging may be available, contact Panduit Customer Service for additional information. For crimping tool information, see pages D1.84 and D1.88.



## Male Disconnect, Vinyl Barrel Insulated – Funnel Entry

### Type DV-MB

- Male tab couples with (all 0.250 x 0.032) female disconnects
- Insulation support helps to prevent wire damage in bending applications
- Male tab can be inserted and removed from the female disconnect without the use of tools for lower installed cost
- UL Flammability UL 94V-0, maximum insulation temperature 221°F (105°C)
- Rated up to 600 V

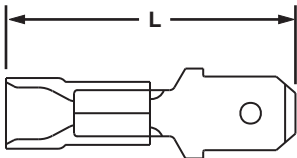

Part Number	Wire Range	Color Code	Max. Ins. (In.)	Figure Dimensions (In.)		Tab Size (In.)	Recommended Installation Tool	Std. Pkg. Qty.**	Std. Ctn. Qty.
				L					
<b>DV18-250MB-CY</b>	22 – 18 AWG	Red	0.154	0.98		0.250 x 0.032	CT-1550, CT-1551, CT-2500	100	500
<b>DV14-250MB-C</b>	16 – 14 AWG	Blue	0.180	0.96		0.250 x 0.032		100	500
<b>DV10-250M-L*</b>	12 – 10 AWG	Yellow	0.235	0.98		0.250 x 0.032		50	500

\*Not UL Listed or CSA Certified.

\*\*Bulk packaging may be available, contact Panduit Customer Service for additional information. For crimping tool information, see pages D1.84 and D1.88.

## Male Disconnect, Non-Insulated – Butted Seam

### Type D-MB

- Male tab couples with (all 0.250 x 0.032) female disconnects
- Male tab can be inserted and removed from the female disconnect without the use of tools for lower installed cost
- Internal barrel serrations assure good wire contact and maximum tensile strength
- Barrel of terminal internally beveled to provide quick and easy wire insertion
- Maximum recommended operating temperature 302°F (150°C)
- Rated up to 2000 V



Part Number	Wire Range	Figure Dimensions (In.)	Tab Size (In.)	Recommended Installation Tool	Std. Pkg. Qty.**	Std. Ctn. Qty.
		L				
<b>D18-250MB-C</b>	22 – 18 AWG	0.69	0.250 x 0.032	CT-100A	100	500
<b>D14-250MB-C</b>	16 – 14 AWG	0.69	0.250 x 0.032		100	500
<b>D10-250M-L*</b>	12 – 10 AWG	0.72	0.250 x 0.032	CT-100A, CT-200, CT-260, CT-1570, CT-2500	50	500

\* Brazed seam.

\*\*To order in bulk, replace -C in the part number with -M for a bulk package of 1000 and replace -L with -D for a bulk package of 500.

For crimping tool information, see pages D1.83, D1.84, and D1.88.

A.  
System  
Overview

B1.  
Cable Ties

B2.  
Cable  
Accessories

B3.  
Stainless  
Steel Ties

C1.  
Wiring  
Duct

C2.  
Surface  
Raceway

C3.  
Abrasion  
Protection

C4.  
Cable  
Management

D1.  
Terminals

D2.  
Power  
Connectors

D3.  
Grounding  
Connectors

E1.  
Labeling  
Systems

E2.  
Labels

E3.  
Pre-Printed  
& Write-On  
Markers

E4.  
Permanent  
Identification

E5.  
Lockout/  
Tagout  
& Safety  
Solutions

F.  
Index

A. System Overview

B1. Cable Ties

B2. Cable Accessories

B3. Stainless Steel Ties

C1. Wiring Duct

C2. Surface Raceway

C3. Abrasion Protection

C4. Cable Management

D1. Terminals

D2. Power Connectors

D3. Grounding Connectors

E1. Labeling Systems

E2. Labels

E3. Pre-Printed & Write-On Markers

E4. Permanent Identification

E5. Lockout/Tagout & Safety Solutions

F. Index

## Selection Guide – Specialty Terminals



Material	Style	Feature	Type	Page Number
Vinyl	Pin Terminal	Insulation Support	PV-P	D1.54
	Blade Terminal	Insulation Support	DV-M	D1.55
Non-Insulated	Pin Terminal	Brazed Seam	P-P	D1.54
	Blade Terminal	Brazed Seam	D-M	D1.55



### Pin Terminal, Vinyl Insulated – Funnel Entry

#### Type PV-P

- Solid pin designed to prevent damage to the wire from over tightening, resulting in a reliable electrical connection
- Insulation support helps to prevent wire damage in bending applications
- Brazed seam protects terminal barrel from splitting during the crimp process

- Internal barrel serrations assure good wire contact and maximum tensile strength
- For use with pin-type terminal blocks
- UL Flammability UL 94V-0, maximum insulation temperature 221°F (105°C)
- UL rated up to 600 V per UL 486A/B



Part Number	Wire Range	Color Code	Max. Ins. (In.)	Figure Dimensions (In.)			Recommended Installation Tool	Std. Pkg. Qty.**	Std. Ctn. Qty.
				L	W	P			
<b>PV18-P47-CY</b>	22 – 18 AWG	Red	0.150	0.97	0.07	0.49	CT-100A, CT-260, CT-1550, CT-1551, CT-2500	100	1000
<b>PV14-P47-C</b>	16 – 14 AWG	Blue	0.170	0.97	0.07	0.49		100	1000
<b>PV10-P55-LY*</b>	12 – 10 AWG	Yellow	0.250	1.10	0.10	0.55		50	500

\*Not UL Listed.

\*\*Bulk packaging may be available, contact Panduit Customer Service for additional information. For crimping tool information, see pages D1.83, D1.84, and D1.88.

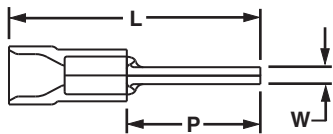

### Pin Terminal, Non-Insulated

#### Type P-P

- Solid pin designed to prevent damage to the wire from over tightening, resulting in a reliable electrical connection
- Brazed seam protects terminal barrel from splitting during the crimp process
- Internal barrel serrations assure good wire contact and maximum tensile strength

- Barrel of terminal internally beveled to provide quick and easy wire insertion
- For use with pin-type terminal blocks
- Maximum recommended operating temperature 302°F (150°C)
- UL rated up to 600 V per UL 486A/B



Part Number	Wire Range	Figure Dimensions (In.)			Recommended Installation Tool	Std. Pkg. Qty.**	Std. Ctn. Qty.
		L	W	P			
<b>P18-P47-C</b>	22 – 18 AWG	0.75	0.07	0.49	CT-100A, CT-200, CT-260, CT-1570, CT-2500	100	1000
<b>P14-P47-C</b>	16 – 14 AWG	0.75	0.07	0.49		100	1000
<b>P10-P55-L*</b>	12 – 10 AWG	0.79	0.11	0.55		50	500

\*Not UL Listed.

\*\*Bulk packaging may be available, contact Panduit Customer Service for additional information.

†UL and CSA approved tooling/product combinations. For crimping tool information, see pages D1.83, D1.84, and D1.88.

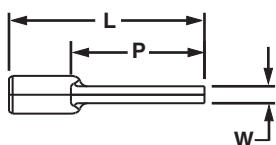

## **PA** **SE** Male Blade Adapter, Vinyl Insulated – Funnel Entry

### Type DV-M

- Flat blade design to prevent damage to the wire from over tightening, resulting in a reliable electrical connection
- For use with blade-type terminal blocks
- Insulation support helps to prevent wire damage in bending applications
- Brazed seam protects terminal barrel from splitting during the crimp process
- UL Flammability UL 94V-0, maximum insulation temperature 221°F (105°C)
- Rated up to 600 V

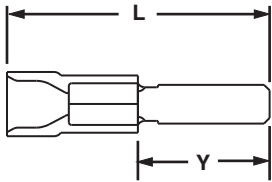

Part Number	Wire Range	Color Code	Max. Ins. (In.)	Figure Dimensions (In.)		Tab Size (In.)	Recommended Installation Tool	Std. Pkg. Qty.**	Std. Ctn. Qty.
				L	Y				
<b>DV18-145M-CY</b>	22 – 18 AWG	Red	0.150	0.97	0.42	0.145 x 0.032	CT-600-A, CT-1550‡, CT-1551‡, CT-2500‡	100	500
<b>DV14-145M-C</b>	16 – 14 AWG	Blue	0.170	0.97	0.42	0.145 x 0.032		100	500

\*\*Bulk packaging may be available, contact Panduit Customer Service for additional information.

‡UL and CSA approved tooling/product combinations. For crimping tool information, see pages D1.84, D1.86, and D1.88.

## **PA** **SE** Male Blade Adapter, Non-Insulated

### Type D-M

- Flat blade design to prevent damage to the wire from over tightening, resulting in a reliable electrical connection
- For use with blade-type terminal blocks
- Internal barrel serrations assure good wire contact and maximum tensile strength
- Brazed seam protects terminal barrel from splitting during the crimp process
- Barrel of terminal internally beveled to provide quick and easy wire insertion
- Maximum recommended operating temperature 302°F (150°C)
- Rated up to 2000 V

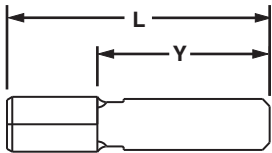

Part Number	Wire Range	Figure Dimensions (In.)		Tab Size (In.)	Recommended Installation Tool	Std. Pkg. Qty.**	Std. Ctn. Qty.
		L	Y				
<b>D18-145M-C</b>	22 – 18 AWG	0.75	0.42	0.145 x 0.032	CT-100A‡, CT-200‡, CT-600-A, CT-1570‡, CT-2500‡	100	500
<b>D14-145M-C</b>	16 – 14 AWG	0.75	0.42	0.145 x 0.032		100	500

\*\*Bulk packaging may be available, contact Panduit Customer Service for additional information.

‡UL and CSA approved tooling/product combinations. For crimping tool information, see pages D1.83, D1.84, D1.86 and D1.88.

A. System Overview

B1. Cable Ties

B2. Cable Accessories

B3. Stainless Steel Ties

C1. Wiring Duct

C2. Surface Raceway

C3. Abrasion Protection

C4. Cable Management

D1. Terminals

D2. Power Connectors

D3. Grounding Connectors

E1. Labeling Systems

E2. Labels

E3. Pre-Printed & Write-On Markers

E4. Permanent Identification

E5. Lockout/Tagout & Safety Solutions

F. Index

A. System Overview

## Features and Benefits – Pan-Term® Metric Disconnects

B1. Cable Ties

### Metric Nylon Fully Insulated Female and Male Tabs Type DMNF-FIB

Available in tab sizes to accommodate 2.8, 4.8, and 6.3mm tabs

Fully insulated design provides protection from electrical shorts



Expanded wire entry (on select sizes) accommodates large insulation or multiple wires

Maximum insulation temperature 221°F (105°C)

Insulation support restricts excessive wire movement to minimize stress on crimp joint

Funnel entry for faster wire insertion and lower installed cost

Rated at 600 V.  
Flammability UL 94V-2/HB.

B2. Cable Accessories

B3. Stainless Steel Ties

C1. Wiring Duct

C2. Surface Raceway

C3. Abrasion Protection

C4. Cable Management

### Nylon Barrel Insulated Female Receptacles and Male Tabs Type DMNF

Available in tab sizes to accommodate 2.8, 4.8, and 6.3mm tabs

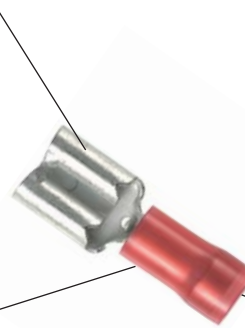

Maximum insulation temperature 221°F (105°C)

Funnel entry for faster wire insertion and lower installed cost

Rated at 600 V.  
Flammability UL 94V-2/HB.

D1. Terminals

D2. Power Connectors

D3. Grounding Connectors

E1. Labeling Systems

E2. Labels

E3. Pre-Printed & Write-On Markers

E4. Permanent Identification

E5. Lockout/Tagout & Safety Solutions

F. Index

### Vinyl Barrel Insulated Female Receptacles Type DMV

Available in tab sizes to accommodate 2.8, 4.8, and 6.3mm tabs

Maximum insulation temperature 221°F (105°C)



Insulation support to protect electrical crimp

Insulation grip sleeve provides a superior insulation crimp for high vibration and high strain relief applications

Rated at 600 V.  
Flammability UL 94V-0.

### Non-Insulated Female Receptacles and Male Tabs Type DM

Available in tab sizes to accommodate 2.8, 4.8, and 6.3mm tabs

Maximum recommended operating temperature 302°F (150°C)



Sleeved barrel assures crimp reliability

Rated up to 2000 V.



Panduit extensive line of tooling is specifically designed for optimum crimping performance.

See pages D1.83 – D1.89.



Panduit designs and manufactures a full line of labeling products, software, and printers to assist you with your labeling requirements.

See pages E1.1 – E2.28.



## Part Number System for Pan-Term® Metric Disconnects

<b>DM</b>	<b>NF</b>	<b>1</b>	<b>—</b>	<b>285</b>	<b>FIB</b>	<b>—</b>	<b>C</b>
Type	Insulation	Wire Range		Size and Type	Special Configuration		Package Size
DM = Disconnect Metric	N = Nylon NF = Nylon Funnel V = Vinyl = Non-Insulated (leave blank)	1 = 0.5 – 1.0mm <sup>2</sup> (22 – 18 AWG) 2 = 1.5 – 2.5mm <sup>2</sup> (16 – 14 AWG) 6 = 4.0 – 6.0mm <sup>2</sup> (12 – 10 AWG)		285 = 2.8mm x 0.5mm (0.110 x 0.020) 288 = 2.8mm x 0.8mm (0.110 x 0.032) 488 = 4.8mm x 0.8mm (0.188 x 0.032) 63 = 6.3mm x 0.8mm (0.250 x 0.032)	B = Butted Seam, Female FI = Fully Insulated, Female FIB = Fully Insulated, Butted Seam, Female FIM = Fully Insulated, Male M = Male MB = Butted Seam, Male = Female (leave blank)		X = 10 E = 20 Q = 25 L = 50 C = 100

## Female Metric Disconnect, Fully Insulated Nylon – Funnel Entry

### Type DMNF-FIB

- Disconnect can be inserted and removed from the male tab without the use of tools for lower installed cost
- Fully insulated design provides protection from electrical shorts
- Internal wire stop assures proper length of insertion into terminal barrel, providing a higher quality connection
- Maximum insulation temperature 221°F (105°C)
- Rated up to 600 V

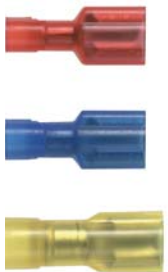

Part Number	Wire Range	Color Code	Max. Ins. (mm)	Figure Dimensions (mm)			Tab Size (mm)	Recommended Installation Tool	Std. Pkg. Qty.**	Std. Ctn. Qty.
				L	W	H				
DMNF1-285FIB-C	0.5 – 1.0	Red	3.05	18.0	4.8	4.1	2.8 x 0.5	CT-1525, CT-2500	100	500
DMNF1-288FIB-C			3.05	18.0	4.8	4.1	2.8 x 0.8		100	500
DMNF1-488FIB-C			3.35	19.8	7.9	5.5	4.8 x 0.8		100	1000
DMNF1-63FIB-C			3.35	21.3	8.9	5.5	6.3 x 0.8		100	500
DMNF2-488FIB-C	1.5 – 2.5	Blue	3.96	19.8	7.9	5.5	4.8 x 0.8	CT-1525, CT-2500	100	1000
DMNF2-63FIB-C			3.96	21.3	8.9	5.5	6.3 x 0.8		100	500
DMNF6-63FI-L	4.0 – 6.0	Yellow	5.84	24.4	8.9	6.9	6.3 x 0.8	CT-1551	50	250

\*\*Bulk packaging may be available, contact Panduit Customer Service for additional information. For crimping tool information, see pages D1.84 and D1.88.

A. System Overview

B1. Cable Ties

B2. Cable Accessories

B3. Stainless Steel Ties

C1. Wiring Duct

C2. Surface Raceway

C3. Abrasion Protection

C4. Cable Management

D1. Terminals

D2. Power Connectors

D3. Grounding Connectors

E1. Labeling Systems

E2. Labels

E3. Pre-Printed & Write-On Markers

E4. Permanent Identification

E5. Lockout/Tagout & Safety Solutions

F. Index

A. System Overview

## Female Metric Disconnect, Nylon Barrel Insulated – Funnel Entry

B1. Cable Ties

### Type DMNF

- Disconnect can be inserted and removed from the male tab without the use of tools for lower installed cost
- Metal insulation grip sleeve crimps to wire insulation, providing protection to the crimp joint during high vibration applications
- Internal barrel serrations assure good wire contact and maximum tensile strength
- Internal wire stop assures proper length of insertion into terminal barrel, providing a higher quality connection
- Maximum insulation temperature 221°F (105°C)
- Rated up to 300 V

B2. Cable Accessories

B3. Stainless Steel Ties



C1. Wiring Duct



C2. Surface Raceway

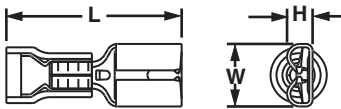

C3. Abrasion Protection

C4. Cable Management

D1. Terminals

D2. Power Connectors

D3. Grounding Connectors

Part Number	Wire Range (mm <sup>2</sup> )	Color Code	Max. Ins. (mm)	Figure Dimensions (mm)			Tab Size (mm)	Recommended Installation Tool	Std. Pkg. Qty.	Std. Ctn. Qty.
				L	W	H				
DMNF1-285-C	0.5 – 1.0	Red	2.50	17.8	3.8	2.0	2.8 x 0.5	CT-1551	100	500
DMNF1-288-C			2.50	17.6	3.8	2.0	2.8 x 0.8		100	500
DMNF1-488-C			3.60	19.6	5.8	2.5	4.8 x 0.8		100	500
DMNF1-63-C	1.5 – 2.5	Blue	3.58	20.7	7.4	3.1	6.3 x 0.8		100	500
DMNF2-288-C			4.20	18.8	3.8	2.0	2.8 x 0.8		100	500
DMNF2-488-C			4.20	19.6	5.8	2.5	4.8 x 0.8		100	500
DMNF2-63-C			4.22	21.1	7.4	3.1	6.3 x 0.8	100	500	

For crimping tool information, see page D1.84.

## Female Metric Disconnect, Vinyl Barrel Insulated – Funnel Entry

### Type DMV

- Disconnect can be inserted and removed from the male tab without the use of tools for lower installed cost
- Internal barrel serrations assure good wire contact and maximum tensile strength
- Internal wire stop assures proper length of insertion into terminal barrel, providing a higher quality connection
- Maximum insulation temperature 221°F (105°C)
- Rated up to 600 V

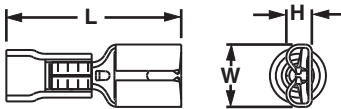

Part Number	Wire Range (mm <sup>2</sup> )	Color Code	Max. Ins. (mm)	Figure Dimensions (mm)			Tab Size (mm)	Recommended Installation Tool	Std. Pkg. Qty.	Std. Ctn. Qty.
				L	W	H				
DMV6-63-L	2.5 – 6.0	Yellow	5.80	25.7	7.6	3.3	6.3 x 0.8	CT-1551	50	250

For crimping tool information, see page D1.84.

E1. Labeling Systems

## Female Metric Disconnect, Non-Insulated – Metal Sleeve

### Type DM

- Disconnect can be inserted and removed from the male tab without the use of tools for lower installed cost
- Sleeved barrel helps to facilitate high mechanical and electrical performance when crimping
- Barrel of terminal internally beveled to provide quick and easy wire insertion
- Internal barrel serrations assure good wire contact and maximum tensile strength
- Internal wire stop assures proper length of insertion into terminal barrel, providing a higher quality connection
- Maximum recommended operating temperature 302°F (150°C)
- Rated up to 2000 V

E2. Labels

E3. Pre-Printed & Write-On Markers

E4. Permanent Identification

E5. Lockout/Tagout & Safety Solutions



Part Number	Wire Range (mm <sup>2</sup> )	Figure Dimensions (mm)			Tab Size (mm)	Recommended Installation Tool	Std. Pkg. Qty.	Std. Ctn. Qty.
		L	W	H				
DM1-488-C	0.5 – 1.0	15.0	5.9	2.5	4.8 x 0.8	CT-1570, CT-2500	100	500
DM1-63-C		16.8	7.6	3.0	6.3 x 0.8		100	500
DM2-488-C	1.5 – 2.5	15.0	5.9	2.5	4.8 x 0.8		100	500
DM2-63-C		16.8	7.6	3.0	6.3 x 0.8		100	500
DM6-63-L	4.0 – 6.0	18.2	7.6	3.0	6.3 x 0.8		50	250

For crimping tool information, see pages D1.84 and D1.88.

## Piggyback Metric Disconnect, Vinyl Barrel Insulated

### Type DMV-P

- Combination of female disconnect and male tab allows versatility in points of connection
- Multiple connection points allow additional circuits to be added to existing equipment without expensive rework
- Metal insulation grip sleeve crimps to wire insulation, providing protection to the crimp joint during high vibration applications
- Maximum insulation temperature 194°F (90°C)
- Rated up to 600 V

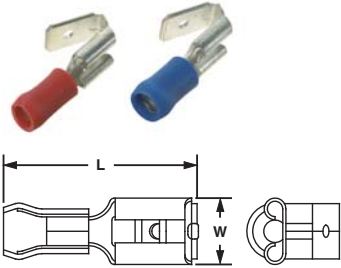

Part Number	Wire Range (mm <sup>2</sup> )	Color Code	Max. Ins. (mm)	Figure Dimensions (mm)		Tab Size (mm)	Recommended Installation Tool	Std. Pkg. Qty.	Std. Ctn. Qty.
				L	W				
DMV1-63P-LY	0.5 – 1.0	Red	3.30	22.4	7.4	6.3 x 0.8	CT-1551	50	500
DMV2-63P-L	1.5 – 2.5	Blue	4.06	22.4	7.4	6.3 x 0.8		50	500

For crimping tool information, see page D1.84.

## Male Metric Disconnect, Fully Insulated Nylon – Funnel Entry

### Type DMNF-FIM

- Male tab couples with (all 6.3mm x 0.8mm) female disconnects
- Fully insulated design provides protection from electrical shorts
- Male tab can be inserted and removed from the female disconnect without the use of tools for lower installed cost
- Internal barrel serrations assure good wire contact and maximum tensile strength
- Maximum insulation temperature 221°F (105°C)
- Rated up to 600 V

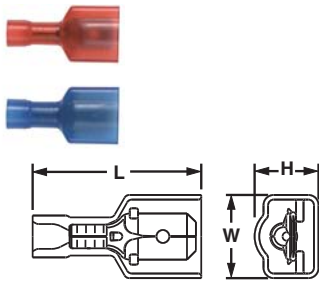

Part Number	Wire Range (mm <sup>2</sup> )	Color Code	Max. Ins. (mm)	Figure Dimensions (mm)			Tab Size (mm)	Recommended Installation Tool	Std. Pkg. Qty.	Std. Ctn. Qty.
				L	W	H				
DMNF1-63FIM-L	0.5 – 1.0	Red	3.38	22.9	10.3	7.03	6.3 x 0.8	CT-1525, CT-2500	50	500
DMNF2-63FIM-L	1.5 – 2.5	Blue	4.01	22.9	10.4	7.05	6.3 x 0.8		50	500

For crimping tool information, see pages D1.84 and D1.88.

## Male Metric Disconnect, Nylon Barrel Insulated – Funnel Entry

### Type DMNF-M

- Male tab couples with (all 6.3mm x 0.8mm) female disconnects
- Male tab can be inserted and removed from the female disconnect without the use of tools for lower installed cost
- Metal insulation grip sleeve crimps to wire insulation, providing protection to the crimp joint during high vibration applications
- Internal barrel serrations assure good wire contact and maximum tensile strength
- Maximum insulation temperature 221°F (105°C)
- Rated up to 600 V

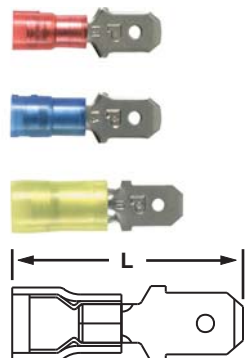

Part Number	Wire Range (mm <sup>2</sup> )	Color Code	Max. Ins. (mm)	Figure Dimensions (mm)	Tab Size (mm)	Recommended Installation Tool	Std. Pkg. Qty.	Std. Ctn. Qty.
				L				
DMNF1-63M-C	0.5 – 1.0	Red	3.96	22.7	6.3 x 0.8	CT-1551	100	500
DMNF2-63M-C	1.5 – 2.5	Blue	4.83	23.6	6.3 x 0.8		100	500
DMNF6-63M-L	4.0 – 6.0	Yellow	6.20	23.6	6.3 x 0.8		50	250

For crimping tool information, see page D1.84.

A. System Overview

## Male Metric Disconnect, Non-Insulated – Butted Seam

B1. Cable Ties

### Type DM-M

- Male tab couples with (all 6.3mm x 0.8mm) female disconnects
- Male tab can be inserted and removed from the female disconnect without the use of tools for lower installed cost
- Internal barrel serrations assure good wire contact and maximum tensile strength
- Barrel of terminal internally beveled to provide quick and easy wire insertion
- Maximum recommended operating temperature 302°F (150°C)
- Rated up to 2000 V

B2. Cable Accessories

B3. Stainless Steel Ties



C1. Wiring Duct



C2. Surface Raceway

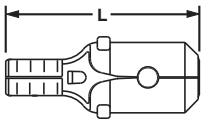

C3. Abrasion Protection

## Metric Pin Terminal, Vinyl Insulated – Funnel Entry

### Type PMV-P

- Solid pin designed to prevent damage to the wire from over tightening, resulting in a reliable electrical connection
- For use with pin-type terminal blocks
- Insulation support helps to prevent wire damage in bending applications
- Brazed seam protects terminal barrel from splitting during the crimp process
- Internal barrel serrations assure good wire contact and maximum tensile strength
- Maximum insulation temperature 221°F (105°C)
- Rated up to 600 V

C4. Cable Management

D1. Terminals



D2. Power Connectors



D3. Grounding Connectors

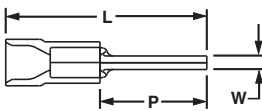

Part Number	Wire Range (mm <sup>2</sup> )	Figure Dimensions (mm)			Recommended Installation Tool	Std. Pkg. Qty.	Std. Ctn. Qty.
		L	W	P			
DM1-63M-C	0.5 – 1.0	19.2	6.3	0.8	CT-1570, CT-2500	100	500
DM2-63M-C	1.5 – 2.5	19.2	6.3	0.8		100	500
DM6-63M-L*	4.0 – 6.0	18.2	6.3	0.8		50	250

\*Brazed seam.  
For crimping tool information, see pages D1.84 and D1.88.

E1. Labeling Systems

## Metric Pin Terminal, Non-Insulated

### Type PM-P

- Solid pin designed to prevent damage to the wire from over tightening, resulting in a reliable electrical connection
- For use with pin-type terminal blocks
- Insulation support helps to prevent wire damage in bending applications
- Brazed seam protects terminal barrel from splitting during the crimp process
- Internal barrel serrations assure good wire contact and maximum tensile strength
- Maximum recommended operating temperature 302°F (150°C)
- Rated up to 2000 V

E2. Labels

E3. Pre-Printed & Write-On Markers

E4. Permanent Identification



E5. Lockout/Tagout & Safety Solutions

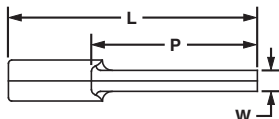

Part Number	Wire Range (mm <sup>2</sup> )	Figure Dimensions (mm)			Recommended Installation Tool	Std. Pkg. Qty.	Std. Ctn. Qty.
		L	W	P			
PM1-P10-C	0.5 – 1.0	19.0	1.8	12.4	CT-1570, CT-2500	100	500
PM2-P10-C	1.5 – 2.5	19.0	1.8	12.4		100	500
PM6-P10-L	4.0 – 6.0	20.1	2.8	14.0		50	250

For crimping tool information, see pages D1.84 and D1.88.

F. Index

## PAN-TERM® SPLICES

Panduit® Pan-Term® Splices are designed and manufactured for fast assembly, and long reliable performance. As the demand for splices increases, it becomes essential to provide a complete system for termination products. We provide an extensive line of tooling designed specifically to provide optimum performance when used as a system for terminating.



- Suitable for in-line, parallel, and group splicing of wires
- Nylon and vinyl insulated as well as non-insulated
- Available in sizes from #26 – 10 AWG
- Internal wire stops on butt splices prevent over insertion of wires
- Applicable sizes are UL Listed and CSA Certified, as noted
- Wide assortment of manual, controlled cycle, battery operated hydraulic and pneumatic crimping tools for reliable connections at the lowest installed cost

Panduit continually provides new designs to meet the application challenges encountered by our customers. Panduit offers a wide assortment of Pan-Term® termination products to meet customer needs at the lowest installed cost.

A.  
System  
Overview

B1.  
Cable Ties

B2.  
Cable  
Accessories

B3.  
Stainless  
Steel Ties

C1.  
Wiring  
Duct

C2.  
Surface  
Raceway

C3.  
Abrasion  
Protection

C4.  
Cable  
Management

D1.  
Terminals

D2.  
Power  
Connectors

D3.  
Grounding  
Connectors

E1.  
Labeling  
Systems

E2.  
Labels

E3.  
Pre-Printed  
& Write-On  
Markers

E4.  
Permanent  
Identification

E5.  
Lockout/  
Tagout  
& Safety  
Solutions

F.  
Index

A. System Overview

## Features and Benefits – Pan-Term® Splices and Wire Joints

B1. Cable Ties

B2. Cable Accessories

B3. Stainless Steel Ties

C1. Wiring Duct

C2. Surface Raceway

C3. Abrasion Protection

C4. Cable Management

D1. Terminals

D2. Power Connectors

D3. Grounding Connectors

E1. Labeling Systems

E2. Labels

E3. Pre-Printed & Write-On Markers

E4. Permanent Identification

E5. Lockout/Tagout & Safety Solutions

F. Index

### Non-Insulated Wire Joints Type J

Only one crimp needed to complete splice

Maximum recommended operating temperature 302°F (150°C)



Internally beveled barrel for quick easy wire insertion

UL and CSA rated up to 2000 V per UL 486C.

### Non-Insulated Parallel Splices Type PS

Seamless tubular barrel provides consistent high performance quality crimps

Maximum recommended operating temperature 302°F (150°C)



Only one crimp needed to complete splice

UL and CSA rated up to 2000 V per UL 486C.

### Nylon Wire Joints Type JN

Fully insulated housing protects crimp joint

Maximum insulation temperature 221°F (105°C)



Only one crimp needed to complete splice

Deep skirt to accommodate multiple variations of wire combinations

UL and CSA rated up to 600 V per UL 486C.  
Metric versions available.  
Flammability – UL 94V-2/HB.

### Nylon Parallel Splices Type PSN

Maximum insulation temperature 221°F (105°C)



Only one crimp needed to complete splice

Rated up to 300 V.  
Flammability – UL 94V-2/HB.



Panduit extensive line of tooling is specifically designed for optimum crimping performance.

See pages D1.83 – D1.89.



Panduit designs and manufactures a full line of labeling products, software, and printers to assist you with your labeling requirements.

See pages E1.1 – E2.28.

## Features and Benefits – Pan-Term® Splices

### Nylon Butt Splices Type BSN

Internal wire stops assure proper insertion length



Maximum insulation temperature 221°F (105°C)

Brazed seam assures crimp reliability

UL and CSA rated up to 600 V per UL 486C.  
Flammability – UL 94V-2/HB.

### Vinyl Butt Splices Type BSV

Internal wire stops assure proper insertion, length



Maximum insulation temperature 221°F (105°C)

Brazed seam assures crimp reliability

Expanded wire entry accommodates larger insulation

UL and CSA rated up to 600 V per UL 486C.  
Flammability – UL 94V-0.  
Metric versions available.

### Non-Insulated Butt Splices Type BS

Internal wire stops assure proper insertion length



Brazed seam assures crimp reliability

Maximum recommended operating temperature 302°F (150°C)

Internally beveled barrel for quick easy wire insertion

UL and CSA rated up to 2000 V per UL 486C.  
Metric versions available.

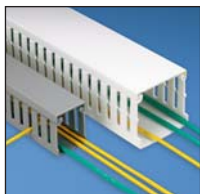

Panduit wiring duct offers a wide variety of sizes and types to meet the wire capacity needs and space constraints of the smallest wall mounted to the largest integrated systems.

See pages C1.1 – C1.52.



A comprehensive selection of cable ties used to bundle, mount, and identify wire and cable.

See pages B1.1 – B1.120.

A.  
System  
Overview

B1.  
Cable Ties

B2.  
Cable  
Accessories

B3.  
Stainless  
Steel Ties

C1.  
Wiring  
Duct

C2.  
Surface  
Raceway

C3.  
Abrasion  
Protection

C4.  
Cable  
Management

D1.  
Terminals

D2.  
Power  
Connectors

D3.  
Grounding  
Connectors

E1.  
Labeling  
Systems

E2.  
Labels

E3.  
Pre-Printed  
& Write-On  
Markers

E4.  
Permanent  
Identification

E5.  
Lockout/  
Tagout  
& Safety  
Solutions

F.  
Index

## A. System Overview

### Selection Guide – Pan-Term® Splices and Wire Joints

B1. Cable Ties

B2. Cable Accessories

B3. Stainless Steel Ties

C1. Wiring Duct

C2. Surface Raceway

C3. Abrasion Protection

C4. Cable Management

D1. Terminals

D2. Power Connectors

D3. Grounding Connectors

E1. Labeling Systems

E2. Labels

E3. Pre-Printed & Write-On Markers

E4. Permanent Identification

E5. Lockout/Tagout & Safety Solutions

F. Index

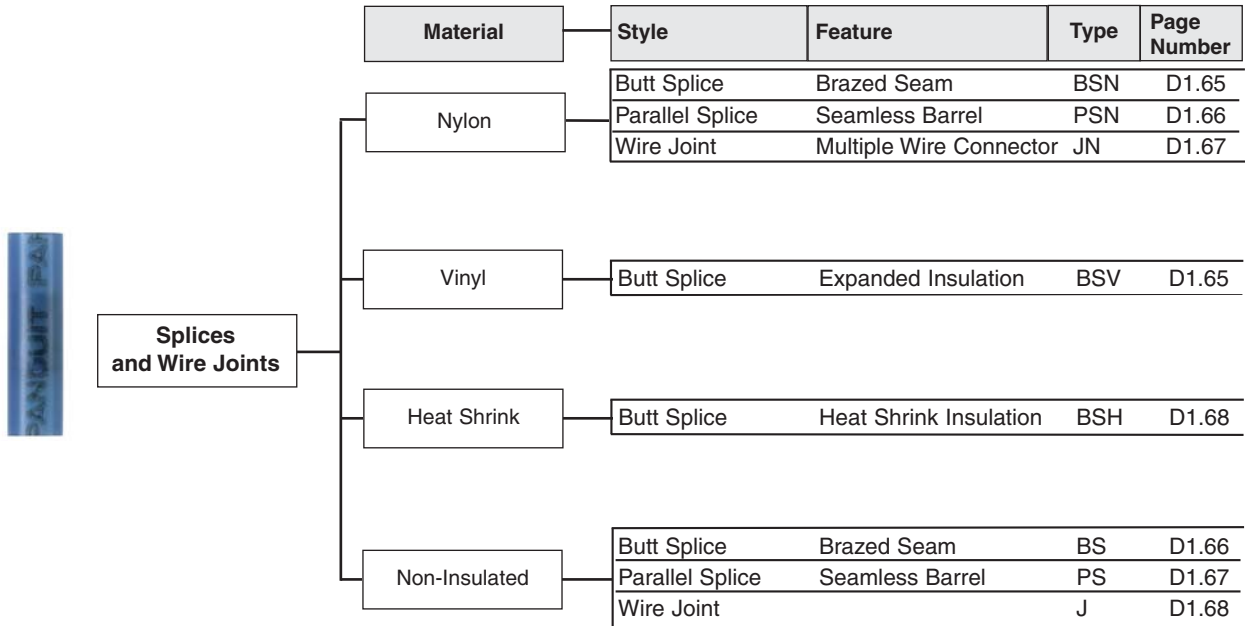

### Part Number System for Pan-Term® Splices

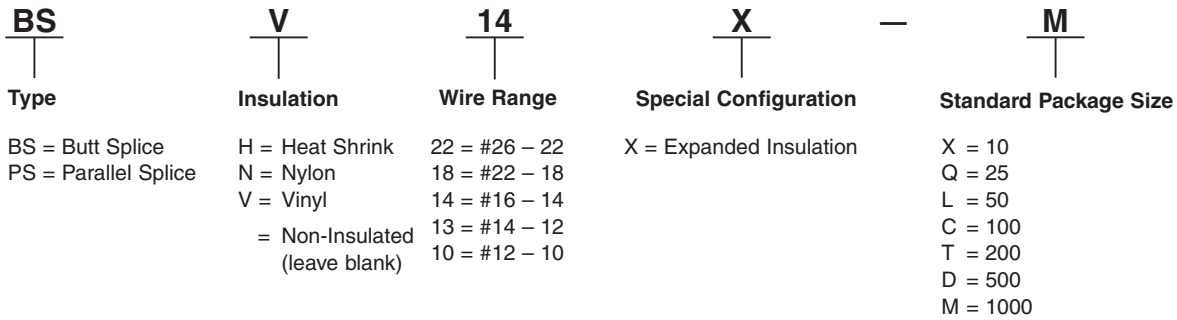

### Part Number System for Pan-Term® Wire Joints

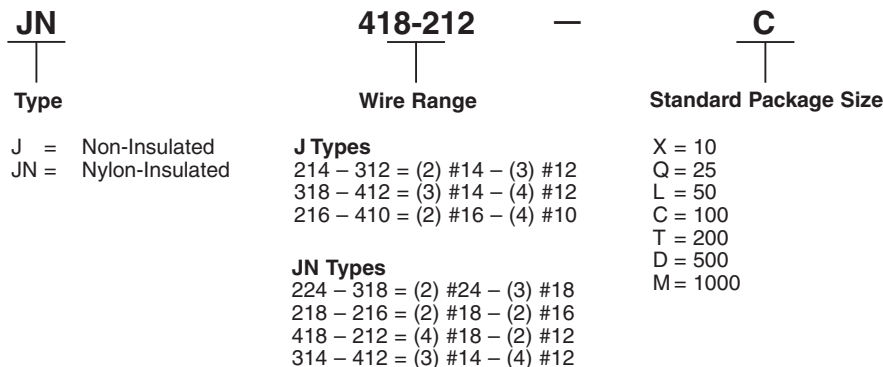





## Butt Splice, Nylon Insulated

### Type BSN

- Designed to splice two solid or stranded wires together to repair or lengthen wires
- Butted configuration provides low profile for limited space applications
- Brazed seam protects terminal barrel from splitting during the crimp process
- Internal wire stop assures proper length of insertion into terminal barrel
- UL Flammability UL 94V-2/HB, maximum insulation temperature 221°F (105°C)
- UL and CSA rated up to 600 V per UL 486C

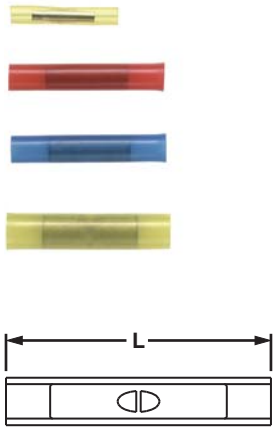

Part Number	Wire Range	Color Code	Max. Ins. (In.)	Figure Dimensions (In.)	Recommended Installation Tool	Std. Pkg. Qty.**	Std. Ctn. Qty.
				L			
<b>BSN22-C*</b>	26 – 22 AWG	Yellow	0.080	0.79	CT-1525, CT-2500	100	1000
<b>BSN18-C</b>	22 – 18 AWG	Red	0.115	1.15	CT-100A, CT-600-A, CT-1550, CT-1551, CT-2500	100	1000
<b>BSN14-C</b>	16 – 14 AWG	Blue	0.148	1.15	CT-100A, CT-600-A, CT-1550, CT-1551, CT-2500	100	1000
<b>BSN10-L</b>	12 – 10 AWG	Yellow	0.210	1.14	CT-100A, CT-600-A, CT-1550, CT-1551, CT-2500	50	500

\*Not UL Listed.

\*\*Bulk packaging may be available, contact Panduit Customer Service for additional information. For crimping tool information, see pages D1.83, D1.84, D1.86 and D1.88.



## Butt Splice, Vinyl Insulated

### Type BSV

- Expanded wire entry designed to accommodate wire with a larger insulation thickness
- Designed to splice two solid or stranded wires together to repair or lengthen wires
- Brazed seam protects terminal barrel from splitting during the crimp process
- Internal wire stop assures proper length of insertion into terminal barrel
- UL Flammability UL 94V-0, maximum insulation temperature 221°F (105°C)
- UL and CSA rated up to 600 V per UL 486C

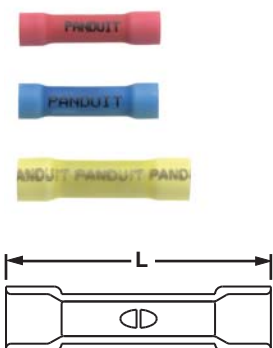

Part Number	Wire Range	Color Code	Max. Ins. (In.)	Figure Dimensions (In.)	Recommended Installation Tool	Std. Pkg. Qty.**	Std. Ctn. Qty.
				L			
<b>BSV18X-LY</b>	22 – 18 AWG	Red	0.170	1.03	CT-100A, CT-600-A, CT-1550, CT-1551, CT-2500	50	500
<b>BSV14X-L</b>	16 – 14 AWG	Blue	0.211	1.04		50	500
<b>BSV10X-Q</b>	12 – 10 AWG	Yellow	0.260	1.17		25	250

\*\*Bulk packaging may be available, contact Panduit Customer Service for additional information. For crimping tool information, see pages D1.83, D1.84, D1.86 and D1.88.

A. System Overview

B1. Cable Ties

B2. Cable Accessories

B3. Stainless Steel Ties

C1. Wiring Duct

C2. Surface Raceway

C3. Abrasion Protection

C4. Cable Management

D1. Terminals

D2. Power Connectors

D3. Grounding Connectors

E1. Labeling Systems

E2. Labels

E3. Pre-Printed & Write-On Markers

E4. Permanent Identification

E5. Lockout/Tagout & Safety Solutions

F. Index

A. System Overview

B1. Cable Ties



## Butt Splice, Non-Insulated

### Type BS

- Designed to splice two solid or stranded wires together to repair or lengthen wires
- Butted configuration provides low profile for limited space applications
- Brazed seam protects terminal barrel from splitting during the crimp process

- Internal wire stop assures proper length of insertion into terminal barrel
- Non-insulated barrel can be used to provide an economical termination when insulation is not required
- Maximum recommended operating temperature 302°F (150°C)
- UL and CSA rated up to 2000 V per UL 486C

B2. Cable Accessories

B3. Stainless Steel Ties



C1. Wiring Duct



C2. Surface Raceway



C3. Abrasion Protection

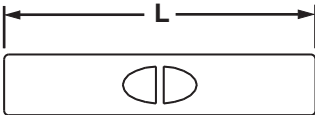

C4. Cable Management

Part Number	Wire Range	Figure Dimensions (In.)	Recommended Installation Tool	Std. Pkg. Qty.**	Std. Ctn. Qty.
		L			
<b>BS22-C*</b>	26 – 22 AWG	0.47	CT-100A	100	1000
<b>BS18-C</b>	22 – 18 AWG	0.62	CT-100A, CT-200, CT-600-A, CT-1570, CT-2500	100	1000
<b>BS14-C</b>	16 – 14 AWG	0.62	CT-100A, CT-200, CT-600-A, CT-1570, CT-2500	100	1000
<b>BS10-L</b>	12 – 10 AWG	0.63	CT-100A, CT-200, CT-600-A, CT-1570, CT-2500, CT-1701‡	50	500

\*Not UL Listed.

\*\*Bulk packaging may be available, contact Panduit Customer Service for additional information.

‡UL and CSA approved tooling/product combinations. For crimping tool information, see pages D1.83, D1.84, D1.86 and D1.88.

D1. Terminals

D2. Power Connectors

D3. Grounding Connectors

## Parallel Splice, Nylon Insulated

### Type PSN

- Designed to splice two solid or stranded wires together to repair or lengthen wires
- Parallel design results in only one crimp required to complete splice

- Seamless tubular barrel provides a consistent high performance quality crimp
- Maximum insulation temperature 221°F (105°C)
- Rated up to 300 V

E1. Labeling Systems

E2. Labels



E3. Pre-Printed & Write-On Markers



E4. Permanent Identification



E5. Lockout/Tagout & Safety Solutions

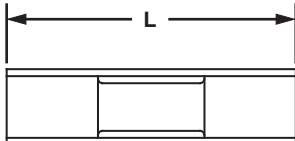

Part Number	Wire Range	Color Code	Max. Ins. (In.)	Figure Dimensions (In.)	Wire Strip Length (In.)	Recommended Installation Tool	Std. Pkg. Qty.**	Std. Ctn. Qty.
				L				
<b>PSN18-C</b>	22 – 18 AWG	Red	0.120	0.75	5/16	CT-100A, CT-1525, CT-2500	100	500
<b>PSN16-C</b>	20 – 16 AWG	Blue	0.150	0.75	5/16		100	500
<b>PSN12-L</b>	14 – 12 AWG	Yellow	0.210	0.83	7/16	CT-100A	50	500

\*\*Bulk packaging may be available, contact Panduit Customer Service for additional information.

For crimping tool information, see pages D1.83, D1.84, and D1.88.

F. Index



## Parallel Splice, Non-Insulated

### Type PS

- Designed to splice two solid or stranded wires together to repair or lengthen wires
- Parallel design results in only one crimp required to complete splice
- Seamless tubular barrel provides a consistent high performance quality crimp

- Non-insulated barrel can be used to provide an economical termination when insulation is not required
- Maximum recommended operating temperature 302°F (150°C)
- UL and CSA rated up to 2000 V per UL 486C



Part Number	Wire Range	Figure Dimensions (In.)		Wire Strip Length (In.)	Recommended Installation Tool	Std. Pkg. Qty.**	Std. Ctn. Qty.
		L					
<b>PS18-C</b>	22 – 18 AWG	0.29		5/16	CT-100A, CT-200	100	500
<b>PS16-C</b>	20 – 16 AWG	0.29		5/16		100	500
<b>PS12-L</b>	14 – 12 AWG	0.38		7/16		50	500

\*\*Bulk packaging may be available, contact Panduit Customer Service for additional information. For crimping tool information, see page D1.83.

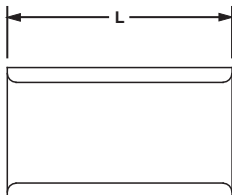

## Wire Joint, Nylon Insulated

### Type JN

- Large barrel, designed to accommodate from one to seven wires with just one crimp
- Accommodates multiple wire sizes in varying combinations
- Barrel of terminal internally beveled to provide quick and easy wire insertion

- UL Flammability UL 94V-2/HB, maximum insulation temperature 221°F (105°C)
- UL and CSA rated up to 600 V per UL 486C



Part Number	Wire Range	Color Code	CMA Range		Figure Dimensions (In.)		Wire Strip Length (In.)	Recommended Installation Tool	Std. Pkg. Qty.**	Std. Ctn. Qty.
			Min.	Max.	L					
<b>JN224-318-C</b>	(2) #24 – (2) #16	Red	808	5160	0.79		7/16	CT-1550‡, CT-1551‡, CT-2500‡	100	1000
<b>JN218-216-C</b>	(2) #22 – (2) #16	Clear	1284	5160	0.78		7/16	CT-1550‡, CT-1551‡, CT-2500‡	100	1000
<b>JN418-212-C</b>	(4) #18 – (2) #12	Clear	6480	14750	0.93		1/2	CT-100A‡, CT-1550‡, CT-1551‡, CT-2500‡	100	1000
<b>JN314-412-C*</b>	(3) #14 – (4) #12	Clear	10320	26120	0.97		5/8	CT-100A, CT-160, CT-260	100	1000

\*Not UL Listed.

\*\*Bulk packaging may be available, contact Panduit Customer Service for additional information.

‡UL and CSA approved tooling/product combinations. For crimping tool information, see pages D1.83, D1.84, and D1.88.

Note: Wire combinations using #24 AWG wire are not UL Listed or CSA Certified.

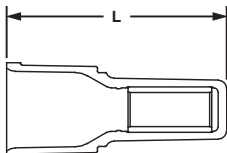

A. System Overview

B1. Cable Ties

B2. Cable Accessories

B3. Stainless Steel Ties

C1. Wiring Duct

C2. Surface Raceway

C3. Abrasion Protection

C4. Cable Management

D1. Terminals

D2. Power Connectors

D3. Grounding Connectors

E1. Labeling Systems

E2. Labels

E3. Pre-Printed & Write-On Markers

E4. Permanent Identification

E5. Lockout/Tagout & Safety Solutions

F. Index

A. System Overview

B1. Cable Ties

B2. Cable Accessories

B3. Stainless Steel Ties

C1. Wiring Duct

C2. Surface Raceway

C3. Abrasion Protection

C4. Cable Management

D1. Terminals

D2. Power Connectors

D3. Grounding Connectors

E1. Labeling Systems

E2. Labels

E3. Pre-Printed & Write-On Markers

E4. Permanent Identification

E5. Lockout/Tagout & Safety Solutions

F. Index



## Wire Joint, Non-Insulated

Type J

- Large barrel, designed to accommodate from one to seven wires with just one crimp
- Accommodates multiple wire sizes in varying combinations
- Non-insulated barrel can be used to provide an economical termination when insulation is not required
- Barrel of terminal internally beveled to provide quick and easy wire insertion
- Maximum recommended operating temperature 302°F (150°C)
- UL and CSA rated up to 2000 V per UL 486C

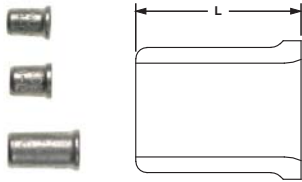

Part Number	Wire Range	CMA Range		Figure Dimensions (In.)	Wire Strip Length (In.)	Recommended Installation Tool	Std. Pkg. Qty.**	Std. Ctn. Qty.
		Min.	Max.	L				
<b>J214-312-T</b>	(2) #14 – (3) #12	5760	19590	0.37	1/2	CT-100A‡, CT-200‡	200	2000
<b>J318-412-T</b>	(3) #18 – (4) #12	4860	27330	0.37	1/2	CT-100A‡, CT-200‡	200	2000
<b>J216-410-L*</b>	(2) #16 – (4) #10	5160	41600	0.62	3/4	CT-100A‡, CT-200‡	50	500

\*Part number J216-410, is not UL Listed or CSA Certified.  
 \*\*Bulk packaging may be available, contact Panduit Customer Service for additional information.  
 ‡UL and CSA approved tooling/product combinations. For crimping tool information, see page D1.83.



## Heat Shrink, Butt Splices

Type BSH

- Designed to splice two solid or stranded wires together to repair or lengthen wires
- Butted configuration provides low profile for limited space applications
- Heat shrink polyolefin sleeve with hot melt adhesive protects against moisture
- After crimping, heat shrink insulation is completed with a standard heat gun
- Minimum continuous operating temperature -65°F (-55°C)
- Maximum continuous operation temperature 230°F (110°C)
- Shrink temperature 300°F (150°C)
- UL and CSA rated up to 600 V per UL 486C

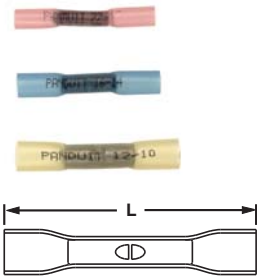

Part Number	Wire Range	Color Code	Max. Ins. (In.)	Figure Dimensions (In.)	Wire Strip Length (In.)	Recommended Installation Tool	Std. Pkg. Qty.**	Std. Ctn. Qty.
				L				
<b>BSH18-Q</b>	22 – 18 AWG	Red	0.170	1.45	5/16	CT-310	25	125
<b>BSH14-Q</b>	16 – 14 AWG	Blue	0.190	1.45	5/16	CT-310	25	125
<b>BSH10-E</b>	12 – 10 AWG	Yellow	0.240	1.64	5/16	CT-310	20	100

\*\*Bulk packaging may be available, contact Panduit Customer Service for additional information.  
 For crimping tool information, see page D1.85.

## Metric Butt Splice, Vinyl Insulated

Type BSMV

- Expanded wire entry designed to accommodate wire with a larger insulation thickness
- Designed to splice two solid or stranded wires together to repair or lengthen wires
- Brazed seam protects terminal barrel from splitting during the crimp process
- Internal wire stop assures proper length of insertion into terminal barrel
- Maximum insulation temperature 221°F (105°C)
- Rated up to 600 V

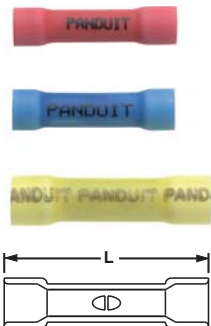

Part Number	Wire Range (mm²)	Color Code	Max Ins. (mm)	Figure Dimensions (mm)	Recommended Installation Tool	Std. Pkg. Qty.**	Std. Ctn. Qty.
				L			
<b>BSMV1BX-LY^</b>	0.5 – 1.0	Red	4.3	26.4	CT-1551	50	500
<b>BSMV2BX-L^</b>	1.5 – 2.5	Blue	5.1	26.4	CT-1551	50	500
<b>BSMV6X-Q*</b>	4.0 – 6.0	Yellow	6.4	30.0	CT-1551	25	250

\*Brazed seam.  
 \*\*Bulk packaging may be available, contact Panduit Customer Service for additional information.  
 ^Butted seam.  
 For crimping tool information, see page D1.84.

## Metric Butt Splice, Non-Insulated

### Type BSM

- Designed to splice two solid or stranded wires together to repair or lengthen wires
- Butted configuration provides low profile for limited space applications
- Brazed seam protects terminal barrel from splitting during the crimp process
- Internal wire stop assures proper length of insertion into terminal barrel
- Non-insulated barrel can be used to provide an economical termination when insulation is not required
- Maximum recommended operating temperature 302°F (150°C)
- Rated up to 2000 V



Part Number	Wire Range (mm <sup>2</sup> )	Figure Dimensions (mm)	Recommended Installation Tool	Std. Pkg. Qty.	Std. Ctn. Qty.
		L			
BSM1-C	0.5 – 1.0	15.7	CT-1570, CT-2500	100	500
BSM2-C	1.5 – 2.5	15.7		100	500
BSM6-L	4.0 – 6.0	18.2		50	250

For crimping tool information, see pages D1.84 and D1.88.

## Metric Wire Joints, Nylon Insulated

### Type JMN

- Large barrel, designed to accommodate from one to seven wires with just one crimp
- Accommodates multiple wire sizes in varying combinations
- Barrel of terminal internally beveled to provide quick and easy wire insertion
- Maximum insulation temperature 221°F (105°C)
- Rated up to 600 V



Part Number	Wire Range (mm <sup>2</sup> )	Color Code	CMA Range Min.	CMA Range Max.	Figure Dimensions (mm)	Recommended Installation Tool	Std. Pkg. Qty.	Std. Ctn. Qty.
					L			
JMN2-C	0.5 – 2.5	Clear	1284	5160	19.9	CT-1551	100	500
JMN6-C	0.75 – 6.0	Clear	6480	14750	23.9	CT-1551	100	500

For crimping tool information, see page D1.84.

A.  
System  
Overview

B1.  
Cable Ties

B2.  
Cable  
Accessories

B3.  
Stainless  
Steel Ties

C1.  
Wiring  
Duct

C2.  
Surface  
Raceway

C3.  
Abrasion  
Protection

C4.  
Cable  
Management

D1.  
Terminals

D2.  
Power  
Connectors

D3.  
Grounding  
Connectors

E1.  
Labeling  
Systems

E2.  
Labels

E3.  
Pre-Printed  
& Write-On  
Markers

E4.  
Permanent  
Identification

E5.  
Lockout/  
Tagout  
& Safety  
Solutions

F.  
Index

A. System Overview

B1. Cable Ties

B2. Cable Accessories

B3. Stainless Steel Ties

C1. Wiring Duct

C2. Surface Raceway

C3. Abrasion Protection

C4. Cable Management

D1. Terminals

D2. Power Connectors

D3. Grounding Connectors

E1. Labeling Systems

E2. Labels

E3. Pre-Printed & Write-On Markers

E4. Permanent Identification

E5. Lockout/Tagout & Safety Solutions

F. Index

## PAN-TERM® FERRULES

Panduit® Pan-Term® Ferrule end sleeves terminate stranded wire into terminal blocks with superior termination performance. A wide assortment of ferrule styles and tool designs provide a proven way to make reliable connections, especially for limited space applications. Insulation flare allows for ease of wire insertion and eliminates loose strands of wire. Encapsulated crimp contains loose wires to eliminate stray wire breakage.



- Ideal for control panel and terminal block applications
- Insulated single wire range of #26 – 1 AWG, sizes meets French and DIN color code standards
- Insulated twin wire end sleeve range of #22 – 10 AWG, sizes meets DIN color code standard
- Non-insulated wire range of #24 – 1 AWG
- Insulated ferrules single wire range #20 – 14 AWG, available in strips of 50 for use with the semiautomatic ferrule crimping tool, CT-1000, for improved reliability and productivity
- Wide assortment of controlled cycle, crimping tools for reliable connections at the lowest installed cost



Panduit continually provides new designs to meet the application challenges encountered by our customers. Panduit offers a wide assortment of Pan-Term® termination products to meet customer needs at the lowest installed cost.

## Features and Benefits – Pan-Term® Ferrules

Panduit ferrules are available for wiring applications from #26 – 1 AWG. Offerings include insulated and non-insulated ferrules, in single-wire or double-wire configurations. Insulated ferrules are color-coded to DIN or French standards. Crimped on the metal barrel these ferrules provide improved performance for terminal block and panel building applications.

<p><b>Insulated Ferrules – Single Wire</b> <b>Type FSF and FSD</b></p>	<p><b>Insulated Ferrules – Twin Wire</b> <b>Type FTD</b></p>
--	--

### Non-Insulated Ferrules

#### Type F



Panduit provides a wide assortment of crimping tools for reliable connections at the lowest installed cost.

See page D1.85.



Panduit designs and manufactures a full line of labeling products, software, and printers to assist you with your labeling requirements.

See pages E1.1 – E2.28.

A.  
System  
Overview

B1.  
Cable Ties

B2.  
Cable  
Accessories

B3.  
Stainless  
Steel Ties

C1.  
Wiring  
Duct

C2.  
Surface  
Raceway

C3.  
Abrasion  
Protection

C4.  
Cable  
Management

D1.  
Terminals

D2.  
Power  
Connectors

D3.  
Grounding  
Connectors

E1.  
Labeling  
Systems

E2.  
Labels

E3.  
Pre-Printed  
& Write-On  
Markers

E4.  
Permanent  
Identification

E5.  
Lockout/  
Tagout  
& Safety  
Solutions

F.  
Index

A. System Overview

## Selection Guide – Pan-Term® Ferrules

B1. Cable Ties

B2. Cable Accessories

B3. Stainless Steel Ties

C1. Wiring Duct

C2. Surface Raceway

C3. Abrasion Protection

C4. Cable Management

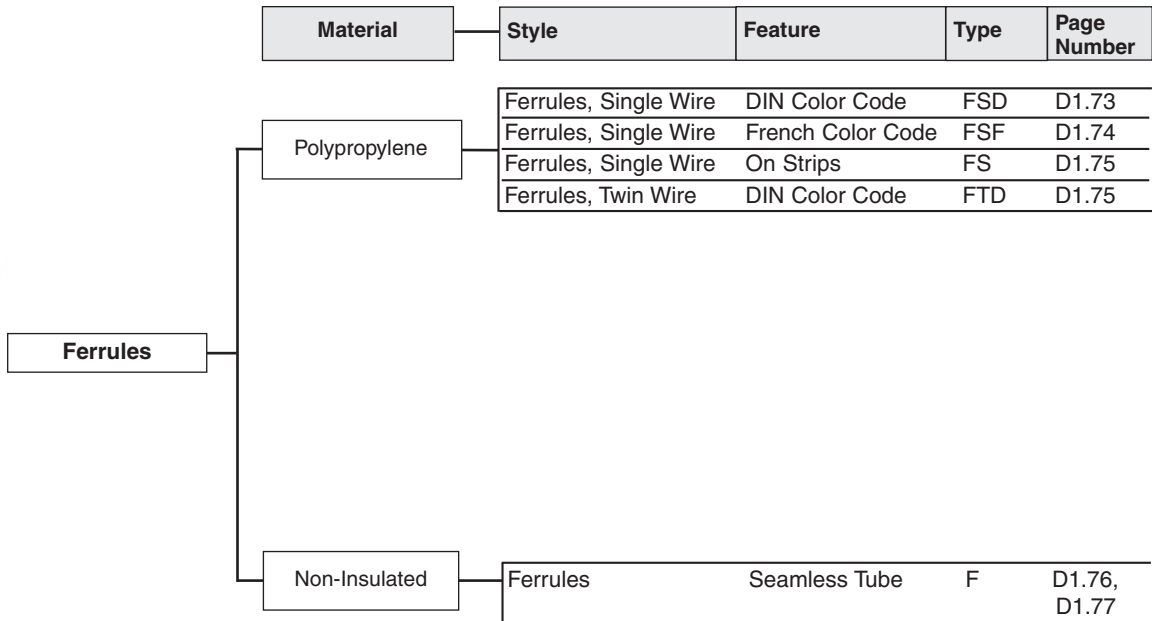

D1. Terminals

## Part Number System for Pan-Term® Ferrules

D2. Power Connectors

D3. Grounding Connectors

**F**

**S**

**D**

**72**

**8**

Type

Wire Type

Color Code

Wire Size

DIN/French Length

F = Ferrule

S = Single

D = DIN

T = Twin

F = French

Blank = Non-Insulated

E2. Labels

E3. Pre-Printed & Write-On Markers

E4. Permanent Identification

E5. Lockout/Tagout & Safety Solutions

F. Index





## Insulated Ferrules – Single Wire DIN End Sleeve

### Type FSD

- Polypropylene insulation housing conforms to DIN color requirements
- Meets DIN standards for single wire containment
- Funnel entry for faster insertion and lower installed cost
- Designed with a seamless barrel to contain loose wire strands for superior terminations
- Eases insertion of wire into terminal block
- Suitable for limited space panel applications
- Multiple pin lengths available for a variety of terminal blocks

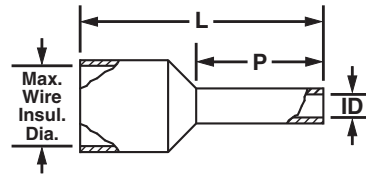

Part Number	Wire Size		Color Code	Max. Wire Insul. Dia.		Figure Dimensions						Wire Strip Length		Recommended Installation Tool	Std. Pkg. Qty.
	AWG	mm <sup>2</sup>		In.	mm	L		P		ID		In.	mm		
FSD72-6-D	26 AWG	0.14	Gray	0.07	2.0	0.41	10.5	0.24	6.0	0.03	0.8	3/8	9.5	CT-1002, CT-1123	500
FSD72-8-D				0.07	2.0	0.49	12.5	0.31	8.0	0.03	0.8	15/32	11.9		500
FSD73-6-D	24 AWG	0.25	Yellow	0.07	2.0	0.41	10.5	0.24	6.0	0.03	0.8	3/8	9.5	CT-1002, CT-1123	500
FSD73-8-D				0.07	2.0	0.49	12.5	0.31	8.0	0.03	0.8	15/32	11.9		500
FSD74-6-D	24 AWG	0.34	Turquoise	0.07	2.0	0.41	10.5	0.24	6.0	0.03	0.8	3/8	9.5	CT-1002, CT-1123	500
FSD74-8-D				0.07	2.0	0.49	12.5	0.31	8.0	0.03	0.8	15/32	11.9		500
FSD75-6-D	22 AWG	0.5	White	0.09	2.5	0.45	11.5	0.24	6.0	0.04	1.1	3/8	9.5	CT-1002, CT-1123	500
FSD75-8-D				0.09	2.5	0.53	13.5	0.31	8.0	0.04	1.1	15/32	11.9		500
FSD75-10-D				0.09	2.5	0.61	15.5	0.39	10.0	0.04	1.1	17/32	13.5		500
FSD76-6-D	20 AWG	0.75	Gray	0.11	2.8	0.47	12.0	0.24	6.0	0.05	1.3	3/8	9.5	CT-1002, CT-1123	500
FSD76-8-D				0.11	2.8	0.55	14.0	0.31	8.0	0.05	1.3	15/32	11.9		500
FSD76-10-D				0.11	2.8	0.63	16.0	0.39	10.0	0.05	1.3	17/32	13.5		500
FSD76-12-D	20 AWG	0.75	Gray	0.11	2.8	0.71	18.0	0.47	12.0	0.05	1.3	5/8	15.9	CT-1002, CT-1003, CT-1123	500
FSD77-6-D				0.12	3.0	0.49	12.5	0.24	6.0	0.06	1.5	3/8	9.5		500
FSD77-8-D				0.12	3.0	0.57	14.5	0.31	8.0	0.06	1.5	15/32	11.9		500
FSD77-10-D	18 AWG	1.0	Red	0.12	3.0	0.65	16.5	0.39	10.0	0.06	1.5	17/32	13.5	CT-1002, CT-1003, CT-1123	500
FSD77-12-D				0.12	3.0	0.73	18.5	0.47	12.0	0.06	1.5	5/8	15.9		500
FSD78-6-D	16 AWG	1.5	Black	0.12	3.0	0.49	12.5	0.24	6.0	0.07	1.8	3/8	9.5	CT-1002, CT-1003, CT-1123	500
FSD78-8-D				0.12	3.0	0.57	14.5	0.31	8.0	0.07	1.8	15/32	11.9		500
FSD78-10-D				0.12	3.0	0.65	16.5	0.39	10.0	0.07	1.8	17/32	13.5		500
FSD78-12-D				0.12	3.0	0.73	18.5	0.47	12.0	0.07	1.8	5/8	15.9		500
FSD78-18-D				0.12	3.0	0.96	24.5	0.71	18.0	0.07	1.8	7/8	22.2		500
FSD79-8-D	14 AWG	2.08	Yellow	0.14	3.6	0.57	14.5	0.31	8.0	0.08	2.1	15/32	11.9	CT-1003, CT-1004, CT-1123, CT-1104	500
FSD80-8-D				0.17	4.2	0.59	15.0	0.31	8.0	0.09	2.3	15/32	11.9		500
FSD80-12-D	14 AWG	2.5	Blue	0.17	4.2	0.75	19.0	0.47	12.0	0.09	2.3	5/8	15.9	CT-1003, CT-1004, CT-1123, CT-1104	500
FSD80-18-D				0.17	4.2	0.98	25.0	0.71	18.0	0.09	2.3	7/8	22.2		500
FSD81-10-D	12 AWG	4.0	Gray	0.19	4.8	0.69	17.5	0.39	10.0	0.11	2.9	17/32	13.5	CT-1003, CT-1004, CT-1123, CT-1104	500
FSD81-12-C				0.19	4.8	0.79	20.0	0.47	12.0	0.11	2.9	5/8	15.9		100
FSD81-18-C				0.19	4.8	1.02	26.0	0.71	18.0	0.11	2.9	7/8	22.2		100
FSD82-12-C	10 AWG	6.0	Yellow	0.24	6.2	0.79	20.0	0.47	12.0	0.14	3.6	5/8	15.9	CT-1003, CT-1004, CT-1123, CT-1104	100
FSD82-18-C				0.24	6.2	1.02	26.0	0.71	18.0	0.14	3.6	7/8	22.2		100
FSD83-12-C	8 AWG	10.0	Red	0.30	7.5	0.83	21.0	0.47	12.0	0.18	4.6	5/8	15.9	CT-1003, CT-1004, CT-1123, CT-1104	100
FSD83-18-C				0.30	7.5	1.06	27.0	0.71	18.0	0.18	4.6	7/8	22.2		100
FSD84-12-C	6 AWG	16.0	Blue	0.35	8.8	0.91	23.0	0.47	12.0	0.24	6.0	5/8	15.9	CT-1004, CT-1104	100
FSD84-18-C				0.35	8.8	1.14	29.0	0.71	18.0	0.24	6.0	7/8	22.2		100
FSD85-16-L	4 AWG	25.0	Yellow	0.43	11.0	1.14	29.0	0.63	16.0	0.30	7.5	3/4	19.1	CT-1005	50
FSD85-18-L				0.43	11.0	1.22	31.0	0.71	18.0	0.30	7.5	7/8	22.2		50
FSD85-22-L				0.43	11.0	1.38	35.0	0.87	22.0	0.30	7.5	1	25.4		50
FSD86-16-L	2 AWG	35.0	Red	0.49	12.5	1.18	30.0	0.63	16.0	0.33	8.5	3/4	19.1	CT-1006	50
FSD86-18-L				0.49	12.5	1.26	32.0	0.71	18.0	0.33	8.5	7/8	22.2		50
FSD86-25-L				0.49	12.5	1.54	39.0	0.98	25.0	0.33	8.5	1 1/8	28.6		50
FSD87-20-L	1 AWG	50.0	Blue	0.59	15.0	1.42	36.0	0.79	20.0	0.41	10.5	15/16	23.8	CT-1006	50
FSD87-25-Q				0.59	15.0	1.61	41.0	0.98	25.0	0.41	10.5	1 1/8	28.6		25

For crimping tool information, see page D1.85

A. System Overview

B1. Cable Ties

B2. Cable Accessories

B3. Stainless Steel Ties

C1. Wiring Duct

C2. Surface Raceway

C3. Abrasion Protection

C4. Cable Management

D1. Terminals

D2. Power Connectors

D3. Grounding Connectors

E1. Labeling Systems

E2. Labels

E3. Pre-Printed & Write-On Markers

E4. Permanent Identification

E5. Lockout/Tagout & Safety Solutions

F. Index





## Insulated Ferrules – Twin Wire DIN End Sleeve

### Type FTD

- Meets DIN standards for twin wire containment
- Polypropylene insulation housing conforms to DIN color requirements
- Funnel entry for faster insertion and lower installed cost
- Designed with a seamless barrel to contain loose wire strands for superior terminations



- Eases insertion of wire into terminal block
- Suitable for limited space panel applications
- Multiple pin lengths available for a variety of terminal blocks

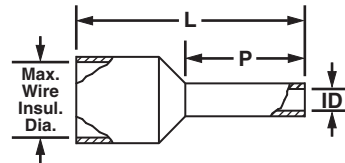

Part Number	Wire Size		Color	Max. Wire Insul. Dia.		Figure Dimensions						Wire Strip Length		Recommended Installation Tool	Std. Pkg. Qty.
	AWG	mm'		In.	mm	L		P		ID		In.	mm		
<b>FTD75-8-D</b>	22 AWG	0.5	White	0.87	2.2	0.59	15.0	0.31	8.0	0.06	1.5	7/16	11.2	CT-1002, CT-1003, CT-1123	500
<b>FTD76-8-D</b>	20 AWG	0.75	Gray	0.09	2.4	0.59	15.0	0.31	8.0	0.07	1.8	7/16	11.2		500
<b>FTD76-10-D</b>				0.09	2.4	0.67	17.0	0.39	10.0	0.07	1.8	9/16	14.0		500
<b>FTD77-8-D</b>	18 AWG	1.0	Red	0.11	2.7	0.59	15.0	0.31	8.0	0.08	2.1	7/16	11.2		500
<b>FTD77-10-D</b>				0.11	2.7	0.67	17.0	0.39	10.0	0.08	2.1	9/16	14.0		500
<b>FTD78-8-D</b>	16 AWG	1.5	Black	0.12	3.0	0.63	16.0	0.31	8.0	0.09	2.3	7/16	11.2		500
<b>FTD78-12-D</b>				0.12	3.0	0.79	20.0	0.47	12.0	0.09	2.3	21/32	16.8		500
<b>FTD80-10-TL</b>	14 AWG	2.5	Blue	0.15	3.7	0.73	18.5	0.39	10.0	0.11	2.9	9/16	14.0		250
<b>FTD80-13-TL</b>				0.15	3.7	0.85	21.5	0.51	13.0	0.11	2.9	23/32	16.2		250
<b>FTD81-12-C</b>	12 AWG	4.0	Gray	0.17	4.3	0.91	23.0	0.47	12.0	0.15	3.8	21/32	16.8		100
<b>FTD82-14-C</b>	10 AWG	6.0	Yellow	0.19	4.8	0.98	25.0	0.55	14.0	0.18	4.6	25/32	19.6	CT-1003, CT-1004, CT-1104	100

For crimping tool information, see page D1.85.



## Insulated Ferrules on Strips – Single Wire

### Type FS

- Polypropylene insulation housing available in DIN standard colors in strips of 50
- Continuously molded design provides consistent placement of ferrules in tool to ensure fast, reliable terminations

- Available in #20 – 14 AWG featuring a seamless barrel design to contain loose wire strands for superior terminations
- Designed for use with the Semiautomatic Ferrule Crimping Tool CT-1000 for medium volume applications

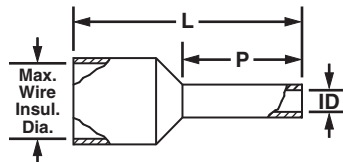
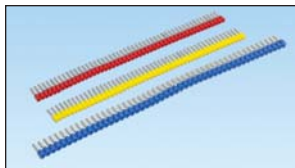

Part Number	Wire Size		Color	Max. Wire Insul. Dia.		Figure Dimensions						Wire Strip Length		Recommended Installation Tool	Std. Pkg. Qty.
	AWG	mm2		In.	mm	L		P		ID		In.	mm		
<b>FSD75-8-DSL10</b>	20 AWG	0.50	White	0.10	2.6	0.60	15.2	0.31	8.0	0.04	1.0	13/32	10.0	CT-1000	500
<b>FSD76-8-DSL8</b>	18 AWG	0.75	Gray	0.11	2.7	0.60	15.2	0.31	8.0	0.06	1.5	13/32	10.0		500
<b>FSD77-8-DSL2</b>		1.00	Red	0.12	3.0	0.60	15.2	0.31	8.0	0.07	1.8	13/32	10.0		500
<b>FSD78-8-DSL0</b>	16 AWG	1.50	Black	0.13	3.2	0.60	15.2	0.31	8.0	0.09	2.3	13/32	10.0		500
<b>FSD80-8-DSL6</b>	14 AWG	2.50	Blue	0.16	4.0	0.60	15.2	0.31	8.0	0.09	2.3	13/32	10.0		500

### Additional Colored End Sleeves

<b>FS75-8-DSL3</b>	20 AWG	0.50	Orange	0.10	2.6	0.60	15.2	0.31	8.0	0.04	1.0	13/32	10.0	CT-1000	500
<b>FS76-8-DSL10</b>	18 AWG	0.75	White	0.11	2.7	0.60	15.2	0.31	8.0	0.05	1.2	13/32	10.0		500
<b>FS76-8-DSL7</b>			Light Blue	0.11	2.7	0.60	15.2	0.31	8.0	0.05	1.2	13/32	10.0		500
<b>FS77-8-DSL4</b>			1.00	Yellow	0.12	3.0	0.60	15.2	0.31	8.0	0.06	1.5	13/32		10.0
<b>FS78-8-DSL2</b>	16 AWG	1.50	Red	0.13	3.2	0.60	15.2	0.31	8.0	0.07	1.8	13/32	10.0		500
<b>FS80-8-DSL8</b>	14 AWG	2.50	Gray	0.16	4.0	0.60	15.2	0.31	8.0	0.09	2.3	13/32	10.0		500

For crimping tool information, see page D1.86.

A. System Overview

B1. Cable Ties

B2. Cable Accessories

B3. Stainless Steel Ties

C1. Wiring Duct

C2. Surface Raceway

C3. Abrasion Protection

C4. Cable Management

D1. Terminals

D2. Power Connectors

D3. Grounding Connectors

E1. Labeling Systems

E2. Labels

E3. Pre-Printed & Write-On Markers

E4. Permanent Identification

E5. Lockout/Tagout & Safety Solutions

F. Index

A. System Overview

## Ferrules, Non-Insulated

B1. Cable Ties

### Type F

B2. Cable Accessories

- Designed with a seamless barrel to contain loose wire strands for superior terminations
- Eases insertion of wire into terminal block
- Meets DIN standards for wire containment
- Suitable for limited space panel applications
- Multiple pin lengths available for a variety of terminal blocks

B3. Stainless Steel Ties

C1. Wiring Duct

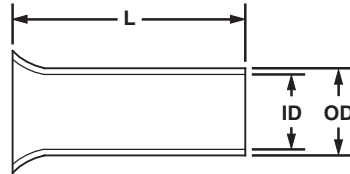

C2. Surface Raceway

C3. Abrasion Protection

C4. Cable Management

D1. Terminals

D2. Power Connectors

D3. Grounding Connectors

E1. Labeling Systems

E2. Labels

E3. Pre-Printed & Write-On Markers

E4. Permanent Identification

E5. Lockout/Tagout & Safety Solutions

F. Index

Part Number	Wire Size		Figure Dimensions						Wire Strip Length		Recommended Installation Tool	Std. Pkg. Qty.
			L		ID		OD					
	AWG	mm <sup>2</sup>	In.	mm	In.	mm	In.	mm	In.	mm		
<b>F73-5-M</b>	24 AWG	0.25	0.20	5.0	0.03	0.80	0.04	1.1	7/32	5.0	CT-1002, CT-1003	1000
<b>F73-7-M</b>			0.28	7.0	0.03	0.80	0.04	1.1	9/32	7.0		1000
<b>F74-5-M</b>		0.34	0.20	5.0	0.04	0.90	0.05	1.2	7/32	5.0		1000
<b>F74-7-M</b>			0.28	7.0	0.04	0.90	0.05	1.2	9/32	7.0		1000
<b>F75-6-M</b>	22 AWG	0.50	0.24	6.0	0.04	1.0	0.05	1.3	1/4	6.0	CT-1002, CT-1003, CT-1123	1000
<b>F75-8-M</b>			0.31	8.0	0.04	1.0	0.05	1.3	5/16	8.0		1000
<b>F75-10-M</b>	20 AWG	0.75	0.39	10.0	0.04	1.0	0.05	1.3	13/32	10.0	CT-1002, CT-1003, CT-1123	1000
<b>F76-6-M</b>			0.24	6.0	0.05	1.2	0.06	1.5	1/4	6.0		1000
<b>F76-8-M</b>			0.31	8.0	0.05	1.2	0.06	1.5	5/16	8.0		1000
<b>F76-10-M</b>			0.39	10.0	0.05	1.2	0.06	1.5	13/32	10.0		1000
<b>F76-12-M</b>	18 AWG	1.0	0.47	12.0	0.05	1.2	0.06	1.5	15/32	12.0	CT-1002, CT-1003, CT-1123	1000
<b>F77-6-M</b>			0.24	6.0	0.06	1.4	0.07	1.7	1/4	6.0		1000
<b>F77-7-M</b>			0.28	7.0	0.06	1.4	0.07	1.7	9/32	7.0		1000
<b>F77-8-M</b>			0.31	8.0	0.06	1.4	0.07	1.7	5/16	8.0		1000
<b>F77-10-M</b>	16 AWG	1.5	0.39	10.0	0.06	1.4	0.07	1.7	13/32	10.0	CT-1002, CT-1003, CT-1123	1000
<b>F77-12-M</b>			0.47	12.0	0.06	1.4	0.07	1.7	15/32	12.0		1000
<b>F78-7-M</b>			0.28	7.0	0.07	1.7	0.08	2.0	9/32	7.0		1000
<b>F78-8-M</b>			0.31	8.0	0.07	1.7	0.08	2.0	5/16	8.0		1000
<b>F78-10-M</b>	1.5	0.39	10.0	0.07	1.7	0.08	2.0	13/32	10.0	CT-1002, CT-1003, CT-1123	1000	
<b>F78-12-M</b>		0.47	12.0	0.07	1.7	0.08	2.0	15/32	12.0		1000	
<b>F78-15-M</b>		0.59	15.0	0.07	1.7	0.08	2.0	19/32	15.0		1000	
<b>F78-18-M</b>	1.5	0.71	18.0	0.07	1.7	0.08	2.0	23/32	18.0	CT-1002, CT-1003, CT-1123	1000	
<b>F78-20-M</b>		0.79	20.0	0.07	1.7	0.08	2.0	25/32	20.0		1000	

For crimping tool information, see page D1.85.

## Ferrules, Non-Insulated (continued)

### Type F

Part Number	Wire Size		Figure Dimensions						Wire Strip Length		Recommended Installation Tool	Std. Pkg. Qty.
			L		ID		OD					
	In.	mm	In.	mm	In.	mm	In.	mm				
F80-7-M	14 AWG	2.5	0.28	7.0	0.09	2.2	0.10	2.5	9/32	7.0	CT-1002, CT-1003, CT-1123	1000
F80-8-M			0.31	8.0	0.09	2.2	0.10	2.5	5/16	8.0		1000
F80-10-M			0.39	10.0	0.09	2.2	0.10	2.5	13/32	10.0		1000
F80-12-M			0.47	12.0	0.09	2.2	0.10	2.5	15/32	12.0		1000
F80-15-M			0.59	15.0	0.09	2.2	0.10	2.5	19/32	15.0		1000
F80-18-M			0.71	18.0	0.09	2.2	0.10	2.5	23/32	18.0		1000
F80-20-M			0.79	20.0	0.09	2.2	0.10	2.5	25/32	20.0		1000
F81-9-M			12 AWG	4.0	0.35	9.0	0.11	2.8	0.13	3.2		11/32
F81-10-M	0.39	10.0			0.11	2.8	0.13	3.2	13/32	10.0	1000	
F81-12-M	0.47	12.0			0.11	2.8	0.13	3.2	15/32	12.0	1000	
F81-15-M	0.59	15.0			0.11	2.8	0.13	3.2	19/32	15.0	1000	
F81-18-M	0.71	18.0			0.11	2.8	0.13	3.2	23/32	18.0	1000	
F81-20-M	0.79	20.0			0.11	2.8	0.13	3.2	25/32	20.0	1000	
F82-10-M	10 AWG	6.0	0.39	10.0	0.14	3.5	0.15	3.9	13/32	10.0	CT-1002, CT-1003, CT-1123	1000
F82-12-M			0.47	12.0	0.14	3.5	0.15	3.9	15/32	12.0		1000
F82-15-M			0.59	15.0	0.14	3.5	0.15	3.9	19/32	15.0		1000
F82-18-M			0.71	18.0	0.14	3.5	0.15	3.9	23/32	18.0		1000
F82-20-M			0.79	20.0	0.14	3.5	0.15	3.9	25/32	20.0		1000
F83-12-D	8 AWG	10.0	0.47	12.0	0.18	4.5	0.19	4.9	15/32	12.0	CT-1003, CT-1004, CT-1123	500
F83-15-D			0.59	15.0	0.18	4.5	0.19	4.9	19/32	15.0		500
F83-18-D			0.71	18.0	0.18	4.5	0.19	4.9	23/32	18.0		500
F83-20-D			0.79	20.0	0.18	4.5	0.19	4.9	25/32	20.0		500
F83-25-D			0.98	25.0	0.18	4.5	0.19	4.9	31/32	25.0		500
F84-12-TL	6 AWG	16.0	0.47	12.0	0.23	5.8	0.24	6.2	15/32	12.0	CT-1004	250
F84-15-TL			0.59	15.0	0.23	5.8	0.24	6.2	19/32	15.0		250
F84-18-TL			0.71	18.0	0.23	5.8	0.24	6.2	23/32	18.0		250
F84-20-TL			0.79	20.0	0.23	5.8	0.24	6.2	25/32	20.0		250
F84-25-TL			0.98	25.0	0.23	5.8	0.24	6.2	31/32	25.0		250
F84-32-TL			1.26	32.0	0.23	5.8	0.24	6.2	1 1/4	32.0		250
F85-12-C			4 AWG	25.0	0.47	12.0	0.29	7.3	0.30	7.7		15/32
F85-15-C	0.59	15.0			0.29	7.3	0.30	7.7	19/32	15.0	100	
F85-18-C	0.71	18.0			0.29	7.3	0.30	7.7	23/32	18.0	100	
F85-25-C	0.98	25.0			0.29	7.3	0.30	7.7	31/32	25.0	100	
F85-32-C	1.26	32.0			0.29	7.3	0.30	7.7	1 1/4	32.0	100	
F86-18-C	0.71	18.0			0.33	8.3	0.34	8.7	23/32	18.0	100	
F86-20-C	2 AWG	35.0	0.79	20.0	0.33	8.3	0.34	8.7	25/32	20.0	CT-1006	100
F86-25-C			0.98	25.0	0.33	8.3	0.34	8.7	31/32	25.0		100
F86-32-C			1.26	32.0	0.33	8.3	0.34	8.7	1 1/4	32.0		100
F87-18-C	1 AWG	50.0	0.71	18.0	0.41	10.3	0.43	10.9	23/32	18.0	CT-1006	100
F87-22-C			0.87	22.0	0.41	10.3	0.43	10.9	7/8	22.0		100
F87-25-C			0.98	25.0	0.41	10.3	0.43	10.9	31/32	25.0		100
F87-32-C			1.26	32.0	0.41	10.3	0.43	10.9	1 1/4	32.0		100

For crimping tool information, see page D1.85.

A.  
System  
Overview

B1.  
Cable Ties

B2.  
Cable  
Accessories

B3.  
Stainless  
Steel Ties

C1.  
Wiring  
Duct

C2.  
Surface  
Raceway

C3.  
Abrasion  
Protection

C4.  
Cable  
Management

D1.  
Terminals

D2.  
Power  
Connectors

D3.  
Grounding  
Connectors

E1.  
Labeling  
Systems

E2.  
Labels

E3.  
Pre-Printed  
& Write-On  
Markers

E4.  
Permanent  
Identification

E5.  
Lockout/  
Tagout  
& Safety  
Solutions

F.  
Index

A.  
System  
Overview

## Ferrule Assortment Kits

B1.  
Cable Ties

- Large selection of ferrules in a convenient compact case
- Plastic case is both durable and reusable keeping ferrules organized and separated

B2.  
Cable  
Accessories



KP-FSD1, KP-FSD2,  
and KP-FSD3

B3.  
Stainless  
Steel Ties

C1.  
Wiring  
Duct

C2.  
Surface  
Raceway



KP-F1 and KP-F2

C3.  
Abrasion  
Protection

C4.  
Cable  
Management

Part Number	Part Description	Std. Pkg. Qty.
KP-FSD1	Ferrule kit includes: #24 – 18 AWG insulated DIN ferrules. Case includes: 30 pieces each of FSD73-6, FSD74-6, FSD75-8, FSD76-8 and FSD77-8.	1
KP-FSD2	Ferrule kit includes: #22 – 14 AWG insulated DIN ferrules. Case includes: 100 pieces each of FSD76-8, FSD77-8, FSD78-8 50 pieces each of FSD75-8 and FSD80-8.	1
KP-FSD3	Ferrule kit includes: #12 – 6 AWG insulated DIN ferrules. Case includes: 50 pieces of FSD81-10 20 pieces each of FSD82-12 and FSD83-12 10 pieces of FSD84-12.	1
KP-F1	Ferrule kit includes: #22 – 14 AWG non-insulated ferrules. Case includes: 500 pieces of F75-6 400 pieces each of F76-6 and F77-6 300 pieces of F78-7 200 pieces of F80-7.	1
KP-F2	Ferrule kit includes: #12 – 6 AWG non-insulated ferrules. Case includes: 150 pieces of F81-9 100 pieces of F82-10 80 pieces of F83-12 40 pieces of F84-12.	1

Ferrule kits do not include crimping tool.

D1.  
Terminals

D2.  
Power  
Connectors

D3.  
Grounding  
Connectors

E1.  
Labeling  
Systems

E2.  
Labels

E3.  
Pre-Printed  
& Write-On  
Markers

E4.  
Permanent  
Identification

E5.  
Lockout/  
Tagout  
& Safety  
Solutions

F.  
Index

## TERMINAL CRIMPING TOOLS

Panduit offers a wide assortment of tools to provide solutions for installing terminals, disconnects, splices, ferrules and lugs. Panduit installation tools provide quality performance and ease of installation at the lowest installed cost. The long-term reliability of Panduit installation tools provides the highest level of service to meet customer requirements.



- Ergonomic design to minimize operator effort
- Features crimping tools with a controlled cycle mechanism ensuring repeat reliability in every crimp
- Superior locator ensures proper location of the terminal barrel or insulated disconnect in the crimp pocket
- Battery powered, hydraulic tools with fingertip operation are available to meet a variety of installation needs
- UL Listed and CSA Certified tooling/product combinations, as noted

Panduit terminal crimping tools are available in an assortment of styles to meet a variety of installation needs. The installer can control the crimp with the plier type hand operated crimping tool. Hand operated Contour Crimp™ Controlled Cycle Crimping Tools feature ergonomically designed cushioned grips with low handle effort. Panduit terminal crimping tools are designed for use with Panduit terminals, providing the right solution for your termination needs.

A.  
System  
Overview

B1.  
Cable Ties

B2.  
Cable  
Accessories

B3.  
Stainless  
Steel Ties

C1.  
Wiring  
Duct

C2.  
Surface  
Raceway

C3.  
Abrasion  
Protection

C4.  
Cable  
Management

D1.  
Terminals

D2.  
Power  
Connectors

D3.  
Grounding  
Connectors

E1.  
Labeling  
Systems

E2.  
Labels

E3.  
Pre-Printed  
& Write-On  
Markers

E4.  
Permanent  
Identification

E5.  
Lockout/  
Tagout  
& Safety  
Solutions

F.  
Index

A. System Overview

B1. Cable Ties

B2. Cable Accessories

B3. Stainless Steel Ties

C1. Wiring Duct

C2. Surface Raceway

C3. Abrasion Protection

C4. Cable Management

D1. Terminals

D2. Power Connectors

D3. Grounding Connectors

E1. Labeling Systems

E2. Labels

E3. Pre-Printed & Write-On Markers

E4. Permanent Identification

E5. Lockout/Tagout & Safety Solutions

F. Index

## Crimping Guidelines for Panduit® Pan-Term® Terminals, Disconnects, Splices and Wire Joints

### 1. Select the proper Panduit terminal for the application and wire size used

- Ring terminals are used for high vibration and grounding applications
- Fork terminals are used for static (non-vibration) applications
- Disconnects are used for applications that require quick connection of wires without the use of tools
- Splices and wire joints are used to join wires together



### 2. Strip wire to the proper length as specified on:

- Panduit product packaging label
- Packaging instructions included with the Panduit product
- Or if no packaging instructions are available, plan your strip length so that 1/32" of wire can be seen protruding through the tongue end of the terminal barrel

### 3. Select the proper crimp tool to be used

- Use crimping tools that provide a UL Listed and/or CSA Certified electrical termination, to assure a safe and reliable connection
- Panduit terminals are UL Listed and CSA Certified when crimped with Panduit plier type crimping tool or with the preferred Contour Crimp™ Controlled Cycle Crimping Tool specified on the packaging label



Plier Type Crimping Tool



Contour Crimp™ Controlled Cycle Crimping Tool

### 4. Select the proper crimp pocket for the terminals and wire size you are using

- Panduit crimping tools simplify this process with color-coded crimp pockets. The yellow, blue, and red pockets are specifically designed for the industry standard barrel sizes, each with a specific color code.



### 5. Perform the electrical crimp for the plier type tool Insulated Terminals and Disconnects

- Locate terminal in appropriate size color-coded crimp die pocket with tool centered on insulation sleeve. (See Note 1, page D1.82)
- Rotate terminal so tongue is level with crimp die.
- Insert properly stripped wire into terminal until a minimum of 1/32" of wire extends beyond the terminal barrel.
- Squeeze tool handles firmly to perform the electrical crimp. (See Note 2, page D1.82)
- Provide second crimp on the flared portion of the insulation housing to close the insulation as shown. Caution: When using plier type crimping tools, do not squeeze as firmly as you did for the electrical crimp. (See Note 3, page D1.82)



Step A



Step B

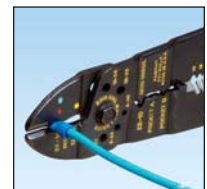

Steps C and D



Step E



Complete Crimp



## Crimping Guidelines for Panduit® Pan-Term® Terminals, Disconnects, Splices and Wire Joints (continued)

### Non-Insulated Terminals and Disconnects

- Locate terminal in appropriate wire gauge crimp die pocket with indenter centered on barrel seam.
- Rotate terminal so tongue is level with crimp die.
- Insert properly stripped wire (based on recommendations on package label) into terminal until a minimum of 1/32" of wire extends beyond the terminal barrel.
- Squeeze tool handles firmly to perform the electrical crimp. (See Note 2, page D1.82)



Step A



Step B



Steps C and D



Complete Crimp

### Insulated and Non-Insulated Parallel Splices

- Locate parallel splice in appropriate wire gauge crimp die pocket and position tool on the center of the splice.
- Rotate terminal so tongue is level with crimp die.
- Insert properly stripped wire (based on recommendations on package label) into each end of the parallel splice.
- Squeeze tool handles firmly. (See Note 2, page D1.82)
- An insulation crimp is not required on an insulated parallel splice.

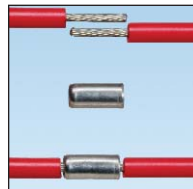

Steps A and B



Steps C and D



Complete Crimp

### Insulated and Non-Insulated Butt Splices

- Locate butt splice in appropriate color-coded crimp die pocket and position crimp halfway between the wire stop (center of splice) and the end of the insulation crimp area. (See Note 4, page D1.82)
- Insert properly stripped wire (based on recommendations on package label) into one end of butt splice.
- Squeeze tool handles firmly to perform the electrical crimp (See Note 2, page D1.82)
- Provide second crimp on the flared portion of the insulation housing to close the insulation. Caution: When using plier type crimping tools, do not squeeze as firmly as you did for the electrical crimp. (See Note 3, page D1.82)
- Repeat steps 1 – 4 for opposite end of butt splice. (See Note 3, page D1.82)



Steps A and B



Step C

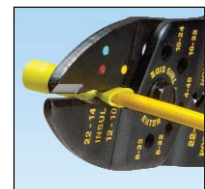

Steps D and E



Complete Crimp

A.  
System  
Overview

B1.  
Cable Ties

B2.  
Cable  
Accessories

B3.  
Stainless  
Steel Ties

C1.  
Wiring  
Duct

C2.  
Surface  
Raceway

C3.  
Abrasion  
Protection

C4.  
Cable  
Management

D1.  
Terminals

D2.  
Power  
Connectors

D3.  
Grounding  
Connectors

E1.  
Labeling  
Systems

E2.  
Labels

E3.  
Pre-Printed  
& Write-On  
Markers

E4.  
Permanent  
Identification

E5.  
Lockout/  
Tagout  
& Safety  
Solutions

F.  
Index

A. System Overview

B1. Cable Ties

B2. Cable Accessories

B3. Stainless Steel Ties

C1. Wiring Duct

C2. Surface Raceway

C3. Abrasion Protection

C4. Cable Management

D1. Terminals

D2. Power Connectors

D3. Grounding Connectors

E1. Labeling Systems

E2. Labels

E3. Pre-Printed & Write-On Markers

E4. Permanent Identification

E5. Lockout/Tagout & Safety Solutions

F. Index

## Crimping Guidelines for Panduit® Pan-Term® Terminals, Disconnects, Splices and Wire Joints (continued)

### Insulated and Non-Insulated Wire Joints

- A. Properly strip wires per manufacturer's recommendations on product package label.
- B. Twist stripped wire ends together and insert wires into wire joint.
- C. Locate wire joint in appropriate wire gauge crimp die pocket and position crimp in the center of the metal insert.
- D. Squeeze tool handles firmly to perform the electrical crimp. *(See Note 2 below)*

Note: An insulation crimp is not required on an insulated wire joint.



Steps A and B



Steps C and D

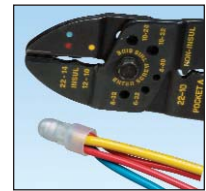

Complete Crimp

### NOTES for Crimping with the Preferred Hand Operated Controlled Cycle Crimping Tools:

1. Panduit controlled cycle crimping tools properly locate rings, forks, and barrel insulated disconnects, pins, and blades. No further positioning is required.
2. When using the preferred controlled cycle tool, once a crimp has been started, the ratchet device of controlled cycle tools will not release until the crimp is complete, independent of operator expertise.
3. Controlled cycle tools provide the electrical crimp and the insulation closure in a single cycle of the tool.
4. When using controlled cycle tooling, insulated butt splices must be inserted from the back of the tool to ensure that the electrical and insulation closure crimp pockets are properly aligned with the splice.

### 5. Perform the electrical crimp using the preferred controlled cycle tool

- A. Make sure the terminal barrel is centered correctly in the right die pocket by using the product locator on the backside of the tool.
- B. Determine the correct die pocket to use based on the color code of the terminal.
- C. Squeeze the handles of the tool until one click is heard; this click indicates the terminal is now held in place securely to insert the wire.
- D. Insert the wire and complete cycle to perform the electrical and insulation crimp simultaneously.
- E. Crimp is complete.



Step A



Step B



Step C



Step D



Complete Crimp

### 6. Inspect the crimp

Note: If your crimp looks like any of the examples shown below, cut off the terminal and re-crimp. These crimps would provide a poor connection!



Bent Back Strands



Over Crimp



Rotated Crimp

## Hand Operated Plier Type Tools

- Installer controlled crimp
- Available with wire stripping and cutting features

- Plier type crimp for #22 – 10 AWG insulated and non-insulated terminal products



CT-260



CT-200



CT-160



CT-100A

Part Number	Part Description	Std. Pkg. Qty.
CT-260	Crimps most Panduit #22 – 10 AWG insulated and non-insulated terminals. Forged steel tool. Cuts wire.	1
CT-200	Forged steel tool. Crimps most Panduit #22 – 10 AWG non-insulated terminals, disconnects and splices. Cuts wire.	1
CT-160	Crimps most Panduit #22 – 10 AWG insulated and non-insulated terminals disconnects and splices. Cuts three U.S. and three metric screw sizes. Cuts and strips wire. Has insulation closure pocket.	1
CT-100A	Crimps most Panduit #22 – 10 AWG insulated and non-insulated terminals, disconnects, and splices. Cuts #4, #6, #8 and #10 screw sizes. Cuts and strips wire. Excellent all-around application tool of heat treated finished steel with comfortable cushioned plastic grip handles.	1

## Wire and Cable Stripping Tools

- Strips and cuts #20 – 10 AWG wire
- Lightweight and durable for comfortable long use

- Rust resistant coating included to improve durability of tool



Part Number	Wire Range (O.D.)	Part Description	Std. Pkg. Qty.
CST115	#20 – 10 AWG	Plier nose wire stripper.	1

A.  
System  
Overview

B1.  
Cable Ties

B2.  
Cable  
Accessories

B3.  
Stainless  
Steel Ties

C1.  
Wiring  
Duct

C2.  
Surface  
Raceway

C3.  
Abrasion  
Protection

C4.  
Cable  
Management

D1.  
Terminals

D2.  
Power  
Connectors

D3.  
Grounding  
Connectors

E1.  
Labeling  
Systems

E2.  
Labels

E3.  
Pre-Printed  
& Write-On  
Markers

E4.  
Permanent  
Identification

E5.  
Lockout/  
Tagout  
& Safety  
Solutions

F.  
Index

A. System Overview

## Contour Crimp™ Controlled Cycle Tools

B1. Cable Ties

- Controlled cycle mechanism assures high quality, consistent terminations
- Ergonomic tool design assures operator comfort, safety, and performance

- Polypropylene handles provide chemical resistance and a cushioned, non-slip grip

B2. Cable Accessories

B3. Stainless Steel Ties



C1. Wiring Duct



C2. Surface Raceway



C3. Abrasion Protection



C4. Cable Management



D1. Terminals



D2. Power Connectors



D3. Grounding Connectors



E1. Labeling Systems

E2. Labels

E3. Pre-Printed & Write-On Markers

E4. Permanent Identification

E5. Lockout/Tagout & Safety Solutions

F. Index

Part Number	Part Description	Std. Pkg. Qty.
<b>CT-1525</b>	Crimps Panduit #26 – 22 AWG insulated terminals and splices, #22 – 10 AWG fully insulated disconnects and insulated parallel splices. Crimps Panduit #22 – 14 AWG barrel insulated disconnects.	1
<b>CT-1550</b>	Crimps most Pan-Term® #22 – 10 AWG nylon and vinyl insulated terminals, splices, and disconnects. The CT-1550 has the red/blue pocket closest to the pivot which provides a reduced crimp effort for those who make red/blue terminations.	1
<b>CT-1551</b>	Crimps most Pan-Term® #22 – 10 AWG nylon and vinyl insulated terminals, splices, and disconnects. The CT-1551 has the yellow pocket closest to the pivot which provides a reduced crimp effort for those who make yellow terminations.	1
<b>CT-1570</b>	Crimps most Pan-Term® #22 – 10 AWG and .5 – 6.0mm <sup>2</sup> non-insulated terminals and disconnects. Crimps Panduit #22 – 10 AWG and .5 – 6.0mm <sup>2</sup> non-insulated splices and #10 AWG compression lugs.	1
<b>CT-1700</b>	Crimps Panduit #8 – 2 AWG non-insulated tubular terminals (S series), #8 – 1 AWG copper code conductor lugs and splices, #8 – 2 AWG copper flex conductor lugs, #6 – 4 AWG dual rated aluminum lugs and splices and CTAPF10-16 to CTAPF3-12 copper taps. Includes 5-position, color coded rotating die.	1
<b>CT-1701</b>	Crimps Panduit #10 – 2 AWG non-insulated large gauge ring terminals (P series), #12 – 4 AWG non-insulated heavy duty ring terminals (P series), and #14 – 10 AWG copper code conductor lugs. Includes 5-position, rotating die.	1
<b>CT-1014</b>	Crimps Panduit #22 – 14 AWG loose piece Disco-Lok™ Disconnects.	1
<b>CT-1015</b>	Crimps Panduit #22 – 14 AWG loose piece Supra-Grip™ Disconnects.	1

## Controlled Cycle Crimping Tools

- Specialty crimping tools for fully insulated right angle disconnects and heat shrink insulated terminals, disconnects, and splices
- Controlled cycle mechanism assures high quality, consistent terminations



CT-300-1

Part Number	Part Description	Std. Pkg. Qty.
CT-300-1	Crimps Panduit #22 – 14 AWG fully insulated right angle disconnects (DNFR-FIB series).	1
CT-310	Blue handle tool crimps Panduit #22 – 10 AWG heat shrink insulated terminals, disconnects, and splices.	1

## Controlled Cycle Crimping Tools – Ferrule End Sleeve

- Specifically designed for the installation of Pan-Term® Ferrules
- Controlled cycle mechanism assures high quality, consistent terminations
- Ergonomic tool design assures operator comfort, safety, and performance
- Multi-position locator facilitates a high quality repeatable crimp



CT-1002



CT-1003



CT-1004



CT-1005



CT-1006



CT-1104



CT-1123

Part Number	Part Description	Std. Pkg. Qty.
CT-1002	Controlled cycle crimp tool with trapezoid profile for #26 – 10 AWG (0.14 – 6.0mm <sup>2</sup> ) insulated and non-insulated single wire ferrules and #22 – 12 AWG (0.50 – 4.0mm <sup>2</sup> ) insulated twin wire ferrules.	1
CT-1003	Controlled cycle crimp tool with trapezoid profile for #22 – 8 AWG (0.50 – 10.0mm <sup>2</sup> ) insulated and non-insulated ferrules and #22 – 10 AWG (0.50 – 6.0mm <sup>2</sup> ) insulated twin wire ferrules.	1
CT-1004	Controlled cycle crimp tool with trapezoid profile for #8 – 6 AWG (10.0 – 16.0mm <sup>2</sup> ) insulated and non-insulated ferrules and #10 AWG (6.0mm <sup>2</sup> ) insulated twin wire ferrules.	1
CT-1005	Controlled cycle crimp tool with trapezoid profile for #4 – 2 AWG (26.0 – 35.0mm <sup>2</sup> ) insulated and non-insulated ferrules.	1
CT-1006	Controlled cycle crimp tool with trapezoid profile for #1 AWG (50.0mm <sup>2</sup> ) insulated and non-insulated ferrules.	1
CT-1104	Controlled cycle crimp tool with square profile for #8 – 6 AWG (10.0 – 16.0mm <sup>2</sup> ) insulated and non-insulated ferrules and #10 AWG (6.0mm <sup>2</sup> ) insulated twin wire ferrules.	1
CT-1123	Controlled cycle crimp tool with square profile for #26 – 8 AWG (0.14 – 10.0mm <sup>2</sup> ) insulated and non-insulated ferrules and #22 – 12 AWG (0.50 – 4.0mm <sup>2</sup> ) insulated twin wire ferrules.	1

A. System Overview

B1. Cable Ties

B2. Cable Accessories

B3. Stainless Steel Ties

C1. Wiring Duct

C2. Surface Raceway

C3. Abrasion Protection

C4. Cable Management

D1. Terminals

D2. Power Connectors

D3. Grounding Connectors

E1. Labeling Systems

E2. Labels

E3. Pre-Printed & Write-On Markers

E4. Permanent Identification

E5. Lockout/ Tagout & Safety Solutions

F. Index

A. System Overview

## Semiautomatic Ferrule Crimping Tool CT-1000

B1. Cable Ties

- Innovative rapid load design utilizes continuously molded ferrules to significantly reduce installation time
- Adjustable die setting allows termination of all Panduit #20 – 14 AWG continuously molded ferrules with a single tool
- Controlled cycle tool cuts, strips, and crimps wire to maximize efficiency

B2. Cable Accessories



B3. Stainless Steel Ties

Part Number	Part Description	Std. Pkg. Qty.
<b>CT-1000</b>	Controlled cycle crimp tool with trapezoid profile for #20 – 14 AWG (0.50 – 2.5mm <sup>2</sup> ) insulated continuously molded ferrules on strips. Also cuts and strips wire.	1

C1. Wiring Duct

C2. Surface Raceway

## Controlled Cycle Crimping Tools – In-Line

- Military specialty tools help meet military and nuclear test requirements for Class 2 applications
- Calibration-recalibration is possible for maintaining exact crimp dimensions
- In-line crimp action for greater dielectric strength with uniform insulation compression

C3. Abrasion Protection



C4. Cable Management

Part Number	Part Description	Std. Pkg. Qty.
<b>CT-400</b>	Crimps #22 – 14 Panduit insulated terminals, disconnects, and splices. Comes complete with tools for calibration. Has adjustable pre-load and emergency ratchet. Helps meet military and nuclear requirements.	1
<b>CT-460</b>	Crimps #16 – 10 Panduit insulated terminals, disconnects, and splices. Has same features as CT-400 above.	1

For proper crimp head selection, see the tooling selection guide for Panduit terminals, splices, and disconnects on pages D1.90 – D1.92, in this catalog.

D1. Terminals

D2. Power Connectors

## Pneumatic Crimping Tool

D3. Grounding Connectors

- Quickly crimps a variety of loose piece terminals in a variety of wire sizes for medium volume production
- Portable – the small size, ease of bench mounting and quick pneumatic connection allow the tool to be moved from one work station to another or to the work itself
- Versatile interchangeable crimping heads let you switch terminal types quickly to meet changing production requirements; this tool, when used with only four crimp heads, can crimp a full range of #26 – 10 AWG insulated and non-insulated terminal products

E1. Labeling Systems



E2. Labels

E3. Pre-Printed & Write-On Markers

E4. Permanent Identification

E5. Lockout/Tagout & Safety Solutions

F. Index

Part Number	Part Description	Std. Pkg. Qty.
<b>CT-600-A</b>	Pneumatic tool, 6' air hose and carrying case. Does not include crimping heads (ordered separately).	1
<b>CT-500CH</b>	Crimping head for most #22 – 14 insulated terminals, splices, and disconnects.	1
<b>CT-520CH</b>	Crimping head for most #22 – 14 insulated butted seam disconnects and #26 – 22 insulated terminals.	1
<b>CT-550CH</b>	Crimping head for most #22 – 10 insulated terminals and splices.	1
<b>CT-570CH</b>	Crimping head for #22 – 10 non-insulated terminals, splices, and disconnects.	1
<b>PD-600-A</b>	Positioning device (for bench mounting of CT-600-A).	1
<b>FPC-600-A</b>	Foot actuator operating air pressure: 80 – 100 psi .233 SCFM type of air: lubricated. Recommend using Norgren (Brand) #FLR222-012-043008 filter lubricator regulator.	1
<b>K600-A</b>	Update kit for foot pedal control and positioning device to work with new CT-600-A pneumatic crimping tool.	1

For proper crimp head selection, see the tooling selection guide for Panduit terminals, splices, and disconnects on pages D1.90 – D1.92, in this catalog.

## Die Type, Manual, Crimping Tool

- High quality, durable tool construction provides long term dependability
- Develops 6 tons of crimping force, crimps copper compression lugs and splices up to 500 kcmil
- Provides UL Listed and CSA Certified connections on Panduit copper and aluminum lugs, splices insulated terminals



Part Number	Part Description	Std. Pkg. Qty.
CT-720	Manual crimping tool for UL Listed or Recognized and CSA Certified terminations of Panduit® Pan-Lug™ copper compression lugs and splices for #8 AWG – 500 kcmil copper code conductor and aluminum compression lugs and splices for #6 AWG – 350 kcmil copper and aluminum code conductors. Provides UL Listed terminations of Panduit® Pan-Term® #8 – 2 AWG vinyl insulated terminals.  Color-coded CD-720 crimping dies, carrying/storage case, and controlled cycle mechanism must be purchased separately.  Specifications: Output: 6 tons Weight: 7.7 lbs. Length: 26" Handle span: 58" (open), 2.5" (closed) Warranty: 90 days	1
CC-720	Optional controlled cycle mechanism only. Total weight of tool with CC-720 is 8.25 lbs.	1
C-720	Black steel carrying case for CT-720 crimping tool.	1

For battery powered crimping tools, see compression connector tools selection guide on pages D3.30 – D3.32.

## CD-720 Crimping Dies

- Color-coded for easy matching to color-coding marked on connectors
- Embosses die index number on connector barrels to provide post crimp inspection except CD-720PV8-2
- Part number permanently marked on crimping die for easy identification
- Provides 5-sided crimp results in terminations with premium electrical and mechanical performance



CD-720PV8-2

Part Number	Used to Install Panduit Compression Lug and Splice Sizes				Std. Pkg. Qty.
	Copper Conductor Size	Copper Die Color and Die No.	Aluminum Conductor Size	Aluminum Die Color and Die No.	
CD-720-1	#8 – 2 AWG	Red P21 Blue P24 Gray P29 Brown P33	#6 AWG	Gray P29	1
CD-720-2	#1 – 3/0 AWG	Green P37 Pink P42 Black P45 Orange P50	#4 – 1/0 AWG	Green P37 Pink P42 Gold P45 Tan P50	1
CD-720-3	4/0 AWG – 250 kcmil	Purple P54 Yellow P62	2/0 – 3/0 AWG	Olive P54 Ruby P62	1
CD-720-4	300 kcmil	White P66	4/0 AWG	White P66	1
CD-720-5	350 kcmil	Red P71	250 kcmil	Red P71	1
CD-720-6	400 kcmil	Blue P76	300 kcmil	Blue P76	1
CD-720-7	500 kcmil	Brown P87	350 kcmil	Brown P87	1
CD-720PV8-2	#8 – 2 AWG, Vinyl Insulated Pan-Term® Terminals	Red, Blue, Yellow	—	—	1

See pages D3.30 – D3.32 for connector and tool selection information.

A.  
System  
Overview

## CT-2500 Battery Powered Crimping Tool

B1.  
Cable Ties

- Quick two-second crimping cycle results in less time to crimp terminals compared to conventional methods
- Interchangeable crimp heads for termination of all Panduit #22 – 10 AWG terminals, disconnects, and splices
- Lightweight 3.3 lb. design provides maximum productivity and ease of use in continuous workflow operations

B2.  
Cable  
Accessories



CT-2500

B3.  
Stainless  
Steel Ties

C1.  
Wiring  
Duct

C2.  
Surface  
Raceway



CT-2550CH

C3.  
Abrasion  
Protection

C4.  
Cable  
Management



CT-2500BC

D1.  
Terminals

D2.  
Power  
Connectors

D3.  
Grounding  
Connectors

E1.  
Labeling  
Systems

E2.  
Labels

E3.  
Pre-Printed  
& Write-On  
Markers

E4.  
Permanent  
Identification

E5.  
Lockout/  
Tagout  
& Safety  
Solutions

F.  
Index

Part Number	Part Description	Std. Pkg. Qty.
<b>Crimping Tools</b>		
<b>CT-2500</b>	Crimps Panduit #22 – 10 AWG insulated and non-insulated terminals, disconnects and splices. Includes tool, two battery cartridges (CT-2500BC), battery charger (CT-2500CHR) and molded carrying case (CT-2500CASE). These parts are also compatible with the CT-2600. Crimp heads not included. Meets U.S. voltage requirements.	1
<b>CT-2500/E</b>	Crimps Panduit #22 – 10 AWG insulated and non-insulated terminals, disconnects and splices. Includes tool, two battery cartridges (CT-2500BC), battery charger (CT-2500CHR/E) and molded carrying case (CT-2500CASE). These parts are also compatible with the CT-2600/E. Crimp heads not included. Meets European voltage requirements.	1

### Crimp Head Frames

<b>CT-2550CH</b>	Crimps Panduit #22 – 10 AWG insulated terminals, disconnects, and splices.	1
<b>CT-2525CH</b>	Crimps Panduit #22 – 10 AWG fully insulated disconnects and insulated parallel splices.	1
<b>CT-2570CH</b>	Crimps Panduit #22 – 10 AWG non-insulated terminals, disconnects, and splices.	1

### Die Inserts For Use With CT-2500CH Crimp Head Frame

<b>CD-525</b>	Die insert used with CT-2500CH (sold separately) to crimp Panduit #22 – 10 AWG fully insulated disconnects and insulated parallel splices.	1
<b>CD-550</b>	Die insert used with CT-2500CH (sold separately) to crimp Panduit #22 – 10 AWG insulated terminals, disconnects, and splices.	1
<b>CD-570</b>	Die insert used with CT-2500CH (sold separately) to crimp Panduit #22 – 10 AWG non-insulated terminals, disconnects, and splices.	1

### Accessories

<b>CT-2500CHR</b>	U.S. compatible battery charger for use with the CT-2500 and the CT-2600.	1
<b>CT-2500CHR/E</b>	European compatible battery charger for use with the CT-2500/E and CT-2600/E.	1
<b>CT-2500BC</b>	Rechargeable tool battery for use with the CT-2500 and CT-2600.	1
<b>CT-2500CASE</b>	Carrying case, holds tool (CT-2500 or CT-2600) and accessories.	1





## CT-2600 Battery Powered Hydraulic, 4 Ton, Crimping Tool

- Battery powered hydraulic design delivers quick termination of #8 – 2 AWG large wire insulated and non-insulated ring terminals
- Quick 4 second crimping cycle results in less time to crimp terminals compared to conventional methods
- Compact, portable, and lightweight (3.5 lbs.) construction allows simple one hand crimp capability

- Ram retracts automatically to signal crimp is complete
- Retractable slide button allows ram to retract in mid-cycle for manual adjustment of terminals
- Snap in crimp die provides quick change of Panduit interchangeable crimp dies without the use of tools
- 360° rotating, crimp head design allows use in limited space areas



CT-2600



CT-2500BC

Part Number	Part Description	Std. Pkg. Qty.
<b>Crimping Tools</b>		
CT-2600	Crimps Panduit tin and nickel plated #8 – 2 AWG high temperature large wire, non-insulated, vinyl and KYNAR® insulated ring terminals. Includes tool with crimp head, two battery cartridges (CT-2500BC), battery charger (CT-2500CHR) and molded carrying case (CT-2500CASE). These parts are also compatible with the CT-2500. Crimp dies not included. Meets U.S. voltage requirements.	1
CT-2600/E	Crimps Panduit tin and nickel plated #8 – 2 AWG high temperature large wire, non-insulated, vinyl and KYNAR® insulated ring terminals. Includes tool with crimp head, two battery cartridges (CT-2500BC), battery charger (CT-2500CHR/E) and molded carrying case (CT-2500CASE). These parts are also compatible with the CT-2500/E. Crimp dies not included. Meets European voltage requirements.	1
<b>Crimp Die Inserts</b>		
CD-2600-P8	Used with CT-2600 to install Panduit P8 and P8-RHT6 series large wire, high temperature, non-insulated ring terminals.	1
CD-2600-P6	Used with CT-2600 to install Panduit P6 and P6-RHT6 series large wire, high temperature, non-insulated ring terminals.	1
CD-2600-P4	Used with CT-2600 to install Panduit P4 and P4-RHT6 series large wire, high temperature, non-insulated ring terminals.	1
CD-2600-P2	Used with CT-2600 to install Panduit P2 and P2-RHT6 series large wire, high temperature, non-insulated ring terminals.	1
CD-2600-PV8	Used with CT-2600 to install Panduit PV8 and PK8 series large wire, vinyl and KYNAR® insulated ring terminals.	1
CD-2600-PV6	Used with CT-2600 to install Panduit PV6 and PK6 series large wire, vinyl and KYNAR® insulated ring terminals.	1
CD-2600-PV4	Used with CT-2600 to install Panduit PV4 and PK4 series large wire, vinyl and KYNAR® insulated ring terminals.	1
CD-2600-PV2	Used with CT-2600 to install Panduit PV2 and PK2 series large wire, vinyl and KYNAR® insulated ring terminals.	1
<b>Accessories</b>		
CT-2500CHR	U.S. compatible battery charger for use with the CT-2500 and the CT-2600.	1
CT-2500CHR/E	European compatible battery charger for use with the CT-2500/E and CT-2600/E.	1
CT-2500BC	Rechargeable tool battery for use with the CT-2500 and CT-2600.	1

®KYNAR is a registered trademark of Atofina Chemicals, Inc.

A. System Overview

B1. Cable Ties

B2. Cable Accessories

B3. Stainless Steel Ties

C1. Wiring Duct

C2. Surface Raceway

C3. Abrasion Protection

C4. Cable Management

D1. Terminals

D2. Power Connectors

D3. Grounding Connectors

E1. Labeling Systems

E2. Labels

E3. Pre-Printed & Write-On Markers

E4. Permanent Identification

E5. Lockout/Tagout & Safety Solutions

F. Index



## Tooling Selection Guide for Panduit Terminals, Splices, and Disconnects (continued)

Panduit Terminal Series	Terminal Description	Std. Wire Range (AWG)	Wire Strip Length (In.)	Plier Tools				Controlled Cycle Hand Tools												Crimp Heads for Pneumatic CT-600-A Tool						
				CT-100A	CT-160	CT-200	CT-260	CT-720	CT-300-1	CT-310	CT-400	CT-460	CT-1014	CT-1015	CT-1525	CT-1550	CT-1551	CT-1570	CT-1701	CT-2500	CT-2600	CT-500CH	CT-520CH	CT-550CH	CT-570CH	
DNF-M	Nylon insulated, funnel entry, barrel insulated, male disconnects	22-18	9/32	X	X		X									X	X			X		X		X		
		16-14	9/32	X	X		X									X	X			X		X		X		
		12-10	9/32	X	X		X									X	X			X				X		
DNFR-B	Nylon pre-insulated, right angle disconnects	22-18	9/32	X										X					X							
		16-14	9/32	X										X					X							
DNFR-FIB	Nylon butted seam, right angle disconnects	22-18	11/32						X																	
		16-14	11/32						X																	
DNG-FB	Supra Grip™ Nylon, Fully Insulated Disconnects (except DNG14-187FB and DNG14-188FB)	22-18	1/4											X												
		16-14	1/4											X												
DNG-FL	Disco-Lok™ Nylon, Fully Insulated Disconnects	22-18	1/4											X												
		16-14	1/4											X												
DNH	Heat shrink disconnects	22-18	5/16							X																
		16-14	5/16							X																
		12-10	5/16							X																
DV	Vinyl barrel insulated sleeved disconnects	12-10	9/32	X											X	X			X				X			
DV-B	Vinyl insulated, butted seam disconnects	22-18	1/4	X										X					X				X			
		16-14	1/4	X										X					X				X			
DV-M	Vinyl barrel insulated male blade adapters	22-18	9/32	X	X		X				X					X	X			X		X		X		
		16-14	9/32	X	X		X			X	X					X	X			X		X		X		
DV-M	Vinyl insulated male disconnects	12-10	9/32	X			X																	X		
DV-MB	Vinyl insulated butted seam male disconnects	22-18	9/32	X						X				X						X		X		X		
		16-14	9/32	X						X	X			X						X		X		X		
DV-P	Vinyl insulated piggyback disconnects	22-18	1/4	X	X		X									X	X			X		X		X		
		16-14	1/4	X	X		X									X	X			X		X		X		
DVF	Vinyl funnel entry barrel insulated female disconnect	22-18	9/32													X	X			X		X		X		
		16-14	9/32													X	X			X		X		X		
J	Non-insulated wire joints																									
		J214-312	14-12	1/2	X		X																			
		J318-412	18-12	1/2	X		X																			
		J216-410	16-10	3/4			X																			
JN	Nylon insulated wire joints																									
		JN224-318	24-16	7/16	X	X		X								X	X			X		X		X		
		JN218-216	22-16	7/16	X	X					X					X	X			X		X		X		
		JN418-212	18-12	1/2	X	X					X					X	X			X				X		
JN314-412	14-12	5/8		X																						
P-HDR	Non-insulated heavy duty rings	16-12	9/32	X		X	X												X	X	X				X	
P-P	Non-insulated pin terminals	22-18	9/32	X	X	X	X													X		X			X	
		16-14	9/32	X	X	X	X													X		X			X	
		12-10	9/32	X	X	X	X													X	X	X			X	
P-R	Non-insulated large ring terminals	8	3/8																							
		6	7/16																							
		4	1/2																							
		2	1/2																							

Tool/product approved combinations indicated on individual product pages.

Table continues on page D1.92



## Tooling Selection Guide for Panduit Tubular Ring Terminals

Tooling	CT-1700	CT-720	CT-930, CT-930CH, CT-920, CT-920CH, CT-2920, CT-940CH	CT-980, CT-980CH, CT-2950, CT-2980	CT-2001
Panduit Part Number	Panduit Die Part Number Die Index Number (Number of Crimps)				
S8-10R-Q	P21 (2)	CD-720-1 P21 (1)	CD-920-8 P21 (1)	—	CD-2001-8 P21 (1)
S8-14R-Q					
S8-56R-Q					
S8-38R-Q					
S6-10R-E	P24 (2)	CD-720-1 P24 (1)	CD-920-6 P24 (1)	—	CD-2001-6 P24 (1)
S6-14R-E					
S6-56R-E					
S6-38R-E					
S4-10R-E	P29 (2)	CD-720-1 P29 (1)	CD-920-4 P28 (1)	STD (1)	CD-2001-4 P29 (1)
S4-14R-E					
S4-56R-E					
S4-38R-E					
S2-10R-X	P37 (3)	CD-720-2 P37 (1)	CD-920-1 P37 (1)	STD (1)	CD-2001-1 P37 (1)
S2-14R-X					
S2-56R-X					
S2-38R-X					
S2-12R-X	—	CD-720-2 P42 (1)	CD-920-1/0 P42 (1)	STD (1)	CD-2001-1/0 P42 (1)
S1/0-14R-X					
S1/0-56R-X					
S1/0-38R-X					
S1/0-12R-X	—	CD-720-2 P45 (2)	CD-920-2/0 P45 (1)	STD (1)	CD-2001-2/0 P45 (2)
S2/0-14R-X					
S2/0-56R-X					
S2/0-38R-X					
S2/0-76R-X	—	CD-720-2 P50 (2)	CD-920-3/0 P50 (1)	STD (1)	CD-2001-3/0 P50 (2)
S2/0-12R-X					
S3/0-14R-5					
S3/0-56R-5					
S3/0-38R-5	—	CD-720-2 P54 (2)	CD-920-4/0 P54 (1)	STD (1)	CD-2001-4/0 P54 (2)
S3/0-76R-5					
S3/0-12R-5					
S4/0-38R-5					
S4/0-76R-5	—	CD-720-3 P62 (2)	CD-920-250 P62 (1)	STD (1)	CD-2001-250 P62 (2)
S4/0-12R-5					
S250-56R-5					
S250-38R-5					
S250-76R-5	—	CD-720-3 P62 (2)	CD-920-250 P62 (1)	STD (1)	CD-2001-250 P62 (2)
S250-12R-5					

A.  
System  
Overview

B1.  
Cable Ties

B2.  
Cable  
Accessories

B3.  
Stainless  
Steel Ties

C1.  
Wiring  
Duct

C2.  
Surface  
Raceway

C3.  
Abrasion  
Protection

C4.  
Cable  
Management

D1.  
Terminals

D2.  
Power  
Connectors

D3.  
Grounding  
Connectors

E1.  
Labeling  
Systems

E2.  
Labels

E3.  
Pre-Printed  
& Write-On  
Markers

E4.  
Permanent  
Identification

E5.  
Lockout/  
Tagout  
& Safety  
Solutions

F.  
Index

A.  
System  
Overview

B1.  
Cable Ties

B2.  
Cable  
Accessories

B3.  
Stainless  
Steel Ties

C1.  
Wiring  
Duct

C2.  
Surface  
Raceway

C3.  
Abrasion  
Protection

C4.  
Cable  
Management

D1.  
Terminals

D2.  
Power  
Connectors

D3.  
Grounding  
Connectors

E1.  
Labeling  
Systems

E2.  
Labels

E3.  
Pre-Printed  
& Write-On  
Markers

E4.  
Permanent  
Identification

E5.  
Lockout/  
Tagout  
& Safety  
Solutions

F.  
Index

## Tooling Selection Guide for Panduit Ferrules

Panduit Ferrule Series	Ferrule Description	Wire Range (AWG)	Wire Range (mm²)	Wire Strip Length	Controlled Cycle Hand Tools											
					CT-1000	CT-1002	CT-1003	CT-1004	CT-1005	CT-1006	CT-1104	CT-1123				
F	Non-insulated ferrules	24	0.25	Please See Ferrule Tables – Pgs. D1.73 – D1.77		X	X									
		22 – 18	0.50 – 1.00			X	X						X			
		16	1.50			X	X						X			
		14	2.50			X	X									
		12	4.00			X	X							X		
		10	6.00			X	X							X		
		8	10.0					X	X					X		
		6	16.0						X	X				X		
		4 – 2	25.0 – 35.0								X			X		
		1	50.0									X				
		FSD, FSF	Insulated single wire ferrules (DIN or French color code)		26 – 18	0.41 – 1.00			X	X						X
					16 – 14	1.50 – 2.00			X	X						X
					12 – 10	4.00 – 6.00			X	X						X
8	10.0						X	X				X	X			
6	16.0							X	X			X				
4 – 2	25.0 – 35.0									X						
1	50.0										X					
FTD	Insulated twin wire ferrules	22 – 18	0.50 – 1.00			X	X						X			
		16 – 14	1.50 – 2.00			X	X						X			
		12	4.00					X	X				X			
		10	6.00					X	X			X				
FSD-DSL FS-DSL	Insulated single wire ferrules on strips of 50 (DIN or other color code)	20 – 14	0.50 – 2.50	0.31" (8mm)	X											

## Technical Specification and Selection Information

The following pages provide information helpful in specifying Panduit terminals and selecting the appropriate terminal and tooling for your applications.

### Panduit Terminal Approvals



Logo (Symbol)	Agency	Spec/Approval	Requirement	Applicable Products
	Underwriters Laboratories, Inc.	#E52164 – UL486A	Minimum tensile strength (pull out force for the crimp terminal) and test current for max. 50°C rise (amps)	All Ring and Fork Terminals
		#E78522 – UL310	Minimum tensile strength (pull out force for the crimp terminal) and continuous test current for max. 30°C rise (amps) (for .187", .205", .250" tab widths) and (.110" tab width)	All Disconnects
		#E52164 – UL486C	Minimum tensile strength (pull out force for the crimp terminal) and test current for max. 50°C rise (amps)	All Splices
	Canadian Standards Association	#LR31212 – C22.2 No. 65	Minimum tensile strength (pull out force for the crimp terminal) and test current for max. 50°C rise (amps)	All Ring and Fork Terminals
		#LR31212 – C22.2 No. 153		All Disconnects
	American Bureau of Shipping	ABS Rules, Steel Vessel Rules 1-1-4/7.7, 4-8-3/9.19, 4-8-4/21.28	Passed extensive testing requirements to verify that product will perform reliably in marine and offshore environments.	Fork Terminals: P-F, PN-F, PV-F, PN-LF, PNF-LF, PV-LF, P-LF Ring Terminals: P-R, PN-R, PNF-R, RV-R, S-R Wire Joints: JN224-318, JN218-216, JN418-212 Splices: BSN, BSV, BS Disconnects: DNF, DNF-FIB, DVF, D, DNF-FL, DNF-M, DNF18-250M, DNF14-250M, DNF18-250FIM, FIMB, FIB, 14-250FIM, FIMB, and FIB
	IEEE (Institute of Electrical and Electronics Engineers)	IEEE std 323-2003 for Qualifying Class 1E Eqpt. for Nuclear Power Generating Stations	Meets criteria for use in harsh, high radiation environments in nuclear power plants	▪Kynar Ring Terminals
	Dept. of Defense	Mil Spec Qualification Test Ref #01017302.AB/08-31-2006	Approved for listing on QPL AS 7928 Class I and Class II	Ring Terminals

▪KYNAR is a registered trademark of Atofina Chemicals, Inc.

A. System Overview

B1. Cable Ties

B2. Cable Accessories

B3. Stainless Steel Ties

C1. Wiring Duct

C2. Surface Raceway

C3. Abrasion Protection

C4. Cable Management

D1. Terminals

D2. Power Connectors

D3. Grounding Connectors

E1. Labeling Systems

E2. Labels

E3. Pre-Printed & Write-On Markers

E4. Permanent Identification

E5. Lockout/Tagout & Safety Solutions

F. Index

A. System Overview

## Performance Requirements

B1. Cable Ties

	Wire Size (AWG)								
	#26	#24	#22	#20	#18	#16	#14	#12	#10

### UL 486A (TERMINALS), UL 310 (MALE BLADE ADAPTERS)

Test Current for Max. 50°C Rise (Amps)	3.5	7	9	12	17	18	30	35	50
Min. Tensile Strength* (Lbs.)	3	5	8	13	20	30	50	70	80

### UL 486C (SPICES)

Test Current for Max. 50°C Rise (Amps)	5.5	7	9	12	17	18	30	35	50
Min. Tensile Strength* (Lbs.)	3	5	8	10	10	15	25	35	40

\*Pull-out force of the crimped terminal.

Applicable Pan-Term® products meet or exceed the following test specifications:

- UL 486A (Terminals)
- UL 486C (Splices)
- UL 310 (Blade Adapters)
- CSA C22.2 No. 65 (all designs)

UL and CSA approved products are shown with the applicable logos in the product section. UL file #E52164, CSA File #LR31212.

C1. Wiring Duct

C2. Surface Raceway

	Wire Size (AWG)						
	#22	#20	#18	#16	*#14	#12	#10

### UL 310 (DISCONNECTS)

Continuous Test Current for Max. 30°C Rise (amps) (for 187", 205", 250" tab widths)	3	4	7	10	15	20	24
Continuous Test Current for Max. 30°C Rise (amps) (for .110", tab width)	2	3	4	5	Not Applicable		
Min. Tensile Strength* (Lbs.)	8	13	20	30	50	70	80

\*Pull-out force of the crimped disconnect.

Applicable Pan-Term® products meet or exceed the following test specifications:

- UL 310 (Disconnects)
- CSA C22.2 No. 153 (all designs)

UL and CSA Listed products are shown with the applicable logos in the product section. UL file #E78522 and CSA file #LR31212.

C4. Cable Management

D1. Terminals

## Panduit® Pan-Term® Terminal Military Cross Reference

	Current Mil. Std Part No., Class 1	Ring Terminals Nylon Insulated	Current Mil. Std. Part No., Class 2	Ring Terminals, Nylon Insulated or Nylon Insulated with Funnel Entry	Current Mil. Std. Part No., Class 1	Ring Terminals Non-Insulated
D2. Power Connectors	MS25036-101	PN18-6RN	MS25036-101	PN18-6RN or PNF18-6RN	MS20659-165	P10-6R
D3. Grounding Connectors	MS25036-102	PN18-6R	MS25036-102	PN18-6R or PNF18-6R	MS20659-105	P10-10R
	MS25036-103	PN18-10R	MS25036-103	PN18-10R or PNF18-10R	MS20659-106	P10-56R
	MS25036-104	PN18-56R	MS25036-104	PN18-56R or PNF18-56R	MS20659-128	P10-38R
	MS25036-105	PN18-38R	MS25036-105	PN18-38R or PNF18-38R		
E1. Labeling Systems	MS25036-106	PN14-6RN	MS25036-106	PN14-6RN or PNF14-6RN		
	MS25036-107	PN14-6R	MS25036-107	PN14-6R or PNF14-6R		
	MS25036-108	PN14-10R	MS25036-108	PN14-10R or PNF14-10R		
	MS25036-109	PN14-56R	MS25036-109	PN14-56R or PNF14-56R		
E2. Labels	MS25036-110	PN14-38R	MS25036-110	PN14-38R or PNF14-38R		
	MS25036-111	PN10-6R	MS25036-111	PN10-6R or PNF10-6R		
	MS25036-112	PN10-10R	MS25036-112	PN10-10R or PNF10-10R		
	MS25036-113	PN10-56R	MS25036-113	PN10-56R or PNF10-56R		
E3. Pre-Printed & Write-On Markers	MS25036-114	PN10-38R	MS25036-114	PN10-38R or PNF10-38R		
	MS25036-148	PN18-4RN	MS25036-148	PN18-4RN or PNF18-4RN		
	MS25036-149	PN18-8R	MS25036-149	PN18-8R or PNF18-8R		
E4. Permanent Identification	MS25036-150	PN18-14R	MS25036-150	PN18-14R or PNF18-14R		
	MS25036-152	PN14-4R	MS25036-152	PN14-4R or PNF14-4R		
	MS25036-153	PN14-8R	MS25036-153	PN14-8R or PNF14-8R		
E5. Lockout/Tagout & Safety Solutions	MS25036-154	PN14-14R	MS25036-154	PN14-14R or PNF14-14R		
	MS25036-156	PN10-8R	MS25036-156	PN10-8R or PNF10-8R		
	MS25036-157	PN10-14R	MS25036-157	PN10-14R or PNF10-14R		
F. Index	Crimping Tools: CT-400 and CT-460					



## Stud Size Chart (Inches/Millimeters)

										
Standard Stud Size	#2	#4	#5	#6	#8	#10	1/4"	5/16"	3/8"	7/16"
Metric Stud Size (mm)	M2	M2.5	M3	M.35	M4	M5	M6	M8	M10	M11
Stud Size Decimal Equivalent	.086"	.112"	.127"	.138"	.164"	.190"	.250"	.312"	.375"	.438"
Metric Diameter (mm)	2.18	2.84	3.18	3.51	4.17	4.83	6.35	7.92	9.53	11.13
Terminal Hole Diameter	.090"	.118"	.130"	.147"	.173"	.204"	.270"	.343"	.392** .406***	.456"
Terminal Hole Diameter Metric (mm)	2.29	3.0	3.23	3.71	4.39	5.18	6.86	8.71	9.78	11.58
Stud Size Designation in Panduit Part Number	2	4	5	6	8	10	14	56	38	76

\*Terminal stud.

\*\*Power Connector stud.

					
Standard Stud Size	1/2"	5/8"	3/4"	7/8"	1"
Metric Stud Size (mm)	M12	M16	M18	M20	M25
Stud Size Decimal Equivalent	.500"	.625"	.750"	.875"	1.00"
Metric Diameter (mm)	12.7	15.88	19.05	22.23	25.4
Terminal Hole Diameter	.531"	.656"	.810"	.906"	1.031"
Terminal Hole Diameter Metric (mm)	13.49	16.66	20.57	23.01	26.19
Stud Size Designation in Panduit Part Number	12	58	34	78	1

Note: Stud hole diagrams are for U.S. reference only.

A.  
System  
Overview

B1.  
Cable Ties

B2.  
Cable  
Accessories

B3.  
Stainless  
Steel Ties

C1.  
Wiring  
Duct

C2.  
Surface  
Raceway

C3.  
Abrasion  
Protection

C4.  
Cable  
Management

D1.  
Terminals

D2.  
Power  
Connectors

D3.  
Grounding  
Connectors

E1.  
Labeling  
Systems

E2.  
Labels

E3.  
Pre-Printed  
& Write-On  
Markers

E4.  
Permanent  
Identification

E5.  
Lockout/  
Tagout  
& Safety  
Solutions











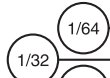



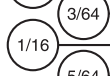
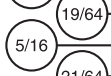
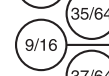
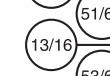

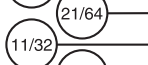
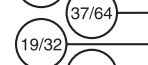
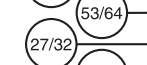

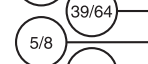
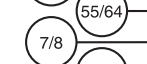

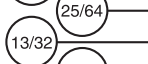
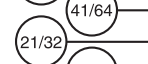
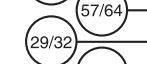
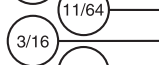

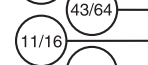
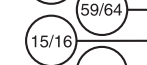
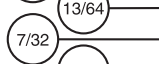

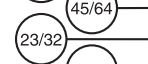
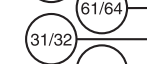
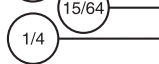
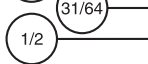

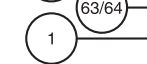



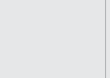
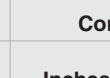
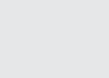
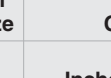

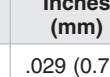

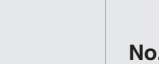
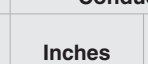
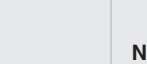
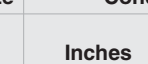

F.  
Index

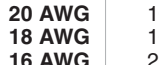
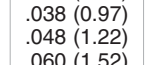
A.  
System  
Overview

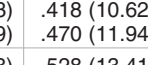
## Equivalent Tables

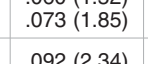
B1.  
Cable Ties

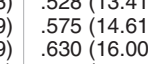
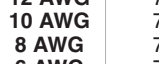
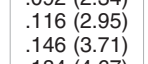
### Decimal/Inches/Millimeters

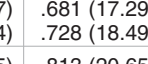
	.0156	0,396		.2656	6,746		.5156	13,100		.7656	19,446
	0.312	0,792		.2812	7,143		.5312	13,492		.7812	14,842
	.0468	1,189		.2968	7,541		.5468	13,891		.7968	20,241
	.0625	1,588		.3125	7,938		.5625	14,288		.8125	20,637
	.0781	1,984		.3281	8,337		.5781	14,684		.8281	21,034
	.0937	2,380		.3437	8,730		.5937	15,080		.8437	21,480
	.1093	2,779		.3593	9,129		.6093	15,479		.8593	21,828
	.125	3,175		.375	9,525		.625	15,875		.875	22,225
	.1406	3,571		.3906	9,921		.6406	16,271		.8906	22,620
	.1562	3,968		.4062	10,317		.6562	16,667		.9062	23,017
	.1718	4,366		.4218	10,716		.6718	17,066		.9218	23,416
	.1875	4,763		.4375	11,113		.6875	17,463		.9375	23,810
	.2031	5,159		.4531	11,509		.7031	17,859		.9531	24,208
	.2187	5,555		.4687	11,905		.7187	18,255		.9687	24,605
	.2343	5,954		.4843	12,304		.7343	18,654		.9843	25,001
	.25	6,350		.5	12,700		.75	19,050		1.	25,400

C4.  
Cable  
Management

### Common Conductor Size Chart (Stranded Wire)

Size	No. of Strands	Individual Strand Size		Conductor Size		Size	No. of Strands	Individual Strand Size		Conductor Size	
		Inches (mm)	Inches (mm)	Inches (mm)	Circle Mil Area (mm <sup>2</sup> )			Inches (mm)	Inches (mm)	Circle Mil Area (mm <sup>2</sup> )	
<b>22 AWG</b>	7	.0096 (0.24)	.029 (0.74)	640 (0.324)		<b>1/0 AWG</b>	19	.0745 (1.89)	.373 (9.47)	105,600 (0.823)	
<b>20 AWG</b>	10	.0100 (0.25)	.038 (0.97)	1020 (0.519)		<b>2/0 AWG</b>	19	.0837 (2.13)	.418 (10.62)	133,100 (67.43)	
<b>18 AWG</b>	16	.0100 (0.25)	.048 (1.22)	1620 (0.823)		<b>3/0 AWG</b>	19	.0940 (2.39)	.470 (11.94)	167,800 (85.01)	
<b>16 AWG</b>	26	.0100 (0.25)	.060 (1.52)	2580 (1.310)		<b>4/0 AWG</b>	19	.1055 (2.68)	.528 (13.41)	211,600 (107.2)	
<b>14 AWG</b>	7	.0242 (0.61)	.073 (1.85)	4110 (2.080)		<b>250 kcmil</b>	37	.0822 (2.09)	.575 (14.61)	250,000 (127)	
<b>12 AWG</b>	7	.0305 (0.77)	.092 (2.34)	6530 (3.310)		<b>300 kcmil</b>	37	.0900 (2.29)	.630 (16.00)	300,000 (152)	
<b>10 AWG</b>	7	.0385 (0.98)	.116 (2.95)	10,380 (5.261)		<b>350 kcmil</b>	37	.0973 (2.47)	.681 (17.29)	350,000 (177)	
<b>8 AWG</b>	7	.0486 (1.23)	.146 (3.71)	16,510 (8.367)		<b>400 kcmil</b>	37	.1040 (2.64)	.728 (18.49)	400,000 (203)	
<b>6 AWG</b>	7	.0612 (1.55)	.184 (4.67)	26,240 (13.30)		<b>500 kcmil</b>	37	.1162 (2.95)	.813 (20.65)	500,000 (253)	
<b>4 AWG</b>	7	.0772 (1.96)	.232 (5.89)	41,740 (21.15)		<b>600 kcmil</b>	61	.0992 (2.52)	.893 (22.68)	600,000 (304)	
<b>2 AWG</b>	7	.0974 (2.47)	.292 (7.42)	66,360 (33.62)		<b>750 kcmil</b>	61	.1109 (2.82)	.998 (25.35)	750,000 (380)	
<b>1 AWG</b>	19	.0664 (1.69)	.332 (8.43)	83,690 (42.41)		<b>800 kcmil</b>	61	.1145 (2.91)	1.031 (26.19)	800,000 (405)	
						<b>1000 kcmil</b>	61	.1280 (3.25)	1.152 (29.26)	1,000,000 (507)	

E2.  
Labels

E3.  
Pre-Printed  
& Write-On  
Markers

E4.  
Permanent  
Identification

E5.  
Lockout/  
Tagout  
& Safety  
Solutions

F.  
Index

## Common Conductor Sizes and Strandings Reference Chart

Conductor		Individual Strands		Overall Conductor Size			Conductor		Individual Strands		Overall Conductor Size				
		Diameter		Diameter		Area			Diameter		Diameter		Area		
AWG	Metric mm <sup>2</sup>	No.	mm	In.	mm	In.	Circ. MILS	AWG	Metric mm <sup>2</sup>	No.	mm	In.	mm	In.	Circ. MILS
	0.05	25	0.05	0.002	0.25	0.010	97		1.0	19	0.25	0.010	1.30	0.051	1841
	0.06	41	0.05	0.002	0.36	0.014	159			1	1.13	0.044	1.13	0.044	1979
26		10	0.13	0.005	0.53	0.021	250	16		32	0.20	0.008	1.30	0.051	1984
		1	0.41	0.016	0.41	0.016	256			7	0.43	0.017	1.30	0.051	2006
		7	0.16	0.006	0.48	0.019	278			19	0.29	0.011	1.47	0.058	2426
		19	0.10	0.004	0.51	0.020	304			65	0.16	0.006	1.50	0.059	2580
24		41	0.08	0.003	0.58	0.023	384	16		*26	0.25	0.010	1.50	0.059	2600
		10	0.16	0.006	0.58	0.023	397			1	1.30	0.051	1.30	0.051	2601
		1	0.51	0.020	0.51	0.020	400			105	0.13	0.005	1.50	0.059	2625
		7	0.20	0.008	0.61	0.024	448			*7	0.51	0.020	1.52	0.060	2828
	0.25	19	0.13	0.005	0.61	0.024	475	16		30	0.25	0.010	1.70	0.067	2906
		65	0.07	0.003	0.65	0.026	484			21	0.30	0.012	1.60	0.063	2930
		128	0.05	0.002	0.65	0.026	496			189	0.10	0.004	1.90	0.075	2930
		32	0.10	0.004	0.65	0.026	496			7	0.52	0.020	1.60	0.063	2934
22		14	0.16	0.006	0.65	0.026	556	14		1	1.38	0.054	1.38	0.054	2952
		1	0.64	0.025	0.64	0.025	625			45	0.16	0.006	1.85	0.073	3786
		16	0.16	0.006	0.76	0.03	635			19	0.38	0.014	1.85	0.073	3831
		26	0.13	0.005	0.76	0.03	650			1	1.63	0.064	1.63	0.064	4096
	0.38	7	0.25	0.010	0.76	0.030	700	14		*41	0.25	0.010	1.85	0.073	4100
		19	0.16	0.006	0.79	0.031	754			*7	0.64	0.025	1.85	0.073	4481
		48	0.10	0.004	0.80	0.031	744			50	0.25	0.010	2.20	0.087	4844
		194	0.05	0.002	0.8	0.031	752			7	0.67	0.026	2.10	0.083	4871
	0.5	100	0.07	0.003	0.8	0.031	760	12		35	0.30	0.012	2.20	0.087	4883
		7	0.27	0.011	0.8	0.031	791			315	0.10	0.004	2.20	0.087	4883
		12	0.21	0.008	0.8	0.031	820			1	1.78	0.070	1.78	0.070	4911
		21	0.16	0.006	0.8	0.031	833			19	0.45	0.018	2.36	0.093	6088
20		7	0.30	0.012	0.90	0.035	977	12		*65	0.25	0.010	2.41	0.095	6500
		16	0.20	0.008	0.90	0.035	992			165	0.16	0.006	2.41	0.095	6549
		1	0.80	0.031	0.80	0.031	992			1	2.06	0.081	2.06	0.081	6561
		*10	0.25	0.010	0.89	0.035	1000			*7	0.81	0.032	2.44	0.096	7168
	0.75	1	0.81	0.032	0.81	0.032	1024	10		56	0.30	0.012	3.10	0.122	7812
		41	0.13	0.005	0.91	0.036	1025			1	2.26	0.089	2.26	0.089	7917
		26	0.16	0.006	0.91	0.036	1032			511	0.10	0.004	3.00	0.118	7921
		*7	0.32	0.013	0.97	0.038	1111			19	0.52	0.020	2.70	0.106	7963
18		19	0.20	0.008	0.94	0.037	1216	10		37	0.40	0.016	2.92	0.115	9354
		7	0.37	0.015	1.10	0.043	1485			49	0.36	0.014	2.95	0.116	9880
		24	0.20	0.008	1.20	0.047	1488			*7	0.98	0.039	2.95	0.116	10376
		1	1.00	0.039	1.00	0.039	1550			1	2.59	0.102	2.59	0.102	10404
	0.75	*16	0.25	0.010	1.19	0.047	1600	10		*105	0.25	0.010	2.95	0.116	10500
		1	1.02	0.040	1.02	0.040	1600			84	0.30	0.012	3.50	0.138	11718
		65	0.13	0.005	1.19	0.047	1625			756	0.10	0.004	3.70	0.146	11718
		41	0.16	0.006	1.19	0.047	1627			1	2.76	0.109	2.76	0.109	11807
	0.75	*7	0.40	0.016	1.22	0.048	1770	6.0		7	1.05	0.041	3.20	0.126	11962
		19	0.25	0.010	1.24	0.049	1900			19	0.64	0.025	3.30	0.130	12063

\*Strandings required for UL and CSA certification testing.

This chart details the different conductors commonly used in the industry. For each size, either AWG or metric, various stranding options are listed. Typically the higher stranding is used in applications requiring greater conductor flexibility.

AWG to Metric Wire Crosses	
AWG	Metric (mm <sup>2</sup> )
26 – 22	0.1 – 0.5
22 – 18	0.5 – 1.0
16 – 14	1.5 – 2.5
12 – 10	4.0 – 6.0

(continued on page D1.100)

A. System Overview

B1. Cable Ties

B2. Cable Accessories

B3. Stainless Steel Ties

C1. Wiring Duct

C2. Surface Raceway

C3. Abrasion Protection

C4. Cable Management

D1. Terminals

D2. Power Connectors

D3. Grounding Connectors

E1. Labeling Systems

E2. Labels

E3. Pre-Printed & Write-On Markers

E4. Permanent Identification

E5. Lockout/Tagout & Safety Solutions

F. Index

## Common Conductor Sizes and Strandings Reference Chart (continued)

Conductor		Individual Strands			Overall Conductor Size			Conductor		Individual Strands			Overall Conductor Size		
		Diameter		Diameter	Diameter		Area			Diameter		Diameter		Area	
AWG	Metric mm <sup>2</sup>	No.	mm	In.	mm	In.	Circ. MILS	AWG	Metric mm <sup>2</sup>	No.	mm	In.	mm	In.	Circ. MILS
	6	7	0.107	0.042	3.21	0.126	11840		95	19	2.57	0.101	12.8	0.505	187500
		1	2.77	0.109	2.77	0.109	11840			37	1.83	0.072	12.5	0.504	187500
9		7	1.1	0.0432	3.3	0.13	13000	4/0		19	2.89	0.1055	13.4	0.528	211600
		1	2.91	0.1144	2.91	0.114	13090			120	37	2.06	0.081	14.4	0.567
8		1	3.26	0.1285	3.25	0.128	16510	250 kcmil		37	2.07	0.0822	14.6	0.575	250 kcmil
		7	1.23	0.0486	3.7	0.146	16510			300 kcmil	150	37	2.29	0.09	16
	10	7	1.37	0.054	4.12	0.162	19740	350 kcmil		37	2.47	0.0973	17.3	0.681	350 kcmil
		1	3.58	0.141	3.58	0.141	19740			185	37	2.54	0.1	17.8	0.7
7		7	1.38	0.0545	4.15	0.164	20520	400 kcmil		37	2.64	0.104	18.5	0.728	400 kcmil
		1	3.67	0.1443	3.67	0.144	20520			240	37	2.9	0.114	20.3	0.798
6		7	1.55	0.0612	4.66	0.184	26240			61	2.26	0.089	20.3	0.801	473.6 kcmil
		1	4.11	0.162	4.11	0.162	26240			500 kcmil	37	2.95	0.1162	20.7	0.813
	16	7	1.73	0.008	5.13	0.204	31580			61	2.3	0.0905	20.7	0.814	500 kcmil
5		7	1.75	0.0688	5.24	0.206	33090		300 kcmil	61	2.51	0.099	22.6	0.891	592.1 kcmil
4		7	1.96	0.0772	5.88	0.232	41740	600 kcmil		61	2.52	0.0992	22.7	0.893	600 kcmil
	25	7	2.16	0.085	6.48	0.255	49340	700 kcmil		61	2.72	0.1071	24.5	0.964	700 kcmil
		19	1.32	0.052	6.6	0.26	49340	750 kcmil		61	2.82	0.1109	25.4	0.998	750 kcmil
3		7	2.2	0.0867	6.61	0.26	52620			91	2.31	0.0908	25.4	0.998	750 kcmil
2		7	2.47	0.0974	7.42	0.292	66300		400	61	2.9	0.114	26.1	1.026	798.4 kcmil
	35	7	2.54	0.1	7.62	0.300	69070	800 kcmil		61	2.91	0.1145	26.2	1.031	800 kcmil
		19	1.55	0.001	7.75	0.305	69070			91	2.38	0.0938	26.2	1.032	800 kcmil
1		19	1.5	0.0064	8.43	0.332	83690	1000 kcmil	500	61	3.25	0.128	28.3	1.152	986.8 kcmil
	50	19	1.85	0.073	9.27	0.365	98680			91	2.66	0.1048	29.3	1.153	1000 kcmil
1/0		19	1.59	0.0745	9.46	0.373	10500		625	91	2.97	0.117	32.7	1.287	1233.7 kcmil
2/0		19	2.13	0.0837	10.6	0.419	133100								
	70	19	2.18	0.086	10.9	0.43	138100								
3/0		19	2.59	0.094	11.9	0.47	167800								
		36	1.71	0.0673	12	0.471	167800								

This chart details the different conductors commonly used in the industry. For each size, either AWG or metric, various stranding options are listed. Typically the higher stranding is used in applications requiring greater conductor flexibility.

AWG to Metric Wire Crosses	
AWG	Metric (mm <sup>2</sup> )
<b>26 – 22</b>	<b>0.1 – 0.5</b>
<b>22 – 18</b>	<b>0.5 – 1.0</b>
<b>16 – 14</b>	<b>1.5 – 2.5</b>
<b>12 – 10</b>	<b>4.0 – 6.0</b>

## REEL SMART™ SYSTEM



The Panduit® Reel Smart™ System provides the best solution for quality, high volume terminations designed to dramatically reduce set-up time and production downtime. This increased efficiency translates into real cost savings throughout the termination process from start to finish.



- One applicator system terminates over 400 continuously molded terminals, reducing cost of ownership
- Continuously molded integrated carrier guarantees alignment of terminal; front to back and side to side to eliminate skewing of product resulting in consistent, high quality low cost termination
- Available in large reels requiring less product changeover, resulting in less downtime
- Applicable sizes are UL Listed and CSA Certified, as noted
- Panduit® CA9 Ezair™ Universal Applicator works with Reel Smart™ Reel-Fed Terminals to deliver the ultimate fully automatic, high-capacity termination performance
- Panduit reel fed strip ferrules combine with tooling options to support wire harness, control panel, and automatic wire processing applications

Panduit continually provides new designs with innovative features to meet the application challenges encountered by customers, while providing the lowest installed cost.

A.  
System  
Overview

B1.  
Cable Ties

B2.  
Cable  
Accessories

B3.  
Stainless  
Steel Ties

C1.  
Wiring  
Duct

C2.  
Surface  
Raceway

C3.  
Abrasion  
Protection

C4.  
Cable  
Management

D1.  
Terminals

D2.  
Power  
Connectors

D3.  
Grounding  
Connectors

E1.  
Labeling  
Systems

E2.  
Labels

E3.  
Pre-Printed  
& Write-On  
Markers

E4.  
Permanent  
Identification

E5.  
Lockout/  
Tagout  
& Safety  
Solutions

F.  
Index

A. System Overview
B1. Cable Ties
B2. Cable Accessories
B3. Stainless Steel Ties
C1. Wiring Duct
C2. Surface Raceway
C3. Abrasion Protection
C4. Cable Management
D1. Terminals
D2. Power Connectors
D3. Grounding Connectors
E1. Labeling Systems
E2. Labels
E3. Pre-Printed & Write-On Markers
E4. Permanent Identification
E5. Lockout/Tagout & Safety Solutions
F. Index

## Features and Benefits – Reel Smart™ Termination System

The Panduit continuously molded Reel Smart™ products are designed such that the terminal, disconnect, and butt splice housings are connected by an integral molded carrier in the barrel crimp zone, producing a continuous length of product. Plated metal terminals, disconnects, and splices are then assembled into the housings. During termination, the continuously molded components are fed into a universal applicator. This process produces a reel-fed solution that eliminates a variety of problems associated with other reel-fed designs and provides high quality, high capacity product on reels for longer, uninterrupted production runs – resulting in the lowest installed cost.

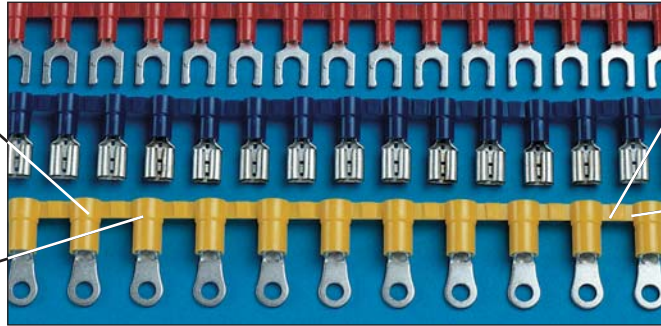

Pre-insulated design eliminates the need for post-insulation – resulting in labor savings

Continuously molded design always aligns product with the carrier strip – resulting in trouble free tool operation

Plastic carrier strip eliminates sharp, unplated edges as found on metal strip-fed carriers – providing better corrosion resistance

Barrel position is controlled for consistent wire feed targeting to deliver high process capability

## Reel Smart™ CA9 Ezair™ Universal Applicator

The Panduit® CA9 Ezair™ applicator automatically adjusts feed stroke to the correct pitch and length for the entire product line of continuously molded products. The need for multiple applicators is eliminated. The applicator, in conjunction with the precision, continuously molded product provides perfect front-to-back and side-to-side alignment in the die pocket for a high quality termination every time – resulting in the most optimum system to terminate terminals.

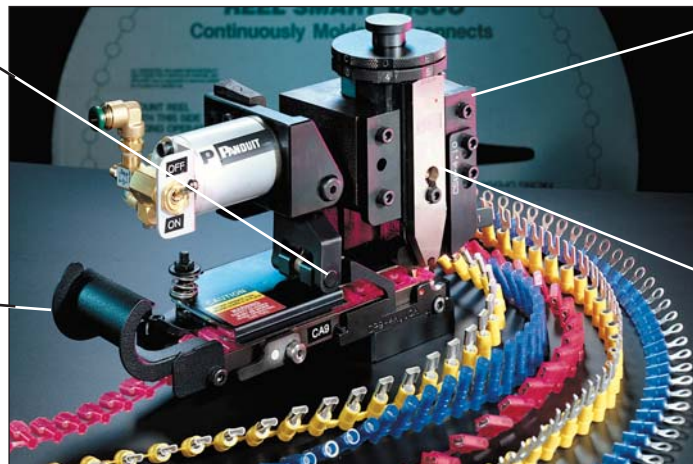

Automatic, self-adjusting feed stroke – resulting in correct pitch and length

Universal applicator installs Reel Smart™ product line – resulting in lower tooling inventory costs

Versatile applicator design – allows for installation in bench presses, and most automatic wire processing systems of 3rd party manufacturers

Quick change dies – provide fast product change-over and reduction in set-up time

## Nylon Insulated Terminals with Insulation Grip Sleeve (Funnel and Non-Funnel Entry Types)

The three-piece design terminal provides a permanently attached tin plated brass sleeve for insulation grip in funnel and straight entry sleeve designs. This product feature offers the most reliable terminations. Nylon insulation is rated up to 600 V maximum and designed for up to 221°F (105°C) operating temperature maximum. Supplied on rings, forks, locking forks, short locking forks and flanged forks in wire sizes #22 through #10.



- Sleeved barrel – assures crimp reliability
- PNF – funnel entry styles available
- Metal insulation crimp – provides DOUBLE CRIMP wire insulation grip sleeve for high vibration and to meet conductor strain environments

- Internal wire barrel serrations – provides increased wire contact and maximum tensile strength
- Product markings – UL and CSA rated – up to 600 V, maximum operating temperature 221°F (105°C)

## Part Number System for Reel Smart™ Terminals

<b>P</b>	<b>NF</b>	<b>14</b>	<b>6</b>	<b>R</b>	<b>N</b>	<b>3K</b>
Type	Insulation	Wire Range	Stud Size	Tongue Configuration	Special Configuration	Std. Pkg. Size
P = Terminal BS = Butt Splice	N = Nylon Insulated NF = Nylon Insulated Funnel Entry V = Vinyl Insulated	18 = #22 – 18 14 = #16 – 14 12 = #16 – 12 10 = #12 – 10	4 = #4 5 = #5 6 = #6 8 = #8 10 = #10 14 = 1/4" 56 = 5/16" 38 = 3/8"	R = Ring HDR = Heavy Duty Ring F = Fork FF = Fanged Fork LF = Locking Fork SLF = Short Locking Fork	N = Narrow Tongue W = Wide Tongue B = Butted Seam = Standard (leave blank)	2K = 2,000 pcs. 3K = 3,000 pcs.



### Ring Terminals, Nylon Insulated – Non-Funnel Entry

#### Type PN-R

- Continuously molded design provides reliable, consistent performance through the applicator for a high quality termination every time
- Ring tongue design assures a secure connection in high vibration applications
- Metal insulation grip sleeve crimps to wire insulation, providing protection to the crimp joint during high vibration applications

- Internal barrel serrations assure good wire contact and maximum tensile strength
- UL Flammability UL 94V-2/HB, maximum insulation temperature 221°F (105°C)
- UL and CSA rated up to 600 V per UL 486A/B



Part Number	Wire Range	Color Code	Stock Thickness (In.)	Max. Ins. (In.)	Stud Size	Figure Dimension (In.)			CA9 Series Crimp Die	CA-800/EZ Series Crimp Die	Pieces Per Reel
						L	W	C			
PN18-4R-3K	22 – 18 AWG	Red	0.03	0.145	#4	0.80	0.25	0.22	CD9-1A	CD-800-1	3000
PN18-6RN-3K					#6	0.74	0.22	0.18			3000
PN18-6R-3K					#6	0.78	0.25	0.22			3000
PN18-8R-3K					#8	0.86	0.31	0.25			3000
PN18-10R-3K					#10	0.86	0.31	0.25			3000
PN18-14R-3K					1/4"	1.05	0.45	0.38			3000
PN14-4R-3K	16 – 14 AWG	Blue	0.03	0.162	#4	0.76	0.25	0.22	CD9-2A	CD-800-2	3000
PN14-6RN-3K					#6	0.76	0.25	0.22			3000
PN14-6R-3K					#6	0.86	0.31	0.25			3000
PN14-8R-3K					#8	0.86	0.31	0.25			3000
PN14-10R-3K					#10	0.86	0.31	0.25			3000
PN14-14R-3K					1/4"	1.06	0.44	0.38			3000
PN10-6R-2K	12 – 10 AWG	Yellow	0.04	0.225	#6	1.06	0.38	0.31	CD9-3B	CD-800-3	2000
PN10-8R-2K					#8	1.06	0.38	0.31			2000
PN10-10R-2K					#10	1.06	0.38	0.31			2000
PN10-14R-2K					1/4"	1.21	0.52	0.38			2000
PN10-56R-2K					5/16"	1.21	0.52	0.38			2000
PN10-38R-2K					3/8"	1.29	0.58	0.43			2000

For applicator information, see page D1.143.

A. System Overview



## Ring Terminals, Nylon Insulated – Funnel Entry

B1. Cable Ties

### Type PNF-R

- Continuously molded design provides reliable, consistent performance through the applicator for a high quality termination every time

B2. Cable Accessories

- Ring tongue design assures a secure connection in high vibration applications

B3. Stainless Steel Ties

- Metal insulation grip sleeve crimps to wire insulation, providing protection to the crimp joint during high vibration applications

- Internal barrel serrations assure good wire contact and maximum tensile strength

- UL Flammability UL 94V-2/HB, maximum insulation temperature 221°F (105°C)

- UL and CSA rated up to 600 V per UL 486A/B

C1. Wiring Duct



C2. Surface Raceway

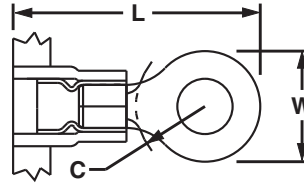

C3. Abrasion Protection

C4. Cable Management

Part Number	Wire Range	Color Code	Stock Thickness (In.)	Max. Ins. (In.)	Stud Size	Figure Dimensions (In.)			CA9 Series Crimp Die	CA-800/EZ Series Crimp Die	Pieces Per Reel
						L	W	C			
<b>PNF18-4RN-3K</b>	22 – 18 AWG	Red	0.03	0.145	#4	0.74	0.22	0.19	CD9-1A	CD-800-1	3000
<b>PNF18-4R-3K</b>					#4	0.78	0.25	0.21			3000
<b>PNF18-6RN-3K</b>					#6	0.74	0.22	0.16			3000
<b>PNF18-6R-3K</b>					#6	0.78	0.25	0.21			3000
<b>PNF18-8R-3K</b>					#8	0.86	0.31	0.25			3000
<b>PNF18-10R-3K</b>					#10	0.86	0.31	0.25			3000
<b>PNF18-14R-3K</b>					1/4"	1.06	0.46	0.38			3000
<b>PNF14-4R-3K</b>	16 – 14 AWG	Blue	0.03	0.162	#4	0.78	0.25	0.18	CD9-2A	CD-800-2	3000
<b>PNF14-6RN-3K</b>					#6	0.78	0.25	0.18			3000
<b>PNF14-6R-3K</b>					#6	0.87	0.31	0.24			3000
<b>PNF14-8R-3K</b>					#8	0.87	0.31	0.25			3000
<b>PNF14-10R-3K</b>					#10	0.85	0.31	0.29			3000
<b>PNF14-14R-3K</b>					1/4"	1.06	0.46	0.40			3000
<b>PNF10-6R-2K</b>	12 – 10 AWG	Yellow	0.04	0.225	#6	1.06	0.38	0.31	CD9-3B	CD-800-3	2000
<b>PNF10-8R-2K</b>					#8	1.06	0.38	0.31			2000
<b>PNF10-10R-2K</b>					#10	1.06	0.38	0.31			2000
<b>PNF10-14R-2K</b>					1/4"	1.21	0.52	0.38			2000
<b>PNF10-56R-2K</b>					5/16"	1.21	0.52	0.38			2000
<b>PNF10-38R-2K</b>					3/8"	1.29	0.58	0.43			2000

For applicator information, see page D1.143.

E1. Labeling Systems

E2. Labels

E3. Pre-Printed & Write-On Markers

E4. Permanent Identification

E5. Lockout/Tagout & Safety Solutions

F. Index





## Ring Terminals, Vinyl Insulated – Funnel Entry

### Type PV-RB

- Continuously molded design provides reliable, consistent performance through the applicator for a high quality termination every time
- Ring tongue design assures a secure connection in high vibration applications



- Insulation support helps to prevent wire damage in bending applications
- UL Flammability UL 94V-0, maximum insulation temperature 221°F (105°C)
- UL and CSA rated up to 600 V per UL 486A/B

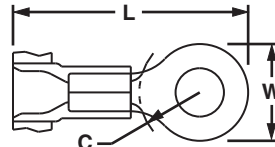

Part Number	Wire Range	Color Code	Stock Thickness (In.)	Max. Ins. (In.)	Stud Size	Figure Dimensions (In.)			CA9 Series Crimp Die	CA-800/EZ Series Crimp Die	Pieces Per Reel						
						L	W	C									
PV18-4RNB-3K	22 – 18 AWG	Red	0.03	0.150	#4	0.74	0.21	0.19	CD9-1A	CD-800-1	3000						
PV18-4RB-3K					#4	0.78	0.25	0.20			3000						
PV18-6RNB-3K					#6	0.75	0.23	0.19			3000						
PV18-6RB-3K					#6	0.78	0.25	0.20			3000						
PV18-8RB-3K					#8	0.86	0.31	0.25			3000						
PV18-10RB-3K					#10	0.86	0.31	0.25			3000						
PV18-14RB-3K					1/4"	1.06	0.45	0.38			3000						
PV18-56RB-2K					5/16"	1.06	0.46	0.38			2000						
PV18-38RB-2K					3/8"	1.15	0.53	0.43			2000						
PV14-4RB-3K					16 – 14 AWG	Blue	0.03	0.170			#4	0.76	0.25	0.22	CD9-2A	CD-800-2	3000
PV14-6RNB-3K	#6	0.76	0.25	0.22					3000								
PV14-6RB-3K	#6	0.86	0.31	0.25					3000								
PV14-8RB-3K	#8	0.86	0.31	0.25					3000								
PV14-10RB-3K	#10	0.86	0.31	0.25					3000								
PV14-14RB-3K	1/4"	1.05	0.45	0.38					3000								
PV14-56RB-2K	5/16"	1.06	0.46	0.38					2000								
PV14-38RB-2K	3/8"	1.15	0.53	0.43					2000								
PV10-6RB-2K	12 – 10 AWG	Yellow	0.04	0.225					#6	1.02	0.31	0.31	CD9-3B	CD-800-3			2000
PV10-8RB-2K									#8	1.02	0.31	0.31					2000
PV10-10RB-2K					#10	1.02	0.31	0.31	2000								
PV10-14RB-2K					1/4"	1.20	0.52	0.38	2000								
PV10-56RB-2K					5/16"	1.20	0.52	0.38	2000								
PV10-38RB-2K					3/8"	1.23	0.58	0.38	2000								

For applicator information, see page D1.143.



## Multiple Stud Ring Terminals, Vinyl Insulated – Funnel Entry

### Type PV-610RB

- Continuously molded design provides reliable, consistent performance through the applicator for a high quality termination every time
- Teardrop shaped mounting hole of multiple stud terminals permits use with #6, #8, or #10 size studs
- Ring tongue design assures a secure connection in high vibration applications



- Insulation support helps to prevent wire damage in bending applications
- UL Flammability UL 94V-0, maximum insulation temperature 221°F (105°C)
- UL and CSA rated up to 600 V per UL 486A/B

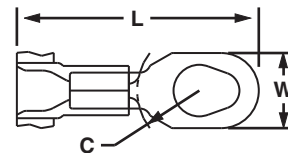

Part Number	Wire Range	Color Code	Stock Thickness (In.)	Max. Ins. (In.)	Stud Size	Figure Dimensions (In.)			CA9 Series Crimp Die	CA-800/EZ Series Crimp Die	Pieces Per Reel
						L	W	C			
PV18-610RB-3K	22 – 18 AWG	Red	0.03	0.150	#6, #8, #10	0.95	0.31	0.25	CD9-1A	CD-800-1	3000
PV14-610RB-3K	16 – 14 AWG	Blue	0.03	0.170		0.95	0.31	0.25	CD9-2A	CD-800-2	3000
PV10-610RB-2K	12 – 10 AWG	Yellow	0.04	0.225		1.17	0.37	0.31	CD9-3B	CD-800-3	2000

For applicator information, see page D1.143.

A. System Overview

B1. Cable Ties

B2. Cable Accessories

B3. Stainless Steel Ties

C1. Wiring Duct

C2. Surface Raceway

C3. Abrasion Protection

C4. Cable Management

D1. Terminals

D2. Power Connectors

D3. Grounding Connectors

E1. Labeling Systems

E2. Labels

E3. Pre-Printed & Write-On Markers

E4. Permanent Identification

E5. Lockout/Tagout & Safety Solutions

F. Index

A. System Overview



## Ring Terminals, Nylon Insulated – Heavy Duty

B1. Cable Ties

### Type PN-HDR

B2. Cable Accessories

B3. Stainless Steel Ties

C1. Wiring Duct

C2. Surface Raceway

C3. Abrasion Protection

C4. Cable Management

- Continuously molded design provides reliable, consistent performance through the applicator for a high quality termination every time
- Manufactured from stock 56% thicker than a standard #16 – 14 AWG terminal for use in heavy duty application
- Ring tongue design assures a secure connection in high vibration applications

- Metal insulation grip sleeve crimps to wire insulation, providing protection to the crimp joint during high vibration applications
- Internal barrel serrations assure good wire contact and maximum tensile strength
- UL Flammability UL 94V-2/HB, maximum insulation temperature 221°F (105°C)
- UL and CSA rated up to 600 V per UL 486A/B

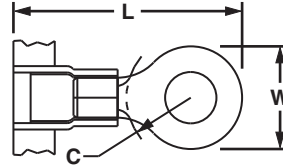

Part Number	Wire Range	Color Code	Stock Thickness (In.)	Max. Ins. (In.)	Stud Size	Figure Dimensions (In.)			CA9 Series Crimp Die	CA-800/EZ Series Crimp Die	Pieces Per Reel
						L	W	C			
PN12-6HDR-2K	16 – 12 AWG	Yellow	0.05	0.225	#6	1.02	0.31	0.31	CD9-3B	CD-800-3	2000
PN12-8HDR-2K					#8	1.02	0.31	0.31			2000
PN12-10HDR-2K					#10	1.05	0.38	0.31			2000
PN12-14HDR-2K					1/4"	1.20	0.52	0.38			2000
PN12-56HDR-2K					5/16"	1.20	0.52	0.38			2000
PN12-38HDR-2K					3/8"	1.28	0.58	0.38			2000

For applicator information, see page D1.143.

D1. Terminals



## Ring Terminals, Vinyl Insulated – Heavy Duty

D2. Power Connectors

### Type PV-HDRB

D3. Grounding Connectors

- Continuously molded design provides reliable, consistent performance through the applicator for a high quality termination every time
- Manufactured from stock 56% thicker than a standard #16 – 14 AWG terminal for use in heavy-duty applications
- Ring tongue design assures a secure connection in high vibration applications

- Insulation support helps to prevent wire damage in bending applications
- UL Flammability UL 94V-0, maximum insulation temperature 221°F (105°C)
- UL and CSA rated up to 600 V per UL 486A/B

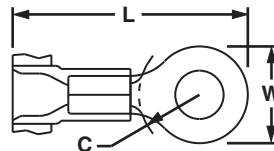

E3. Pre-Printed & Write-On Markers

Part Number	Wire Range	Color Code	Stock Thickness (In.)	Max. Ins. (In.)	Stud Size	Figure Dimensions (In.)			CA9 Series Crimp Die	CA-800/EZ Series Crimp Die	Pieces Per Reel
						L	W	C			
PV12-6HDRB-2K	16 – 12 AWG	Yellow	0.05	0.225	#6	1.03	0.31	0.36	CD9-3B	CD-800-3	2000
PV12-8HDRB-2K					#8	1.03	0.31	0.36			2000
PV12-10HDRB-2K					#10	1.06	0.37	0.36			2000
PV12-14HDRB-2K					1/4"	1.23	0.52	0.43			2000
<b>PV12-56HDRB-2K</b>					5/16"	1.23	0.52	0.43			2000
PV12-38HDRB-2K					3/8"	1.30	0.58	0.48			2000

For applicator information, see page D1.143.

F. Index



## Fork Terminals, Nylon Insulated – Non-Funnel Entry

### Type PN-F

- Continuously molded design provides reliable, consistent performance through the applicator for a high quality termination every time
- Fork design provides for fast and easy installation, without the need to remove fastener
- Metal insulation grip sleeve crimps to wire insulation, providing protection to the crimp joint during high vibration applications

- Internal barrel serrations assure good wire contact and maximum tensile strength
- UL Flammability UL 94V-2/HB, maximum insulation temperature 221°F (105°C)
- UL and CSA rated up to 600 V per UL 486A/B



Part Number	Wire Range	Color Code	Stock Thickness (In.)	Max. Ins. (In.)	Stud Size	Figure Dimensions (In.)			CA9 Series Crimp Die	CA-800/EZ Series Crimp Die	Pieces Per Reel
						L	W	C			
PN18-6FN-3K	22 – 18 AWG	Red	0.03	0.145	#6	0.78	0.25	0.20	CD9-1A	CD-800-1	3000
PN18-6F-3K					#6	0.78	0.30	0.20			3000
PN18-8F-3K					#8	0.84	0.32	0.23			3000
PN18-10FN-3K					#10	0.86	0.31	0.25			3000
PN18-10F-3K					#10	0.86	0.35	0.25			3000
PN18-14F-3K					1/4"	1.03	0.44	0.33			3000
PN14-6FN-3K	16 – 14 AWG	Blue	0.03	0.162	#6	0.78	0.24	0.19	CD9-2A	CD-800-2	3000
PN14-6F-3K					#6	0.78	0.28	0.19			3000
PN14-8F-3K					#8	0.84	0.31	0.23			3000
PN14-10FN-3K					#10	0.86	0.31	0.24			3000
PN14-10F-3K					#10	0.86	0.34	0.24			3000
PN14-14F-3K					1/4"	1.03	0.44	0.32			3000
PN10-6F-2K	12 – 10 AWG	Yellow	0.04	0.225	#6	1.00	0.31	0.24	CD9-3B	CD-800-3	2000
PN10-8F-2K					#8	1.03	0.37	0.24			2000
PN10-10F-2K					#10	1.04	0.37	0.24			2000
PN10-14F-2K					1/4"	1.14	0.49	0.32			2000

For applicator information, see page D1.143.

A. System Overview

B1. Cable Ties

B2. Cable Accessories

B3. Stainless Steel Ties

C1. Wiring Duct

C2. Surface Raceway

C3. Abrasion Protection

C4. Cable Management

D1. Terminals

D2. Power Connectors

D3. Grounding Connectors

E1. Labeling Systems

E2. Labels

E3. Pre-Printed & Write-On Markers

E4. Permanent Identification

E5. Lockout/Tagout & Safety Solutions

F. Index

A. System Overview



## Fork Terminals, Nylon Insulated – Funnel Entry

B1. Cable Ties

### Type PNF-F

- Continuously molded design provides reliable, consistent performance through the applicator for a high quality termination every time
- Fork design provides for fast and easy installation, without the need to remove fastener
- Metal insulation grip sleeve crimps to wire insulation, providing protection to the crimp joint during high vibration applications

- Internal barrel serrations assure good wire contact and maximum tensile strength
- UL Flammability UL 94V-2/HB, maximum insulation temperature 221°F (105°C)
- UL and CSA rated up to 600 V per UL 486A/B

B2. Cable Accessories

B3. Stainless Steel Ties

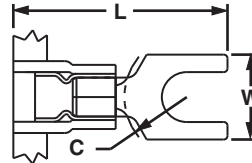

C1. Wiring Duct

C2. Surface Raceway

C3. Abrasion Protection

C4. Cable Management

D1. Terminals

D2. Power Connectors

D3. Grounding Connectors

E1. Labeling Systems

E2. Labels

E3. Pre-Printed & Write-On Markers

E4. Permanent Identification

E5. Lockout/Tagout & Safety Solutions

F. Index

Part Number	Wire Range	Color Code	Stock Thickness (In.)	Max. Ins. (In.)	Stud Size	Figure Dimensions (In.)			CA9 Series Crimp Die	CA-800/EZ Series Crimp Die	Pieces Per Reel
						L	W	C			
<b>PNF18-6F-3K</b>	22 – 18 AWG	Red	0.03	0.145	#6	0.77	0.24	0.19	CD9-1A	CD-800-1	3000
<b>PNF18-6FN-3K</b>					#6	0.78	0.30	0.19			3000
<b>PNF18-8F-3K</b>					#8	0.83	0.32	0.22			3000
<b>PNF18-10F-3K</b>					#10	0.85	0.35	0.24			3000
<b>PNF18-14F-3K</b>					1/4"	1.02	0.44	0.33			3000
<b>PNF14-6FN-3K*</b>	16 – 14 AWG	Blue	0.03	0.162	#6	0.78	0.24	0.19	CD9-2A	CD-800-2	3000
<b>PNF14-6F-3K</b>					#6	0.78	0.28	0.19			3000
<b>PNF14-8F-3K</b>					#8	0.84	0.31	0.23			3000
<b>PNF14-10F-3K</b>					#10	0.86	0.34	0.24			3000
<b>PNF14-14F-3K</b>					1/4"	1.03	0.44	0.32			3000
<b>PNF10-6F-2K</b>	12 – 10 AWG	Yellow	0.04	0.225	#6	1.01	0.31	0.24	CD9-3B	CD-800-3	2000
<b>PNF10-8F-2K</b>					#8	1.02	0.37	0.24			2000
<b>PNF10-14F-2K</b>					1/4"	1.13	0.49	0.32			2000

\*Not UL Listed or CSA Certified.  
For applicator information, see page D1.143.



## Fork Terminals, Vinyl Insulated – Funnel Entry

### Type PV-FB

- Continuously molded design provides reliable, consistent performance through the applicator for a high quality termination every time
- Fork design provides for fast and easy installation, without the need to remove fastener

- Insulation support helps to prevent wire damage in bending applications
- UL Flammability UL 94V-0, maximum insulation temperature 221°F (105°C)
- UL and CSA rated up 600 V per UL 486A/B

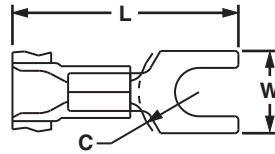

Part Number	Wire Range	Color Code	Stock Thickness (In.)	Max. Ins. (In.)	Stud Size	Figure Dimensions (In.)			CA9 Series Crimp Die	CA-800/EZ Series Crimp Die	Pieces Per Reel
						L	W	C			
<b>PV18-6FB-3K</b>	22 – 18 AWG	Red	0.03	0.150	#6	0.78	0.25	0.20	CD9-1A	CD-800-1	3000
<b>PV18-6FNB-3K</b>					#6	0.78	0.30	0.20			3000
<b>PV18-8FB-3K</b>					#8	0.84	0.32	0.23			3000
<b>PV18-10FB-3K</b>					#10	0.86	0.35	0.25			3000
<b>PV18-14FB-3K</b>					1/4"	1.03	0.44	0.33			3000
<b>PV14-6FB-3K</b>	16 – 14 AWG	Blue	0.03	0.170	#6	0.78	0.24	0.19	CD9-2A	CD-800-2	3000
<b>PV14-6FNB-3K*</b>					#6	0.78	0.28	0.19			3000
<b>PV14-8FB-3K</b>					#8	0.84	0.31	0.23			3000
<b>PV14-10FB-3K</b>					#10	0.86	0.31	0.24			3000
<b>PV14-10FNB-3K*</b>					#10	0.86	0.34	0.24			3000
<b>PV14-14FB-3K</b>	1/4"	1.03	0.44	0.32	3000						
<b>PV10-6FB-2K</b>	12 – 10 AWG	Yellow	0.04	0.225	#6	0.99	0.31	0.22	CD9-3B	CD-800-3	2000
<b>PV10-8FB-2K</b>					#8	1.00	0.38	0.22			2000
<b>PV10-10FB-2K</b>					#10	1.04	0.38	0.22			2000
<b>PV10-14FB-2K</b>					1/4"	1.13	0.49	0.32			2000

\*CSA Certified only.  
For applicator information, see page D1.143.

A. System Overview

B1. Cable Ties

B2. Cable Accessories

B3. Stainless Steel Ties

C1. Wiring Duct

C2. Surface Raceway

C3. Abrasion Protection

C4. Cable Management

D1. Terminals

D2. Power Connectors

D3. Grounding Connectors

E1. Labeling Systems

E2. Labels

E3. Pre-Printed & Write-On Markers

E4. Permanent Identification

E5. Lockout/Tagout & Safety Solutions

F. Index

A. System Overview



## Locking Fork Terminals, Nylon Insulated – Non-Funnel Entry

### Type PN-LF

B1. Cable Ties

B2. Cable Accessories

B3. Stainless Steel Ties

C1. Wiring Duct



- Continuously molded design provides reliable, consistent performance through the applicator for a high quality termination every time
- Snap in place for secure connection
- Fork design provides for fast and easy installation, without the need to remove fastener
- Metal insulation grip sleeve crimps to wire insulation, providing protection to the crimp joint during high vibration applications
- Internal barrel serrations assure good wire contact and maximum tensile strength
- UL Flammability UL 94V-2/HB, maximum insulation temperature 221°F (105°C)
- UL and CSA rated up to 600 V per UL 486A/B

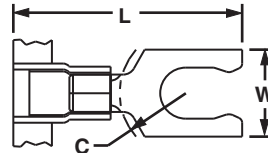

C2. Surface Raceway

C3. Abrasion Protection

C4. Cable Management

Part Number	Wire Range	Color Code	Stock Thickness (In.)	Max. Ins. (In.)	Stud Size	Figure Dimensions (In.)			CA9 Series Crimp Die	CA-800/EZ Series Crimp Die	Pieces Per Reel
						L	W	C			
PN18-6LF-3K	22 – 18 AWG	Red	0.03	0.145	#6	0.82	0.27	0.19	CD9-1A	CD-800-1	3000
PN18-8LF-3K					#8	0.89	0.29	0.23			3000
PN18-10LF-3K					#10	0.89	0.33	0.23			3000
PN14-6LF-3K	16 – 14 AWG	Blue	0.03	0.162	#6	0.85	0.25	0.18	CD9-2A	CD-800-2	3000
PN14-8LF-3K					#8	0.92	0.29	0.23			3000
PN14-10LF-3K					#10	0.92	0.33	0.23			3000
PN10-6LF-2K	12 – 10 AWG	Yellow	0.04	0.225	#6	1.02	0.30	0.21	CD9-3B	CD-800-3	2000
PN10-8LF-2K					#8	1.05	0.30	0.21			2000
PN10-10LF-2K					#10	1.05	0.34	0.21			2000

For applicator information, see page D1.143.

D1. Terminals



## Locking Fork Terminals, Nylon Insulated – Funnel Entry

### Type PNF-LF

D2. Power Connectors

D3. Grounding Connectors

E1. Labeling Systems

E2. Labels

E3. Pre-Printed & Write-On Markers

E4. Permanent Identification

E5. Lockout/Tagout & Safety Solutions

F. Index



- Continuously molded design provides reliable, consistent performance through the applicator for a high quality termination every time
- Snap in place for secure connection
- Fork design provides for fast and easy installation, without the need to remove fastener
- Metal insulation grip sleeve crimps to wire insulation, providing protection to the crimp joint during high vibration applications
- Internal barrel serrations assure good wire contact and maximum tensile strength
- UL Flammability UL 94V-2/HB, maximum insulation temperature 221°F (105°C)
- UL and CSA rated up to 600 V per UL 486A/B

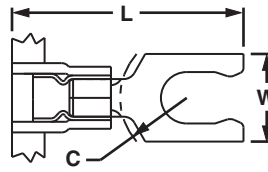

Part Number	Wire Range	Color Code	Stock Thickness (In.)	Max. Ins. (In.)	Stud Size	Figure Dimensions (In.)			CA9 Series Crimp Die	CA-800/EZ Series Crimp Die	Pieces Per Reel
						L	W	C			
PNF18-6LF-3K	22 – 18 AWG	Red	0.03	0.145	#6	0.85	0.27	0.19	CD9-1A	CD-800-1	3000
PNF18-6LFW-3K					#6	0.85	0.29	0.19			3000
PNF18-8LF-3K					#8	0.89	0.29	0.23			3000
PNF18-10LF-3K	16 – 14 AWG	Blue	0.03	0.162	#10	0.89	0.33	0.23	CD9-2A	CD-800-2	3000
PNF14-6LF-3K					#6	0.85	0.25	0.18			3000
PNF14-8LF-3K					#8	0.92	0.29	0.23			3000
PNF14-10LFN-3K	12 – 10 AWG	Yellow	0.04	0.225	#10	0.92	0.33	0.23	CD9-3B	CD-800-3	3000
PNF14-10LF-3K					#10	0.92	0.33	0.23			3000
PNF10-6LF-2K					#6	1.02	0.30	0.21			2000
PNF10-8LF-2K	12 – 10 AWG	Yellow	0.04	0.225	#8	1.05	0.30	0.21	CD9-3B	CD-800-3	2000
PNF10-10LF-2K					#10	1.05	0.34	0.21			2000
PNF10-14LF-2K					1/4"	1.19	0.46	0.32			2000

For applicator information, see page D1.143.



## Locking Fork Terminals, Vinyl Insulated – Funnel Entry

### Type PV-LFB

- Continuously molded design provides reliable, consistent performance through the applicator for a high quality termination every time
- Snap in place for secure connection
- Fork design provides for fast and easy installation, without the need to remove fastener
- Insulation support helps to prevent wire damage in bending applications
- UL Flammability UL 94V-0, maximum insulation temperature 221 °F (105°C)
- UL and CSA rated to 600 V per UL 486A/B

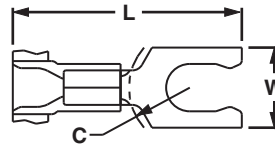

Part Number	Wire Range	Color Code	Stock Thickness (In.)	Max. Ins. (In.)	Stud Size	Figure Dimensions (In.)			CA9 Series Crimp Die	CA-800/EZ Series Crimp Die	Pieces Per Reel
						L	W	C			
<b>PV18-6LFB-3K</b>	22 – 18 AWG	Red	0.03	0.150	#6	0.80	0.27	0.19	CD9-1A	CD-800-1	3000
<b>PV18-6LFWB-3K</b>					#6	0.83	0.29	0.19			3000
<b>PV18-8LFB-3K</b>					#8	0.87	0.29	0.23			3000
<b>PV18-10LFB-3K*</b>					#10	0.87	0.29	0.23			3000
<b>PV18-10LFB-3K</b>					#10	0.87	0.33	0.23			3000
<b>PV14-6LFB-3K</b>	16 – 14 AWG	Blue	0.03	0.170	#6	0.85	0.25	0.18	CD9-2A	CD-800-2	3000
<b>PV14-6LFWB-3K</b>					#6	0.85	0.29	0.18			3000
<b>PV14-8LFB-3K</b>					#8	0.92	0.29	0.23			3000
<b>PV14-10LFB-3K</b>	12 – 10 AWG	Yellow	0.04	0.225	#10	0.92	0.33	0.23	CD9-3B	CD-800-3	3000
<b>PV10-6LFB-2K</b>					#6	1.02	0.30	0.21			2000
<b>PV10-8LFB-2K</b>					#8	1.04	0.30	0.21			2000
<b>PV10-10LFB-2K</b>					#10	1.04	0.34	0.21			2000
<b>PV10-14LFB-2K</b>					1/4"	1.16	0.46	0.32			2000

\*Not UL Listed or CSA Certified.  
For applicator information, see page D1.143.

A. System Overview

B1. Cable Ties

B2. Cable Accessories

B3. Stainless Steel Ties

C1. Wiring Duct

C2. Surface Raceway

C3. Abrasion Protection

C4. Cable Management

D1. Terminals

D2. Power Connectors

D3. Grounding Connectors

E1. Labeling Systems

E2. Labels

E3. Pre-Printed & Write-On Markers

E4. Permanent Identification

E5. Lockout/Tagout & Safety Solutions

F. Index

A. System Overview



## Short Locking Fork Terminals, Nylon Insulated – Non-Funnel Entry

### Type PN-SLF

B1. Cable Ties

- Continuously molded design provides reliable, consistent performance through the applicator for a high quality termination every time

- Internal barrel serrations assure good wire contact and maximum tensile strength

B2. Cable Accessories

- Lock in place for a secure connection in limited spaces
- Fork design provides for fast and easy installation, without the need to remove fastener
- Metal insulation grip sleeve crimps to wire insulation, providing protection to the crimp joint during high vibration applications

- UL Flammability UL 94V-2/HB, maximum insulation temperature 221°F (105°C)

- UL and CSA rated up to 600 V per UL 486A/B

B3. Stainless Steel Ties

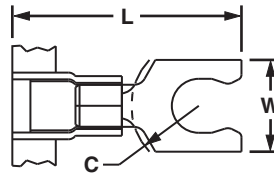

C1. Wiring Duct

C2. Surface Raceway

C3. Abrasion Protection

C4. Cable Management

Part Number	Wire Range	Color Code	Stock Thickness (In.)	Max. Ins. (In.)	Stud Size	Figure Dimensions (In.)			CA9 Series Crimp Die	CA-800/EZ Series Crimp Die	Pieces Per Reel
						L	W	C			
PN18-5SLF-3K	22 – 18 AWG	Red	0.03	0.145	#5	0.75	0.26	0.19	CD9-1A	CD-800-1	3000
PN18-6SLF-3K					#6	0.75	0.27	0.19			3000
PN18-8SLF-3K					#8	0.79	0.29	0.23			3000
PN18-10SLF-3K					#10	0.80	0.33	0.23			3000
PN14-5SLF-3K	16 – 14 AWG	Blue	0.03	0.162	#5	0.75	0.25	0.19	CD9-2A	CD-800-2	3000
PN14-6SLF-3K					#6	0.75	0.25	0.19			3000
PN14-8SLF-3K					#8	0.80	0.29	0.23			3000
PN14-10SLF-3K					#10	0.81	0.33	0.23			3000
PN10-8SLF-2K	12 – 10 AWG	Yellow	0.04	0.225	#8	0.92	0.29	0.22	CD9-3B	CD-800-3	2000
PN10-10SLF-2K					#10	0.92	0.33	0.22			2000

For applicator information, see page D1.143.

D1. Terminals



## Short Locking Fork Terminals, Nylon Insulated – Funnel Entry

### Type PNF-SLF

D2. Power Connectors

- Continuously molded design provides reliable, consistent performance through the applicator for a high quality termination every time

- Internal barrel serrations assure good wire contact and maximum tensile strength

D3. Grounding Connectors

- Lock in place for a secure connection in limited spaces
- Fork design provides for fast and easy installation, without the need to remove fastener
- Metal insulation grip sleeve crimps to wire insulation, providing protection to the crimp joint during high vibration applications

- UL Flammability UL 94V-2/HB, maximum insulation temperature 221°F (105°C)

- UL and CSA rated up to 600 V per UL 486A/B

E1. Labeling Systems

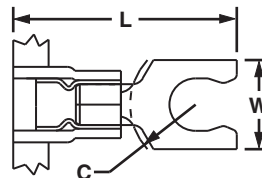

E2. Labels

E3. Pre-Printed & Write-On Markers

E4. Permanent Identification

E5. Lockout/Tagout & Safety Solutions

F. Index

Part Number	Wire Range	Color Code	Stock Thickness (In.)	Max. Ins. (In.)	Stud Size	Figure Dimensions (In.)			CA9 Series Crimp Die	CA-800/EZ Series Crimp Die	Pieces Per Reel
						L	W	C			
PNF18-5SLF-3K	22 – 18 AWG	Red	0.03	0.145	#5	0.73	0.26	0.19	CD9-1A	CD-800-1	3000
<b>PNF18-6SLF-3K</b>					#6	0.74	0.27	0.19			3000
PNF18-8SLF-3K					#8	0.80	0.29	0.23			3000
PNF18-10SLF-3K					#10	0.80	0.33	0.23			3000
PNF14-6SLF-3K	16 – 14 AWG	Blue	0.03	0.162	#6	0.75	0.25	0.19	CD9-2A	CD-800-2	3000
PNF14-10SLF-3K					#10	0.81	0.33	0.23			3000
PNF10-6SLF-2K	12 – 10 AWG	Yellow	0.04	0.225	#6	0.91	0.25	0.17	CD9-3B	CD-800-3	2000
PNF10-8SLF-2K					#8	0.92	0.29	0.22			2000
PNF10-10SLF-2K					#10	0.93	0.33	0.22			2000

For applicator information, see page D1.143.





## Short Locking Fork Terminals, Vinyl Insulated – Funnel Entry

### Type PV-SLFB

- Continuously molded design provides reliable, consistent performance through the applicator for a high quality termination every time
- Lock in place for a secure connection in limited spaces
- Fork design provides for fast and easy installation, without the need to remove fastener

- Insulation support helps to prevent wire damage in bending applications
- UL Flammability UL 94V-0, maximum insulation temperature 221°F (105°C)
- UL and CSA rated up to 600 V per UL 486A/B

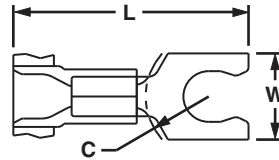

Part Number	Wire Range	Color Code	Stock Thickness (In.)	Max. Ins. (In.)	Stud Size	Figure Dimensions (In.)			CA9 Series Crimp Die	CA-800/EZ Series Crimp Die	Pieces Per Reel
						L	W	C			
PV18-5SLFB-3K	22 – 18 AWG	Red	0.03	0.150	#5	0.72	0.26	0.19	CD9-1A	CD-800-1	3000
PV18-6SLFB-3K					#6	0.72	0.27	0.19			3000
PV18-8SLFB-3K					#8	0.77	0.29	0.23			3000
PV18-10SLFB-3K					#10	0.78	0.33	0.23			3000
PV14-6SLFB-3K	16 – 14 AWG	Blue	0.03	0.170	#6	0.75	0.25	0.19	CD9-2A	CD-800-2	3000
PV14-8SLFB-3K					#8	0.80	0.29	0.23			3000
PV14-10SLFB-3K					#10	0.81	0.33	0.23			3000
PV14-14SLFB-3K					1/4"	0.90	0.44	0.29			3000
PV10-6SLFB-2K	12 – 10 AWG	Yellow	0.04	0.225	#6	0.84	0.25	0.17	CD9-3B	CD-800-3	2000
PV10-8SLFB-2K					#8	0.90	0.29	0.22			2000
PV10-10SLFB-2K					#10	0.91	0.33	0.22			2000

For applicator information, see page D1.143.



## Flanged Fork Terminals, Nylon Insulated – Non-Funnel Entry

### Type PN-FF

- Continuously molded design provides reliable, consistent performance through the applicator for a high quality termination every time
- Flange design provides extra secure connection on a variety of applications
- Fork design provides for fast and easy installation, without the need to remove fastener

- Metal insulation grip sleeve crimps to wire insulation, providing protection to the crimp joint during high vibration applications
- Internal barrel serrations assure good wire contact and maximum tensile strength
- UL Flammability UL 94V-2/HB, maximum insulation temperature 221°F (105°C)
- UL and CSA rated up to 600 V per UL 486A/B



Part Number	Wire Range	Color Code	Stock Thickness (In.)	Max. Ins. (In.)	Stud Size	Figure Dimensions (In.)			CA9 Series Crimp Die	CA-800/EZ Series Crimp Die	Pieces Per Reel
						L	W	C			
PN18-6FF-3K	22 – 18 AWG	Red	0.03	0.136	#6	0.80	0.28	0.19	CD9-1A	CD-800-1	3000
PN18-8FF-3K					#8	0.87	0.31	0.23			3000
PN18-10FF-3K					#10	0.87	0.35	0.23			3000
PN14-6FF-3K	16 – 14 AWG	Blue	0.03	0.162	#6	0.80	0.28	0.19	CD9-2A	CD-800-2	3000
PN14-8FF-3K					#8	0.87	0.31	0.23			3000
PN14-10FF-3K					#10	0.87	0.35	0.23			3000
PN10-8FF-2K	12 – 10 AWG	Yellow	0.04	0.225	#8	1.05	0.38	0.22	CD9-3B	CD-800-3	2000
PN10-10FF-2K					#10	1.05	0.38	0.22			2000

For applicator information, see page D1.143.

A. System Overview

B1. Cable Ties

B2. Cable Accessories

B3. Stainless Steel Ties

C1. Wiring Duct

C2. Surface Raceway

C3. Abrasion Protection

C4. Cable Management

D1. Terminals

D2. Power Connectors

D3. Grounding Connectors

E1. Labeling Systems

E2. Labels

E3. Pre-Printed & Write-On Markers

E4. Permanent Identification

E5. Lockout/Tagout & Safety Solutions

F. Index

A. System Overview



## Flanged Fork Terminals, Nylon Insulated – Funnel Entry

B1. Cable Ties

### Type PNF-FF

B2. Cable Accessories

B3. Stainless Steel Ties

C1. Wiring Duct

- Continuously molded design provides reliable, consistent performance through the applicator for a high quality termination every time
- Flange design provides extra secure connection on a variety of applications
- Fork design provides for fast and easy installation, without the need to remove fastener

- Metal insulation grip sleeve crimps to wire insulation, providing protection to the crimp joint during high vibration applications
- Internal barrel serrations assure good wire contact and maximum tensile strength
- UL Flammability UL 94V-2/HB, maximum insulation temperature 221°F (105°C)
- UL and CSA rated up to 600 V per UL 486A/B



C2. Surface Raceway

C3. Abrasion Protection

C4. Cable Management

Part Number	Wire Range	Color Code	Stock Thickness (In.)	Max. Ins. (In.)	Stud Size	Figure Dimensions (In.)			CA9 Series Crimp Die	CA-800/EZ Series Crimp Die	Pieces Per Reel
						L	W	C			
PNF18-6FF-3K	22 – 18 AWG	Red	0.03	0.145	#6	0.80	0.28	0.19	CD9-1A	CD-800-1	3000
<b>PNF18-8FF-3K</b>					#8	0.87	0.31	0.23			3000
PNF18-10FF-3K					#10	0.86	0.35	0.23			3000
PNF14-6FF-3K	16 – 14 AWG	Blue	0.03	0.162	#6	0.80	0.28	0.19	CD9-2A	CD-800-2	3000
PNF14-8FF-3K					#8	0.87	0.31	0.23			3000
PNF14-10FF-3K					#10	0.87	0.35	0.23			3000
PNF10-8FF-2K	12 – 10 AWG	Yellow	0.04	0.225	#8	1.05	0.38	0.24	CD9-3B	CD-800-3	2000
PNF10-10FF-2K					#10	1.05	0.38	0.24			2000

For applicator information, see page D1.143.

D1. Terminals



## Flanged Fork Terminals, Vinyl Insulated – Funnel Entry

D2. Power Connectors

### Type PV-FFB

D3. Grounding Connectors

- Continuously molded design provides reliable, consistent performance through the applicator for a high quality termination every time
- Flange design provides extra secure connection on a variety of applications
- Fork design provides for fast and easy installation, without the need to remove fastener

- Insulation support helps to prevent wire damage in bending applications
- UL Flammability UL 94V-0, maximum insulation temperature 221°F (105°C)
- UL and CSA rated up to 600 V per UL 486A/B

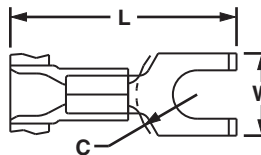

E1. Labeling Systems

E2. Labels

E3. Pre-Printed & Write-On Markers

E4. Permanent Identification

E5. Lockout/Tagout & Safety Solutions

Part Number	Wire Range	Color Code	Stock Thickness (In.)	Max. Ins. (In.)	Stud Size	Figure Dimensions (In.)			CA9 Series Crimp Die	CA-800/EZ Series Crimp Die	Pieces Per Reel
						L	W	C			
PV18-6FFB-3K	22 – 18 AWG	Red	0.03	0.150	#6	0.80	0.28	0.19	CD9-1A	CD-800-1	3000
<b>PV18-8FFB-3K</b>					#8	0.87	0.31	0.23			3000
PV18-10FFB-3K					#10	0.86	0.35	0.23			3000
PV14-6FFB-3K	16 – 14 AWG	Blue	0.03	0.170	#6	0.80	0.28	0.19	CD9-2A	CD-800-2	3000
PV14-8FFB-3K					#8	0.86	0.31	0.23			3000
PV14-10FFB-3K					#10	0.86	0.35	0.23			3000
PV10-8FFB-2K	12 – 10 AWG	Yellow	0.04	0.225	#8	1.03	0.37	0.22	CD9-3B	CD-800-3	2000
<b>PV10-10FFB-2K</b>					#10	1.03	0.37	0.22			2000

For applicator information, see page D1.143.

F. Index

## Features and Benefits – Reel Smart™ Metric Terminals

### Metric Nylon Insulated Funnel Terminals with Insulation Grip Sleeve Type PMN or PMNF



UL and CSA rated up to 600 V per UL 486A/B.  
Flammability – UL 94V-2/HB.

### Metric Nylon Insulated Funnel Terminals with Insulation Support Type PMV



UL and CSA rated up to 600 V per UL 486A/B.  
Flammability UL 94V-0.

## Part Number System for Reel Smart™ Metric Terminals

<u>PM</u>	<u>V</u>	<u>1</u>	—	<u>3</u>	<u>R</u>	<u>B</u>	<u>3K</u>
Type	Insulation	Wire Range		Stud Size	Tongue Configuration	Special Configuration	Std. Pkg. Size
PM = Pan-Term® Metric	N = Nylon NF = Nylon Funnel Entry V = Vinyl	1 = 0.5 – 1.0mm <sup>2</sup> or 0.5 – 1.5mm <sup>2</sup> 2 = 1.5 – 2.5mm <sup>2</sup> 6 = 2.5 – 6.0mm <sup>2</sup> or 4.0 – 6.0mm <sup>2</sup>		3 = M3 (#5) 35 = M3.5 (#6) 4 = M4 (#8) 5 = M5 (#10) 6 = M6 (1/4") 8 = M8 (5/16")	R = Ring F = Fork	B = Butted Seam = Standard (leave blank)	2K = 2,000 pcs. 3K = 3,000 pcs.

A. System Overview



## Metric Ring Terminals, Nylon Insulated – Non-Funnel Entry

B1. Cable Ties

### Type PMN-R

B2. Cable Accessories

B3. Stainless Steel Ties

C1. Wiring Duct

C2. Surface Raceway

C3. Abrasion Protection

C4. Cable Management

D1. Terminals

D2. Power Connectors

D3. Grounding Connectors

E1. Labeling Systems

E2. Labels

E3. Pre-Printed & Write-On Markers

E4. Permanent Identification

E5. Lockout/Tagout & Safety Solutions

F. Index

- Continuously molded design provides reliable, consistent performance through the applicator for a high quality termination every time
- Ring tongue design assures a secure connection in high vibration applications

- Metal insulation grip sleeve crimps to wire insulation, providing protection to the crimp joint during high vibration applications
- Internal barrel serrations assure good wire contact and maximum tensile strength
- UL Flammability UL 94V-2/HB, maximum insulation temperature 221°F (105°C)
- UL and CSA rated up to 600 V per UL 486A/B



Part Number	Wire Range (mm²)	Color Code	Max. Ins. (mm)	Stud Size	Figure Dimensions (mm)			CA9 Series Crimp Die	CA-800/EZ Series Crimp Die	Pieces Per Reel
					L	W	C			
PMN1-3R-3K	0.5 – 1.0	Red	3.7	M3	19.3	5.8	5.2	CD9-1A	CD-800-1	3000
PMN1-35R-3K				M3.5	19.3	5.8	5.2			3000
PMN1-4R-3K				M4	21.9	7.9	6.4			3000
PMN1-5R-3K				M5	22.4	8.9	6.4			3000
PMN1-6R-3K				M6	26.7	10.9	9.7			3000
PMN2-3R-3K				1.5 – 2.5	Blue	4.1	M3			21.6
PMN2-35R-3K	M3.5	21.6	5.8				5.1	3000		
PMN2-4R-3K	M4	24.1	7.9				6.5	3000		
PMN2-5R-3K	M5	24.6	8.9				6.5	3000		
PMN2-6R-3K	M6	26.7	10.9				9.7	3000		
PMN6-3R-2K	4.0 – 6.0	Yellow	5.7				M3	24.7	5.8	7.9
PMN6-35R-2K				M3.5	24.7	5.8	7.9	2000		
PMN6-4R-2K				M4	25.7	7.9	7.9	2000		
PMN6-5R-2K				M5	26.4	9.7	7.9	2000		
PMN6-6R-2K				M6	29.0	10.9	9.7	2000		
PMN6-8R-2K				M8	30.0	13.2	9.7	2000		

For applicator information, see page D1.143.



## Metric Ring Terminals, Nylon Insulated – Funnel Entry

### Type PMNF-R

- Continuously molded design provides reliable, consistent performance through the applicator for a high quality termination every time
- Ring tongue design assures a secure connection in high vibration applications

- Metal insulation grip sleeve crimps to wire insulation, providing protection to the crimp joint during high vibration applications
- Internal barrel serrations assure good wire contact and maximum tensile strength
- UL Flammability UL 94V-2/HB, maximum insulation temperature 221°F (105°C)
- UL and CSA rated up to 600 V per UL 486A/B

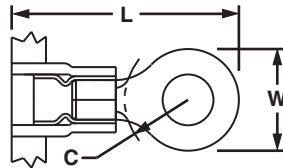

Part Number	Wire Range (mm <sup>2</sup> )	Color Code	Max. Ins. (mm)	Stud Size	Figure Dimensions (mm)			CA9 Series Crimp Die	CA-800/EZ Series Crimp Die	Pieces Per Reel
					L	W	C			
PMNF1-3R-3K	0.5 – 1.0	Red	3.7	M3	19.3	5.8	5.2	CD9-1A	CD-800-1	3000
PMNF1-35R-3K				M3.5	19.3	5.8	5.2			3000
PMNF1-4R-3K				M4	21.9	7.9	6.4			3000
PMNF1-5R-3K				M5	22.4	8.9	6.4			3000
PMNF1-6R-3K				M6	26.7	10.9	9.7			3000
PMNF2-3R-3K	1.5 – 2.5	Blue	4.1	M3	19.4	5.8	5.1	CD9-2A	CD-800-2	3000
PMNF2-35R-3K				M3.5	19.4	5.8	5.1			3000
PMNF2-4R-3K				M4	21.8	7.9	6.5			3000
PMNF2-5R-3K				M5	22.4	8.9	6.5			3000
PMNF2-6R-3K				M6	26.5	10.9	9.7			3000
PMNF6-3R-2K	4.0 – 6.0	Yellow	5.7	M3	24.7	5.8	7.9	CD9-3B	CD-800-3	2000
PMNF6-35R-2K				M3.5	24.7	5.8	7.9			2000
PMNF6-4R-2K				M4	25.7	7.9	7.9			2000
PMNF6-5R-2K				M5	26.4	9.7	7.9			2000
PMNF6-6R-2K				M6	29.0	10.9	9.7			2000
PMNF6-8R-2K	M8	30.0	13.2	9.7	2000					

For applicator information, see page D1.143.

A. System Overview

B1. Cable Ties

B2. Cable Accessories

B3. Stainless Steel Ties

C1. Wiring Duct

C2. Surface Raceway

C3. Abrasion Protection

C4. Cable Management

D1. Terminals

D2. Power Connectors

D3. Grounding Connectors

E1. Labeling Systems

E2. Labels

E3. Pre-Printed & Write-On Markers

E4. Permanent Identification

E5. Lockout/Tagout & Safety Solutions

F. Index

A. System Overview



## Metric Ring Terminals, Vinyl Insulated – Funnel Entry

B1. Cable Ties

### Type PMV-RB

- Continuously molded design provides reliable, consistent performance through the applicator for a high quality termination every time
- Insulation support helps to prevent wire damage in bending applications

- Ring tongue design assures a secure connection in high vibration applications
- UL Flammability UL 94V-0, maximum insulation temperature 221°F (105°C)
- UL and CSA rated up to 600 V per UL 486A/B

B2. Cable Accessories

B3. Stainless Steel Ties

C1. Wiring Duct

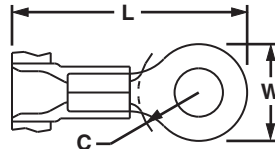

C2. Surface Raceway

C3. Abrasion Protection

C4. Cable Management

D1. Terminals

D2. Power Connectors

D3. Grounding Connectors

Part Number	Wire Range (mm²)	Color Code	Max. Ins. (mm)	Stud Size	Figure Dimensions (mm)			CA9 Series Crimp Die	CA-800/EZ Series Crimp Die	Pieces Per Reel
					L	W	C			
PMV1-3RB-3K	0.5 – 1.0	Red	3.7	M3	19.3	5.8	5.2	CD9-1A	CD-800-1	3000
PMV1-35RB-3K				M3.5	19.3	5.8	5.2			3000
PMV1-4RB-3K				M4	21.8	7.9	6.4			3000
PMV1-5RB-3K				M5	22.4	8.9	6.4			3000
PMV1-6RB-3K				M6	26.4	10.9	9.7			3000
PMV2-3RB-3K				1.5 – 2.5	Blue	4.3	M3			21.3
PMV2-35RB-3K	M3.5	21.3	5.8				5.1	3000		
PMV2-4RB-3K	M4	23.9	7.9				6.5	3000		
PMV2-5RB-3K	M5	24.4	8.9				6.5	3000		
PMV2-6RB-3K	M6	26.7	10.9				9.7	3000		
PMV6-3RB-2K	4.0 – 6.0	Yellow	5.7				M3	24.9	6.1	7.9
PMV6-35RB-2K				M3.5	24.9	6.1	7.9	2000		
PMV6-4RB-2K				M4	25.9	7.9	7.9	2000		
PMV6-5RB-2K				M5	26.7	9.4	7.9	2000		
PMV6-6RB-2K				M6	29.2	10.9	9.7	2000		
PMV6-8RB-2K				M8	30.5	13.2	9.7	2000		

For applicator information, see page D1.143.

E1. Labeling Systems

E2. Labels

E3. Pre-Printed & Write-On Markers

E4. Permanent Identification

E5. Lockout/Tagout & Safety Solutions

F. Index



## Metric Fork Terminals, Nylon Insulated – Non-Funnel Entry

### Type PMN-F

- Continuously molded design provides reliable, consistent performance through the applicator for a high quality termination every time
- Fork design provides for fast and easy installation, without the need to remove fastener
- Metal insulation grip sleeve crimps to wire insulation, providing protection to the crimp joint during high vibration applications

- Internal barrel serrations assure good wire contact and maximum tensile strength
- UL Flammability UL 94V-2/HB, maximum insulation temperature 221°F (105°C)
- UL and CSA rated up to 600 V per UL 486A/B



Part Number	Wire Range (mm <sup>2</sup> )	Color Code	Max. Ins. (mm)	Stud Size	Figure Dimensions (mm)			CA9 Series Crimp Die	CA-800/EZ Series Crimp Die	Pieces Per Reel
					L	W	C			
PMN1-3F-3K	0.5 – 1.0	Red	3.7	M3	19.9	5.9	5.0	CD9-1A	CD-800-1	3000
PMN1-4F-3K				M4	21.6	8.2	5.8			3000
PMN1-5F-3K				M5	21.8	8.9	6.3			3000
PMN1-6F-3K				M6	26.4	11.2	8.4			3000
PMN2-3F-3K	1.5 – 2.5	Blue	4.1	M3	19.8	5.9	5.1	CD9-2A	CD-800-2	3000
PMN2-4F-3K				M4	21.3	7.9	5.9			3000
PMN2-5F-3K				M5	21.9	8.6	6.4			3000
PMN2-6F-3K				M6	26.2	11.2	8.5			3000
PMN6-4F-2K	4.0 – 6.0	Yellow	5.7	M4	25.7	7.9	6.1	CD9-3B	CD-800-3	2000
PMN6-5F-2K				M5	25.7	9.5	6.1			2000
PMN6-6F-2K				M6	28.5	11.0	8.2			2000

For applicator information, see page D1.143.



## Metric Fork Terminals, Nylon Insulated – Funnel Entry

### Type PMNF-F

- Continuously molded design provides reliable, consistent performance through the applicator for a high quality termination every time
- Flange design provides extra secure connection on a variety of applications
- Fork design provides for fast and easy installation, without the need to remove fastener

- Metal insulation grip sleeve crimps to wire insulation, providing protection to the crimp joint during high vibration applications
- Internal barrel serrations assure good wire contact and maximum tensile strength
- UL Flammability UL 94V-2/HB, maximum insulation temperature 221°F (105°C)
- UL and CSA rated up to 600 V per UL 486A/B



Part Number	Wire Range (mm <sup>2</sup> )	Color Code	Max. Ins. (mm)	Stud Size	Figure Dimensions (mm)			CA9 Series Crimp Die	CA-800/EZ Series Crimp Die	Pieces Per Reel
					L	W	C			
PMNF1-3F-3K	0.5 – 1.0	Red	3.7	M3	20.0	5.9	5.0	CD9-1A	CD-800-1	3000
PMNF1-4F-3K				M4	21.6	8.2	5.8			3000
PMNF1-5F-3K				M5	21.8	8.9	6.3			3000
PMNF1-6F-3K				M6	26.4	11.2	8.4			3000
PMNF2-3F-3K	1.5 – 2.5	Blue	4.1	M3	19.8	5.9	5.1	CD9-2A	CD-800-2	3000
PMNF2-4F-3K				M4	21.3	7.9	5.9			3000
PMNF2-5F-3K				M5	21.9	8.6	6.4			3000
PMNF2-6F-3K				M6	26.2	11.2	8.5			3000
PMNF6-4F-2K	4.0 – 6.0	Yellow	5.7	M4	25.7	7.9	6.1	CD9-3B	CD-800-3	2000
PMNF6-5F-2K				M5	25.7	9.5	6.1			2000
PMNF6-6F-2K				M6	28.5	11.0	8.2			2000

For applicator information, see page D1.143.

A. System Overview

B1. Cable Ties

B2. Cable Accessories

B3. Stainless Steel Ties

C1. Wiring Duct

C2. Surface Raceway

C3. Abrasion Protection

C4. Cable Management

D1. Terminals

D2. Power Connectors

D3. Grounding Connectors

E1. Labeling Systems

E2. Labels

E3. Pre-Printed & Write-On Markers

E4. Permanent Identification

E5. Lockout/Tagout & Safety Solutions

F. Index

A. System Overview



## Metric Fork Terminals, Vinyl Insulated – Funnel Entry

B1. Cable Ties

### Type PMV-FB

- Continuously molded design provides reliable, consistent performance through the applicator for a high quality termination every time
- Fork design provides for fast and easy installation, without the need to remove fastener

- Insulation support helps to prevent wire damage in bending applications
- UL Flammability UL 94V-0, maximum insulation temperature 221°F (105°C)
- UL and CSA rated up to 600 V per UL 486A/B

B2. Cable Accessories

B3. Stainless Steel Ties



C1. Wiring Duct

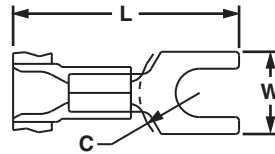

C2. Surface Raceway

C3. Abrasion Protection

C4. Cable Management

D1. Terminals

D2. Power Connectors

D3. Grounding Connectors

E1. Labeling Systems

E2. Labels

E3. Pre-Printed & Write-On Markers

E4. Permanent Identification

E5. Lockout/Tagout & Safety Solutions

F. Index

Part Number	Wire Range (mm <sup>2</sup> )	Color Code	Max. Ins. (mm)	Stud Size	Figure Dimensions (mm)			CA9 Series Crimp Die	CA-800/EZ Series Crimp Die	Pieces Per Reel
					L	W	C			
PMV1-3FB-3K	0.5 – 1.0	Red	3.7	M3	19.8	5.8	5.1	CD9-1A	CD-800-1	3000
PMV1-4FB-3K				M4	21.3	8.1	5.8			3000
PMV1-5FB-3K				M5	21.8	9.0	6.4			3000
PMV1-6FB-3K				M6	26.2	11.2	8.4			3000
PMV2-3FB-3K	1.5 – 2.5	Blue	4.3	M3	19.8	5.9	5.1	CD9-2A	CD-800-2	3000
PMV2-4FB-3K				M4	21.3	7.9	5.8			3000
PMV2-5FB-3K				M5	21.8	8.6	6.4			3000
PMV2-6FB-3K				M6	26.2	11.2	8.5			3000
PMV6-4FB-2K	4.0 – 6.0	Yellow	5.7	M4	25.9	7.9	6.2	CD9-3B	CD-800-3	2000
PMV6-5FB-2K				M5	25.9	9.7	6.2			2000
PMV6-6FB-2K				M6	28.7	11.0	8.2			2000

For applicator information, see page D1.143.



## Features and Benefits – Reel Smart™ Disconnects

### Supra-Grip™ Nylon Fully Insulated Funnel Entry, Female Receptacle Type DNG-FB

Available in tab sizes to accommodate .187" or .250" tabs

Fully insulated design provides protection from electrical shorts

Maximum insulation temperature 221°F (105°C)

Continuously molded design provides reliable, consistent performance through applicator

Funnel entry for faster wire insertion and lower installed cost

Fully integrated metal insulation grip for high vibration, high strain relief, and double crimp requirements



UL and CSA Rated up to 600 V per UL 310. Flammability UL 94V-2/HB.

### Disco-Lok™ Nylon Fully Insulated, Funnel Entry, Female Receptacle Type DNG-FL

Available in tab sizes to accommodate .250" tabs

Maximum insulation temperature 221°F (105°C)

Continuously molded design provides reliable, consistent performance through applicator

Funnel entry for faster wire insertion and lower installed cost

Unique locking mechanism allows for low insertion (mating) and positive locking for secure connections

Insulation grip sleeve provides a superior insulation crimp for high vibration and high strain relief applications



UL and CSA rated up to 300 V. Flammability UL 94V-2/HB.

### Standard and Premium Nylon Fully Insulated, Funnel Entry, Females Receptacles and Male Tabs Type DPF

Available in tab sizes to accommodate .110", .187", .205" or .250" tabs

Maximum insulation temperature 257°F (125°C)

Continuously molded design provides reliable, consistent performance through applicator

Funnel entry for faster wire insertion and lower installed cost

Fully insulated design provides protection from electrical shorts

Insulation support restricts excessive wire movement to minimize stress on crimp joint

Expanded wire entry (on select sizes) accommodates large insulation or multiple wires

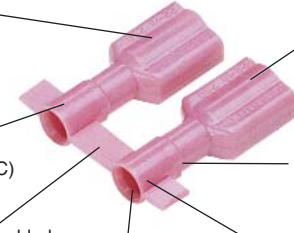

UL and CSA Rated up to 600 V per UL 310. Flammability UL 94V-2.

### Vinyl Barrel Insulated Funnel Entry, Female Receptacles and Male Tabs Type DV

Available in tab sizes to accommodate .187", .205", or .250" tabs

Continuously molded design provides reliable, consistent performance through applicator

Insulation grip sleeve provides a superior insulation crimp for high vibration and high strain relief applications

Insulation support to protect electrical crimp

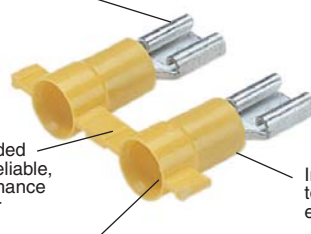

UL and CSA Rated up to 600 V. Flammability UL 94V-0.



High speed electric presses provide for fast terminations.

See page D1.144.



Fully Automatic Cable Tie Installation Systems offer an efficient solution for high volume harnessing, assembly, fastening and packaging applications.

See pages B1.113 – B1.122.

A. System Overview

B1. Cable Ties

B2. Cable Accessories

B3. Stainless Steel Ties

C1. Wiring Duct

C2. Surface Raceway

C3. Abrasion Protection

C4. Cable Management

D1. Terminals

D2. Power Connectors

D3. Grounding Connectors

E1. Labeling Systems

E2. Labels

E3. Pre-Printed & Write-On Markers

E4. Permanent Identification

E5. Lockout/Tagout & Safety Solutions

F. Index

## Part Number System for Reel Smart™ Disconnects

D	NF	14	—	250	FIB	3K
Type	Insulation	Wire Range		Size and Type	Special Configuration	Std. Pkg. Size
D = Disconnects	NF = Nylon Funnel Entry NG = Nylon Funnel Entry Metal Insulation Grip NFR = Nylon Funnel Entry Right Angle PF = Premium Grade Nylon (Double Crimp) V = Vinyl	18 = #22 – 18 14 = #16 – 14 10 = #12 – 10		110 = 0.110 x 0.032 tab size 111 = 0.110 x 0.020 tab size 145 = 0.145 x 0.032 tab size 187 = 0.187 x 0.032 tab size 188 = 0.187 x 0.020 tab size 205 = 0.187/0.205 x 0.032 tab size 206 = 0.187/0.205 x 0.020 tab size 250 = 0.250 x 0.032 tab size  0.187/0.205: Expandable receptacle will accept male tabs from 0.187" to 0.205" widths in 0.032" or 0.020" thick styles. Fully reliable connection through all widths.	B = Butted seam C = Compression Tab FB = Metal Insulation Grip, Female FL = Fully Insulated Positive Locking Female FIB = Fully Insulated, Butted Seam, Female FIBX = Fully Insulated, Butted Seam, Female, Expanded Wire Entry FIM = Fully Insulated Male FIMB = Fully Insulated, Male, Oversized Housing FIMX = Fully Insulated, Male, Expanded Wire Entry M = Male MB = Male Butted Seam	K = 1,000 KD = 1,500 2K = 2,000 3K = 3,000

### UL LISTED CERTIFIED **Supra-Grip™ Female Disconnects, Nylon Fully Insulated – Funnel Entry**

#### Type DNG-FB

- Continuously molded design provides reliable, consistent performance through the applicator for a high quality termination every time
- Disconnect can be inserted and removed from the male tab without the use of tools for lower installed cost
- Flared barrel extension integrated into stamping to provide insulation grip for double crimp requirements
- Internal barrel serrations assure good wire contact and maximum tensile strength
- Internal wire stop assures proper length of insertion into terminal barrel, providing a higher-quality connection
- Mates with DNF-FIMB family
- UL Flammability UL 94V-2/HB, maximum insulation temperature 221°F (105°C)
- UL and CSA rated up to 600 V per UL 310

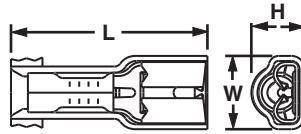

Part Number	Wire Range	Color Code	Max. Ins. (In.)	Figure Dimensions (In.)			Tab Size		CA9 Series Crimp Die	CA-800/EZ Series Crimp Die	Pieces Per Reel
				L	W	H	In.	mm			
<b>DNG18-187FB-3K</b>	22 – 18 AWG	Red	0.126	0.89	0.29	0.22	0.187 x 0.032	4.8 x 0.8	CD9-15A	CD-800-15	3000
<b>DNG18-188FB-3K</b>				0.89	0.29	0.22	0.187 x 0.020	4.8 x 0.5			3000
<b>DNG18-250FB-3K</b>				0.93	0.35	0.23	0.250 x 0.032	6.3 x 0.8			3000
<b>DNG14-187FB-3K*</b>	16 – 14 AWG	Blue	0.153	0.89	0.29	0.25	0.187 x 0.032	4.8 x 0.8	CD9-16A	CD-800-16	3000
<b>DNG14-188FB-3K</b>				0.89	0.29	0.25	0.187 x 0.020	4.8 x 0.5			3000
<b>DNG14-250FB-3K</b>				0.93	0.35	0.25	0.250 x 0.032	6.3 x 0.8			3000

\*UL Recognized for copper alloy tabs only.  
For applicator information, see page D1.143.

## Disco-Lok™ Female Disconnects, Nylon Fully Insulated – Funnel Entry

### Type DNG-FL

- Continuously molded design provides reliable, consistent performance through the applicator for a high quality termination every time
- Disconnect can be inserted and removed from the male tab without the use of tools for lower installed cost
- Unique locking mechanism design allows for low insertion forces (mating) and positive lock for high vibration applications where a secure connection is mandatory
- Fully insulated design provides protection from electrical shorts
- Flared barrel extension integrated into stamping to provide insulation grip for double crimp requirements
- Insulation housing moves back and forth to engage and disengage locking mechanism for repeated use
- Specialty tool required to install this disconnect (CT-1014)
- Mates with DNF-FIMB family
- UL Flammability UL 94V-2/HB, maximum insulation temperature 221°F (105°C)
- Rated up to 300 V

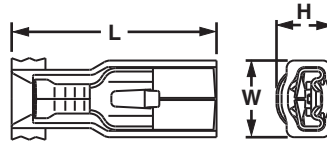

Part Number	Wire Range	Color Code	Max. Ins. (In.)	Figure Dimensions (In.)			Tab Size		CA9 Series Crimp Die	CA-800/EZ Series Crimp Die	Pieces Per Reel
				L	W	H	In.	mm			
<b>DNG18-250FL-3K</b>	22 – 18 AWG	Red	0.126	0.97	0.36	0.24	0.250 x 0.032	6.3 x 0.8	CD9-14A	CD-800-14	3000
<b>DNG14-250FL-3K</b>	16 – 14 AWG	Blue	0.150	0.97	0.36	0.25	0.250 x 0.032	6.3 x 0.8	CD9-14A	CD-800-14	3000

For applicator information, see page D1.143.

## Female Disconnects, Nylon Fully Insulated – Funnel Entry

### Type DNF-FIB

- Continuously molded design provides reliable, consistent performance through the applicator for a high quality termination every time
- Disconnect can be inserted and removed from the male tab without the use of tools for lower installed cost
- Fully insulated design provides protection from electrical shorts
- Disconnects available in common industry tab sizes
- Internal wire stop assures proper length of insertion into terminal barrel, providing a higher quality connection
- UL Flammability UL 94V-2/HB, maximum insulation temperature 221°F (105°C)
- UL and CSA rated up to 600 V per UL 310

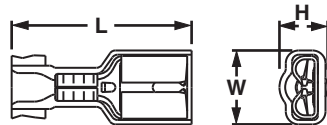

Part Number	Wire Range	Color Code	Max. Ins. (In.)	Figure Dimensions (In.)			Tab Size		CA9 Series Crimp Die	CA-800/EZ Series Crimp Die	Pieces Per Reel
				L	W	H	In.	mm			
<b>DNF18-110FIB-3K</b>	22 – 18 AWG	Red	0.120	0.71	0.19	0.15	0.110 x 0.032	2.8 x 0.8	CD9-7A	CD-800-7	3000
<b>DNF18-111FIB-3K</b>		Red	0.120	0.71	0.19	0.15	0.110 x 0.020	2.8 x 0.5	CD9-7A	CD-800-7	3000
<b>DNF18-112FIB-3K*</b>		Natural	0.120	0.71	0.19	0.15	0.110 x 0.010	2.8 x 0.3	CD9-7A	CD-800-7	3000
<b>DNF18-187FIB-3K</b>		Red	0.136	0.78	0.29	0.16	0.187 x 0.032	4.8 x 0.8	CD9-4A	CD-800-4	3000
<b>DNF18-188FIB-3K</b>		Red	0.136	0.78	0.29	0.16	0.187 x 0.020	4.8 x 0.5	CD9-4A	CD-800-4	3000
<b>DNF18-205FIB-3K</b>		Red	0.136	0.78	0.31	0.22	0.187/0.205 x 0.032	4.8/5.2 x 0.8	CD9-4A	CD-800-4	3000
<b>DNF18-206FIB-3K</b>		Red	0.136	0.78	0.31	0.22	0.187/0.205 x 0.020	4.8/5.2 x 0.5	CD9-4A	CD-800-4	3000
<b>DNF18-250FIB-3K**</b>		Red	0.136	0.84	0.35	0.22	0.250 x 0.032	6.3 x 0.8	CD9-4A	CD-800-4	3000
<b>DNF14-187FIB-3K</b>	16 – 14 AWG	Blue	0.160	0.78	0.29	0.18	0.187 x 0.032	4.8 x 0.8	CD9-5A	CD-800-5	3000
<b>DNF14-188FIB-3K</b>			0.160	0.78	0.29	0.18	0.187 x 0.020	4.8 x 0.5	CD9-5A	CD-800-5	3000
<b>DNF14-205FIB-3K</b>			0.160	0.78	0.31	0.22	0.187/0.205 x 0.032	4.8/5.2 x 0.8	CD9-5A	CD-800-5	3000
<b>DNF14-206FIB-3K</b>			0.160	0.78	0.31	0.22	0.187/0.205 x 0.020	4.8/5.2 x 0.5	CD9-5A	CD-800-5	3000
<b>DNF14-250FIB-3K</b>			0.160	0.84	0.35	0.22	0.250 x 0.032	6.3 x 0.8	CD9-5A	CD-800-5	3000
<b>DNF10-250FIB-2K</b>	12 – 10 AWG	Yellow	0.220	0.96	0.35	0.23	0.250 x 0.032	6.3 x 0.8	CD9-13B	CD-800-13	2000
<b>DNF10250FIB-2K†</b>			0.220	0.96	0.35	0.23	0.250 x 0.032	6.4 x 0.8	CD9-13B	CD-800-13	2000

\*UL/CSA standards do not exist for 0.110" x 0.010" receptacles.

\*\*UL with 17 AWG wire.

†Compressor tab disconnect to fit 0.250" tabs with a post style support.

For applicator information, see page D1.143.

A. System Overview



## Disco™ Female Disconnects, Nylon Fully Insulated – Expanded Wire Entry

B1. Cable Ties

### Type DNF-FIBX

- Continuously molded design provides reliable, consistent performance through the applicator for a high quality termination every time
- Disconnect can be inserted and removed from the male tab without the use of tools for lower installed cost
- Expanded wire entry designed to accommodate wire with a larger insulation thickness
- Fully insulated design provides protection from electrical shorts
- Internal wire stop assures proper length of insertion into terminal barrel, providing a higher quality connection
- UL Flammability UL 94V-2/HB, maximum insulation temperature 221°F (105°C)
- UL and CSA rated up to 600 V per UL 310

B2. Cable Accessories

B3. Stainless Steel Ties

C1. Wiring Duct

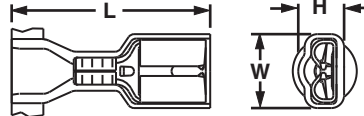

C2. Surface Raceway

Part Number	Wire Range	Color Code	Max. Ins. (In.)	Figure Dimensions (In.)			Tab Size		CA9 Series Crimp Die	CA-800/EZ Series Crimp Die	Pieces Per Reel
				L	W	H	In.	mm			
<b>DNF18205FIBX-2K</b>	22 – 18 AWG	Red	0.210	0.87	0.31	0.22	0.187/0.205 x 0.032	4.8/5.2 x 0.8	CD9-6B	CD-800-6	2000
<b>DNF18206FIBX-2K</b>				0.87	0.31	0.22	0.187/0.205 x 0.020	4.8/5.2 x 0.5			2000
<b>DNF18250FIBX-2K</b>				0.93	0.35	0.22	0.250 x 0.032	6.3 x 0.8			2000
<b>DNF14205FIBX-2K</b>	16 – 14 AWG	Blue	0.240	0.87	0.31	0.22	0.187/0.205 x 0.032	4.8/5.2 x 0.8	CD9-8B	CD-800-8	2000
<b>DNF14206FIBX-2K</b>				0.87	0.31	0.22	0.187/0.205 x 0.020	4.8/5.2 x 0.5			2000
<b>DNF14250FIBX-2K</b>				0.93	0.35	0.22	0.250 x 0.032	6.3 x 0.8			2000

For applicator information, see page D1.143.

D1. Terminals



## Disco™ Female Disconnects, Nylon Fully Insulated – Right Angle

D2. Power Connectors

### Type DNFR-FIB

- Continuously molded design provides reliable, consistent performance through the applicator for a high quality termination every time
- Right angle design for use in limited space applications
- Fully insulated design provides protection from electrical shorts
- Internal wire stop assures proper length of insertion into terminal barrel, providing a higher quality connection
- Disconnect can be inserted and removed from the male tab without the use of tools for lower installed cost
- UL Flammability UL 94V-2/HB, maximum insulation temperature 221°F (105°C)
- UL and CSA rated up to 600 V per UL 310

D3. Grounding Connectors

E1. Labeling Systems

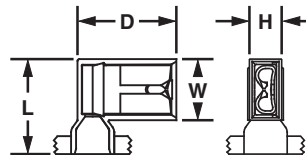

E2. Labels

E3. Pre-Printed & Write-On Markers

Part Number	Wire Range	Color Code	Max. Ins. (In.)	Figure Dimensions (In.)				Tab Size		CA9 Series Crimp Die	CA-800/EZ Series Crimp Die	Pieces Per Reel
				L	W	H	D	In.	mm			
<b>DNFR18205FIB-KD</b>	22 – 18 AWG	Red	0.178	0.57	0.37	0.21	0.60	0.187/0.205 x 0.032	4.8/5.2 x 0.8	CD9-9C	CD-800-9	1500
<b>DNFR18206FIB-KD</b>				0.57	0.37	0.21	0.60	0.187/0.205 x 0.020	4.8/5.2 x 0.5			1500
<b>DNFR18250FIB-KD</b>				0.57	0.37	0.21	0.60	0.250 x 0.032	6.3 x 0.8			1500
<b>DNFR14205FIB-KD</b>	16 – 14 AWG	Blue	0.178	0.57	0.37	0.21	0.60	0.187/0.205 x 0.032	4.8/5.2 x 0.8	CD9-9C	CD-800-9	1500
<b>DNFR14206FIB-KD</b>				0.57	0.37	0.21	0.60	0.187/0.205 x 0.020	4.8/5.2 x 0.5			1500
<b>DNFR14250FIB-KD</b>				0.57	0.37	0.21	0.60	0.250 x 0.032	6.3 x 0.8			1500

For applicator information, see page D1.143.

F. Index



## Disco™ Female Disconnects, Vinyl Barrel Insulated – Funnel Entry

### Type DV-B

- Continuously molded design provides reliable, consistent performance through the applicator for a high quality termination every time
- Disconnect can be inserted and removed from the male tab without the use of tools for lower installed cost
- Internal barrel serrations assure good wire contact and maximum tensile strength

- Internal wire stop assures proper length of insertion into terminal barrel, providing a higher quality connection
- UL Flammability UL 94V-0, maximum insulation temperature 221°F (105°C)
- UL and CSA rated up to 600 V per UL 310



Part Number	Wire Range	Color Code	Max. Ins. (In.)	Figure Dimensions (In.)			Tab Size		CA9 Series Crimp Die	CA-800/EZ Series Crimp Die	Pieces Per Reel
				L	W	H	In.	mm			
DV18-187B-3K	22 – 18 AWG	Red	0.150	0.77	0.23	0.10	0.187 x 0.032		CD9-1A	CD-800-1	3000
DV18-188B-3K			0.150	0.77	0.23	0.09	0.187 x 0.020				3000
DV18-205B-3K			0.150	0.77	0.25	0.12	0.187/0.205 x 0.032				3000
DV18-206B-3K			0.150	0.77	0.25	0.11	0.187/0.205 x 0.020				3000
DV18-250B-3K			0.150	0.83	0.29	0.12	0.250 x 0.032				3000
DV14-187B-3K	16 – 14 AWG	Blue	0.170	0.77	0.23	0.10	0.187 x 0.032		CD9-2A	CD-800-2	3000
DV14-188B-3K			0.170	0.77	0.23	0.09	0.187 x 0.020				3000
DV14-205B-3K			0.170	0.77	0.25	0.12	0.187/0.205 x 0.032				3000
DV14-206B-3K			0.170	0.77	0.25	0.11	0.187/0.205 x 0.020				3000
DV14-250B-3K			0.170	0.83	0.29	0.12	0.250 x 0.032				3000
DV10-250-2K*	12 – 10 AWG	Yellow	0.230	0.95	0.29	0.12	0.250 x 0.032		CD9-3B	CD-800-3	2000
DV10-250C-2K†**			0.230	0.95	0.29	0.12	0.250 x 0.032				2000

\*Not UL Listed or CSA Certified.

\*\*UL Recognized and CSA Certified.

†Compression tab disconnect to fit 0.250" tabs with a post style support.

For applicator information, see page D1.143.

A. System Overview

B1. Cable Ties

B2. Cable Accessories

B3. Stainless Steel Ties

C1. Wiring Duct

C2. Surface Raceway

C3. Abrasion Protection

C4. Cable Management

D1. Terminals

D2. Power Connectors

D3. Grounding Connectors

E1. Labeling Systems

E2. Labels

E3. Pre-Printed & Write-On Markers

E4. Permanent Identification

E5. Lockout/Tagout & Safety Solutions

F. Index

A. System Overview



## DiscoGrip™ Female Disconnects, Fully Insulated

B1. Cable Ties

### Type DPF-FIB

B2. Cable Accessories

B3. Stainless Steel Ties

C1. Wiring Duct

C2. Surface Raceway

C3. Abrasion Protection

C4. Cable Management

D1. Terminals

D2. Power Connectors

D3. Grounding Connectors

E1. Labeling Systems

E2. Labels

E3. Pre-Printed & Write-On Markers

E4. Permanent Identification

E5. Lockout/Tagout & Safety Solutions

F. Index

- Continuously molded design provides reliable, consistent performance through the applicator for a high quality termination every time
- Disconnect can be inserted and removed from the male tab without the use of tools for lower installed cost
- Premium nylon insulation retains its shape when crimped and provides a tight grip around the wire insulation for maximum strain relief

- Fully insulated design provides protection from electrical shorts
- Internal wire stop assures proper length of insertion into terminal barrel, providing a higher quality connection
- UL Flammability UL 94V-2, maximum insulation temperature 221°F (105°C)
- UL and CSA rated up to 600 V per UL 310

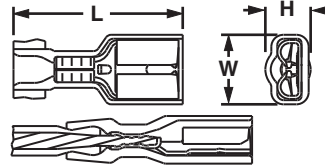

Cross section of DiscoGrip™ Crimp showing insulation crimp of the wire insulation.

Part Number	Wire Range	Color Code	Max. Ins. (In.)	Figure Dimensions (In.)			Tab Size		CA9 Series Crimp Die	CA-800/EZ Series Crimp Die	Pieces Per Reel
				L	W	H	In.	mm			
<b>DPF18-110FIB-3K</b>	22 – 18 AWG	Red	0.132	0.71	0.19	0.17	0.110 x 0.032	2.8 x 0.8	CD9-12A	CD-800-12	3000
<b>DPF18-111FIB-3K</b>			0.132	0.71	0.19	0.17	0.110 x 0.020	2.8 x 0.5			3000
<b>DPF18-187FIB-3K</b>			0.136	0.78	0.29	0.16	0.187 x 0.032	4.8 x 0.8			3000
<b>DPF18-188FIB-3K</b>			0.136	0.78	0.29	0.16	0.187 x 0.020	4.8 x 0.5	CD9-10A	CD-800-10	3000
<b>DPF18-205FIB-3K</b>			0.136	0.78	0.31	0.22	0.187/0.205 x 0.032	4.8/5.2 x 0.8			3000
<b>DPF18-206FIB-3K</b>			0.136	0.78	0.31	0.22	0.187/0.205 x 0.020	4.8/5.2 x 0.5			3000
<b>DPF18-250FIB-3K</b>			0.136	0.84	0.35	0.22	0.250 x 0.032	6.3 x 0.8	3000		
<b>DPF14-187FIB-3K</b>			16 – 14 AWG	Blue	0.160	0.78	0.29	0.18	0.187 x 0.032	4.8 x 0.8	CD9-11A
<b>DPF14-205FIB-3K</b>	0.160	0.78			0.31	0.22	0.187/0.205 x 0.032	4.8/5.2 x 0.8	3000		
<b>DPF14-206FIB-3K</b>	0.160	0.78			0.31	0.22	0.187/0.205 x 0.020	4.8/5.2 x 0.5	3000		
<b>DPF14-250FIB-3K</b>	0.160	0.84			0.35	0.22	0.250 x 0.032	6.3 x 0.8	3000		
<b>DPF10-250FIB-2K</b>	12 – 10 AWG	Yellow	0.220	0.96	0.35	0.23	0.250 x 0.032	6.3 x 0.8	CD9-13B	CD-800-13	2000

For applicator information, see page D1.143.



## DiscoGrip™ Male Disconnects, Fully Insulated

### Type DPF-FIM

- Continuously molded design provides reliable, consistent performance through the applicator for a high quality termination every time
- Disconnect can be inserted and removed from the male tab without the use of tools for lower installed cost
- Fully insulated design provides protection from electrical shorts
- Premium nylon insulation retains its shape when crimped and provides a tight grip around the wire insulation for maximum strain relief

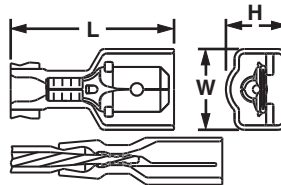

Cross section of DiscoGrip™ Crimp showing insulation crimp of the wire insulation.

- Oversized housing designed for maximum versatility to mate with most commercially available fully insulated female disconnects
- Internal wire stop assures proper length of insertion into terminal barrel, providing a higher quality connection
- UL Flammability UL 94V-2, maximum insulation temperature 221°F (105°C)
- UL and CSA rated up to 600 V per UL 310

Part Number	Wire Range	Color Code	Max. Ins. (In.)	Figure Dimensions (In.)			Tab Size		CA9 Series Crimp Die	CA-800/EZ Series Crimp Die	Pieces Per Reel
				L	W	H	In.	mm			
<b>Standard Housing</b>											
DPF18-250FIM-2K	22 – 18 AWG	Red	0.133	0.90	0.41	0.29	0.250 x 0.032	6.3 x 0.8	CD9-10B	CD-800-10	2000
DPF14-250FIM-2K	16 – 14 AWG	Blue	0.156						CD9-11B	CD-800-11	2000
<b>Oversized Housing</b>											
DPF18-250FIMB-K*	22 – 18 AWG	Red	0.133	0.92	0.46	0.34	0.250 x 0.032	6.3 x 0.8	CD9-10B	CD-800-10	1000
DPF14-250FIMB-K*	16 – 14 AWG	Blue	0.156						CD9-11B	CD-800-11	1000

\*To mate with other manufacturers fully insulated 0.250 x 0.032 female receptacles. For applicator information, see page D1.143.

A. System Overview

B1. Cable Ties

B2. Cable Accessories

B3. Stainless Steel Ties

C1. Wiring Duct

C2. Surface Raceway

C3. Abrasion Protection

C4. Cable Management

D1. Terminals

D2. Power Connectors

D3. Grounding Connectors

E1. Labeling Systems

E2. Labels

E3. Pre-Printed & Write-On Markers

E4. Permanent Identification

E5. Lockout/Tagout & Safety Solutions

F. Index

A. System Overview



## Disco™ Male Disconnects, Nylon Fully Insulated – Funnel Entry

B1. Cable Ties

### Type DNF-FIM

- Continuously molded design provides reliable, consistent performance through the applicator for a high quality termination every time
- Male tab couples with (all 0.250 x 0.032) female disconnects
- Fully insulated design provides protection from electrical shorts

- Male tab can be inserted and removed from the female disconnect without the use of tools for lower installed cost
- UL Flammability UL 94V-2/HB, maximum insulation temperature 221°F (105°C)
- UL and CSA rated up to 600 V per UL 310

B2. Cable Accessories

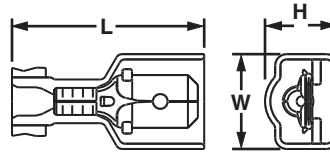

B3. Stainless Steel Ties

C1. Wiring Duct

C2. Surface Raceway

C3. Abrasion Protection

C4. Cable Management

D1. Terminals

D2. Power Connectors

D3. Grounding Connectors

E1. Labeling Systems

E2. Labels

E3. Pre-Printed & Write-On Markers

E4. Permanent Identification

E5. Lockout/Tagout & Safety Solutions

F. Index

Part Number	Wire Range	Color Code	Max. Ins. (In.)	Figure Dimensions (In.)			Tab Size		CA9 Series Crimp Die	CA-800/EZ Series Crimp Die	Pieces Per Reel
				L	W	H	In.	mm			
<b>Standard Housing</b>											
<b>DNF18-250FIM-2K</b>	22 – 18 AWG	Red	0.133	0.90	0.42	0.30	0.250 x 0.032	6.3 x 0.8	CD9-4B	CD-800-4	2000
<b>DNF14-250FIM-2K</b>	16 – 14 AWG	Blue	0.158	0.90	0.42	0.30	0.250 x 0.032	6.3 x 0.8	CD9-5B	CD-800-5	2000
<b>Oversized Housing</b>											
<b>DNF18-250FIMB-K*</b>	22 – 18 AWG	Red	0.135	0.91	0.45	0.34	0.250 x 0.032	6.3 x 0.8	CD9-4B	CD-800-4	1000
<b>DNF14-250FIMB-K*</b>	16 – 14 AWG	Blue	0.160	0.91	0.46	0.34	0.250 x 0.032	6.3 x 0.8	CD9-5B	CD-800-5	1000
<b>DNF10-250FIMB-K</b>	12 – 10 AWG	Yellow	0.220	0.96	0.45	0.36	0.250 x 0.032	6.3 x 0.8	CD9-18B	CD-800-18	1000

\*To mate with other manufacturers' fully insulated 0.250 x 0.032 female receptacles. For applicator information, see page D1.143.



## Disco™ Male Disconnects, Nylon Fully Insulated – Expanded Wire Entry

### Type DNF-FIMX

- Continuously molded design provides reliable, consistent performance through the applicator for a high quality termination every time
- Expanded wire entry designed to accommodate wire with a larger insulation thickness
- Male tab couples with (all 0.250 x 0.032) female disconnects
- Fully insulated design provides protection from electrical shorts

- Male tab can be inserted and removed from the female disconnect without the use of tools for lower installed cost
- Internal barrel serrations assure good wire contact and maximum tensile strength
- UL Flammability UL 94V-2/HB, maximum insulation temperature 221°F (105°C)
- UL and CSA rated up to 600 V per UL 310

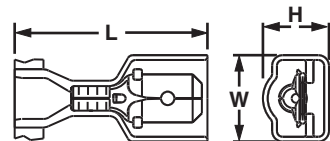

Part Number	Wire Range	Color Code	Max. Ins. (In.)	Figure Dimensions (In.)			Tab Size		CA9 Series Crimp Die	CA-800/EZ Series Crimp Die	Pieces Per Reel
				L	W	H	In.	mm			
<b>DNF18250FIMX-2K*</b>	22 – 18 AWG	Red	0.244	0.97	0.41	0.29	0.250 x 0.032	6.3 x 0.8	CD9-8B	CD-800-8	2000
<b>DNF14250FIMX-2K**</b>	16 – 14 AWG	Blue									2000

\*CSA Certified for use with (2) #18 AWG, (2) #20 AWG, or (2) #22 AWG wires.

\*\*CSA Certified for use with (2) #16 AWG or (2) #18 AWG wires.

For applicator information, see page D1.143.





## Disco™ Male Disconnects, Nylon Barrel Insulated – Funnel Entry

### Type DNF-M

- Continuously molded design provides reliable, consistent performance through the applicator for a high quality termination every time
- Male tab couples with (all 0.250 x 0.032) female disconnects
- Male tab can be inserted and removed from the female disconnect without the use of tools for lower installed cost
- Metal insulation grip sleeve crimps to wire insulation, providing protection to the crimp joint during high vibration applications
- Internal barrel serrations assure good wire contact and maximum tensile strength
- UL Flammability UL 94V-2/HB, maximum insulation temperature 221 °F (105°C)
- Rated up to 600 V

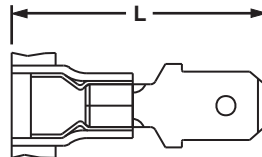

Part Number	Wire Range	Color Code	Max. Ins. (In.)	Figure Dimensions (In.)		Tab Size		CA9 Series Crimp Die	CA-800/EZ Series Crimp Die	Pieces Per Reel
				L	In.	mm				
DNF18-250M-3K	22 – 18 AWG	Red	0.145	0.90	0.250 x 0.032	6.3 x 0.8	CD9-1A	CD-800-1	3000	
DNF14-250M-3K	16 – 14 AWG	Blue	0.162	0.90	0.250 x 0.032	6.3 x 0.8	CD9-2A	CD-800-2	3000	
DNF10-250M-2K	12 – 10 AWG	Yellow	0.225	0.95	0.250 x 0.032	6.3 x 0.8	CD9-3B	CD-800-3	2000	

For applicator information, see page D1.143.



## Disco™ Male Disconnects, Vinyl Barrel Insulated – Funnel Entry

### Type DV-MB

- Continuously molded design provides reliable, consistent performance through the applicator for a high quality termination every time
- Male tab couples with (all 0.250 x 0.032) female disconnects
- Insulation support helps to prevent wire damage in bending applications
- Male tab can be inserted and removed from the female disconnect without the use of tools for lower installed cost
- UL Flammability UL 94V-0, maximum insulation temperature 221°F (105°C)
- UL and CSA rated up to 600 V per UL 310

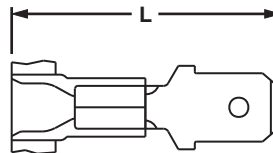

Part Number	Wire Range	Color Code	Max. Ins. (In.)	Figure Dimensions (In.)		Tab Size		CA9 Series Crimp Die	CA-800/EZ Series Crimp Die	Pieces Per Reel
				L	In.	mm				
DV18-250MB-3K	22 – 18 AWG	Red	0.155	0.90	0.250 x 0.032	6.3 x 0.8	CD9-1A	CD800-1	3000	
DV14-250MB-3K	16 – 14 AWG	Blue	0.175				CD9-2A	CD-800-2	3000	
DV10-250M-2K*	12 – 10 AWG	Yellow	0.225				CD9-3B	CD-800-3	2000	

\*Rated up to 300 V.

For applicator information, see page D1.143.

A. System Overview

B1. Cable Ties

B2. Cable Accessories

B3. Stainless Steel Ties

C1. Wiring Duct

C2. Surface Raceway

C3. Abrasion Protection

C4. Cable Management

D1. Terminals

D2. Power Connectors

D3. Grounding Connectors

E1. Labeling Systems

E2. Labels

E3. Pre-Printed & Write-On Markers

E4. Permanent Identification

E5. Lockout/Tagout & Safety Solutions

F. Index

A. System Overview

## Pin Terminals, Vinyl Insulated – Funnel Entry

### Type PV-PB

- Continuously molded design provides reliable, consistent performance through the applicator for a high quality termination every time
- Solid pin designed to prevent damage to the wire from over tightening, resulting in a reliable electrical connection
- For use with pin-type terminal blocks
- Insulation support helps to prevent wire damage in bending applications
- UL Flammability UL 94V-0, maximum insulation temperature 221°F (105°C)
- UL rated up to 600 V per UL 486A/B

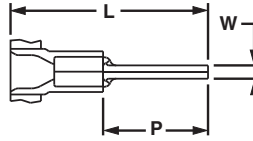

B1. Cable Ties

B2. Cable Accessories

B3. Stainless Steel Ties

C1. Wiring Duct

C2. Surface Raceway

C3. Abrasion Protection

C4. Cable Management

D1. Terminals

D2. Power Connectors

D3. Grounding Connectors

E1. Labeling Systems

E2. Labels

E3. Pre-Printed & Write-On Markers

E4. Permanent Identification

E5. Lockout/Tagout & Safety Solutions

F. Index

Part Number	Wire Range	Color Code	Max. Ins. (In.)	Figure Dimensions (In.)			CA9 Series Crimp Die	CA-800/EZ Series Crimp Die	Pieces Per Reel
				L	W	P			
<b>PV18-P47B-3K</b>	22 – 18 AWG	Red	0.150	0.90	0.07	0.49	CD9-1A	CD-800-1	3000
<b>PV14-P47B-3K</b>	16 – 14 AWG	Blue	0.170	0.90	0.07	0.49	CD9-2A	CD-800-2	3000

For applicator information, see page D1.143.

## Male Blade Adapters, Vinyl Insulated – Funnel Entry

### Type DV-MB

- Continuously molded design provides reliable, consistent performance through the applicator for a high quality termination every time
- Flat blade design to prevent damage to the wire from over tightening, resulting in a reliable electrical connection
- For use with blade-type terminal blocks
- Insulation support helps to prevent wire damage in bending applications
- UL Flammability UL 94V-0, maximum insulation temperature 221°F (105°C)
- Rated up to 600 V

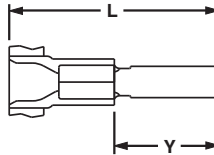

Part Number	Wire Range	Color Code	Max. Ins. (In.)	Figure Dimensions (In.)		Tab Size (In.)	CA9 Series Crimp Die	CA-800/EZ Series Crimp Die	Pieces Per Reel
				L	Y				
<b>DV18-145MB-3K</b>	22 – 18 AWG	Red	0.155	0.90	0.42	0.145 x 0.032	CD9-1A	CD-800-1	3000
<b>DV14-145MB-3K</b>	16 – 14 AWG	Blue	0.175	0.90	0.42	0.145 x 0.032	CD9-2A	CD-800-2	3000

For applicator information, see page D1.143.



## Butt Splices Nylon Insulated and Premium Grade Nylon

### Type BSN, BSP

- Continuously molded design provides reliable, consistent performance through the applicator for a high quality termination every time
- Designed to splice two solid or stranded wires together to repair or lengthen wires
- Butted configuration provides low profile for limited space applications
- Brazed seam protects terminal barrel from splitting during the crimp process
- Internal wire stop assures proper length of insertion into terminal barrel
- Premium grade nylon insulation available for applications requiring a tighter grip around the wire insulation for maximum strain relief
- UL Flammability UL 94V-2/HB, maximum insulation temperature 221°F (105°C)
- UL and CSA rated up to 600 V per UL 486C

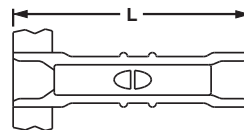

Part Number	Wire Range	Color Code	Max. Ins. (In.)	Figure Dimensions (In.)	CA9 Series Crimp Die	CA-800/EZ Series Crimp Die	Pieces Per Reel
				L			
<b>BSN18-3K</b>	22 – 16 AWG	Red	0.150	0.95	CD9-1A	CD-800-1	3000
<b>BSN14-3K</b>	18 – 14 AWG	Blue	0.170	0.95	CD9-2A	CD-800-2	3000
<b>BSN10-2K</b>	12 – 10 AWG	Yellow	0.230	0.95	CD9-17B	CD-800-17	2000
<b>BSP18-3K</b>	22 – 16 AWG	Red	0.150	0.96	CD9-1A	CD-800-1	3000
<b>BSP14-3K</b>	18 – 14 AWG	Blue	0.170	0.96	CD9-2A	CD-800-2	3000

For applicator information, see page D1.143.

## Features and Benefits – Reel Smart™ Metric Disconnects

### Metric Supra-Grip™ Nylon Fully Insulated Female Disconnects Type DMNG-FB

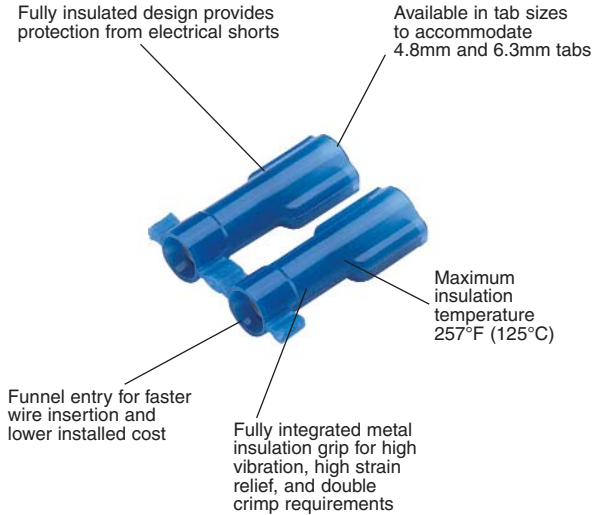

UL and CSA rated up to 600 V per UL 310.  
Flammability – UL 94V-2/HB.

### Metric Disco-Lok™ Nylon Fully Insulated, Funnel Entry, Female Receptacle Type DMNG-FL

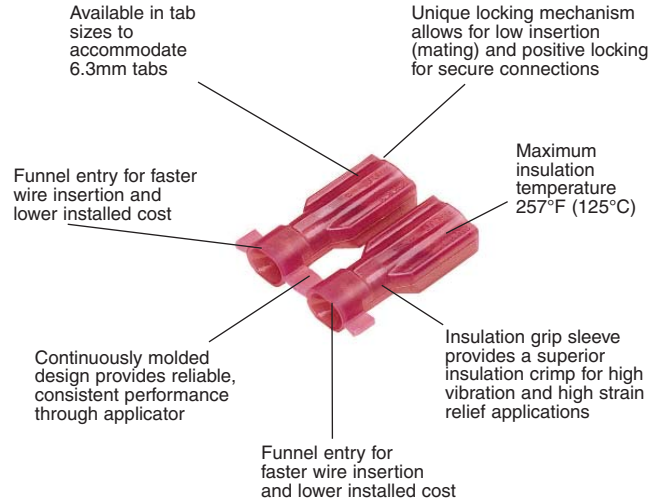

Rated up to 300 V.  
Flammability UL 94V-2/HB.

### Metric Standard and Premium Nylon Fully Insulated, Funnel Entry, Female Receptacles and Male Tabs Type DMNF and DMPF

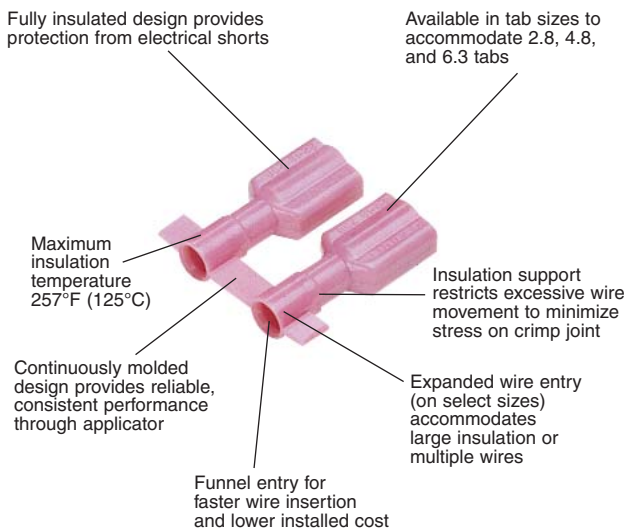

UL and CSA rated up to 600 V per UL 310.  
Flammability – UL 94V-2.

### Metric Vinyl Barrel Insulated Funnel Entry, Female Receptacles and Male Tabs Type DMV

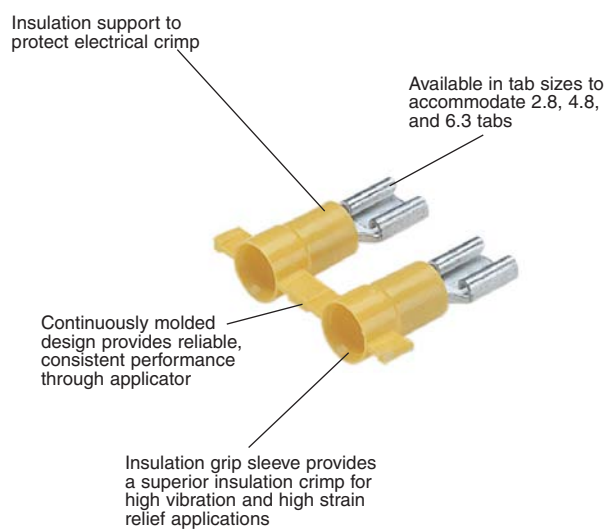

Rated up to 600 V.  
Flammability UL 94V-0.

A. System Overview

B1. Cable Ties

B2. Cable Accessories

B3. Stainless Steel Ties

C1. Wiring Duct

C2. Surface Raceway

C3. Abrasion Protection

C4. Cable Management

D1. Terminals

D2. Power Connectors

D3. Grounding Connectors

E1. Labeling Systems

E2. Labels

E3. Pre-Printed & Write-On Markers

E4. Permanent Identification

E5. Lockout/Tagout & Safety Solutions

F. Index

A. System Overview

## Part Number System for Reel Smart™ Metric Disconnects

B1. Cable Ties

B2. Cable Accessories

B3. Stainless Steel Ties

C1. Wiring Duct

C2. Surface Raceway

C3. Abrasion Protection

C4. Cable Management

D1. Terminals

D2. Power Connectors

D3. Grounding Connectors

E1. Labeling Systems

E2. Labels

E3. Pre-Printed & Write-On Markers

E4. Permanent Identification

E5. Lockout/Tagout & Safety Solutions

F. Index

**DM**

Type

D = Disconnect Metric

**NF**

Insulation

N = Nylon  
NF = Nylon Funnel Entry  
V = Vinyl

**1**

Wire Range

1 = 0.5 – 1.0mm<sup>2</sup>  
2 = 1.5 – 2.5mm<sup>2</sup>  
6 = 4.0 – 6.0mm<sup>2</sup>

—

**285**

Size and Type

283 = 2.8mm x 0.3mm Tab Size  
285 = 2.8mm x 0.5mm Tab Size  
288 = 2.8mm x 0.8mm Tab Size  
485 = 4.8mm x 0.5mm Tab Size  
488 = 4.8mm x 0.8mm Tab Size  
63 = 6.3mm x 0.8mm Tab Size

**FIB**

Special Configuration

B = Butted Seam  
FB = Metal Insulation Grip, Female  
FL = Fully Insulated Positive Locking Female  
FIB = Fully Insulated, Butted Seam, Female  
FIBX = Fully Insulated, Butted Seam, Female, Expanded Wire Entry  
FIM = Fully Insulated Male  
FIMB = Fully Insulated, Male, Oversized Housing  
FIMX = Fully Insulated, Male, Expanded Wire Entry  
M = Male  
MB = Male Butted Seam

**3K**

Std. Pkg. Size

K = 1,000  
KD = 1,500  
2K = 2,000  
3K = 3,000



## Metric Supra-Grip™ Female Disconnects, Nylon Fully Insulated – Funnel Entry

### Type DMNG-FB

- Continuously molded design provides reliable, consistent performance through the applicator for a high quality termination every time
- Disconnect can be inserted and removed from the male tab without the use of tools for lower installed cost
- Flared barrel extension integrated into stamping to provide insulation grip for double crimp requirements

- Internal barrel serrations assure good wire contact and maximum tensile strength
- Internal wire stop assures proper length of insertion into terminal barrel, providing a higher quality connection
- Mates with DNF-FIMB family
- UL Flammability UL 94V-2/HB, maximum insulation temperature 257°F (125°C)
- UL and CSA rated up to 600 V per UL 310

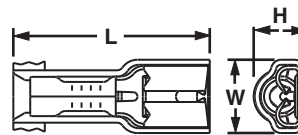

Part Number	Wire Range (mm <sup>2</sup> )	Color Code	Max. Ins. (mm)	Figure Dimensions (mm)			Tab Size (mm)	CA9 Series Crimp Die	CA-800/EZ Series Crimp Die	Pieces Per Reel
				L	W	H				
DMNG1-485FB-3K	0.5 – 1.0	Red	3.2	22.6	7.4	6.1	4.8 x 0.5	CD9-15A	CD-800-15	3000
DMNG1-488FB-3K			3.2	22.6	7.4	6.1	4.8 x 0.8			3000
DMNG1-63FB-3K			3.2	23.6	8.9	6.1	6.3 x 0.8			3000
DMNG2-485FB-3K*	1.5 – 2.5	Blue	3.9	22.6	7.4	6.1	4.8 x 0.5	CD9-16A	CD-800-16	3000
DMNG2-488FB-3K			3.9	22.6	7.4	6.1	4.8 x 0.8			3000
DMNG2-63FB-3K			3.9	23.6	8.9	6.1	6.3 x 0.8			3000

\*For #14 AWG wire applications, part to be used with copper alloy tabs only and is UL Recognized. For applicator information, see page D1.143.

## Metric Disco-Lok™ Female Disconnects, Nylon Fully Insulated – Funnel Entry

### Type DMNG-FL

- Continuously molded design provides reliable, consistent performance through the applicator for a high quality termination every time
- Disconnect can be inserted and removed from the male tab without the use of tools for lower installed cost
- Unique locking mechanism design allows for low insertion forces (mating) and positive lock for high vibration applications where a secure connection is mandatory
- Fully insulated design provides protection from electrical shorts
- Flared barrel extension integrated into stamping to provide insulation grip for double crimp requirements
- Insulation housing moves back and forth to engage and disengage locking mechanism for repeated use
- Specialty tool required to install this disconnect (CT-1014)
- Mates with DNF-FIMB family
- UL Flammability UL 94V-2/HB, maximum insulation temperature 257°F (125°C)
- Rated up to 300 V

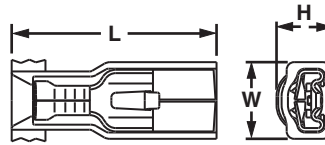

Part Number	Wire Range (mm²)	Color Code	Max. Ins. (mm)	Figure Dimensions (mm)			Tab Size (mm)	CA9 Series Crimp Die	CA-800/EZ Series Crimp Die	Pieces Per Reel
				L	W	H				
DMNG1-63FL-3K	0.5 – 1.0	Red	3.2	24.6	9.1	6.1	6.3 x 0.8	CD9-14A	CD-800-14	3000
DMNG2-63FL-3K	1.5 – 2.5	Blue	3.8	24.6	9.1	6.4	6.3 x 0.8	CD9-14A	CD-800-14	3000

For applicator information, see page D1.143.

## Metric Female Disconnects, Nylon Fully Insulated – Funnel Entry

### Type DMNF-FIB

- Continuously molded design provides reliable, consistent performance through the applicator for a high quality termination every time
- Disconnect can be inserted and removed from the male tab without the use of tools for lower installed cost
- Fully insulated design provides protection from electrical shorts
- Internal wire stop assures proper length of insertion into terminal barrel, providing a higher quality connection
- UL Flammability UL 94V-2/HB, maximum insulation temperature 221°F (105°C)
- UL and CSA rated up to 600 V per UL 310

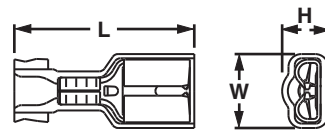

Part Number	Wire Range (mm²)	Color Code	Max. Ins. (mm)	Figure Dimensions (mm)			Tab Size (mm)	CA9 Series Crimp Die	CA-800/EZ Series Crimp Die	Pieces Per Reel	
				L	W	H					
DMNF1-283FIB-3K*	0.5 – 1.0	Natural	3.0	18.0	4.8	3.8	2.8 x 0.3	CD9-7A	CD-800-7	3000	
DMNF1-285FIB-3K			3.0	18.0	4.8	3.8	2.8 x 0.5			3000	
DMNF1-288FIB-3K			3.0	18.0	4.8	3.8	2.8 x 0.8			3000	
DMNF1-485FIB-3K			Red	3.4	19.8	7.4	4.1	4.8 x 0.5	CD9-4A	CD-800-4	3000
DMNF1-488FIB-3K				3.4	19.8	7.4	4.1	4.8 x 0.8			3000
DMNF1-63FIB-3K				3.4	21.3	8.9	5.6	6.3 x 0.8			3000
DMNF2-485FIB-3K	1.5 – 2.5	Blue	4.0	19.8	7.4	4.6	4.8 x 0.5	CD9-5A	CD-800-5	3000	
DMNF2-488FIB-3K			4.0	19.8	7.4	4.6	4.8 x 0.8			3000	
DMNF2-63FIB-3K			4.1	21.3	8.9	5.6	6.3 x 0.8			3000	
DMNF6-63FIB-2K			4.0 – 6.0	Yellow	5.6	24.4	8.9			5.8	6.3 x 0.8

\*UL/CSA standards do not exist for 2.8mm x 0.3mm (0.110" x 0.010") receptacles. For applicator information, see page D1.143.

A. System Overview



## Metric Disco™ Female Disconnect, Nylon Fully Insulated – Expanded Wire Entry

B1. Cable Ties

### Type DMNF-FIBX

- Continuously molded design provides reliable, consistent performance through the applicator for a high quality termination every time
- Expanded wire entry designed to accommodate wire with a larger insulation thickness
- Disconnect can be inserted and removed from the male tab without the use of tools for lower installed cost
- Fully insulated design provides protection from electrical shorts
- Internal wire stop assures proper length of insertion into terminal barrel, providing a higher quality connection
- UL Flammability UL 94V-2/HB, maximum insulation temperature 221°F (105°C)
- UL and CSA rated up to 600 V per UL 310

B2. Cable Accessories

B3. Stainless Steel Ties

C1. Wiring Duct

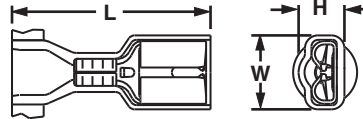

C2. Surface Raceway

C3. Abrasion Protection

C4. Cable Management

Part Number	Wire Range (mm <sup>2</sup> )	Color Code	Max. Ins. (mm)	Figure Dimensions (mm)			Tab Size (mm)	CA9 Series Crimp Die	CA-800/EZ Series Crimp Die	Pieces Per Reel
				L	W	H				
DMNF1485FIBX-2K	0.5 – 1.0	Red	5.3	22.1	7.9	5.5	5.2/4.8 x 0.5	CD9-6B	CD-800-6	2000
DMNF1488FIBX-2K			5.3	22.1	7.9	5.5	5.2/4.8 x 0.8			2000
DMNF1-63FIBX-2K			5.3	23.6	8.9	5.5	6.3 x 0.8			2000
DMNF2485FIBX-2K	1.5 – 2.5	Blue	6.1	22.1	7.9	5.5	5.2/4.8 x 0.5	CD9-8B	CD-800-8	2000
DMNF2488FIBX-2K			6.1	22.1	7.9	5.5	5.2/4.8 x 0.8			2000
DMNF2-63FIBX-2K			6.1	23.6	8.9	5.5	6.3 x 0.8			2000

For applicator information, see page D1.143.

D1. Terminals



## Metric Disco™ Female Disconnects, Nylon Fully Insulated – Right Angle

D2. Power Connectors

### Type DMNFR-FIB

- Continuously molded design provides reliable, consistent performance through the applicator for a high quality termination every time
- Right angle design for use in limited space applications
- Fully insulated design provides protection from electrical shorts
- Internal wire stop assures proper length of insertion into terminal barrel, providing a higher quality connection
- Disconnect can be inserted and removed from the male tab without the use of tools for lower installed cost
- UL Flammability UL 94V-2/HB, maximum insulation temperature 221°F (105°C)
- UL and CSA rated up to 600 V per UL 310

D3. Grounding Connectors

E1. Labeling Systems

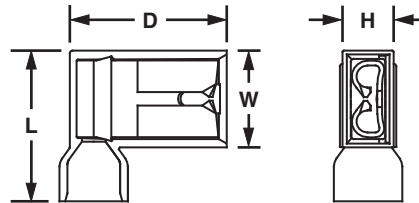

E2. Labels

E3. Pre-Printed & Write-On Markers

E4. Permanent Identification

E5. Lockout/Tagout & Safety Solutions

Part Number	Wire Range (mm <sup>2</sup> )	Color Code	Max. Ins. (mm)	Figure Dimension (mm)				Tab Size (mm)	CA9 Series Crimp Die	CA-800/EZ Series Crimp Die	Pieces Per Reel
				D	L	W	H				
DMNFR1485FIB-KD	0.5 – 1.0	Red	4.5	15.2	14.5	9.4	2.8	5.2/4.8 x 0.5	CD9-9C	CD-800-9	1500
DMNFR1488FIB-KD			4.5	15.2	14.5	9.4	3.1	5.2/4.8 x 0.8			1500
DMNFR163FIB-KD			4.5	15.2	14.5	9.4	3.1	6.3 x 0.8			1500
DMNFR2485FIB-KD	1.5 – 2.5	Blue	4.5	15.2	14.5	9.4	2.8	5.2/4.8 x 0.5	CD9-9C	CD-800-9	1500
DMNFR2488FIB-KD			4.5	15.2	14.5	9.4	3.1	5.2/4.8 x 0.8			1500
DMNFR263FIB-KD			4.5	15.2	14.5	9.4	3.1	6.3 x 0.8			1500

For applicator information, see page D1.143.

F. Index



## Metric Disco™ Female Disconnects, Vinyl Barrel Insulated – Funnel Entry

### Type DMV-B

- Continuously molded design provides reliable, consistent performance through the applicator for a high quality termination every time
- Disconnect can be inserted and removed from the male tab without the use of tools for lower installed cost

- Internal barrel serrations assure good wire contact and maximum tensile strength
- Internal wire stop assures proper length of insertion into terminal barrel, providing a higher quality connection
- UL Flammability UL 94V-0, maximum insulation temperature 221°F (105°C)
- UL and CSA rated up to 600 V per UL 310



Part Number	Wire Range (mm <sup>2</sup> )	Color Code	Max. Ins. (mm)	Figure Dimension (mm)			Tab Size (mm)	CA9 Series Crimp Die	CA-800/EZ Series Crimp Die	Pieces Per Reel
				L	W	H				
DMV1-485B-3K	0.5 – 1.0	Red	4.06	19.3	5.8	2.5	4.8 x 0.5	CD9-1A	CD-800-1	3000
DMV1-488B-3K			4.06	18.8	5.8	2.5	4.8 x 0.8	CD9-2A	CD-800-2	3000
DMV1-63B-3K			4.06	21.1	7.4	3.0	6.3 x 0.8	CD9-2A	CD-800-2	3000
DMV2-485B-3K	1.5 – 2.5	Blue	4.52	19.6	5.3	2.5	4.8 x 0.5	CD9-2A	CD-800-2	3000
DMV2-488B-3K			4.52	19.6	5.3	2.5	4.8 x 0.8	CD9-1A	CD-800-1	3000
DMV2-63B-3K			4.52	21.1	7.4	3.0	6.3 x 0.8	CD9-2A	CD-800-2	3000
DMV6-63-2K*	4.0 – 6.0	Yellow	5.84	24.1	7.4	3.0	6.3 x 0.8	CD9-3B	CD-800-8	2000

\*Not UL Listed or CSA Certified.  
For applicator information, see page D1.143.



## Metric DiscoGrip™ Female Disconnects, Fully Insulated – Funnel Entry

### Type DMPF-FIB

- Continuously molded design provides reliable, consistent performance through the applicator for a high quality termination every time
- Disconnect can be inserted and removed from the male tab without the use of tools for lower installed cost
- Premium nylon insulation retains its shape when crimped and provides a tight grip around the wire insulation for maximum strain relief

- Fully insulated design provides protection from electrical shorts
- Internal wire stop assures proper length of insertion into terminal barrel, providing a higher quality connection
- Male tab couples with (all 6.3mm x 0.8mm) female disconnects
- UL Flammability UL 94V-2, maximum insulation temperature 221°F (105°C)
- UL and CSA rated up to 600 V per UL 310

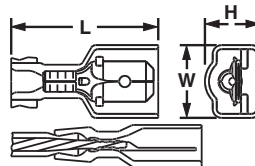

Cross section of DiscoGrip™ Crimp showing insulation crimp of the wire insulation.

Part Number	Wire Range (mm <sup>2</sup> )	Color Code	Max. Ins. (mm)	Figure Dimensions (mm)			Tab Size (mm)	CA9 Series Crimp Die	CA-800/EZ Series Crimp Die	Pieces Per Reel
				L	W	H				
DMPF1-285FIB-3K	0.5 – 1.0	Red	3.4	18.0	4.8	4.3	2.8 x 0.5	CD9-12A	CD-800-12	3000
DMPF1-288FIB-3K			3.4	18.0	4.8	4.3	2.8 x 0.8	CD9-12A	CD-800-12	3000
DMPF1-485FIB-3K			3.4	19.8	7.9	4.3	4.8 x 0.5	CD9-10A	CD-800-10	3000
DMPF1-488FIB-3K			3.4	19.8	7.9	4.3	4.8 x 0.8	CD9-10A	CD-800-10	3000
DMPF1-63FIB-3K			3.4	21.3	8.9	5.6	6.3 x 0.8	CD9-13A	CD-800-13	3000
DMPF2-485FIB-3K	1.5 – 2.5	Blue	4.0	19.8	7.9	4.8	4.8 x 0.5	CD9-11A	CD-800-11	3000
DMPF2-488FIB-3K			4.0	19.8	7.9	4.8	4.8 x 0.8	CD9-11A	CD-800-11	3000
DMPF2-63FIB-3K			4.0	21.3	8.9	5.6	6.3 x 0.8	CD9-11A	CD-800-11	3000
DMPF6-63FIB-2K*	4.0 – 6.0	Yellow	5.5	24.4	8.9	5.8	6.3 x 0.8	CD9-13A	CD-800-13	2000

\*Also approved for use with (2) 1.5 (#16) wires.  
For applicator information, see page D1.143.

A. System Overview

B1. Cable Ties

B2. Cable Accessories

B3. Stainless Steel Ties

C1. Wiring Duct

C2. Surface Raceway

C3. Abrasion Protection

C4. Cable Management

D1. Terminals

D2. Power Connectors

D3. Grounding Connectors

E1. Labeling Systems

E2. Labels

E3. Pre-Printed & Write-On Markers

E4. Permanent Identification

E5. Lockout/Tagout & Safety Solutions

F. Index

A. System Overview



## Metric DiscoGrip™ Male Disconnects, Fully Insulated – Funnel Entry

B1. Cable Ties

### Type DMPF-FIM

- Continuously molded design provides reliable, consistent performance through the applicator for a high quality termination every time
- Male tab can be inserted and removed from the female disconnect without the use of tools for lower installed cost
- Fully insulated design provides protection from electrical shorts
- Premium nylon insulation retains its shape when crimped and provides a tight grip around the wire insulation for maximum strain relief
- Oversized housing designed for maximum versatility to mate with most commercially available fully insulated female disconnects
- Internal wire stop assures proper length of insertion into terminal barrel, providing a higher quality connection
- Male tab couples with (all 6.3mm x 0.8mm) female disconnects
- UL Flammability UL 94V-2, maximum insulation temperature 221°F (105°C)
- UL and CSA rated up to 600 V per UL 310

B2. Cable Accessories

B3. Stainless Steel Ties

C1. Wiring Duct

C2. Surface Raceway

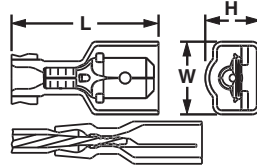

Cross section of DiscoGrip™ Crimp showing insulation crimp of the wire insulation.

C3. Abrasion Protection

C4. Cable Management

Part Number	Wire Range (mm <sup>2</sup> )	Color Code	Max. Ins. (mm)	Figure Dimensions (mm)			Tab Size (mm)	CA9 Series Crimp Die	CA-800/EZ Series Crimp Die	Pieces Per Reel
				L	W	H				

#### Standard Housing

DMPF1-63FIM-2K	0.5 – 1.0	Red	3.4	22.9	10.4	7.4	6.3 x 0.8	CD9-10B	CD-800-10	2000
DMPF2-63FIM-2K	1.5 – 2.5	Blue	4.0	22.9	10.4	7.4	6.3 x 0.8	CD9-11B	CD-800-11	2000

#### Oversized Housing

DMPF1-63FIMB-K*	0.5 – 1.0	Red	3.4	23.4	11.7	8.6	6.3 x 0.8	CD9-10B	CD-800-10	1000
DMPF2-63FIMB-K*	1.5 – 2.5	Blue	4.1	23.4	11.7	8.6	6.3 x 0.8	CD9-11B	CD-800-11	1000

\*To mate with other manufacturers' fully insulated 6.3mm x 0.8mm female receptacles. For applicator information, see page D1.143.

D1. Terminals

D2. Power Connectors



## Metric Disco™ Male Disconnects, Nylon Fully Insulated – Funnel Entry

### Type DMNF-FIM

- Continuously molded design provides reliable, consistent performance through the applicator for a high quality termination every time
- Male tab can be inserted and removed from the female disconnect without the use of tools for lower installed cost
- Internal barrel serrations assure good wire contact and maximum tensile strength
- UL Flammability UL 94V-2/HB, maximum insulation temperature 221°F (105°C)
- UL and CSA rated up to 600 V per UL 310
- Male tab couples with (all 6.3mm x 0.8mm) female disconnects
- Fully insulated design provides protection from electrical shorts

D3. Grounding Connectors

E1. Labeling Systems

E2. Labels

E3. Pre-Printed & Write-On Markers

E4. Permanent Identification

E5. Lockout/Tagout & Safety Solutions

F. Index

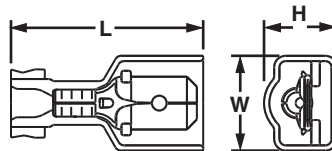

Part Number	Wire Range (mm <sup>2</sup> )	Color Code	Max. Ins. (mm)	Figure Dimensions (mm)			Tab Size (mm)	CA9 Series Crimp Die	CA-800/EZ Series Crimp Die	Pieces Per Reel
				L	W	H				

#### Standard Housing

DMNF1-63FIM-2K	0.5 – 1.0	Red	3.4	22.9	10.7	7.5	6.3 x 0.8	CD9-4B	CD-800-4	2000
DMNF2-63FIM-2K	1.5 – 2.5	Blue	4.0	22.9	10.7	7.5	6.3 x 0.8	CD9-5B	CD-800-5	2000

#### Oversized Housing

DMNF1-63FIMB-K*	0.5 – 1.0	Red	3.4	23.1	11.4	8.6	6.3 x 0.8	CD9-4B	CD-800-4	1000
DMNF2-63FIMB-K*	1.5 – 2.5	Blue	4.1	23.1	11.7	8.4	6.3 x 0.8	CD9-5B	CD-800-5	1000

\*To mate with other manufacturers' fully insulated 6.3mm x 0.8mm female receptacles. For applicator information, see page D1.143.





## Metric Disco™ Male Disconnects, Nylon Fully Insulated – Expanded Wire Entry

### Type DMNF-FIMX

- Continuously molded design provides reliable, consistent performance through the applicator for a high quality termination every time
- Expanded wire entry designed to accommodate wire with a larger insulation thickness
- Male tab couples with (all 6.3mm x 0.8mm) female disconnects
- Fully insulated design provides protection from electrical shorts

- Male tab can be inserted and removed from the female disconnect without the use of tools for lower installed cost
- Internal barrel serrations assure good wire contact and maximum tensile strength
- UL Flammability UL 94V-2/HB, maximum insulation temperature 221°F (105°C)
- UL and CSA rated up to 600 V per UL 310



Part Number	Wire Range (mm <sup>2</sup> )	Color Code	Max. Ins. (mm)	Figure Dimensions (mm)			Tab Size (mm)	CA9 Series Crimp Die	CA-800/EZ Series Crimp Die	Pieces Per Reel
				L	W	H				
DMNF1-63FIMX-2K*	0.5 – 1.0	Red	6.2	24.6	10.4	7.4	6.3 x 0.8	CD9-8B	CD-800-8	2000
DMNF2-63FIMX-2K**	1.5 – 2.5	Blue	6.2	24.6	10.4	7.4	6.3 x 0.8	CD9-8B	CD-800-8	2000

\*CSA Certified for use with (2) #16 AWG or (2) #18 AWG wires.

\*\*CSA Certified for use with (2) #18 AWG, (2) #20 AWG, or (2) #22 AWG wires.

For applicator information, see page D1.143.



## Metric Disco™ Male Disconnects, Nylon Barrel Insulated – Funnel Entry

### Type DMNF-M

- Continuously molded design provides reliable, consistent performance through the applicator for a high quality termination every time
- Male tab couples with (all 6.3mm x 0.8mm) female disconnects
- Male tab can be inserted and removed from the female disconnect without the use of tools for lower installed cost

- Metal insulation grip sleeve crimps to wire insulation, providing protection to the crimp joint during high vibration applications
- Internal barrel serrations assure good wire contact and maximum tensile strength
- UL Flammability UL 94V-2/HB, maximum insulation temperature 221°F (105°C)
- Rated up to 600 V



Part Number	Wire Range (mm <sup>2</sup> )	Color Code	Max. Ins. (mm)	Figure Dimensions (mm)	Tab Size (mm)	CA9 Series Crimp Die	CA-800/EZ Series Crimp Die	Pieces Per Reel
				L				
DMNF1-63M-3K	0.5 – 1.0	Red	3.7	22.9	6.3 x 0.8	CD9-1A	CD-800-1	3000
DMNF2-63M-3K	1.5 – 2.5	Blue	4.1	22.9	6.3 x 0.8	CD9-2A	CD-800-2	3000
DMNF6-63M-2K*	4.0 – 6.0	Yellow	5.7	24.1	6.3 x 0.8	CD9-3B	CD-800-3	2000

\*Not CSA Certified.

For applicator information, see page D1.143.

A. System Overview

B1. Cable Ties

B2. Cable Accessories

B3. Stainless Steel Ties

C1. Wiring Duct

C2. Surface Raceway

C3. Abrasion Protection

C4. Cable Management

D1. Terminals

D2. Power Connectors

D3. Grounding Connectors

E1. Labeling Systems

E2. Labels

E3. Pre-Printed & Write-On Markers

E4. Permanent Identification

E5. Lockout/Tagout & Safety Solutions

F. Index

A. System Overview



## Metric Disco™ Male Disconnects, Vinyl Barrel Insulated – Funnel Entry

B1. Cable Ties

### Type DMV-MB

B2. Cable Accessories

B3. Stainless Steel Ties

C1. Wiring Duct

- Continuously molded design provides reliable, consistent performance through the applicator for a high quality termination every time
- Male tab couples with (all 6.3mm x 0.8mm) female disconnects
- Insulation support helps to prevent wire damage in bending applications

- Male tab can be inserted and removed from the female disconnect without the use of tools for lower installed cost
- UL Flammability UL 94V-0, maximum insulation temperature 194°F (90°C)
- Rated up to 600 V

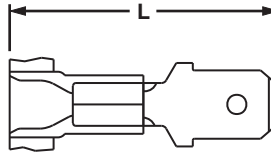

C2. Surface Raceway

C3. Abrasion Protection

C4. Cable Management

Part Number	Wire Range (mm <sup>2</sup> )	Color Code	Max. Ins. (mm)	Figure Dimension (mm)			CA9 Series Crimp Die	CA-800/EZ Series Crimp Die	Pieces Per Reel
				L	Tab Size (mm)				
<b>DMV1-63MB-3K</b>	0.5 – 1.0	Red	3.9	22.9	6.3 x 0.8		CD9-1A	CD-800-1	3000
<b>DMV2-63MB-3K</b>	1.5 – 2.5	Blue	4.5	22.9	6.3 x 0.8		CD9-2A	CD-800-2	3000
<b>DMV6-63M-2K*</b>	4.0 – 6.0	Yellow	6.1	24.4	6.3 x 0.8		CD9-3B	CD-800-3	2000

\*DMV6-63M-2K is not CSA Certified.  
For applicator information, see page D1.143.

D1. Terminals

## Metric Pin Terminals, Vinyl Insulated – Funnel Entry

D2. Power Connectors

D3. Grounding Connectors

### Type PMV-P

- Continuously molded design provides reliable, consistent performance through the applicator for a high quality termination every time
- Solid pin designed to prevent damage to the wire from over tightening, resulting in a reliable electrical connection

- Insulation support helps to prevent wire damage in bending applications
- For use with pin-type terminal blocks
- UL Flammability UL 94V-0, maximum insulation temperature 221°F (105°C)
- Rated up to 600 V

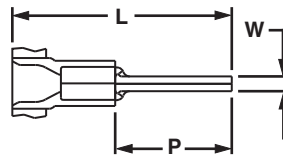

E1. Labeling Systems

E2. Labels

E3. Pre-Printed & Write-On Markers

E4. Permanent Identification

E5. Lockout/Tagout & Safety Solutions

F. Index

Part Number	Wire Range (mm <sup>2</sup> )	Color Code	Max. Ins. (mm)	Figure Dimensions (mm)			CA9 Series Crimp Die	CA-800/EZ Series Crimp Die	Pieces Per Reel
				L	W	P			
<b>PMV1-P12B-3K</b>	0.5 – 1.0	Red	3.8	22.6	2.0	10.0	CD9-1A	CD-800-1	3000
<b>PMV2-P12B-3K</b>	1.5 – 2.5	Blue	4.3	22.6	2.0	10.0	CD9-2A	CD-800-2	3000

For applicator information, see page D1.143.

## Metric Male Blade Adapters, Vinyl Insulated – Funnel Entry

### Type DMV-MB

- Continuously molded design provides reliable, consistent performance through the applicator for a high quality termination every time
- Flat blade design to prevent damage to the wire from over tightening, resulting in a reliable electrical connection
- For use with blade-type terminal blocks
- Insulation support helps to prevent wire damage in bending applications
- UL Flammability UL 94V-0, maximum insulation temperature 194°F (90°C)
- Rated up to 600 V

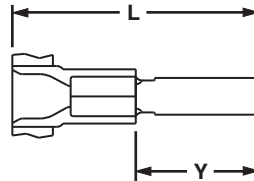

Part Number	Wire Range (mm <sup>2</sup> )	Color Code	Max. Ins. (mm)	Figure Dimensions (mm)		Tab Size (mm)	CA9 Series Crimp Die	CA-800/EZ Series Crimp Die	Pieces Per Reel
				L	Y				
DMV1-37MB-3K	0.5 – 1.0	Red	3.9	22.9	10.5	3.7 x 0.8	CD9-1A	CD-800-1	3000
DMV2-37MB-3K	1.5 – 2.5	Blue	4.5	22.9	10.5	3.7 x 0.8	CD9-2A	CD-800-2	3000

For applicator information, see page D1.143.

## Metric Butt Splices, Nylon Insulated

### Type BSMN, BSMP

- One-side machine applied termination replaces manual crimping
- Funnel entry on machine termination side to increase productivity
- Also hand crimped with Panduit CT-100A, CT-1550, or CT-1551 crimping tools
- Barrel locating ribs provide for accurate hand tool placement
- Available with insulation crimp premium grade nylon
- Brazed seam with center wire stop for increased performance and productivity
- UL Flammability UL 94V-2/HB, maximum insulation temperature 221°F (105°C)
- UL and CSA rated up to 600 V per UL 486C

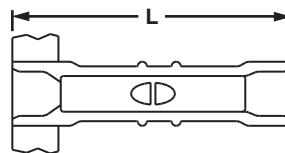

Part Number	Wire Range (mm <sup>2</sup> )	Color Code	Max. Ins. (mm)	Figure Dimension (mm)	CA9 Series Crimp Die	CA-800/EZ Series Crimp Die	Pieces Per Reel
				L			
BSMN1-3K	0.5 – 1.5	Red	3.8	24.1	CD9-1A	CD-800-1	3000
BSMN2-3K	1.5 – 2.5	Blue	4.3	24.1	CD9-2A	CD-800-2	3000
BSMN6-2K	4.0 – 6.0	Yellow	5.8	24.1	CD9-3B	CD-800-3	2000
BSMP1-3K	0.5 – 1.5	Red	3.8	24.1	CD9-1A	CD-800-1	3000
BSMP2-3K	1.5 – 2.5	Blue	4.3	24.1	CD9-2A	CD-800-2	3000

For applicator information, see page D1.143.

A.  
System  
Overview

## Features and Benefits – Reel Smart™ Ferrules

B1.  
Cable Ties

Panduit ferrules are available in strips and reels for wiring applications from #20 – 14 AWG. Offerings include insulated ferrules in single wire configurations. These insulated ferrules are color-coded to DIN standards.

B2.  
Cable  
Accessories

### Insulated Ferrules – Single Wire Type FS and FSD

Seamless tubular  
barrel provides  
consistent quality  
crimps

Maximum insulation  
temperature 192°F (89°C)



Color-coded polypropylene  
identifies wire size

C1.  
Wiring  
Duct

C2.  
Surface  
Raceway

C3.  
Abrasion  
Protection

C4.  
Cable  
Management

### Part Number System for Reel Smart® Ferrules

<b>F</b>	<b>S</b>	<b>D</b>	<b>75</b>	—	<b>8</b>	<b>5K or DSL</b>	<b>10</b>
Type	Wire Type	Color Code	Wire Size (mm <sup>2</sup> )		DIN Length	Std. Pkg. Size	Color-Code Number
F = Ferrule	S = Single	D = DIN = Standard (leave blank)				3K = 3,000 5K = 5,000 DSL = 50	0 = Black 2 = Red 3 = Orange 4 = Yellow 6 = Blue 7 = Light Blue 8 = Gray 10 = White

D1.  
Terminals

D2.  
Power  
Connectors

D3.  
Grounding  
Connectors

E1.  
Labeling  
Systems

E2.  
Labels

E3.  
Pre-Printed  
& Write-On  
Markers

E4.  
Permanent  
Identification

E5.  
Lockout/  
Tagout  
& Safety  
Solutions

F.  
Index



## Insulated Ferrules on Strips – Single Wire

### Type FS

- Polypropylene insulation housing available in DIN standard colors in strips of 50
- Continuously molded design provides consistent placement of ferrules in tool to ensure fast, reliable terminations
- Available in #20 – 14 AWG featuring a seamless barrel design to contain loose wire strands for superior terminations
- Designed for use with the Semiautomatic Ferrule Crimping Tool CT-1000 for medium volume applications

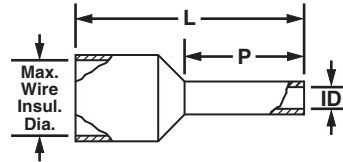
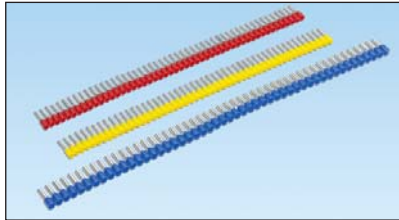

Part Number	Wire Size		Color	Max. Wire Insul. Dia.		Figure Dimensions						Wire Strip Length		Recommended Installation Tool	Std. Pkg. Qty.
	AWG	mm <sup>2</sup>		In.	mm	L		P		ID		In.	mm		

### DIN End Sleeves

FSD75-8-DSL10	20 AWG	0.50	White	0.10	2.6	0.60	15.2	0.31	8.0	0.04	1.0	13/32	10.0	CT-1000	500
FSD76-8-DSL8	18 AWG	0.75	Gray	0.11	2.7	0.60	15.2	0.31	8.0	0.06	1.5	13/32	10.0		500
FSD77-8-DSL2		1.00	Red	0.12	3.0	0.60	15.2	0.31	8.0	0.07	1.8	13/32	10.0		500
FSD78-8-DSL0	16 AWG	1.50	Black	0.13	3.2	0.60	15.2	0.31	8.0	0.09	2.3	13/32	10.0		500
FSD80-8-DSL6	14 AWG	2.50	Blue	0.16	4.0	0.60	15.2	0.31	8.0	0.09	2.3	13/32	10.0		500

### Additional Colored End Sleeves

FS75-8-DSL3	20 AWG	0.50	Orange	0.10	2.6	0.60	15.2	0.31	8.0	0.04	1.0	13/32	10.0	CT-1000	500
FS76-8-DSL10	18 AWG	0.75	White	0.11	2.7	0.60	15.2	0.31	8.0	0.05	1.2	13/32	10.0		500
FS76-8-DSL7			Light Blue	0.11	2.7	0.60	15.2	0.31	8.0	0.05	1.2	13/32	10.0		500
FS77-8-DSL4		1.00	Yellow	0.12	3.0	0.60	15.2	0.31	8.0	0.06	1.5	13/32	10.0		500
FS78-8-DSL2	16 AWG	1.50	Red	0.13	3.2	0.60	15.2	0.31	8.0	0.07	1.8	13/32	10.0		500
FS80-8-DSL8	14 AWG	2.50	Gray	0.16	4.0	0.60	15.2	0.31	8.0	0.09	2.3	13/32	10.0		500

A.  
System  
Overview

B1.  
Cable Ties

B2.  
Cable  
Accessories

B3.  
Stainless  
Steel Ties

C1.  
Wiring  
Duct

C2.  
Surface  
Raceway

C3.  
Abrasion  
Protection

C4.  
Cable  
Management

D1.  
Terminals

D2.  
Power  
Connectors

D3.  
Grounding  
Connectors

E1.  
Labeling  
Systems

E2.  
Labels

E3.  
Pre-Printed  
& Write-On  
Markers

E4.  
Permanent  
Identification

E5.  
Lockout/  
Tagout  
& Safety  
Solutions

F.  
Index

A. System Overview

## Semiautomatic Ferrule Crimping Tool – CT-1000

B1. Cable Ties

- Innovative rapid load design utilizes continuously molded ferrules to significantly reduce installation time
- Adjustable die setting allows termination of all Panduit #20 – 14 AWG continuously molded ferrules with a single tool
- Controlled cycle tool cuts, strips, and crimps wire to maximize efficiency

B2. Cable Accessories



B3. Stainless Steel Ties

Part Number	Part Description	Std. Pkg. Qty.
CT-1000	Controlled cycle crimp tool with trapezoid profile for #20 – 14 AWG (0.50 – 2.5mm <sup>2</sup> ) insulated continuously molded ferrules on strips. Also cuts and strips wire.	1

C1. Wiring Duct

C2. Surface Raceway

C3. Abrasion Protection



## Insulated Ferrules on Reels – Single Wire

### Type FS

C4. Cable Management

- Polypropylene insulation housing available in DIN standard colors in reels of 3000 and 5000
- Designed specifically for use with the Ferrule Applicator (CA10) for high volume applications
- Continuously molded design provides consistent placement of ferrules in applicator to ensure fast, reliable terminations
- Available in #20 – 14 AWG featuring a seamless barrel design to contain loose wire strands for superior terminations

D1. Terminals



D2. Power Connectors

D3. Grounding Connectors

Part Number	Wire Size		Color	Max. Wire Insul. Dia.		Figure Dimensions						Wire Strip Length		CA10 Series Dies	Pieces Per Reel
	AWG	mm <sup>2</sup>		In.	mm	L		P		ID		In.	mm		

E1. Labeling Systems

### DIN End Sleeves

FSD75-8-5K10	20 AWG	0.50	White	0.10	2.6	0.57	14.5	0.31	8.0	0.04	1.0	13/32	10.0	CD10-1	5000
FSD76-8-5K8	18 AWG	0.75	Gray	0.11	2.7	0.57	14.5	0.31	8.0	0.05	1.2	13/32	10.0		5000
FSD77-8-5K2	18 AWG	1.00	Red	0.12	3.0	0.57	14.5	0.31	8.0	0.06	1.5	13/32	10.0	CD10-2	5000
FSD78-8-5K0	16 AWG	1.50	Black	0.13	3.2	0.57	14.5	0.31	8.0	0.07	1.8	13/32	10.0		5000
FSD80-8-3K6	14 AWG	2.50	Blue	0.16	4.0	0.57	14.5	0.31	8.0	0.09	2.3	13/32	10.0	CD10-3	3000

E2. Labels

### Additional Colored End Sleeves

FS75-8-5K3	20 AWG	0.50	Orange	0.10	2.6	0.57	14.5	0.31	8.0	0.04	1.0	13/32	10.0	CD10-1	5000
FS76-8-5K10	18 AWG	0.75	White	0.11	2.7	0.57	14.5	0.31	8.0	0.05	1.2	13/32	10.0		5000
FS76-8-5K7	18 AWG	0.75	Light Blue	0.11	2.7	0.57	14.5	0.31	8.0	0.05	1.2	13/32	10.0	CD10-2	5000
FS77-8-5K4	18 AWG	1.00	Yellow	0.12	3.0	0.57	14.5	0.31	8.0	0.06	1.5	13/32	10.0		5000
FS78-8-5K2	16 AWG	1.50	Red	0.13	3.2	0.57	14.5	0.31	8.0	0.07	1.8	13/32	10.0	CD10-3	5000
FS80-8-3K8	14 AWG	2.50	Gray	0.16	4.0	0.57	14.5	0.31	8.0	0.09	2.3	13/32	10.0		3000

E4. Permanent Identification

E5. Lockout/Tagout & Safety Solutions

F. Index

## Reel Smart™ Ferrule Applicator – CA10

- Designed for use with continuously molded ferrules in reels of 3,000 or 5,000 for high volume applications
- Precision ferrule indexing through applicator for optimum reliability and productivity
- Universal base plate allows compatibility with the Panduit CP-871 electric press, and other commercially available bench presses and automatic wire processing (AWP) machines
- Quick change die sets terminate the entire ferrule line to provide fast product change over and reduction in setup time; dies sold separately



Part Number	Part Description	Std. Pkg. Qty.
CA10	Applicator used to terminate entire line of Reel Smart™ Continuously Molded Ferrules on reels. For use with CP-871 Electric Press and CD10 series die sets.	1
CD10-1	Die insert to be used with the CA10 applicator to terminate FS75, FSD75, FS76 and FSD76 Reel Smart™ Continuously Molded Ferrules.	1
CD10-2	Die insert to be used with the CA10 applicator to terminate FS77, FSD77, FS78 and FSD78 Reel Smart™ Continuously Molded Ferrules.	1
CD10-3	Die insert to be used with the CA10 applicator to terminate FS80 and FSD80 Reel Smart™ Continuously Molded Ferrules.	1

## CA9 Ezair™ and CA-800EZ Applicators

- Designed to terminate all continuously molded terminals, disconnects, and splices in reels of 3,000 or 5,000 for high volume applications
- Precision terminal indexing through applicator for optimum reliability and productivity
- Universal base plate allows compatibility with the Panduit CP-871 electric press, and other commercially available bench presses and automatic wire processing (AWP) machines
- Quick change die sets allow for fast product change over and reduction in setup time; dies sold separately



Part Number	Part Description	Std. Pkg. Qty.
CA-800EZ*	Applicator: runs in the AMP* Model T and K bench presses. True “quick change” applicator — no additional plates are necessary. Slide right into the press for easy changeover. Uses CD-800 series die inserts.	1
CA9	CA9 Ezair™ Applicator: terminates the entire Reel Smart™ product line. This greatly reduces set up and maintenance time and increases productivity. This patented applicator is so smart it automatically adjusts feed stroke to the correct pitch and length for the entire product line. Crimp die changeover in less than 1 minute, minimizes downtime and increases productivity. Fast, easy loading of terminal parts without special instructions or setup personnel. Simply feed the parts strip into the applicator. All the necessary adjustments are made by the dies and the automatic feed stroke. Used in CP-871 electric press. Safety lockout guard ensures operator safety. Positive stop adjustment rings allow for electrical and insulation crimp adjustments as desired.	1

\*AMP is a registered trademark of Tyco Electronics.  
For crimp die information, refer to pages D1.145 and D1.146.

A.  
System  
Overview

B1.  
Cable Ties

B2.  
Cable  
Accessories

B3.  
Stainless  
Steel Ties

C1.  
Wiring  
Duct

C2.  
Surface  
Raceway

C3.  
Abrasion  
Protection

C4.  
Cable  
Management

D1.  
Terminals

D2.  
Power  
Connectors

D3.  
Grounding  
Connectors

E1.  
Labeling  
Systems

E2.  
Labels

E3.  
Pre-Printed  
& Write-On  
Markers

E4.  
Permanent  
Identification

E5.  
Lockout/  
Tagout  
& Safety  
Solutions

F.  
Index

A.  
System  
Overview

## Electric Bench Press

B1.  
Cable Ties

- For use with Panduit Applicators and Reel Smart™ Continuously Molded Terminals and Ferrules to provide a superior solution for quality, high volume terminations

- Tool crimp height adjustment feature allows user to easily set and maintain desired crimp height for consistent performance

B2.  
Cable  
Accessories

- CP-871 press has a microprocessor based controller and LCD that displays text messages and cycle count with multi-language capability

- Applicator can be changed without the use of tools to facilitate faster changeover for lower cost of ownership

B3.  
Stainless  
Steel Ties



Part Number	Part Description	Std. Pkg. Qty.
CP-871	Electric press: 4000+ terminations per hour. Operates on 110 VAC current/60 Hz, 220 VAC current/50 Hz (field convertible). Overall size (without reel): 13" x 33" x 16". Total weight (without reel): 176 lbs. Includes foot pedal.	1

C1.  
Wiring  
Duct

C2.  
Surface  
Raceway

C3.  
Abrasion  
Protection

C4.  
Cable  
Management

## Die Sharpening Kits

- Used to resharpen cutting edges and maintain reliability of CD-800 and CD9 series cutter dies

Part Number	Part Description	Std. Pkg. Qty.
DSF-RS	For use with black oxide cutter dies.	1
DSF-NP	For use with nickel-plated cutter dies.	1

D1.  
Terminals

D2.  
Power  
Connectors

D3.  
Grounding  
Connectors

E1.  
Labeling  
Systems

E2.  
Labels

E3.  
Pre-Printed  
& Write-On  
Markers

E4.  
Permanent  
Identification

E5.  
Lockout/  
Tagout  
& Safety  
Solutions

F.  
Index



## Die Information

Part Number	AWG Wire Range	Color Code	(1) Wire Insulation Strain Relief	Part No. Prefix	60/40 Solder Slug Dia.		Spare Part Number				
					In.	mm	Crimp Die	Cutter Die	Lower Die		
CD-800-1	22 – 18, 22 – 16	Red	Plastic Ins. Crimp, Insulation Support, Metal Ins. Crimp, Plastic Ins. Crimp	PV, DV-MB, DV-B, BSN, PN, PNF, DNF-M, BSP (Premium Nylon)	0.188	4.78	TD13471C06 CD-800-1	TD13483C02 CD-800 C1	TD17755B01 CD-1		
CD-800-1D***	22-18										
CD-800-2	16 – 14, 18 – 14	Blue	Plastic Ins. Crimp, Insulation Support, Metal Ins. Crimp, Plastic Ins. Crimp	PV, DV-MB, DV-B, BSN, PN, PNF, DNF-M, BSP (Premium Nylon)			TD13473C05 CD-800-2	TD13486C03 CD-800C-2	TD17756B01 C-2		
CD-800-2D***	16 – 14										
CD-800-3	12 – 10, 14 – 10, 16 – 12	Yellow	Plastic Ins. Crimp, Plastic Ins. Crimp, Metal Ins. Crimp, Plastic Ins. Crimp, Metal Ins. Crimp	PV, PV12, DV, DV-C, PN12, PV12, DV-M, PN, PNF, DNF-M			TD13475C06 CD-800-3	TD13489C02 CD-800C-3	TD17757B01 C-3		
CD-800-4	12 – 18	Red	Insulation Support	DNF-FIB, DNF-FIM, DNF-FIMB, DNF-LPB						TD13833C06 CD-800-4, 10	TD13505C02 CD-800 C-4
CD-800-5	16 – 14	Blue	Insulation Support	DNF-FIB, DNF-FIM, DNF-FIMB, DNF-LPB			TD13634C05 CD-800-5, 11	TD13508C02 CD-800 C-5	TD17759B01 C-5, 11		
CD-800-6	22 – 18	Red	Insulation Support	DNF-FIBX						TD13652C04 CD-800-6	TD13499C02 CD-800C-6
CD-800-7	22 – 18	Red	Insulation Support	DNF-110FIB, DNF-111FIB, DNF-112FIB			0.125	3.18	TD13477C05 CD-800-7, 12		
CD-800-8	22 – 18, 16 – 14	Red/ Blue	Insulation Support	DNF-FIBX, DNF-FIMX, DNF-FIMX			0.188	4.78	TD13481C06 CD-800-8	TD13502C03 CD-800 C-8	TD17762B01 C-8
CD-800-9	22 – 14	Red/ Blue	Insulation Support	DNFR-FIB	0.125	3.18	TD13479C05 CD-800-9	TD13495C02 CD-800 C-9	TD17763B01 C-9		
CD-800-10	22 – 18	Red	DiscoGrip™ Insulation Crimp	DPF-FIB, DPF-FIM, DPF-FIMB, DPF-LPB	0.188	4.78	TD13633C06 CD-800-4, 10	TD16233C02 CD-800 C-10	TD17758B01 C-4, 10		
CD-800-11	16 – 14	Blue	DiscoGrip™ Insulation Crimp	DPF-FIM, DPF-FIMB, DPF-FIB, DPF-LPB						TD13634C05 CD-800-5, 10	TD16243C01 CD-800 C-11
CD-800-12	22 – 18	Red	DiscoGrip™ Insulation Crimp	DPF-110FIB, DPF-111FIB	0.125	3.18	TD13477C05 CD-800-7, 12	TD16235C02 CD-800 C-12	TD17761B01 C-7, 12		
CD-800-13	12 – 10	Yellow	Insulation Support, DiscoGrip™ Insulation Crimp	DNF-FIB, DPF-FIB	0.188	4.78	TD19116C03 CD-800-13	TD19115C05 CD-800 C-13	TD19424B01 C-13		
CD-800-14	22 – 18, 16 – 14	Red/ Blue	Metal Insulation Crimp	DNG-FL	0.125	3.18	TD22943C01 CD-800-14	TD22944C01 CD-800 C-14	TD22960B01 C-14		
CD-800-15	22 – 18	Red	Metal Insulation Crimp	DNG-FB	0.188	4.78	TD22945C01 CD-800-15	TD22946C01 CD-800 C-15	TD22961B01 C-15		
CD-800-16	16 – 14	Blue	Metal Insulation Crimp	DNG-FB						TD22947C01 CD-800-16	TD22948C01 CD-800 C-16
CD-800-17	12 – 10	Yellow	Insulation Support	BSN	0.188	4.78	TD23601C01 CD-800-17	TD23600C01 CD-800-17	TD23612B01 CD-800-17		
CD-800-18	12 – 10	Yellow	Plastic Insulation Crimp	DNF-FIMB						TD13475C06 CD-800-18	TD23773C01 CD-800-18

TA13721A01 = 60/40 Solder Slug with 1/8" (.125) outer diameter.

TA13722A01 = 60/40 Solder Slug with 3/16" (.188) outer diameter.

(1) Insulation Support: Minimum wire insulation strain relief for normal applications.

Plastic and DiscoGrip™ Insulation Crimp: Secondary wire insulation strain relief for high vibration or conductor strain applications.

Metal Insulation Grip: Maximum wire insulation strain relief for high vibration or conductor strain applications.

\*\*\*Modified lower die for barrel insulated disconnects DV-B series. Available as a complete die set or just lower die assembly.

Table continues on page D1.146

A. System Overview

## Die Information (continued)

B1. Cable Ties

B2. Cable Accessories

B3. Stainless Steel Ties

C1. Wiring Duct

C2. Surface Raceway

C3. Abrasion Protection

C4. Cable Management

D1. Terminals

D2. Power Connectors

D3. Grounding Connectors

E1. Labeling Systems

E2. Labels

E3. Pre-Printed & Write-On Markers

E4. Permanent Identification

E5. Lockout/Tagout & Safety Solutions

F. Index

Part Number	Color Code	AWG Wire Range	Wire Insulation Strain Relief	Part No. Prefix	60/40 Solder Slug Diameter		Spare Part Number		
					In.	mm	Crimp Die	Cutter Die	Lower Die
<b>CD9-1A</b>	Red	22 – 16, 22 – 18	Insulation Support, Plastic Ins. Crimp, Plastic Ins. Crimp, Metal Ins. Grip	BSN, BSP, PV, DV-B, DV-MB, PN, PNF, DNF-M	0.188	4.78	TD24129C01	TD24139C01	TD24149C01
<b>CD9-1AD***</b>		22 – 18	Plastic Insulation Crimp, Metal Insulation Grip	PV, DV-B, DV-MB, PN, PNF, DNF-M	0.188	4.78			
<b>CD9-1B</b>		22 – 18	Plastic Insulation Crimp	PV-56R, PV-38R	0.188	4.78			
<b>CD9-2A</b>	Blue	18 – 14, 16 – 14	Insulation Support, Plastic Ins. Crimp, Insulation Support, Plastic Ins. Crimp, Metal Ins. Grip	BSN, BSP, BSN, PV, DV-B, DV-MB, PN, PNF, DNF-M	0.188	4.78	TD24130C01	TD24140C01	TD23712C01
<b>CD9-2AD***</b>		16 – 14	Insulation Support, Plastic Insulation Crimp, Metal Insulation Grip	BSN, PV, DV-B, DV-MB, PN, PNF, DNF-M	0.188	4.78			
<b>CD9-2B</b>		16 – 14	Plastic Insulation Crimp	PV-56R, PV-38R	0.188	4.78			
<b>CD9-3B</b>	Yellow	12 – 10, 16 – 12	Plastic Ins. Crimp, Metal Ins. Grip, Plastic Ins. Crimp	PV, DV, DV-M, PN, PNF, DNF-M, PV12, PN12	0.188	4.78	TD24131C01	TD24141C01	TD23713C01
<b>CD9-4A</b>	Red	22 – 18	Insulation Support	DNF-FIB, DNF-LPB	0.188	4.78	TD24132C01	TD24142C01	TD24150C01
<b>CD9-4B</b>		22 – 18	Insulation Support	DNF-FIM, DNF-FIMB	0.188	4.78			
<b>CD9-5A</b>	Blue	16 – 14	Insulation Support	DNF-FIB, DNF-LPB	0.188	4.78	TD24133C01	TD24143C01	TD24151C01
<b>CD9-5B</b>		16 – 14	Insulation Support	DNF-FIM, DNF-FIMB	0.188	4.78			
<b>CD9-6B</b>	Red	22 – 18	Insulation Support	DNF-FIBX	0.188	4.78	TD23700C01	TD23683C01	TD23716C01
<b>CD9-7A</b>	Red	22 – 18	Insulation Support	DNF-110, 111, 112FIB	0.125	3.18	TD23701C02	TD23684C01	TD23717C01
<b>CD9-8B</b>	Blue/ Red	16 – 14, 22 – 14	Insulation Support	DNF-FIBX, DNF-FIMX	0.188	4.78	TD23702C01	TD23685C01	TD23718C01
<b>CD9-9C</b>	Red/ Blue	22 – 14	Insulation Support	DNFR-FIB	0.125	3.18	TD23703C01	TD23686C01	TD23719C01
<b>CD9-10A</b>	Red	22 – 18	DiscoGrip™ Insulation Crimp	DPF-FIB, DPF-LPB	0.188	4.78	TD24132C01	TD24144C01	TD24150C01
<b>CD9-10B</b>	Red	22 – 18	DiscoGrip™ Insulation Crimp	DPF-FIM, DPF-FIMB	0.188	4.78			
<b>CD9-11A</b>	Blue	16 – 14	DiscoGrip™ Insulation Crimp	DPF-FIB, DPF-LPB	0.188	4.78	TD24133C01	TD23688C01	TD24151C01
<b>CD9-11B</b>	Blue	16 – 14	DiscoGrip™ Insulation Crimp	DPF-FIM, DPF-FIMB	0.188	4.78			
<b>CD9-12A</b>	Red	22 – 18	DiscoGrip™ Insulation Crimp	DPF-110FIB, DFP-111FIB	0.125	3.18	TD23701C02	TD23689C01	TD23717C01
<b>CD9-13B</b>	Yellow	12 – 10	Insulation Support, DiscoGrip™ Insulation Crimp	DNF-FIB, DPF-FIB	0.188	4.78	TD24134C01	TD24145C01	TD24152C01
<b>CD9-14A</b>	Red/ Blue	22 – 18, 16 – 14	Metal Insulation Grip	DNG-FL	0.125	3.18	TD23705C01	TD23691C01	TD23721C01
<b>CD9-15A</b>	Red	22 – 18	Metal Insulation Grip	DNG-FB	0.188	4.78	TD24135C01	TD24146C01	TD24153C01
<b>CD9-16A</b>	Blue	16 – 14	Metal Insulation Grip	DNG-FB	0.188	4.78	TD24136C01	TD24147C01	TD24154C01
<b>CD9-17B</b>	Yellow	12 – 10	Insulation Support	BSN	0.188	4.78	TD24110C01	TD24109C01	TD24111C01 TD24112C01
<b>CD9-18B</b>	Yellow	12 – 10	Insulation Support	DNF-FIMB	0.188	4.78	TD24131C01	TD23766C01	TD23713C01
<b>CD10-1</b>	—	20 – 18	Insulation Support	FS75, FSD75, FS76, FSD76	—	—	—	—	—
<b>CD10-2</b>	—	18 – 16	Insulation Support	FS77, FSD77, FS78, FSD78	—	—	—	—	—
<b>CD10-3</b>	—	14	Insulation Support	FS80, FSD80	—	—	—	—	—

TA13721A01 = 60/40 Solder Slug with 1/8" (.125) outer diameter.

TA13722A01 = 60/40 Solder Slug with 3/16" (.188) outer diameter.

(1) Insulation Support: Minimum wire insulation strain relief for normal applications.

Plastic and DiscoGrip™ Insulation Crimp: Secondary wire insulation strain relief for high vibration or conductor strain applications.

Metal Insulation Grip: Maximum wire insulation strain relief for high vibration or conductor strain applications.

\*\*\*Modified lower die for barrel insulated disconnects DV-B series. Available as a complete die set or just lower die assembly.

## CA10, CA9 Ezair™, and CA-800EZ Applicators Wire Processing Machine Manufacturer/Press Compatibility

Manufacturer	Wire Processing Machine with (WPM) or Bench Press Only	CA10	Panduit Applicators	
			CA9 Ezair™	CA-800EZ*
<b>PANDUIT</b>	CP-851 bench press only CP-861 bench press only CP-862 bench press only CP-871 bench press only	A	A <sup>1</sup> A <sup>1</sup>	A
<b>T/E CONNECTIVITY</b>	CLS III G with G press (AWP) CLS IV with G press (AWP) CLS IV G plus with G press (AWP) G bench press only CLS II with T press (AWP) CLS III with T press (AWP) T bench press only K bench press only	A A A A	A <sup>1</sup> A <sup>1</sup> A <sup>1</sup> A <sup>1</sup> A <sup>1</sup> A <sup>1</sup> A <sup>3</sup>	A A
<b>ARTOS</b>	CS-600 with AMP G press (AWP) CS-600 with TU7M press (AWP) CS-600 with TU-10 press (AWP) MTX Series 5 with TU-10 press (AWP)	A	A <sup>1</sup> A <sup>1</sup> A <sup>1</sup>	A
<b>GAMMA MECCANICA</b>	T20P-110V bench press only		A <sup>1</sup>	
<b>KODERA</b>	Series C451/C450 (AWP) Series C551/C550 (AWP)	A	A <sup>1</sup> A <sup>1</sup>	
<b>KOMAX</b>	Gamma 311 with Mecal K300 press (AWP) Gamma 333 with mci 711 press (AWP) Alpha 411 with Mecal PE7 or P107 press (AWP) Alpha 433 with Mecal PE7 or P107 press (AWP) 40T with Mecal PE7 press (AWP) 40T with Panduit CP-861 press (AWP) bt711 bench press only bt722	A A	A <sup>1</sup> A <sup>1</sup> A <sup>1</sup> A <sup>1</sup> A <sup>1</sup> A	A <sup>2</sup> A <sup>2</sup> A <sup>4</sup>
<b>MEGOMAT</b>	AMS 3001A/APE 300 press (AWP) Contact (AWP) Primo with MP-3.0 press (AWP)		A <sup>1</sup> A <sup>1</sup> A <sup>1</sup>	
<b>MOLEX</b>	EP-20 bench press only TM-2000 bench press only			A A
<b>SCHLEUNIGER</b>	Crimp center 12 with ACP01 press (AWP) Crimp center 64 (AWP) UC-200 bench press Crimpcenter 36 (AWP)	A A A	A <sup>1</sup> A <sup>1</sup> A <sup>1</sup> A	A
<b>SHINMAYWA</b>	TR101 (AWP) TRD111/TR111 (AWP)		A <sup>1</sup>	A A

A = Compatible with Press.

- Special Requirements:
- \*Refer to the specific applicator operation manual for installation instructions.
  - <sup>1</sup> See specific section of installation manual for details.
  - <sup>2</sup> Komax press shim is required to operate CA-800EZ Applicator.
  - <sup>3</sup> Bench press air feed capability is required.
  - <sup>4</sup> Remove press wire stripper.

A.  
System  
Overview

B1.  
Cable Ties

B2.  
Cable  
Accessories

B3.  
Stainless  
Steel Ties

C1.  
Wiring  
Duct

C2.  
Surface  
Raceway

C3.  
Abrasion  
Protection

C4.  
Cable  
Management

D1.  
Terminals

D2.  
Power  
Connectors

D3.  
Grounding  
Connectors

E1.  
Labeling  
Systems

E2.  
Labels

E3.  
Pre-Printed  
& Write-On  
Markers

E4.  
Permanent  
Identification

E5.  
Lockout/  
Tagout/  
& Safety  
Solutions

F.  
Index

A. System Overview

## Performance Requirements

B1. Cable Ties

	Wire Size (AWG)							
	#26	#24	#22	#20	#18	#16	#14	#12

**UL 486A (Terminals), UL 310 (Male Blade Adapters)**

Test current for max. 50° rise (amps)	3.5	7	9	12	17	18	30	35	50
Min. tensile strength* (lbs.)	3	5	8	13	20	30	50	70	80

**UL 486C (Splices)**

Test current for max. 50°C rise (amps)	5.5	7	9	12	17	18	30	35	50
Min. tensile strength* (lbs.)	3	5	8	10	10	15	25	35	40

\*Pull-out force of the crimped terminal.

C1. Wiring Duct

C2. Surface Raceway

	Wire Size (AWG)						
	#22	#20	#18	#16	#14	#12	#10

**UL 310 (Disconnects)**

Continuous test current for max. 30°C rise (amps) (for .187", .205", .250" tab widths)	3	4	7	10	15	20	24
--	---	---	---	----	----	----	----

Continuous test current for max. 30°C rise (amps) (for .110" tab width)	2	3	4	5	Not Applicable		
---	---	---	---	---	----------------	--	--

Min. tensile strength* (lbs.)	8	13	20	30	50	70	80
-------------------------------	---	----	----	----	----	----	----

\*Pull-out force of the crimped disconnect.

C4. Cable Management

D1. Terminals

D2. Power Connectors

D3. Grounding Connectors

E1. Labeling Systems

E2. Labels

E3. Pre-Printed & Write-On Markers

E4. Permanent Identification

E5. Lockout/Tagout & Safety Solutions

F. Index

**Applicable Pan-Term® products meet or exceed the following test specifications:**

- UL 486A (Terminals)
- UL 486C (Splices)
- UL 310 (Blade Adapters)
- CSA C22.2 No. 65 (all designs)
- UL and CSA approved products are shown with the applicable logos in the product section.
- UL file #E52164, CSA File #LR31212

**Applicable Reel Smart™ products meet or exceed the following test specifications:**

- Listed per Underwriters Laboratories, Inc. Standard UL 310 (Disconnects)
- Recognized under the Component Recognition Program of Underwriters Laboratories Inc.
- Certified by Canadian Standards Association (Disconnects)
- UL and CSA listed products are shown with the applicable logos in the product section.
- UL file #E78526, CSA file #LR31212

# NOTES

A.  
System  
Overview

B1.  
Cable Ties

B2.  
Cable  
Accessories

B3.  
Stainless  
Steel Ties

C1.  
Wiring  
Duct

C2.  
Surface  
Raceway

C3.  
Abrasion  
Protection

C4.  
Cable  
Management

D1.  
Terminals

D2.  
Power  
Connectors

D3.  
Grounding  
Connectors

E1.  
Labeling  
Systems

E2.  
Labels

E3.  
Pre-Printed  
& Write-On  
Markers

E4.  
Permanent  
Identification

E5.  
Lockout/  
Tagout  
& Safety  
Solutions

F.  
Index

A. System Overview

## Compression Connector Reference Information

B1. Cable Ties

B2. Cable Accessories

B3. Stainless Steel Ties

C1. Wiring Duct

C2. Surface Raceway

C3. Abrasion Protection

C4. Cable Management

D1. Terminals

D2. Power Connectors

D3. Grounding Connectors

E1. Labeling Systems

E2. Labels

E3. Pre-Printed & Write-On Markers

E4. Permanent Identification

E5. Lockout/Tagout & Safety Solutions

F. Index

**Selection Guide - Pand-Loc™ Copper Compression Connectors for Copper Code Conductor**

Conductor	Barrel Style	Die	Page Number
Short Barrel Lug	Standard barrel lug	CC001	02-03, 02-04
	Standard barrel lug	CC002	02-03, 02-04
	Standard barrel lug	CC003	02-03, 02-04
	Standard barrel lug	CC004	02-03, 02-04
Double Lug	Long barrel lug	CC005	02-03, 02-04
	Long barrel lug	CC006	02-03, 02-04
	Long barrel lug	CC007	02-03, 02-04
	Long barrel lug	CC008	02-03, 02-04
T-Spline	Standard barrel lug	CC009	02-03, 02-04
	Standard barrel lug	CC010	02-03, 02-04
	Standard barrel lug	CC011	02-03, 02-04
	Standard barrel lug	CC012	02-03, 02-04

### Selection Guide

- Provides a quick and easy method to select the proper connector to meet the specific application requirements

Conductor Type

Stud Hole Configuration

Barrel Style

Product Type and Page Number

**Pand-Loc™ Copper Compression Connectors, Blank Tongue, Long Barrel Lug (continued)**

**Agency Listings**

- UL Recognized and CSA Certified to 50 kV<sup>1</sup> and appropriate to 100 kV<sup>2</sup> (See UL and CSA listings for details.)
- UL Recognized and CSA Certified to 50 kV<sup>1</sup> and appropriate to 100 kV<sup>2</sup> (See UL and CSA listings for details.)

**Features and Benefits**

- UL Recognized and CSA Certified to 50 kV<sup>1</sup> and appropriate to 100 kV<sup>2</sup> (See UL and CSA listings for details.)
- UL Recognized and CSA Certified to 50 kV<sup>1</sup> and appropriate to 100 kV<sup>2</sup> (See UL and CSA listings for details.)

**Full Color Photo and 2-View Drawing**

**Panduit and Competitor Die Information**

Part Number	Conductor Size	Die	Die Part Number	Die Index Number	Number of Crimps
LCC-000-01	1/2"	CC001	CC001	01	1
LCC-000-02	3/8"	CC002	CC002	02	1
LCC-000-03	5/16"	CC003	CC003	03	1
LCC-000-04	3/16"	CC004	CC004	04	1
LCC-000-05	1/4"	CC005	CC005	05	1
LCC-000-06	5/16"	CC006	CC006	06	1
LCC-000-07	3/8"	CC007	CC007	07	1
LCC-000-08	1/2"	CC008	CC008	08	1

**Page Reference for Panduit and Competitor Installation Tooling and Die Selection Charts**

### Product Page

- Includes all necessary information for part identification and selection

Agency Listings

Features and Benefits

Full Color Photo and 2-View Drawing

Panduit and Competitor Die Information

Page Reference for Panduit and Competitor Installation Tooling and Die Selection Charts

**Installation Tooling and Die Selection for Pand-Loc™ Copper Compression Connectors**

**Page Reference to Compression Connector Tools Selection Guide for Detailed Information on Panduit Tools**

**Panduit and Competitor Tools**

**Product Type Listed by Conductor Size**

**Die Part Number, Color Code, Die Index Number and Number of Crimps for Each Product Type and Tool Combination**

### Installation Tooling and Die Selection Chart

- Contains comprehensive tool and die installation information for Panduit compression connectors with both Panduit and competitor tools

Page Reference to Compression Connector Tools Selection Guide for Detailed Information on Panduit Tools

Panduit and Competitor Tools

Product Type Listed by Conductor Size

Die Part Number, Color Code, Die Index Number and Number of Crimps for Each Product Type and Tool Combination

## PAN-LUG™ COMPRESSION CONNECTORS

Panduit® Pan-Lug™ Compression Connectors provide permanent terminations for a variety of power and grounding applications, with innovation, highest reliability, and lowest installed cost. Panduit offers the first and only copper compression lugs and splices that meet Network Equipment-Building Systems (NEBS) Level 3 requirements as tested by Telcordia Technologies. NEBS Level 3 assures that product performance is suitable for equipment applications that demand minimal service interruptions over the life span of the equipment.



- **Functional product information is marked directly on the connector, facilitating the identification, ordering, and usage of the compression connector**
- **Color-coded to facilitate quick identification of the proper crimping die**
- **Made from high strength, high conductivity electrolytic copper and aluminum alloy materials to provide optimum connectivity for power and grounding applications**
- **UL Listed or Recognized, CSA Certified, ABS Type Approved and tested by Telcordia – meets NEBS Level 3, as noted**
- **Terminations using Panduit® Pan-Lug™ Compression Connectors are also UL Listed and CSA Certified with specified competitor tools**
- **Wide assortment of manual, controlled cycle, battery operated hydraulic and pneumatic crimping tools for reliable connections at the lowest installed cost**

Panduit® Pan-Lug™ Compression Connectors are designed for use with many different code and flex conductor types and are available in a broad range of styles and sizes including copper one-hole, two-hole, and blank tongue lugs and splices; aluminum one-hole and two-hole lugs and splices; and copper in-line reducing splices. Panduit offers a wide assortment of Pan-Lug™ Power Connectors to meet customer needs and today's application requirements.

A.  
System  
Overview

B1.  
Cable Ties

B2.  
Cable  
Accessories

B3.  
Stainless  
Steel Ties

C1.  
Wiring  
Duct

C2.  
Surface  
Raceway

C3.  
Abrasion  
Protection

C4.  
Cable  
Management

D1.  
Terminals

D2.  
Power  
Connectors

D3.  
Grounding  
Connectors

E1.  
Labeling  
Systems

E2.  
Labels

E3.  
Pre-Printed  
& Write-On  
Markers

E4.  
Permanent  
Identification

E5.  
Lockout/  
Tagout  
& Safety  
Solutions

F.  
Index

A. System Overview

## Features and Benefits – Pan-Lug™ Compression Connectors

B1. Cable Ties

**Bolded features are unique to Panduit.**

B2. Cable Accessories

B3. Stainless Steel Ties

C1. Wiring Duct

C2. Surface Raceway

C3. Abrasion Protection

C4. Cable Management

D1. Terminals

D2. Power Connectors

D3. Grounding Connectors

E1. Labeling Systems

E2. Labels

E3. Pre-Printed & Write-On Markers

E4. Permanent Identification

E5. Lockout/Tagout & Safety Solutions

F. Index

### Copper Lugs

Color-coded bands for proper die selection and crimp placement

Internally beveled barrel end for easy conductor insertion (types LCCF and LCAF available with flared entry for flex conductor)

Easy-to-read, color-coded die index numbers for Panduit and specified competitor crimping dies for selection

Inspection windows available to assure complete conductor insertion

Made from seamless, high conductivity copper tubing and electro tin-plated and burnished to inhibit corrosion

Part number, stud size, and conductor size marked on part for easy identification



### Flex Lugs

Color-coded bands for proper die selection and crimp placement

Inspection window to assure complete conductor insertion

Made from seamless, high conductivity copper tubing and electro tin-plated and burnished to inhibit corrosion

Easy-to-read, color-coded die index numbers for Panduit and specified competitor crimping dies for selection

Product information marked on part for easy identification

Can be used with code conductor and flex conductor class: G, H, I, K, M and Diesel Locomotive



### Narrow Tongue Lugs

Color-coded bands for proper die selection and crimp placement

Inspection window to assure complete conductor insertion

Easy-to-read, color-coded die index numbers for Panduit and specified competitor crimping dies for selection

Narrow tongue width for limited space applications

Made from seamless, high conductivity copper tubing and electro tin-plated and burnished to inhibit corrosion

Product information marked on part for easy identification



### Copper Metric Lugs

Internally beveled barrel ends for easy conductor insertion

Product information marked on part for easy identification

Inspection window to assure complete conductor insertion

Made from 99.9% pure copper for high quality connection and tin-plated to inhibit corrosion



### Copper Parallel Splice

Chamfered on both ends for fast and easy conductor insertion

Made from seamless, high conductivity copper tubing and electro tin-plated and burnished to inhibit corrosion

Largest part marking in the industry – easier to read in low light conditions

Intuitive part numbering for fast and accurate part selection in the field

Industry recognized color-coding for selection



### Aluminum Lugs

Easy-to-read die index numbers for Panduit and specified competitor crimping dies for selection

Color-coded end plugs for proper die selection

Part number and conductor size marked on part for easy identification

Made from seamless wrought aluminum and electro tin-plated to inhibit corrosion

Crimping areas marked on part for proper crimp placement

Factory pre-filled with oxide inhibitor to prevent oxidation



Compression connector crimping tools speed installation and reduce total installed cost. See pages D3.31 – D3.94.



Panduit designs and manufactures a full line of labeling products, software and printers to assist you with your labeling requirements. See pages E1.1 – E2.22.









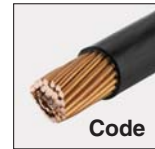

Heat shrink tubing provides an economical and easy way to insulate, protect, harness and color code electrical and electronic components. See pages C3.22 – C3.44.



## Selection Guide – Pan-Lug™ Copper Compression Connectors for Copper Code Conductor



Connector	Barrel Style	Type	Page Number
 <b>One-Hole Lugs</b>	Short Barrel with Inspection Window	LCAS	D2.7, D2.8
		LCAS-H 45° bent	D2.9, D2.10
		LCAS-F 90° bent	D2.11, D2.12
	Standard Barrel with Inspection Window	LCA	D2.13, D2.14
		LCA-H 45° bent	D2.15, D2.16
		LCA-F 90° bent	D2.17, D2.18
		LCAN narrow tongue	D2.19, D2.20
		LCA-00 blank tongue	D2.21
	Long Barrel no Inspection Window	LCB	D2.22, D2.23
		LCB-H 45° bent	D2.24, D2.25
		LCB-F 90° bent	D2.26, D2.27
	Long Barrel with Inspection Window	LCBH with corona relief taper	D2.30
LCB-W		D2.28	
LCB-WH 45° bent		D2.29	
LCB-WF 90° bent		D2.29	
 <b>Two-Hole Lugs</b>	Standard Barrel with Inspection Window	LCD	D2.31, D2.32
		LCD-H 45° bent	D2.33, D2.34
		LCD-F 90° bent	D2.35, D2.36
		LCDN narrow tongue	D2.37
	Long Barrel no Inspection Window	LCDN-H 45° bent narrow tongue	D2.38
		LCDN-F 90° bent narrow tongue	D2.39
		LCD-00 blank tongue	D2.40
		LCC	D2.41, D2.42
		LCC-H 45° bent	D2.43, D2.44
		LCC-F 90° bent	D2.45, D2.46
	Long Barrel with Inspection Window	LCCH with corona relief taper	D2.56
		LCC-00 blank tongue	D2.57
LCC-W		D2.47, D2.48, D2.49	
LCC-WH 45° bent		D2.50, D2.51, D2.52	
LCC-WF 90° bent		D2.53, D2.54, D2.55	
 <b>Butt Splices</b>	Short Barrel	SCSS	D2.59
	Standard Barrel	SCS	D2.60
	Long Barrel	SCL	D2.61
		SCH with corona relief chamfer	D2.62
 <b>T Splices</b>		SCT	D2.63
 <b>Parallel Splices</b>		PSC	D2.64
 <b>One-Hole Metric Lugs</b>		LCMA	D2.107, D2.108
 <b>Two-Hole Metric Lugs</b>		LCMD	D2.109, D2.110
 <b>Metric Splices</b>		SCMS	D2.111

A. System Overview

B1. Cable Ties

B2. Cable Accessories

B3. Stainless Steel Ties

C1. Wiring Duct

C2. Surface Raceway

C3. Abrasion Protection

C4. Cable Management

D1. Terminals

D2. Power Connectors

D3. Grounding Connectors

E1. Labeling Systems

E2. Labels

E3. Pre-Printed & Write-On Markers

E4. Permanent Identification

E5. Lockout/Tagout & Safety Solutions

F. Index

A. System Overview

B1. Cable Ties

B2. Cable Accessories

B3. Stainless Steel Ties

C1. Wiring Duct

C2. Surface Raceway

C3. Abrasion Protection

C4. Cable Management

D1. Terminals

D2. Power Connectors

D3. Grounding Connectors

E1. Labeling Systems

E2. Labels

E3. Pre-Printed & Write-On Markers





E4. Permanent Identification

E5. Lockout/Tagout & Safety Solutions







F. Index

## Selection Guide – Pan-Lug™ Copper Compression Connectors for Copper Code and/or Flex Conductor



Connector	Barrel Style	Type	Page Number
 <p><b>One-Hole Lugs</b></p>	Standard Barrel with Inspection Window Code and Flex	LCAX	D2.66, D2.67
		LCAX-H 45° bent	D2.68, D2.69
		LCAX-F 90° bent	D2.70, D2.71
		LCAXN narrow tongue	D2.72
	Standard Barrel with Inspection Window and Flared Entry Flex	LCAF	D2.73, D2.74
		LCAF-H 45° bent	D2.75, D2.76
		LCAF-F 90° bent	D2.77, D2.78
	Long Barrel with Inspection Window Code and Flex	LCBX	D2.79
		LCBX-H 45° bent	D2.80
LCBX-F 90° bent		D2.81	
 <p><b>Two-Hole Lugs</b></p>	Standard Barrel with Inspection Window Code and Flex	LCDX	D2.82, D2.83
		LCDX-H 45° bent	D2.84, D2.85
		LCDX-F 90° bent	D2.86, D2.87
		LCDXN narrow tongue	D2.88
		LCDXN-H 45° bent narrow tongue	D2.89
	LCDXN-F 90° bent narrow tongue	D2.89	
	Long Barrel no Inspection Window Flared Entry Flex	LCCF	D2.96, D2.97
		LCCF-H 45° bent	D2.98, D2.99
		LCCF-F 90° bent	D2.100, D2.101
	Long Barrel with Inspection Window Code and Flex	LCCX	D2.90, D2.91
LCCX-H 45° bent		D2.92, D2.93	
LCCX-F 90° bent		D2.94, D2.95	
LCCXN narrow tongue		D2.95	
 <p><b>Butt Splices with Flared Entry for Flex</b></p>		SCSF	D2.102
 <p><b>Reducing Splices with Inspection Window for Code and Flex</b></p>		RSCK kits with reducing splice and clear heat shrink	D2.103, D2.104
		RSC reducing splices	D2.105, D2.106

## Selection Guide – Pan-Lug™ Aluminum Compression Connectors for Aluminum or Copper Code Conductor

Connector	Type	Page Number
	One-Hole Lugs — LAA	D2.112
	Two-Hole Lugs — LAB	D2.113
	Butt Splices — SA	D2.115
	Reducing Splices — SAR	D2.116
	Bi-Metallic Pin Connectors for Aluminum Conductors Only — BPC	D2.117
	Belleville Washers — CW	D2.114, D2.155
	Joint Compounds — CMP	D2.118, D2.155

A.  
System  
Overview

B1.  
Cable Ties

B2.  
Cable  
Accessories

B3.  
Stainless  
Steel Ties

C1.  
Wiring  
Duct

C2.  
Surface  
Raceway

C3.  
Abrasion  
Protection

C4.  
Cable  
Management

D1.  
Terminals

D2.  
Power  
Connectors

D3.  
Grounding  
Connectors

E1.  
Labeling  
Systems

E2.  
Labels

E3.  
Pre-Printed  
& Write-On  
Markers

E4.  
Permanent  
Identification

E5.  
Lockout/  
Tagout  
& Safety  
Solutions

F.  
Index

A.  
System  
Overview

B1.  
Cable Ties

B2.  
Cable  
Accessories

B3.  
Stainless  
Steel Ties

C1.  
Wiring  
Duct

C2.  
Surface  
Raceway

C3.  
Abrasion  
Protection

C4.  
Cable  
Management

D1.  
Terminals

D2.  
Power  
Connectors

D3.  
Grounding  
Connectors

E1.  
Labeling  
Systems

E2.  
Labels

E3.  
Pre-Printed  
& Write-On  
Markers

E4.  
Permanent  
Identification

E5.  
Lockout/  
Tagout  
& Safety  
Solutions

F.  
Index

## Part Number System for Pan-Lug™ Compression AWG Lugs

**LCD**

Type

**2/0**

Conductor  
Size

**38**

Stud Hole  
Size

**D**

Two Stud  
Hole Spacing

**F**

Tongue Angle

**X**

Standard Package Size

Ex: LCD Lug, Copper  
Two-Hole  
Standard Barrel

10 = #10

14 = 1/4"

56 = 5/16"

38 = 3/8"

12 = 1/2"

58 = 5/8"

34 = 3/4"

78 = 7/8"

00 = Blank Tongue\*

\* LCA, LCC  
and LCD  
styles only

A = .625"

B = .750"

C = .875"

D = 1.0"

E = 1.25"

G = 1.5"

J = .5"

K = 2"

M = 1.375"

P = .688"

Q = 1.125"

No Letter = 1.75"

H = 45° Angle

F = 90° Angle

No Letter = Straight

1 = 1

2 = 2

3 = 3

5 = 5

6 = 6

X = 10

E = 20

Q = 25

L = 50



## Code Conductor, One-Hole, Short Barrel with Window Lug

For Use with Stranded Copper Conductors

### Type LCAS

- Short barrel for limited space applications
- Color-coded barrels marked with Panduit and specified competitor die index numbers for proper crimp die selection
- Inspection window to visually assure full conductor insertion
- Tin-plated to inhibit corrosion
- UL Listed and CSA Certified to 35 KV\*\* and temperature rated to 90°C when crimped with Panduit and specified competitor crimping tools and dies
- Tested by Telcordia – meets NEBS Level 3
- American Bureau of Shipping approved



Part Number	Copper Conductor Size	Stud Hole Size (In.)	Figure Dimensions (In.)				Panduit Color Code	Panduit Die Index No.‡	Burdny Die Index No.‡	T&B Die Index No.‡	Wire Strip Length (In.)	Std. Pkg. Qty.
			W	B	T	L						
<b>LCAS8-10-L</b>	#8 AWG	#10	0.41	0.42	0.08	1.11	Red	P21	49	21	1/2	50
<b>LCAS8-14-L</b>		1/4	0.48	0.42	0.07	1.20	Red	P21	49	21	1/2	50
<b>LCAS8-56-L</b>		5/16	0.56	0.42	0.05	1.32	Red	P21	49	21	1/2	50
<b>LCAS8-38-L</b>		3/8	0.60	0.42	0.05	1.42	Red	P21	49	21	1/2	50
<b>LCAS6-10-L</b>	#6 AWG	#10	0.45	0.48	0.09	1.19	Blue	P24	7	24	9/16	50
<b>LCAS6-14-L</b>		1/4	0.48	0.48	0.08	1.28	Blue	P24	7	24	9/16	50
<b>LCAS6-56-L</b>		5/16	0.56	0.48	0.07	1.40	Blue	P24	7	24	9/16	50
<b>LCAS6-38-L</b>		3/8	0.62	0.48	0.06	1.50	Blue	P24	7	24	9/16	50
<b>LCAS4-10-L</b>	#4 AWG	#10	0.55	0.53	0.09	1.26	Gray	P29	8	29	5/8	50
<b>LCAS4-14-L</b>		1/4	0.55	0.53	0.09	1.35	Gray	P29	8	29	5/8	50
<b>LCAS4-56-L</b>		5/16	0.55	0.53	0.09	1.47	Gray	P29	8	29	5/8	50
<b>LCAS4-38-L</b>		3/8	0.62	0.53	0.07	1.57	Gray	P29	8	29	5/8	50
<b>LCAS2-14-Q</b>	#2 AWG	1/4	0.60	0.57	0.10	1.46	Brown	P33	10	33	5/8	25
<b>LCAS2-56-Q</b>		5/16	0.66	0.57	0.10	1.58	Brown	P33	10	33	5/8	25
<b>LCAS2-38-Q</b>		3/8	0.66	0.57	0.10	1.66	Brown	P33	10	33	5/8	25
<b>LCAS2-12-Q</b>		1/2	0.75	0.57	0.08	1.89	Brown	P33	10	33	5/8	25
<b>LCAS1-14-E</b>	#1 AWG	1/4	0.70	0.59	0.11	1.50	Green	P37	11	37	11/16	20
<b>LCAS1-56-E</b>		5/16	0.70	0.59	0.11	1.63	Green	P37	11	37	11/16	20
<b>LCAS1-38-E</b>		3/8	0.70	0.59	0.11	1.70	Green	P37	11	37	11/16	20
<b>LCAS1-12-E</b>		1/2	0.75	0.59	0.09	1.94	Green	P37	11	37	11/16	20
<b>LCAS1/0-14-X</b>	1/0 AWG	1/4	0.76	0.66	0.12	1.67	Pink	P42	12	42	3/4	10
<b>LCAS1/0-56-X</b>		5/16	0.76	0.66	0.12	1.72	Pink	P42	12	42	3/4	10
<b>LCAS1/0-38-X</b>		3/8	0.76	0.66	0.12	1.80	Pink	P42	12	42	3/4	10
<b>LCAS1/0-12-X</b>		1/2	0.80	0.66	0.12	2.03	Pink	P42	12	42	3/4	10
<b>LCAS2/0-14-X</b>	2/0 AWG	1/4	0.85	0.72	0.13	1.82	Black	P45	13	45	3/4	10
<b>LCAS2/0-56-X</b>		5/16	0.85	0.72	0.13	1.82	Black	P45	13	45	3/4	10
<b>LCAS2/0-38-X</b>		3/8	0.85	0.72	0.13	1.89	Black	P45	13	45	3/4	10
<b>LCAS2/0-12-X</b>		1/2	0.85	0.72	0.13	2.14	Black	P45	13	45	3/4	10

‡See pages D3.56, D3.57 for tool and die information.

\*\*Consult cable manufacturer for voltage stress relief instructions with applications greater than 2000 V.

Table continues on page D2.8

A. System Overview

B1. Cable Ties

B2. Cable Accessories

B3. Stainless Steel Ties

C1. Wiring Duct

C2. Surface Raceway

C3. Abrasion Protection

C4. Cable Management

D1. Terminals

D2. Power Connectors

D3. Grounding Connectors

E1. Labeling Systems

E2. Labels

E3. Pre-Printed & Write-On Markers

E4. Permanent Identification

E5. Lockout/Tagout & Safety Solutions

F. Index

A.  
System  
Overview

B1.  
Cable Ties

B2.  
Cable  
Accessories

B3.  
Stainless  
Steel Ties

C1.  
Wiring  
Duct

C2.  
Surface  
Raceway

C3.  
Abrasion  
Protection

C4.  
Cable  
Management

D1.  
Terminals

D2.  
Power  
Connectors

D3.  
Grounding  
Connectors

E1.  
Labeling  
Systems

E2.  
Labels

E3.  
Pre-Printed  
& Write-On  
Markers

E4.  
Permanent  
Identification

E5.  
Lockout/  
Tagout  
& Safety  
Solutions

F.  
Index



## Code Conductor, One-Hole, Short Barrel with Window Lug (continued)

Part Number	Copper Conductor Size	Stud Hole Size (In.)	Figure Dimensions (In.)				Panduit Color Code	Panduit Die Index No.‡	Burndy Die Index No.‡	T&B Die Index No.‡	Wire Strip Length (In.)	Std. Pkg. Qty.
			W	B	T	L						
<b>LCAS3/0-14-X</b>	3/0 AWG	1/4	0.96	0.83	0.13	1.97	Orange	P50	14	50	7/8	10
<b>LCAS3/0-56-X</b>		5/16	0.96	0.83	0.13	1.97	Orange	P50	14	50	7/8	10
<b>LCAS3/0-38-X</b>		3/8	0.96	0.83	0.13	2.03	Orange	P50	14	50	7/8	10
<b>LCAS3/0-12-X</b>		1/2	0.96	0.83	0.13	2.28	Orange	P50	14	50	7/8	10
<b>LCAS4/0-14-X</b>	4/0 AWG	1/4	1.06	0.91	0.14	2.08	Purple	P54	15	54	1	10
<b>LCAS4/0-56-X</b>		5/16	1.06	0.91	0.14	2.10	Purple	P54	15	54	1	10
<b>LCAS4/0-38-X</b>		3/8	1.06	0.91	0.14	2.17	Purple	P54	15	54	1	10
<b>LCAS4/0-12-X</b>		1/2	1.06	0.91	0.14	2.40	Purple	P54	15	54	1	10
<b>LCAS250-14-X</b>	250 kcmil	1/4	1.17	1.03	0.14	2.25	Yellow	P62	16	62	1 1/8	10
<b>LCAS250-56-X</b>		5/16	1.17	1.03	0.14	2.25	Yellow	P62	16	62	1 1/8	10
<b>LCAS250-38-X</b>		3/8	1.17	1.03	0.14	2.32	Yellow	P62	16	62	1 1/8	10
<b>LCAS250-12-X</b>		1/2	1.17	1.03	0.14	2.56	Yellow	P62	16	62	1 1/8	10

‡See pages D3.56, D3.57 for tool and die information.

\*\*Consult cable manufacturer for voltage stress relief instructions with applications greater than 2000 V.



## Code Conductor, One-Hole, Short Barrel with Window Lug, 45° Angle

For Use with Stranded Copper Conductors

### Type LCAS-H

- Short barrel for limited space applications
- Color-coded barrels marked with Panduit and specified competitor die index numbers for proper crimp die selection
- Inspection window to visually assure full conductor insertion
- Tin-plated to inhibit corrosion

- UL Listed and CSA Certified to 35 KV\*\* and temperature rated to 90°C when crimped with Panduit and specified competitor crimping tools and dies
- Tested by Telcordia – meets NEBS Level 3
- American Bureau of Shipping approved

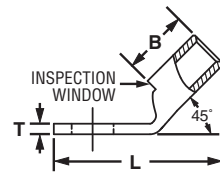
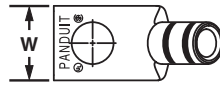

Part Number	Copper Conductor Size	Stud Hole Size (In.)	Figure Dimensions (In.)				Panduit Color Code	Panduit Die Index No.‡	Burdndy Die Index No.‡	T&B Die Index No.‡	Wire Strip Length (In.)	Std. Pkg. Qty.
			W	B	T	L						
LCAS8-10H-L	#8 AWG	#10	0.41	0.42	0.08	1.00	Red	P21	49	21	1/2	50
LCAS8-14H-L		1/4	0.48	0.42	0.07	1.09	Red	P21	49	21	1/2	50
LCAS8-56H-L		5/16	0.56	0.42	0.05	1.20	Red	P21	49	21	1/2	50
LCAS8-38H-L		3/8	0.60	0.42	0.05	1.30	Red	P21	49	21	1/2	50
LCAS6-10H-L	#6 AWG	#10	0.45	0.48	0.09	1.06	Blue	P24	7	24	9/16	50
LCAS6-14H-L		1/4	0.48	0.48	0.08	1.14	Blue	P24	7	24	9/16	50
LCAS6-56H-L		5/16	0.56	0.48	0.07	1.26	Blue	P24	7	24	9/16	50
LCAS6-38H-L		3/8	0.62	0.48	0.06	1.35	Blue	P24	7	24	9/16	50
LCAS4-10H-L	#4 AWG	#10	0.55	0.53	0.09	1.12	Gray	P29	8	29	5/8	50
LCAS4-14H-L		1/4	0.55	0.53	0.09	1.21	Gray	P29	8	29	5/8	50
LCAS4-56H-L		5/16	0.55	0.53	0.09	1.33	Gray	P29	8	29	5/8	50
LCAS4-38H-L		3/8	0.62	0.53	0.07	1.42	Gray	P29	8	29	5/8	50
LCAS2-14H-Q	#2 AWG	1/4	0.60	0.57	0.10	1.27	Brown	P33	10	33	5/8	25
LCAS2-56H-Q		5/16	0.66	0.57	0.10	1.39	Brown	P33	10	33	5/8	25
LCAS2-38H-Q		3/8	0.66	0.57	0.10	1.46	Brown	P33	10	33	5/8	25
LCAS2-12H-Q		1/2	0.75	0.57	0.08	1.68	Brown	P33	10	33	5/8	25
LCAS1-14H-E	#1 AWG	1/4	0.70	0.59	0.11	1.29	Green	P37	11	37	11/16	20
LCAS1-56H-E		5/16	0.70	0.59	0.11	1.42	Green	P37	11	37	11/16	20
LCAS1-38H-E		3/8	0.70	0.59	0.11	1.49	Green	P37	11	37	11/16	20
LCAS1-12H-E		1/2	0.75	0.59	0.09	1.73	Green	P37	11	37	11/16	20
LCAS1/0-14H-X	1/0 AWG	1/4	0.76	0.66	0.12	1.43	Pink	P42	12	42	3/4	10
LCAS1/0-56H-X		5/16	0.76	0.66	0.12	1.49	Pink	P42	12	42	3/4	10
LCAS1/0-38H-X		3/8	0.76	0.66	0.12	1.56	Pink	P42	12	42	3/4	10
LCAS1/0-12H-X		1/2	0.80	0.66	0.12	1.79	Pink	P42	12	42	3/4	10
LCAS2/0-14H-X	2/0 AWG	1/4	0.85	0.72	0.13	1.58	Black	P45	13	45	3/4	10
LCAS2/0-56H-X		5/16	0.85	0.72	0.13	1.58	Black	P45	13	45	3/4	10
LCAS2/0-38H-X		3/8	0.85	0.72	0.13	1.64	Black	P45	13	45	3/4	10
LCAS2/0-12H-X		1/2	0.85	0.72	0.13	1.89	Black	P45	13	45	3/4	10

‡See pages D3.56, D3.57 for tool and die information.

\*\*Consult cable manufacturer for voltage stress relief instructions with applications greater than 2000 V.

Table continues on page D2.10

A. System Overview

B1. Cable Ties

B2. Cable Accessories

B3. Stainless Steel Ties

C1. Wiring Duct

C2. Surface Raceway

C3. Abrasion Protection

C4. Cable Management

D1. Terminals

D2. Power Connectors

D3. Grounding Connectors

E1. Labeling Systems

E2. Labels

E3. Pre-Printed & Write-On Markers

E4. Permanent Identification

E5. Lockout/Tagout & Safety Solutions

F. Index

A.  
System  
Overview

B1.  
Cable Ties



## Code Conductor, One-Hole, Short Barrel with Window Lug, 45° Angle (continued)

B2.  
Cable  
Accessories

B3.  
Stainless  
Steel Ties

C1.  
Wiring  
Duct

C2.  
Surface  
Raceway

C3.  
Abrasion  
Protection

C4.  
Cable  
Management

D1.  
Terminals

D2.  
Power  
Connectors

D3.  
Grounding  
Connectors

E1.  
Labeling  
Systems

E2.  
Labels

E3.  
Pre-Printed  
& Write-On  
Markers

E4.  
Permanent  
Identification

E5.  
Lockout/  
Tagout  
& Safety  
Solutions

F.  
Index

Part Number	Copper Conductor Size	Stud Hole Size (In.)	Figure Dimensions (In.)				Panduit Color Code	Panduit Die Index No.‡	Burndy Die Index No.‡	T&B Die Index No.‡	Wire Strip Length (In.)	Std. Pkg. Qty.
			W	B	T	L						
LCAS3/0-14H-X	3/0 AWG	1/4	0.96	0.83	0.13	1.68	Orange	P50	14	50	7/8	10
LCAS3/0-56H-X		5/16	0.96	0.83	0.13	1.68	Orange	P50	14	50	7/8	10
LCAS3/0-38H-X		3/8	0.96	0.83	0.13	1.74	Orange	P50	14	50	7/8	10
LCAS3/0-12H-X		1/2	0.96	0.83	0.13	1.99	Orange	P50	14	50	7/8	10
LCAS4/0-14H-X	4/0 AWG	1/4	1.06	0.91	0.14	1.77	Purple	P54	15	54	1	10
LCAS4/0-56H-X		5/16	1.06	0.91	0.14	1.78	Purple	P54	15	54	1	10
LCAS4/0-38H-X		3/8	1.06	0.91	0.14	1.85	Purple	P54	15	54	1	10
LCAS4/0-12H-X		1/2	1.06	0.91	0.14	2.08	Purple	P54	15	54	1	10
LCAS250-14H-X	250 kcmil	1/4	1.17	1.03	0.14	1.89	Yellow	P62	16	62	1 1/8	10
LCAS250-56H-X		5/16	1.17	1.03	0.14	1.90	Yellow	P62	16	62	1 1/8	10
LCAS250-38H-X		3/8	1.17	1.03	0.14	1.97	Yellow	P62	16	62	1 1/8	10
LCAS250-12H-X		1/2	1.17	1.03	0.14	2.20	Yellow	P62	16	62	1 1/8	10

‡See pages D3.56, D3.57 for tool and die information.

\*\*Consult cable manufacturer for voltage stress relief instructions with applications greater than 2000 V.





## Code Conductor, One-Hole, Short Barrel with Window Lug, 90° Angle

For Use with Stranded Copper Conductors

### Type LCAS-F

- Short barrel for limited space applications
- Color-coded barrels marked with Panduit and specified competitor die index numbers for proper crimp die selection
- Inspection window to visually assure full conductor insertion
- Tin-plated to inhibit corrosion

- UL Listed and CSA Certified to 35 KV\*\* and temperature rated to 90°C when crimped with Panduit and specified competitor crimping tools and dies
- Tested by Telcordia – meets NEBS Level 3
- American Bureau of Shipping approved

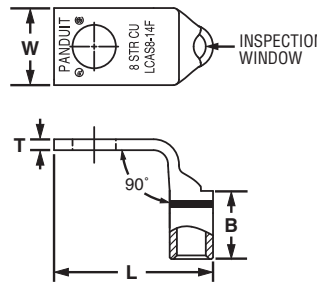

Part Number	Copper Conductor Size	Stud Hole Size (In.)	Figure Dimensions (In.)				Panduit Color Code	Panduit Die Index No.‡	Burdny Die Index No.‡	T&B Die Index No.‡	Wire Strip Length (In.)	Std. Pkg. Qty.
			W	B	T	L						
LCAS8-10F-L	#8 AWG	#10	0.41	0.42	0.08	0.90	Red	P21	49	21	1/2	50
LCAS8-14F-L		1/4	0.48	0.42	0.07	0.99	Red	P21	49	21	1/2	50
LCAS8-56F-L		5/16	0.56	0.42	0.05	1.11	Red	P21	49	21	1/2	50
LCAS8-38F-L		3/8	0.60	0.42	0.05	1.21	Red	P21	49	21	1/2	50
LCAS6-10F-L	#6 AWG	#10	0.45	0.48	0.09	0.94	Blue	P24	7	24	9/16	50
LCAS6-14F-L		1/4	0.48	0.48	0.08	1.03	Blue	P24	7	24	9/16	50
LCAS6-56F-L		5/16	0.56	0.48	0.07	1.15	Blue	P24	7	24	9/16	50
LCAS6-38F-L		3/8	0.62	0.48	0.06	1.25	Blue	P24	7	24	9/16	50
LCAS4-10F-L	#4 AWG	#10	0.55	0.53	0.09	1.03	Gray	P29	8	29	5/8	50
LCAS4-14F-L		1/4	0.55	0.53	0.09	1.12	Gray	P29	8	29	5/8	50
LCAS4-56F-L		5/16	0.55	0.53	0.09	1.24	Gray	P29	8	29	5/8	50
LCAS4-38F-L		3/8	0.62	0.53	0.07	1.34	Gray	P29	8	29	5/8	50
LCAS2-14F-Q	#2 AWG	1/4	0.60	0.57	0.10	1.24	Brown	P33	10	33	5/8	25
LCAS2-56F-Q		5/16	0.66	0.57	0.10	1.36	Brown	P33	10	33	5/8	25
LCAS2-38F-Q		3/8	0.66	0.57	0.10	1.44	Brown	P33	10	33	5/8	25
LCAS2-12F-Q		1/2	0.75	0.57	0.08	1.67	Brown	P33	10	33	5/8	25
LCAS1-14F-E	#1 AWG	1/4	0.70	0.59	0.11	1.31	Green	P37	11	37	11/16	20
LCAS1-56F-E		5/16	0.70	0.59	0.11	1.44	Green	P37	11	37	11/16	20
LCAS1-38F-E		3/8	0.70	0.59	0.11	1.51	Green	P37	11	37	11/16	20
LCAS1-12F-E		1/2	0.75	0.59	0.09	1.75	Green	P37	11	37	11/16	20
LCAS1/0-14F-X	1/0 AWG	1/4	0.76	0.66	0.12	1.45	Pink	P42	12	42	3/4	10
LCAS1/0-56F-X		5/16	0.76	0.66	0.12	1.51	Pink	P42	12	42	3/4	10
LCAS1/0-38F-X		3/8	0.76	0.66	0.12	1.58	Pink	P42	12	42	3/4	10
LCAS1/0-12F-X		1/2	0.80	0.66	0.12	1.82	Pink	P42	12	42	3/4	10
LCAS2/0-14F-X	2/0 AWG	1/4	0.85	0.72	0.13	1.59	Black	P45	13	45	3/4	10
LCAS2/0-56F-X		5/16	0.85	0.72	0.13	1.59	Black	P45	13	45	3/4	10
LCAS2/0-38F-X		3/8	0.85	0.72	0.13	1.66	Black	P45	13	45	3/4	10
LCAS2/0-12F-X		1/2	0.85	0.72	0.13	1.91	Black	P45	13	45	3/4	10

‡See pages D3.56, D3.57 for tool and die information.

\*\*Consult cable manufacturer for voltage stress relief instructions with applications greater than 2000 V.

Table continues on page D2.12

A. System Overview

B1. Cable Ties

B2. Cable Accessories

B3. Stainless Steel Ties

C1. Wiring Duct

C2. Surface Raceway

C3. Abrasion Protection

C4. Cable Management

D1. Terminals

D2. Power Connectors

D3. Grounding Connectors

E1. Labeling Systems

E2. Labels

E3. Pre-Printed & Write-On Markers

E4. Permanent Identification

E5. Lockout/Tagout & Safety Solutions

F. Index

A.  
System  
Overview

B1.  
Cable Ties



## Code Conductor, One-Hole, Short Barrel with Window Lug, 90° Angle (continued)

B2.  
Cable  
Accessories

B3.  
Stainless  
Steel Ties

C1.  
Wiring  
Duct

C2.  
Surface  
Raceway

C3.  
Abrasion  
Protection

C4.  
Cable  
Management

D1.  
Terminals

D2.  
Power  
Connectors

D3.  
Grounding  
Connectors

E1.  
Labeling  
Systems

E2.  
Labels

E3.  
Pre-Printed  
& Write-On  
Markers

E4.  
Permanent  
Identification

E5.  
Lockout/  
Tagout  
& Safety  
Solutions

F.  
Index

Part Number	Copper Conductor Size	Stud Hole Size (In.)	Figure Dimensions (In.)				Panduit Color Code	Panduit Die Index No.‡	Burdny Die Index No.‡	T&B Die Index No.‡	Wire Strip Length (In.)	Std. Pkg. Qty.
			W	B	T	L						
LCAS3/0-14F-X	3/0 AWG	1/4	0.96	0.83	0.13	1.67	Orange	P50	14	50	7/8	10
LCAS3/0-56F-X		5/16	0.96	0.83	0.13	1.67	Orange	P50	14	50	7/8	10
LCAS3/0-38F-X		3/8	0.96	0.83	0.13	1.73	Orange	P50	14	50	7/8	10
LCAS3/0-12F-X		1/2	0.96	0.83	0.13	1.98	Orange	P50	14	50	7/8	10
LCAS4/0-14F-X	4/0 AWG	1/4	1.06	0.91	0.14	1.75	Purple	P54	15	54	1	10
LCAS4/0-56F-X		5/16	1.06	0.91	0.14	1.77	Purple	P54	15	54	1	10
LCAS4/0-38F-X		3/8	1.06	0.91	0.14	1.84	Purple	P54	15	54	1	10
LCAS4/0-12F-X		1/2	1.06	0.91	0.14	2.07	Purple	P54	15	54	1	10
LCAS250-14F-X	250 kcmil	1/4	1.17	1.03	0.14	1.82	Yellow	P62	16	62	1 1/8	10
LCAS250-56F-X		5/16	1.17	1.03	0.14	1.83	Yellow	P62	16	62	1 1/8	10
LCAS250-38F-X		3/8	1.17	1.03	0.14	1.90	Yellow	P62	16	62	1 1/8	10
LCAS250-12F-X		1/2	1.17	1.03	0.14	2.13	Yellow	P62	16	62	1 1/8	10

‡See pages D3.56, D3.57 for tool and die information.

\*\*Consult cable manufacturer for voltage stress relief instructions with applications greater than 2000 V.



## Code Conductor, One-Hole, Standard Barrel with Window Lug

For Use with Stranded Copper Conductors

### Type LCA

- Color-coded barrels marked with Panduit and specified competitor die index numbers for proper crimp die selection
- Inspection window to visually assure full conductor insertion
- Tin-plated to inhibit corrosion
- UL Listed and CSA Certified to 35 KV\*\* and temperature rated to 90°C when crimped with Panduit and specified competitor crimping tools and dies
- UL Listed and CSA Certified for wide wire range-taking capability when crimped with Panduit® Uni-Die™ Dieless Crimping Tools‡
- Tested by Telcordia – meets NEBS Level 3
- American Bureau of Shipping Approved



Part Number	Copper Conductor Size	Stud Hole Size (In.)	Figure Dimensions (In.)				Panduit Color Code	Panduit Die Index No.‡	Burdny Die Index No.‡	T&B Die Index No.‡	Wire Strip Length (In.)	Std. Pkg. Qty.
			W	B	T	L						
LCA10-10-L*	#14 – #10 AWG STR, #12 – #10 AWG SOL	#10	0.38	0.38	0.06	1.07	—	—	—	—	7/16	50
LCA10-14-L*		1/4	0.42	0.38	0.05	1.16	—	—	—	—	7/16	50
LCA10-56-L*		5/16	0.54	0.38	0.04	1.28	—	—	—	—	7/16	50
LCA10-38-L*		3/8	0.56	0.38	0.04	1.38	—	—	—	—	7/16	50
LCA8-10-L	#8 AWG	#10	0.41	0.56	0.08	1.25	Red	P21	49	21	5/8	50
LCA8-14-L		1/4	0.48	0.56	0.07	1.34	Red	P21	49	21	5/8	50
LCA8-56-L		5/16	0.56	0.56	0.05	1.46	Red	P21	49	21	5/8	50
LCA8-38-L		3/8	0.60	0.56	0.05	1.56	Red	P21	49	21	5/8	50
LCA6-10-L	#6 AWG	#10	0.45	0.81	0.09	1.52	Blue	P24	7	24	7/8	50
LCA6-14-L		1/4	0.48	0.81	0.08	1.61	Blue	P24	7	24	7/8	50
LCA6-56-L		5/16	0.56	0.81	0.07	1.73	Blue	P24	7	24	7/8	50
LCA6-38-L		3/8	0.62	0.81	0.06	1.83	Blue	P24	7	24	7/8	50
LCA6-12-L		1/2	0.75	0.81	0.07	2.23	Blue	P24	7	24	7/8	50
LCA4-10-L	#4 – #3 AWG STR, #2 AWG SOL	#10	0.55	0.81	0.09	1.54	Gray	P29	8	29	7/8	50
LCA4-14-L		1/4	0.55	0.81	0.09	1.63	Gray	P29	8	29	7/8	50
LCA4-56-L		5/16	0.55	0.81	0.09	1.75	Gray	P29	8	29	7/8	50
LCA4-38-L		3/8	0.62	0.81	0.07	1.85	Gray	P29	8	29	7/8	50
LCA4-12-L		1/2	0.75	0.81	0.07	2.23	Gray	P29	8	29	7/8	50
LCA2-14-Q	#2 AWG	1/4	0.60	0.88	0.10	1.77	Brown	P33	10	33	15/16	25
LCA2-56-Q		5/16	0.66	0.88	0.10	1.90	Brown	P33	10	33	15/16	25
LCA2-38-Q		3/8	0.66	0.88	0.10	1.97	Brown	P33	10	33	15/16	25
LCA2-12-Q		1/2	0.75	0.88	0.08	2.21	Brown	P33	10	33	15/16	25
LCA1-14-E	#1 AWG	1/4	0.70	0.88	0.11	1.79	Green	P37	11	37	15/16	20
LCA1-56-E		5/16	0.70	0.88	0.11	1.92	Green	P37	11	37	15/16	20
LCA1-38-E		3/8	0.70	0.88	0.11	1.99	Green	P37	11	37	15/16	20
LCA1-12-E		1/2	0.75	0.88	0.09	2.23	Green	P37	11	37	15/16	20

‡See pages D3.58 – D3.61 for tool and die information.

\*Not tested to NEBS Level 3 requirements.

\*\*Consult cable manufacturer for voltage stress relief instructions with applications greater than 2000 V.

Table continues on page D2.14

A. System Overview

B1. Cable Ties

B2. Cable Accessories

B3. Stainless Steel Ties

C1. Wiring Duct

C2. Surface Raceway

C3. Abrasion Protection

C4. Cable Management

D1. Terminals

D2. Power Connectors

D3. Grounding Connectors

E1. Labeling Systems

E2. Labels

E3. Pre-Printed & Write-On Markers

E4. Permanent Identification

E5. Lockout/Tagout & Safety Solutions

F. Index

A. System Overview

B1. Cable Ties

B2. Cable Accessories

B3. Stainless Steel Ties

C1. Wiring Duct

C2. Surface Raceway

C3. Abrasion Protection

C4. Cable Management

D1. Terminals

D2. Power Connectors

D3. Grounding Connectors

E1. Labeling Systems

E2. Labels

E3. Pre-Printed & Write-On Markers

E4. Permanent Identification

E5. Lockout/Tagout & Safety Solutions

F. Index



## Code Conductor, One-Hole, Standard Barrel with Window Lug (continued)

Part Number	Copper Conductor Size	Stud Hole Size (In.)	Figure Dimensions (In.)				Panduit Color Code	Panduit Die Index No.‡	Burndy Die Index No.‡	T&B Die Index No.‡	Wire Strip Length (In.)	Std. Pkg. Qty.
			W	B	T	L						
<b>LCA1/0-14-X</b>	1/0 AWG	1/4	0.76	0.94	0.12	1.95	Pink	P42	12	42	1	10
<b>LCA1/0-56-X</b>		5/16	0.76	0.94	0.12	2.00	Pink	P42	12	42	1	10
<b>LCA1/0-38-X</b>		3/8	0.76	0.94	0.12	2.08	Pink	P42	12	42	1	10
<b>LCA1/0-12-X</b>	2/0 AWG	1/2	0.80	0.94	0.12	2.31	Pink	P42	12	42	1	10
<b>LCA2/0-14-X</b>		1/4	0.85	0.98	0.13	2.09	Black	P45	13	45	1 1/16	10
<b>LCA2/0-56-X</b>		5/16	0.85	0.98	0.13	2.09	Black	P45	13	45	1 1/16	10
<b>LCA2/0-38-X</b>	3/0 AWG	3/8	0.85	0.98	0.13	2.15	Black	P45	13	45	1 1/16	10
<b>LCA2/0-12-X</b>		1/2	0.85	0.98	0.13	2.40	Black	P45	13	45	1 1/16	10
<b>LCA3/0-14-X</b>		1/4	0.96	1.14	0.13	2.28	Orange	P50	14	50	1 3/16	10
<b>LCA3/0-56-X</b>	4/0 AWG	5/16	0.96	1.14	0.13	2.28	Orange	P50	14	50	1 3/16	10
<b>LCA3/0-38-X</b>		3/8	0.96	1.14	0.13	2.34	Orange	P50	14	50	1 3/16	10
<b>LCA3/0-12-X</b>		1/2	0.96	1.14	0.13	2.59	Orange	P50	14	50	1 3/16	10
<b>LCA4/0-14-X</b>	250 kcmil	1/4	1.06	1.19	0.14	2.36	Purple	P54	15	54	1 1/4	10
<b>LCA4/0-56-X</b>		5/16	1.06	1.19	0.14	2.38	Purple	P54	15	54	1 1/4	10
<b>LCA4/0-38-X</b>		3/8	1.06	1.19	0.14	2.45	Purple	P54	15	54	1 1/4	10
<b>LCA4/0-12-X</b>	300 kcmil	1/2	1.06	1.19	0.14	2.68	Purple	P54	15	54	1 1/4	10
<b>LCA250-14-X</b>		1/4	1.17	1.25	0.14	2.47	Yellow	P62	16	62	1 5/16	10
<b>LCA250-56-X</b>		5/16	1.17	1.25	0.14	2.48	Yellow	P62	16	62	1 5/16	10
<b>LCA250-38-X</b>	350 kcmil	3/8	1.17	1.25	0.14	2.55	Yellow	P62	16	62	1 5/16	10
<b>LCA250-12-X</b>		1/2	1.17	1.25	0.14	2.78	Yellow	P62	16	62	1 5/16	10
<b>LCA300-56-X</b>		5/16	1.19	1.44	0.16	2.94	White	P66	17	66	1 1/2	10
<b>LCA300-38-X</b>	400 kcmil	3/8	1.19	1.44	0.16	2.94	White	P66	17	66	1 1/2	10
<b>LCA300-12-X</b>		1/2	1.19	1.44	0.16	3.05	White	P66	17	66	1 1/2	10
<b>LCA300-58-X</b>		5/8	1.19	1.44	0.16	3.26	White	P66	17	66	1 1/2	10
<b>LCA300-78-X</b>	500 kcmil	7/8	1.19	1.44	0.16	3.70	White	P66	17	66	1 1/2	10
<b>LCA350-38-X</b>		3/8	1.28	1.44	0.17	2.98	Red	P71	18	71	1 1/2	10
<b>LCA350-12-X</b>		1/2	1.28	1.44	0.17	3.09	Red	P71	18	71	1 1/2	10
<b>LCA350-58-X</b>	600 kcmil	5/8	1.28	1.44	0.17	3.30	Red	P71	18	71	1 1/2	10
<b>LCA350-78-X</b>		7/8	1.28	1.44	0.17	3.74	Red	P71	18	71	1 1/2	10
<b>LCA400-38-6</b>		3/8	1.39	1.50	0.18	3.22	Blue	P76	19	76	1 9/16	6
<b>LCA400-12-6</b>	750 kcmil	1/2	1.39	1.50	0.18	3.22	Blue	P76	19	76	1 9/16	6
<b>LCA400-58-6</b>		5/8	1.39	1.50	0.18	3.43	Blue	P76	19	76	1 9/16	6
<b>LCA400-78-6</b>		7/8	1.39	1.50	0.18	3.82	Blue	P76	19	76	1 9/16	6
<b>LCA500-38-6</b>	E1, E2, E3, E4	3/8	1.54	1.75	0.22	3.39	Brown	P87	20	87	1 13/16	6
<b>LCA500-12-6</b>		1/2	1.54	1.75	0.22	3.55	Brown	P87	20	87	1 13/16	6
<b>LCA500-58-6</b>		5/8	1.54	1.75	0.22	3.76	Brown	P87	20	87	1 13/16	6
<b>LCA500-34-6</b>	E1, E2, E3, E4	3/4	1.54	1.75	0.22	3.90	Brown	P87	20	87	1 13/16	6
<b>LCA500-78-6</b>		7/8	1.54	1.75	0.22	4.15	Brown	P87	20	87	1 13/16	6
<b>LCA500-1-6</b>		1	1.54	1.75	0.22	4.27	Brown	P87	20	87	1 13/16	6
<b>LCA600-12-6</b>	E1, E2, E3, E4	1/2	1.70	1.75	0.26	4.20	Green	P94	22	94	1 13/16	6
<b>LCA600-58-6</b>		5/8	1.70	1.75	0.26	4.20	Green	P94	22	94	1 13/16	6
<b>LCA600-78-6</b>		7/8	1.70	1.75	0.26	4.20	Green	P94	22	94	1 13/16	6
<b>LCA750-58-6</b>	E1, E2, E3, E4	5/8	1.89	1.88	0.26	4.59	Black	P106	24	106	1 15/16	6

‡See pages D3.58 – D3.61 for tool and die information.

\*Not tested to NEBS Level 3 requirements.

\*\*Consult cable manufacturer for voltage stress relief instructions with applications greater than 2000 V.



## Code Conductor, One-Hole, Standard Barrel with Window Lug, 45° Angle

For Use with Stranded Copper Conductors

### Type LCA-H

- Color-coded barrels marked with Panduit and specified competitor die index numbers for proper crimp die selection
- Inspection window to visually assure full conductor insertion
- Tin-plated to inhibit corrosion
- UL Listed and CSA Certified to 35 KV\*\* and temperature rated to 90°C when crimped with Panduit and specified competitor crimping tools and dies

- UL Listed and CSA Certified for wide wire range-taking capability when crimped with Panduit® Uni-Die™ Dieless Crimping Tools‡
- Tested by Telcordia – meets NEBS Level 3
- American Bureau of Shipping approved

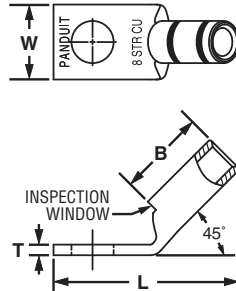

Part Number	Copper Conductor Size	Stud Hole Size (In.)	Figure Dimensions (In.)				Panduit Color Code	Panduit Die Index No.‡	Burndy Die Index No.‡	T&B Die Index No.‡	Wire Strip Length (In.)	Std. Pkg. Qty.
			W	B	T	L						
LCA10-14H-L*	#14 – #10 AWG STR, #12 – #10 AWG SOL	1/4	0.42	0.38	0.05	1.05	—	—	—	—	7/16	50
LCA8-10H-L	#8 AWG	#10	0.41	0.56	0.08	1.10	Red	P21	49	21	5/8	50
LCA8-14H-L		1/4	0.48	0.56	0.07	1.19	Red	P21	49	21	5/8	50
LCA8-56H-L		5/16	0.56	0.56	0.05	1.30	Red	P21	49	21	5/8	50
LCA8-38H-L		3/8	0.60	0.56	0.05	1.40	Red	P21	49	21	5/8	50
LCA6-10H-L	#6 AWG	#10	0.45	0.81	0.09	1.29	Blue	P24	7	24	7/8	50
LCA6-14H-L		1/4	0.48	0.81	0.08	1.38	Blue	P24	7	24	7/8	50
LCA6-56H-L		5/16	0.56	0.81	0.07	1.49	Blue	P24	7	24	7/8	50
LCA6-38H-L		3/8	0.62	0.81	0.06	1.59	Blue	P24	7	24	7/8	50
LCA4-10H-L	#4 – #3 AWG STR, #2 AWG SOL	#10	0.55	0.81	0.09	1.31	Gray	P29	8	29	7/8	50
LCA4-14H-L		1/4	0.55	0.81	0.09	1.40	Gray	P29	8	29	7/8	50
LCA4-56H-L		5/16	0.55	0.81	0.09	1.52	Gray	P29	8	29	7/8	50
LCA4-38H-L		3/8	0.62	0.81	0.07	1.61	Gray	P29	8	29	7/8	50
LCA2-14H-Q	#2 AWG	1/4	0.60	0.88	0.10	1.49	Brown	P33	10	33	15/16	25
LCA2-56H-Q		5/16	0.66	0.88	0.10	1.61	Brown	P33	10	33	15/16	25
LCA2-38H-Q		3/8	0.66	0.88	0.10	1.68	Brown	P33	10	33	15/16	25
LCA2-12H-Q		1/2	0.75	0.88	0.08	1.90	Brown	P33	10	33	15/16	25

‡See pages D3.58 – D3.61 for tool and die information.

\*Not tested to NEBS Level 3 requirements.

\*\*Consult cable manufacturer for voltage stress relief instructions with applications greater than 2000 V.

Table continues on page D2.16

A. System Overview

B1. Cable Ties

B2. Cable Accessories

B3. Stainless Steel Ties

C1. Wiring Duct

C2. Surface Raceway

C3. Abrasion Protection

C4. Cable Management

D1. Terminals

D2. Power Connectors

D3. Grounding Connectors

E1. Labeling Systems

E2. Labels

E3. Pre-Printed & Write-On Markers

E4. Permanent Identification

E5. Lockout/Tagout & Safety Solutions

F. Index

A.  
System  
Overview



## Code Conductor, One-Hole, Standard Barrel with Window Lug, 45° Angle (continued)

B1.  
Cable Ties

B2.  
Cable  
Accessories

B3.  
Stainless  
Steel Ties

C1.  
Wiring  
Duct

C2.  
Surface  
Raceway

C3.  
Abrasion  
Protection

C4.  
Cable  
Management

D1.  
Terminals

D2.  
Power  
Connectors

D3.  
Grounding  
Connectors

E1.  
Labeling  
Systems

E2.  
Labels

E3.  
Pre-Printed  
& Write-On  
Markers

E4.  
Permanent  
Identification

E5.  
Lockout/  
Tagout  
& Safety  
Solutions

F.  
Index

Part Number	Copper Conductor Size	Stud Hole Size (In.)	Figure Dimensions (In.)				Panduit Color Code	Panduit Die Index No.‡	Burdny Die Index No.‡	T&B Die Index No.‡	Wire Strip Length (In.)	Std. Pkg. Qty.
			W	B	T	L						
LCA1-14H-E	#1 AWG	1/4	0.70	0.88	0.11	1.50	Green	P37	11	37	15/16	20
LCA1-56H-E		5/16	0.70	0.88	0.11	1.62	Green	P37	11	37	15/16	20
LCA1-38H-E		3/8	0.70	0.88	0.11	1.70	Green	P37	11	37	15/16	20
LCA1-12H-E		1/2	0.75	0.88	0.09	1.93	Green	P37	11	37	15/16	20
LCA1/0-14H-X	1/0 AWG	1/4	0.76	0.94	0.12	1.63	Pink	P42	12	42	1	10
LCA1/0-56H-X		5/16	0.76	0.94	0.12	1.69	Pink	P42	12	42	1	10
LCA1/0-38H-X		3/8	0.76	0.94	0.12	1.76	Pink	P42	12	42	1	10
LCA1/0-12H-X		1/2	0.80	0.94	0.12	1.99	Pink	P42	12	42	1	10
LCA2/0-14H-X	2/0 AWG	1/4	0.85	0.98	0.13	1.77	Black	P45	13	45	1 1/16	10
LCA2/0-56H-X		5/16	0.85	0.98	0.13	1.77	Black	P45	13	45	1 1/16	10
LCA2/0-38H-X		3/8	0.85	0.98	0.13	1.83	Black	P45	13	45	1 1/16	10
LCA2/0-12H-X		1/2	0.85	0.98	0.13	2.08	Black	P45	13	45	1 1/16	10
LCA2/0-34H-X	3/0 AWG	3/4	1.06	0.98	0.09	2.66	Black	P45	13	45	1 1/16	10
LCA3/0-14H-X		1/4	0.96	1.14	0.13	1.90	Orange	P50	14	50	1 3/16	10
LCA3/0-56H-X		5/16	0.96	1.14	0.13	1.90	Orange	P50	14	50	1 3/16	10
<b>LCA3/0-38H-X</b>		3/8	0.96	1.14	0.13	1.96	Orange	P50	14	50	1 3/16	10
LCA3/0-12H-X	4/0 AWG	1/2	0.96	1.14	0.13	2.21	Orange	P50	14	50	1 3/16	10
LCA4/0-14H-X		1/4	1.06	1.19	0.14	1.97	Purple	P54	15	54	1 1/4	10
LCA4/0-56H-X		5/16	1.06	1.19	0.14	1.98	Purple	P54	15	54	1 1/4	10
LCA4/0-38H-X		3/8	1.06	1.19	0.14	2.05	Purple	P54	15	54	1 1/4	10
LCA4/0-12H-X	250 kcmil	1/2	1.06	1.19	0.14	2.28	Purple	P54	15	54	1 1/4	10
LCA250-14H-X		1/4	1.17	1.25	0.14	2.05	Yellow	P62	16	62	1 5/16	10
LCA250-56H-X		5/16	1.17	1.25	0.14	2.06	Yellow	P62	16	62	1 5/16	10
<b>LCA250-38H-X</b>		3/8	1.17	1.25	0.14	2.13	Yellow	P62	16	62	1 5/16	10
LCA250-12H-X	300 kcmil	1/2	1.17	1.25	0.14	2.36	Yellow	P62	16	62	1 5/16	10
LCA300-56H-X		5/16	1.19	1.44	0.16	2.55	White	P66	17	66	1 1/2	10
LCA300-38H-X		3/8	1.19	1.44	0.16	2.55	White	P66	17	66	1 1/2	10
LCA300-12H-X		1/2	1.19	1.44	0.16	2.66	White	P66	17	66	1 1/2	10
LCA300-58H-X	350 kcmil	5/8	1.19	1.44	0.16	2.87	White	P66	17	66	1 1/2	10
LCA300-78H-X		7/8	1.19	1.44	0.16	3.31	White	P66	17	66	1 1/2	10
LCA350-38H-X		3/8	1.28	1.44	0.17	2.59	Red	P71	18	71	1 1/2	10
LCA350-12H-X		1/2	1.28	1.44	0.17	2.70	Red	P71	18	71	1 1/2	10
LCA350-58H-X	400 kcmil	5/8	1.28	1.44	0.17	2.91	Red	P71	18	71	1 1/2	10
LCA350-78H-X		7/8	1.28	1.44	0.17	3.35	Red	P71	18	71	1 1/2	10
LCA400-38H-6		3/8	1.39	1.50	0.18	2.85	Blue	P76	19	76	1 9/16	6
LCA400-12H-6		1/2	1.39	1.50	0.18	2.85	Blue	P76	19	76	1 9/16	6
LCA400-58H-6	500 kcmil	5/8	1.39	1.50	0.18	3.06	Blue	P76	19	76	1 9/16	6
LCA400-78H-6		7/8	1.39	1.50	0.18	3.45	Blue	P76	19	76	1 9/16	6
LCA500-38H-6		3/8	1.54	1.75	0.22	2.94	Brown	P87	20	87	1 13/16	6
LCA500-12H-6		1/2	1.54	1.75	0.22	3.10	Brown	P87	20	87	1 13/16	6
LCA500-58H-6	600 kcmil	5/8	1.54	1.75	0.22	3.31	Brown	P87	20	87	1 13/16	6
LCA500-34H-6		3/4	1.54	1.75	0.22	3.45	Brown	P87	20	87	1 13/16	6
LCA500-78H-6		7/8	1.54	1.75	0.22	3.70	Brown	P87	20	87	1 13/16	6
LCA500-1H-6		1	1.54	1.75	0.22	3.82	Brown	P87	20	87	1 13/16	6
LCA600-12H-6	600 kcmil	1/2	1.70	1.75	0.26	3.76	Green	P94	22	94	1 13/16	6
LCA600-58H-6		5/8	1.70	1.75	0.26	3.76	Green	P94	22	94	1 13/16	6
LCA600-78H-6		7/8	1.70	1.75	0.26	3.76	Green	P94	22	94	1 13/16	6

‡See pages D3.58 – D3.61 for tool and die information.

\*Not tested to NEBS Level 3 requirements.

\*\*Consult cable manufacturer for voltage stress relief instructions with applications greater than 2000 V.



## Code Conductor, One-Hole, Standard Barrel with Window Lug, 90° Angle

For Use with Stranded Copper Conductors

### Type LCA-F

- Color-coded barrels marked with Panduit and specified competitor die index numbers for proper crimp die selection
- Inspection window to visually assure full conductor insertion
- Tin-plated to inhibit corrosion
- UL Listed and CSA Certified to 35 KV\*\* and temperature rated to 90°C when crimped with Panduit and specified competitor crimping tools and dies

- UL Listed and CSA Certified for wide wire range-taking capability when crimped with Panduit® Uni-Die™ Dieless Crimping Tools‡
- Tested by Telcordia – meets NEBS Level 3
- American Bureau of Shipping Approved

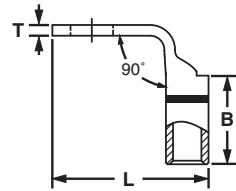
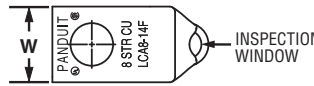

Part Number	Copper Conductor Size	Stud Hole Size (In.)	Figure Dimensions (In.)				Panduit Color Code	Panduit Die Index No.‡	Burdny Die Index No.‡	T&B Die Index No.‡	Wire Strip Length (In.)	Std. Pkg. Qty.
			W	B	T	L						
LCA10-14F-L*	#14 – #10 AWG STR, #12 – #10 AWG SOL	1/4	0.42	0.38	0.05	0.94	—	—	—	—	7/16	50
LCA8-10F-L	#8 AWG	#10	0.41	0.56	0.08	0.90	Red	P21	49	21	5/8	50
LCA8-14F-L		1/4	0.48	0.56	0.07	0.99	Red	P21	49	21	5/8	50
LCA8-56F-L		5/16	0.56	0.56	0.05	1.11	Red	P21	49	21	5/8	50
LCA8-38F-L		3/8	0.60	0.56	0.05	1.21	Red	P21	49	21	5/8	50
LCA6-10F-L	#6 AWG	#10	0.45	0.81	0.09	0.94	Blue	P24	7	24	7/8	50
LCA6-14F-L		1/4	0.48	0.81	0.08	1.03	Blue	P24	7	24	7/8	50
LCA6-56F-L		5/16	0.56	0.81	0.07	1.15	Blue	P24	7	24	7/8	50
LCA6-38F-L		3/8	0.62	0.81	0.06	1.25	Blue	P24	7	24	7/8	50
LCA4-10F-L	#4 – #3 AWG STR, #2 AWG SOL	#10	0.55	0.81	0.09	1.03	Gray	P29	8	29	7/8	50
LCA4-14F-L		1/4	0.55	0.81	0.09	1.12	Gray	P29	8	29	7/8	50
LCA4-56F-L		5/16	0.55	0.81	0.09	1.24	Gray	P29	8	29	7/8	50
LCA4-38F-L		3/8	0.62	0.81	0.07	1.34	Gray	P29	8	29	7/8	50
LCA4-12F-L	#2 AWG	1/2	0.75	0.81	0.07	1.59	Gray	P29	8	29	7/8	50
LCA2-14F-Q		1/4	0.60	0.88	0.10	1.24	Brown	P33	10	33	15/16	25
LCA2-56F-Q		5/16	0.66	0.88	0.10	1.36	Brown	P33	10	33	15/16	25
LCA2-38F-Q		3/8	0.66	0.88	0.10	1.44	Brown	P33	10	33	15/16	25
LCA2-12F-Q	1/2	0.75	0.88	0.08	1.67	Brown	P33	10	33	15/16	25	

‡See pages D3.58 – D3.61 for tool and die information.

\*Not tested to NEBS Level 3 requirements.

\*\*Consult cable manufacturer for voltage stress relief instructions with applications greater than 2000 V.

Table continues on page D2.18

A. System Overview

B1. Cable Ties

B2. Cable Accessories

B3. Stainless Steel Ties

C1. Wiring Duct

C2. Surface Raceway

C3. Abrasion Protection

C4. Cable Management

D1. Terminals

D2. Power Connectors

D3. Grounding Connectors

E1. Labeling Systems

E2. Labels

E3. Pre-Printed & Write-On Markers

E4. Permanent Identification

E5. Lockout/Tagout & Safety Solutions

F. Index



## Code Conductor, One-Hole, Standard Barrel with Window Lug, 90° Angle (continued)

Part Number	Copper Conductor Size	Stud Hole Size (In.)	Figure Dimensions (In.)				Panduit Color Code	Panduit Die Index No.‡	Burdny Die Index No.‡	T&B Die Index No.‡	Wire Strip Length (In.)	Std. Pkg. Qty.
			W	B	T	L						
LCA1-14F-E	#1 AWG	1/4	0.70	0.88	0.11	1.31	Green	P37	11	37	15/16	20
LCA1-56F-E		5/16	0.70	0.88	0.11	1.44	Green	P37	11	37	15/16	20
<b>LCA1-38F-E</b>		3/8	0.70	0.88	0.11	1.51	Green	P37	11	37	15/16	20
<b>LCA1-12F-E</b>		1/2	0.75	0.88	0.09	1.75	Green	P37	11	37	15/16	20
LCA1/0-14F-X	1/0 AWG	1/4	0.76	0.94	0.12	1.45	Pink	P42	12	42	1	10
LCA1/0-56F-X		5/16	0.76	0.94	0.12	1.51	Pink	P42	12	42	1	10
LCA1/0-38F-X		3/8	0.76	0.94	0.12	1.58	Pink	P42	12	42	1	10
LCA1/0-12F-X		1/2	0.80	0.94	0.12	1.82	Pink	P42	12	42	1	10
LCA2/0-14F-X	2/0 AWG	1/4	0.85	0.98	0.13	1.61	Black	P45	13	45	1 1/16	10
LCA2/0-56F-X		5/16	0.85	0.98	0.13	1.59	Black	P45	13	45	1 1/16	10
LCA2/0-38F-X		3/8	0.85	0.98	0.13	1.66	Black	P45	13	45	1 1/16	10
LCA2/0-12F-X		1/2	0.85	0.98	0.13	1.91	Black	P45	13	45	1 1/16	10
LCA3/0-14F-X	3/0 AWG	1/4	0.96	1.14	0.13	1.67	Orange	P50	14	50	1 3/16	10
LCA3/0-56F-X		5/16	0.96	1.14	0.13	1.67	Orange	P50	14	50	1 3/16	10
LCA3/0-38F-X		3/8	0.96	1.14	0.13	1.73	Orange	P50	14	50	1 3/16	10
LCA3/0-12F-X		1/2	0.96	1.14	0.13	1.98	Orange	P50	14	50	1 3/16	10
LCA4/0-14F-X	4/0 AWG	1/4	1.06	1.19	0.14	1.75	Purple	P54	15	54	1 1/4	10
LCA4/0-56F-X		5/16	1.06	1.19	0.14	1.77	Purple	P54	15	54	1 1/4	10
LCA4/0-38F-X		3/8	1.06	1.19	0.14	1.84	Purple	P54	15	54	1 1/4	10
LCA4/0-12F-X		1/2	1.06	1.19	0.14	2.07	Purple	P54	15	54	1 1/4	10
LCA250-14F-X	250 kcmil	1/4	1.17	1.25	0.14	1.82	Yellow	P62	16	62	1 5/16	10
<b>LCA250-56F-X</b>		5/16	1.17	1.25	0.14	1.83	Yellow	P62	16	62	1 5/16	10
LCA250-38F-X		3/8	1.17	1.25	0.14	1.90	Yellow	P62	16	62	1 5/16	10
LCA250-12F-X		1/2	1.17	1.25	0.14	2.13	Yellow	P62	16	62	1 5/16	10
LCA300-56F-X	300 kcmil	5/16	1.19	1.44	0.16	2.07	White	P66	17	66	1 1/2	10
LCA300-38F-X		3/8	1.19	1.44	0.16	2.07	White	P66	17	66	1 1/2	10
LCA300-12F-X		1/2	1.19	1.44	0.16	2.18	White	P66	17	66	1 1/2	10
LCA300-58F-X		5/8	1.19	1.44	0.16	2.39	White	P66	17	66	1 1/2	10
LCA300-78F-X	350 kcmil	7/8	1.19	1.44	0.16	2.83	White	P66	17	66	1 1/2	10
LCA350-38F-X		3/8	1.28	1.44	0.17	2.13	Red	P71	18	71	1 1/2	10
LCA350-12F-X		1/2	1.28	1.44	0.17	2.24	Red	P71	18	71	1 1/2	10
LCA350-58F-X		5/8	1.28	1.44	0.17	2.45	Red	P71	18	71	1 1/2	10
LCA350-78F-X	400 kcmil	7/8	1.28	1.44	0.17	2.89	Red	P71	18	71	1 1/2	10
LCA400-38F-6		3/8	1.39	1.50	0.18	2.37	Blue	P76	19	76	1 9/16	6
LCA400-12F-6		1/2	1.39	1.50	0.18	2.37	Blue	P76	19	76	1 9/16	6
LCA400-58F-6		5/8	1.39	1.50	0.18	2.58	Blue	P76	19	76	1 9/16	6
LCA400-78F-6	500 kcmil	7/8	1.39	1.50	0.18	2.97	Blue	P76	19	76	1 9/16	6
LCA500-38F-6		3/8	1.54	1.75	0.22	2.32	Brown	P87	20	87	1 13/16	6
LCA500-12F-6		1/2	1.54	1.75	0.22	2.48	Brown	P87	20	87	1 13/16	6
LCA500-58F-6		5/8	1.54	1.75	0.22	2.69	Brown	P87	20	87	1 13/16	6
LCA500-34F-6	600 kcmil	3/4	1.54	1.75	0.22	2.83	Brown	P87	20	87	1 13/16	6
LCA500-78F-6		7/8	1.54	1.75	0.22	3.08	Brown	P87	20	87	1 13/16	6
LCA500-1F-6		1	1.54	1.75	0.22	3.20	Brown	P87	20	87	1 13/16	6
LCA600-12F-6		1/2	1.70	1.75	0.26	3.21	Green	P94	22	94	1 13/16	6
LCA600-58F-6	600 kcmil	5/8	1.70	1.75	0.26	3.21	Green	P94	22	94	1 13/16	6
LCA600-78F-6		7/8	1.70	1.75	0.26	3.21	Green	P94	22	94	1 13/16	6

‡See pages D3.58 – D3.61 for tool and die information.

\*Not tested to NEBS Level 3 requirements.

\*\*Consult cable manufacturer for voltage stress relief instructions with applications greater than 2000 V.





## Code Conductor, One-Hole, Standard Barrel with Window, Narrow Tongue Lug

For Use with Stranded Copper Conductors

### Type L CAN

- Narrow tongue width for limited space applications
- Color-coded barrels marked with Panduit and specified competitor die index numbers for proper crimp die selection
- Inspection window to visually assure full conductor insertion
- Tin-plated to inhibit corrosion

- UL Listed and CSA Certified to 35 KV\*\* and temperature rated to 90°C when crimped with Panduit and specified competitor crimping tools and dies
- UL Listed and CSA Certified for wide wire range-taking capability when crimped with Panduit® Uni-Die™ Dieless Crimping Tools‡



Part Number	Copper Conductor Size	Stud Hole Size (In.)	Figure Dimensions (In.)				Panduit Color Code	Panduit Die Index No.‡	Burdny Die Index No.‡	T&B Die Index No.‡	Wire Strip Length (In.)	Std. Pkg. Qty.
			W	B	T	L						
LCAN8-6-L	#8 AWG	#6	0.27	0.56	0.10	1.24	Red	P21	49	21	5/8	50
LCAN6-6-L	#6 AWG	#6	0.31	0.81	0.10	1.51	Blue	P24	7	24	7/8	50
LCAN4-10-L	#4 – #3 AWG STR, #2 AWG SOL	#10	0.40	0.81	0.11	1.54	Gray	P29	8	29	7/8	50
LCAN4-14-L		1/4	0.40	0.81	0.11	1.63	Gray	P29	8	29	7/8	50
LCAN2-10-Q	#2 AWG	#10	0.42	0.88	0.12	1.67	Brown	P33	10	33	15/16	25
LCAN2-14-Q		1/4	0.42	0.88	0.12	1.77	Brown	P33	10	33	15/16	25
LCAN1-10-E	#1 AWG	#10	0.47	0.88	0.11	1.69	Green	P37	11	37	15/16	20
LCAN1-14-E		1/4	0.47	0.88	0.12	1.79	Green	P37	11	37	15/16	20
LCAN1/0-10-X	1/0 AWG	#10	0.52	0.94	0.13	1.78	Pink	P42	12	42	1	10
LCAN1/0-14-X		1/4	0.52	0.94	0.13	1.95	Pink	P42	12	42	1	10
LCAN1/0-56-X		5/16	0.52	0.94	0.13	2.00	Pink	P42	12	42	1	10
LCAN2/0-10-X	2/0 AWG	#10	0.58	0.98	0.13	1.84	Black	P45	13	45	1 1/16	10
LCAN2/0-14-X		1/4	0.58	0.98	0.14	2.09	Black	P45	13	45	1 1/16	10
LCAN2/0-56-X		5/16	0.58	0.98	0.14	2.09	Black	P45	13	45	1 1/16	10
LCAN2/0-38-X		3/8	0.58	0.98	0.13	2.15	Black	P45	13	45	1 1/16	10
LCAN3/0-14-X	3/0 AWG	1/4	0.64	1.14	0.14	2.28	Orange	P50	14	50	1 3/16	10
LCAN3/0-56-X		5/16	0.64	1.14	0.13	2.28	Orange	P50	14	50	1 3/16	10
LCAN3/0-38-X		3/8	0.64	1.14	0.13	2.34	Orange	P50	14	50	1 3/16	10
LCAN4/0-14-X	4/0 AWG	1/4	0.71	1.19	0.14	2.36	Purple	P54	15	54	1 1/4	10
LCAN4/0-56-X		5/16	0.71	1.19	0.14	2.38	Purple	P54	15	54	1 1/4	10
LCAN4/0-38-X		3/8	0.71	1.19	0.15	2.45	Purple	P54	15	54	1 1/4	10

‡See pages D3.58 – D3.61 for tool and die information.

\*\*Consult cable manufacturer for voltage stress relief instructions with applications greater than 2000 V.

Table continues on page D2.20

A. System Overview

B1. Cable Ties

B2. Cable Accessories

B3. Stainless Steel Ties

C1. Wiring Duct

C2. Surface Raceway

C3. Abrasion Protection

C4. Cable Management

D1. Terminals

D2. Power Connectors

D3. Grounding Connectors

E1. Labeling Systems

E2. Labels

E3. Pre-Printed & Write-On Markers

E4. Permanent Identification

E5. Lockout/Tagout & Safety Solutions

F. Index

A.  
System  
Overview



## Code Conductor, One-Hole, Standard Barrel with Window, Narrow Tongue Lug (continued)

B1.  
Cable Ties

B2.  
Cable  
Accessories

B3.  
Stainless  
Steel Ties

C1.  
Wiring  
Duct

C2.  
Surface  
Raceway

C3.  
Abrasion  
Protection

C4.  
Cable  
Management

D1.  
Terminals

D2.  
Power  
Connectors

D3.  
Grounding  
Connectors

E1.  
Labeling  
Systems

E2.  
Labels

E3.  
Pre-Printed  
& Write-On  
Markers

E4.  
Permanent  
Identification

E5.  
Lockout/  
Tagout  
& Safety  
Solutions

F.  
Index

Part Number	Copper Conductor Size	Stud Hole Size (In.)	Figure Dimensions (In.)				Panduit Color Code	Panduit Die Index No.‡	Burndy Die Index No.‡	T&B Die Index No.‡	Wire Strip Length (In.)	Std. Pkg. Qty.
			W	B	T	L						
<b>LCAN250-14-X</b>	250 kcmil	1/4	0.77	1.25	0.14	2.47	Yellow	P62	16	62	1 5/16	10
<b>LCAN250-38-X</b>		3/8	0.77	1.25	0.15	2.55	Yellow	P62	16	62	1 5/16	10
<b>LCAN300-14-X</b>	300 kcmil	1/4	0.81	1.44	0.16	2.90	White	P66	17	66	1 1/2	10
<b>LCAN300-38-X</b>		3/8	0.81	1.44	0.16	2.94	White	P66	17	66	1 1/2	10
<b>LCAN350-38-X</b>	350 kcmil	3/8	0.88	1.44	0.17	2.98	Red	P71	18	71	1 1/2	10
<b>LCAN350-12-X</b>		1/2	0.88	1.44	0.17	3.09	Red	P71	18	71	1 1/2	10
<b>LCAN400-38-6</b>	400 kcmil	3/8	0.95	1.50	0.18	3.22	Blue	P76	19	76	1 9/16	6
<b>LCAN400-12-6</b>		1/2	0.95	1.50	0.18	3.22	Blue	P76	19	76	1 9/16	6
<b>LCAN500-38-6</b>	500 kcmil	3/8	1.06	1.75	0.23	3.39	Brown	P87	20	87	1 13/16	6
<b>LCAN500-12-6</b>		1/2	1.06	1.75	0.22	3.55	Brown	P87	20	87	1 13/16	6
<b>LCAN600-38-6</b>	600 kcmil	3/8	1.19	1.75	0.27	3.44	Green	P94	22	94	1 13/16	6
<b>LCAN600-12-6</b>		1/2	1.19	1.75	0.27	4.20	Green	P94	22	94	1 13/16	6
<b>LCAN750-38-6</b>	750 kcmil	3/8	1.30	1.88	0.28	3.84	Black	P106	24	106	1 15/16	6
<b>LCAN750-12-6</b>		1/2	1.30	1.88	0.28	4.03	Black	P106	24	106	1 15/16	6
<b>LCAN750-58-6</b>		5/8	1.30	1.88	0.28	4.59	Black	P106	24	106	1 15/16	6

‡See pages D3.58 – D3.61 for tool and die information.

\*\*Consult cable manufacturer for voltage stress relief instructions with applications greater than 2000 V.



## Code Conductor, Short Blank Tongue, Standard Barrel with Window Lug

For Use with Stranded Copper Conductors

### Type LCA-00

- Color-coded barrels marked with Panduit and specified competitor die index numbers for proper crimp die selection
- Inspection window to visually assure full conductor insertion
- Tin-plated to inhibit corrosion
- UL Recognized and CSA Certified to 35 KV\*\* and temperature rated to 90°C when crimped with Panduit and specified competitor crimping tools and dies



Part Number	Copper Conductor Size	Figure Dimensions (In.)				Panduit Color Code	Panduit Die Index No.‡	Burdny Die Index No.‡	T&B Die Index No.‡	Wire Strip Length (In.)	Std. Pkg. Qty.
		W	B	T	L						
LCA8-00-L	#8 AWG	0.60	0.56	0.05	1.56	Red	P21	49	21	5/8	50
LCA6-00-L	#6 AWG	0.62	0.81	0.06	1.83	Blue	P24	7	24	7/8	50
LCA4-00-L	#4 - #3 AWG STR, #2 AWG SOL	0.62	0.81	0.07	1.85	Gray	P29	8	29	7/8	50
LCA2-00-Q	#2 AWG	0.75	0.88	0.08	2.21	Brown	P33	10	33	15/16	25
LCA1-00-E	#1 AWG	0.75	0.88	0.09	2.23	Green	P37	11	37	15/16	20
LCA1/0-00-X	1/0 AWG	0.80	0.94	0.12	2.31	Pink	P42	12	42	1	10
LCA2/0-00-X	2/0 AWG	0.85	0.98	0.13	2.40	Black	P45	13	45	1 1/16	10
LCA3/0-00-X	3/0 AWG	0.96	1.14	0.13	2.59	Orange	P50	14	50	1 3/16	10
LCA4/0-00-X	4/0 AWG	1.06	1.19	0.14	2.68	Purple	P54	15	54	1 1/4	10
LCA300-00-X	300 kcmil	1.19	1.44	0.16	3.70	White	P66	17	66	1 1/2	10
LCA350-00-X	350 kcmil	1.28	1.44	0.17	3.74	Red	P71	18	71	1 1/2	10
LCA400-00-6	400 kcmil	1.39	1.50	0.18	3.82	Blue	P76	19	76	1 9/16	6
LCA500-00-6	500 kcmil	1.54	1.75	0.22	4.27	Brown	P87	20	87	1 13/16	6
LCA600-00-6	600 kcmil	1.70	1.75	0.26	4.20	Green	P94	22	94	1 13/16	6

‡See pages D3.58 – D3.61 for tool and die information.

\*\*Consult cable manufacturer for voltage stress relief instructions with applications greater than 2000 V.

- A. System Overview
- B1. Cable Ties
- B2. Cable Accessories
- B3. Stainless Steel Ties
- C1. Wiring Duct
- C2. Surface Raceway
- C3. Abrasion Protection
- C4. Cable Management
- D1. Terminals
- D2. Power Connectors
- D3. Grounding Connectors
- E1. Labeling Systems
- E2. Labels
- E3. Pre-Printed & Write-On Markers
- E4. Permanent Identification
- E5. Lockout/Tagout & Safety Solutions
- F. Index

A. System Overview



## Code Conductor, One-Hole, Long Barrel Lug

B1. Cable Ties

### For Use with Stranded Copper Conductors

B2. Cable Accessories

#### Type LCB

- Long barrel maximizes number of crimps and provides premium wire pull-out strength and electrical performance
- Color-coded barrels marked with Panduit and specified competitor die index numbers for proper crimp die selection
- Enclosed barrel prevents corrosive material from entering barrel when used in harsh environments
- Tin-plated to inhibit corrosion

- UL Listed and CSA Certified to 35 KV\*\* and temperature rated to 90°C when crimped with Panduit and specified competitor crimping tools and dies
- UL Listed and CSA Certified for wide wire range-taking capability when crimped with Panduit® Uni-Die™ Dieless Crimping Tools‡
- **Tested by Telcordia – meets NEBS Level 3**
- American Bureau of Shipping Approved

C1. Wiring Duct



C2. Surface Raceway

C3. Abrasion Protection

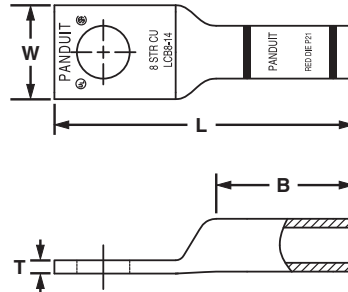

C4. Cable Management

Part Number	Copper Conductor Size	Stud Hole Size (in.)	Figure Dimensions (in.)				Panduit Color Code	Panduit Die Index No.‡	Burdndy Die Index No.‡	T&B Die Index No.‡	Wire Strip Length (in.)	Std. Pkg. Qty.
			W	B	T	L						
LCB8-10-L	#8 AWG	#10	0.41	0.70	0.08	1.44	Red	P21	49	21	3/4	50
LCB8-14-L		1/4	0.48	0.70	0.07	1.53	Red	P21	49	21	3/4	50
LCB8-38-L		3/8	0.60	0.70	0.05	1.75	Red	P21	49	21	3/4	50
LCB6-10-L	#6 AWG	#10	0.45	1.07	0.09	1.84	Blue	P24	7	24	1 1/8	50
<b>LCB6-14-L</b>		1/4	0.48	1.07	0.08	1.93	Blue	P24	7	24	1 1/8	50
LCB6-38-L		3/8	0.62	1.07	0.05	2.15	Blue	P24	7	24	1 1/8	50
LCB4-10-L	#4 – #3 AWG STR, #2 AWG SOL	#10	0.55	1.05	0.09	1.86	Gray	P29	8	29	1 1/8	50
<b>LCB4-14-L</b>		1/4	0.55	1.05	0.09	1.95	Gray	P29	8	29	1 1/8	50
LCB4-56-L		5/16	0.62	1.05	0.07	2.13	Gray	P29	8	29	1 1/8	50
LCB4-38-L		3/8	0.62	1.05	0.07	2.17	Gray	P29	8	29	1 1/8	50
LCB2-10-Q	#2 AWG	#10	0.60	1.16	0.10	2.07	Brown	P33	10	33	1 1/4	25
LCB2-14-Q		1/4	0.60	1.16	0.10	2.14	Brown	P33	10	33	1 1/4	25
<b>LCB2-56-Q</b>		5/16	0.66	1.16	0.10	2.27	Brown	P33	10	33	1 1/4	25
LCB2-38-Q		3/8	0.66	1.16	0.10	2.34	Brown	P33	10	33	1 1/4	25
LCB2-12-Q		1/2	0.75	1.16	0.08	2.58	Brown	P33	10	33	1 1/4	25
LCB1-10-E	#1 AWG	#10	0.70	1.36	0.11	2.30	Green	P37	11	37	1 7/16	20
LCB1-56-E		5/16	0.70	1.36	0.11	2.50	Green	P37	11	37	1 7/16	20
LCB1-38-E		3/8	0.70	1.36	0.11	2.57	Green	P37	11	37	1 7/16	20
LCB1-12-E		1/2	0.75	1.36	0.09	2.81	Green	P37	11	37	1 7/16	20
LCB1/0-10-X	1/0 AWG	#10	0.76	1.44	0.12	2.41	Pink	P42	12	42	1 1/2	10
LCB1/0-56-X		5/16	0.76	1.44	0.12	2.61	Pink	P42	12	42	1 1/2	10
<b>LCB1/0-38-X</b>		3/8	0.76	1.44	0.12	2.69	Pink	P42	12	42	1 1/2	10
LCB1/0-12-X		1/2	0.80	1.44	0.12	2.92	Pink	P42	12	42	1 1/2	10

‡See pages D3.62 – D3.65 for tool and die information.

\*\*Consult cable manufacturer for voltage stress relief instructions with applications greater than 2000 V.

E4. Permanent Identification

E5. Lockout/Tagout & Safety Solutions

F. Index



## Code Conductor, One-Hole, Long Barrel Lug (continued)

Part Number	Copper Conductor Size	Stud Hole Size (In.)	Figure Dimensions (In.)				Panduit Color Code	Panduit Die Index No.‡	Burndy Die Index No.‡	T&B Die Index No.‡	Wire Strip Length (In.)	Std. Pkg. Qty.
			W	B	T	L						
<b>LCB2/0-38-X</b>	2/0 AWG	3/8	0.85	1.50	0.13	2.82	Black	P45	13	45	1 9/16	10
LCB2/0-12-X		1/2	0.85	1.50	0.13	3.07	Black	P45	13	45	1 9/16	10
<b>LCB3/0-38-X</b>	3/0 AWG	3/8	0.96	1.50	0.13	2.87	Orange	P50	14	50	1 9/16	10
LCB3/0-12-X		1/2	0.96	1.50	0.13	3.12	Orange	P50	14	50	1 9/16	10
<b>LCB4/0-38-X</b>	4/0 AWG	3/8	1.06	1.56	0.14	3.03	Purple	P54	15	54	1 5/8	10
LCB4/0-12-X		1/2	1.06	1.56	0.14	3.22	Purple	P54	15	54	1 5/8	10
<b>LCB250-12-X</b>	250 kcmil	1/2	1.17	1.61	0.14	3.32	Yellow	P62	16	62	1 11/16	10
LCB250-78-X		7/8	1.25	1.61	0.12	3.85	Yellow	P62	16	62	1 11/16	10
LCB300-56-X	300 kcmil	5/16	1.19	2.24	0.16	3.95	White	P66	17	66	2 5/16	10
LCB300-38-X		3/8	1.19	2.24	0.16	3.95	White	P66	17	66	2 5/16	10
LCB300-12-X		1/2	1.19	2.24	0.16	4.06	White	P66	17	66	2 5/16	10
LCB350-12-X	350 kcmil	1/2	1.28	2.24	0.17	4.11	Red	P71	18	71	2 5/16	10
LCB350-78-X		7/8	1.28	2.24	0.17	4.78	Red	P71	18	71	2 5/16	10
LCB400-38-6	400 kcmil	3/8	1.39	2.30	0.18	4.27	Blue	P76	19	76	2 3/8	6
LCB400-12-6		1/2	1.39	2.30	0.18	4.27	Blue	P76	19	76	2 3/8	6
LCB400-58-6		5/8	1.39	2.30	0.18	4.48	Blue	P76	19	76	2 3/8	6
LCB400-78-6		7/8	1.39	2.30	0.18	4.88	Blue	P76	19	76	2 3/8	6
LCB500-12-6	500 kcmil	1/2	1.54	2.50	0.22	4.53	Brown	P87	20	87	2 9/16	6
LCB500-58-6		5/8	1.54	2.50	0.22	4.74	Brown	P87	20	87	2 9/16	6
LCB500-78-6		7/8	1.54	2.50	0.22	5.13	Brown	P87	20	87	2 9/16	6
<b>LCB600-12-6</b>	600 kcmil	1/2	1.70	2.69	0.26	5.40	Green	P94	22	94	2 3/4	6
LCB600-58-6		5/8	1.70	2.69	0.26	5.40	Green	P94	22	94	2 3/4	6
<b>LCB750-58-6</b>	750 kcmil	5/8	1.89	2.88	0.26	5.98	Black	P106	24	106	2 15/16	6
LCB750-78-6		7/8	1.89	2.88	0.26	6.07	Black	P106	24	106	2 15/16	6
LCB800-58-6	800 kcmil	5/8	1.95	2.94	0.29	6.06	Orange	P107	25	107	3	6
LCB1000-58-3	1000 kcmil	5/8	2.17	3.00	0.32	6.32	White	P125	27	125	3 1/16	3

‡See pages D3.62 – D3.65 for tool and die information.

\*\*Consult cable manufacturer for voltage stress relief instructions with applications greater than 2000 V.

A.  
System  
Overview

B1.  
Cable Ties

B2.  
Cable  
Accessories

B3.  
Stainless  
Steel Ties

C1.  
Wiring  
Duct

C2.  
Surface  
Raceway

C3.  
Abrasion  
Protection

C4.  
Cable  
Management

D1.  
Terminals

D2.  
Power  
Connectors

D3.  
Grounding  
Connectors

E1.  
Labeling  
Systems

E2.  
Labels

E3.  
Pre-Printed  
& Write-On  
Markers

E4.  
Permanent  
Identification

E5.  
Lockout/  
Tagout  
& Safety  
Solutions

F.  
Index

A. System Overview



## Code Conductor, One-Hole, Long Barrel Lug, 45° Angle

B1. Cable Ties

### For Use with Stranded Copper Conductors

B2. Cable Accessories

#### Type LCB-H

B3. Stainless Steel Ties

- Long barrel maximizes number of crimps and provides premium wire pull-out strength and electrical performance
- Color-coded barrels marked with Panduit and specified competitor die index numbers for proper crimp die selection
- Enclosed barrel prevents corrosive material from entering barrel when used in harsh environments
- Tin-plated to inhibit corrosion

- UL Listed and CSA Certified to 35 KV\*\* and temperature rated to 90°C when crimped with Panduit and specified competitor crimping tools and dies
- UL Listed and CSA Certified for wide wire range-taking capability when crimped with Panduit® Uni-Die™ Dieless Crimping Tools‡
- **Tested by Telcordia – meets NEBS Level 3**
- American Bureau of Shipping approved

C1. Wiring Duct



C2. Surface Raceway

C3. Abrasion Protection

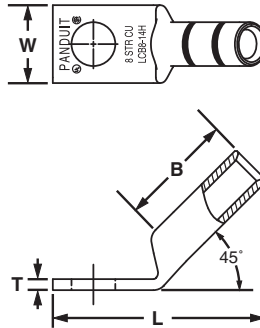

C4. Cable Management

Part Number	Copper Conductor Size	Stud Hole Size (In.)	Figure Dimensions (In.)				Panduit Color Code	Panduit Die Index No.‡	Burdndy Die Index No.‡	T&B Die Index No.‡	Wire Strip Length (In.)	Std. Pkg. Qty.
			W	B	T	L						
<b>LCB8-10H-L</b>	#8 AWG	#10	0.41	0.70	0.08	1.23	Red	P21	49	21	3/4	50
<b>LCB8-14H-L</b>		1/4	0.48	0.70	0.07	1.31	Red	P21	49	21	3/4	50
<b>LCB6-10H-L</b>	#6 AWG	#10	0.45	1.07	0.09	1.52	Blue	P24	7	24	1 1/8	50
<b>LCB6-14H-L</b>		1/4	0.48	1.07	0.08	1.60	Blue	P24	7	24	1 1/8	50
<b>LCB6-38H-L</b>		3/8	0.62	1.07	0.05	1.81	Blue	P24	7	24	1 1/8	50
<b>LCB4-10H-L</b>	#4 – #3 AWG STR, #2 AWG SOL	#10	0.55	1.05	0.09	1.54	Gray	P29	8	29	1 1/8	50
<b>LCB4-14H-L</b>		1/4	0.55	1.05	0.09	1.63	Gray	P29	8	29	1 1/8	50
<b>LCB2-10H-Q</b>	#2 AWG	#10	0.60	1.16	0.10	1.68	Brown	P33	10	33	1 1/4	25
<b>LCB2-56H-Q</b>		5/16	0.66	1.16	0.10	1.87	Brown	P33	10	33	1 1/4	25
<b>LCB1-10H-E</b>	#1 AWG	#10	0.70	1.36	0.11	1.83	Green	P37	11	37	1 7/16	20
<b>LCB1-56H-E</b>		5/16	0.70	1.36	0.11	2.03	Green	P37	11	37	1 7/16	20
<b>LCB1/0-10H-X</b>		#10	0.76	1.44	0.12	1.92	Pink	P42	12	42	1 1/2	10
<b>LCB1/0-56H-X</b>	1/0 AWG	5/16	0.76	1.44	0.12	2.12	Pink	P42	12	42	1 1/2	10
<b>LCB1/0-38H-X</b>		3/8	0.76	1.44	0.12	2.19	Pink	P42	12	42	1 1/2	10
<b>LCB1/0-12H-X</b>		1/2	0.80	1.44	0.11	2.42	Pink	P42	12	42	1 1/2	10
<b>LCB2/0-38H-X</b>	2/0 AWG	3/8	0.85	1.50	0.13	2.31	Black	P45	13	45	1 9/16	10
<b>LCB2/0-12H-X</b>		1/2	0.85	1.50	0.13	2.53	Black	P45	13	45	1 9/16	10
<b>LCB3/0-38H-X</b>	3/0 AWG	3/8	0.96	1.50	0.13	2.33	Orange	P50	14	50	1 9/16	10
<b>LCB3/0-12H-X</b>		1/2	0.96	1.50	0.13	2.58	Orange	P50	14	50	1 9/16	10

‡See pages D3.62 – D3.65 for tool and die information.

\*\*Consult cable manufacturer for voltage stress relief instructions with applications greater than 2000 V.

E4. Permanent Identification

E5. Lockout/Tagout & Safety Solutions

F. Index



## Code Conductor, One-Hole, Long Barrel Lug, 45° Angle (continued)

Part Number	Copper Conductor Size	Stud Hole Size (In.)	Figure Dimensions (In.)				Panduit Color Code	Panduit Die Index No.‡	Burndy Die Index No.‡	T&B Die Index No.‡	Wire Strip Length (In.)	Std. Pkg. Qty.
			W	B	T	L						
LCB4/0-38H-X	4/0 AWG	3/8	1.06	1.56	0.14	2.48	Purple	P54	15	54	1 5/8	10
LCB4/0-12H-X		1/2	1.06	1.56	0.14	2.67	Purple	P54	15	54	1 5/8	10
LCB250-12H-X	250 kcmil	1/2	1.17	1.61	0.14	2.74	Yellow	P62	16	62	1 11/16	10
LCB250-78H-X		7/8	1.25	1.61	0.12	3.27	Yellow	P62	16	62	1 11/16	10
LCB300-56H-X	300 kcmil	5/16	1.19	2.24	0.16	3.24	White	P66	17	66	2 5/16	10
LCB300-38H-X		3/8	1.19	2.24	0.16	3.24	White	P66	17	66	2 5/16	10
LCB300-12H-X		1/2	1.19	2.24	0.16	3.35	White	P66	17	66	2 5/16	10
LCB350-12H-X	350 kcmil	1/2	1.28	2.24	0.17	3.39	Red	P71	18	71	2 5/16	10
LCB350-78H-X		7/8	1.28	2.24	0.17	4.04	Red	P71	18	71	2 5/16	10
LCB400-12H-6	400 kcmil	1/2	1.39	2.30	0.18	3.53	Blue	P76	19	76	2 3/8	6
LCB400-58H-6		5/8	1.39	2.30	0.18	3.74	Blue	P76	19	76	2 3/8	6
LCB400-78H-6		7/8	1.39	2.30	0.18	4.13	Blue	P76	19	76	2 3/8	6
LCB500-12H-6	500 kcmil	1/2	1.54	2.50	0.22	3.74	Brown	P87	20	87	2 9/16	6
LCB500-58H-6		5/8	1.54	2.50	0.22	3.95	Brown	P87	20	87	2 9/16	6
LCB500-78H-6		7/8	1.54	2.50	0.22	4.34	Brown	P87	20	87	2 9/16	6
LCB600-12H-6	600 kcmil	1/2	1.70	2.69	0.26	4.56	Green	P94	22	94	2 3/4	6
LCB600-58H-6		5/8	1.70	2.69	0.26	4.56	Green	P94	22	94	2 3/4	6

‡See pages D3.62 – D3.65 for tool and die information.

\*\*Consult cable manufacturer for voltage stress relief instructions with applications greater than 2000 V.

A.  
System  
Overview

B1.  
Cable Ties

B2.  
Cable  
Accessories

B3.  
Stainless  
Steel Ties

C1.  
Wiring  
Duct

C2.  
Surface  
Raceway

C3.  
Abrasion  
Protection

C4.  
Cable  
Management

D1.  
Terminals

D2.  
Power  
Connectors

D3.  
Grounding  
Connectors

E1.  
Labeling  
Systems

E2.  
Labels

E3.  
Pre-Printed  
& Write-On  
Markers

E4.  
Permanent  
Identification

E5.  
Lockout/  
Tagout  
& Safety  
Solutions

F.  
Index

A. System Overview



## Code Conductor, One-Hole, Long Barrel Lug, 90° Angle

B1. Cable Ties

**For Use with Stranded Copper Conductors**

### Type LCB-F

B2. Cable Accessories

- Long barrel maximizes number of crimps and provides premium wire pull-out strength and electrical performance
- Color-coded barrels marked with Panduit and specified competitor die index numbers for proper crimp die selection
- Enclosed barrel prevents corrosive material from entering barrel when used in harsh environments
- Tin-plated to inhibit corrosion

- UL Listed and CSA Certified to 35 KV\*\* and temperature rated to 90°C when crimped with Panduit and specified competitor crimping tools and dies
- UL Listed and CSA Certified for wide wire range-taking capability when crimped with Panduit® Uni-Die™ Dieless Crimping Tools‡
- **Tested by Telcordia – meets NEBS Level 3**
- American Bureau of Shipping approved

B3. Stainless Steel Ties

C1. Wiring Duct



C2. Surface Raceway

C3. Abrasion Protection

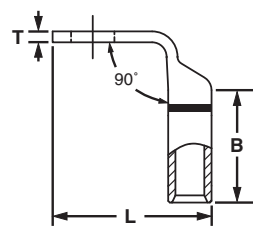

C4. Cable Management

Part Number	Copper Conductor Size	Stud Hole Size (In.)	Figure Dimensions (In.)				Panduit Color Code	Panduit Die Index No.‡	Burdny Die Index No.‡	T&B Die Index No.‡	Wire Strip Length (In.)	Std. Pkg. Qty.
			W	B	T	L						
LCB8-10F-L	#8 AWG	#10	0.41	0.70	0.08	1.08	Red	P21	49	21	3/4	50
LCB8-14F-L		1/4	0.48	0.70	0.07	1.07	Red	P21	49	21	3/4	50
LCB6-10F-L	#6 AWG	#10	0.45	1.07	0.09	1.49	Blue	P24	7	24	1 1/8	50
LCB6-14F-L		1/4	0.48	1.07	0.08	1.48	Blue	P24	7	24	1 1/8	50
LCB6-38F-L		3/8	0.62	1.07	0.05	1.45	Blue	P24	7	24	1 1/8	50
LCB4-10F-L	#4 – #3 AWG STR, #2 AWG SOL	#10	0.55	1.05	0.09	1.53	Gray	P29	8	29	1 1/8	50
LCB4-14F-L		1/4	0.55	1.05	0.09	1.53	Gray	P29	8	29	1 1/8	50
LCB2-10F-Q	#2 AWG	#10	0.60	1.16	0.10	1.75	Brown	P33	10	33	1 1/4	25
LCB2-56F-Q		5/16	0.66	1.16	0.10	1.74	Brown	P33	10	33	1 1/4	25
LCB1-10F-E	#1 AWG	#10	0.70	1.36	0.11	2.00	Green	P37	11	37	1 7/16	20
LCB1-56F-E		5/16	0.70	1.36	0.11	2.00	Green	P37	11	37	1 7/16	20
LCB1/0-10F-X		#10	0.76	1.44	0.12	2.15	Pink	P42	12	42	1 1/2	10
LCB1/0-56F-X	1/0 AWG	5/16	0.76	1.44	0.12	2.15	Pink	P42	12	42	1 1/2	10
LCB1/0-38F-X		3/8	0.76	1.44	0.12	2.15	Pink	P42	12	42	1 1/2	10
LCB1/0-12F-X	2/0 AWG	1/2	0.80	1.44	0.12	2.14	Pink	P42	12	42	1 1/2	10
LCB2/0-38F-X		3/8	0.85	1.50	0.13	2.30	Black	P45	13	45	1 9/16	10
LCB3/0-38F-X		3/8	0.96	1.50	0.13	2.35	Orange	P50	14	50	1 9/16	10
LCB3/0-12F-X	3/0 AWG	1/2	0.96	1.50	0.13	2.35	Orange	P50	14	50	1 9/16	10
LCB4/0-38F-X		3/8	1.06	1.56	0.14	2.48	Purple	P54	15	54	1 5/8	10
LCB4/0-12F-X	4/0 AWG	1/2	1.06	1.56	0.14	2.48	Purple	P54	15	54	1 5/8	10

‡See pages D3.62 – D3.65 for tool and die information.

\*\*Consult cable manufacturer for voltage stress relief instructions with applications greater than 2000 V.

E4. Permanent Identification

E5. Lockout/Tagout & Safety Solutions

F. Index





## Code Conductor, One-Hole, Long Barrel Lug, 90° Angle (continued)

Part Number	Copper Conductor Size	Stud Hole Size (In.)	Figure Dimensions (In.)				Panduit Color Code	Panduit Die Index No.‡	Burndy Die Index No.‡	T&B Die Index No.‡	Wire Strip Length (In.)	Std. Pkg. Qty.
			W	B	T	L						
LCB250-12F-X	250 kcmil	1/2	1.17	1.61	0.14	2.57	Yellow	P62	16	62	1 11/16	10
LCB250-78F-X		7/8	1.25	1.61	0.12	2.49	Yellow	P62	16	62	1 11/16	10
LCB350-12F-X	350 kcmil	1/2	1.28	2.24	0.17	3.34	Red	P71	18	71	2 5/16	10
LCB350-78F-X		7/8	1.28	2.24	0.17	3.34	Red	P71	18	71	2 5/16	10
LCB400-58F-6	400 kcmil	5/8	1.39	2.30	0.18	3.47	Blue	P76	19	76	2 3/8	6
LCB400-78F-6		7/8	1.39	2.30	0.18	3.47	Blue	P76	19	76	2 3/8	6
LCB500-12F-6	500 kcmil	1/2	1.54	2.50	0.22	3.77	Brown	P87	20	87	2 9/16	6
LCB500-58F-6		5/8	1.54	2.50	0.22	3.77	Brown	P87	20	87	2 9/16	6
LCB500-78F-6		7/8	1.54	2.50	0.22	3.77	Brown	P87	20	87	2 9/16	6
LCB600-12F-6	600 kcmil	1/2	1.70	2.69	0.26	4.08	Green	P94	22	94	2 3/4	6
LCB600-58F-6		5/8	1.70	2.69	0.26	4.08	Green	P94	22	94	2 3/4	6

‡See pages D3.62 – D3.65 for tool and die information.

\*\*Consult cable manufacturer for voltage stress relief instructions with applications greater than 2000 V.

A.  
System  
Overview

B1.  
Cable Ties

B2.  
Cable  
Accessories

B3.  
Stainless  
Steel Ties

C1.  
Wiring  
Duct

C2.  
Surface  
Raceway

C3.  
Abrasion  
Protection

C4.  
Cable  
Management

D1.  
Terminals

D2.  
Power  
Connectors

D3.  
Grounding  
Connectors

E1.  
Labeling  
Systems

E2.  
Labels

E3.  
Pre-Printed  
& Write-On  
Markers

E4.  
Permanent  
Identification

E5.  
Lockout/  
Tagout  
& Safety  
Solutions

F.  
Index

A. System Overview



## Code Conductor, One-Hole, Long Barrel with Window Lug

B1. Cable Ties

### For Use with Stranded Copper Conductors

#### Type LCB-W

B2. Cable Accessories

- Long barrel maximizes number of crimps and provides premium wire pull-out strength and electrical performance
- Inspection window to visually assure full conductor insertion
- Color-coded barrels marked with Panduit and specified competitor die index numbers for proper crimp die selection
- Tin-plated to inhibit corrosion
- UL Listed and CSA Certified to 35 KV\*\* and temperature rated to 90°C when crimped with Panduit and specified competitor crimping tools and dies

- UL Listed and CSA Certified for wide wire range-taking capability when crimped with Panduit® Uni-Die™ Dieless Crimping Tools‡
- **Tested by Telcordia – meets NEBS Level 3**
- Meets J-STD-607-A and TIA-942 requirements for network systems grounding applications

C1. Wiring Duct

C2. Surface Raceway

C3. Abrasion Protection

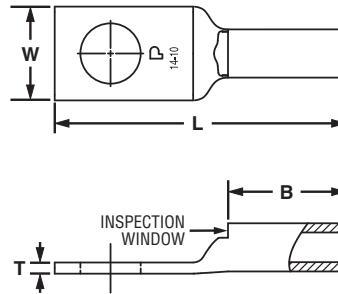

C4. Cable Management

Part Number	Copper Conductor Size	Stud Hole Size (In.)	Figure Dimensions (In.)				Panduit Color Code	Panduit Die Index No.‡	Burdny Die Index No.‡	T&B Die Index No.‡	Wire Strip Length (In.)	Std. Pkg. Qty.
			W	B	T	L						
<b>LCB10-14W-L*</b>	#14 – #10 AWG STR, #12 – #10 AWG SOL	1/4	0.42	0.53	0.05	1.31	—	—	—	—	9/16	50
<b>LCB750-38W-6</b>	750 kcmil	3/8	1.89	2.88	0.26	4.83	Black	P106	24	106	2 15/16	6
<b>LCB750-12W-6</b>		1/2	1.89	2.88	0.26	5.03	Black	P106	24	106	2 15/16	6
<b>LCB750-58W-6</b>		5/8	1.89	2.88	0.26	5.58	Black	P106	24	106	2 15/16	6
<b>LCB750-78W-6</b>		7/8	1.89	2.88	0.26	5.68	Black	P106	24	106	2 15/16	6
<b>LCB800-12W-6</b>	800 kcmil	1/2	1.95	2.94	0.30	5.11	Orange	P107	25	107	3	6
<b>LCB800-58W-6</b>		5/8	1.95	2.94	0.30	5.68	Orange	P107	25	107	3	6
<b>LCB1000-38W-3</b>	1000 kcmil	3/8	2.17	3.00	0.32	5.08	White	P125	27	125	3 1/16	3
<b>LCB1000-12W-3</b>		1/2	2.17	3.00	0.32	5.27	White	P125	27	125	3 1/16	3
<b>LCB1000-58W-3</b>		5/8	2.17	3.00	0.32	5.92	White	P125	27	125	3 1/16	3

‡See pages D3.62 – D3.65 for tool and die information.

\*Not tested to NEBS Level 3 requirements.

\*\*Consult cable manufacturer for voltage stress relief instructions with applications greater than 2000 V.

E1. Labeling Systems

E2. Labels

E3. Pre-Printed & Write-On Markers

E4. Permanent Identification

E5. Lockout/Tagout & Safety Solutions

F. Index



## Code Conductor, One-Hole, Long Barrel with Window Lug, 45° Angle

For Use with Stranded Copper Conductors

### Type LCB-WH

- Long barrel maximizes number of crimps and provides premium wire pull-out strength and electrical performance
- Inspection window to visually assure full conductor insertion
- Tin-plated to inhibit corrosion
- UL Listed and CSA Certified to 35 KV\*\* and temperature rated to 90°C when crimped with Panduit crimping tools and dies
- Meets J-STD-607-A and TIA-942 requirements for network systems grounding applications

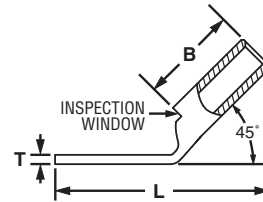
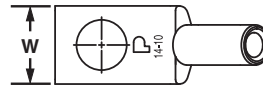

Part Number	Copper Conductor Size	Stud Hole Size (In.)	Figure Dimensions (In.)				Panduit Color Code	Panduit Die Index No.‡	Burdny Die Index No.‡	T&B Die Index No.‡	Wire Strip Length (In.)	Std. Pkg. Qty.
			W	B	T	L						
LCB10-14WH-L	#14 – #10 AWG STR, #12 – #10 AWG SOL	1/4	0.42	0.53	0.05	1.15	—	—	—	—	9/16	50

‡See pages D3.62 – D3.65 for tool and die information.

\*\*Consult cable manufacturer for voltage stress relief instructions with applications greater than 2000 V.



## Code Conductor, One-Hole, Long Barrel with Window Lug, 90° Angle

For Use with Stranded Copper Conductors

### Type LCB-WF

- Long barrel maximizes number of crimps and provides premium wire pull-out strength and electrical performance
- Inspection window to visually assure full conductor insertion
- Tin-plated to inhibit corrosion
- UL Listed and CSA Certified to 35 KV\*\* and temperature rated to 90°C when crimped with Panduit crimping tools and dies
- Meets J-STD-607-A and TIA-942 requirements for network systems grounding applications

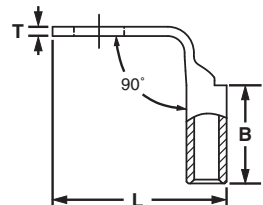
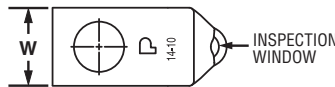

Part Number	Copper Conductor Size	Stud Hole Size (In.)	Figure Dimensions (In.)				Panduit Color Code	Panduit Die Index No.‡	Burdny Die Index No.‡	T&B Die Index No.‡	Wire Strip Length (In.)	Std. Pkg. Qty.
			W	B	T	L						
LCB10-14WF-L	#14 – #10 AWG STR, #12 – #10 AWG SOL	1/4	0.42	0.53	0.05	0.94	—	—	—	—	9/16	50

‡See pages D3.62 – D3.65 for tool and die information.

\*\*Consult cable manufacturer for voltage stress relief instructions with applications greater than 2000 V.

A. System Overview

B1. Cable Ties

B2. Cable Accessories

B3. Stainless Steel Ties

C1. Wiring Duct

C2. Surface Raceway

C3. Abrasion Protection

C4. Cable Management

D1. Terminals

D2. Power Connectors

D3. Grounding Connectors

E1. Labeling Systems

E2. Labels

E3. Pre-Printed & Write-On Markers

E4. Permanent Identification

E5. Lockout/Tagout & Safety Solutions

F. Index

A. System Overview



## Code Conductor, One-Hole, Long Barrel with Corona Relief Taper Lug

B1. Cable Ties

**To Facilitate Use with Stranded Copper Conductors in Applications of 5000 V or More**

B2. Cable Accessories

### Type LCBH

- Externally chamfered barrel end inhibits Corona effect when used in high voltage applications
- Long barrel maximizes number of crimps and provides premium wire pull-out strength and electrical performance
- Color-coded barrels marked with Panduit and specified competitor die index numbers for proper crimp die selection
- Enclosed barrel prevents corrosive material from entering barrel when used in harsh environments
- Tin-plated to inhibit corrosion
- UL Listed and CSA Certified to 35 KV\*\* and temperature rated to 90°C when crimped with Panduit and specified competitor crimping tools and dies

B3. Stainless Steel Ties

C1. Wiring Duct



C2. Surface Raceway



Corona Relief Taper

C3. Abrasion Protection

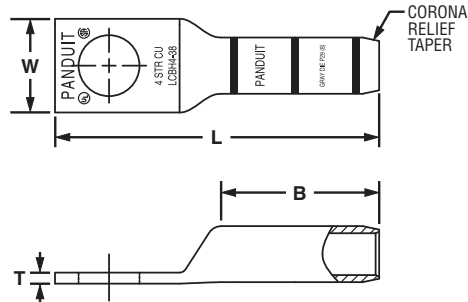

C4. Cable Management

Part Number	Copper Conductor Size	Stud Hole Size (In.)	Figure Dimensions (In.)				Panduit Color Code	Panduit Die Index No.‡	Burndy Die Index No.‡	T&B Die Index No.‡	Wire Strip Length (In.)	Std. Pkg. Qty.
			W	B	T	L						
<b>LCBH4-38-L</b>	#4 AWG	3/8	0.62	1.05	0.07	2.16	Gray	P29	8	29	1 1/8	50
<b>LCBH2-38-Q</b>	#2 AWG	3/8	0.66	1.16	0.10	2.34	Brown	P33	10	33	1 1/4	25
<b>LCBH1-38-E</b>	#1 AWG	3/8	0.70	1.36	0.10	2.57	Green	P37	11	37	1 7/16	20
<b>LCBH1/0-38-X</b>	1/0 AWG	3/8	0.76	1.44	0.12	2.69	Pink	P42	12	42	1 1/2	10
<b>LCBH2/0-12-X</b>	2/0 AWG	1/2	0.85	1.50	0.13	3.07	Black	P45	13	45	1 9/16	10
<b>LCBH3/0-12-X</b>	3/0 AWG	1/2	0.96	1.50	0.13	3.12	Orange	P50	14	50	1 9/16	10
<b>LCBH4/0-12-X</b>	4/0 AWG	1/2	1.06	1.56	0.14	3.22	Purple	P54	15	54	1 5/8	10
<b>LCBH250-12-X</b>	250 kcmil	1/2	1.17	1.61	0.14	3.32	Yellow	P62	16	62	1 11/16	10

‡See pages D3.66, D3.67 for tool and die information.

\*\*Consult cable manufacturer for voltage stress relief instructions with applications greater than 2000 V.

E1. Labeling Systems

E2. Labels

E3. Pre-Printed & Write-On Markers

E4. Permanent Identification

E5. Lockout/Tagout & Safety Solutions

F. Index



## Code Conductor, Two-Hole, Standard Barrel with Window Lug

For Use with Stranded Copper Conductors

### Type LCD

- Color-coded barrels marked with Panduit and specified competitor die index numbers for proper crimp die selection
- Inspection window to visually assure full conductor insertion
- Tin-plated to inhibit corrosion
- UL Listed and CSA Certified to 35 KV\*\* and temperature rated to 90°C when crimped with Panduit and specified competitor crimping tools and dies
- UL Listed and CSA Certified for wide wire range-taking capability when crimped with Panduit® Uni-Die™ Dieless Crimping Tools‡
- Tested by Telcordia – meets NEBS Level 3
- American Bureau of Shipping approved
- Available with NEMA hole sizes and spacing

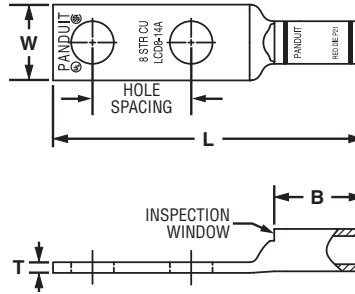

Part Number	Copper Conductor Size	Stud Hole Size (In.)	Stud Hole Spacing (In.)	Figure Dimensions (In.)				Panduit Color Code	Panduit Die Index No.‡	Burndy Die Index No.‡	T&B Die Index No.‡	Wire Strip Length (In.)	Std. Pkg. Qty.
				W	B	T	L						
LCD10-10A-L*	#14 – #10 AWG STR, #12 – #10 AWG SOL	#10	0.63	0.38	0.38	0.06	1.69	—	—	—	—	7/16	50
LCD10-14A-L*		1/4	0.63	0.42	0.38	0.05	1.78	—	—	—	—	7/16	50
LCD10-14B-L*		1/4	0.75	0.42	0.38	0.05	1.91	—	—	—	—	7/16	50
LCD10-14D-L*		1/4	1.00	0.42	0.38	0.05	2.16	—	—	—	—	7/16	50
LCD10-38D-L*		3/8	1.00	0.56	0.38	0.04	2.38	—	—	—	—	7/16	50
LCD8-10A-L	#8 AWG	#10	0.63	0.41	0.56	0.08	1.88	Red	P21	49	21	5/8	50
LCD8-14A-L		1/4	0.63	0.48	0.56	0.07	1.97	Red	P21	49	21	5/8	50
LCD8-14B-L		1/4	0.75	0.48	0.56	0.07	2.09	Red	P21	49	21	5/8	50
LCD8-14D-L		1/4	1.00	0.48	0.56	0.07	2.34	Red	P21	49	21	5/8	50
LCD8-38D-L		3/8	1.00	0.60	0.56	0.05	2.56	Red	P21	49	21	5/8	50
LCD6-10A-L	#6 AWG	#10	0.63	0.46	0.81	0.08	2.15	Blue	P24	7	24	7/8	50
LCD6-10B-L		#10	0.75	0.46	0.81	0.08	2.27	Blue	P24	7	24	7/8	50
LCD6-10D-L		#10	1.00	0.46	0.81	0.08	2.52	Blue	P24	7	24	7/8	50
LCD6-14A-L		1/4	0.63	0.48	0.81	0.08	2.24	Blue	P24	7	24	7/8	50
LCD6-14B-L		1/4	0.75	0.48	0.81	0.08	2.36	Blue	P24	7	24	7/8	50
LCD6-14D-L		1/4	1.00	0.48	0.81	0.08	2.61	Blue	P24	7	24	7/8	50
LCD6-56D-L		5/16	1.00	0.56	0.81	0.07	2.73	Blue	P24	7	24	7/8	50
LCD6-38D-L		3/8	1.00	0.62	0.81	0.06	2.83	Blue	P24	7	24	7/8	50
LCD4-10A-L	#4 – #3 AWG STR, #2 AWG SOL	#10	0.63	0.55	0.81	0.09	2.17	Gray	P29	8	29	7/8	50
LCD4-10B-L		#10	0.75	0.55	0.81	0.09	2.29	Gray	P29	8	29	7/8	50
LCD4-14A-L		1/4	0.63	0.55	0.81	0.09	2.26	Gray	P29	8	29	7/8	50
LCD4-14B-L		1/4	0.75	0.55	0.81	0.09	2.38	Gray	P29	8	29	7/8	50
LCD4-14D-L		1/4	1.00	0.55	0.81	0.09	2.63	Gray	P29	8	29	7/8	50
LCD4-38D-L		3/8	1.00	0.62	0.81	0.08	2.85	Gray	P29	8	29	7/8	50
LCD2-14A-Q	#2 AWG	1/4	0.63	0.60	0.88	0.10	2.40	Brown	P33	10	33	15/16	25
LCD2-14B-Q		1/4	0.75	0.60	0.88	0.10	2.52	Brown	P33	10	33	15/16	25
LCD2-14D-Q		1/4	1.00	0.60	0.88	0.10	2.77	Brown	P33	10	33	15/16	25
LCD2-56B-Q		5/16	0.75	0.66	0.88	0.10	2.65	Brown	P33	10	33	15/16	25
LCD2-38D-Q		3/8	1.00	0.66	0.88	0.10	3.00	Brown	P33	10	33	15/16	25
LCD2-12-Q		1/2	1.75	0.75	0.88	0.08	4.14	Brown	P33	10	33	15/16	25

‡See pages D3.58 – D3.61 for tool and die information.

\*Not tested to NEBS Level 3 requirements.

\*\*Consult cable manufacturer for voltage stress relief instructions with applications greater than 2000 V.

Table continues on page D2.32

A. System Overview

B1. Cable Ties

B2. Cable Accessories

B3. Stainless Steel Ties

C1. Wiring Duct

C2. Surface Raceway

C3. Abrasion Protection

C4. Cable Management

D1. Terminals

D2. Power Connectors

D3. Grounding Connectors

E1. Labeling Systems

E2. Labels

E3. Pre-Printed & Write-On Markers

E4. Permanent Identification

E5. Lockout/Tagout & Safety Solutions

F. Index



## Code Conductor, Two-Hole, Standard Barrel with Window Lug (continued)

- A. System Overview
- B1. Cable Ties
- B2. Cable Accessories
- B3. Stainless Steel Ties
- C1. Wiring Duct
- C2. Surface Raceway
- C3. Abrasion Protection
- C4. Cable Management
- D1. Terminals
- D2. Power Connectors
- D3. Grounding Connectors
- E1. Labeling Systems
- E2. Labels
- E3. Pre-Printed & Write-On Markers
- E4. Permanent Identification
- E5. Lockout/Tagout & Safety Solutions
- F. Index

Part Number	Copper Conductor Size	Stud Hole Size (In.)	Stud Hole Spacing (In.)	Figure Dimensions (In.)				Panduit Color Code	Panduit Die Index No.‡	Burdny Die Index No.‡	T&B Die Index No.‡	Wire Strip Length (In.)	Std. Pkg. Qty.	
				W	B	T	L							
<b>LCD1-14A-E</b>	#1 AWG	1/4	0.63	0.70	0.88	0.11	2.42	Green	P37	11	37	15/16	20	
LCD1-14B-E		1/4	0.75	0.70	0.88	0.11	2.54	Green	P37	11	37	15/16	20	
LCD1-56C-E		5/16	0.88	0.70	0.88	0.11	2.79	Green	P37	11	37	15/16	20	
<b>LCD1-38D-E</b>		3/8	1.00	0.70	0.88	0.11	2.99	Green	P37	11	37	15/16	20	
LCD1-12-E		1/2	1.75	0.75	0.88	0.09	4.16	Green	P37	11	37	15/16	20	
LCD1/0-14A-X		1/0 AWG	1/4	0.63	0.76	0.94	0.12	2.57	Pink	P42	12	42	1	10
LCD1/0-14B-X	1/4		0.75	0.76	0.94	0.12	2.70	Pink	P42	12	42	1	10	
LCD1/0-56C-X	5/16		0.88	0.76	0.94	0.12	2.88	Pink	P42	12	42	1	10	
<b>LCD1/0-38D-X</b>	3/8		1.00	0.76	0.94	0.12	3.08	Pink	P42	12	42	1	10	
LCD1/0-12-X	1/2		1.75	0.80	0.94	0.12	4.25	Pink	P42	12	42	1	10	
LCD2/0-14A-X	2/0 AWG		1/4	0.63	0.85	0.98	0.13	2.70	Black	P45	13	45	1 1/16	10
<b>LCD2/0-14B-X</b>		1/4	0.75	0.85	0.98	0.13	2.83	Black	P45	13	45	1 1/16	10	
LCD2/0-56C-X		5/16	0.88	0.85	0.98	0.13	2.95	Black	P45	13	45	1 1/16	10	
LCD2/0-38D-X		3/8	1.00	0.85	0.98	0.13	3.14	Black	P45	13	45	1 1/16	10	
LCD2/0-12-X		1/2	1.75	0.85	0.98	0.13	4.30	Black	P45	13	45	1 1/16	10	
LCD3/0-14B-X		3/0 AWG	1/4	0.75	0.96	1.14	0.13	3.02	Orange	P50	14	50	1 3/16	10
<b>LCD3/0-56D-X</b>	5/16		1.00	0.96	1.14	0.13	3.27	Orange	P50	14	50	1 3/16	10	
LCD3/0-38D-X	3/8		1.00	0.96	1.14	0.13	3.33	Orange	P50	14	50	1 3/16	10	
LCD3/0-12-X	1/2		1.75	0.96	1.14	0.13	4.49	Orange	P50	14	50	1 3/16	10	
LCD4/0-14B-X	4/0 AWG		1/4	0.75	1.06	1.19	0.14	3.10	Purple	P54	15	54	1 1/4	10
<b>LCD4/0-38D-X</b>			3/8	1.00	1.06	1.19	0.14	3.44	Purple	P54	15	54	1 1/4	10
◆ LCD4/0-12-X		1/2	1.75	1.06	1.19	0.14	4.58	Purple	P54	15	54	1 1/4	10	
<b>LCD250-38D-X</b>		250 kcmil	3/8	1.00	1.17	1.25	0.14	3.54	Yellow	P62	16	62	1 5/16	10
◆ LCD250-12-X			1/2	1.75	1.17	1.25	0.14	4.68	Yellow	P62	16	62	1 5/16	10
LCD300-38D-X		300 kcmil	3/8	1.00	1.19	1.44	0.16	3.74	White	P66	17	66	1 1/2	10
◆ LCD300-12-X	1/2		1.75	1.19	1.44	0.16	4.92	White	P66	17	66	1 1/2	10	
LCD350-14B-X	350 kcmil	1/4	0.75	1.28	1.44	0.17	3.30	Red	P71	18	71	1 1/2	10	
LCD350-38D-X		3/8	1.00	1.28	1.44	0.17	3.78	Red	P71	18	71	1 1/2	10	
LCD350-12E-X		1/2	1.25	1.28	1.44	0.17	4.33	Red	P71	18	71	1 1/2	10	
◆ LCD350-12-X		1/2	1.75	1.28	1.44	0.17	4.96	Red	P71	18	71	1 1/2	10	
LCD400-38D-6		400 kcmil	3/8	1.00	1.39	1.50	0.18	3.86	Blue	P76	19	76	1 9/16	6
◆ LCD400-12-6			1/2	1.75	1.39	1.50	0.18	5.04	Blue	P76	19	76	1 9/16	6
LCD500-14B-6	500 kcmil	1/4	0.75	1.54	1.75	0.22	3.71	Brown	P87	20	87	1 13/16	6	
LCD500-38D-6		3/8	1.00	1.54	1.75	0.22	4.19	Brown	P87	20	87	1 13/16	6	
LCD500-12E-6		1/2	1.25	1.54	1.75	0.22	4.74	Brown	P87	20	87	1 13/16	6	
◆ LCD500-12-6		1/2	1.75	1.54	1.75	0.22	5.37	Brown	P87	20	87	1 13/16	6	
LCD600-38D-6		600 kcmil	3/8	1.00	1.70	1.75	0.26	4.24	Green	P94	22	94	1 13/16	6
◆ LCD600-12-6			1/2	1.75	1.70	1.75	0.26	5.42	Green	P94	22	94	1 13/16	6
LCD750-38D-6	750 kcmil	3/8	1.00	1.89	1.88	0.26	4.71	Black	P106	24	106	1 15/16	6	
◆ LCD750-12-6		1/2	1.75	1.89	1.88	0.26	5.65	Black	P106	24	106	1 15/16	6	
LCD750-58G-6	750 kcmil	5/8	1.50	1.89	1.88	0.26	5.46	Black	P106	24	106	1 15/16	6	
◆ LCD1000-12-3	1000 kcmil	1/2	1.75	2.17	1.88	0.32	5.77	White	P125	27	125	1 15/16	3	
LCD1000-12E-3		1/2	1.25	2.17	1.88	0.32	5.27	White	P125	27	125	1 15/16	3	

‡See pages D3.58 – D3.61 for tool and die information.

\*\*Consult cable manufacturer for voltage stress relief instructions with applications greater than 2000 V.

◆NEMA hole sizes and spacing.



## Code Conductor, Two-Hole, Standard Barrel with Window Lug, 45° Angle

For Use with Stranded Copper Conductors

### Type LCD-H

- Color-coded barrels marked with Panduit and specified competitor die index numbers for proper crimp die selection
- Inspection window to visually assure full conductor insertion
- Tin-plated to inhibit corrosion
- UL Listed and CSA Certified to 35 KV\*\* and temperature rated to 90°C when crimped with Panduit and specified competitor crimping tools and dies

- UL Listed and CSA Certified for wide wire range-taking capability when crimped with Panduit® Uni-Die™ Dieless Crimping Tools‡
- **Tested by Telcordia – meets NEBS Level 3**
- American Bureau of Shipping approved
- Available with NEMA hole sizes and spacing

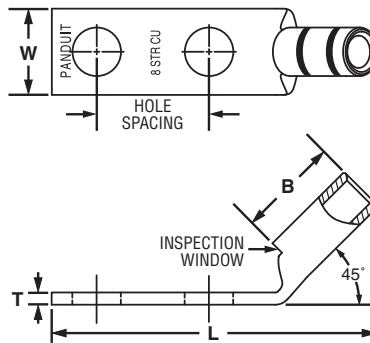

Part Number	Copper Conductor Size	Stud Hole Size (In.)	Stud Hole Spacing (In.)	Figure Dimensions (In.)				Panduit Color Code	Panduit Die Index No.‡	Burdny Die Index No.‡	T&B Die Index No.‡	Wire Strip Length (In.)	Std. Pkg. Qty.
				W	B	T	L						
LCD10-10AH-L*	#14 – #10	#10	0.63	0.38	0.38	0.06	1.59	—	—	—	—	7/16	50
LCD10-14AH-L*	#12 – #10	1/4	0.63	0.42	0.38	0.05	1.67	—	—	—	—	7/16	50
LCD10-38DH-L*	#12 – #10	3/8	1.00	0.56	0.38	0.04	2.28	—	—	—	—	7/16	50
LCD8-10AH-L	#8 AWG	#10	0.63	0.41	0.56	0.08	1.73	Red	P21	49	21	5/8	50
LCD8-14AH-L		1/4	0.63	0.48	0.56	0.07	1.81	Red	P21	49	21	5/8	50
LCD8-14BH-L		1/4	0.75	0.48	0.56	0.07	1.94	Red	P21	49	21	5/8	50
LCD8-14DH-L		1/4	1.00	0.48	0.56	0.07	2.19	Red	P21	49	21	5/8	50
LCD8-38DH-L		3/8	1.00	0.63	0.56	0.05	2.40	Red	P21	49	21	5/8	50
LCD6-10AH-L	#6 AWG	#10	0.63	0.46	0.81	0.08	1.92	Blue	P24	7	24	7/8	50
LCD6-10BH-L		#10	0.75	0.46	0.81	0.08	2.04	Blue	P24	7	24	7/8	50
LCD6-10DH-L		#10	1.00	0.46	0.81	0.08	2.29	Blue	P24	7	24	7/8	50
LCD6-14AH-L		1/4	0.63	0.48	0.81	0.08	2.00	Blue	P24	7	24	7/8	50
LCD6-14BH-L		1/4	0.75	0.48	0.81	0.08	2.13	Blue	P24	7	24	7/8	50
LCD6-14DH-L		1/4	1.00	0.48	0.81	0.08	2.38	Blue	P24	7	24	7/8	50
LCD6-56DH-L		5/16	1.00	0.56	0.81	0.07	2.49	Blue	P24	7	24	7/8	50
LCD6-38DH-L		3/8	1.00	0.62	0.81	0.06	2.59	Blue	P24	7	24	7/8	50
LCD4-10AH-L	#4 – #3 AWG STR, #2 AWG SOL	#10	0.63	0.55	0.81	0.09	1.94	Gray	P29	8	29	7/8	50
LCD4-10BH-L		#10	0.75	0.55	0.81	0.09	2.06	Gray	P29	8	29	7/8	50
LCD4-14AH-L		1/4	0.63	0.55	0.81	0.09	2.03	Gray	P29	8	29	7/8	50
LCD4-14BH-L		1/4	0.75	0.55	0.81	0.09	2.15	Gray	P29	8	29	7/8	50
LCD4-14DH-L		1/4	1.00	0.55	0.81	0.09	2.40	Gray	P29	8	29	7/8	50
LCD4-38DH-L		3/8	1.00	0.62	0.81	0.08	2.62	Gray	P29	8	29	7/8	50

‡See pages D3.58 – D3.61 for tool and die information.

\*Not tested to NEBS Level 3 requirements.

\*\*Consult cable manufacturer for voltage stress relief instructions with applications greater than 2000 V.

◆NEMA hole sizes and spacing.

Table continues on page D2.34

A. System Overview

B1. Cable Ties

B2. Cable Accessories

B3. Stainless Steel Ties

C1. Wiring Duct

C2. Surface Raceway

C3. Abrasion Protection

C4. Cable Management

D1. Terminals

D2. Power Connectors

D3. Grounding Connectors

E1. Labeling Systems

E2. Labels

E3. Pre-Printed & Write-On Markers

E4. Permanent Identification

E5. Lockout/Tagout & Safety Solutions

F. Index



## Code Conductor, Two-Hole, Standard Barrel with Window Lug, 45° Angle (continued)

Part Number	Copper Conductor Size	Stud Hole Size (In.)	Stud Hole Spacing (In.)	Figure Dimensions (In.)				Panduit Color Code	Panduit Die Index No.†	Burndy Die Index No.‡	T&B Die Index No.‡	Wire Strip Length (In.)	Std. Pkg. Qty.
				W	B	T	L						
LCD2-14AH-Q	#2 AWG	1/4	0.63	0.60	0.88	0.10	2.11	Brown	P33	10	33	15/16	25
LCD2-14BH-Q		1/4	0.75	0.60	0.88	0.10	2.24	Brown	P33	10	33	15/16	25
LCD2-14DH-Q		1/4	1.00	0.60	0.88	0.10	2.49	Brown	P33	10	33	15/16	25
LCD2-56BH-Q		5/16	0.75	0.66	0.88	0.10	2.36	Brown	P33	10	33	15/16	25
LCD2-38DH-Q		3/8	1.00	0.66	0.88	0.10	2.71	Brown	P33	10	33	15/16	25
LCD2-12H-Q		1/2	1.75	0.75	0.88	0.08	3.84	Brown	P33	10	33	15/16	25
LCD1-14AH-E	#1 AWG	1/4	0.63	0.70	0.88	0.11	2.12	Green	P37	11	37	15/16	20
LCD1-14BH-E		1/4	0.75	0.70	0.88	0.11	2.25	Green	P37	11	37	15/16	20
LCD1-56CH-E		5/16	0.88	0.70	0.88	0.11	2.50	Green	P37	11	37	15/16	20
LCD1-38DH-E		3/8	1.00	0.70	0.88	0.11	2.70	Green	P37	11	37	15/16	20
LCD1-12H-E	1/0 AWG	1/2	1.75	0.75	0.88	0.09	3.87	Green	P37	11	37	15/16	20
LCD1/0-14AH-X		1/4	0.63	0.76	0.94	0.12	2.26	Pink	P42	12	42	1	10
LCD1/0-14BH-X		1/4	0.75	0.76	0.94	0.12	2.38	Pink	P42	12	42	1	10
LCD1/0-56CH-X		5/16	0.88	0.76	0.94	0.12	2.56	Pink	P42	12	42	1	10
LCD1/0-38DH-X		3/8	1.00	0.76	0.94	0.12	2.76	Pink	P42	12	42	1	10
LCD1/0-12H-X		1/2	1.75	0.80	0.94	0.12	3.93	Pink	P42	12	42	1	10
LCD2/0-14AH-X	2/0 AWG	1/4	0.63	0.85	0.98	0.13	2.39	Black	P45	13	45	1 1/16	10
LCD2/0-14BH-X		1/4	0.75	0.85	0.98	0.13	2.52	Black	P45	13	45	1 1/16	10
LCD2/0-56CH-X		5/16	0.88	0.85	0.98	0.13	2.64	Black	P45	13	45	1 1/16	10
LCD2/0-38DH-X		3/8	1.00	0.85	0.98	0.13	2.83	Black	P45	13	45	1 1/16	10
LCD2/0-12H-X		1/2	1.75	0.85	0.98	0.13	3.99	Black	P45	13	45	1 1/16	10
LCD3/0-14BH-X	3/0 AWG	1/4	0.75	0.96	1.14	0.13	2.65	Orange	P50	14	50	1 3/16	10
LCD3/0-56DH-X		5/16	1.00	0.96	1.14	0.13	2.90	Orange	P50	14	50	1 3/16	10
LCD3/0-38DH-X		3/8	1.00	0.96	1.14	0.13	2.96	Orange	P50	14	50	1 3/16	10
LCD3/0-12H-X	4/0 AWG	1/2	1.75	0.96	1.14	0.13	4.12	Orange	P50	14	50	1 3/16	10
LCD4/0-14BH-X		1/4	0.75	1.06	1.19	0.14	2.72	Purple	P54	15	54	1 1/4	10
LCD4/0-38DH-X		3/8	1.00	1.06	1.19	0.14	3.05	Purple	P54	15	54	1 1/4	10
LCD4/0-12H-X		1/2	1.75	1.06	1.19	0.14	4.19	Purple	P54	15	54	1 1/4	10
LCD250-38DH-X	250 kcmil	3/8	1.00	1.17	1.25	0.14	3.13	Yellow	P62	16	62	1 5/16	10
LCD250-12H-X		1/2	1.75	1.17	1.25	0.14	4.27	Yellow	P62	16	62	1 5/16	10
LCD300-38DH-X	300 kcmil	3/8	1.00	1.17	1.44	0.14	3.36	White	P66	17	66	1 1/2	10
LCD300-12H-X		1/2	1.75	1.17	1.44	0.14	4.54	White	P66	17	66	1 1/2	10
LCD350-14BH-X	350 kcmil	1/4	0.75	1.28	1.44	0.17	2.92	Red	P71	18	71	1 1/2	10
LCD350-38DH-X		3/8	1.00	1.28	1.44	0.17	3.40	Red	P71	18	71	1 1/2	10
LCD350-12EH-X		1/2	1.25	1.28	1.44	0.17	3.95	Red	P71	18	71	1 1/2	10
LCD350-12H-X		1/2	1.75	1.28	1.44	0.17	4.58	Red	P71	18	71	1 1/2	10
LCD400-38DH-6	400 kcmil	3/8	1.00	1.39	1.50	0.18	3.50	Blue	P76	19	76	1 9/16	6
LCD400-12H-6		1/2	1.75	1.39	1.50	0.18	4.68	Blue	P76	19	76	1 9/16	6
LCD500-14BH-6	500 kcmil	1/4	0.75	1.54	1.75	0.22	3.27	Brown	P87	20	87	1 13/16	6
LCD500-38DH-6		3/8	1.00	1.54	1.75	0.22	3.75	Brown	P87	20	87	1 13/16	6
LCD500-12EH-6		1/2	1.25	1.54	1.75	0.22	4.30	Brown	P87	20	87	1 13/16	6
LCD500-12H-6		1/2	1.75	1.54	1.75	0.22	4.93	Brown	P87	20	87	1 13/16	6
LCD600-38DH-6	600 kcmil	3/8	1.00	1.70	1.75	0.26	3.81	Green	P94	22	94	1 13/16	6
LCD600-12H-6		1/2	1.75	1.70	1.75	0.26	4.99	Green	P94	22	94	1 13/16	6

†See pages D3.58 – D3.61 for tool and die information.

\*Not tested to NEBS Level 3 requirements.

\*\*Consult cable manufacturer for voltage stress relief instructions with applications greater than 2000 V.

◆NEMA hole sizes and spacing.





## Code Conductor, Two-Hole, Standard Barrel with Window Lug, 90° Angle

For Use with Stranded Copper Conductors

### Type LCD-F

- Color-coded barrels marked with Panduit and specified competitor die index numbers for proper crimp die selection
- Inspection window to visually assure full conductor insertion
- Tin-plated to inhibit corrosion
- UL Listed and CSA Certified to 35 KV\*\* and temperature rated to 90°C when crimped with Panduit and specified competitor crimping tools and dies

- UL Listed and CSA Certified for wide wire range-taking capability when crimped with Panduit® Uni-Die™ Dieless Crimping Tools‡
- **Tested by Telcordia – meets NEBS Level 3**
- American Bureau of Shipping approved
- Available with NEMA hole sizes and spacing



Part Number	Copper Conductor Size	Stud Hole Size (In.)	Stud Hole Spacing (In.)	Figure Dimensions (In.)				Panduit Color Code	Panduit Die Index No.‡	Burndy Die Index No.‡	T&B Die Index No.‡	Wire Strip Length (In.)	Std. Pkg. Qty.
				W	B	T	L						
LCD10-10AF-L*	#14 – #10	#10	0.63	0.38	0.38	0.06	1.47	—	—	—	—	7/16	50
LCD10-14AF-L*	AWG STR,	1/4	0.63	0.42	0.38	0.05	1.56	—	—	—	—	7/16	50
LCD10-38DF-L*	#12 – #10	3/8	1.00	0.56	0.38	0.04	2.16	—	—	—	—	7/16	50
LCD8-10AF-L	#8 AWG	#10	0.63	0.41	0.56	0.08	1.53	Red	P21	49	21	5/8	50
LCD8-14AF-L		1/4	0.63	0.48	0.56	0.07	1.62	Red	P21	49	21	5/8	50
LCD8-14BF-L		1/4	0.75	0.48	0.56	0.07	1.74	Red	P21	49	21	5/8	50
LCD8-14DF-L		1/4	1.00	0.48	0.56	0.07	1.99	Red	P21	49	21	5/8	50
LCD8-38DF-L		3/8	1.00	0.63	0.56	0.05	2.21	Red	P21	49	21	5/8	50
LCD6-10AF-L	#6 AWG	#10	0.63	0.46	0.81	0.08	1.57	Blue	P24	7	24	7/8	50
LCD6-10BF-L		#10	0.75	0.46	0.81	0.08	1.69	Blue	P24	7	24	7/8	50
LCD6-10DF-L		#10	1.00	0.46	0.81	0.08	1.94	Blue	P24	7	24	7/8	50
LCD6-14AF-L		1/4	0.63	0.48	0.81	0.08	1.66	Blue	P24	7	24	7/8	50
LCD6-14BF-L		1/4	0.75	0.48	0.81	0.08	1.78	Blue	P24	7	24	7/8	50
LCD6-14DF-L		1/4	1.00	0.48	0.81	0.08	2.03	Blue	P24	7	24	7/8	50
LCD6-56DF-L		5/16	1.00	0.56	0.81	0.07	2.15	Blue	P24	7	24	7/8	50
LCD6-38DF-L		3/8	1.00	0.62	0.81	0.06	2.25	Blue	P24	7	24	7/8	50
LCD4-10AF-L	#4 – #3	#10	0.63	0.55	0.81	0.09	1.65	Gray	P29	8	29	7/8	50
LCD4-10BF-L		#10	0.75	0.55	0.81	0.09	1.78	Gray	P29	8	29	7/8	50
LCD4-14AF-L		1/4	0.63	0.55	0.81	0.09	1.74	Gray	P29	8	29	7/8	50
LCD4-14BF-L		1/4	0.75	0.55	0.81	0.09	1.87	Gray	P29	8	29	7/8	50
LCD4-14DF-L		1/4	1.00	0.55	0.81	0.09	2.12	Gray	P29	8	29	7/8	50
LCD4-38DF-L		#2 AWG	3/8	1.00	0.62	0.81	0.08	2.34	Gray	P29	8	29	7/8

‡See pages D3.58 – D3.61 for tool and die information.

\*Not tested to NEBS Level 3 requirements.

\*\*Consult cable manufacturer for voltage stress relief instructions with applications greater than 2000 V.

Table continues on page D2.36

A. System Overview

B1. Cable Ties

B2. Cable Accessories

B3. Stainless Steel Ties

C1. Wiring Duct

C2. Surface Raceway

C3. Abrasion Protection

C4. Cable Management

D1. Terminals

D2. Power Connectors

D3. Grounding Connectors

E1. Labeling Systems

E2. Labels

E3. Pre-Printed & Write-On Markers

E4. Permanent Identification

E5. Lockout/Tagout & Safety Solutions

F. Index



## Code Conductor, Two-Hole, Standard Barrel with Window Lug, 90° Angle (continued)

Part Number	Copper Conductor Size	Stud Hole Size (In.)	Stud Hole Spacing (In.)	Figure Dimensions (In.)				Panduit Color Code	Panduit Die Index No.‡	Burndy Die Index No.‡	T&B Die Index No.‡	Wire Strip Length (In.)	Std. Pkg. Qty.	
				W	B	T	L							
<b>LCD2-14AF-Q</b>	#2 AWG	1/4	0.63	0.60	0.88	0.10	1.86	Brown	P33	10	33	15/16	25	
LCD2-14BF-Q		1/4	0.75	0.60	0.88	0.10	1.99	Brown	P33	10	33	15/16	25	
LCD2-14DF-Q		1/4	1.00	0.60	0.88	0.10	2.24	Brown	P33	10	33	15/16	25	
LCD2-56BF-Q		5/16	0.75	0.66	0.88	0.10	2.11	Brown	P33	10	33	15/16	25	
LCD2-38DF-Q		3/8	1.00	0.66	0.88	0.10	2.47	Brown	P33	10	33	15/16	25	
LCD2-12F-Q		1/2	1.75	0.75	0.88	0.08	3.61	Brown	P33	10	33	15/16	25	
LCD1-14AF-E		#1 AWG	1/4	0.63	0.70	0.88	0.11	1.94	Green	P37	11	37	15/16	20
LCD1-14BF-E	1/4		0.75	0.70	0.88	0.11	2.06	Green	P37	11	37	15/16	20	
LCD1-56CF-E	5/16		0.88	0.70	0.88	0.11	2.31	Green	P37	11	37	15/16	20	
<b>LCD1-38DF-E</b>	3/8		1.00	0.70	0.88	0.11	2.51	Green	P37	11	37	15/16	20	
LCD1-12F-E	1/2		1.75	0.75	0.88	0.09	3.68	Green	P37	11	37	15/16	20	
LCD1/0-14AF-X	1/0 AWG		1/4	0.63	0.76	0.94	0.12	2.08	Pink	P42	12	42	1	10
LCD1/0-14BF-X			1/4	0.75	0.76	0.94	0.12	2.20	Pink	P42	12	42	1	10
LCD1/0-56CF-X		5/16	0.88	0.76	0.94	0.12	2.38	Pink	P42	12	42	1	10	
LCD1/0-38DF-X		3/8	1.00	0.76	0.94	0.12	2.58	Pink	P42	12	42	1	10	
LCD1/0-12F-X		1/2	1.75	0.80	0.94	0.12	3.75	Pink	P42	12	42	1	10	
<b>LCD2/0-14AF-X</b>		2/0 AWG	1/4	0.63	0.85	0.98	0.13	2.22	Black	P45	13	45	1 1/16	10
LCD2/0-14BF-X			1/4	0.75	0.85	0.98	0.13	2.34	Black	P45	13	45	1 1/16	10
LCD2/0-56CF-X	5/16		0.88	0.85	0.98	0.13	2.47	Black	P45	13	45	1 1/16	10	
LCD2/0-38DF-X	3/8		1.00	0.85	0.98	0.13	2.66	Black	P45	13	45	1 1/16	10	
LCD2/0-12F-X	1/2		1.75	0.85	0.98	0.13	3.82	Black	P45	13	45	1 1/16	10	
LCD3/0-14BF-X	3/0 AWG		1/4	0.75	0.96	1.14	0.13	2.42	Orange	P50	14	50	1 3/16	10
LCD3/0-56DF-X			5/16	1.00	0.96	1.14	0.13	2.67	Orange	P50	14	50	1 3/16	10
LCD3/0-38DF-X		3/8	1.00	0.96	1.14	0.13	2.73	Orange	P50	14	50	1 3/16	10	
LCD3/0-12F-X		1/2	1.75	0.96	1.14	0.13	3.89	Orange	P50	14	50	1 3/16	10	
LCD4/0-14BF-X		4/0 AWG	1/4	0.75	1.06	1.19	0.14	2.50	Purple	P54	15	54	1 1/4	10
LCD4/0-38DF-X			3/8	1.00	1.06	1.19	0.14	2.84	Purple	P54	15	54	1 1/4	10
LCD4/0-12F-X			1/2	1.75	1.06	1.19	0.14	3.98	Purple	P54	15	54	1 1/4	10
LCD250-38DF-X	250 kcmil		3/8	1.00	1.17	1.25	0.14	2.90	Yellow	P62	16	62	1 5/16	10
LCD250-12F-X			1/2	1.75	1.17	1.25	0.14	4.04	Yellow	P62	16	62	1 5/16	10
LCD300-38DF-X	300 kcmil		3/8	1.00	1.19	1.44	0.16	2.88	White	P66	17	66	1 1/2	10
LCD300-12F-X			1/2	1.75	1.19	1.44	0.16	4.06	White	P66	17	66	1 1/2	10
LCD350-14BF-X	350 kcmil	1/4	0.75	1.28	1.44	0.17	2.46	Red	P71	18	71	1 1/2	10	
LCD350-38DF-X		3/8	1.00	1.28	1.44	0.17	2.94	Red	P71	18	71	1 1/2	10	
LCD350-12EF-X		1/2	1.25	1.28	1.44	0.17	3.49	Red	P71	18	71	1 1/2	10	
LCD350-12F-X		1/2	1.75	1.28	1.44	0.17	4.12	Red	P71	18	71	1 1/2	10	
LCD400-38DF-6		400 kcmil	3/8	1.00	1.39	1.50	0.18	3.02	Blue	P76	19	76	1 9/16	6
LCD400-12F-6			1/2	1.75	1.39	1.50	0.18	4.20	Blue	P76	19	76	1 9/16	6
LCD500-14BF-6		500 kcmil	1/4	0.75	1.54	1.75	0.22	2.65	Brown	P87	20	87	1 13/16	6
LCD500-38DF-6	3/8		1.00	1.54	1.75	0.22	3.13	Brown	P87	20	87	1 13/16	6	
LCD500-12EF-6	1/2		1.25	1.54	1.75	0.22	3.68	Brown	P87	20	87	1 13/16	6	
LCD500-12F-6	1/2		1.75	1.54	1.75	0.22	4.31	Brown	P87	20	87	1 13/16	6	
LCD600-38DF-6	600 kcmil		3/8	1.00	1.70	1.75	0.26	3.26	Green	P94	22	94	1 13/16	6
LCD600-12F-6			1/2	1.75	1.70	1.75	0.26	4.44	Green	P94	22	94	1 13/16	6

‡See pages D3.58 – D3.61 for tool and die information.

\*\*Consult cable manufacturer for voltage stress relief instructions with applications greater than 2000 V.

◆NEMA hole sizes and spacing.



## Code Conductor, Two-Hole, Standard Barrel with Window, Narrow Tongue Lug

For Use with Stranded Copper Conductors

### Type LCDN

- Narrow tongue width for limited space applications
- Color-coded barrels marked with Panduit and specified competitor die index numbers for proper crimp die selection
- Inspection window to visually assure full conductor insertion
- Tin-plated to inhibit corrosion

- UL Listed and CSA Certified to 35 KV\*\* and temperature rated to 90°C when crimped with Panduit and specified competitor crimping tools and dies
- UL Listed and CSA Certified for wide wire range-taking capability when crimped with Panduit® Uni-Die™ Dieless Crimping Tools‡

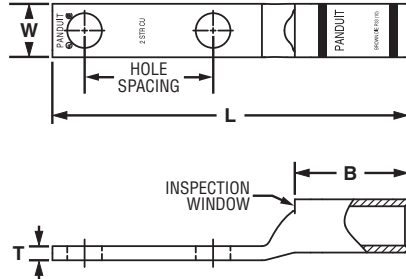

Part Number	Copper Conductor Size	Stud Hole Size (In.)	Stud Hole Spacing (In.)	Figure Dimensions (In.)				Panduit Color Code	Panduit Die Index No.‡	Burdny Die Index No.‡	T&B Die Index No.‡	Wire Strip Length (In.)	Std. Pkg. Qty.
				W	B	T	L						
LCDN2-10B-Q	#2 AWG	#10	0.75	0.42	0.88	0.11	2.43	Brown	P33	10	33	15/16	25
LCDN2-14A-Q		1/4	0.63	0.42	0.88	0.12	2.40	Brown	P33	10	33	15/16	25
LCDN2-14B-Q		1/4	0.75	0.42	0.88	0.11	2.52	Brown	P33	10	33	15/16	25
LCDN2-14D-Q		1/4	1.00	0.42	0.88	0.11	2.77	Brown	P33	10	33	15/16	25
LCDN1-14B-E	#1 AWG	1/4	0.75	0.47	0.88	0.11	2.54	Green	P37	11	37	15/16	20
LCDN1/0-14D-X	1/0 AWG	1/4	1.00	0.52	0.94	0.13	2.95	Pink	P42	12	42	1	10
LCDN1/0-56D-X		5/16	1.00	0.52	0.94	0.13	3.00	Pink	P42	12	42	1	10
LCDN2/0-14A-X	2/0 AWG	1/4	0.63	0.58	0.98	0.14	2.71	Black	P45	13	45	1 1/16	10
LCDN2/0-14D-X		1/4	1.00	0.58	0.98	0.13	3.09	Black	P45	13	45	1 1/16	10
LCDN2/0-56A-X		5/16	0.63	0.58	0.98	0.13	2.71	Black	P45	13	45	1 1/16	10
LCDN2/0-56D-X		5/16	1.00	0.58	0.98	0.13	3.09	Black	P45	13	45	1 1/16	10
LCDN350-38D-X	350 kcmil	3/8	1.00	0.88	1.44	0.17	3.79	Red	P71	18	71	1 1/2	10
LCDN500-38D-6	500 kcmil	3/8	1.00	1.06	1.75	0.22	4.20	Brown	P87	20	87	1 13/16	6
LCDN500-12D-6		1/2	1.00	1.06	1.75	0.22	4.63	Brown	P87	20	87	1 13/16	6
LCDN750-38D-6	750 kcmil	3/8	1.00	1.30	1.88	0.26	4.72	Black	P106	24	106	1 15/16	6

‡See pages D3.58 – D3.61 for tool and die information.

\*\*Consult cable manufacturer for voltage stress relief instructions with applications greater than 2000 V.

A. System Overview

B1. Cable Ties

B2. Cable Accessories

B3. Stainless Steel Ties

C1. Wiring Duct

C2. Surface Raceway

C3. Abrasion Protection

C4. Cable Management

D1. Terminals

D2. Power Connectors

D3. Grounding Connectors

E1. Labeling Systems

E2. Labels

E3. Pre-Printed & Write-On Markers

E4. Permanent Identification

E5. Lockout/Tagout & Safety Solutions

F. Index

A. System Overview



## Code Conductor, Two-Hole, Standard Barrel with Window, Narrow Tongue Lug, 45°

B1. Cable Ties

### For Use with Stranded Copper Conductors

#### Type LCDN-H

- Narrow tongue width for limited space applications
- Color-coded barrels marked with Panduit and specified competitor die index numbers for proper crimp die selection
- Inspection window to visually assure full conductor insertion
- Tin-plated to inhibit corrosion

- UL Listed and CSA Certified to 35 KV\*\* and temperature rated to 90°C when crimped with Panduit and specified competitor crimping tools and dies
- UL Listed and CSA Certified for wide wire range-taking capability when crimped with Panduit® Uni-Die™ Dieless Crimping Tools‡

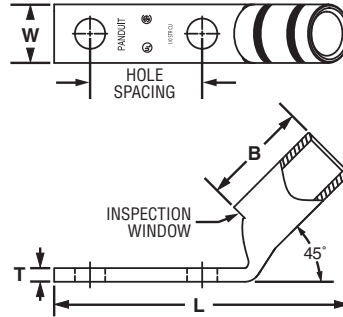

C1. Wiring Duct

C2. Surface Raceway

C3. Abrasion Protection

C4. Cable Management

Part Number	Copper Conductor Size	Stud Hole Size (In.)	Stud Hole Spacing (In.)	Figure Dimensions (In.)				Panduit Color Code	Panduit Die Index No.‡	Burdny Die Index No.‡	T&B Die Index No.‡	Wire Strip Length (In.)	Std. Pkg. Qty.
				W	B	T	L						
LCDN2-14AH-Q	#2 AWG	1/4	0.63	0.42	0.88	0.11	2.12	Brown	P33	10	33	15/16	25
LCDN2-14DH-Q	#2 AWG	1/4	1.00	0.42	0.88	0.11	2.49	Brown	P33	10	33	15/16	25
LCDN1/0-14DH-X	1/0 AWG	1/4	1.00	0.52	0.94	0.13	2.63	Pink	P42	12	42	1	10
LCDN1/0-56DH-X	1/0 AWG	5/16	1.00	0.52	0.94	0.13	2.70	Pink	P42	12	42	1	10

‡See pages D3.58 – D3.61 for tool and die information.

\*\*Consult cable manufacturer for voltage stress relief instructions with applications greater than 2000 V.

D1. Terminals

D2. Power Connectors

D3. Grounding Connectors

E1. Labeling Systems

E2. Labels

E3. Pre-Printed & Write-On Markers

E4. Permanent Identification

E5. Lockout/Tagout & Safety Solutions

F. Index



## Code Conductor, Two-Hole, Standard Barrel with Window, Narrow Tongue Lug, 90°

For Use with Stranded Copper Conductors

### Type LCDN-F

- Narrow tongue width for limited space applications
- Color-coded barrels marked with Panduit and specified competitor die index numbers for proper crimp die selection
- Inspection window to visually assure full conductor insertion
- Tin-plated to inhibit corrosion

- UL Listed and CSA Certified to 35 KV\*\* and temperature rated to 90°C when crimped with Panduit and specified competitor crimping tools and dies
- UL Listed and CSA Certified for wide wire range-taking capability when crimped with Panduit® Uni-Die™ Dieless Crimping Tools‡



Part Number	Copper Conductor Size	Stud Hole Size (In.)	Stud Hole Spacing (In.)	Figure Dimensions (In.)				Panduit Color Code	Panduit Die Index No.‡	Burndy Die Index No.‡	T&B Die Index No.‡	Wire Strip Length (In.)	Std. Pkg. Qty.
				W	B	T	L						
LCDN2-14AF-Q	#2 AWG	1/4	0.63	0.42	0.88	0.11	1.86	Brown	P33	10	33	15/16	25
LCDN2-14DF-Q	#2 AWG	1/4	1.00	0.42	0.88	0.11	2.24	Brown	P33	10	33	15/16	25
LCDN1/0-14DF-X	1/0 AWG	1/4	1.00	0.52	0.94	0.13	2.45	Pink	P42	12	42	1	10
LCDN1/0-56DF-X	1/0 AWG	5/16	1.00	0.52	0.94	0.13	2.51	Pink	P42	12	42	1	10

‡See pages D3.58 – D3.61 for tool and die information.

\*\*Consult cable manufacturer for voltage stress relief instructions with applications greater than 2000 V.

- A. System Overview
- B1. Cable Ties
- B2. Cable Accessories
- B3. Stainless Steel Ties
- C1. Wiring Duct
- C2. Surface Raceway
- C3. Abrasion Protection
- C4. Cable Management
- D1. Terminals
- D2. Power Connectors
- D3. Grounding Connectors
- E1. Labeling Systems
- E2. Labels
- E3. Pre-Printed & Write-On Markers
- E4. Permanent Identification
- E5. Lockout/Tagout & Safety Solutions
- F. Index

A. System Overview

## Code Conductor, Long Blank Tongue, Standard Barrel with Window Lug

B1. Cable Ties

### For Use with Stranded Copper Conductors

#### Type LCD-00

- Color-coded barrels marked with Panduit and specified competitor die index numbers for proper crimp die selection
- Tin-plated to inhibit corrosion
- Inspection window to visually assure full conductor insertion
- UL Recognized and CSA Certified to 35 KV\*\* and temperature rated to 90°C when crimped with Panduit and specified competitor crimping tools and dies

B2. Cable Accessories

B3. Stainless Steel Ties



C1. Wiring Duct

C2. Surface Raceway

C3. Abrasion Protection

C4. Cable Management

D1. Terminals

D2. Power Connectors

D3. Grounding Connectors

E1. Labeling Systems

E2. Labels

E3. Pre-Printed & Write-On Markers

E4. Permanent Identification

E5. Lockout/Tagout & Safety Solutions

F. Index

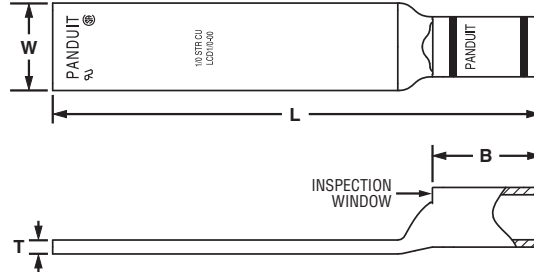

Part Number	Copper Conductor Size	Figure Dimensions (In.)				Panduit Color Code	Panduit Die Index No.‡	Burdny Die Index No.‡	T&B Die Index No.‡	Wire Strip Length (In.)	Std. Pkg. Qty.
		W	B	T	L						
LCD1/0-00-X	1/0 AWG	0.76	0.94	0.12	4.25	Pink	P42	12	42	1	10
LCD2/0-00-X	2/0 AWG	0.85	0.98	0.13	4.30	Black	P45	13	45	1 1/16	10
LCD3/0-00-X	3/0 AWG	0.96	1.14	0.13	4.50	Orange	P50	14	50	1 3/16	10
LCD4/0-00-X	4/0 AWG	1.06	1.19	0.14	4.58	Purple	P54	15	54	1 1/4	10
LCD250-00-X	250 kcmil	1.17	1.25	0.14	4.69	Yellow	P62	16	62	1 5/16	10
LCD300-00-X	300 kcmil	1.19	1.44	0.16	4.93	White	P66	17	66	1 1/2	10
LCD350-00-X	350 kcmil	1.28	1.44	0.17	4.97	Red	P71	18	71	1 1/2	10
LCD400-00-6	400 kcmil	1.39	1.50	0.18	5.05	Blue	P76	19	76	1 9/16	6
LCD500-00-6	500 kcmil	1.54	1.75	0.22	5.38	Brown	P87	20	87	1 13/16	6
LCD600-00-6	600 kcmil	1.70	1.75	0.26	5.43	Green	P94	22	94	1 13/16	6
LCD750-00-6	750 kcmil	1.89	1.88	0.26	5.65	Black	P106	24	106	1 15/16	6
LCD1000-00-3	1000 kcmil	2.17	1.88	0.32	5.77	White	P125	27	125	1 15/16	3

‡See pages D3.58 – D3.61 for tool and die information.

\*\*Consult cable manufacturer for voltage stress relief instructions with applications greater than 2000 V.



## Code Conductor, Two-Hole, Long Barrel Lug

For Use with Stranded Copper Conductors

### Type LCC

- Long barrel maximizes number of crimps and provides premium wire pull-out strength and electrical performance
- Color-coded barrels marked with Panduit and specified competitor die index numbers for proper crimp die selection
- Enclosed barrel prevents corrosive material from entering barrel when used in harsh environments
- Tin-plated to inhibit corrosion
- UL Listed and CSA Certified to 35 KV\*\* and temperature rated to 90°C when crimped with Panduit and specified competitor crimping tools and dies
- UL Listed and CSA Certified for wide wire range-taking capability when crimped with Panduit® Uni-Die™ Dieless Crimping Tools‡
- **Tested by Telcordia – meets NEBS Level 3**
- American Bureau of Shipping approved
- Available with NEMA hole sizes and spacing

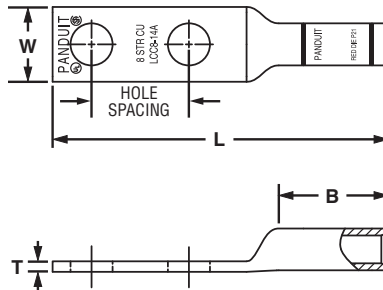

Part Number	Copper Conductor Size	Stud Hole Size (In.)	Stud Hole Spacing (In.)	Figure Dimensions (In.)				Panduit Color Code	Panduit Die Index No.‡	Burdny Die Index No.‡	T&B Die Index No.‡	Wire Strip Length (In.)	Std. Pkg. Qty.
				W	B	T	L						
LCC8-10A-L	#8 AWG	#10	0.63	0.41	0.70	0.08	2.07	Red	P21	49	21	3/4	50
LCC8-14A-L		1/4	0.63	0.48	0.70	0.07	2.16	Red	P21	49	21	3/4	50
LCC8-14B-L		1/4	0.75	0.48	0.70	0.07	2.28	Red	P21	49	21	3/4	50
LCC8-14D-L		1/4	1.00	0.48	0.70	0.07	2.53	Red	P21	49	21	3/4	50
LCC8-38D-L		3/8	1.00	0.60	0.70	0.05	2.75	Red	P21	49	21	3/4	50
LCC6-10A-L	#6 AWG	#10	0.63	0.46	1.07	0.08	2.47	Blue	P24	7	24	1 1/8	50
LCC6-14A-L		1/4	0.63	0.48	1.07	0.08	2.56	Blue	P24	7	24	1 1/8	50
LCC6-14B-L		1/4	0.75	0.48	1.07	0.08	2.68	Blue	P24	7	24	1 1/8	50
LCC6-14D-L		1/4	1.00	0.48	1.07	0.08	2.93	Blue	P24	7	24	1 1/8	50
LCC6-38D-L		3/8	1.00	0.62	1.07	0.06	3.15	Blue	P24	7	24	1 1/8	50
LCC6-12-L		1/2	1.75	0.75	1.07	0.07	4.04	Blue	P24	7	24	1 1/8	50
LCC4-14A-L	#4 – #3 AWG STR, #2 AWG SOL	1/4	0.63	0.55	1.05	0.09	2.58	Gray	P29	8	29	1 1/8	50
LCC4-14B-L		1/4	0.75	0.55	1.05	0.09	2.70	Gray	P29	8	29	1 1/8	50
LCC4-38D-L		3/8	1.00	0.62	1.05	0.08	3.17	Gray	P29	8	29	1 1/8	50
LCC4-12-L		1/2	1.75	0.75	1.05	0.07	4.09	Gray	P29	8	29	1 1/8	50
LCC2-14A-Q	#2 AWG	1/4	0.63	0.60	1.16	0.10	2.77	Brown	P33	10	33	1 1/4	25
LCC2-14B-Q		1/4	0.75	0.60	1.16	0.10	2.89	Brown	P33	10	33	1 1/4	25
LCC2-56B-Q		5/16	0.75	0.66	1.16	0.10	3.02	Brown	P33	10	33	1 1/4	25
LCC2-56C-Q		5/16	0.88	0.66	1.16	0.10	3.14	Brown	P33	10	33	1 1/4	25
LCC2-38D-Q		3/8	1.00	0.66	1.16	0.10	3.34	Brown	P33	10	33	1 1/4	25
LCC2-38-Q		3/8	1.75	0.66	1.16	0.10	4.09	Brown	P33	10	33	1 1/4	25
LCC2-12-Q		1/2	1.75	0.75	1.16	0.08	4.51	Brown	P33	10	33	1 1/4	25
LCC1-14A-E		#1 AWG	1/4	0.63	0.70	1.36	0.11	3.00	Green	P37	11	37	1 7/16
LCC1-14B-E	1/4		0.75	0.70	1.36	0.11	3.12	Green	P37	11	37	1 7/16	20
LCC1-56B-E	5/16		0.75	0.70	1.36	0.11	3.25	Green	P37	11	37	1 7/16	20
LCC1-56C-E	5/16		0.88	0.70	1.36	0.11	3.37	Green	P37	11	37	1 7/16	20
LCC1-38D-E	3/8		1.00	0.70	1.36	0.11	3.57	Green	P37	11	37	1 7/16	20
LCC1-12-E	1/2		1.75	0.75	1.36	0.09	4.74	Green	P37	11	37	1 7/16	20

‡See pages D3.62 – D3.65 for tool and die information.

\*\*Consult cable manufacturer for voltage stress relief instructions with applications greater than 2000 V.

◆NEMA hole sizes and spacing.

Table continues on page D2.42

A. System Overview

B1. Cable Ties

B2. Cable Accessories

B3. Stainless Steel Ties

C1. Wiring Duct

C2. Surface Raceway

C3. Abrasion Protection

C4. Cable Management

D1. Terminals

D2. Power Connectors

D3. Grounding Connectors

E1. Labeling Systems

E2. Labels

E3. Pre-Printed & Write-On Markers

E4. Permanent Identification

E5. Lockout/Tagout & Safety Solutions

F. Index



## Code Conductor, Two-Hole, Long Barrel Lug (continued)

A. System Overview
B1. Cable Ties
B2. Cable Accessories
B3. Stainless Steel Ties
C1. Wiring Duct
C2. Surface Raceway
C3. Abrasion Protection
C4. Cable Management
D1. Terminals
D2. Power Connectors
D3. Grounding Connectors
E1. Labeling Systems
E2. Labels
E3. Pre-Printed & Write-On Markers
E4. Permanent Identification
E5. Lockout/Tagout & Safety Solutions
F. Index

Part Number	Copper Conductor Size	Stud Hole Size (In.)	Stud Hole Spacing (In.)	Figure Dimensions (In.)				Panduit Color Code	Panduit Die Index No.‡	Burndy Die Index No.‡	T&B Die Index No.‡	Wire Strip Length (In.)	Std. Pkg. Qty.	
				W	B	T	L							
LCC1/0-14A-X	1/0 AWG	1/4	0.63	0.76	1.44	0.12	3.18	Pink	P42	12	42	1 1/2	10	
LCC1/0-14B-X		1/4	0.75	0.76	1.44	0.12	3.31	Pink	P42	12	42	1 1/2	10	
LCC1/0-56C-X		5/16	0.88	0.76	1.44	0.12	3.49	Pink	P42	12	42	1 1/2	10	
LCC1/0-56D-X		5/16	1.00	0.76	1.44	0.12	3.61	Pink	P42	12	42	1 1/2	10	
<b>LCC1/0-38D-X</b>		3/8	1.00	0.76	1.44	0.12	3.69	Pink	P42	12	42	1 1/2	10	
LCC1/0-12D-X		1/2	1.00	0.80	1.44	0.12	3.95	Pink	P42	12	42	1 1/2	10	
LCC1/0-12-X		1/2	1.75	0.80	1.44	0.12	4.86	Pink	P42	12	42	1 1/2	10	
LCC2/0-14A-X		2/0 AWG	1/4	0.63	0.85	1.50	0.13	3.38	Black	P45	13	45	1 9/16	10
LCC2/0-14B-X			1/4	0.75	0.85	1.50	0.13	3.51	Black	P45	13	45	1 9/16	10
LCC2/0-56D-X			5/16	1.00	0.85	1.50	0.13	3.76	Black	P45	13	45	1 9/16	10
LCC2/0-38D-X	3/8		1.00	0.85	1.50	0.13	3.82	Black	P45	13	45	1 9/16	10	
LCC2/0-12D-X	1/2		1.00	0.85	1.50	0.13	4.07	Black	P45	13	45	1 9/16	10	
LCC2/0-12-X	1/2		1.75	0.85	1.50	0.13	4.98	Black	P45	13	45	1 9/16	10	
LCC3/0-14B-X	3/0 AWG		1/4	0.75	0.96	1.50	0.13	3.56	Orange	P50	14	50	1 9/16	10
LCC3/0-38D-X			3/8	1.00	0.96	1.50	0.13	3.87	Orange	P50	14	50	1 9/16	10
LCC3/0-12D-X			1/2	1.00	0.96	1.50	0.13	4.12	Orange	P50	14	50	1 9/16	10
LCC3/0-12-X			1/2	1.75	0.96	1.50	0.13	5.03	Orange	P50	14	50	1 9/16	10
LCC4/0-14B-X		4/0 AWG	1/4	0.75	1.06	1.56	0.14	3.66	Purple	P54	15	54	1 5/8	10
LCC4/0-56D-X	5/16		1.00	1.06	1.56	0.14	3.92	Purple	P54	15	54	1 5/8	10	
LCC4/0-38D-X	3/8		1.00	1.06	1.56	0.14	3.99	Purple	P54	15	54	1 5/8	10	
LCC4/0-38-X	3/8		1.75	1.06	1.56	0.14	4.74	Purple	P54	15	54	1 5/8	10	
LCC4/0-12D-X	1/2		1.00	1.06	1.56	0.14	4.22	Purple	P54	15	54	1 5/8	10	
<b>LCC4/0-12-X</b>	1/2		1.75	1.06	1.56	0.14	5.13	Purple	P54	15	54	1 5/8	10	
LCC250-38D-X	250 kcmil		3/8	1.00	1.17	1.60	0.14	4.09	Yellow	P62	16	62	1 11/16	10
LCC250-12D-X			1/2	1.00	1.17	1.60	0.14	4.32	Yellow	P62	16	62	1 11/16	10
<b>LCC250-12-X</b>			1/2	1.75	1.17	1.60	0.14	5.23	Yellow	P62	16	62	1 11/16	10
LCC300-38D-X	300 kcmil		3/8	1.00	1.19	2.24	0.16	4.76	White	P66	17	66	2 5/16	10
LCC300-12-X		1/2	1.75	1.19	2.24	0.16	5.94	White	P66	17	66	2 5/16	10	
LCC350-14B-X	350 kcmil	1/4	0.75	1.28	2.24	0.17	4.33	Red	P71	18	71	2 5/16	10	
LCC350-38D-X		3/8	1.00	1.28	2.24	0.17	4.81	Red	P71	18	71	2 5/16	10	
<b>LCC350-12-X</b>		1/2	1.75	1.28	2.24	0.17	5.99	Red	P71	18	71	2 5/16	10	
LCC400-14B-6		400 kcmil	1/4	0.75	1.39	2.30	0.18	4.44	Blue	P76	19	76	2 3/8	6
LCC400-38D-6	3/8		1.00	1.39	2.30	0.18	4.92	Blue	P76	19	76	2 3/8	6	
<b>LCC400-12-6</b>	1/2		1.75	1.39	2.30	0.18	6.10	Blue	P76	19	76	2 3/8	6	
LCC500-14B-6	500 kcmil	1/4	0.75	1.54	2.50	0.22	4.70	Brown	P87	20	87	2 9/16	6	
LCC500-38D-6		3/8	1.00	1.54	2.50	0.22	5.18	Brown	P87	20	87	2 9/16	6	
<b>LCC500-12-6</b>		1/2	1.75	1.54	2.50	0.22	6.36	Brown	P87	20	87	2 9/16	6	
LCC600-38D-6	600 kcmil	3/8	1.00	1.70	2.69	0.26	5.45	Green	P94	22	94	2 3/4	6	
<b>LCC600-12-6</b>		1/2	1.75	1.70	2.69	0.26	6.63	Green	P94	22	94	2 3/4	6	
LCC750-38D-6	750 kcmil	3/8	1.00	1.89	2.87	0.26	6.10	Black	P106	24	106	2 15/16	6	
<b>LCC750-12-6</b>		1/2	1.75	1.89	2.87	0.26	7.04	Black	P106	24	106	2 15/16	6	
<b>LCC800-12-6</b>	800 kcmil	1/2	1.75	1.95	2.94	0.29	7.13	Orange	P107	25	—	3	6	
LCC1000-38D-3	1000 kcmil	3/8	1.00	2.17	3.00	0.32	6.35	White	P125	27	125	3 1/16	3	
<b>LCC1000-12-3</b>		1/2	1.75	2.17	3.00	0.32	7.29	White	P125	27	125	3 1/16	3	

‡See pages D3.62 – D3.65 for tool and die information.

\*\*Consult cable manufacturer for voltage stress relief instructions with applications greater than 2000 V.

◆NEMA hole sizes and spacing.





## Code Conductor, Two-Hole, Long Barrel Lug, 45° Angle

For Use with Stranded Copper Conductors

### Type LCC-H

- Long barrel maximizes number of crimps and provides premium wire pull-out strength and electrical performance
- Color-coded barrels marked with Panduit and specified competitor die index numbers for proper crimp die selection
- Enclosed barrel prevents corrosive material from entering barrel when used in harsh environments
- Tin-plated to inhibit corrosion

- UL Listed and CSA Certified to 35 KV\*\* and temperature rated to 90°C when crimped with Panduit and specified competitor crimping tools and dies
- UL Listed and CSA Certified for wide wire range-taking capability when crimped with Panduit® Uni-Die™ Dieless Crimping Tools‡
- **Tested by Telcordia – meets NEBS Level 3**
- American Bureau of Shipping approved
- Available with NEMA hole sizes and spacing



Part Number	Copper Conductor Size	Stud Hole Size (In.)	Stud Hole Spacing (In.)	Figure Dimensions (In.)				Panduit Color Code	Panduit Die Index No.‡	Burndy Die Index No.‡	T&B Die Index No.‡	Wire Strip Length (In.)	Std. Pkg. Qty.
				W	B	T	L						
LCC8-10AH-L	#8 AWG	#10	0.63	0.41	0.70	0.08	1.86	Red	P21	49	21	3/4	50
LCC8-14AH-L		1/4	0.63	0.48	0.70	0.07	1.94	Red	P21	49	21	3/4	50
LCC8-14BH-L		1/4	0.75	0.48	0.70	0.07	2.06	Red	P21	49	21	3/4	50
LCC8-14DH-L		1/4	1.00	0.48	0.70	0.07	2.31	Red	P21	49	21	3/4	50
LCC8-38DH-L		3/8	1.00	0.60	0.70	0.05	2.52	Red	P21	49	21	3/4	50
LCC6-10AH-L	#6 AWG	#10	0.63	0.46	1.07	0.08	2.14	Blue	P24	7	24	1 1/8	50
LCC6-14AH-L		1/4	0.63	0.48	1.07	0.08	2.23	Blue	P24	7	24	1 1/8	50
LCC6-14BH-L		1/4	0.75	0.48	1.07	0.08	2.35	Blue	P24	7	24	1 1/8	50
LCC6-14DH-L		1/4	1.00	0.48	1.07	0.08	2.60	Blue	P24	7	24	1 1/8	50
LCC6-38DH-L		3/8	1.00	0.62	1.07	0.06	2.81	Blue	P24	7	24	1 1/8	50
LCC4-14AH-L	#4 – #3 AWG STR, #2 AWG SOL	1/4	0.63	0.55	1.05	0.09	2.26	Gray	P29	8	29	1 1/8	50
LCC4-14BH-L		1/4	0.75	0.55	1.05	0.09	2.38	Gray	P29	8	29	1 1/8	50
LCC4-38DH-L		3/8	1.00	0.62	1.05	0.08	2.84	Gray	P29	8	29	1 1/8	50
LCC2-14AH-Q	#2 AWG	1/4	0.63	0.60	1.16	0.10	2.38	Brown	P33	10	33	1 1/4	25
LCC2-14BH-Q		1/4	0.75	0.60	1.16	0.10	2.50	Brown	P33	10	33	1 1/4	25
LCC2-56BH-Q		5/16	0.75	0.66	1.16	0.10	2.62	Brown	P33	10	33	1 1/4	25
LCC2-56CH-Q		5/16	0.88	0.66	1.16	0.10	2.75	Brown	P33	10	33	1 1/4	25
LCC2-38DH-Q		3/8	1.00	0.66	1.16	0.10	2.95	Brown	P33	10	33	1 1/4	25
LCC2-38H-Q		3/8	1.75	0.66	1.16	0.10	3.70	Brown	P33	10	33	1 1/4	25
LCC2-12H-Q		1/2	1.75	0.75	1.16	0.08	4.10	Brown	P33	10	33	1 1/4	25

‡See pages D3.62 – D3.65 for tool and die information.

\*\*Consult cable manufacturer for voltage stress relief instructions with applications greater than 2000 V.

◆NEMA hole sizes and spacing.

Table continues on page D2.44

A. System Overview

B1. Cable Ties

B2. Cable Accessories

B3. Stainless Steel Ties

C1. Wiring Duct

C2. Surface Raceway

C3. Abrasion Protection

C4. Cable Management

D1. Terminals

D2. Power Connectors

D3. Grounding Connectors

E1. Labeling Systems

E2. Labels

E3. Pre-Printed & Write-On Markers

E4. Permanent Identification

E5. Lockout/Tagout & Safety Solutions

F. Index

# PANDUIT® ELECTRICAL SOLUTIONS



## Code Conductor, Two-Hole, Long Barrel Lug, 45° Angle (continued)

A.	System Overview
B1.	Cable Ties
B2.	Cable Accessories
B3.	Stainless Steel Ties
C1.	Wiring Duct
C2.	Surface Raceway
C3.	Abrasion Protection
C4.	Cable Management
D1.	Terminals
D2.	Power Connectors
D3.	Grounding Connectors
E1.	Labeling Systems
E2.	Labels
E3.	Pre-Printed & Write-On Markers
E4.	Permanent Identification
E5.	Lockout/Tagout & Safety Solutions
F.	Index

Part Number	Copper Conductor Size	Stud Hole Size (In.)	Stud Hole Spacing (In.)	Figure Dimensions (In.)				Panduit Color Code	Panduit Die Index No.‡	Burndy Die Index No.‡	T&B Die Index No.‡	Wire Strip Length (In.)	Std. Pkg. Qty.
				W	B	T	L						
LCC1-14AH-E	#1 AWG	1/4	0.63	0.70	1.36	0.11	2.53	Green	P37	11	37	1 7/16	20
LCC1-14BH-E		1/4	0.75	0.70	1.36	0.11	2.66	Green	P37	11	37	1 7/16	20
LCC1-56BH-E		5/16	0.75	0.70	1.36	0.11	2.78	Green	P37	11	37	1 7/16	20
LCC1-56CH-E		5/16	0.88	0.70	1.36	0.11	2.91	Green	P37	11	37	1 7/16	20
LCC1-38DH-E		3/8	1.00	0.70	1.36	0.11	3.11	Green	P37	11	37	1 7/16	20
LCC1-12H-E		1/2	1.75	0.75	1.36	0.09	4.27	Green	P37	11	37	1 7/16	20
LCC1/0-14AH-X		1/0 AWG	1/4	0.63	0.76	1.44	0.12	2.69	Pink	P42	12	42	1 1/2
LCC1/0-14BH-X	1/4		0.75	0.76	1.44	0.12	2.81	Pink	P42	12	42	1 1/2	10
LCC1/0-56CH-X	5/16		0.88	0.76	1.44	0.12	2.99	Pink	P42	12	42	1 1/2	10
LCC1/0-56DH-X	5/16		1.00	0.76	1.44	0.12	3.12	Pink	P42	12	42	1 1/2	10
LCC1/0-38DH-X	3/8		1.00	0.76	1.44	0.12	3.19	Pink	P42	12	42	1 1/2	10
LCC1/0-12DH-X	1/2		1.00	0.80	1.44	0.12	3.46	Pink	P42	12	42	1 1/2	10
LCC1/0-12H-X	1/2		1.75	0.80	1.44	0.12	4.36	Pink	P42	12	42	1 1/2	10
LCC2/0-14AH-X	2/0 AWG	1/4	0.63	0.85	1.50	0.13	2.87	Black	P45	13	45	1 9/16	10
LCC2/0-14BH-X		1/4	0.75	0.85	1.50	0.13	2.99	Black	P45	13	45	1 9/16	10
LCC2/0-56DH-X		5/16	1.00	0.85	1.50	0.13	3.24	Black	P45	13	45	1 9/16	10
LCC2/0-38DH-X		3/8	1.00	0.85	1.50	0.13	3.31	Black	P45	13	45	1 9/16	10
LCC2/0-12DH-X		1/2	1.00	0.85	1.50	0.13	3.56	Black	P45	13	45	1 9/16	10
LCC2/0-12H-X		1/2	1.75	0.85	1.50	0.13	4.47	Black	P45	13	45	1 9/16	10
LCC3/0-14BH-X		3/0 AWG	1/4	0.75	0.96	1.50	0.13	3.02	Orange	P50	14	50	1 9/16
LCC3/0-38DH-X	3/8		1.00	0.96	1.50	0.13	3.33	Orange	P50	14	50	1 9/16	10
LCC3/0-12DH-X	1/2		1.00	0.96	1.50	0.13	3.58	Orange	P50	14	50	1 9/16	10
LCC3/0-12H-X	1/2		1.75	0.96	1.50	0.13	4.50	Orange	P50	14	50	1 9/16	10
LCC4/0-14BH-X	4/0 AWG	1/4	0.75	1.06	1.56	0.14	3.11	Purple	P54	15	54	1 5/8	10
LCC4/0-56DH-X		5/16	1.00	1.06	1.56	0.14	3.37	Purple	P54	15	54	1 5/8	10
LCC4/0-38DH-X		3/8	1.00	1.06	1.56	0.14	3.44	Purple	P54	15	54	1 5/8	10
LCC4/0-38H-X		3/8	1.75	1.06	1.56	0.14	4.19	Purple	P54	15	54	1 5/8	10
LCC4/0-12DH-X		1/2	1.00	1.06	1.56	0.14	3.67	Purple	P54	15	54	1 5/8	10
LCC4/0-12H-X		1/2	1.75	1.06	1.56	0.14	4.58	Purple	P54	15	54	1 5/8	10
LCC250-38DH-X		250 kcmil	3/8	1.00	1.17	1.61	0.14	3.51	Yellow	P62	16	62	1 11/16
LCC250-12DH-X	1/2		1.00	1.17	1.61	0.14	3.74	Yellow	P62	16	62	1 11/16	10
LCC250-12H-X	1/2		1.75	1.17	1.61	0.14	4.65	Yellow	P62	16	62	1 11/16	10
LCC300-38DH-X	300 kcmil	3/8	1.00	1.19	2.24	0.16	4.05	White	P66	17	66	2 5/16	10
LCC300-12H-X		1/2	1.75	1.19	2.24	0.16	5.23	White	P66	17	66	2 5/16	10
LCC350-14BH-X	350 kcmil	1/4	0.75	1.28	2.24	0.17	3.61	Red	P71	18	71	2 5/16	10
LCC350-38DH-X		3/8	1.00	1.28	2.24	0.17	4.09	Red	P71	18	71	2 5/16	10
LCC350-12H-X		1/2	1.75	1.28	2.24	0.17	5.27	Red	P71	18	71	2 5/16	10
LCC400-14BH-6	400 kcmil	1/4	0.75	1.39	2.30	0.18	3.70	Blue	P76	19	76	2 3/8	6
LCC400-38DH-6		3/8	1.00	1.39	2.30	0.18	4.18	Blue	P76	19	76	2 3/8	6
LCC400-12H-6		1/2	1.75	1.39	2.30	0.18	5.36	Blue	P76	19	76	2 3/8	6
LCC500-14BH-6	500 kcmil	1/4	0.75	1.54	2.50	0.22	3.91	Brown	P87	20	87	2 9/16	6
LCC500-38DH-6		3/8	1.00	1.54	2.50	0.22	4.39	Brown	P87	20	87	2 9/16	6
LCC500-12H-6		1/2	1.75	1.54	2.50	0.22	5.57	Brown	P87	20	87	2 9/16	6
LCC600-38DH-6	600 kcmil	3/8	1.00	1.70	2.69	0.26	4.61	Green	P94	22	94	2 3/4	6
LCC600-12H-6		1/2	1.75	1.70	2.69	0.26	5.79	Green	P94	22	94	2 3/4	6

‡See pages D3.62 – D3.65 for tool and die information.

\*\*Consult cable manufacturer for voltage stress relief instructions with applications greater than 2000 V.

◆NEMA hole sizes and spacing.



## Code Conductor, Two-Hole, Long Barrel Lug, 90° Angle

For Use with Stranded Copper Conductors

### Type LCC-F

- Long barrel maximizes number of crimps and provides premium wire pull-out strength and electrical performance
- Color-coded barrels marked with Panduit and specified competitor die index numbers for proper crimp die selection
- Enclosed barrel prevents corrosive material from entering barrel when used in harsh environments
- Tin-plated to inhibit corrosion

- UL Listed and CSA Certified to 35 KV\*\* and temperature rated to 90°C when crimped with Panduit and specified competitor crimping tools and dies
- UL Listed and CSA Certified for wide wire range-taking capability when crimped with Panduit® Uni-Die™ Dieless Crimping Tools‡
- **Tested by Telcordia – meets NEBS Level 3**
- American Bureau of Shipping approved
- Available with NEMA hole sizes and spacing



Part Number	Copper Conductor Size	Stud Hole Size (In.)	Stud Hole Spacing (In.)	Figure Dimensions (In.)				Panduit Color Code	Panduit Die Index No.‡	Burdly Die Index No.‡	T&B Die Index No.‡	Wire Strip Length (In.)	Std. Pkg. Qty.
				W	B	T	L						
LCC8-10AF-L	#8 AWG	#10	0.63	0.41	0.70	0.08	1.53	Red	P21	49	21	3/4	50
LCC8-14AF-L		1/4	0.63	0.48	0.70	0.07	1.62	Red	P21	49	21	3/4	50
LCC8-14BF-L		1/4	0.75	0.48	0.70	0.07	1.74	Red	P21	49	21	3/4	50
LCC8-14DF-L		1/4	1.00	0.48	0.70	0.07	1.99	Red	P21	49	21	3/4	50
LCC8-38DF-L		3/8	1.00	0.60	0.70	0.05	2.21	Red	P21	49	21	3/4	50
LCC6-10AF-L	#6 AWG	#10	0.63	0.46	1.07	0.08	1.57	Blue	P24	7	24	1 1/8	50
LCC6-14AF-L		1/4	0.63	0.48	1.07	0.08	1.66	Blue	P24	7	24	1 1/8	50
LCC6-14BF-L		1/4	0.75	0.48	1.07	0.08	1.78	Blue	P24	7	24	1 1/8	50
LCC6-14DF-L		1/4	1.00	0.48	1.07	0.08	2.03	Blue	P24	7	24	1 1/8	50
LCC6-38DF-L		3/8	1.00	0.62	1.07	0.05	2.25	Blue	P24	7	24	1 1/8	50
LCC4-14AF-L	#4 – #3 AWG STR, #2 AWG SOL	1/4	0.63	0.55	1.05	0.09	1.74	Gray	P29	8	29	1 1/8	50
LCC4-14BF-L		1/4	0.75	0.55	1.05	0.09	1.87	Gray	P29	8	29	1 1/8	50
LCC4-38DF-L		3/8	1.00	0.62	1.05	0.08	2.34	Gray	P29	8	29	1 1/8	50
LCC2-14AF-Q	#2 AWG	1/4	0.63	0.60	1.16	0.10	1.86	Brown	P33	10	33	1 1/4	25
LCC2-14BF-Q		1/4	0.75	0.60	1.16	0.10	1.99	Brown	P33	10	33	1 1/4	25
LCC2-56BF-Q		5/16	0.75	0.66	1.16	0.10	2.11	Brown	P33	10	33	1 1/4	25
LCC2-56CF-Q		5/16	0.88	0.66	1.16	0.10	2.24	Brown	P33	10	33	1 1/4	25
LCC2-38DF-Q		3/8	1.00	0.66	1.16	0.10	2.44	Brown	P33	10	33	1 1/4	25
LCC2-38F-Q		3/8	1.75	0.66	1.16	0.10	3.19	Brown	P33	10	33	1 1/4	25
LCC2-12F-Q		1/2	1.75	0.75	1.16	0.08	3.61	Brown	P33	10	33	1 1/4	25

‡See pages D3.62 – D3.65 for tool and die information.

\*\*Consult cable manufacturer for voltage stress relief instructions with applications greater than 2000 V.

◆NEMA hole sizes and spacing.

Table continues on page D2.46



## Code Conductor, Two-Hole, Long Barrel Lug, 90° Angle (continued)

- A. System Overview
- B1. Cable Ties
- B2. Cable Accessories
- B3. Stainless Steel Ties
- C1. Wiring Duct
- C2. Surface Raceway
- C3. Abrasion Protection
- C4. Cable Management
- D1. Terminals
- D2. Power Connectors
- D3. Grounding Connectors
- E1. Labeling Systems
- E2. Labels
- E3. Pre-Printed & Write-On Markers
- E4. Permanent Identification
- E5. Lockout/Tagout & Safety Solutions
- F. Index

Part Number	Copper Conductor Size	Stud Hole Size (In.)	Stud Hole Spacing (In.)	Figure Dimensions (In.)				Panduit Color Code	Panduit Die Index No.‡	Burndy Die Index No.‡	T&B Die Index No.‡	Wire Strip Length (In.)	Std. Pkg. Qty.
				W	B	T	L						
LCC1-14AF-E	#1 AWG	1/4	0.63	0.70	1.36	0.11	1.94	Green	P37	11	37	1 7/16	20
LCC1-14BF-E		1/4	0.75	0.70	1.36	0.11	2.06	Green	P37	11	37	1 7/16	20
LCC1-56BF-E		5/16	0.75	0.70	1.36	0.11	2.19	Green	P37	11	37	1 7/16	20
LCC1-56CF-E		5/16	0.88	0.70	1.36	0.11	2.31	Green	P37	11	37	1 7/16	20
LCC1-38DF-E		3/8	1.00	0.70	1.36	0.11	2.51	Green	P37	11	37	1 7/16	20
LCC1-12F-E		1/2	1.75	0.75	1.36	0.09	3.68	Green	P37	11	37	1 7/16	20
LCC1/0-14AF-X		1/4	0.63	0.76	1.44	0.12	2.08	Pink	P42	12	42	1 1/2	10
LCC1/0-14BF-X		1/4	0.75	0.76	1.44	0.12	2.20	Pink	P42	12	42	1 1/2	10
LCC1/0-56CF-X		5/16	0.88	0.76	1.44	0.12	2.38	Pink	P42	12	42	1 1/2	10
LCC1/0-56DF-X		5/16	1.00	0.76	1.44	0.12	2.51	Pink	P42	12	42	1 1/2	10
LCC1/0-38DF-X	1/0 AWG	3/8	1.00	0.76	1.44	0.12	2.58	Pink	P42	12	42	1 1/2	10
LCC1/0-12DF-X		1/2	1.00	0.80	1.44	0.12	2.85	Pink	P42	12	42	1 1/2	10
LCC1/0-12F-X		1/2	1.75	0.80	1.44	0.12	3.75	Pink	P42	12	42	1 1/2	10
LCC2/0-14AF-X		1/4	0.63	0.85	1.50	0.13	2.22	Black	P45	13	45	1 9/16	10
LCC2/0-14BF-X	2/0 AWG	1/4	0.75	0.85	1.50	0.13	2.34	Black	P45	13	45	1 9/16	10
LCC2/0-56DF-X		5/16	1.00	0.85	1.50	0.13	2.59	Black	P45	13	45	1 9/16	10
LCC2/0-38DF-X		3/8	1.00	0.85	1.50	0.13	2.66	Black	P45	13	45	1 9/16	10
LCC2/0-12DF-X		1/2	1.00	0.85	1.50	0.13	2.85	Black	P45	13	45	1 9/16	10
LCC2/0-12F-X		1/2	1.75	0.85	1.50	0.13	3.82	Black	P45	13	45	1 9/16	10
LCC3/0-14BF-X		3/0 AWG	1/4	0.75	0.96	1.50	0.13	2.42	Orange	P50	14	50	1 9/16
LCC3/0-38DF-X	3/8		1.00	0.96	1.50	0.13	2.73	Orange	P50	14	50	1 9/16	10
LCC3/0-12DF-X	1/2		1.00	0.96	1.50	0.13	2.98	Orange	P50	14	50	1 9/16	10
LCC3/0-12F-X	1/2		1.75	0.96	1.50	0.13	3.89	Orange	P50	14	50	1 9/16	10
LCC4/0-14BF-X	4/0 AWG	1/4	0.75	1.06	1.56	0.14	2.50	Purple	P54	15	54	1 5/8	10
LCC4/0-56DF-X		5/16	1.00	1.06	1.56	0.14	2.77	Purple	P54	15	54	1 5/8	10
LCC4/0-38DF-X		3/8	1.00	1.06	1.56	0.14	2.84	Purple	P54	15	54	1 5/8	10
LCC4/0-38F-X		3/8	1.75	1.06	1.56	0.14	3.59	Purple	P54	15	54	1 5/8	10
LCC4/0-12DF-X		1/2	1.00	1.06	1.56	0.14	3.07	Purple	P54	15	54	1 5/8	10
LCC4/0-12F-X		1/2	1.75	1.06	1.56	0.14	3.98	Purple	P54	15	54	1 5/8	10
LCC250-38DF-X	250 kcmil	3/8	1.00	1.17	1.61	0.14	2.90	Yellow	P62	16	62	1 11/16	10
LCC250-12DF-X		1/2	1.00	1.17	1.61	0.14	3.13	Yellow	P62	16	62	1 11/16	10
LCC250-12F-X	300 kcmil	1/2	1.75	1.17	1.61	0.14	4.04	Yellow	P62	16	62	1 11/16	10
LCC300-38DF-X		3/8	1.00	1.19	2.24	0.16	2.88	White	P66	17	66	2 5/16	10
LCC300-12F-X	350 kcmil	1/2	1.75	1.19	2.24	0.16	4.06	White	P66	17	66	2 5/16	10
LCC350-14BF-X		1/4	0.75	1.28	2.24	0.17	2.46	Red	P71	18	71	2 5/16	10
LCC350-38DF-X	400 kcmil	3/8	1.00	1.28	2.24	0.17	2.94	Red	P71	18	71	2 5/16	10
LCC350-12F-X		1/2	1.75	1.28	2.24	0.17	4.12	Red	P71	18	71	2 5/16	10
LCC400-14BF-6	500 kcmil	1/4	0.75	1.39	2.30	0.18	2.54	Blue	P76	19	76	2 3/8	6
LCC400-38DF-6		3/8	1.00	1.39	2.30	0.18	3.02	Blue	P76	19	76	2 3/8	6
LCC400-12F-6	600 kcmil	1/2	1.75	1.39	2.30	0.18	4.20	Blue	P76	19	76	2 3/8	6
LCC500-14BF-6		1/4	0.75	1.54	2.50	0.22	2.65	Brown	P87	20	87	2 9/16	6
LCC500-38DF-6	600 kcmil	3/8	1.00	1.54	2.50	0.22	3.13	Brown	P87	20	87	2 9/16	6
LCC500-12F-6		1/2	1.75	1.54	2.50	0.22	4.31	Brown	P87	20	87	2 9/16	6
LCC600-38DF-6	600 kcmil	3/8	1.00	1.70	2.69	0.26	3.26	Green	P94	22	94	2 3/4	6
LCC600-12F-6		1/2	1.75	1.70	2.69	0.26	4.44	Green	P94	22	94	2 3/4	6

‡See pages D3.62 – D3.65 for tool and die information.  
 \*\*Consult cable manufacturer for voltage stress relief instructions with applications greater than 2000 V.  
 ◆NEMA hole sizes and spacing.



## Code Conductor, Two-Hole, Long Barrel with Window Lug

For Use with Stranded Copper Conductors

### Type LCC-W

- Long barrel maximizes number of crimps and provides premium wire pull-out strength and electrical performance
- Inspection window to visually assure full conductor insertion
- Color-coded barrels marked with Panduit and specified competitor die index numbers for proper crimp die selection
- Tin-plated to inhibit corrosion
- UL Listed and CSA Certified to 35 KV\*\* and temperature rated to 90°C when crimped with Panduit and specified competitor crimping tools and dies
- UL Listed and CSA Certified for wide wire range-taking capability when crimped with Panduit® Uni-Die™ Dieless Crimping Tools‡
- **Tested by Telcordia – meets NEBS Level 3**
- Meets J-STD-607-A and TIA-942 requirements for network systems grounding applications
- Available with NEMA hole sizes and spacing



Figure 1

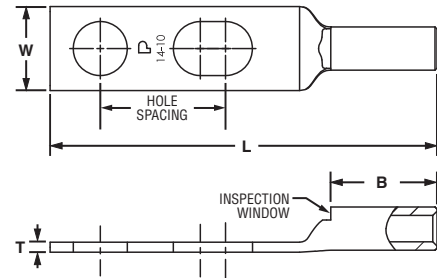

Figure 2: Slotted

Part Number	Figure No.	Copper Conductor Size	Stud Hole Size (In.)	Stud Hole Spacing (In.)	Figure Dimensions (In.)				Panduit Color Code	Panduit Die Index No.‡	Burdny Die Index No.‡	T&B Die Index No.‡	Wire Strip Length (In.)	Std. Pkg. Qty.
					W	B	T	L						
LCC10-14JAW-L*	2	#14 – 10 AWG STR, #12 – 10 AWG SOL	1/4	.50 – .63	.42	.53	.05	1.93	—	—	—	—	9/16	50
LCC10-14AW-L*	1		1/4	.63	.42	.53	.05	1.93	—	—	—	—	9/16	50
LCC10-14BW-L*	1		1/4	.75	.42	.53	.05	2.06	—	—	—	—	9/16	50
LCC8-10AW-L	1	#8 AWG	#10	.63	.41	.70	.08	2.01	Red	P21	49	21	3/4	50
LCC8-10BW-L	1		#10	.75	.41	.70	.08	2.14	Red	P21	49	21	3/4	50
LCC8-10ABW-L	2		#10	.63 – .75	.41	.70	.08	2.14	Red	P21	49	21	3/4	50
LCC8-14AW-L	1		1/4	.63	.48	.70	.07	2.10	Red	P21	49	21	3/4	50
LCC8-14BW-L	1		1/4	.75	.48	.70	.07	2.23	Red	P21	49	21	3/4	50
LCC8-14ABW-L	2		1/4	.63 – .75	.48	.70	.07	2.23	Red	P21	49	21	3/4	50
LCC8-14DW-L	1		1/4	1.00	.48	.70	.07	2.48	Red	P21	49	21	3/4	50
LCC8-38DW-L	1		3/8	1.00	.60	.70	.05	2.70	Red	P21	49	21	3/4	50
LCC6-10AW-L	1		#6 AWG	#10	.63	.46	1.07	.08	2.40	Blue	P24	7	24	1 1/8
LCC6-10BW-L	1	#10		.75	.46	1.07	.08	2.52	Blue	P24	7	24	1 1/8	50
LCC6-10ABW-L	2	#10		.63 – .75	.46	1.07	.08	2.52	Blue	P24	7	24	1 1/8	50
LCC6-14JW-L	1	1/4		.50	.48	1.07	.08	2.36	Blue	P24	7	24	1 1/8	50
LCC6-14AW-L	1	1/4		.63	.48	1.07	.08	2.49	Blue	P24	7	24	1 1/8	50
LCC6-14JAW-L	2	1/4		.50 – .63	.48	1.07	.08	2.49	Blue	P24	7	24	1 1/8	50
LCC6-14BW-L	1	1/4		.75	.48	1.07	.08	2.61	Blue	P24	7	24	1 1/8	50
LCC6-14DW-L	1	1/4		1.00	.48	1.07	.08	2.86	Blue	P24	7	24	1 1/8	50
LCC6-14BDW-L	2	1/4		.75 – 1.00	.48	1.07	.08	2.86	Blue	P24	7	24	1 1/8	50
LCC6-14EW-L	1	1/4		1.25	.48	1.07	.08	3.11	Blue	P24	7	24	1 1/8	50
LCC6-14W-L	1	1/4		1.75	.48	1.07	.08	3.61	Blue	P24	7	24	1 1/8	50
LCC6-56BW-L	1	5/16		.75	.56	1.07	.07	2.73	Blue	P24	7	24	1 1/8	50
LCC6-38BW-L	1	3/8		.75	.62	1.07	.06	2.83	Blue	P24	7	24	1 1/8	50
LCC6-38CW-L	1	3/8		.88	.62	1.07	.06	2.96	Blue	P24	7	24	1 1/8	50
LCC6-38DW-L	1	3/8		1.00	.62	1.07	.06	3.08	Blue	P24	7	24	1 1/8	50
LCC6-38BDW-L	2	3/8		.75 – 1.00	.62	1.07	.06	3.08	Blue	P24	7	24	1 1/8	50
LCC6-12W-L	1	1/2		1.75	.75	1.07	0.07	3.97	Blue	P24	7	24	1 1/8	50

‡See pages D3.62 – D3.65 for tool and die information.

\*Not tested to NEBS Level 3 requirements.

\*\*Consult cable manufacturer for voltage stress relief instructions with applications greater than 2000 V.

◆NEMA hole sizes and spacing.

Table continues on pages D2.48 – D2.49

A. System Overview

B1. Cable Ties

B2. Cable Accessories

B3. Stainless Steel Ties

C1. Wiring Duct

C2. Surface Raceway

C3. Abrasion Protection

C4. Cable Management

D1. Terminals

D2. Power Connectors

D3. Grounding Connectors

E1. Labeling Systems

E2. Labels

E3. Pre-Printed & Write-On Markers

E4. Permanent Identification

E5. Lockout/Tagout & Safety Solutions

F. Index

A. System Overview



## Code Conductor, Two-Hole, Long Barrel with Window Lug (continued)

B1. Cable Ties

B2. Cable Accessories

B3. Stainless Steel Ties

C1. Wiring Duct

C2. Surface Raceway

C3. Abrasion Protection

C4. Cable Management

D1. Terminals

D2. Power Connectors

D3. Grounding Connectors

E1. Labeling Systems

E2. Labels

E3. Pre-Printed & Write-On Markers

E4. Permanent Identification

E5. Lockout/Tagout & Safety Solutions

F. Index

Part Number	Figure No.	Copper Conductor Size	Stud Hole Size (In.)	Stud Hole Spacing (In.)	Figure Dimensions (In.)				Panduit Color Code	Panduit Die Index No.‡	Burndy Die Index No.‡	T&B Die Index No.‡	Wire Strip Length (In.)	Std. Pkg. Qty.	
					W	B	T	L							
LCC4-10AW-L	1	#4 – 3 AWG STR, #2 AWG SOL	#10	.63	.55	1.05	.09	2.40	Gray	P29	8	29	1 1/8	50	
LCC4-10BW-L	1		#10	.75	.55	1.05	.09	2.53	Gray	P29	8	29	1 1/8	50	
LCC4-14AW-L	1		1/4	.63	.55	1.05	.09	2.50	Gray	P29	8	29	1 1/8	50	
LCC4-14BW-L	1		1/4	.75	.55	1.05	.09	2.63	Gray	P29	8	29	1 1/8	50	
LCC4-14DW-L	1		1/4	1.00	.55	1.05	.09	2.63	Gray	P29	8	29	1 1/8	50	
LCC4-14ADW-L	2		1/4	.63 – 1.00	.55	1.05	.09	2.87	Gray	P29	8	29	1 1/8	50	
LCC4-38DW-L	1		3/8	1.00	.62	1.05	.08	3.09	Gray	P29	8	29	1 1/8	50	
LCC4-12W-L	1		1/2	1.75	.75	1.05	0.07	4.01	Gray	P29	8	29	1 1/8	50	
LCC2-10AW-Q	1		#2 AWG	#10	.63	.60	1.16	.10	2.57	Brown	P33	10	33	1 1/4	25
LCC2-10BW-Q	1			#10	.75	.60	1.16	.10	2.69	Brown	P33	10	33	1 1/4	25
LCC2-14AW-Q	1	1/4		.63	.60	1.16	.10	2.67	Brown	P33	10	33	1 1/4	25	
LCC2-14BW-Q	1	1/4		.75	.60	1.16	.10	2.79	Brown	P33	10	33	1 1/4	25	
LCC2-14DW-Q	1	1/4		1.00	.60	1.16	.10	3.04	Brown	P33	10	33	1 1/4	25	
LCC2-56BW-Q	1	5/16		.75	.66	1.16	.10	2.92	Brown	P33	10	33	1 1/4	25	
LCC2-56CW-Q	1	5/16		.88	.66	1.16	.10	3.04	Brown	P33	10	33	1 1/4	25	
LCC2-38BW-Q	1	3/8		.75	.66	1.16	.10	2.99	Brown	P33	10	33	1 1/4	25	
LCC2-38CW-Q	1	3/8		.88	.66	1.16	.10	3.12	Brown	P33	10	33	1 1/4	25	
LCC2-38DW-Q	1	3/8		1.00	.66	1.16	.10	3.24	Brown	P33	10	33	1 1/4	25	
LCC2-38W-Q	1	3/8	1.75	.66	1.16	.10	3.99	Brown	P33	10	33	1 1/4	25		
LCC2-12W-Q	1	1/2	1.75	.75	1.16	.08	4.41	Brown	P33	10	33	1 1/4	25		
LCC1-14AW-E	1	#1 AWG	1/4	.63	.70	1.36	.11	2.89	Green	P37	11	37	1 7/16	20	
LCC1-14BW-E	1		1/4	.75	.70	1.36	.11	3.01	Green	P37	11	37	1 7/16	20	
LCC1-56BW-E	1		5/16	.75	.70	1.36	.11	3.14	Green	P37	11	37	1 7/16	20	
LCC1-56CW-E	1		5/16	.88	.70	1.36	.11	3.26	Green	P37	11	37	1 7/16	20	
LCC1-38DW-E	1		3/8	1.00	.70	1.36	.11	3.46	Green	P37	11	37	1 7/16	20	
LCC1-12W-E	1		1/2	1.75	.75	1.36	.09	4.63	Green	P37	11	37	1 7/16	20	
LCC1/0-14AW-X	1	1/0 AWG	1/4	.63	.76	1.44	.12	3.07	Pink	P42	12	42	1 1/2	10	
LCC1/0-14BW-X	1		1/4	.75	.76	1.44	.12	3.19	Pink	P42	12	42	1 1/2	10	
LCC1/0-14DW-X	1		1/4	1.00	.76	1.44	.12	3.44	Pink	P42	12	42	1 1/2	10	
LCC1/0-38DW-X	1		3/8	1.00	.76	1.44	.12	3.57	Pink	P42	12	42	1 1/2	10	
LCC1/0-38W-X	1		3/8	1.75	.76	1.44	.12	4.32	Pink	P42	12	42	1 1/2	10	
LCC1/0-12DW-X	1		1/2	1.00	.80	1.44	.12	3.84	Pink	P42	12	42	1 1/2	10	
LCC1/0-12W-X	1	1/2	1.75	.80	1.44	.12	4.74	Pink	P42	12	42	1 1/2	10		
LCC2/0-14AW-X	1	2/0 AWG	1/4	.63	.85	1.50	.13	3.23	Black	P45	13	45	1 9/16	10	
LCC2/0-14BW-X	1		1/4	.75	.85	1.50	.13	3.36	Black	P45	13	45	1 9/16	10	
LCC2/0-56DW-X	1		5/16	1.00	.85	1.50	.13	3.61	Black	P45	13	45	1 9/16	10	
LCC2/0-38DW-X	1		3/8	1.00	.85	1.50	.13	3.67	Black	P45	13	45	1 9/16	10	
LCC2/0-12DW-X	1		1/2	1.00	.85	1.50	.13	3.92	Black	P45	13	45	1 9/16	10	
LCC2/0-12W-X	1		1/2	1.75	.85	1.50	.13	4.83	Black	P45	13	45	1 9/16	10	

‡See pages D3.62 – D3.65 for tool and die information.  
 \*Not tested to NEBS Level 3 requirements.  
 \*\*Consult cable manufacturer for voltage stress relief instructions with applications greater than 2000 V.  
 ◆NEMA hole sizes and spacing.



## Code Conductor, Two-Hole, Long Barrel with Window Lug (continued)

Part Number	Figure No.	Copper Conductor Size	Stud Hole Size (In.)	Stud Hole Spacing (In.)	Figure Dimensions (In.)				Panduit Color Code	Panduit Die Index No.‡	Burdny Die Index No.‡	T&B Die Index No.‡	Wire Strip Length (In.)	Std. Pkg. Qty.
					W	B	T	L						
LCC3/0-14BW-X	1	3/0 AWG	1/4	.75	.96	1.50	.13	3.39	Orange	P50	14	50	1 9/16	10
LCC3/0-56DW-X	1		5/16	1.00	.96	1.50	.13	3.64	Orange	P50	14	50	1 9/16	10
LCC3/0-38DW-X	1		3/8	1.00	.96	1.50	.13	3.70	Orange	P50	14	50	1 9/16	10
LCC3/0-12DW-X	1		1/2	1.00	.96	1.50	.13	3.95	Orange	P50	14	50	1 9/16	10
LCC3/0-12W-X	1		1/2	1.75	.96	1.50	.13	4.87	Orange	P50	14	50	1 9/16	10
LCC4/0-14AW-X	1	4/0 AWG	1/4	.63	1.06	1.56	.14	3.35	Purple	P54	15	54	1 5/8	10
LCC4/0-14BW-X	1		1/4	.75	1.06	1.56	.14	3.48	Purple	P54	15	54	1 5/8	10
LCC4/0-56DW-X	1		5/16	1.00	1.06	1.56	.14	3.74	Purple	P54	15	54	1 5/8	10
LCC4/0-38DW-X	1		3/8	1.00	1.06	1.56	.14	3.81	Purple	P54	15	54	1 5/8	10
LCC4/0-38W-X	1		3/8	1.75	1.06	1.56	.14	4.56	Purple	P54	15	54	1 5/8	10
LCC4/0-12DW-X	1		1/2	1.00	1.06	1.56	.14	4.04	Purple	P54	15	54	1 5/8	10
◆ LCC4/0-12W-X	1	1/2	1.75	1.06	1.56	.14	4.95	Purple	P54	15	54	1 5/8	10	
LCC250-56DW-X	1	250 kcmil	5/16	1.00	1.17	1.61	.14	3.82	Yellow	P62	16	62	1 11/16	10
LCC250-38DW-X	1		3/8	1.00	1.17	1.61	.14	3.89	Yellow	P62	16	62	1 11/16	10
LCC250-12DW-X	1		1/2	1.00	1.17	1.61	.14	4.12	Yellow	P62	16	62	1 11/16	10
◆ LCC250-12W-X	1	1/2	1.75	1.17	1.61	.14	5.03	Yellow	P62	16	62	1 11/16	10	
LCC300-38DW-X	1	300 kcmil	3/8	1.00	1.19	2.24	.16	4.54	White	P66	17	66	2 5/16	10
◆ LCC300-12W-X	1		1/2	1.75	1.19	2.24	.16	5.72	White	P66	17	66	2 5/16	10
LCC350-14BW-X	1	350 kcmil	1/4	.75	1.28	2.24	.17	4.10	Red	P71	18	71	2 5/16	10
LCC350-38DW-X	1		3/8	1.00	1.28	2.24	.17	4.58	Red	P71	18	71	2 5/16	10
◆ LCC350-12W-X	1		1/2	1.75	1.28	2.24	.17	5.76	Red	P71	18	71	2 5/16	10
LCC400-14BW-6	1	400 kcmil	1/4	.75	1.39	2.30	.18	4.18	Blue	P76	19	76	2 3/8	6
LCC400-38DW-6	1		3/8	1.00	1.39	2.30	.18	4.66	Blue	P76	19	76	2 3/8	6
◆ LCC400-12W-6	1		1/2	1.75	1.28	2.30	.17	5.84	Blue	P76	19	76	2 3/8	6
LCC500-14BW-6	1	500 kcmil	1/4	.75	1.54	2.50	.22	4.46	Brown	P87	20	87	2 9/16	6
LCC500-38DW-6	1		3/8	1.00	1.54	2.50	.22	4.94	Brown	P87	20	87	2 9/16	6
◆ LCC500-12W-6	1		1/2	1.75	1.54	2.50	.22	6.12	Brown	P87	20	87	2 9/16	6
LCC600-38DW-6	1	600 kcmil	3/8	1.00	1.70	2.69	.26	5.18	Green	P94	22	94	2 3/4	6
◆ LCC600-12W-6	1		1/2	1.75	1.70	2.69	.26	6.36	Green	P94	22	94	2 3/4	6
LCC750-38DW-6	1	750 kcmil	3/8	1.00	1.89	2.88	.26	5.71	Black	P106	24	106	2 15/16	6
◆ LCC750-12W-6	1		1/2	1.75	1.89	2.88	.26	6.65	Black	P106	24	106	2 15/16	6
◆ LCC800-12W-6	1	800 kcmil	1/2	1.75	1.95	2.94	.30	6.74	Orange	P107	25	107	3	6
LCC1000-38DW-3	1	1000 kcmil	3/8	1.00	2.17	3.00	.32	5.95	White	P125	27	125	3 1/16	3
◆ LCC1000-12W-3	1		1/2	1.75	2.17	3.00	.32	6.89	White	P125	27	125	3 1/16	3

‡See pages D3.62 – D3.65 for tool and die information.

\*Not tested to NEBS Level 3 requirements.

\*\*Consult cable manufacturer for voltage stress relief instructions with applications greater than 2000 V.

◆NEMA hole sizes and spacing.

A.  
System  
Overview

B1.  
Cable Ties

B2.  
Cable  
Accessories

B3.  
Stainless  
Steel Ties

C1.  
Wiring  
Duct

C2.  
Surface  
Raceway

C3.  
Abrasion  
Protection

C4.  
Cable  
Management

D1.  
Terminals

D2.  
Power  
Connectors

D3.  
Grounding  
Connectors

E1.  
Labeling  
Systems

E2.  
Labels

E3.  
Pre-Printed  
& Write-On  
Markers

E4.  
Permanent  
Identification

E5.  
Lockout/  
Tagout  
& Safety  
Solutions

F.  
Index

A. System Overview



## Code Conductor, Two-Hole, Long Barrel with Window Lug, 45° Angle

B1. Cable Ties

### For Use with Stranded Copper Conductors

#### Type LCC-WH

- Long barrel maximizes number of crimps and provides premium wire pull-out strength and electrical performance
- Inspection window to visually assure full conductor insertion
- Color-coded barrels marked with Panduit and specified competitor die index numbers for proper crimp die selection
- Tin-plated to inhibit corrosion
- UL Listed and CSA Certified to 35 KV\*\* and temperature rated to 90°C when crimped with Panduit and specified competitor crimping tools and dies
- UL Listed and CSA Certified for wide wire range-taking capability when crimped with Panduit® Uni-Die™ Dieless Crimping Tools‡
- **Tested by Telcordia – meets NEBS Level 3**
- Meets J-STD-607-A and TIA-942 requirements for network systems grounding applications
- Available with NEMA hole sizes and spacing

B2. Cable Accessories

B3. Stainless Steel Ties

C1. Wiring Duct

C2. Surface Raceway

C3. Abrasion Protection

C4. Cable Management

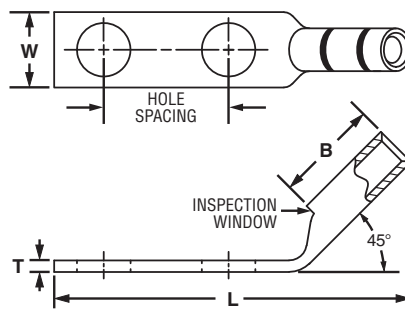

Figure 1

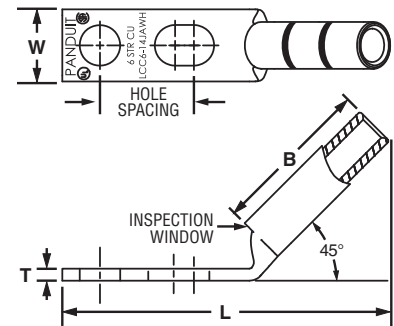

Figure 2: Slotted

D1. Terminals

D2. Power Connectors

D3. Grounding Connectors

E1. Labeling Systems

E2. Labels

E3. Pre-Printed & Write-On Markers

E4. Permanent Identification

E5. Lockout/Tagout & Safety Solutions

F. Index

Part Number	Figure No.	Copper Conductor Size	Stud Hole Size (In.)	Stud Hole Spacing (In.)	Figure Dimensions (In.)				Panduit Color Code	Panduit Die Index No.‡	Burdny Die Index No.‡	T&B Die Index No.‡	Wire Strip Length (In.)	Std. Pkg. Qty.
					W	B	T	L						
<b>LCC10-14JAWH-L*</b>	2	#14 – #10 AWG STR, #12 – #10 AWG SOL	1/4	0.50–0.63	0.42	0.53	0.05	1.78	—	—	—	—	9/16	50
<b>LCC10-14AWH-L*</b>	1		1/4	0.63	0.42	0.53	0.05	1.78	—	—	—	—	9/16	50
<b>LCC10-14BWH-L*</b>	1		1/4	0.75	0.42	0.53	0.05	1.90	—	—	—	—	9/16	50
<b>LCC8-10AWH-L</b>	1	#8 AWG	#10	0.63	0.41	0.70	0.08	1.82	Red	P21	49	21	3/4	50
<b>LCC8-10BWH-L</b>	1		#10	0.75	0.41	0.70	0.08	1.95	Red	P21	49	21	3/4	50
<b>LCC8-14AWH-L</b>	2		1/4	0.63	0.48	0.70	0.07	1.91	Red	P21	49	21	3/4	50
<b>LCC8-14BWH-L</b>	1		1/4	0.75	0.48	0.70	0.07	2.03	Red	P21	49	21	3/4	50
<b>LCC8-14DWH-L</b>	1		1/4	1.00	0.48	0.70	0.07	2.28	Red	P21	49	21	3/4	50
<b>LCC8-38DWH-L</b>	1		3/8	1.00	0.60	0.70	0.05	2.49	Red	P21	49	21	3/4	50
<b>LCC6-10AWH-L</b>	1	#6 AWG	#10	0.63	0.46	1.07	0.08	2.09	Blue	P24	7	24	1 1/8	50
<b>LCC6-10BWH-L</b>	1		#10	0.75	0.46	1.07	0.08	2.22	Blue	P24	7	24	1 1/8	50
<b>LCC6-14JWH-L</b>	1		1/4	0.50	0.48	1.07	0.08	2.06	Blue	P24	7	24	1 1/8	50
<b>LCC6-14AWH-L</b>	1		1/4	0.63	0.48	1.07	0.08	2.18	Blue	P24	7	24	1 1/8	50
<b>LCC6-14JAWH-L</b>	2		1/4	0.50–0.63	0.48	1.07	0.08	2.08	Blue	P24	7	24	1 1/8	50
<b>LCC6-14BWH-L</b>	1		1/4	0.75	0.48	1.07	0.08	2.31	Blue	P24	7	24	1 1/8	50
<b>LCC6-14DWH-L</b>	1		1/4	1.00	0.48	1.07	0.08	2.56	Blue	P24	7	24	1 1/8	50
<b>LCC6-14EWH-L</b>	1		1/4	1.25	0.48	1.07	0.08	2.81	Blue	P24	7	24	1 1/8	50
<b>LCC6-56BWH-L</b>	1		5/16	0.75	0.56	1.07	0.07	2.42	Blue	P24	7	24	1 1/8	50
<b>LCC6-38BWH-L</b>	1		3/8	0.75	0.62	1.07	0.06	2.52	Blue	P24	7	24	1 1/8	50
<b>LCC6-38CWH-L</b>	1		3/8	0.88	0.62	1.07	0.06	2.64	Blue	P24	7	24	1 1/8	50
<b>LCC6-38DWH-L</b>	1		3/8	1.00	0.62	1.07	0.06	2.77	Blue	P24	7	24	1 1/8	50

‡See pages D3.62 – D3.65 for tool and die information.

\*Not tested to NEBS Level 3 requirements.

\*\*Consult cable manufacturer for voltage stress relief instructions with applications greater than 2000 V.





## Code Conductor, Two-Hole, Long Barrel with Window Lug, 45° Angle (continued)

A.  
System  
Overview

B1.  
Cable Ties

B2.  
Cable  
Accessories

B3.  
Stainless  
Steel Ties

C1.  
Wiring  
Duct

C2.  
Surface  
Raceway

C3.  
Abrasion  
Protection

C4.  
Cable  
Management

D1.  
Terminals

D2.  
Power  
Connectors

D3.  
Grounding  
Connectors

E1.  
Labeling  
Systems

E2.  
Labels

E3.  
Pre-Printed  
& Write-On  
Markers

E4.  
Permanent  
Identification

E5.  
Lockout/  
Tagout  
& Safety  
Solutions

F.  
Index

Part Number	Figure No.	Copper Conductor Size	Stud Hole Size (In.)	Stud Hole Spacing (In.)	Figure Dimensions (In.)				Panduit Color Code	Panduit Die Index No.‡	Burndy Die Index No.‡	T&B Die Index No.‡	Wire Strip Length (In.)	Std. Pkg. Qty.	
					W	B	T	L							
LCC4-10AWH-L	1	#4 – #3 AWG STR, #2 AWG SOL	#10	0.63	0.55	1.05	0.09	2.11	Gray	P29	8	29	1 1/8	50	
LCC4-10BWH-L	1		#10	0.75	0.55	1.05	0.09	2.23	Gray	P29	8	29	1 1/8	50	
LCC4-14AWH-L	1		1/4	0.63	0.55	1.05	0.09	2.20	Gray	P29	8	29	1 1/8	50	
LCC4-14BWH-L	1		1/4	0.75	0.55	1.05	0.09	2.32	Gray	P29	8	29	1 1/8	50	
LCC4-38DWH-L	1		3/8	1.00	0.62	1.05	0.08	2.79	Gray	P29	8	29	1 1/8	50	
LCC2-10AWH-Q	1	#2 AWG	#10	0.63	0.60	1.16	0.10	2.21	Brown	P33	10	33	1 1/4	25	
LCC2-10BWH-Q	1		#10	0.75	0.60	1.16	0.10	2.33	Brown	P33	10	33	1 1/4	25	
LCC2-14AWH-Q	1		1/4	0.63	0.60	1.16	0.10	2.31	Brown	P33	10	33	1 1/4	25	
LCC2-14BWH-Q	1		1/4	0.75	0.60	1.16	0.10	2.43	Brown	P33	10	33	1 1/4	25	
LCC2-14DWH-Q	1		1/4	1.00	0.60	1.16	0.10	2.68	Brown	P33	10	33	1 1/4	25	
LCC2-56BWH-Q	1		5/16	0.75	0.66	1.16	0.10	2.55	Brown	P33	10	33	1 1/4	25	
LCC2-56CWH-Q	1		5/16	0.88	0.66	1.16	0.10	2.68	Brown	P33	10	33	1 1/4	25	
LCC2-38BWH-Q	1		3/8	0.75	0.66	1.16	0.10	2.63	Brown	P33	10	33	1 1/4	25	
LCC2-38CWH-Q	1		3/8	0.88	0.66	1.16	0.10	2.75	Brown	P33	10	33	1 1/4	25	
LCC2-38DWH-Q	1		3/8	1.00	0.66	1.16	0.10	2.88	Brown	P33	10	33	1 1/4	25	
LCC2-38WH-Q	1		3/8	1.75	0.66	1.16	0.10	3.63	Brown	P33	10	33	1 1/4	25	
LCC2-12WH-Q	1		1/2	1.75	0.75	1.16	0.08	4.03	Brown	P33	10	33	1 1/4	25	
LCC1-14AWH-E	1		#1 AWG	1/4	0.63	0.70	1.36	0.11	2.46	Green	P37	11	37	1 7/16	20
LCC1-14BWH-E	1			1/4	0.75	0.70	1.36	0.11	2.58	Green	P37	11	37	1 7/16	20
LCC1-56BWH-E	1			5/16	0.75	0.70	1.36	0.11	2.71	Green	P37	11	37	1 7/16	20
LCC1-56CWH-E	1	5/16		0.88	0.70	1.36	0.11	2.83	Green	P37	11	37	1 7/16	20	
LCC1-38DWH-E	1	3/8		1.00	0.70	1.36	0.11	3.04	Green	P37	11	37	1 7/16	20	
LCC1-12WH-E	1	1/2	1.75	0.75	1.36	0.09	4.20	Green	P37	11	37	1 7/16	20		
LCC1/0-14AWH-X	1	1/0 AWG	1/4	0.63	0.76	1.44	0.12	2.61	Pink	P42	12	42	1 1/2	10	
LCC1/0-14BWH-X	1		1/4	0.75	0.76	1.44	0.12	2.73	Pink	P42	12	42	1 1/2	10	
LCC1/0-14DWH-X	1		1/4	1.00	0.76	1.44	0.12	2.98	Pink	P42	12	42	1 1/2	10	
LCC1/0-38DWH-X	1		3/8	1.00	0.76	1.44	0.12	3.11	Pink	P42	12	42	1 1/2	10	
LCC1/0-38WH-X	1		3/8	1.75	0.76	1.44	0.12	3.86	Pink	P42	12	42	1 1/2	10	
LCC1/0-12DWH-X	1	1/2	1.00	0.80	1.44	0.12	3.37	Pink	P42	12	42	1 1/2	10		
LCC1/0-12WH-X	1	1/2	1.75	0.80	1.44	0.12	4.28	Pink	P42	12	42	1 1/2	10		
LCC2/0-14AWH-X	1	2/0 AWG	1/4	0.63	0.85	1.50	0.13	2.76	Black	P45	13	45	1 9/16	10	
LCC2/0-14BWH-X	1		1/4	0.75	0.85	1.50	0.13	2.88	Black	P45	13	45	1 9/16	10	
LCC2/0-56DWH-X	1		5/16	1.00	0.85	1.50	0.13	3.13	Black	P45	13	45	1 9/16	10	
LCC2/0-38DWH-X	1		3/8	1.00	0.85	1.50	0.13	3.20	Black	P45	13	45	1 9/16	10	
LCC2/0-12DWH-X	1		1/2	1.00	0.85	1.50	0.13	3.45	Black	P45	13	45	1 9/16	10	
LCC2/0-12WH-X	1	1/2	1.75	0.85	1.50	0.13	4.36	Black	P45	13	45	1 9/16	10		
LCC3/0-14BWH-X	1	3/0 AWG	1/4	0.75	0.96	1.50	0.13	2.91	Orange	P50	14	50	1 9/16	10	
LCC3/0-56DWH-X	1		5/16	1.00	0.96	1.50	0.13	3.16	Orange	P50	14	50	1 9/16	10	
LCC3/0-38DWH-X	1		3/8	1.00	0.96	1.50	0.13	3.22	Orange	P50	14	50	1 9/16	10	
LCC3/0-12DWH-X	1		1/2	1.00	0.96	1.50	0.13	3.47	Orange	P50	14	50	1 9/16	10	
LCC3/0-12WH-X	1		1/2	1.75	0.96	1.50	0.13	4.38	Orange	P50	14	50	1 9/16	10	
LCC4/0-14AWH-X	1	4/0 AWG	1/4	0.63	1.06	1.56	0.14	2.85	Purple	P54	15	54	1 5/8	10	
LCC4/0-14BWH-X	1		1/4	0.75	1.06	1.56	0.14	2.98	Purple	P54	15	54	1 5/8	10	
LCC4/0-56DWH-X	1		5/16	1.00	1.06	1.56	0.14	3.24	Purple	P54	15	54	1 5/8	10	
LCC4/0-38DWH-X	1		3/8	1.00	1.06	1.56	0.14	3.31	Purple	P54	15	54	1 5/8	10	
LCC4/0-38WH-X	1		3/8	1.75	1.06	1.56	0.14	4.06	Purple	P54	15	54	1 5/8	10	
LCC4/0-12DWH-X	1	1/2	1.00	1.06	1.56	0.14	3.54	Purple	P54	15	54	1 5/8	10		
LCC4/0-12WH-X	1	1/2	1.75	1.06	1.56	0.14	4.45	Purple	P54	15	54	1 5/8	10		

‡See pages D3.62 – D3.65 for tool and die information.

\*\*Consult cable manufacturer for voltage stress relief instructions with applications greater than 2000 V.

◆NEMA hole sizes and spacing.

*Table continues on page D2.52*

A.  
System  
Overview



## Code Conductor, Two-Hole, Long Barrel with Window Lug, 45° Angle (continued)

B1.  
Cable Ties

B2.  
Cable  
Accessories

B3.  
Stainless  
Steel Ties

C1.  
Wiring  
Duct

C2.  
Surface  
Raceway

C3.  
Abrasion  
Protection

C4.  
Cable  
Management

D1.  
Terminals

D2.  
Power  
Connectors

D3.  
Grounding  
Connectors

E1.  
Labeling  
Systems

E2.  
Labels

E3.  
Pre-Printed  
& Write-On  
Markers

E4.  
Permanent  
Identification

E5.  
Lockout/  
Tagout  
& Safety  
Solutions

F.  
Index

Part Number	Figure No.	Copper Conductor Size	Stud Hole Size (In.)	Stud Hole Spacing (In.)	Figure Dimensions (In.)				Panduit Color Code	Panduit Die Index No.‡	Burndy Die Index No.‡	T&B Die Index No.‡	Wire Strip Length (In.)	Std. Pkg. Qty.
					W	B	T	L						
LCC250-56DWH-X	1	250 kcmil	5/16	1.00	1.17	1.61	0.14	3.31	Yellow	P62	16	62	1 11/16	10
LCC250-38DWH-X	1		3/8	1.00	1.17	1.61	0.14	3.38	Yellow	P62	16	62	1 11/16	10
LCC250-12DWH-X	1		1/2	1.00	1.17	1.61	0.14	3.61	Yellow	P62	16	62	1 11/16	10
◆ LCC250-12WH-X	1	300 kcmil	1/2	1.75	1.17	1.61	0.14	4.52	Yellow	P62	16	62	1 11/16	10
LCC300-38DWH-X	1		3/8	1.00	1.19	2.24	0.16	3.93	White	P66	17	66	2 5/16	10
◆ LCC300-12WH-X	1		1/2	1.75	1.19	2.24	0.16	5.11	White	P66	17	66	2 5/16	10
LCC350-14BWH-X	1	350 kcmil	1/4	0.75	1.28	2.24	0.17	3.48	Red	P71	18	71	2 5/16	10
LCC350-38DWH-X	1		3/8	1.00	1.28	2.24	0.17	3.96	Red	P71	18	71	2 5/16	10
◆ LCC350-12WH-X	1		1/2	1.75	1.28	2.24	0.17	5.14	Red	P71	18	71	2 5/16	10
LCC400-14BWH-6	1	400 kcmil	1/4	0.75	1.39	2.30	0.18	3.59	Blue	P76	19	76	2 3/8	6
LCC400-38DWH-6	1		3/8	1.00	1.39	2.30	0.18	4.07	Blue	P76	19	76	2 3/8	6
◆ LCC400-12WH-6	1		1/2	1.75	1.28	2.30	0.17	5.24	Blue	P76	19	76	2 3/8	6
LCC500-14BWH-6	1	500 kcmil	1/4	0.75	1.54	2.50	0.22	3.80	Brown	P87	20	87	2 9/16	6
LCC500-38DWH-6	1		3/8	1.00	1.54	2.50	0.22	4.29	Brown	P87	20	87	2 9/16	6
◆ LCC500-12WH-6	1		1/2	1.75	1.54	2.50	0.22	5.46	Brown	P87	20	87	2 9/16	6
LCC600-38DWH-6	1	600 kcmil	3/8	1.00	1.70	2.69	0.26	4.47	Green	P94	22	94	2 3/4	6
◆ LCC600-12WH-6	1		1/2	1.75	1.70	2.69	0.26	5.65	Green	P94	22	94	2 3/4	6

‡See pages D3.62 – D3.65 for tool and die information.

\*\*Consult cable manufacturer for voltage stress relief instructions with applications greater than 2000 V.

◆NEMA hole sizes and spacing.



## Code Conductor, Two-Hole, Long Barrel with Window Lug, 90° Angle

For Use with Stranded Copper Conductors

### Type LCC-WF

- Long barrel maximizes number of crimps and provides premium wire pull-out strength and electrical performance
- Inspection window to visually assure full conductor insertion
- Color-coded barrels marked with Panduit and specified competitor die index numbers for proper crimp die selection
- Tin-plated to inhibit corrosion
- UL Listed and CSA Certified to 35 KV\*\* and temperature rated to 90°C when crimped with Panduit and specified competitor crimping tools and dies
- UL Listed and CSA Certified for wide wire range-taking capability when crimped with Panduit® Uni-Die™ Dieless Crimping Tools‡
- **Tested by Telcordia – meets NEBS Level 3**
- Meets J-STD-607-A and TIA-942 requirements for network systems grounding applications
- Available with NEMA hole sizes and spacing

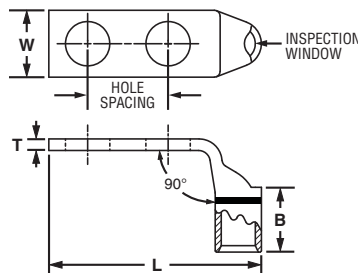

Figure 1



Figure 2: Slotted

Part Number	Figure No.	Copper Conductor Size	Stud Hole Size (in.)	Stud Hole Spacing (in.)	Figure Dimensions (in.)				Panduit Color Code	Panduit Die Index No.‡	Burdny Die Index No.‡	T&B Die Index No.‡	Wire Strip Length (in.)	Std. Pkg. Qty.
					W	B	T	L						
LCC10-14JAWF-L*	2	#14 – #10 AWG	1/4	0.50 – 0.63	0.42	0.53	0.05	1.56	—	—	—	—	9/16	50
LCC10-14AWF-L*	1	STR, #12 – #10 AWG SOL	1/4	0.63	0.42	0.53	0.05	1.56	—	—	—	—	9/16	50
LCC10-14BWF-L*	1		1/4	0.75	0.42	0.53	0.05	1.69	—	—	—	—	9/16	50
LCC8-10AWF-L	1	#8 AWG	#10	0.63	0.41	0.70	0.08	1.53	Red	P21	49	21	3/4	50
LCC8-10BWF-L	1		#10	0.75	0.41	0.70	0.08	1.65	Red	P21	49	21	3/4	50
LCC8-14AWF-L	1		1/4	0.63	0.48	0.70	0.07	1.61	Red	P21	49	21	3/4	50
LCC8-14BWF-L	1		1/4	0.75	0.48	0.70	0.07	1.74	Red	P21	49	21	3/4	50
LCC8-14DWF-L	1		1/4	1.00	0.48	0.70	0.07	1.99	Red	P21	49	21	3/4	50
LCC8-38DWF-L	1		3/8	1.00	0.60	0.70	0.05	2.21	Red	P21	49	21	3/4	50
LCC6-10AWF-L	1	#6 AWG	#10	0.63	0.46	1.07	0.08	1.57	Blue	P24	7	24	1 1/8	50
LCC6-10BWF-L	1		#10	0.75	0.46	1.07	0.08	1.69	Blue	P24	7	24	1 1/8	50
LCC6-14JWF-L	1		1/4	0.50	0.48	1.07	0.08	1.53	Blue	P24	7	24	1 1/8	50
LCC6-14AWF-L	1		1/4	0.63	0.48	1.07	0.08	1.66	Blue	P24	7	24	1 1/8	50
LCC6-14JAWF-L	2		1/4	0.50 – 0.63	0.48	1.07	0.08	1.66	Blue	P24	7	24	1 1/8	50
LCC6-14BWF-L	1		1/4	0.75	0.48	1.07	0.08	1.78	Blue	P24	7	24	1 1/8	50
LCC6-14DWF-L	1		1/4	1.00	0.48	1.07	0.08	2.03	Blue	P24	7	24	1 1/8	50
LCC6-14EWF-L	1		1/4	1.25	0.48	1.07	0.08	2.28	Blue	P24	7	24	1 1/8	50
LCC6-56BWF-L	1		5/16	0.75	0.56	1.07	0.07	1.90	Blue	P24	7	24	1 1/8	50
LCC6-38BWF-L	1		3/8	0.75	0.62	1.07	0.06	2.00	Blue	P24	7	24	1 1/8	50
LCC6-38CWF-L	1		3/8	0.88	0.62	1.07	0.06	2.13	Blue	P24	7	24	1 1/8	50
LCC6-38DWF-L	1		3/8	1.00	0.62	1.07	0.06	2.25	Blue	P24	7	24	1 1/8	50

‡See pages D3.62 – D3.65 for tool and die information.

\*Not tested to NEBS Level 3 requirements.

\*\*Consult cable manufacturer for voltage stress relief instructions with applications greater than 2000 V.

Table continues on pages D2.54 — D2.55

A. System Overview

B1. Cable Ties

B2. Cable Accessories

B3. Stainless Steel Ties

C1. Wiring Duct

C2. Surface Raceway

C3. Abrasion Protection

C4. Cable Management

D1. Terminals

D2. Power Connectors

D3. Grounding Connectors

E1. Labeling Systems

E2. Labels

E3. Pre-Printed & Write-On Markers

E4. Permanent Identification

E5. Lockout/Tagout & Safety Solutions

F. Index



## Code Conductor, Two-Hole, Long Barrel with Window Lug, 90° Angle (continued)

A. System Overview
B1. Cable Ties
B2. Cable Accessories
B3. Stainless Steel Ties
C1. Wiring Duct
C2. Surface Raceway
C3. Abrasion Protection
C4. Cable Management
D1. Terminals
D2. Power Connectors
D3. Grounding Connectors
E1. Labeling Systems
E2. Labels
E3. Pre-Printed & Write-On Markers
E4. Permanent Identification
E5. Lockout/Tagout & Safety Solutions
F. Index

Part Number	Figure No.	Copper Conductor Size	Stud Hole Size (In.)	Stud Hole Spacing (In.)	Figure Dimensions (In.)				Panduit Color Code	Panduit Die Index No.‡	Burndy Die Index No.‡	T&B Die Index No.‡	Wire Strip Length (In.)	Std. Pkg. Qty.
					W	B	T	L						
LCC4-10AWF-L	1	#4 – #3 AWG STR, #2 AWG SOL	#10	0.63	0.55	1.05	0.09	1.65	Gray	P29	8	29	1 1/8	50
LCC4-10BWF-L	1		#10	0.75	0.55	1.05	0.09	1.78	Gray	P29	8	29	1 1/8	50
LCC4-14AWF-L	1		1/4	0.63	0.55	1.05	0.09	1.74	Gray	P29	8	29	1 1/8	50
LCC4-14BWF-L	1		1/4	0.75	0.55	1.05	0.09	1.87	Gray	P29	8	29	1 1/8	50
LCC4-38DWF-L	1	#2 AWG	3/8	1.00	0.62	1.05	0.08	2.34	Gray	P29	8	29	1 1/8	50
LCC2-10AWF-Q	1		#10	0.63	0.60	1.16	0.10	1.76	Brown	P33	10	33	1 1/4	25
LCC2-10BWF-Q	1		#10	0.75	0.60	1.16	0.10	1.89	Brown	P33	10	33	1 1/4	25
LCC2-14AWF-Q	1		1/4	0.63	0.60	1.16	0.10	1.86	Brown	P33	10	33	1 1/4	25
LCC2-14BWF-Q	1		1/4	0.75	0.60	1.16	0.10	1.99	Brown	P33	10	33	1 1/4	25
LCC2-14DWF-Q	1		1/4	1.00	0.60	1.16	0.10	2.24	Brown	P33	10	33	1 1/4	25
LCC2-56BWF-Q	1		5/16	0.75	0.66	1.16	0.10	2.11	Brown	P33	10	33	1 1/4	25
LCC2-56CWF-Q	1		5/16	0.88	0.66	1.16	0.10	2.24	Brown	P33	10	33	1 1/4	25
LCC2-38BWF-Q	1		3/8	0.75	0.66	1.16	0.10	2.19	Brown	P33	10	33	1 1/4	25
LCC2-38CWF-Q	1		3/8	0.88	0.66	1.16	0.10	2.31	Brown	P33	10	33	1 1/4	25
LCC2-38DWF-Q	1		3/8	1.00	0.66	1.16	0.10	2.44	Brown	P33	10	33	1 1/4	25
LCC2-38WF-Q	1		3/8	1.75	0.66	1.16	0.10	3.19	Brown	P33	10	33	1 1/4	25
LCC2-12WF-Q	1	1/2	1.75	0.75	1.16	0.08	3.61	Brown	P33	10	33	1 1/4	25	
LCC1-14AWF-E	1	#1 AWG	1/4	0.63	0.70	1.36	0.11	1.94	Green	P37	11	37	1 7/16	20
LCC1-14BWF-E	1		1/4	0.75	0.70	1.36	0.11	2.06	Green	P37	11	37	1 7/16	20
LCC1-56BWF-E	1		5/16	0.75	0.70	1.36	0.11	2.19	Green	P37	11	37	1 7/16	20
LCC1-56CWF-E	1		5/16	0.88	0.70	1.36	0.11	2.31	Green	P37	11	37	1 7/16	20
LCC1-38DWF-E	1		3/8	1.00	0.70	1.36	0.11	2.51	Green	P37	11	37	1 7/16	20
LCC1-12WF-E	1		1/2	1.75	0.75	1.36	0.09	3.68	Green	P37	11	37	1 7/16	20
LCC1/0-14AWF-X	1	1/0 AWG	1/4	0.63	0.76	1.44	0.12	2.08	Pink	P42	12	42	1 1/2	10
LCC1/0-14BWF-X	1		1/4	0.75	0.76	1.44	0.12	2.20	Pink	P42	12	42	1 1/2	10
LCC1/0-14DWF-X	1		1/4	1.00	0.76	1.44	0.12	2.45	Pink	P42	12	42	1 1/2	10
LCC1/0-38DWF-X	1		3/8	1.00	0.76	1.44	0.12	2.58	Pink	P42	12	42	1 1/2	10
LCC1/0-38WF-X	1		3/8	1.75	0.76	1.44	0.12	3.33	Pink	P42	12	42	1 1/2	10
LCC1/0-12DWF-X	1		1/2	1.00	0.80	1.44	0.12	2.85	Pink	P42	12	42	1 1/2	10
LCC1/0-12WF-X	1	1/2	1.75	0.80	1.44	0.12	3.75	Pink	P42	12	42	1 1/2	10	
LCC2/0-14AWF-X	1	2/0 AWG	1/4	0.63	0.85	1.50	0.13	2.22	Black	P45	13	45	1 9/16	10
LCC2/0-14BWF-X	1		1/4	0.75	0.85	1.50	0.13	2.34	Black	P45	13	45	1 9/16	10
LCC2/0-56DWF-X	1		5/16	1.00	0.85	1.50	0.13	2.59	Black	P45	13	45	1 9/16	10
LCC2/0-38DWF-X	1		3/8	1.00	0.85	1.50	0.13	2.66	Black	P45	13	45	1 9/16	10
LCC2/0-12DWF-X	1		1/2	1.00	0.85	1.50	0.13	2.91	Black	P45	13	45	1 9/16	10
LCC2/0-12WF-X	1		1/2	1.75	0.85	1.50	0.13	3.82	Black	P45	13	45	1 9/16	10
LCC3/0-14BWF-X	1	3/0 AWG	1/4	0.75	0.96	1.50	0.13	2.42	Orange	P50	14	50	1 9/16	10
LCC3/0-56DWF-X	1		5/16	1.00	0.96	1.50	0.13	2.67	Orange	P50	14	50	1 9/16	10
LCC3/0-38DWF-X	1		3/8	1.00	0.96	1.50	0.13	2.73	Orange	P50	14	50	1 9/16	10
LCC3/0-12DWF-X	1		1/2	1.00	0.96	1.50	0.13	2.98	Orange	P50	14	50	1 9/16	10
LCC3/0-12WF-X	1	1/2	1.75	0.96	1.50	0.13	3.89	Orange	P50	14	50	1 9/16	10	
LCC4/0-14AWF-X	1	4/0 AWG	1/4	0.63	1.06	1.56	0.14	2.38	Purple	P54	15	54	1 5/8	10
LCC4/0-14BWF-X	1		1/4	0.75	1.06	1.56	0.14	2.50	Purple	P54	15	54	1 5/8	10
LCC4/0-56DWF-X	1		5/16	1.00	1.06	1.56	0.14	2.77	Purple	P54	15	54	1 5/8	10
LCC4/0-38DWF-X	1		3/8	1.00	1.06	1.56	0.14	2.84	Purple	P54	15	54	1 5/8	10
LCC4/0-38WF-X	1		3/8	1.75	1.06	1.56	0.14	3.59	Purple	P54	15	54	1 5/8	10
LCC4/0-12DWF-X	1		1/2	1.00	1.06	1.56	0.14	3.07	Purple	P54	15	54	1 5/8	10
LCC4/0-12WF-X	1	1/2	1.75	1.06	1.56	0.14	3.98	Purple	P54	15	54	1 5/8	10	

‡See pages D3.62 – D3.65 for tool and die information.

\*\*Consult cable manufacturer for voltage stress relief instructions with applications greater than 2000 V.

◆NEMA hole sizes and spacing.



## Code Conductor, Two-Hole, Long Barrel with Window Lug, 90° Angle (continued)

Part Number	Figure No.	Copper Conductor Size	Stud Hole Size (In.)	Stud Hole Spacing (In.)	Figure Dimensions (In.)				Panduit Color Code	Panduit Die Index No.‡	Burdny Die Index No.‡	T&B Die Index No.‡	Wire Strip Length (In.)	Std. Pkg. Qty.
					W	B	T	L						
LCC250-56DWF-X	1	250 kcmil	5/16	1.00	1.17	1.61	0.14	2.83	Yellow	P62	16	62	1 11/16	10
LCC250-38DWF-X	1		3/8	1.00	1.17	1.61	0.14	2.90	Yellow	P62	16	62	1 11/16	10
LCC250-12DWF-X	1		1/2	1.00	1.17	1.61	0.14	3.13	Yellow	P62	16	62	1 11/16	10
◆ LCC250-12WF-X	1		1/2	1.75	1.17	1.61	0.14	4.04	Yellow	P62	16	62	1 11/16	10
◆ LCC300-38DWF-X	1	300 kcmil	3/8	1.00	1.19	2.24	0.16	2.88	White	P66	17	66	2 5/16	10
◆ LCC300-12WF-X	1		1/2	1.75	1.19	2.24	0.16	4.06	White	P66	17	66	2 5/16	10
◆ LCC350-14BWF-X	1	350 kcmil	1/4	0.75	1.28	2.24	0.17	2.46	Red	P71	18	71	2 5/16	10
◆ LCC350-38DWF-X	1		3/8	1.00	1.28	2.24	0.17	2.94	Red	P71	18	71	2 5/16	10
◆ LCC350-12WF-X	1		1/2	1.75	1.28	2.24	0.17	4.12	Red	P71	18	71	2 5/16	10
◆ LCC400-14BWF-6	1	400 kcmil	1/4	0.75	1.39	2.30	0.18	2.54	Blue	P76	19	76	2 3/8	6
◆ LCC400-38DWF-6	1		3/8	1.00	1.39	2.30	0.18	3.02	Blue	P76	19	76	2 3/8	6
◆ LCC400-12WF-6	1		1/2	1.75	1.39	2.30	0.18	4.20	Blue	P76	19	76	2 3/8	6
◆ LCC500-14BWF-6	1		500 kcmil	1/4	0.75	1.54	2.50	0.22	2.65	Brown	P87	20	87	2 9/16
◆ LCC500-38DWF-6	1	3/8		1.00	1.54	2.50	0.22	3.13	Brown	P87	20	87	2 9/16	6
◆ LCC500-12WF-6	1	1/2		1.75	1.54	2.50	0.22	4.31	Brown	P87	20	87	2 9/16	6
◆ LCC600-38DWF-6	1	600 kcmil	3/8	1.00	1.70	2.69	0.26	3.26	Green	P94	22	94	2 3/4	6
◆ LCC600-12WF-6	1		1/2	1.75	1.70	2.69	0.26	4.44	Green	P94	22	94	2 3/4	6

‡See pages D3.62 – D3.65 for tool and die information.

\*\*Consult cable manufacturer for voltage stress relief instructions with applications greater than 2000 V.

◆NEMA hole sizes and spacing.



## Code Conductor, Two-Hole, Long Barrel with Window, Narrow Tongue Lug

For Use with Stranded Copper Conductors

### Type LCCN-W

- Narrow tongue width for limited space applications
- Long barrel maximizes number of crimps and provides premium wire pull-out strength and electrical performance
- Inspection window to visually assure full conductor insertion
- Color-coded barrels marked with Panduit and specified competitor die index numbers for proper crimp die selection
- Tin-plated to inhibit corrosion

- UL Listed and CSA Certified to 35 KV\*\* and temperature rated to 90°C when crimped with Panduit and specified competitor crimping tools and dies
- UL Listed and CSA Certified for wide wire range-taking capability when crimped with Panduit® Uni-Die™ Dieless Crimping Tools‡
- **Tested by Telcordia – meets NEBS Level 3**
- Meets J-STD-607-A and TIA-942 requirements for network systems grounding applications
- Available with NEMA hole sizes and spacing

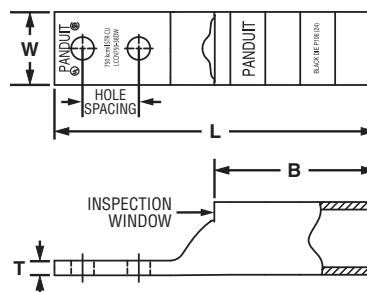

Part Number	Copper Conductor Size	Stud Hole Size (In.)	Stud Hole Spacing (In.)	Figure Dimensions (In.)				Panduit Color Code	Panduit Die Index No.‡	Burdny Die Index No.‡	T&B Die Index No.‡	Wire Strip Length (In.)	Std. Pkg. Qty.
				W	B	T	L						
◆ LCCN750-38DW-6	750 kcmil	3/8	1.00	1.30	2.88	0.28	5.72	Black	P106	24	106	2 15/16	6
◆ LCCN750-12W-6	750 kcmil	1/2	1.75	1.30	2.88	0.28	6.66	Black	P106	24	106	2 15/16	6

‡See pages D3.62 – D3.65 for tool and die information.

\*\*Consult cable manufacturer for voltage stress relief instructions with applications greater than 2000 V.

◆NEMA hole sizes and spacing.

A. System Overview



## Code Conductor, Two-Hole, Long Barrel with Corona Relief Taper Lug

B1. Cable Ties

**To Facilitate Use with Stranded Copper Conductors in Applications of 5000 V or More**

### Type LCCH

B2. Cable Accessories

- Externally chamfered barrel end inhibits Corona effect when used in high voltage applications
- Long barrel maximizes number of crimps and provides premium wire pull-out strength and electrical performance
- Color-coded barrels marked with Panduit and specified competitor die index numbers for proper crimp die selection
- Enclosed barrel prevents corrosive material from entering barrel when used in harsh environments
- Tin-plated to inhibit corrosion
- UL Listed and CSA Certified to 35 KV\*\* and temperature rated to 90°C when crimped with Panduit and specified competitor crimping tools and dies
- Available with NEMA hole sizes and spacing

B3. Stainless Steel Ties

C1. Wiring Duct



C2. Surface Raceway



Corona Relief Taper

C3. Abrasion Protection

C4. Cable Management

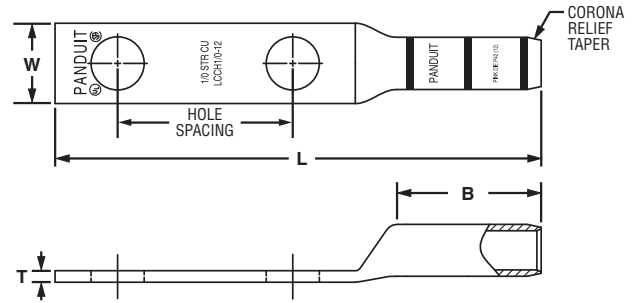

D1. Terminals

D2. Power Connectors

D3. Grounding Connectors

Part Number	Copper Conductor Size	Stud Hole Size (In.)	Stud Hole Spacing (In.)	Figure Dimensions (In.)				Panduit Color Code	Panduit Die Index No.‡	Burdny Die Index No.‡	T&B Die Index No.‡	Wire Strip Length (In.)	Std. Pkg. Qty.
				W	B	T	L						
LCCH1/0-12-X	1/0 AWG	1/2	1.75	0.80	1.44	0.12	4.86	Pink	P42	12	42	1 1/2	10
LCCH2/0-12-X	2/0 AWG	1/2	1.75	0.85	1.50	0.13	4.98	Black	P45	13	45	1 9/16	10
LCCH3/0-12-X	3/0 AWG	1/2	1.75	0.96	1.50	0.13	5.03	Orange	P50	14	50	1 9/16	10
◆ LCCH4/0-12-X	4/0 AWG	1/2	1.75	1.06	1.56	0.14	5.13	Purple	P54	15	54	1 5/8	10
◆ LCCH250-12-X	250 kcmil	1/2	1.75	1.17	1.61	0.14	5.23	Yellow	P62	16	62	1 1/16	10
◆ LCCH300-12-X	300 kcmil	1/2	1.75	1.19	2.24	0.16	5.94	White	P66	17	66	2 5/16	10
◆ LCCH350-12-X	350 kcmil	1/2	1.75	1.28	2.24	0.17	5.99	Red	P71	18	71	2 5/16	10
◆ LCCH400-12-6	400 kcmil	1/2	1.75	1.39	2.30	0.18	6.10	Blue	P76	19	76	2 3/8	6
◆ LCCH500-12-6	500 kcmil	1/2	1.75	1.54	2.50	0.22	6.36	Brown	P87	20	87	2 9/16	6
◆ LCCH600-12-6	600 kcmil	1/2	1.75	1.70	2.69	0.26	6.63	Green	P94	22	94	2 3/4	6
◆ LCCH750-12-6	750 kcmil	1/2	1.75	1.89	2.88	0.26	7.04	Black	P106	24	106	2 15/16	6
◆ LCCH1000-12-3	1000 kcmil	1/2	1.75	2.17	3.00	0.32	7.29	White	P125	27	125	3 1/16	3

‡See pages D3.66, D3.67 for tool and die information.

\*\*Consult cable manufacturer for voltage stress relief instructions with applications greater than 2000 V.

◆NEMA hole sizes and spacing.

E1. Labeling Systems

E2. Labels

E3. Pre-Printed & Write-On Markers

E4. Permanent Identification

E5. Lockout/Tagout & Safety Solutions

F. Index



## Code Conductor, Blank Tongue, Long Barrel Lug

For Use with Stranded Copper Conductors

### Type LCC-00

- Long barrel maximizes number of crimps and provides premium wire pull-out strength and electrical performance
- Color-coded barrels marked with Panduit and specified competitor die index numbers for proper crimp die selection
- Enclosed barrel prevents corrosive material from entering barrel when used in harsh environments
- Tin-plated to inhibit corrosion
- UL Recognized and CSA Certified to 35 KV\*\* and temperature rated to 90°C when crimped with Panduit and specified competitor crimping tools and dies

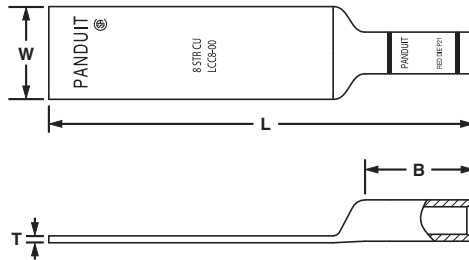

Figure 1



Figure 2: Two-Piece Brazed Tongue Construction

Part Number	Figure No.	Copper Conductor Size	Figure Dimensions (In.)				Panduit Color Code	Panduit Die Index No.	Burdny Die Index No.‡	T&B Die Index No.‡	Wire Strip Length (In.)	Std. Pkg. Qty.
			W	B	T	L						
LCC8-00-L	1	#8 AWG	0.60	0.70	0.05	2.75	Red	P21	49	21	3/4	50
LCC6-00-L	2	#6 AWG	0.75	1.13	0.16	5.00	Blue	P24	7	24	1 1/8	50
LCC4-00-L	2	#4 – #3 AWG STR, #2 AWG SOL	0.75	1.13	0.16	5.06	Gray	P29	8	29	1 1/8	50
LCC2-00-Q	1	#2 AWG	0.75	1.16	0.08	4.51	Brown	P33	10	33	1 1/4	25
LCC1-00-E	1	#1 AWG	0.75	1.36	0.09	4.74	Green	P37	11	37	1 7/16	20
LCC1/0-00-X	1	1/0 AWG	0.80	1.44	0.12	4.86	Pink	P42	12	42	1 1/2	10
LCC2/0-00-X	1	2/0 AWG	0.85	1.50	0.13	4.98	Black	P45	13	45	1 9/16	10
LCC3/0-00-X	1	3/0 AWG	0.96	1.50	0.13	5.03	Orange	P50	14	50	1 9/16	10
LCC4/0-00-X	1	4/0 AWG	1.06	1.56	0.14	5.13	Purple	P54	15	54	1 5/8	10
LCC250-00-X	1	250 kcmil	1.17	1.60	0.14	5.23	Yellow	P62	16	62	1 11/16	10
LCC300-00-X	1	300 kcmil	1.19	2.23	0.16	5.94	White	P66	17	66	2 5/16	10
LCC350-00-X	1	350 kcmil	1.28	2.23	0.17	5.99	Red	P71	18	71	2 5/16	10
LCC400-00-6	1	400 kcmil	1.39	2.29	0.18	6.10	Blue	P76	19	76	2 3/8	6
LCC500-00-6	1	500 kcmil	1.54	2.49	0.22	6.36	Brown	P87	20	87	2 9/16	6
LCC600-00-6	1	600 kcmil	1.70	2.68	0.26	6.63	Green	P94	22	94	2 3/4	6
LCC750-00-6	1	750 kcmil	1.89	2.87	0.26	7.04	Black	P106	24	106	2 15/16	6
LCC1000-00-3	1	1000 kcmil	2.17	2.99	0.32	7.29	White	P125	27	125	3 1/16	3

‡See pages D3.62 – D3.65 for tool and die information.

\*\*Consult cable manufacturer for voltage stress relief instructions with applications greater than 2000 V.

A. System Overview

B1. Cable Ties

B2. Cable Accessories

B3. Stainless Steel Ties

C1. Wiring Duct

C2. Surface Raceway

C3. Abrasion Protection

C4. Cable Management

D1. Terminals

D2. Power Connectors

D3. Grounding Connectors

E1. Labeling Systems

E2. Labels

E3. Pre-Printed & Write-On Markers

E4. Permanent Identification

E5. Lockout/Tagout & Safety Solutions

F. Index

A. System Overview



## Code Conductor, Blank Tongue, Long Barrel with Window Lug

B1. Cable Ties

### For Use with Stranded Copper Conductors Type LCC-00W

B2. Cable Accessories

B3. Stainless Steel Ties

- Long barrel maximizes number of crimps and provides premium wire pull-out strength and electrical performance
- Inspection window to visually assure full conductor insertion
- Color-coded barrels marked with Panduit and specified competitor die index numbers for proper crimp die selection
- Enclosed barrel prevents corrosive material from entering barrel when used in harsh environments
- Tin-plated to inhibit corrosion
- UL Recognized and CSA Certified to 35 KV\*\* and temperature rated to 90°C when crimped with Panduit and specified competitor crimping tools and dies

C1. Wiring Duct



C2. Surface Raceway

C3. Abrasion Protection



C4. Cable Management

Part Number	Copper Conductor Size	Figure Dimensions (In.)				Panduit Color Code	Panduit Die Index No.‡	Burdny Die Index No.‡	T&B Die Index No.‡	Wire Strip Length (In.)	Std. Pkg. Qty.
		W	B	T	L						
<b>LCC8-00W-L</b>	#8 AWG	0.60	0.70	0.05	2.70	Red	P21	49	21	3/4	50
<b>LCC6-00W-L</b>	#6 AWG	0.62	1.07	0.06	3.08	Blue	P24	7	24	1 1/8	50
<b>LCC4-00W-L</b>	#4 AWG	0.62	1.05	0.08	3.09	Gray	P29	8	29	1 1/8	50
<b>LCC2-00W-Q</b>	#2 AWG	0.75	1.16	0.08	4.41	Brown	P33	10	33	1 1/4	25
<b>LCC1-00W-E</b>	#1 AWG	0.75	1.36	0.09	4.63	Green	P37	11	37	1 7/16	20
<b>LCC1/0-00W-X</b>	1/0 AWG	0.80	1.44	0.12	4.74	Pink	P42	12	42	1 1/2	10
<b>LCC2/0-00W-X</b>	2/0 AWG	0.85	1.50	0.13	4.83	Black	P45	13	45	1 9/16	10
<b>LCC3/0-00W-X</b>	3/0 AWG	0.96	1.50	0.13	4.87	Orange	P50	14	50	1 9/16	10
<b>LCC4/0-00W-X</b>	4/0 AWG	1.06	1.56	0.14	4.95	Purple	P54	15	54	1 5/8	10
<b>LCC250-00W-X</b>	250 kcmil	1.17	1.61	0.14	5.04	Yellow	P62	16	62	1 11/16	10
<b>LCC300-00W-X</b>	300 kcmil	1.19	2.24	0.16	5.73	White	P66	17	66	2 5/16	10
<b>LCC350-00W-X</b>	350 kcmil	1.28	2.24	0.17	5.77	Red	P71	18	71	2 5/16	10
<b>LCC400-00W-6</b>	400 kcmil	1.28	2.30	0.17	5.85	Blue	P76	19	76	2 3/8	6
<b>LCC500-00W-6</b>	500 kcmil	1.54	2.50	0.22	6.13	Brown	P87	20	87	2 9/16	6
<b>LCC600-00W-6</b>	600 kcmil	1.70	2.69	0.26	6.37	Green	P94	22	94	2 3/4	6

‡See pages D3.62 – D3.65 for tool and die information.

\*\*Consult cable manufacturer for voltage stress relief instructions with applications greater than 2000 V.

E2. Labels

E3. Pre-Printed & Write-On Markers

E4. Permanent Identification

E5. Lockout/Tagout & Safety Solutions

F. Index





## Code Conductor, Short Barrel, Butt Splice

**For Use with Stranded Copper Conductors**

### Type SCSS

- Short barrel for limited space applications
- Color-coded barrels marked with Panduit and specified competitor die index numbers for proper crimp die selection
- Internal wire stops to prevent over-insertion of conductor
- Tin-plated to inhibit corrosion
- UL Listed and CSA Certified to 35 KV\*\* and temperature rated to 90°C when crimped with Panduit and specified competitor crimping tools and dies
- Tested by Telcordia – meets NEBS Level 3



Part Number	Copper Conductor Size	Figure Dimensions (In.)		Panduit Color Code	Panduit Die Index No.‡	Burdy Die Index No.‡	T&B Die Index No.‡	Wire Strip Length (In.)	Std. Pkg. Qty.
		Barrel O.D.	L						
SCSS8-L	#8 AWG	0.27	1.00	Red	P21	49	21	7/16	50
SCSS6-L	#6 AWG	0.31	1.00	Blue	P24	7	24	7/16	50
SCSS4-L	#4 AWG	0.38	1.00	Gray	P29	8	29	7/16	50
SCSS2-Q	#2 AWG	0.42	1.25	Brown	P33	10	33	9/16	25
SCSS1-Q	#1 AWG	0.46	1.44	Green	P37	11	37	11/16	25
SCSS1/0-X	1/0 AWG	0.52	1.44	Pink	P42	12	42	11/16	10
SCSS2/0-X	2/0 AWG	0.58	1.56	Black	P45	13	45	3/4	10
SCSS3/0-X	3/0 AWG	0.64	1.69	Orange	P50	14	50	3/4	10
SCSS4/0-X	4/0 AWG	0.71	1.81	Purple	P54	15	54	13/16	10
SCSS250-X	250 kcmil	0.77	2.19	Yellow	P62	16	62	1 1/16	10

‡See pages D3.56, D3.57 for tool and die information.

\*\*Consult cable manufacturer for voltage stress relief instructions with applications greater than 2000 V.

A.  
System  
Overview

B1.  
Cable Ties

B2.  
Cable  
Accessories

B3.  
Stainless  
Steel Ties

C1.  
Wiring  
Duct

C2.  
Surface  
Raceway

C3.  
Abrasion  
Protection

C4.  
Cable  
Management

D1.  
Terminals

D2.  
Power  
Connectors

D3.  
Grounding  
Connectors

E1.  
Labeling  
Systems

E2.  
Labels

E3.  
Pre-Printed  
& Write-On  
Markers

E4.  
Permanent  
Identification

E5.  
Lockout/  
Tagout  
& Safety  
Solutions

F.  
Index

A. System Overview



## Code Conductor, Standard Barrel, Butt Splice

B1. Cable Ties

### For Use with Stranded Copper Conductors

#### Type SCS

- Color-coded barrels marked with Panduit and specified competitor die index numbers for proper crimp die selection
- Internal wire stops to prevent over-insertion of conductor
- Tin-plated to inhibit corrosion
- UL Listed and CSA Certified to 35 KV\*\* and temperature rated to 90°C when crimped with Panduit and specified competitor crimping tools and dies
- UL Listed and CSA Certified for wide wire range-taking capability when crimped with Panduit® Uni-Die™ Dieless Crimping Tools‡
- Tested by Telcordia – meets NEBS Level 3
- American Bureau of Shipping approved

B2. Cable Accessories

B3. Stainless Steel Ties

C1. Wiring Duct

C2. Surface Raceway

C3. Abrasion Protection

C4. Cable Management

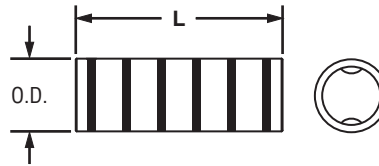

D1. Terminals

D2. Power Connectors

D3. Grounding Connectors

E1. Labeling Systems

E2. Labels

E3. Pre-Printed & Write-On Markers

E4. Permanent Identification

E5. Lockout/Tagout & Safety Solutions

F. Index

Part Number	Copper Conductor Size	Figure Dimensions (In.)		Panduit Color Code	Panduit Die Index No.‡	Burndy Die Index No.‡	T&B Die Index No.‡	Wire Strip Length (In.)	Std. Pkg. Qty.
		Barrel O.D.	L						
<b>SCS8-L</b>	#8 AWG	0.27	1.50	Red	P21	49	21	11/16	50
<b>SCS6-L</b>	#6 AWG	0.31	1.75	Blue	P24	7	24	13/16	50
<b>SCS4-L</b>	#4 – #3 AWG STR, #2 AWG SOL	0.38	1.75	Gray	P29	8	29	13/16	50
<b>SCS2-Q</b>	#2 AWG	0.42	1.87	Brown	P33	10	33	7/8	25
<b>SCS1-E</b>	#1 AWG	0.47	1.87	Green	P37	11	37	7/8	20
<b>SCS1/0-X</b>	1/0 AWG	0.52	1.87	Pink	P42	12	42	7/8	10
<b>SCS2/0-X</b>	2/0 AWG	0.58	2.00	Black	P45	13	45	15/16	10
<b>SCS3/0-X</b>	3/0 AWG	0.64	2.12	Orange	P50	14	50	1	10
<b>SCS4/0-X</b>	4/0 AWG	0.71	2.12	Purple	P54	15	54	1	10
<b>SCS250-X</b>	250 kcmil	0.77	2.25	Yellow	P62	16	62	1 1/16	10
<b>SCS300-X</b>	300 kcmil	0.81	2.25	White	P66	17	66	1 1/16	10
<b>SCS350-X</b>	350 kcmil	0.87	2.37	Red	P71	18	71	1 1/8	10
<b>SCS400-6</b>	400 kcmil	0.95	2.50	Blue	P76	19	76	1 3/16	6
<b>SCS500-6</b>	500 kcmil	1.05	2.87	Brown	P87	20	87	1 3/8	6
<b>SCS600-6</b>	600 kcmil	1.18	2.87	Green	P94	22	94	1 3/8	6
<b>SCS750-6</b>	750 kcmil	1.29	3.37	Black	P106	24	106	1 5/8	6
<b>SCS1000-3</b>	1000 kcmil	1.50	3.87	White	P125	27	125	1 7/8	3

‡See pages D3.58 – D3.61 for tool and die information.

\*\*Consult cable manufacturer for voltage stress relief instructions with applications greater than 2000 V.



## Code Conductor, Long Barrel, Butt Splice

For Use with Stranded Copper Conductors

### Type SCL

- Long barrel maximizes the number of crimps and provides premium wire pull-out strength and electrical performance
- Color-coded barrels marked with Panduit and specified competitor die index numbers for proper crimp die selection
- Internal wire stops to prevent over-insertion of conductor
- Tin-plated to inhibit corrosion
- UL Listed and CSA Certified to 35 KV\*\* and temperature rated to 90°C when crimped with Panduit and specified competitor crimping tools and dies
- UL Listed and CSA Certified for wide wire range-taking capability when crimped with Panduit® Uni-Die™ Dieless Crimping Tools‡
- Tested by Telcordia – meets NEBS Level 3

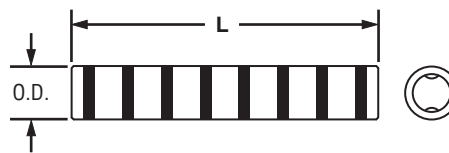

Part Number	Copper Conductor Size	Figure Dimensions (In.)		Panduit Color Code	Panduit Die Index No.‡	Burdny Die Index No.‡	T&B Die Index No.‡	Wire Strip Length (In.)	Std. Pkg. Qty.
		Barrel O.D.	L						
SCL8-L	#8 AWG	0.27	2.25	Red	P21	49	21	1 1/16	50
SCL6-L	#6 AWG	0.31	2.38	Blue	P24	7	24	1 1/8	50
SCL4-L	#4 – #3 AWG STR, #2 AWG SOL	0.38	2.38	Gray	P29	8	29	1 1/8	50
SCL2-Q	#2 AWG	0.42	2.62	Brown	P33	10	33	1 1/4	25
SCL1-E	#1 AWG	0.47	2.87	Green	P37	11	37	1 3/8	20
SCL1/0-X	1/0 AWG	0.52	2.87	Pink	P42	12	42	1 3/8	10
SCL2/0-X	2/0 AWG	0.58	3.13	Black	P45	13	45	1 1/2	10
SCL3/0-X	3/0 AWG	0.64	3.12	Orange	P50	14	54	1 1/2	10
SCL4/0-X	4/0 AWG	0.71	3.37	Purple	P54	15	54	1 5/8	10
SCL250-X	250 kcmil	0.77	3.38	Yellow	P62	16	62	1 5/8	10
SCL300-X	300 kcmil	0.81	4.12	White	P66	17	66	2	10
SCL350-X	350 kcmil	0.88	4.12	Red	P71	18	71	2	10
SCL400-6	400 kcmil	0.95	4.37	Blue	P76	19	76	2 1/8	6
SCL500-6	500 kcmil	1.06	4.62	Brown	P87	20	87	2 1/4	6
SCL600-6	600 kcmil	1.19	5.50	Green	P94	22	94	2 11/16	6
SCL750-6	750 kcmil	1.30	5.87	Black	P106	24	106	2 7/8	6
SCL1000-3	1000 kcmil	1.50	6.12	White	P125	27	125	3	3

‡See pages D3.62 – D3.65 for tool and die information.

\*\*Consult cable manufacturer for voltage stress relief instructions with applications greater than 2000 V.

A. System Overview

B1. Cable Ties

B2. Cable Accessories

B3. Stainless Steel Ties

C1. Wiring Duct

C2. Surface Raceway

C3. Abrasion Protection

C4. Cable Management

D1. Terminals

D2. Power Connectors

D3. Grounding Connectors

E1. Labeling Systems

E2. Labels

E3. Pre-Printed & Write-On Markers

E4. Permanent Identification

E5. Lockout/Tagout & Safety Solutions

F. Index

A. System Overview



## Code Conductor, Long Barrel with Corona Relief Taper Splice

B1. Cable Ties

**To Facilitate Use with Stranded Copper Conductors in Applications of 5000 V or More**

### Type SCH

B2. Cable Accessories

- Externally chamfered barrel end inhibits Corona effect when used in high voltage applications
- Color-coded barrels marked with Panduit and specified competitor die index numbers for proper crimp die selection
- Internal wire stops to prevent over-insertion of conductor
- Tin-plated to inhibit corrosion
- UL Listed and CSA Certified to 35 KV\*\* and temperature rated to 90°C when crimped with Panduit and specified competitor crimping tools and dies

B3. Stainless Steel Ties

C1. Wiring Duct



C2. Surface Raceway

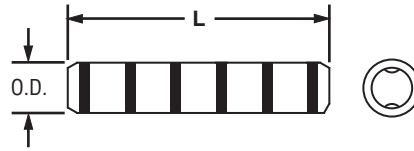

C3. Abrasion Protection

C4. Cable Management

Part Number	Copper Conductor Size	Figure Dimensions (In.)		Panduit Color Code	Panduit Die Index No.‡	Burdny Die Index No.‡	T&B Die Index No.‡	Wire Strip Length (In.)	Std. Pkg. Qty.
		Barrel O.D.	L						
SCH6-L	#6 AWG	0.31	1.97	Blue	P24	7	24	15/16	50
SCH4-L	#4 AWG	0.38	1.97	Gray	P29	8	29	15/16	50
SCH2-Q	#2 AWG	0.42	2.13	Brown	P33	10	33	1	25
SCH1-E	#1 AWG	0.47	2.13	Green	P37	11	37	1	20
SCH1/0-X	1/0 AWG	0.52	2.13	Pink	P42	12	42	1	10
SCH2/0-X	2/0 AWG	0.58	2.28	Black	P45	13	45	1 1/16	10
SCH3/0-X	3/0 AWG	0.64	2.47	Orange	P50	14	50	1 3/16	10
SCH4/0-X	4/0 AWG	0.71	2.54	Purple	P54	15	54	1 3/16	10
SCH250-X	250 kcmil	0.77	2.63	Yellow	P62	16	62	1 1/4	10
SCH300-X	300 kcmil	0.82	2.69	White	P66	17	66	2	10
SCH350-X	350 kcmil	0.88	2.84	Red	P71	18	71	2	10
SCH500-6	500 kcmil	1.06	3.53	Brown	P87	20	87	2 1/4	6
SCH750-6	750 kcmil	1.30	4.28	Black	P106	24	106	2 7/8	6
SCH1000-3	1000 kcmil	1.50	5.06	White	P125	27	125	3	3

‡See pages D3.66, D3.67 for tool and die information.

\*\*Consult cable manufacturer for voltage stress relief instructions with applications greater than 2000 V.

E2. Labels

E3. Pre-Printed & Write-On Markers

E4. Permanent Identification

E5. Lockout/Tagout & Safety Solutions

F. Index

## Code Conductor, Long Barrel, T Splice

### For Copper-to-Copper Stranded Conductors

#### Type SCT

- Provides a means of connecting the run conductor and taking off a perpendicular tap
- Long barrel maximizes number of crimps and provides premium wire pull-out strength and electrical performance

- Run conductor size and tap conductor size marked on each barrel
- 90°C temperature rated and for use up to 600 V when crimped with Panduit and specified competitor crimping tools and dies



Part Number	Copper Conductor Size		Run O.D.	Tap O.D.	Figure Dimensions (In.)		Panduit Color Code and Die Index No.‡		Wire Strip Length (In.)		Std. Pkg. Qty.
	Run	Tap			H	L	Run	Tap	Run	Tap	
	SCT2-2	#2 AWG			#2 AWG	0.42	0.42	1.50	3.88	Brown P33	
SCT1/0-1/0	1/0 AWG	1/0 AWG	0.51	0.51	1.50	4.00	Pink P42	Pink P42	2 1/16	1 9/16	1
SCT2/0-2/0	2/0 AWG	2/0 AWG	0.56	0.56	1.50	4.00	Black P45	Black P45	2 1/16	1 9/16	1
SCT4/0-1/0	4/0 AWG	1/0 AWG	0.69	0.51	1.50	4.00	Purple P54	Pink P42	2 1/16	1 9/16	1
SCT4/0-4/0	4/0 AWG	4/0 AWG	0.69	0.69	1.63	4.19	Purple P54	Purple P54	2 1/8	1 11/16	1
SCT250-250	250 kcmil	250 kcmil	0.75	0.75	1.63	4.25	Yellow P62	Yellow P62	2 3/16	1 11/16	1
SCT300-300	300 kcmil	300 kcmil	0.81	0.81	2.00	5.44	White P66	White P66	2 13/16	2 1/16	1
SCT350-350	350 kcmil	350 kcmil	0.88	0.88	2.00	5.50	Red P71	Red P71	2 13/16	2 1/16	1
SCT500-4/0	500 kcmil	4/0 AWG	1.06	0.69	2.25	5.81	Brown P87	Purple P54	2 15/16	2 5/16	1
SCT500-500	500 kcmil	500 kcmil	1.06	1.06	2.50	6.06	Brown P87	Brown P87	3 1/8	2 9/16	1

‡See pages D3.68, D3.69 for Panduit, Burndy and Thomas and Betts tool and die information.

A. System Overview

B1. Cable Ties

B2. Cable Accessories

B3. Stainless Steel Ties

C1. Wiring Duct

C2. Surface Raceway

C3. Abrasion Protection

C4. Cable Management

D1. Terminals

D2. Power Connectors

D3. Grounding Connectors

E1. Labeling Systems

E2. Labels

E3. Pre-Printed & Write-On Markers

E4. Permanent Identification

E5. Lockout/Tagout & Safety Solutions

F. Index

A. System Overview



## Code Conductor, Color-Coded Parallel Splice

B1. Cable Ties

### For Use with Stranded Copper Conductors

#### Type PSC

- Industry recognized color-coding allows proper part selection and quick identification of crimping dies to speed installation
- Large easy-to-read part numbering for verification in demanding low light conditions
- Tin-plated to inhibit corrosion
- UL Listed and CSA Certified to 35 KV\*\* and temperature rated to 90°C when crimped with Panduit dieless and die type crimping tools
- Single crimp design speeds installation and reduces labor costs
- Chamfered on both ends to facilitate fast and easy conductor insertion to speed installation

B2. Cable Accessories

B3. Stainless Steel Ties

C1. Wiring Duct

C2. Surface Raceway

C3. Abrasion Protection

C4. Cable Management

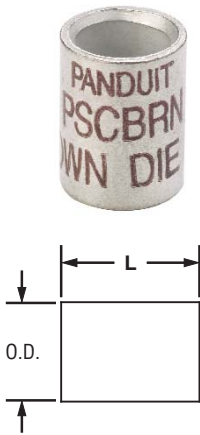

Part Number	Figure Dimensions (In.)		Panduit Color Code	Panduit Die Index No.‡	Wire Strip Length (In.)	Std. Pkg. Qty.
	Barrel O.D.	L				
PSCRED-L	0.27	0.50	Red	P21	7/16	50
PSCBLU-L	0.31	0.50	Blue	P24	7/16	50
PSCGRY-L	0.38	0.50	Gray	P29	7/16	50
PSCBRN-L	0.47	0.62	Brown	P33	11/16	50
PSCGRN-L	0.52	0.62	Green	P37	11/16	50
PSCPNK-L	0.58	0.62	Pink	P42	11/16	50
PSCBLK-Q	0.64	0.81	Black	P45	7/8	25
PSCORG-Q	0.71	0.81	Orange	P50	7/8	25
PSCPUR-Q	0.77	0.88	Purple	P54	1	25
PSCYEL-Q	0.81	1.05	Yellow	P62	1 1/16	25

‡See page D3.82 for tool and die information. For smaller wires sizes, see pages D1.65 – D1.69.

For heat shrink end caps and tubing see pages C3.35 – C3.42.

For thermal transfer labeling solutions see pages E1.1 – E2.22.

\*\*Consult cable manufacturer for voltage stress relief instructions with applications greater than 2000 V.

D1. Terminals

D2. Power Connectors

D3. Grounding Connectors

E1. Labeling Systems

E2. Labels

E3. Pre-Printed & Write-On Markers

E4. Permanent Identification

E5. Lockout/Tagout & Safety Solutions

F. Index

## Copper Compression Parallel Splice

### How to Use This Guide

**Example:** (3) #14 AWG wires

(2) #12 AWG wires

- In Table 1 find #14 AWG wire size and # of wires on vertical axis.
- Find #12 AWG wire size and # of wires on horizontal axis.
- Find the intersection of ① and ② to identify the correct color coded splice, which corresponds to the part number in Table 2.   blue = PSCBLU-L
- See tool chart on page D3.78 for proper die index number, wire strip length, and number of crimps.



Part Number	Barrel O.D. (In.)	Length (In.)	Panduit Color Code	Panduit Die Index No.	Std. Pkg. Qty.
PSCRED-L	0.27	0.50	Red	P21	50
PSCBLU-L	0.31	0.50	Blue	P24	50
PSCGRY-L	0.38	0.50	Gray	P29	50
PSCBRN-L	0.47	0.62	Brown	P33	50
PSCGRN-L	0.52	0.62	Green	P37	50
PSCPnk-L	0.58	0.62	Pink	P42	50
PSCBLK-Q	0.64	0.81	Black	P45	25
PSCORG-Q	0.71	0.81	Orange	P50	25
PSCPUR-Q	0.77	0.88	Purple	P54	25
PSCYEL-Q	0.81	1.05	Yellow	P62	25

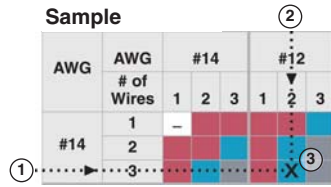

Table 2

AWG	AWG # of Wires	#14			#12			#10			#8			#6			#4			#2			#1			1/0			2/0			3/0		
		1	2	3	1	2	3	1	2	3	1	2	3	1	2	3	1	2	3	1	2	3	1	2	3	1	2	3	1	2	3	1	2	3
#14	1	-	-	-	-	-	-	-	-	-	-	-	-	-	-	-	-	-	-	-	-	-	-	-	-	-	-	-	-	-	-	-		
	2	-	-	-	-	-	-	-	-	-	-	-	-	-	-	-	-	-	-	-	-	-	-	-	-	-	-	-	-	-	-	-		
	3	-	-	-	-	-	-	-	-	-	-	-	-	-	-	-	-	-	-	-	-	-	-	-	-	-	-	-	-	-	-	-		
#12	1	-	-	-	-	-	-	-	-	-	-	-	-	-	-	-	-	-	-	-	-	-	-	-	-	-	-	-	-	-	-	-		
	2	-	-	-	-	-	-	-	-	-	-	-	-	-	-	-	-	-	-	-	-	-	-	-	-	-	-	-	-	-	-	-		
	3	-	-	-	-	-	-	-	-	-	-	-	-	-	-	-	-	-	-	-	-	-	-	-	-	-	-	-	-	-	-	-		
#10	1	-	-	-	-	-	-	-	-	-	-	-	-	-	-	-	-	-	-	-	-	-	-	-	-	-	-	-	-	-	-	-		
	2	-	-	-	-	-	-	-	-	-	-	-	-	-	-	-	-	-	-	-	-	-	-	-	-	-	-	-	-	-	-	-		
	3	-	-	-	-	-	-	-	-	-	-	-	-	-	-	-	-	-	-	-	-	-	-	-	-	-	-	-	-	-	-	-		
#8	1	-	-	-	-	-	-	-	-	-	-	-	-	-	-	-	-	-	-	-	-	-	-	-	-	-	-	-	-	-	-	-		
	2	-	-	-	-	-	-	-	-	-	-	-	-	-	-	-	-	-	-	-	-	-	-	-	-	-	-	-	-	-	-	-		
	3	-	-	-	-	-	-	-	-	-	-	-	-	-	-	-	-	-	-	-	-	-	-	-	-	-	-	-	-	-	-	-		
#6	1	-	-	-	-	-	-	-	-	-	-	-	-	-	-	-	-	-	-	-	-	-	-	-	-	-	-	-	-	-	-	-		
	2	-	-	-	-	-	-	-	-	-	-	-	-	-	-	-	-	-	-	-	-	-	-	-	-	-	-	-	-	-	-	-		
	3	-	-	-	-	-	-	-	-	-	-	-	-	-	-	-	-	-	-	-	-	-	-	-	-	-	-	-	-	-	-	-		
#4	1	-	-	-	-	-	-	-	-	-	-	-	-	-	-	-	-	-	-	-	-	-	-	-	-	-	-	-	-	-	-	-		
	2	-	-	-	-	-	-	-	-	-	-	-	-	-	-	-	-	-	-	-	-	-	-	-	-	-	-	-	-	-	-	-		
	3	-	-	-	-	-	-	-	-	-	-	-	-	-	-	-	-	-	-	-	-	-	-	-	-	-	-	-	-	-	-	-		
#2	1	-	-	-	-	-	-	-	-	-	-	-	-	-	-	-	-	-	-	-	-	-	-	-	-	-	-	-	-	-	-	-		
	2	-	-	-	-	-	-	-	-	-	-	-	-	-	-	-	-	-	-	-	-	-	-	-	-	-	-	-	-	-	-	-		
	3	-	-	-	-	-	-	-	-	-	-	-	-	-	-	-	-	-	-	-	-	-	-	-	-	-	-	-	-	-	-	-		
#1	1	-	-	-	-	-	-	-	-	-	-	-	-	-	-	-	-	-	-	-	-	-	-	-	-	-	-	-	-	-	-	-		
	2	-	-	-	-	-	-	-	-	-	-	-	-	-	-	-	-	-	-	-	-	-	-	-	-	-	-	-	-	-	-	-		
	3	-	-	-	-	-	-	-	-	-	-	-	-	-	-	-	-	-	-	-	-	-	-	-	-	-	-	-	-	-	-	-		
1/0	1	-	-	-	-	-	-	-	-	-	-	-	-	-	-	-	-	-	-	-	-	-	-	-	-	-	-	-	-	-	-	-		
	2	-	-	-	-	-	-	-	-	-	-	-	-	-	-	-	-	-	-	-	-	-	-	-	-	-	-	-	-	-	-	-		
	3	-	-	-	-	-	-	-	-	-	-	-	-	-	-	-	-	-	-	-	-	-	-	-	-	-	-	-	-	-	-	-		
2/0	1	-	-	-	-	-	-	-	-	-	-	-	-	-	-	-	-	-	-	-	-	-	-	-	-	-	-	-	-	-	-	-		
	2	-	-	-	-	-	-	-	-	-	-	-	-	-	-	-	-	-	-	-	-	-	-	-	-	-	-	-	-	-	-	-		
	3	-	-	-	-	-	-	-	-	-	-	-	-	-	-	-	-	-	-	-	-	-	-	-	-	-	-	-	-	-	-	-		
3/0	1	-	-	-	-	-	-	-	-	-	-	-	-	-	-	-	-	-	-	-	-	-	-	-	-	-	-	-	-	-	-	-		
	2	-	-	-	-	-	-	-	-	-	-	-	-	-	-	-	-	-	-	-	-	-	-	-	-	-	-	-	-	-	-	-		
	3	-	-	-	-	-	-	-	-	-	-	-	-	-	-	-	-	-	-	-	-	-	-	-	-	-	-	-	-	-	-	-		

Table 1

A. System Overview



## Flex Conductor, One-Hole, Standard Barrel with Window Lug

B1. Cable Ties

**For Use with Flexible, Extra-Flexible, and Code Stranded Copper Conductors**

### Type LCAX

- Can be used with code conductor and flex conductor class: G, H, I, K, M and Diesel Locomotive
- Generously beveled wire entry prevents bent back strands when inserting conductor into barrel
- Color-coded barrels marked with Panduit and specified competitor die index numbers for proper crimp die selection
- Inspection window to visually assure full conductor insertion
- Tin-plated to inhibit corrosion
- UL Listed and CSA Certified to 35 KV\*\* and temperature rated to 90°C when crimped with Panduit and specified competitor crimping tools and dies
- American Bureau of Shipping approved

B2. Cable Accessories

B3. Stainless Steel Ties

C1. Wiring Duct



C2. Surface Raceway

C3. Abrasion Protection

C4. Cable Management



Part Number	Flex Conductor Size		Code Conductor Size	Stud Hole Size (In.)	Figure Dimensions (In.)				Panduit Color Code	Panduit Die Index No.‡	Burdny Die Index No.‡	T&B Die Index No.‡	Wire Strip Length (In.)	Std. Pkg. Qty.
	Class G, H, I, K, M	Diesel Locomotive			W	B	T	L						
LCAX8-10-L	#8 AWG	#8 AWG	#8 AWG	#10	0.41	0.42	0.08	1.11	Red	P21	49	21	1/2	50
LCAX8-14-L				1/4	0.48	0.42	0.07	1.20	Red	P21	49	21	1/2	50
LCAX8-56-L				5/16	0.56	0.42	0.05	1.32	Red	P21	49	21	1/2	50
LCAX8-38-L				3/8	0.60	0.42	0.05	1.42	Red	P21	49	21	1/2	50
LCAX6-10-L	#6 AWG	#6 AWG	#6 AWG	#10	0.45	0.48	0.09	1.19	Blue	P24	7	24	9/16	50
LCAX6-14-L				1/4	0.48	0.48	0.08	1.28	Blue	P24	7	24	9/16	50
LCAX6-56-L				5/16	0.56	0.48	0.07	1.40	Blue	P24	7	24	9/16	50
LCAX6-38-L				3/8	0.62	0.48	0.06	1.50	Blue	P24	7	24	9/16	50
LCAX4-10-L	#4 AWG	#5, #4, #3 AWG	#4 AWG	#10	0.55	0.53	0.09	1.26	Gray	P29	8	29	5/8	50
LCAX4-14-L				1/4	0.55	0.53	0.09	1.35	Gray	P29	8	29	5/8	50
LCAX4-56-L				5/16	0.55	0.53	0.09	1.47	Gray	P29	8	29	5/8	50
LCAX4-38-L				3/8	0.62	0.53	0.07	1.57	Gray	P29	8	29	5/8	50
LCAX2-10-E*	#2 AWG	#2 AWG	#2 AWG	#10	0.70	0.59	0.11	1.40	Brown	P33	10	33	11/16	20
LCAX2-14-E*				1/4	0.70	0.59	0.11	1.50	Brown	P33	10	33	11/16	20
LCAX2-56-E*				5/16	0.70	0.59	0.11	1.63	Brown	P33	10	33	11/16	20
LCAX2-38-E*				3/8	0.70	0.59	0.11	1.70	Brown	P33	10	33	11/16	20
LCAX2-12-E*	#1 AWG	#1 AWG	#1 AWG	1/2	0.75	0.59	0.09	1.94	Brown	P33	10	33	11/16	20
LCAX1-10-X				#10	0.76	0.66	0.12	1.50	Green	P37	11	37	3/4	10
LCAX1-14-X				1/4	0.76	0.66	0.12	1.67	Green	P37	11	37	3/4	10
LCAX1-56-X				5/16	0.76	0.66	0.12	1.72	Green	P37	11	37	3/4	10
LCAX1-38-X	3/8	0.76	0.66	0.12	1.80	Green	P37	11	37	3/4	10			
LCAX1-12-X	1/2	0.80	0.66	0.12	2.03	Green	P37	11	37	3/4	10			

‡See pages D3.70 – D3.73 for tool and die information.

\*Not UL Listed or CSA Certified with Class K flex conductor when crimped with Burndy tools.

\*\*Consult cable manufacturer for voltage stress relief instructions with applications greater than 2000 V.

E4. Permanent Identification

E5. Lockout/Tagout & Safety Solutions

F. Index



# PANDUIT® ELECTRICAL SOLUTIONS



## Flex Conductor, One-Hole, Standard Barrel with Window Lug (continued)

Part Number	Flex Conductor Size		Code Conductor Size	Stud Hole Size (In.)	Figure Dimensions (In.)				Panduit Color Code	Panduit Die Index No.‡	Burndy Die Index No.‡	T&B Die Index No.‡	Wire Strip Length (In.)	Std. Pkg. Qty.
	Class G, H, I, K, M	Diesel Locomotive			W	B	T	L						
LCAX1/0-14-X	1/0 AWG	1/0 AWG	1/0 AWG	1/4	0.85	0.72	0.13	1.82	Pink	P42	12	42	3/4	10
LCAX1/0-56-X				5/16	0.85	0.72	0.13	1.82	Pink	P42	12	42	3/4	10
LCAX1/0-38-X				3/8	0.85	0.72	0.13	1.89	Pink	P42	12	42	3/4	10
LCAX1/0-12-X				1/2	0.85	0.72	0.13	2.14	Pink	P42	12	42	3/4	10
LCAX1/0-58-X				5/8	0.96	0.72	0.11	2.38	Pink	P42	12	42	3/4	10
LCAX2/0-10-X	2/0 AWG	2/0 AWG	2/0 AWG	#10	0.96	0.83	0.13	1.72	Black	P45	13	45	7/8	10
LCAX2/0-14-X				1/4	0.96	0.83	0.13	1.97	Black	P45	13	45	7/8	10
LCAX2/0-56-X				5/16	0.96	0.83	0.13	1.97	Black	P45	13	45	7/8	10
LCAX2/0-38-X				3/8	0.96	0.83	0.13	2.03	Black	P45	13	45	7/8	10
LCAX2/0-12-X				1/2	0.96	0.83	0.13	2.28	Black	P45	13	45	7/8	10
LCAX2/0-58-X	5/8	0.96	0.83	0.13	2.52	Black	P45	13	45	7/8	10			
LCAX3/0-10-X	3/0 AWG	3/0 AWG	3/0 AWG	#10	1.06	0.91	0.14	1.84	Orange	P50	14	50	1	10
LCAX3/0-14-X				1/4	1.06	0.91	0.14	2.08	Orange	P50	14	50	1	10
LCAX3/0-56-X				5/16	1.06	0.91	0.14	2.10	Orange	P50	14	50	1	10
LCAX3/0-38-X				3/8	1.06	0.91	0.14	2.17	Orange	P50	14	50	1	10
LCAX3/0-12-X				1/2	1.06	0.91	0.14	2.40	Orange	P50	14	50	1	10
LCAX3/0-58-X	5/8	1.06	0.91	0.14	2.64	Orange	P50	14	50	1	10			
LCAX4/0-14-X	4/0 AWG	4/0 AWG	4/0 AWG	1/4	1.19	1.03	0.16	2.30	Purple	P54	15	54	1 1/16	10
LCAX4/0-56-X				5/16	1.19	1.03	0.16	2.53	Purple	P54	15	54	1 1/16	10
LCAX4/0-38-X				3/8	1.19	1.03	0.16	2.53	Purple	P54	15	54	1 1/16	10
LCAX4/0-12-X				1/2	1.19	1.03	0.16	2.64	Purple	P54	15	54	1 1/16	10
LCAX4/0-58-X				5/8	1.19	1.03	0.16	2.85	Purple	P54	15	54	1 1/16	10
LCAX4/0-34-X	3/4	1.19	1.03	0.16	3.04	Purple	P54	15	54	1 1/16	10			
LCAX250-14-X	250 kcmil	262.6 kcmil	—	1/4	1.28	1.03	0.17	2.34	Yellow	P62	16	62	1 1/16	10
LCAX250-56-X				5/16	1.28	1.03	0.17	2.57	Yellow	P62	16	62	1 1/16	10
LCAX250-38-X				3/8	1.28	1.03	0.17	2.57	Yellow	P62	16	62	1 1/16	10
LCAX250-12-X				1/2	1.28	1.03	0.17	2.68	Yellow	P62	16	62	1 1/16	10
LCAX250-58-X				5/8	1.28	1.03	0.17	2.89	Yellow	P62	16	62	1 1/16	10
LCAX250-34-X	3/4	1.28	1.03	0.17	3.08	Yellow	P62	16	62	1 1/16	10			
LCAX300-38-6	300 kcmil	313.1 kcmil	—	3/8	1.39	1.19	0.18	2.91	Red	P71	18	71H	1 1/4	6
LCAX300-12-6				1/2	1.39	1.19	0.18	2.91	Red	P71	18	71H	1 1/4	6
LCAX300-58-6				5/8	1.39	1.19	0.18	3.12	Red	P71	18	71H	1 1/4	6
LCAX350-56-6	350 kcmil	373.7 kcmil	—	5/16	1.54	1.29	0.22	2.93	Blue	P76	19	76H	1 3/8	6
LCAX350-38-6				3/8	1.54	1.29	0.22	2.93	Blue	P76	19	76H	1 3/8	6
LCAX350-12-6				1/2	1.54	1.29	0.22	3.09	Blue	P76	19	76H	1 3/8	6
LCAX350-58-6				5/8	1.54	1.29	0.22	3.30	Blue	P76	19	76H	1 3/8	6
LCAX450-12-6	450 kcmil	444.4 kcmil	—	1/2	1.70	1.40	0.26	3.60	Brown	P87	20	87H	1 7/16	6
LCAX450-58-6				5/8	1.70	1.40	0.26	3.73	Brown	P87	20	87H	1 7/16	6
LCAX500-56-6	500 kcmil	535.3 kcmil	—	5/16	1.89	1.48	0.26	3.27	Pink	P99	L99	99H	1 9/16	6
LCAX500-38-6				3/8	1.89	1.48	0.26	3.27	Pink	P99	L99	99H	1 9/16	6
LCAX500-12-6				1/2	1.89	1.48	0.26	3.64	Pink	P99	L99	99H	1 9/16	6
LCAX500-58-6				5/8	1.89	1.48	0.26	4.20	Pink	P99	L99	99H	1 9/16	6
LCAX650-56-6	—	646.4 kcmil	—	5/16	1.95	1.45	0.30	3.27	Black	P106	24	106H	1 1/2	6
LCAX650-38-6				3/8	1.95	1.45	0.30	3.27	Black	P106	24	106H	1 1/2	6
LCAX650-12-6				1/2	1.95	1.45	0.30	3.64	Black	P106	24	106H	1 1/2	6
LCAX650-58-6				5/8	1.95	1.45	0.30	4.20	Black	P106	24	106H	1 1/2	6
LCAX750-12-3	—	777.7 kcmil	—	1/2	2.17	1.66	0.32	3.94	Yellow	P115	L115	115H	1 3/4	3
LCAX750-58-3				5/8	2.17	1.66	0.32	4.59	Yellow	P115	L115	115H	1 3/4	3

‡See pages D3.70 – D3.73 for tool and die information.

\*Not UL Listed or CSA Certified with Class K flex conductor when crimped with Burndy tools.

\*\*Consult cable manufacturer for voltage stress relief instructions with applications greater than 2000 V.

A. System Overview

B1. Cable Ties

B2. Cable Accessories

B3. Stainless Steel Ties

C1. Wiring Duct

C2. Surface Raceway

C3. Abrasion Protection

C4. Cable Management

D1. Terminals

D2. Power Connectors

D3. Grounding Connectors

E1. Labeling Systems

E2. Labels

E3. Pre-Printed & Write-On Markers

E4. Permanent Identification

E5. Lockout/Tagout & Safety Solutions

F. Index

A. System Overview



## Flex Conductor, One-Hole, Standard Barrel with Window Lug, 45° Angle

B1. Cable Ties

**For Use with Flexible, Extra-Flexible, and Code Stranded Copper Conductors**

### Type LCAX-H

- Can be used with code conductor and flex conductor class: G, H, I, K, M and Diesel Locomotive
- Generously beveled wire entry prevents bent back strands when inserting conductor into barrel
- Color-coded barrels marked with Panduit and specified competitor die index numbers for proper crimp die selection
- Inspection window to visually assure full conductor insertion
- Tin-plated to inhibit corrosion
- UL Listed and CSA Certified to 35 KV\*\* and temperature rated to 90°C when crimped with Panduit and specified competitor crimping tools and dies
- American Bureau of Shipping Approved

B2. Cable Accessories

B3. Stainless Steel Ties

C1. Wiring Duct

C2. Surface Raceway

C3. Abrasion Protection



C4. Cable Management

D1. Terminals

D2. Power Connectors

D3. Grounding Connectors

E1. Labeling Systems

E2. Labels

E3. Pre-Printed & Write-On Markers

E4. Permanent Identification

E5. Lockout/Tagout & Safety Solutions

F. Index

Part Number	Flex Conductor Size		Code Conductor Size	Stud Hole Size (In.)	Figure Dimensions (In.)				Panduit Color Code	Panduit Die Index No.‡	Burndy Die Index No.‡	T&B Die Index No.‡	Wire Strip Length (In.)	Std. Pkg. Qty.
	Class G, H, I, K, M	Diesel Locomotive			W	B	T	L						
LCAX8-10H-L	#8 AWG	#8 AWG	#8 AWG	#10	0.41	0.42	0.08	1.00	Red	P21	49	21	1/2	50
LCAX8-14H-L				1/4	0.48	0.42	0.07	1.09	Red	P21	49	21	1/2	50
LCAX8-56H-L				5/16	0.56	0.42	0.05	1.20	Red	P21	49	21	1/2	50
LCAX8-38H-L				3/8	0.60	0.42	0.05	1.30	Red	P21	49	21	1/2	50
LCAX6-10H-L	#6 AWG	#6 AWG	#6 AWG	#10	0.45	0.48	0.09	1.06	Blue	P24	7	24	9/16	50
LCAX6-14H-L				1/4	0.48	0.48	0.08	1.14	Blue	P24	7	24	9/16	50
LCAX6-56H-L				5/16	0.56	0.48	0.07	1.26	Blue	P24	7	24	9/16	50
LCAX6-38H-L	3/8	0.62	0.48	0.06	1.35	Blue	P24	7	24	9/16	50			
LCAX4-10H-L	#4 AWG	#5, #4, #3 AWG	#4 AWG	#10	0.55	0.53	0.09	1.12	Gray	P29	8	29	5/8	50
LCAX4-14H-L				1/4	0.55	0.53	0.09	1.21	Gray	P29	8	29	5/8	50
LCAX4-56H-L				5/16	0.55	0.53	0.09	1.33	Gray	P29	8	29	5/8	50
LCAX4-38H-L	3/8	0.62	0.53	0.07	1.42	Gray	P29	8	29	5/8	50			
LCAX2-10H-E	#2 AWG	#2 AWG	#2 AWG	#10	0.70	0.59	0.11	1.22	Brown	P33	10	33	11/16	20
LCAX2-14H-E				1/4	0.70	0.59	0.11	1.29	Brown	P33	10	33	11/16	20
LCAX2-56H-E				5/16	0.70	0.59	0.11	1.42	Brown	P33	10	33	11/16	20
LCAX2-38H-E				3/8	0.70	0.59	0.11	1.49	Brown	P33	10	33	11/16	20
LCAX2-12H-E	1/2	0.75	0.59	0.09	1.73	Brown	P33	10	33	11/16	20			
LCAX1-10H-X	#1 AWG	#1 AWG	#1 AWG	#10	0.76	0.66	0.12	1.43	Green	P37	11	37	3/4	10
LCAX1-14H-X				1/4	0.76	0.66	0.12	1.43	Green	P37	11	37	3/4	10
LCAX1-56H-X				5/16	0.76	0.66	0.12	1.49	Green	P37	11	37	3/4	10
LCAX1-38H-X				3/8	0.76	0.66	0.12	1.56	Green	P37	11	37	3/4	10
LCAX1-12H-X	1/2	0.80	0.66	0.12	1.80	Green	P37	11	37	3/4	10			
LCAX1/0-14H-X	1/0 AWG	1/0 AWG	1/0 AWG	1/4	0.85	0.72	0.13	1.58	Pink	P42	12	42	3/4	10
LCAX1/0-56H-X				5/16	0.85	0.72	0.13	1.58	Pink	P42	12	42	3/4	10
LCAX1/0-38H-X				3/8	0.85	0.72	0.13	1.64	Pink	P42	12	42	3/4	10
LCAX1/0-12H-X				1/2	0.85	0.72	0.13	1.89	Pink	P42	12	42	3/4	10

‡See pages D3.70 – D3.73 for tool and die information.

\*Not UL Listed or CSA Certified with Class K flex conductor when crimped with Burndy tools.

\*\*Consult cable manufacturer for voltage stress relief instructions with applications greater than 2000 V.



## Flex Conductor, One-Hole, Standard Barrel with Window Lug, 45° Angle (continued)

Part Number	Flex Conductor Size		Code Conductor Size	Stud Hole Size (In.)	Figure Dimensions (In.)				Panduit Color Code	Panduit Die Index No.†	Burndy Die Index No.‡	T&B Die Index No.‡	Wire Strip Length (In.)	Std. Pkg. Qty.			
	Class G, H, I, K, M	Diesel Locomotive			W	B	T	L									
LCAX2/0-10H-X	2/0 AWG	2/0 AWG	2/0 AWG	#10	0.96	0.83	0.13	1.56	Black	P45	13	45	7/8	10			
LCAX2/0-14H-X				1/4	0.96	0.83	0.13	1.68	Black	P45	13	45	7/8	10			
LCAX2/0-56H-X				5/16	0.96	0.83	0.13	1.68	Black	P45	13	45	7/8	10			
LCAX2/0-38H-X				3/8	0.96	0.83	0.13	1.74	Black	P45	13	45	7/8	10			
LCAX2/0-12H-X				1/2	0.96	0.83	0.13	1.99	Black	P45	13	45	7/8	10			
LCAX2/0-58H-X				5/8	0.96	0.83	0.13	2.28	Black	P45	13	45	7/8	10			
LCAX3/0-10H-X				3/0 AWG	3/0 AWG	3/0 AWG	#10	1.06	0.91	0.14	1.77	Orange	P50	14	50	1	10
LCAX3/0-14H-X	1/4	1.06	0.91				0.14	1.77	Orange	P50	14	50	1	10			
LCAX3/0-56H-X	5/16	1.06	0.91				0.14	1.78	Orange	P50	14	50	1	10			
LCAX3/0-38H-X	3/8	1.06	0.91				0.14	1.85	Orange	P50	14	50	1	10			
LCAX3/0-12H-X	1/2	1.06	0.91				0.14	2.08	Orange	P50	14	50	1	10			
LCAX4/0-14H-X	4/0 AWG	4/0 AWG	4/0 AWG				1/4	1.19	1.03	0.16	2.03	Purple	P54	15	54	1 1/16	10
LCAX4/0-56H-X							5/16	1.19	1.03	0.16	2.26	Purple	P54	15	54	1 1/16	10
LCAX4/0-38H-X				3/8	1.19	1.03	0.16	2.26	Purple	P54	15	54	1 1/16	10			
LCAX4/0-12H-X				1/2	1.19	1.03	0.16	2.37	Purple	P54	15	54	1 1/16	10			
LCAX4/0-58H-X				5/8	1.19	1.03	0.16	2.58	Purple	P54	15	54	1 1/16	10			
LCAX4/0-34H-X				3/4	1.19	1.03	0.16	2.58	Purple	P54	15	54	1 1/16	10			
LCAX250-14H-X				250 kcmil	262.6 kcmil	—	1/4	1.28	1.03	0.17	2.30	Yellow	P62	16	62	1 1/16	10
LCAX250-56H-X	5/16	1.28	1.03				0.17	2.30	Yellow	P62	16	62	1 1/16	10			
LCAX250-38H-X	3/8	1.28	1.03				0.17	2.30	Yellow	P62	16	62	1 1/16	10			
LCAX250-12H-X	1/2	1.28	1.03				0.17	2.41	Yellow	P62	16	62	1 1/16	10			
LCAX250-58H-X	5/8	1.28	1.03				0.17	2.62	Yellow	P62	16	62	1 1/16	10			
LCAX250-34H-X	3/4	1.28	1.03				0.17	2.62	Yellow	P62	16	62	1 1/16	10			
LCAX300-38H-6	300 kcmil	313.1 kcmil	—				3/8	1.39	1.19	0.18	2.64	Red	P71	18	71H	1 1/4	6
LCAX300-12H-6				1/2	1.39	1.19	0.18	2.64	Red	P71	18	71H	1 1/4	6			
LCAX300-58H-6				5/8	1.39	1.19	0.18	2.85	Red	P71	18	71H	1 1/4	6			
LCAX350-56H-6	350 kcmil	373.7 kcmil	—	5/16	1.54	1.29	0.22	2.62	Blue	P76	19	76H	1 3/8	6			
LCAX350-38H-6				3/8	1.54	1.29	0.22	2.62	Blue	P76	19	76H	1 3/8	6			
LCAX350-12H-6				1/2	1.54	1.29	0.22	2.78	Blue	P76	19	76H	1 3/8	6			
LCAX350-58H-6				5/8	1.54	1.29	0.22	2.99	Blue	P76	19	76H	1 3/8	6			
LCAX450-12H-6	450 kcmil	444.4 kcmil	—	1/2	1.70	1.40	0.26	3.26	Brown	P87	20	87H	1 7/16	6			
LCAX450-58H-6				5/8	1.70	1.40	0.26	3.39	Brown	P87	20	87H	1 7/16	6			
LCAX500-56H-6	500 kcmil	535.3 kcmil	—	5/16	1.89	1.48	0.26	2.87	Pink	P99	L99	99H	1 9/16	6			
LCAX500-38H-6				3/8	1.89	1.48	0.26	2.87	Pink	P99	L99	99H	1 9/16	6			
LCAX500-12H-6				1/2	1.89	1.48	0.26	3.24	Pink	P99	L99	99H	1 9/16	6			
LCAX500-58H-6				5/8	1.89	1.48	0.26	3.80	Pink	P99	L99	99H	1 9/16	6			
LCAX650-56H-6	—	646.4 kcmil	—	5/16	1.95	1.45	0.30	2.89	Black	P106	24	106H	1 1/2	6			
LCAX650-38H-6				3/8	1.95	1.45	0.30	2.89	Black	P106	24	106H	1 1/2	6			
LCAX650-12H-6				1/2	1.95	1.45	0.30	3.26	Black	P106	24	106H	1 1/2	6			
LCAX650-58H-6				5/8	1.95	1.45	0.30	3.82	Black	P106	24	106H	1 1/2	6			
LCAX750-12H-3	—	777.7 kcmil	—	1/2	2.17	1.66	0.32	3.52	Yellow	P115	L115	115H	1 3/4	3			
LCAX750-58H-3				5/8	2.17	1.66	0.32	4.18	Yellow	P115	L115	115H	1 3/4	3			

†See pages D3.70 – D3.73 for tool and die information.

\*Not UL Listed or CSA Certified with Class K flex conductor when crimped with Burndy tools.

\*\*Consult cable manufacturer for voltage stress relief instructions with applications greater than 2000 V.

A.  
System Overview

B1.  
Cable Ties

B2.  
Cable Accessories

B3.  
Stainless Steel Ties

C1.  
Wiring Duct

C2.  
Surface Raceway

C3.  
Abrasion Protection

C4.  
Cable Management

D1.  
Terminals

D2.  
Power Connectors

D3.  
Grounding Connectors

E1.  
Labeling Systems

E2.  
Labels

E3.  
Pre-Printed & Write-On Markers

E4.  
Permanent Identification

E5.  
Lockout/Tagout & Safety Solutions

F.  
Index

A. System Overview



## Flex Conductor, One-Hole, Standard Barrel with Window Lug, 90° Angle

B1. Cable Ties

**For Use with Flexible, Extra-Flexible, and Code Stranded Copper Conductors**

### Type LCAX-F

- Can be used with code conductor and flex conductor class: G, H, I, K, M and Diesel Locomotive
- Generously beveled wire entry prevents bent back strands when inserting conductor into barrel
- Color-coded barrels marked with Panduit and specified competitor die index numbers for proper crimp die selection
- Inspection window to visually assure full conductor insertion
- Tin-plated to inhibit corrosion
- UL Listed and CSA Certified to 35 KV\*\* and temperature rated to 90°C when crimped with Panduit and specified competitor crimping tools and dies
- American Bureau of Shipping approved

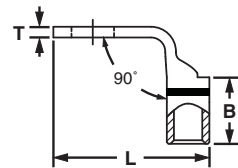

C1. Wiring Duct

C2. Surface Raceway

C3. Abrasion Protection

C4. Cable Management

Part Number	Flex Conductor Size		Code Conductor Size	Stud Hole Size (In.)	Figure Dimensions (In.)				Panduit Color Code	Panduit Die Index No.‡	Burndy Die Index No.‡	T&B Die Index No.‡	Wire Strip Length (In.)	Std. Pkg. Qty.
	Class G, H, I, K, M	Diesel Locomotive			W	B	T	L						
LCAX8-10F-L	#8 AWG	#8 AWG	#8 AWG	#10	0.41	0.42	0.08	0.90	Red	P21	49	21	1/2	50
LCAX8-14F-L				1/4	0.48	0.42	0.07	0.99	Red	P21	49	21	1/2	50
LCAX8-56F-L				5/16	0.56	0.42	0.05	1.11	Red	P21	49	21	1/2	50
LCAX8-38F-L				3/8	0.60	0.42	0.05	1.21	Red	P21	49	21	1/2	50
LCAX6-10F-L	#6 AWG	#6 AWG	#6 AWG	#10	0.45	0.48	0.09	0.99	Blue	P24	7	24	9/16	50
LCAX6-14F-L				1/4	0.48	0.48	0.08	1.03	Blue	P24	7	24	9/16	50
LCAX6-56F-L				5/16	0.56	0.48	0.07	1.15	Blue	P24	7	24	9/16	50
LCAX6-38F-L				3/8	0.62	0.48	0.06	1.25	Blue	P24	7	24	9/16	50
LCAX4-10F-L	#4 AWG	#5, #4, #3 AWG	#4 AWG	#10	0.55	0.53	0.09	1.03	Gray	P29	8	29	5/8	50
LCAX4-14F-L				1/4	0.55	0.53	0.09	1.12	Gray	P29	8	29	5/8	50
LCAX4-56F-L				5/16	0.55	0.53	0.09	1.24	Gray	P29	8	29	5/8	50
LCAX4-38F-L				3/8	0.62	0.53	0.07	1.34	Gray	P29	8	29	5/8	50
LCAX2-10F-E*	#2 AWG	#2 AWG	#2 AWG	#10	0.70	0.59	0.11	1.21	Brown	P33	10	33	11/16	20
LCAX2-14F-E*				1/4	0.70	0.59	0.11	1.31	Brown	P33	10	33	11/16	20
LCAX2-56F-E*				5/16	0.70	0.59	0.11	1.44	Brown	P33	10	33	11/16	20
LCAX2-38F-E*				3/8	0.70	0.59	0.11	1.51	Brown	P33	10	33	11/16	20
LCAX2-12F-E*	#1 AWG	#1 AWG	#1 AWG	1/2	0.75	0.59	0.09	1.75	Brown	P33	10	33	11/16	20
LCAX1-10F-X				#10	0.76	0.66	0.12	1.28	Green	P37	11	37	3/4	10
LCAX1-14F-X				1/4	0.76	0.66	0.12	1.45	Green	P37	11	37	3/4	10
LCAX1-56F-X				5/16	0.76	0.66	0.12	1.51	Green	P37	11	37	3/4	10
LCAX1-38F-X	3/8	0.76	0.66	0.12	1.58	Green	P37	11	37	3/4	10			
LCAX1-12F-X	1/0 AWG	1/0 AWG	1/0 AWG	1/2	0.80	0.66	0.12	1.82	Green	P37	11	37	3/4	10
LCAX1/0-14F-X				1/4	0.85	0.72	0.13	1.59	Pink	P42	12	42	3/4	10
LCAX1/0-56F-X				5/16	0.85	0.72	0.13	1.59	Pink	P42	12	42	3/4	10
LCAX1/0-38F-X				3/8	0.85	0.72	0.13	1.66	Pink	P42	12	42	3/4	10
LCAX1/0-12F-X	1/2	0.85	0.72	0.13	1.91	Pink	P42	12	42	3/4	10			

‡See pages D3.70 – D3.73 for tool and die information.

\*Not UL Listed or CSA Certified with Class K flex conductor when crimped with Burndy tools.

\*\*Consult cable manufacturer for voltage stress relief instructions with applications greater than 2000 V.

E1. Labeling Systems

E2. Labels

E3. Pre-Printed & Write-On Markers

E4. Permanent Identification

E5. Lockout/Tagout & Safety Solutions

F. Index



## Flex Conductor, One-Hole, Standard Barrel with Window Lug, 90° Angle (continued)

Part Number	Flex Conductor Size		Code Conductor Size	Stud Hole Size (In.)	Figure Dimensions (In.)				Panduit Color Code	Panduit Die Index No.†	Burndy Die Index No.‡	T&B Die Index No.‡	Wire Strip Length (In.)	Std. Pkg. Qty.
	Class G, H, I, K, M	Diesel Locomotive			W	B	T	L						
LCAX2/0-10F-X	2/0 AWG	2/0 AWG	2/0 AWG	#10	0.96	0.83	0.13	1.42	Black	P45	13	45	7/8	10
LCAX2/0-14F-X				1/4	0.96	0.83	0.13	1.67	Black	P45	13	45	7/8	10
LCAX2/0-56F-X				5/16	0.96	0.83	0.13	1.67	Black	P45	13	45	7/8	10
LCAX2/0-38F-X				3/8	0.96	0.83	0.13	1.73	Black	P45	13	45	7/8	10
LCAX2/0-12F-X				1/2	0.96	0.83	0.13	1.98	Black	P45	13	45	7/8	10
LCAX2/0-58F-X				5/8	0.96	0.83	0.13	2.27	Black	P45	13	45	7/8	10
LCAX3/0-10F-X	3/0 AWG	3/0 AWG	3/0 AWG	#10	1.06	0.91	0.14	1.51	Orange	P50	14	50	1	10
LCAX3/0-14F-X				1/4	1.06	0.91	0.14	1.75	Orange	P50	14	50	1	10
LCAX3/0-56F-X				5/16	1.06	0.91	0.14	1.77	Orange	P50	14	50	1	10
LCAX3/0-38F-X				3/8	1.06	0.91	0.14	1.84	Orange	P50	14	50	1	10
LCAX3/0-12F-X				1/2	1.06	0.91	0.14	2.07	Orange	P50	14	50	1	10
LCAX4/0-14F-X				4/0 AWG	4/0 AWG	4/0 AWG	1/4	1.19	1.03	0.16	1.84	Purple	P54	15
LCAX4/0-56F-X	5/16	1.19	1.03				0.16	2.07	Purple	P54	15	54	1 1/16	10
LCAX4/0-38F-X	3/8	1.19	1.03				0.16	2.07	Purple	P54	15	54	1 1/16	10
LCAX4/0-12F-X	1/2	1.19	1.03				0.16	2.18	Purple	P54	15	54	1 1/16	10
LCAX4/0-58F-X	5/8	1.19	1.03				0.16	2.39	Purple	P54	15	54	1 1/16	10
LCAX4/0-34F-X	3/4	1.19	1.03				0.16	2.58	Purple	P54	15	54	1 1/16	10
LCAX250-14F-X	250 kcmil	262.6 kcmil	—	1/4	1.28	1.03	0.17	1.90	Yellow	P62	16	62	1 1/16	10
LCAX250-56F-X				5/16	1.28	1.03	0.17	2.13	Yellow	P62	16	62	1 1/16	10
LCAX250-38F-X				3/8	1.28	1.03	0.17	2.13	Yellow	P62	16	62	1 1/16	10
LCAX250-12F-X				1/2	1.28	1.03	0.17	2.24	Yellow	P62	16	62	1 1/16	10
LCAX250-58F-X				5/8	1.28	1.03	0.17	2.45	Yellow	P62	16	62	1 1/16	10
LCAX250-34F-X				3/4	1.28	1.03	0.17	2.64	Yellow	P62	16	62	1 1/16	10
LCAX300-38F-6	300 kcmil	313.1 kcmil	—	3/8	1.39	1.19	0.18	2.37	Red	P71	18	71H	1 1/4	6
LCAX300-12F-6				1/2	1.39	1.19	0.18	2.37	Red	P71	18	71H	1 1/4	6
LCAX300-58F-6				5/8	1.39	1.19	0.18	2.58	Red	P71	18	71H	1 1/4	6
LCAX350-56F-6	350 kcmil	373.7 kcmil	—	5/16	1.54	1.29	0.22	2.32	Blue	P76	19	76H	1 3/8	6
LCAX350-38F-6				3/8	1.54	1.29	0.22	2.32	Blue	P76	19	76H	1 3/8	6
LCAX350-12F-6				1/2	1.54	1.29	0.22	2.48	Blue	P76	19	76H	1 3/8	6
LCAX350-58F-6				5/8	1.54	1.29	0.22	2.69	Blue	P76	19	76H	1 3/8	6
LCAX450-12F-6	450 kcmil	444.4 kcmil	—	1/2	1.70	1.40	0.26	2.95	Brown	P87	20	87H	1 7/16	6
LCAX450-58F-6				5/8	1.70	1.40	0.26	3.08	Brown	P87	20	87H	1 7/16	6
LCAX500-56F-6	500 kcmil	535.3 kcmil	—	5/16	1.89	1.48	0.26	2.44	Pink	P99	L99	99H	1 9/16	6
LCAX500-38F-6				3/8	1.89	1.48	0.26	2.69	Pink	P99	L99	99H	1 9/16	6
LCAX500-12F-6				1/2	1.89	1.48	0.26	2.81	Pink	P99	L99	99H	1 9/16	6
LCAX500-58F-6				5/8	1.89	1.48	0.26	3.37	Pink	P99	L99	99H	1 9/16	6
LCAX650-56F-6	—	646.4 kcmil	—	5/16	1.95	1.45	0.30	2.50	Black	P106	24	106H	1 1/2	6
LCAX650-38F-6				3/8	1.95	1.45	0.30	2.50	Black	P106	24	106H	1 1/2	6
LCAX650-12F-6				1/2	1.95	1.45	0.30	2.86	Black	P106	24	106H	1 1/2	6
LCAX650-58F-6				5/8	1.95	1.45	0.30	3.42	Black	P106	24	106H	1 1/2	6
LCAX750-12F-3	—	777.7 kcmil	—	1/2	2.17	1.66	0.32	2.86	Yellow	P115	L115	115H	1 3/4	3
LCAX750-58F-3				5/8	2.17	1.66	0.32	3.67	Yellow	P115	L115	115H	1 3/4	3

†See pages D3.70 – D3.73 for tool and die information.

\*Not UL Listed or CSA Certified with Class K flex conductor when crimped with Burndy tools.

\*\*Consult cable manufacturer for voltage stress relief instructions with applications greater than 2000 V.

A.  
System  
Overview

B1.  
Cable Ties

B2.  
Cable  
Accessories

B3.  
Stainless  
Steel Ties

C1.  
Wiring  
Duct

C2.  
Surface  
Raceway

C3.  
Abrasion  
Protection

C4.  
Cable  
Management

D1.  
Terminals

D2.  
Power  
Connectors

D3.  
Grounding  
Connectors

E1.  
Labeling  
Systems

E2.  
Labels

E3.  
Pre-Printed  
& Write-On  
Markers

E4.  
Permanent  
Identification

E5.  
Lockout/  
Tagout  
& Safety  
Solutions

F.  
Index

A. System Overview



## Flex Conductor, One-Hole, Standard Barrel with Window, Narrow Tongue Lug

B1. Cable Ties

### For Use with Flexible Copper Conductors

#### Type LCAXN

- Narrow tongue width for limited space applications
- Can be used with flex conductor class: Diesel Locomotive
- Generously beveled wire entry prevents bent back strands when inserting conductor into barrel
- Color-coded barrels marked with Panduit and specified competitor die index numbers for proper crimp die selection
- Inspection window to visually assure full conductor insertion
- Tin-plated to inhibit corrosion
- UL Listed and CSA Certified to 35 KV\*\* and temperature rated to 90°C when crimped with Panduit and specified competitor crimping tools and dies

B2. Cable Accessories

B3. Stainless Steel Ties

C1. Wiring Duct

C2. Surface Raceway

C3. Abrasion Protection

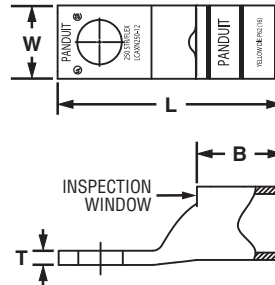

C4. Cable Management

Part Number	Flex Conductor Size	Stud Hole Size (In.)	Figure Dimensions (In.)				Panduit Color Code	Panduit Die Index No.‡	Burndy Die Index No.‡	T&B Die Index No.‡	Wire Strip Length (In.)	Std. Pkg. Qty.
	Diesel Locomotive		W	B	T	L						
LCAXN750-12-3	777.7 kcmil	1/2	1.50	1.66	0.33	3.94	Yellow	P115	L115	115H	1 3/4	3

‡See pages D3.70 – D3.73 for tool and die information.

\*\*Consult cable manufacturer for voltage stress relief instructions with applications greater than 2000 V.

D1. Terminals

D2. Power Connectors

D3. Grounding Connectors

E1. Labeling Systems

E2. Labels

E3. Pre-Printed & Write-On Markers

E4. Permanent Identification

E5. Lockout/Tagout & Safety Solutions

F. Index



## Flex Conductor, One-Hole, Standard Barrel with Window, Flared NEBS Lug

For Use with Flexible and Extra-Flexible Copper Conductors

### Type LCAF

- Can be used with flex conductor class: K, M, and Diesel Locomotive
- Flared entry prevents bent back strands when inserting fine strand conductor into barrel
- Color-coded barrels marked with Panduit die index numbers for proper crimp die selection
- Inspection window to visually assure full conductor insertion
- Tin-plated to inhibit corrosion
- UL Listed and CSA Certified to 35 KV\*\* and temperature rated to 90°C when crimped with Panduit crimping tools and dies
- **Tested by Telcordia – meets NEBS Level 3**
- American Bureau of Shipping approved

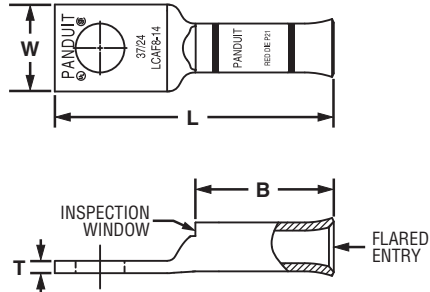

Part Number	Flex Conductor Size		Stud Hole Size (In.)	Figure Dimensions (In.)				Panduit Color Code	Panduit Die Index No.‡	Wire Strip Length (In.)	Std. Pkg. Qty.
	Class K and M	Diesel Locomotive		W	B	T	L				
LCAF8-10-L	—	#8 AWG	#10	0.41	0.76	0.08	1.45	Red	P21	13/16	50
LCAF8-14-L			1/4	0.48	0.76	0.07	1.54	Red	P21	13/16	50
LCAF8-56-L			5/16	0.56	0.76	0.05	1.66	Red	P21	13/16	50
LCAF8-38-L			3/8	0.60	0.76	0.05	1.76	Red	P21	13/16	50
LCAF6-10-L	#6 AWG	#6 AWG	#10	0.45	0.81	0.09	1.52	Blue	P24	7/8	50
LCAF6-14-L			1/4	0.48	0.81	0.08	1.61	Blue	P24	7/8	50
LCAF6-56-L			5/16	0.56	0.81	0.07	1.73	Blue	P24	7/8	50
LCAF6-38-L			3/8	0.62	0.81	0.06	1.83	Blue	P24	7/8	50
LCAF4-10-L	#4 AWG	#4 AWG	#10	0.55	0.81	0.09	1.54	Gray	P29	7/8	50
LCAF4-14-L			1/4	0.55	0.81	0.09	1.63	Gray	P29	7/8	50
LCAF4-56-L			5/16	0.55	0.81	0.09	1.75	Gray	P29	7/8	50
LCAF4-38-L			3/8	0.62	0.81	0.07	1.85	Gray	P29	7/8	50
LCAF2-14-E	#2 AWG	#2 AWG	1/4	0.70	0.88	0.11	1.79	Brown	P33	15/16	20
LCAF2-56-E			5/16	0.70	0.88	0.11	1.92	Brown	P33	15/16	20
LCAF2-38-E			3/8	0.70	0.88	0.11	1.99	Brown	P33	15/16	20
LCAF2-12-E			1/2	0.79	0.88	0.09	2.23	Brown	P33	15/16	20
LCAF1-14-X	#1 AWG	#1 AWG	1/4	0.76	0.94	0.12	1.95	Pink	P42	1	10
LCAF1-56-X			5/16	0.76	0.94	0.12	2.00	Pink	P42	1	10
LCAF1-38-X			3/8	0.76	0.94	0.12	2.08	Pink	P42	1	10
LCAF1-12-X			1/2	0.80	0.94	0.12	2.31	Pink	P42	1	10
LCAF1/0-14-X	1/0 AWG	1/0 AWG	1/4	0.85	1.35	0.13	2.46	Black	P45	1 7/16	10
LCAF1/0-56-X			5/16	0.85	1.35	0.13	2.46	Black	P45	1 7/16	10
LCAF1/0-38-X			3/8	0.85	1.35	0.13	2.52	Black	P45	1 7/16	10
LCAF1/0-12-X			1/2	0.85	1.35	0.13	2.77	Black	P45	1 7/16	10

‡See pages D3.74, D3.75 for tool and die information.

\*\*Consult cable manufacturer for voltage stress relief instructions with applications greater than 2000 V.

Table continues on page D2.74

A. System Overview

B1. Cable Ties

B2. Cable Accessories

B3. Stainless Steel Ties

C1. Wiring Duct

C2. Surface Raceway

C3. Abrasion Protection

C4. Cable Management

D1. Terminals

D2. Power Connectors

D3. Grounding Connectors

E1. Labeling Systems

E2. Labels

E3. Pre-Printed & Write-On Markers

E4. Permanent Identification

E5. Lockout/Tagout & Safety Solutions

F. Index

A. System Overview



## Flex Conductor, One-Hole, Standard Barrel with Window, Flared NEBS Lug (continued)

B1. Cable Ties

B2. Cable Accessories

B3. Stainless Steel Ties

C1. Wiring Duct

C2. Surface Raceway

C3. Abrasion Protection

C4. Cable Management

D1. Terminals

D2. Power Connectors

D3. Grounding Connectors

E1. Labeling Systems

E2. Labels

E3. Pre-Printed & Write-On Markers

E4. Permanent Identification

E5. Lockout/Tagout & Safety Solutions

F. Index

Part Number	Flex Conductor Size		Stud Hole Size (In.)	Figure Dimensions (In.)				Panduit Color Code	Panduit Die Index No.‡	Wire Strip Length (In.)	Std. Pkg. Qty.
	Class K and M	Diesel Locomotive		W	B	T	L				
LCAF2/0-14-X	2/0 AWG	2/0 AWG	1/4	0.96	1.35	0.13	2.49	Orange	P50	1 7/16	10
LCAF2/0-56-X			5/16	0.96	1.35	0.13	2.49	Orange	P50	1 7/16	10
<b>LCAF2/0-38-X</b>			3/8	0.96	1.35	0.13	2.55	Orange	P50	1 7/16	10
LCAF2/0-12-X			1/2	0.96	1.35	0.13	2.80	Orange	P50	1 7/16	10
LCAF3/0-14-X	3/0 AWG	3/0 AWG	1/4	1.06	1.35	0.14	2.52	Purple	P54	1 7/16	10
LCAF3/0-56-X			5/16	1.06	1.35	0.14	2.53	Purple	P54	1 7/16	10
LCAF3/0-38-X			3/8	1.06	1.35	0.14	2.60	Purple	P54	1 7/16	10
LCAF3/0-12-X			1/2	1.06	1.35	0.14	2.83	Purple	P54	1 7/16	10
LCAF4/0-14-X	4/0 AWG	4/0 AWG	1/4	1.17	1.35	0.14	2.56	Yellow	P62	1 7/16	10
LCAF4/0-56-X			5/16	1.17	1.35	0.14	2.58	Yellow	P62	1 7/16	10
LCAF4/0-38-X			3/8	1.17	1.35	0.14	2.65	Yellow	P62	1 7/16	10
<b>LCAF4/0-12-X</b>			1/2	1.17	1.35	0.14	2.88	Yellow	P62	1 7/16	10
LCAF250-38-X	250 kcmil	262.6 kcmil	3/8	1.28	1.65	0.17	3.19	White	P66	1 3/4	10
LCAF250-12-X			1/2	1.28	1.65	0.17	3.30	White	P66	1 3/4	10
LCAF250-58-X			5/8	1.28	1.65	0.17	3.51	White	P66	1 3/4	10
LCAF250-78-X			7/8	1.28	1.65	0.17	3.95	White	P66	1 3/4	10
LCAF300-38-6	300 kcmil	313.1 kcmil	3/8	1.39	1.65	0.18	3.37	Red	P71	1 3/4	6
LCAF300-12-6			1/2	1.39	1.65	0.18	3.37	Red	P71	1 3/4	6
LCAF300-58-6			5/8	1.39	1.65	0.18	3.58	Red	P71	1 3/4	6
LCAF300-78-6			7/8	1.39	1.65	0.18	3.97	Red	P71	1 3/4	6
LCAF350-38-6	350 kcmil	373.7 kcmil	3/8	1.54	1.85	0.22	3.49	Blue	P76	1 15/16	6
<b>LCAF350-12-6</b>			1/2	1.54	1.85	0.22	3.65	Blue	P76	1 15/16	6
LCAF350-58-6			5/8	1.54	1.85	0.22	3.86	Blue	P76	1 15/16	6
LCAF350-34-6			3/4	1.54	1.85	0.22	4.00	Blue	P76	1 15/16	6
LCAF350-78-6	400 kcmil	444.4 kcmil	7/8	1.54	1.85	0.22	4.25	Blue	P76	1 15/16	6
LCAF350-1-6			1	1.54	1.85	0.22	4.37	Blue	P76	1 15/16	6
LCAF400-12-6			1/2	1.70	2.20	0.26	4.65	Brown	P87	2 1/4	6
LCAF400-58-6			5/8	1.70	2.20	0.26	4.65	Brown	P87	2 1/4	6
LCAF400-78-6	500 kcmil	535.3 kcmil	7/8	1.70	2.20	0.26	4.65	Brown	P87	2 1/4	6
LCAF500-12-6			1/2	1.89	2.28	0.26	4.99	Pink	P99	2 5/16	6
LCAF500-58-6			5/8	1.89	2.28	0.26	5.18	Pink	P99	2 5/16	6
LCAF600-12-6			—	646.4 kcmil	1/2	1.95	2.33	0.30	5.07	Black	P106
LCAF600-58-6	5/8	1.95			2.33	0.30	5.26	Black	P106	2 3/8	6
LCAF750-12-3	—	777.7 kcmil	1/2	2.17	2.38	0.32	5.21	Orange	P107	2 7/16	3
LCAF750-58-3			5/8	2.17	2.38	0.32	5.40	Orange	P107	2 7/16	3

‡See pages D3.74, D3.75 for tool and die information.

\*\*Consult cable manufacturer for voltage stress relief instructions with applications greater than 2000 V.





## Flex Conductor, One-Hole, Standard Barrel with Window, Flared NEBS Lug, 45° Angle

For Use with Flexible and Extra-Flexible Copper Conductors

### Type LCAF-H

- Can be used with flex conductor class: K, M, and Diesel Locomotive
- Flared entry prevents bent back strands when inserting fine strand conductor into barrel
- Color-coded barrels marked with Panduit die index numbers for proper crimp die selection
- Inspection window to visually assure full conductor insertion
- Tin-plated to inhibit corrosion
- UL Listed and CSA Certified to 35 KV\*\* and temperature rated to 90°C when crimped with Panduit crimping tools and dies
- Tested by Telcordia – meets NEBS Level 3
- American Bureau of Shipping approved

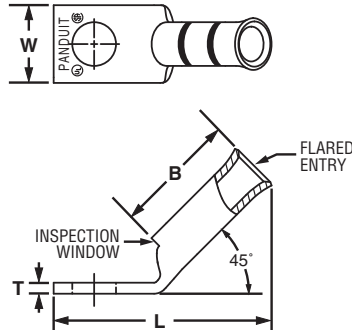

Part Number	Flex Conductor Size		Stud Hole Size (In.)	Figure Dimensions (In.)				Panduit Color Code	Panduit Die Index No.‡	Wire Strip Length (In.)	Std. Pkg. Qty.
	Class K and M	Diesel Locomotive		W	B	T	L				
LCAF8-10H-L	—	#8 AWG	#10	0.41	0.76	0.08	1.26	Red	P21	13/16	50
LCAF8-14H-L			1/4	0.48	0.76	0.07	1.35	Red	P21	13/16	50
LCAF8-56H-L			5/16	0.56	0.76	0.05	1.46	Red	P21	13/16	50
LCAF8-38H-L			3/8	0.60	0.76	0.05	1.55	Red	P21	13/16	50
LCAF6-10H-L	#6 AWG	#6 AWG	#10	0.45	0.81	0.09	1.31	Blue	P24	7/8	50
LCAF6-14H-L			1/4	0.48	0.81	0.08	1.40	Blue	P24	7/8	50
LCAF6-56H-L			5/16	0.56	0.81	0.07	1.51	Blue	P24	7/8	50
LCAF6-38H-L			3/8	0.62	0.81	0.06	1.61	Blue	P24	7/8	50
LCAF4-10H-L	#4 AWG	#4 AWG	#10	0.55	0.81	0.09	1.34	Gray	P29	7/8	50
LCAF4-14H-L			1/4	0.55	0.81	0.09	1.43	Gray	P29	7/8	50
LCAF4-56H-L			5/16	0.55	0.81	0.09	1.55	Gray	P29	7/8	50
LCAF4-38H-L			3/8	0.62	0.81	0.07	1.64	Gray	P29	7/8	50
LCAF2-14H-E	#2 AWG	#2 AWG	1/4	0.70	0.88	0.11	1.52	Brown	P33	15/16	20
LCAF2-56H-E			5/16	0.70	0.88	0.11	1.65	Brown	P33	15/16	20
LCAF2-38H-E			3/8	0.70	0.88	0.11	1.72	Brown	P33	15/16	20
LCAF2-12H-E			1/2	0.79	0.88	0.09	1.95	Brown	P33	15/16	20
LCAF1-14H-X	#1 AWG	#1 AWG	1/4	0.76	0.94	0.12	1.65	Pink	P42	1	10
LCAF1-56H-X			5/16	0.76	0.94	0.12	1.71	Pink	P42	1	10
LCAF1-38H-X			3/8	0.76	0.94	0.12	1.78	Pink	P42	1	10
LCAF1-12H-X			1/2	0.80	0.94	0.12	2.01	Pink	P42	1	10
LCAF1/0-14H-X	1/0 AWG	1/0 AWG	1/4	0.85	1.35	0.13	2.06	Black	P45	1 7/16	10
LCAF1/0-56H-X			5/16	0.85	1.35	0.13	2.06	Black	P45	1 7/16	10
LCAF1/0-38H-X			3/8	0.85	1.35	0.13	2.12	Black	P45	1 7/16	10
LCAF1/0-12H-X			1/2	0.85	1.35	0.13	2.37	Black	P45	1 7/16	10
LCAF2/0-14H-X	2/0 AWG	2/0 AWG	1/4	0.96	1.35	0.13	2.08	Orange	P50	1 7/16	10
LCAF2/0-56H-X			5/16	0.96	1.35	0.13	2.08	Orange	P50	1 7/16	10
LCAF2/0-38H-X			3/8	0.96	1.35	0.13	2.14	Orange	P50	1 7/16	10
LCAF2/0-12H-X			1/2	0.96	1.35	0.13	2.39	Orange	P50	1 7/16	10

‡See pages D3.74, D3.75 for tool and die information.

\*\*Consult cable manufacturer for voltage stress relief instructions with applications greater than 2000 V.

Table continues on page D2.76

A. System Overview

B1. Cable Ties

B2. Cable Accessories

B3. Stainless Steel Ties

C1. Wiring Duct

C2. Surface Raceway

C3. Abrasion Protection

C4. Cable Management

D1. Terminals

D2. Power Connectors

D3. Grounding Connectors

E1. Labeling Systems

E2. Labels

E3. Pre-Printed & Write-On Markers

E4. Permanent Identification

E5. Lockout/Tagout & Safety Solutions

F. Index

A.  
System  
Overview



## Flex Conductor, One-Hole, Standard Barrel with Window, Flared NEBS Lug, 45° Angle (continued)

B1.  
Cable Ties

B2.  
Cable  
Accessories

B3.  
Stainless  
Steel Ties

C1.  
Wiring  
Duct

C2.  
Surface  
Raceway

C3.  
Abrasion  
Protection

C4.  
Cable  
Management

D1.  
Terminals

D2.  
Power  
Connectors

D3.  
Grounding  
Connectors

E1.  
Labeling  
Systems

E2.  
Labels

E3.  
Pre-Printed  
& Write-On  
Markers

E4.  
Permanent  
Identification

E5.  
Lockout/  
Tagout  
& Safety  
Solutions

F.  
Index

Part Number	Flex Conductor Size		Stud Hole Size (In.)	Figure Dimensions (In.)				Panduit Color Code	Panduit Die Index No.‡	Wire Strip Length (In.)	Std. Pkg. Qty.
	Class K and M	Diesel Locomotive		W	B	T	L				
LCAF3/0-14H-X	3/0 AWG	3/0 AWG	1/4	1.06	1.35	0.14	2.11	Purple	P54	1 7/16	10
LCAF3/0-56H-X			5/16	1.06	1.35	0.14	2.13	Purple	P54	1 7/16	10
LCAF3/0-38H-X			3/8	1.06	1.35	0.14	2.20	Purple	P54	1 7/16	10
LCAF3/0-12H-X			1/2	1.06	1.35	0.14	2.43	Purple	P54	1 7/16	10
LCAF4/0-14H-X	4/0 AWG	4/0 AWG	1/4	1.17	1.35	0.14	2.16	Yellow	P62	1 7/16	10
LCAF4/0-56H-X			5/16	1.17	1.35	0.14	2.17	Yellow	P62	1 7/16	10
LCAF4/0-38H-X			3/8	1.17	1.35	0.14	2.24	Yellow	P62	1 7/16	10
LCAF4/0-12H-X			1/2	1.17	1.35	0.14	2.47	Yellow	P62	1 7/16	10
LCAF250-38H-X	250 kcmil	262.6 kcmil	3/8	1.28	1.65	0.17	3.19	White	P66	1 3/4	10
LCAF250-12H-X			1/2	1.28	1.65	0.17	2.89	White	P66	1 3/4	10
LCAF250-58H-X			5/8	1.28	1.65	0.17	3.10	White	P66	1 3/4	10
LCAF250-78H-X			7/8	1.28	1.65	0.17	3.54	White	P66	1 3/4	10
LCAF300-38H-6	300 kcmil	313.1 kcmil	3/8	1.39	1.64	0.18	3.00	Red	P71	1 3/4	6
LCAF300-12H-6			1/2	1.39	1.64	0.18	3.00	Red	P71	1 3/4	6
LCAF300-58H-6			5/8	1.39	1.64	0.18	3.21	Red	P71	1 3/4	6
LCAF300-78H-6			7/8	1.39	1.64	0.18	3.60	Red	P71	1 3/4	6
LCAF350-38H-6	350 kcmil	373.7 kcmil	3/8	1.54	1.84	0.22	3.06	Blue	P76	1 15/16	6
LCAF350-12H-6			1/2	1.54	1.84	0.22	3.22	Blue	P76	1 15/16	6
LCAF350-58H-6			5/8	1.54	1.84	0.22	3.43	Blue	P76	1 15/16	6
LCAF350-34H-6			3/4	1.54	1.84	0.22	3.57	Blue	P76	1 15/16	6
LCAF350-78H-6	400 kcmil	444.4 kcmil	7/8	1.54	1.84	0.22	3.82	Blue	P76	1 15/16	6
LCAF350-1H-6			1	1.54	1.84	0.22	3.94	Blue	P76	1 15/16	6
LCAF400-12H-6			1/2	1.70	2.19	0.26	4.12	Brown	P87	2 1/4	6
LCAF400-58H-6	400 kcmil	444.4 kcmil	5/8	1.70	2.19	0.26	4.12	Brown	P87	2 1/4	6
LCAF400-78H-6			7/8	1.70	2.19	0.26	4.12	Brown	P87	2 1/4	6

‡See pages D3.74, D3.75 for tool and die information.

\*\*Consult cable manufacturer for voltage stress relief instructions with applications greater than 2000 V.



## Flex Conductor, One-Hole, Standard Barrel with Window, Flared NEBS Lug, 90° Angle

For Use with Flexible and Extra-Flexible Copper Conductors

### Type LCAF-F

- Can be used with flex conductor class: K, M, and Diesel Locomotive
- Flared entry prevents bent back strands when inserting fine strand conductor into barrel
- Color-coded barrels marked with Panduit die index numbers for proper crimp die selection
- Inspection window to visually assure full conductor insertion
- Tin-plated to inhibit corrosion
- UL Listed and CSA Certified to 35 KV\*\* and temperature rated to 90°C when crimped with Panduit crimping tools and dies
- **Tested by Telcordia – meets NEBS Level 3**
- American Bureau of Shipping Approved



Part Number	Flex Conductor Size		Stud Hole Size (In.)	Figure Dimensions (In.)				Panduit Color Code	Panduit Die Index No.‡	Wire Strip Length (In.)	Std. Pkg. Qty.
	Class K and M	Diesel Locomotive		W	B	T	L				
LCAF8-10F-L	—	#8 AWG	#10	0.41	0.76	0.08	0.93	Red	P21	13/16	50
LCAF8-14F-L			1/4	0.48	0.76	0.07	1.02	Red	P21	13/16	50
LCAF8-56F-L			5/16	0.56	0.76	0.05	1.14	Red	P21	13/16	50
LCAF8-38F-L			3/8	0.60	0.76	0.05	1.24	Red	P21	13/16	50
LCAF6-10F-L	#6 AWG	#6 AWG	#10	0.45	0.81	0.09	1.52	Blue	P24	7/8	50
LCAF6-14F-L			1/4	0.48	0.81	0.08	1.06	Blue	P24	7/8	50
LCAF6-56F-L			5/16	0.56	0.81	0.07	1.18	Blue	P24	7/8	50
LCAF6-38F-L			3/8	0.62	0.81	0.06	1.28	Blue	P24	7/8	50
LCAF4-10F-L	#4 AWG	#4 AWG	#10	0.55	0.81	0.09	1.07	Gray	P29	7/8	50
LCAF4-14F-L			1/4	0.55	0.81	0.09	1.16	Gray	P29	7/8	50
LCAF4-56F-L			5/16	0.55	0.81	0.09	1.28	Gray	P29	7/8	50
LCAF4-38F-L			3/8	0.62	0.81	0.07	1.38	Gray	P29	7/8	50
LCAF2-14F-E	#2 AWG	#2 AWG	1/4	0.70	0.88	0.11	1.35	Brown	P33	15/16	20
LCAF2-56F-E			5/16	0.70	0.88	0.11	1.48	Brown	P33	15/16	20
LCAF2-38F-E			3/8	0.70	0.88	0.11	1.55	Brown	P33	15/16	20
LCAF2-12F-E			1/2	0.79	0.88	0.09	1.79	Brown	P33	15/16	20
LCAF1-14F-X	#1 AWG	#1 AWG	1/4	0.76	0.94	0.12	1.49	Pink	P42	1	10
LCAF1-56F-X			5/16	0.76	0.94	0.12	1.54	Pink	P42	1	10
LCAF1-38F-X			3/8	0.76	0.94	0.12	1.62	Pink	P42	1	10
LCAF1-12F-X			1/2	0.80	0.94	0.12	1.85	Pink	P42	1	10
LCAF1/0-14F-X	1/0 AWG	1/0 AWG	1/4	0.85	1.35	0.13	1.64	Black	P45	1 7/16	10
LCAF1/0-56F-X			5/16	0.85	1.35	0.13	1.70	Black	P45	1 7/16	10
LCAF1/0-38F-X			3/8	0.85	1.35	0.13	1.70	Black	P45	1 7/16	10
LCAF1/0-12F-X			1/2	0.85	1.35	0.13	1.95	Black	P45	1 7/16	10

‡See pages D3.74, D3.75 for tool and die information.

\*\*Consult cable manufacturer for voltage stress relief instructions with applications greater than 2000 V.

Table continues on page D2.78

A. System Overview

B1. Cable Ties

B2. Cable Accessories

B3. Stainless Steel Ties

C1. Wiring Duct

C2. Surface Raceway

C3. Abrasion Protection

C4. Cable Management

D1. Terminals

D2. Power Connectors

D3. Grounding Connectors

E1. Labeling Systems

E2. Labels

E3. Pre-Printed & Write-On Markers

E4. Permanent Identification

E5. Lockout/Tagout & Safety Solutions

F. Index

A. System Overview



## Flex Conductor, One-Hole, Standard Barrel with Window, Flared NEBS Lug, 90° Angle (continued)

B1. Cable Ties

B2. Cable Accessories

B3. Stainless Steel Ties

C1. Wiring Duct

C2. Surface Raceway

C3. Abrasion Protection

C4. Cable Management

D1. Terminals

D2. Power Connectors

D3. Grounding Connectors

E1. Labeling Systems

E2. Labels

E3. Pre-Printed & Write-On Markers

E4. Permanent Identification

E5. Lockout/Tagout & Safety Solutions

F. Index

Part Number	Flex Conductor Size		Stud Hole Size (In.)	Figure Dimensions (In.)				Panduit Color Code	Panduit Die Index No.‡	Wire Strip Length (In.)	Std. Pkg. Qty.
	Class K and M	Diesel Locomotive		W	B	T	L				
LCAF2/0-14F-X	2/0 AWG	2/0 AWG	1/4	0.96	1.35	0.13	1.71	Orange	P50	1 7/16	10
LCAF2/0-56F-X			5/16	0.96	1.35	0.13	1.71	Orange	P50	1 7/16	10
LCAF2/0-38F-X			3/8	0.96	1.35	0.13	1.77	Orange	P50	1 7/16	10
LCAF2/0-12F-X	3/0 AWG	3/0 AWG	1/2	0.96	1.35	0.13	2.02	Orange	P50	1 7/16	10
LCAF3/0-14F-X			1/4	1.06	1.35	0.14	1.81	Purple	P54	1 7/16	10
LCAF3/0-56F-X			5/16	1.06	1.35	0.14	1.82	Purple	P54	1 7/16	10
LCAF3/0-38F-X	4/0 AWG	4/0 AWG	3/8	1.06	1.35	0.14	1.89	Purple	P54	1 7/16	10
LCAF3/0-12F-X			1/2	1.06	1.35	0.14	2.12	Purple	P54	1 7/16	10
LCAF4/0-14F-X			1/4	1.17	1.35	0.14	1.88	Yellow	P62	1 7/16	10
LCAF4/0-56F-X	4/0 AWG	4/0 AWG	5/16	1.17	1.35	0.14	1.90	Yellow	P62	1 7/16	10
LCAF4/0-38F-X			3/8	1.17	1.35	0.14	1.97	Yellow	P62	1 7/16	10
LCAF4/0-12F-X			1/2	1.17	1.35	0.14	2.20	Yellow	P62	1 7/16	10
LCAF250-38F-X	250 kcmil	262.6 kcmil	3/8	1.28	1.65	0.17	2.21	White	P66	1 3/4	10
LCAF250-12F-X			1/2	1.28	1.65	0.17	2.32	White	P66	1 3/4	10
LCAF250-58F-X			5/8	1.28	1.65	0.17	2.53	White	P66	1 3/4	10
LCAF250-78F-X	300 kcmil	313.1 kcmil	7/8	1.28	1.65	0.17	2.97	White	P66	1 3/4	10
LCAF300-38F-6			3/8	1.39	1.65	0.18	2.44	Red	P71	1 3/4	6
LCAF300-12F-6			1/2	1.39	1.65	0.18	2.44	Red	P71	1 3/4	6
LCAF300-58F-6	350 kcmil	373.7 kcmil	5/8	1.39	1.65	0.18	2.65	Red	P71	1 3/4	6
LCAF300-78F-6			7/8	1.39	1.65	0.18	3.04	Red	P71	1 3/4	6
LCAF350-38F-6			3/8	1.54	1.85	0.22	2.40	Blue	P76	1 15/16	6
LCAF350-12F-6	400 kcmil	444.4 kcmil	1/2	1.54	1.85	0.22	2.40	Blue	P76	1 15/16	6
LCAF350-58F-6			5/8	1.54	1.85	0.22	2.77	Blue	P76	1 15/16	6
LCAF350-34F-6			3/4	1.54	1.85	0.22	2.91	Blue	P76	1 15/16	6
LCAF350-78F-6	400 kcmil	444.4 kcmil	7/8	1.54	1.85	0.22	3.16	Blue	P76	1 15/16	6
LCAF350-1F-6			1	1.54	1.85	0.22	3.28	Blue	P76	1 15/16	6
LCAF400-12F-6			1/2	1.70	2.20	0.26	3.28	Brown	P87	2 1/4	6
LCAF400-58F-6	400 kcmil	444.4 kcmil	5/8	1.70	2.20	0.26	3.28	Brown	P87	2 1/4	6
LCAF400-78F-6			7/8	1.70	2.20	0.26	3.28	Brown	P87	2 1/4	6

‡See pages D3.74, D3.75 for tool and die information.

\*\*Consult cable manufacturer for voltage stress relief instructions with applications greater than 2000 V.



## Flex Conductor, One-Hole, Long Barrel with Window Lug

For Use with Flexible, Extra-Flexible, and Code Stranded Copper Conductors

### Type LCBX

- Can be used with code conductor and flex conductor class: G, H, I, K, M and Diesel Locomotive
- Long barrel maximizes number of crimps and provides premium wire pull-out strength and electrical performance
- Generously beveled wire entry prevents bent back strands when inserting conductor into barrel
- Color-coded barrels marked with Panduit and specified competitor die index numbers for proper crimp die selection
- Inspection window to visually assure full conductor insertion
- Tin-plated to inhibit corrosion
- UL Listed and CSA Certified to 35 KV\*\* and temperature rated to 90°C when crimped with Panduit and specified competitor crimping tools and dies
- Meets J-STD-607-A and TIA-942 requirements for network systems grounding applications

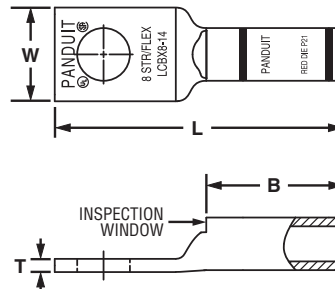

Part Number	Flex Conductor Size		Code Conductor Size	Stud Hole Size (In.)	Figure Dimensions (In.)				Panduit Color Code	Panduit Die Index No.‡	Burdny Die Index No.‡	T&B Die Index No.‡	Wire Strip Length (In.)	Std. Pkg. Qty.
	Class G, H, I, K, M	Diesel Locomotive			W	B	T	L						
LCBX8-10-L				#10	0.41	0.70	0.08	1.39	Red	P21	49	21	3/4	50
LCBX8-14-L	#8 AWG	#8 AWG	#8 AWG	1/4	0.48	0.70	0.07	1.48	Red	P21	49	21	3/4	50
LCBX8-38-L				3/8	0.60	0.70	0.05	1.70	Red	P21	49	21	3/4	50
LCBX6-14-L	#6 AWG	#6 AWG	#6 AWG	1/4	0.48	1.07	0.08	1.86	Blue	P24	7	24	1 1/8	50
LCBX6-38-L				3/8	0.62	1.07	0.06	2.08	Blue	P24	7	24	1 1/8	50
LCBX4-14-L	#4 AWG	#5, #4, #3 AWG	#4 AWG	1/4	0.55	1.05	0.09	1.87	Gray	P29	8	29	1 1/8	50
LCBX4-38-L				3/8	0.62	1.05	0.07	2.09	Gray	P29	8	29	1 1/8	50
LCBX2-14-E*	#2 AWG	#2 AWG	#2 AWG	1/4	0.70	1.36	0.11	2.26	Brown	P33	10	33	1 7/16	20
LCBX2-38-E*				3/8	0.70	1.36	0.11	2.46	Brown	P33	10	33	1 7/16	20
LCBX2-12-E*				1/2	0.75	1.36	0.09	2.70	Brown	P33	10	33	1 7/16	20
LCBX1-14-X	#1 AWG	#1 AWG	#1 AWG	1/4	0.76	1.44	0.12	2.44	Green	P37	11	37	1 1/2	10
LCBX1-56-X				5/16	0.76	1.44	0.12	2.50	Green	P37	11	37	1 1/2	10
LCBX1-38-X				3/8	0.76	1.44	0.12	2.57	Green	P37	11	37	1 1/2	10
LCBX1/0-14-X	1/0 AWG	1/0 AWG	1/0 AWG	1/4	0.85	1.50	0.13	2.61	Pink	P42	12	42	1 9/16	10
LCBX1/0-38-X				3/8	0.85	1.50	0.13	2.67	Pink	P42	12	42	1 9/16	10
LCBX1/0-12-X				1/2	0.85	1.50	0.13	2.92	Pink	P42	12	42	1 9/16	10
LCBX2/0-14-X	2/0 AWG	2/0 AWG	2/0 AWG	1/4	0.96	1.50	0.13	2.64	Black	P45	13	45	1 9/16	10
LCBX2/0-38-X				3/8	0.96	1.50	0.13	2.70	Black	P45	13	45	1 9/16	10
LCBX2/0-12-X				1/2	0.96	1.50	0.13	2.96	Black	P45	13	45	1 9/16	10
LCBX3/0-38-X	3/0 AWG	3/0 AWG	3/0 AWG	3/8	1.06	1.56	0.14	2.81	Orange	P50	14	50	1 5/8	10
LCBX4/0-38-X	4/0 AWG	4/0 AWG	4/0 AWG	3/8	1.19	2.24	0.16	3.74	Purple	P54	15	54	2 5/16	10
LCBX4/0-12-X				1/2	1.19	2.24	0.16	3.85	Purple	P54	15	54	2 5/16	10
LCBX250-38-X	250 kcmil	262.6 kcmil	—	3/8	1.28	2.24	0.17	3.78	Yellow	P62	16	62	2 5/16	10
LCBX250-12-X			—	1/2	1.28	2.24	0.17	3.89	Yellow	P62	16	62	2 5/16	10
LCBX250-58-X			—	5/8	1.28	2.24	0.17	4.10	Yellow	P62	16	62	2 5/16	10
LCBX300-38-6	300 kcmil	313.1 kcmil	—	3/8	1.39	2.30	0.18	4.02	Red	P71	18	71H	2 3/8	6
LCBX350-38-6	350 kcmil	373.7 kcmil	—	3/8	1.54	2.50	0.22	4.14	Blue	P76	19	76H	2 9/16	6
LCBX350-12-6			—	1/2	1.54	2.50	0.22	4.30	Blue	P76	19	76H	2 9/16	6
LCBX450-38-6	450 kcmil	444.4 kcmil	—	3/8	1.70	2.69	0.26	5.14	Brown	P87	20	87H	2 3/4	6
LCBX500-38-6	500 kcmil	535.3 kcmil	—	3/8	1.89	2.88	0.26	4.84	Pink	P99	L99	99H	2 15/16	6
LCBX500-12-6			—	1/2	1.89	2.88	0.26	5.03	Pink	P99	L99	99H	2 15/16	6

‡See pages D3.70 – D3.73 for tool and die information.

\*Not UL Listed or CSA Certified with Class K flex conductor when crimped with Burdny tools.

\*\*Consult cable manufacturer for voltage stress relief instructions with applications greater than 2000 V.

A. System Overview

B1. Cable Ties

B2. Cable Accessories

B3. Stainless Steel Ties

C1. Wiring Duct

C2. Surface Raceway

C3. Abrasion Protection

C4. Cable Management

D1. Terminals

D2. Power Connectors

D3. Grounding Connectors

E1. Labeling Systems

E2. Labels

E3. Pre-Printed & Write-On Markers

E4. Permanent Identification

E5. Lockout/Tagout & Safety Solutions

F. Index

A. System Overview



## Flex Conductor, One-Hole, Long Barrel with Window Lug, 45° Angle

B1. Cable Ties

**For Use with Flexible, Extra-Flexible, and Code Stranded Copper Conductors**

### Type LCBX-H

- Can be used with code conductor and flex conductor class: G, H, I, K, M and Diesel Locomotive
- Long barrel maximizes number of crimps and provides premium wire pull-out strength and electrical performance
- Generously beveled wire entry prevents bent back strands when inserting conductor into barrel
- Color-coded barrels marked with Panduit and specified competitor die index numbers for proper crimp die selection
- Inspection window to visually assure full conductor insertion
- Tin-plated to inhibit corrosion
- UL Listed and CSA Certified to 35 KV\*\* and temperature rated to 90°C when crimped with Panduit and specified competitor crimping tools and dies
- Meets J-STD-607-A and TIA-942 requirements for network systems grounding applications

C1. Wiring Duct

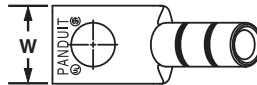

C2. Surface Raceway

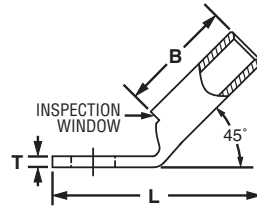

C3. Abrasion Protection

C4. Cable Management

D1. Terminals

D2. Power Connectors

D3. Grounding Connectors

E1. Labeling Systems

E2. Labels

E3. Pre-Printed & Write-On Markers

E4. Permanent Identification

E5. Lockout/Tagout & Safety Solutions

F. Index

Part Number	Flex Conductor Size		Code Conductor Size	Stud Hole Size (In.)	Figure Dimensions (In.)				Panduit Color Code	Panduit Die Index No.†	Burdny Die Index No.†	T&B Die Index No.†	Wire Strip Length (In.)	Std. Pkg. Qty.
	Class G, H, I, K, M	Diesel Locomotive			W	B	T	L						
<b>LCBX8-10H-L</b>				#10	0.41	0.70	0.08	1.20	Red	P21	49	21	3/4	50
<b>LCBX8-14H-L</b>	#8 AWG	#8 AWG	#8 AWG	1/4	0.48	0.70	0.07	1.28	Red	P21	49	21	3/4	50
<b>LCBX8-38H-L</b>				3/8	0.60	0.70	0.05	1.49	Red	P21	49	21	3/4	50
<b>LCBX6-14H-L</b>	#6 AWG	#6 AWG	#6 AWG	1/4	0.48	1.07	0.08	1.56	Blue	P24	7	24	1 1/8	50
<b>LCBX6-38H-L</b>				3/8	0.62	1.07	0.06	1.77	Blue	P24	7	24	1 1/8	50
<b>LCBX4-14H-L</b>	#4 AWG	#5, #4, #3 AWG	#4 AWG	1/4	0.55	1.05	0.09	1.57	Gray	P29	8	29	1 1/8	50
<b>LCBX4-38H-L</b>				3/8	0.62	1.05	0.07	1.78	Gray	P29	8	29	1 1/8	50
<b>LCBX2-14H-E*</b>				1/4	0.70	1.36	0.11	1.83	Brown	P33	10	33	1 7/16	20
<b>LCBX2-38H-E*</b>	#2 AWG	#2 AWG	#2 AWG	3/8	0.70	1.36	0.11	2.03	Brown	P33	10	33	1 7/16	20
<b>LCBX2-12H-E*</b>				1/2	0.75	1.36	0.09	2.26	Brown	P33	10	33	1 7/16	20
<b>LCBX1-14H-X</b>				1/4	0.76	1.44	0.12	1.98	Green	P37	11	37	1 1/2	10
<b>LCBX1-56H-X</b>	#1 AWG	#1 AWG	#1 AWG	5/16	0.76	1.44	0.12	2.04	Green	P37	11	37	1 1/2	10
<b>LCBX1-38H-X</b>				3/8	0.76	1.44	0.12	2.11	Green	P37	11	37	1 1/2	10
<b>LCBX1/0-14H-X</b>				1/4	0.85	1.50	0.13	2.13	Pink	P42	12	42	1 9/16	10
<b>LCBX1/0-38H-X</b>	1/0 AWG	1/0 AWG	1/0 AWG	3/8	0.85	1.50	0.13	2.20	Pink	P42	12	42	1 9/16	10
<b>LCBX1/0-12H-X</b>				1/2	0.85	1.50	0.13	2.45	Pink	P42	12	42	1 9/16	10
<b>LCBX2/0-14H-X</b>				1/4	0.96	1.50	0.13	2.16	Black	P45	13	45	1 9/16	10
<b>LCBX2/0-38H-X</b>	2/0 AWG	2/0 AWG	2/0 AWG	3/8	0.96	1.50	0.13	2.22	Black	P45	13	45	1 9/16	10
<b>LCBX2/0-12H-X</b>				1/2	0.96	1.50	0.13	2.47	Black	P45	13	45	1 9/16	10
<b>LCBX3/0-38H-X</b>	3/0 AWG	3/0 AWG	3/0 AWG	3/8	1.06	1.56	0.14	2.31	Orange	P50	14	50	1 5/8	10
<b>LCBX4/0-38H-X</b>				3/8	1.19	2.24	0.16	3.12	Purple	P54	15	54	2 5/16	10
<b>LCBX4/0-12H-X</b>	4/0 AWG	4/0 AWG	4/0 AWG	1/2	1.19	2.24	0.16	3.23	Purple	P54	15	54	2 5/16	10
<b>LCBX250-38H-X</b>	250 kcmil	262.6 kcmil	—	3/8	1.28	2.24	0.17	3.15	Yellow	P62	16	62	2 5/16	10
<b>LCBX300-38H-6</b>	300 kcmil	313.1 kcmil	—	3/8	1.39	2.30	0.18	3.42	Red	P71	18	71H	2 3/8	6
<b>LCBX300-12H-6</b>				1/2	1.39	2.30	0.18	3.69	Red	P71	18	71H	2 3/8	6
<b>LCBX350-38H-6</b>	350 kcmil	373.7 kcmil	—	3/8	1.54	2.50	0.22	3.48	Blue	P76	19	76H	2 9/16	6
<b>LCBX350-12H-6</b>				1/2	1.54	2.50	0.22	3.64	Blue	P76	19	76H	2 9/16	6
<b>LCBX450-38H-6</b>	450 kcmil	444.4 kcmil	—	3/8	1.70	2.69	0.26	4.42	Brown	P87	20	87H	2 3/4	6
<b>LCBX500-38H-6</b>	500 kcmil	535.3 kcmil	—	3/8	1.89	2.88	0.26	4.08	Pink	P99	L99	99H	2 15/16	6
<b>LCBX500-12H-6</b>				1/2	1.89	2.88	0.26	4.27	Pink	P99	L99	99H	2 15/16	6

†See pages D3.70 – D3.73 for tool and die information.

\*Not UL Listed or CSA Certified with Class K flex conductor when crimped with Burndy tools.

\*\*Consult cable manufacturer for voltage stress relief instructions with applications greater than 2000 V.



## Flex Conductor, One-Hole, Long Barrel with Window Lug, 90° Angle

For Use with Flexible, Extra-Flexible, and Code Stranded Copper Conductors

### Type LCBX-F

- Can be used with code conductor and flex conductor class: G, H, I, K, M and Diesel Locomotive
- Long barrel maximizes number of crimps and provides premium wire pull-out strength and electrical performance
- Generously beveled wire entry prevents bent back strands when inserting conductor into barrel
- Color-coded barrels marked with Panduit and specified competitor die index numbers for proper crimp die selection
- Inspection window to visually assure full conductor insertion
- Tin-plated to inhibit corrosion
- UL Listed and CSA Certified to 35 KV\*\* and temperature rated to 90°C when crimped with Panduit and specified competitor crimping tools and dies
- Meets J-STD-607-A and TIA-942 requirements for network systems grounding applications

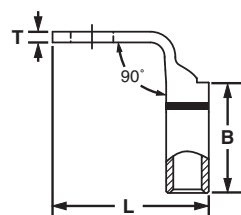

Part Number	Flex Conductor Size		Code Conductor Size	Stud Hole Size (In.)	Figure Dimensions (In.)				Panduit Color Code	Panduit Die Index No.‡	Burndy Die Index No.‡	T&B Die Index No.‡	Wire Strip Length (In.)	Std. Pkg. Qty.
	Class G, H, I, K, M	Diesel Locomotive			W	B	T	L						
LCBX8-10F-L				#10	0.41	0.70	0.08	0.90	Red		49	21	3/4	50
LCBX8-14F-L	#8 AWG	#8 AWG	#8 AWG	1/4	0.48	0.70	0.07	0.99	Red	P21	49	21	3/4	50
LCBX8-38F-L				3/8	0.60	0.70	0.05	1.21	Red	P21	49	21	3/4	50
LCBX6-14F-L	#6 AWG	#6 AWG	#6 AWG	1/4	0.48	1.07	0.08	1.03	Blue	P24	7	24	1 1/8	50
LCBX6-38F-L				3/8	0.62	1.07	0.06	1.25	Blue	P24	7	24	1 1/8	50
LCBX4-14F-L	#4 AWG	#5, #4, #3 AWG	#4 AWG	1/4	0.55	1.05	0.09	1.12	Gray	P29	8	29	1 1/8	50
LCBX4-38F-L				3/8	0.62	1.05	0.07	1.34	Gray	P29	8	29	1 1/8	50
LCBX2-14F-E*	#2 AWG	#2 AWG	#2 AWG	1/4	0.70	1.36	0.11	1.31	Brown	P33	10	33	1 7/16	20
LCBX2-38F-E*				3/8	0.70	1.36	0.11	1.51	Brown	P33	10	33	1 7/16	20
LCBX2-12F-E*				1/2	0.75	1.36	0.09	1.75	Brown	P33	10	33	1 7/16	20
LCBX1-14F-X	#1 AWG	#1 AWG	#1 AWG	1/4	0.76	1.44	0.12	1.45	Green	P37	11	37	1 1/2	10
LCBX1-56F-X				5/16	0.76	1.44	0.12	1.51	Green	P37	11	37	1 1/2	10
LCBX1-38F-X				3/8	0.76	1.44	0.12	1.58	Green	P37	11	37	1 1/2	10
LCBX1/0-14F-X	1/0 AWG	1/0 AWG	1/0 AWG	1/4	0.85	1.50	0.13	1.61	Pink	P42	12	42	1 9/16	10
LCBX1/0-38F-X				3/8	0.85	1.50	0.13	1.66	Pink	P42	12	42	1 9/16	10
LCBX1/0-12F-X				1/2	0.85	1.50	0.13	1.91	Pink	P42	12	42	1 9/16	10
LCBX2/0-14F-X	2/0 AWG	2/0 AWG	2/0 AWG	1/4	0.96	1.50	0.13	1.67	Black	P45	13	45	1 9/16	10
LCBX2/0-38F-X				3/8	0.96	1.50	0.13	1.73	Black	P45	13	45	1 9/16	10
LCBX2/0-12F-X				1/2	0.96	1.50	0.13	1.98	Black	P45	13	45	1 9/16	10
LCBX3/0-38F-X	3/0 AWG	3/0 AWG	3/0 AWG	3/8	1.06	1.56	0.14	1.84	Orange	P50	14	50	1 5/8	10
LCBX4/0-38F-X	4/0 AWG	4/0 AWG	4/0 AWG	3/8	1.19	2.24	0.16	2.07	Purple	P54	15	54	2 5/16	10
LCBX4/0-12F-X				1/2	1.19	2.24	0.16	2.18	Purple	P54	15	54	2 5/16	10
LCBX250-38F-X	250 kcmil	262.6 kcmil	—	3/8	1.28	2.24	0.17	2.13	Yellow	P62	16	62	2 5/16	10
LCBX300-38F-6	300 kcmil	313.1 kcmil	—	3/8	1.39	2.30	0.18	2.37	Red	P71	18	71H	2 3/8	6
LCBX300-12F-6				1/2	1.39	2.30	0.18	2.37	Red	P71	18	71H	2 3/8	6
LCBX350-38F-6	350 kcmil	373.7 kcmil	—	3/8	1.54	2.50	0.22	2.32	Blue	P76	19	76H	2 9/16	6
LCBX350-12F-6				1/2	1.54	2.50	0.22	2.48	Blue	P76	19	76H	2 9/16	6
LCBX450-38F-6	450 kcmil	444.4 kcmil	—	3/8	1.70	2.69	0.26	3.14	Brown	P87	20	87H	2 3/4	6
LCBX500-38F-6	500 kcmil	535.3 kcmil	—	3/8	1.89	2.88	0.26	2.62	Pink	P99	L99	99H	2 15/16	6
LCBX500-12F-6				1/2	1.89	2.88	0.26	2.81	Pink	P99	L99	99H	2 15/16	6

‡See pages D3.70 – D3.73 for tool and die information.

\*Not UL Listed or CSA Certified with Class K flex conductor when crimped with Burndy tools.

\*\*Consult cable manufacturer for voltage stress relief instructions with applications greater than 2000 V.

A. System Overview

B1. Cable Ties

B2. Cable Accessories

B3. Stainless Steel Ties

C1. Wiring Duct

C2. Surface Raceway

C3. Abrasion Protection

C4. Cable Management

D1. Terminals

D2. Power Connectors

D3. Grounding Connectors

E1. Labeling Systems

E2. Labels

E3. Pre-Printed & Write-On Markers

E4. Permanent Identification

E5. Lockout/Tagout & Safety Solutions

F. Index

A. System Overview



## Flex Conductor, Two-Hole, Standard Barrel with Window Lug

B1. Cable Ties

**For Use with Flexible, Extra-Flexible, and Code Stranded Copper Conductors**

### Type LCDX

B2. Cable Accessories

- Can be used with code conductor and flex conductor class: G, H, I, K, M and Diesel Locomotive
- Generously beveled wire entry prevents bent back strands when inserting conductor into barrel
- Color-coded barrels marked with Panduit and specified competitor die index numbers for proper crimp die selection
- Inspection window to visually assure full conductor insertion
- Tin-plated to inhibit corrosion
- UL Listed and CSA Certified to 35 KV\*\* and temperature rated to 90°C when crimped with Panduit and specified competitor crimping tools and dies
- American Bureau of Shipping approved
- Available with NEMA hole sizes and spacing

B3. Stainless Steel Ties

C1. Wiring Duct

C2. Surface Raceway

C3. Abrasion Protection

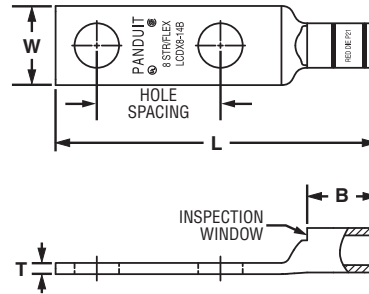

C4. Cable Management

D1. Terminals

D2. Power Connectors

D3. Grounding Connectors

E1. Labeling Systems

E2. Labels

E3. Pre-Printed & Write-On Markers

E4. Permanent Identification

E5. Lockout/Tagout & Safety Solutions

F. Index

Part Number	Flex Conductor Size		Code Conductor Size	Stud Hole Size (In.)	Stud Hole Spacing (In.)	Figure Dimensions (In.)				Panduit Color Code	Panduit Die Index No.‡	Burndy Die Index No.‡	T&B Die Index No.‡	Wire Strip Length (In.)	Std. Pkg. Qty.
	Class G, H, I, K, M	Diesel Locomotive				W	B	T	L						
LCDX8-10A-L				#10	.63	.41	.42	.08	1.74	Red	P21	49	21	1/2	50
LCDX8-14A-L				1/4	.63	.48	.42	.07	1.83	Red	P21	49	21	1/2	50
LCDX8-14B-L	#8 AWG	#8 AWG	#8 AWG	1/4	.75	.48	.42	.07	1.95	Red	P21	49	21	1/2	50
LCDX8-14D-L				1/4	1.00	.48	.42	.07	2.20	Red	P21	49	21	1/2	50
LCDX8-38D-L				3/8	1.00	.60	.42	.05	2.42	Red	P21	49	21	1/2	50
LCDX6-10A-L				#10	.63	.46	.48	.08	1.82	Blue	P24	7	24	9/16	50
LCDX6-10B-L				#10	.75	.46	.48	.08	1.94	Blue	P24	7	24	9/16	50
LCDX6-10G-L				#10	1.50	.46	.48	.08	2.69	Blue	P24	7	24	9/16	50
LCDX6-10P-L				#10	.69	.46	.48	.08	1.88	Blue	P24	7	24	9/16	50
LCDX6-14A-L	#6 AWG	#6 AWG	#6 AWG	1/4	.63	.48	.48	.08	1.91	Blue	P24	7	24	9/16	50
LCDX6-14B-L				1/4	.75	.48	.48	.08	2.03	Blue	P24	7	24	9/16	50
LCDX6-14D-L				1/4	1.00	.48	.48	.08	2.28	Blue	P24	7	24	9/16	50
LCDX6-56D-L				5/16	1.00	.56	.48	.07	2.40	Blue	P24	7	24	9/16	50
LCDX6-38D-L				3/8	1.00	.62	.48	.06	2.50	Blue	P24	7	24	9/16	50
LCDX4-14A-L				1/4	.63	.55	.53	.09	1.98	Gray	P29	8	29	5/8	50
LCDX4-14B-L				1/4	.75	.55	.53	.09	2.10	Gray	P29	8	29	5/8	50
LCDX4-14D-L	#4 AWG	#5, #4, #3 AWG	#4 AWG	1/4	1.00	.55	.53	.09	2.35	Gray	P29	8	29	5/8	50
LCDX4-56D-L				5/16	1.00	.55	.53	.09	2.47	Gray	P29	8	29	5/8	50
LCDX4-38D-L				3/8	1.00	.62	.53	.08	2.57	Gray	P29	8	29	5/8	50
LCDX2-14A-E*				1/4	.63	.70	.59	.11	2.13	Brown	P33	10	33	11/16	20
LCDX2-14B-E*				1/4	.75	.70	.59	.11	2.25	Brown	P33	10	33	11/16	20
LCDX2-14D-E*				1/4	1.00	.70	.59	.11	2.50	Brown	P33	10	33	11/16	20
LCDX2-56D-E*	#2 AWG	#2 AWG	#2 AWG	5/16	1.00	.70	.59	.11	2.63	Brown	P33	10	33	11/16	20
LCDX2-38D-E*				3/8	1.00	.70	.59	.11	2.70	Brown	P33	10	33	11/16	20
LCDX2-12-E*				1/2	1.75	.75	.59	.09	3.87	Brown	P33	10	33	11/16	20
LCDX1-14A-X				1/4	.63	.76	.66	.12	2.29	Green	P37	11	37	3/4	10
LCDX1-14B-X				1/4	.75	.76	.66	.12	2.42	Green	P37	11	37	3/4	10
LCDX1-14D-X				1/4	1.00	.76	.66	.12	2.67	Green	P37	11	37	3/4	10
LCDX1-56D-X	#1 AWG	#1 AWG	#1 AWG	5/16	1.00	.76	.66	.12	2.72	Green	P37	11	37	3/4	10
LCDX1-38D-X				3/8	1.00	.76	.66	.12	2.80	Green	P37	11	37	3/4	10
LCDX1-12-X				1/2	1.75	.80	.66	.12	3.97	Green	P37	11	37	3/4	10

‡See pages D3.70 – D3.73 for tool and die information.

\*Not UL Listed or CSA Certified with Class K flex conductor when crimped with Burndy tools.

\*\*Consult cable manufacturer for voltage stress relief instructions with applications greater than 2000 V.

◆NEMA hole sizes and spacing.





## Flex Conductor, Two-Hole, Standard Barrel with Window Lug (continued)

Part Number	Flex Conductor Size		Code Conductor Size	Stud Hole Size (In.)	Stud Hole Spacing (In.)	Figure Dimensions (In.)				Panduit Color Code	Panduit Die Index No.‡	Burndy Die Index No.‡	T&B Die Index No.‡	Wire Strip Length (In.)	Std. Pkg. Qty.
	Class G, H, I, K, M	Diesel Locomotive				W	B	T	L						
LCDX1/0-14A-X	1/0 AWG	1/0 AWG	1/0 AWG	1/4	.63	.85	.72	.13	2.45	Pink	P42	12	42	3/4	10
LCDX1/0-14B-X				1/4	.75	.85	.72	.13	2.57	Pink	P42	12	42	3/4	10
LCDX1/0-56B-X				5/16	.75	.85	.72	.13	2.57	Pink	P42	12	42	3/4	10
LCDX1/0-56D-X				5/16	1.00	.85	.72	.13	2.82	Pink	P42	12	42	3/4	10
LCDX1/0-38D-X				3/8	1.00	.85	.72	.13	2.89	Pink	P42	12	42	3/4	10
LCDX1/0-12D-X				1/2	1.00	.85	.72	.13	3.14	Pink	P42	12	42	3/4	10
LCDX1/0-12-X				1/2	1.75	.85	.72	.13	4.05	Pink	P42	12	42	3/4	10
LCDX2/0-14A-X	2/0 AWG	2/0 AWG	2/0 AWG	1/4	.63	.96	.83	.13	2.59	Black	P45	13	45	7/8	10
LCDX2/0-14B-X				1/4	.75	.96	.83	.13	2.72	Black	P45	13	45	7/8	10
LCDX2/0-56D-X				5/16	1.00	.96	.83	.13	2.97	Black	P45	13	45	7/8	10
LCDX2/0-38D-X				3/8	1.00	.96	.83	.13	3.03	Black	P45	13	45	7/8	10
LCDX2/0-12D-X				1/2	1.00	.96	.83	.13	3.28	Black	P45	13	45	7/8	10
LCDX2/0-12-X	1/2	1.75	.96	.83	.13	4.19	Black	P45	13	45	7/8	10			
LCDX3/0-14A-X	3/0 AWG	3/0 AWG	3/0 AWG	1/4	.63	1.06	.91	.14	2.71	Orange	P50	14	50	1	10
LCDX3/0-56D-X				5/16	1.00	1.06	.91	.14	3.10	Orange	P50	14	50	1	10
LCDX3/0-38D-X				3/8	1.00	1.06	.91	.14	3.17	Orange	P50	14	50	1	10
LCDX3/0-12-X				1/2	1.75	1.06	.91	.14	4.31	Orange	P50	14	50	1	10
LCDX4/0-14A-X	4/0 AWG	4/0 AWG	4/0 AWG	1/4	.63	1.19	1.03	.16	2.74	Purple	P54	15	54	1 1/16	10
LCDX4/0-14B-X				1/4	.75	1.19	1.03	.16	2.96	Purple	P54	15	54	1 1/16	10
LCDX4/0-56D-X				5/16	1.00	1.19	1.03	.16	3.31	Purple	P54	15	54	1 1/16	10
LCDX4/0-38D-X				3/8	1.00	1.19	1.03	.16	3.34	Purple	P54	15	54	1 1/16	10
LCDX4/0-12D-X				1/2	1.00	1.19	1.03	.16	3.61	Purple	P54	15	54	1 1/16	10
LCDX4/0-12E-X				1/2	1.25	1.19	1.03	.16	3.89	Purple	P54	15	54	1 1/16	10
LCDX4/0-12-X				1/2	1.75	1.19	1.03	.16	4.52	Purple	P54	15	54	1 1/16	10
LCDX250-38D-X	250 kcmil	262.6 kcmil	—	3/8	1.00	1.28	1.03	.17	3.38	Yellow	P62	16	62	1 1/16	10
LCDX250-38-X				3/8	1.75	1.28	1.03	.17	4.13	Yellow	P62	16	62	1 1/16	10
LCDX250-12E-X				1/2	1.25	1.28	1.03	.17	3.93	Yellow	P62	16	62	1 1/16	10
LCDX250-12-X	1/2	1.75	1.28	1.03	.17	4.56	Yellow	P62	16	62	1 1/16	10			
LCDX300-38D-6	300 kcmil	313.1 kcmil	—	3/8	1.00	1.39	1.19	.18	3.56	Red	P71	18	71H	1 1/4	6
LCDX300-12-6				1/2	1.75	1.39	1.19	.18	4.74	Red	P71	18	71H	1 1/4	6
LCDX350-56D-6	350 kcmil	373.7 kcmil	—	5/16	1.00	1.54	1.29	.22	3.71	Blue	P76	19	76H	1 3/8	6
LCDX350-38D-6				3/8	1.00	1.54	1.29	.22	3.74	Blue	P76	19	76H	1 3/8	6
LCDX350-38-6				3/8	1.75	1.54	1.29	.22	4.49	Blue	P76	19	76H	1 3/8	6
LCDX350-12E-6				1/2	1.25	1.54	1.29	.22	4.29	Blue	P76	19	76H	1 3/8	6
LCDX350-12-6				1/2	1.75	1.54	1.29	.22	4.92	Blue	P76	19	76H	1 3/8	6
LCDX450-38D-6	450 kcmil	444.4 kcmil	—	3/8	1.00	1.70	1.40	.26	3.90	Brown	P87	20	87H	1 7/16	6
LCDX450-12-6				1/2	1.75	1.70	1.40	.26	5.08	Brown	P87	20	87H	1 7/16	6
LCDX500-56D-6	500 kcmil	535.3 kcmil	—	5/16	1.00	1.89	1.48	.26	4.05	Pink	P99	L99	99H	1 9/16	6
LCDX500-38D-6				3/8	1.00	1.89	1.48	.26	4.08	Pink	P99	L99	99H	1 9/16	6
LCDX500-12E-6				1/2	1.25	1.89	1.48	.26	4.76	Pink	P99	L99	99H	1 9/16	6
LCDX500-12-6	1/2	1.75	1.89	1.48	.26	5.26	Pink	P99	L99	99H	1 9/16	6			
LCDX600-12-6	600 kcmil	—	—	1/2	1.75	1.89	1.48	.26	5.26	Pink	P99	400	99H	1 9/16	6
LCDX650-38D-6	—	646.4 kcmil	—	3/8	1.00	1.95	1.45	.30	4.08	Black	P106	24	106H	1 1/2	6
LCDX650-12-6				1/2	1.75	1.95	1.45	.30	5.26	Black	P106	24	106H	1 1/2	6
LCDX750-38D-3	—	777.7 kcmil	—	3/8	1.00	2.17	1.66	.32	4.62	Yellow	P115	L115	115H	1 3/4	3
LCDX750-12E-3				1/2	1.25	2.17	1.66	.32	5.06	Yellow	P115	L115	115H	1 3/4	3
LCDX750-12G-3				1/2	1.50	2.17	1.66	.32	5.31	Yellow	P115	L115	115H	1 3/4	3
LCDX750-12-3				1/2	1.75	2.17	1.66	.32	5.56	Yellow	P115	L115	115H	1 3/4	3
LCDX750-58G-3	5/8	1.50	2.17	1.66	.32	5.37	Yellow	P115	L115	115H	1 3/4	3			

‡See pages D3.70 – D3.73 for tool and die information.

\*Not UL Listed or CSA Certified with Class K flex conductor when crimped with Burndy tools.

\*\*Consult cable manufacturer for voltage stress relief instructions with applications greater than 2000 V.

◆NEMA hole sizes and spacing.

A.  
System Overview

B1.  
Cable Ties

B2.  
Cable Accessories

B3.  
Stainless Steel Ties

C1.  
Wiring Duct

C2.  
Surface Raceway

C3.  
Abrasion Protection

C4.  
Cable Management

D1.  
Terminals

D2.  
Power Connectors

D3.  
Grounding Connectors

E1.  
Labeling Systems

E2.  
Labels

E3.  
Pre-Printed & Write-On Markers

E4.  
Permanent Identification

E5.  
Lockout/Tagout & Safety Solutions

F.  
Index

A. System Overview



## Flex Conductor, Two-Hole, Standard Barrel with Window Lug, 45° Angle

B1. Cable Ties

**For Use with Flexible, Extra-Flexible, and Code Stranded Copper Conductors**

B2. Cable Accessories

### Type LCDX-H

- Can be used with code conductor and flex conductor class: G, H, I, K, M and Diesel Locomotive
- Generously beveled wire entry prevents bent back strands when inserting conductor into barrel
- Color-coded barrels marked with Panduit and specified competitor die index numbers for proper crimp die selection
- Inspection window to visually assure full conductor insertion
- Tin-plated to inhibit corrosion
- UL Listed and CSA Certified to 35 KV\*\* and temperature rated to 90°C when crimped with Panduit and specified competitor crimping tools and dies
- American Bureau of Shipping approved
- Available with NEMA hole sizes and spacing

B3. Stainless Steel Ties

C1. Wiring Duct



C2. Surface Raceway

C3. Abrasion Protection

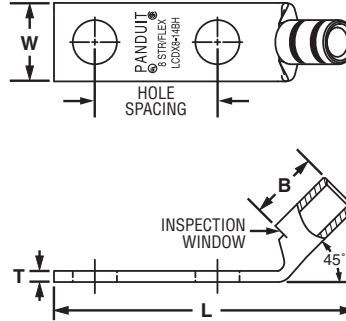

C4. Cable Management

D1. Terminals

D2. Power Connectors

D3. Grounding Connectors

E1. Labeling Systems

E2. Labels

E3. Pre-Printed & Write-On Markers

E4. Permanent Identification

E5. Lockout/Tagout & Safety Solutions

F. Index

Part Number	Flex Conductor Size		Code Conductor Size	Stud Hole Size (In.)	Stud Hole Spacing (In.)	Figure Dimensions (In.)				Panduit Color Code	Panduit Die Index No.†	Burndy Die Index No.‡	T&B Die Index No.‡	Wire Strip Length (In.)	Std. Pkg. Qty.
	Class G, H, I, K, M	Diesel Locomotive				W	B	T	L						
LCDX8-10AH-L	#8 AWG	#8 AWG	#8 AWG	#10	.63	.41	.42	.08	1.63	Red	P21	49	21	1/2	50
LCDX8-14AH-L				1/4	.63	.48	.42	.07	1.71	Red	P21	49	21	1/2	50
LCDX8-14BH-L				1/4	.75	.48	.42	.07	1.84	Red	P21	49	21	1/2	50
LCDX8-14DH-L				1/4	1.00	.48	.42	.07	2.09	Red	P21	49	21	1/2	50
LCDX8-38DH-L	#6 AWG	#6 AWG	#6 AWG	3/8	1.00	.60	.42	.05	2.30	Red	P21	49	21	1/2	50
LCDX6-10AH-L				#10	.63	.46	.48	.08	1.68	Blue	P24	7	24	9/16	50
LCDX6-10BH-L				#10	.75	.46	.48	.08	1.81	Blue	P24	7	24	9/16	50
LCDX6-10GH-L				#10	1.50	.46	.48	.08	2.56	Blue	P24	7	24	9/16	50
LCDX6-10PH-L	#6 AWG	#6 AWG	#6 AWG	#10	.69	.46	.48	.08	1.74	Blue	P24	7	24	9/16	50
LCDX6-14AH-L				1/4	.63	.48	.48	.08	1.77	Blue	P24	7	24	9/16	50
LCDX6-14BH-L				1/4	.75	.48	.48	.08	1.89	Blue	P24	7	24	9/16	50
LCDX6-14DH-L				1/4	1.00	.48	.48	.08	2.14	Blue	P24	7	24	9/16	50
LCDX6-56DH-L	#4 AWG	#5, #4, #3 AWG	#4 AWG	5/16	1.00	.56	.48	.07	2.26	Blue	P24	7	24	9/16	50
LCDX6-38DH-L				3/8	1.00	.62	.48	.06	2.35	Blue	P24	7	24	9/16	50
LCDX4-14AH-L				1/4	.63	.55	.53	.09	1.83	Gray	P29	8	29	5/8	50
LCDX4-14BH-L				1/4	.75	.55	.53	.09	1.96	Gray	P29	8	29	5/8	50
LCDX4-14DH-L	#2 AWG	#2 AWG	#2 AWG	1/4	1.00	.55	.53	.09	2.21	Gray	P29	8	29	5/8	50
LCDX4-56DH-L				5/16	1.00	.55	.53	.09	2.33	Gray	P29	8	29	5/8	50
LCDX4-38DH-L				3/8	1.00	.62	.53	.08	2.42	Gray	P29	8	29	5/8	50
LCDX2-14AH-E*				1/4	.63	.70	.59	.11	1.92	Brown	P33	10	33	11/16	20
LCDX2-14BH-E*	#2 AWG	#2 AWG	#2 AWG	1/4	.75	.70	.59	.11	2.04	Brown	P33	10	33	11/16	20
LCDX2-14DH-E*				1/4	1.00	.70	.59	.11	2.29	Brown	P33	10	33	11/16	20
LCDX2-56DH-E*				5/16	1.00	.70	.59	.11	2.42	Brown	P33	10	33	11/16	20
LCDX2-38DH-E*				3/8	1.00	.70	.59	.11	2.49	Brown	P33	10	33	11/16	20
LCDX2-12H-E*	#1 AWG	#1 AWG	#1 AWG	1/2	1.75	.75	.59	.09	3.66	Brown	P33	10	33	11/16	20
LCDX1-14AH-X				1/4	.63	.76	.66	.12	2.06	Green	P37	11	37	3/4	10
LCDX1-14BH-X				1/4	.75	.76	.66	.12	2.18	Green	P37	11	37	3/4	10
LCDX1-14DH-X				1/4	1.00	.76	.66	.12	2.43	Green	P37	11	37	3/4	10
LCDX1-56DH-X	#1 AWG	#1 AWG	#1 AWG	5/16	1.00	.76	.66	.12	2.49	Green	P37	11	37	3/4	10
LCDX1-38DH-X				3/8	1.00	.76	.66	.12	2.56	Green	P37	11	37	3/4	10
LCDX1-12H-X				1/2	1.75	.80	.66	.12	3.73	Green	P37	11	37	3/4	10

†See pages D3.70 – D3.73 for tool and die information.

\*Not UL Listed or CSA Certified with Class K flex conductor when crimped with Burndy tools.

\*\*Consult cable manufacturer for voltage stress relief instructions with applications greater than 2000 V.

◆NEMA hole sizes and spacing.



## Flex Conductor, Two-Hole, Standard Barrel with Window Lug, 45° Angle (continued)

Part Number	Flex Conductor Size		Code Conductor Size	Stud Hole Size (In.)	Stud Hole Spacing (In.)	Figure Dimensions (In.)				Panduit Color Code	Panduit Die Index No.‡	Burndy Die Index No.‡	T&B Die Index No.‡	Wire Strip Length (In.)	Std. Pkg. Qty.
	Class G, H, I, K, M	Diesel Locomotive				W	B	T	L						
LCDX1/0-14AH-X				1/4	.63	.85	.72	.13	2.21	Pink	P42	12	42	3/4	10
LCDX1/0-14BH-X				1/4	.75	.85	.72	.13	2.33	Pink	P42	12	42	3/4	10
LCDX1/0-56BH-X				5/16	.75	.85	.72	.13	2.33	Pink	P42	12	42	3/4	10
LCDX1/0-56DH-X	1/0 AWG	1/0 AWG	1/0 AWG	5/16	1.00	.85	.72	.13	2.58	Pink	P42	12	42	3/4	10
LCDX1/0-38DH-X				3/8	1.00	.85	.72	.13	2.64	Pink	P42	12	42	3/4	10
LCDX1/0-12DH-X				1/2	1.00	.85	.72	.13	2.89	Pink	P42	12	42	3/4	10
LCDX1/0-12H-X				1/2	1.75	.85	.72	.13	3.81	Pink	P42	12	42	3/4	10
LCDX2/0-14AH-X				1/4	.63	.96	.83	.13	2.30	Black	P45	13	45	7/8	10
LCDX2/0-14BH-X				1/4	.75	.96	.83	.13	2.43	Black	P45	13	45	7/8	10
LCDX2/0-56DH-X	2/0 AWG	2/0 AWG	2/0 AWG	5/16	1.00	.96	.83	.13	2.68	Black	P45	13	45	7/8	10
LCDX2/0-38DH-X				3/8	1.00	.96	.83	.13	2.74	Black	P45	13	45	7/8	10
LCDX2/0-12DH-X				1/2	1.00	.96	.83	.13	3.03	Black	P45	13	45	7/8	10
LCDX2/0-12H-X				1/2	1.75	.96	.83	.13	3.90	Black	P45	13	45	7/8	10
LCDX3/0-14AH-X				1/4	.63	1.06	.91	.14	2.39	Orange	P50	14	50	1	10
LCDX3/0-56DH-X	3/0 AWG	3/0 AWG	3/0 AWG	5/16	1.00	1.06	.91	.14	2.78	Orange	P50	14	50	1	10
LCDX3/0-38DH-X				3/8	1.00	1.06	.91	.14	2.85	Orange	P50	14	50	1	10
LCDX3/0-12H-X				1/2	1.75	1.06	.91	.14	3.99	Orange	P50	14	50	1	10
LCDX4/0-14AH-X				1/4	.63	1.19	1.03	.16	2.67	Purple	P54	15	54	1 1/16	10
LCDX4/0-14BH-X				1/4	.75	1.19	1.03	.16	2.79	Purple	P54	15	54	1 1/16	10
LCDX4/0-56DH-X	4/0 AWG	4/0 AWG	4/0 AWG	5/16	1.00	1.19	1.03	.16	3.04	Purple	P54	15	54	1 1/16	10
LCDX4/0-38DH-X				3/8	1.00	1.19	1.03	.16	3.07	Purple	P54	15	54	1 1/16	10
LCDX4/0-12DH-X				1/2	1.00	1.19	1.03	.16	3.36	Purple	P54	15	54	1 1/16	10
LCDX4/0-12EH-X				1/2	1.25	1.19	1.03	.16	3.62	Purple	P54	15	54	1 1/16	10
LCDX4/0-12H-X				1/2	1.75	1.19	1.03	.16	4.25	Purple	P54	15	54	1 1/16	10
LCDX250-38DH-X	250 kcmil	262.6 kcmil	—	3/8	1.00	1.28	1.03	.17	3.11	Yellow	P62	16	62	1 1/16	10
LCDX250-38H-X				3/8	1.75	1.28	1.03	.17	3.86	Yellow	P62	16	62	1 1/16	10
LCDX250-12EH-X				1/2	1.25	1.28	1.03	.17	3.66	Yellow	P62	16	62	1 1/16	10
LCDX250-12H-X				1/2	1.75	1.28	1.03	.17	4.29	Yellow	P62	16	62	1 1/16	10
LCDX300-38DH-6	300 kcmil	313.1 kcmil	—	3/8	1.00	1.39	1.19	.18	3.29	Red	P71	18	71H	1 1/4	6
LCDX300-12H-6				1/2	1.75	1.39	1.19	.18	4.47	Red	P71	18	71H	1 1/4	6
LCDX350-56DH-6	350 kcmil	373.7 kcmil	—	5/16	1.00	1.54	1.29	.22	3.40	Blue	P76	19	76H	1 3/8	6
LCDX350-38DH-6				3/8	1.00	1.54	1.29	.22	3.43	Blue	P76	19	76H	1 3/8	6
LCDX350-38H-6				3/8	1.75	1.54	1.29	.22	4.18	Blue	P76	19	76H	1 3/8	6
LCDX350-12EH-6				1/2	1.25	1.54	1.29	.22	3.98	Blue	P76	19	76H	1 3/8	6
LCDX350-12H-6				1/2	1.75	1.54	1.29	.22	4.61	Blue	P76	19	76H	1 3/8	6
LCDX450-38DH-6	450 kcmil	444.4 kcmil	—	3/8	1.00	1.70	1.40	.26	3.75	Brown	P87	20	87H	1 7/16	6
LCDX450-12H-6				1/2	1.75	1.70	1.40	.26	4.74	Brown	P87	20	87H	1 7/16	6
LCDX500-56DH-6	500 kcmil	535.3 kcmil	—	5/16	1.00	1.89	1.48	.26	3.70	Pink	P99	L99	99H	1 9/16	6
LCDX500-38DH-6				3/8	1.00	1.89	1.48	.26	3.73	Pink	P99	L99	99H	1 9/16	6
LCDX500-12EH-6				1/2	1.25	1.89	1.48	.26	4.41	Pink	P99	L99	99H	1 9/16	6
LCDX500-12H-6				1/2	1.75	1.89	1.48	.26	4.91	Pink	P99	L99	99H	1 9/16	6
LCDX600-12H-6	600 kcmil	—	—	1/2	1.75	1.89	1.48	.26	4.91	Pink	P99	400	99H	1 9/16	6
LCDX650-38DH-6	—	646.4 kcmil	—	3/8	1.00	1.95	1.45	.30	3.74	Black	P106	24	106H	1 1/2	6
LCDX650-12H-6				1/2	1.75	1.95	1.45	.30	4.92	Black	P106	24	106H	1 1/2	6
LCDX750-38DH-3	—	777.7 kcmil	—	3/8	1.00	2.17	1.66	.32	4.21	Yellow	P115	L115	115H	1 3/4	3
LCDX750-12EH-3				1/2	1.25	2.17	1.66	.32	4.65	Yellow	P115	L115	115H	1 3/4	3
LCDX750-12GH-3				1/2	1.50	2.17	1.66	.32	4.90	Yellow	P115	L115	115H	1 3/4	3
LCDX750-12H-3				1/2	1.75	2.17	1.66	.32	5.15	Yellow	P115	L115	115H	1 3/4	3
LCDX750-58GH-3				5/8	1.50	2.17	1.66	.32	4.90	Yellow	P115	L115	115H	1 3/4	3

‡See pages D3.70 – D3.73 for tool and die information.

\*Not UL Listed or CSA Certified with Class K flex conductor when crimped with Burndy tools.

\*\*Consult cable manufacturer for voltage stress relief instructions with applications greater than 2000 V.

◆NEMA hole sizes and spacing.

A. System Overview

B1. Cable Ties

B2. Cable Accessories

B3. Stainless Steel Ties

C1. Wiring Duct

C2. Surface Raceway

C3. Abrasion Protection

C4. Cable Management

D1. Terminals

D2. Power Connectors

D3. Grounding Connectors

E1. Labeling Systems

E2. Labels

E3. Pre-Printed & Write-On Markers

E4. Permanent Identification

E5. Lockout/Tagout & Safety Solutions

F. Index

A. System Overview



## Flex Conductor, Two-Hole, Standard Barrel with Window Lug, 90° Angle

B1. Cable Ties

**For Use with Flexible, Extra-Flexible, and Code Stranded Copper Conductors**

### Type LCDX-F

B2. Cable Accessories

- Can be used with code conductor and flex conductor class: G, H, I, K, M and Diesel Locomotive
- Tin-plated to inhibit corrosion
- Generously beveled wire entry prevents bent back strands when inserting conductor into barrel
- UL Listed and CSA Certified to 35 KV\*\* and temperature rated to 90°C when crimped with Panduit and specified competitor crimping tools and dies
- Color-coded barrels marked with Panduit and specified competitor die index numbers for proper crimp die selection
- American Bureau of Shipping approved
- Inspection window to visually assure full conductor insertion
- Available with NEMA hole sizes and spacing

B3. Stainless Steel Ties

C1. Wiring Duct



C2. Surface Raceway

C3. Abrasion Protection

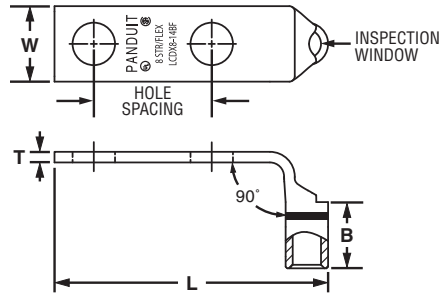

C4. Cable Management

D1. Terminals

D2. Power Connectors

D3. Grounding Connectors

E1. Labeling Systems

E2. Labels

E3. Pre-Printed & Write-On Markers

E4. Permanent Identification

E5. Lockout/Tagout & Safety Solutions

F. Index

Part Number	Flex Conductor Size		Code Conductor Size	Stud Hole Size (In.)	Stud Hole Spacing (In.)	Figure Dimensions (In.)				Panduit Color Code	Panduit Die Index No.‡	Burndy Die Index No.‡	T&B Die Index No.‡	Wire Strip Length (In.)	Std. Pkg. Qty.
	Class G, H, I, K, M	Diesel Locomotive				W	B	T	L						
LCDX8-10AF-L				#10	.63	.41	.42	.08	1.53	Red	P21	49	21	1/2	50
LCDX8-14AF-L				1/4	.63	.48	.42	.07	1.62	Red	P21	49	21	1/2	50
LCDX8-14BF-L	#8 AWG	#8 AWG	#8 AWG	1/4	.75	.48	.42	.07	1.74	Red	P21	49	21	1/2	50
LCDX8-14DF-L				1/4	1.00	.48	.42	.07	1.99	Red	P21	49	21	1/2	50
LCDX8-38DF-L				3/8	1.00	.63	.42	.05	2.21	Red	P21	49	21	1/2	50
LCDX6-10AF-L				#10	.63	.46	.48	.08	1.57	Blue	P24	7	24	9/16	50
LCDX6-10BF-L				#10	.75	.46	.48	.08	1.69	Blue	P24	7	24	9/16	50
LCDX6-10GF-L				#10	1.50	.46	.48	.08	2.44	Blue	P24	7	24	9/16	50
LCDX6-10PF-L				#10	.69	.46	.48	.08	1.63	Blue	P24	7	24	9/16	50
LCDX6-14AF-L	#6 AWG	#6 AWG	#6 AWG	1/4	.63	.48	.48	.08	1.66	Blue	P24	7	24	9/16	50
LCDX6-14BF-L				1/4	.75	.48	.48	.08	1.78	Blue	P24	7	24	9/16	50
LCDX6-14DF-L				1/4	1.00	.48	.48	.08	2.03	Blue	P24	7	24	9/16	50
LCDX6-56DF-L				5/16	1.00	.56	.48	.07	2.15	Blue	P24	7	24	9/16	50
LCDX6-38DF-L				3/8	1.00	.62	.48	.06	2.25	Blue	P24	7	24	9/16	50
LCDX4-14AF-L				1/4	.63	.55	.53	.09	1.74	Gray	P29	8	29	5/8	50
LCDX4-14BF-L				1/4	.75	.55	.53	.09	1.87	Gray	P29	8	29	5/8	50
LCDX4-14DF-L	#4 AWG	#5, #4, #3 AWG	#4 AWG	1/4	1.00	.55	.53	.09	2.12	Gray	P29	8	29	5/8	50
LCDX4-56DF-L				5/16	1.00	.55	.53	.09	2.24	Gray	P29	8	29	5/8	50
LCDX4-38DF-L				3/8	1.00	.62	.53	.08	2.34	Gray	P29	8	29	5/8	50
LCDX2-14AF-E*				1/4	.63	.70	.59	.11	1.94	Brown	P33	10	33	11/16	20
LCDX2-14BF-E*				1/4	.75	.70	.59	.11	2.06	Brown	P33	10	33	11/16	20
LCDX2-14DF-E*				1/4	1.00	.70	.59	.11	2.31	Brown	P33	10	33	11/16	20
LCDX2-56DF-E*	#2 AWG	#2 AWG	#2 AWG	5/16	1.00	.70	.59	.11	2.44	Brown	P33	10	33	11/16	20
LCDX2-38DF-E*				3/8	1.00	.70	.59	.11	2.51	Brown	P33	10	33	11/16	20
LCDX2-12F-E*				1/2	1.75	.75	.59	.09	3.68	Brown	P33	10	33	11/16	20
LCDX1-14AF-X				1/4	.63	.76	.66	.12	2.08	Green	P37	11	37	3/4	10
LCDX1-14BF-X				1/4	.75	.76	.66	.12	2.20	Green	P37	11	37	3/4	10
LCDX1-14DF-X				1/4	1.00	.76	.66	.12	2.45	Green	P37	11	37	3/4	10
LCDX1-56DF-X	#1 AWG	#1 AWG	#1 AWG	5/16	1.00	.76	.66	.12	2.51	Green	P37	11	37	3/4	10
LCDX1-38DF-X				3/8	1.00	.76	.66	.12	2.58	Green	P37	11	37	3/4	10
LCDX1-12F-X				1/2	1.75	.80	.66	.12	3.75	Green	P37	11	37	3/4	10

‡See pages D3.70 – D3.73 for tool and die information.

\*Not UL Listed or CSA Certified with Class K flex conductor when crimped with Burndy tools.

\*\*Consult cable manufacturer for voltage stress relief instructions with applications greater than 2000 V.

◆NEMA hole sizes and spacing.



## Flex Conductor, Two-Hole, Standard Barrel with Window Lug, 90° Angle (continued)

A.  
System  
Overview

B1.  
Cable Ties

B2.  
Cable  
Accessories

B3.  
Stainless  
Steel Ties

C1.  
Wiring  
Duct

C2.  
Surface  
Raceway

C3.  
Abrasion  
Protection

C4.  
Cable  
Management

D1.  
Terminals

D2.  
Power  
Connectors

D3.  
Grounding  
Connectors

E1.  
Labeling  
Systems

E2.  
Labels

E3.  
Pre-Printed  
& Write-On  
Markers

E4.  
Permanent  
Identification

E5.  
Lockout/  
Tagout  
& Safety  
Solutions

F.  
Index

Part Number	Flex Conductor Size		Code Conductor Size	Stud Hole Size (In.)	Stud Hole Spacing (In.)	Figure Dimensions (In.)				Panduit Color Code	Panduit Die Index No.‡	Burdny Die Index No.‡	T&B Die Index No.‡	Wire Strip Length (In.)	Std. Pkg. Qty.
	Class G, H, I, K, M	Diesel Locomotive				W	B	T	L						
LCDX1/0-14AF-X	1/0 AWG	1/0 AWG	1/0 AWG	1/4	.63	.85	.72	.13	2.22	Pink	P42	12	42	3/4	10
LCDX1/0-14BF-X				1/4	.75	.85	.72	.13	2.34	Pink	P42	12	42	3/4	10
LCDX1/0-56BF-X				5/16	.75	.85	.72	.13	2.34	Pink	P42	12	42	3/4	10
LCDX1/0-56DF-X				5/16	1.00	.85	.72	.13	2.59	Pink	P42	12	42	3/4	10
LCDX1/0-38DF-X				3/8	1.00	.85	.72	.13	2.66	Pink	P42	12	42	3/4	10
LCDX1/0-12DF-X				1/2	1.00	.85	.72	.13	2.91	Pink	P42	12	42	3/4	10
LCDX1/0-12F-X				1/2	1.75	.85	.72	.13	3.82	Pink	P42	12	42	3/4	10
LCDX2/0-14AF-X	2/0 AWG	2/0 AWG	2/0 AWG	1/4	.63	.96	.83	.13	2.29	Black	P45	13	45	7/8	10
LCDX2/0-14BF-X				1/4	.75	.96	.83	.13	2.42	Black	P45	13	45	7/8	10
LCDX2/0-56DF-X				5/16	1.00	.96	.83	.13	2.67	Black	P45	13	45	7/8	10
LCDX2/0-38DF-X				3/8	1.00	.96	.83	.13	2.73	Black	P45	13	45	7/8	10
LCDX2/0-12DF-X				1/2	1.00	.96	.83	.13	2.98	Black	P45	13	45	7/8	10
LCDX2/0-12F-X				1/2	1.75	.96	.83	.13	3.89	Black	P45	13	45	7/8	10
LCDX3/0-14AF-X	3/0 AWG	3/0 AWG	3/0 AWG	1/4	.63	1.06	.91	.14	2.38	Orange	P50	14	50	1	10
LCDX3/0-56DF-X				5/16	1.00	1.06	.91	.14	2.77	Orange	P50	14	50	1	10
LCDX3/0-38DF-X				3/8	1.00	1.06	.91	.14	2.84	Orange	P50	14	50	1	10
LCDX3/0-12F-X				1/2	1.75	1.06	.91	.14	3.98	Orange	P50	14	50	1	10
LCDX4/0-14AF-X	4/0 AWG	4/0 AWG	4/0 AWG	1/4	.63	1.19	1.03	.16	2.28	Purple	P54	15	54	1 1/16	10
LCDX4/0-14BF-X				1/4	.75	1.19	1.03	.16	2.40	Purple	P54	15	54	1 1/16	10
LCDX4/0-56DF-X				5/16	1.00	1.19	1.03	.16	2.85	Purple	P54	15	54	1 1/16	10
LCDX4/0-38DF-X				3/8	1.00	1.19	1.03	.16	2.88	Purple	P54	15	54	1 1/16	10
LCDX4/0-12DF-X				1/2	1.00	1.19	1.03	.16	3.15	Purple	P54	15	54	1 1/16	10
LCDX4/0-12EF-X				1/2	1.25	1.19	1.03	.16	3.43	Purple	P54	15	54	1 1/16	10
LCDX4/0-12F-X	1/2	1.75	1.19	1.03	.16	4.06	Purple	P54	15	54	1 1/16	10			
LCDX250-38DF-X	250 kcmil	262.6 kcmil	—	3/8	1.00	1.28	1.03	.17	2.94	Yellow	P62	16	62	1 1/16	10
LCDX250-38F-X				3/8	1.75	1.28	1.03	.17	3.69	Yellow	P62	16	62	1 1/16	10
LCDX250-12EF-X				1/2	1.25	1.28	1.03	.17	3.49	Yellow	P62	16	62	1 1/16	10
LCDX250-12F-X				1/2	1.75	1.28	1.03	.17	4.12	Yellow	P62	16	62	1 1/16	10
LCDX300-38DF-6	300 kcmil	313.1 kcmil	—	3/8	1.00	1.39	1.19	.18	3.02	Red	P71	18	71H	1 1/4	6
LCDX300-12F-6				1/2	1.75	1.39	1.19	.18	4.20	Red	P71	18	71H	1 1/4	6
LCDX350-56DF-6	350 kcmil	373.7 kcmil	—	5/16	1.00	1.54	1.29	.22	3.10	Blue	P76	19	76H	1 3/8	6
LCDX350-38DF-6				3/8	1.00	1.54	1.29	.22	3.13	Blue	P76	19	76H	1 3/8	6
LCDX350-38F-6				3/8	1.75	1.54	1.29	.22	3.88	Blue	P76	19	76H	1 3/8	6
LCDX350-12EF-6				1/2	1.25	1.54	1.29	.22	3.68	Blue	P76	19	76H	1 3/8	6
LCDX350-12F-6	1/2	1.75	1.54	1.29	.22	4.31	Blue	P76	19	76H	1 3/8	6			
LCDX450-38DF-6	450 kcmil	444.4 kcmil	—	3/8	1.00	1.70	1.40	.26	3.26	Brown	P87	20	87H	1 7/16	6
LCDX450-12F-6				1/2	1.75	1.70	1.40	.26	4.44	Brown	P87	20	87H	1 7/16	6
LCDX500-56DF-6	500 kcmil	535.3 kcmil	—	5/16	1.00	1.89	1.48	.26	3.29	Pink	P99	L99	99H	1 9/16	6
LCDX500-38DF-6				3/8	1.00	1.89	1.48	.26	3.32	Pink	P99	L99	99H	1 9/16	6
LCDX500-12EF-6				1/2	1.25	1.89	1.48	.26	4.00	Pink	P99	L99	99H	1 9/16	6
LCDX500-12F-6	1/2	1.75	1.89	1.48	.26	4.50	Pink	P99	L99	99H	1 9/16	6			
LCDX600-12F-6	600 kcmil	—	—	1/2	1.75	1.89	1.48	.26	4.50	Pink	P99	400	99H	1 9/16	6
LCDX650-38DF-6	—	646.4 kcmil	—	3/8	1.00	1.95	1.45	.30	3.37	Black	P106	24	106H	1 1/2	6
LCDX650-12F-6				1/2	1.75	1.95	1.45	.30	4.55	Black	P106	24	106H	1 1/2	6
LCDX750-38DF-3	—	777.7 kcmil	—	3/8	1.00	2.17	1.66	.32	3.76	Yellow	P115	L115	115H	1 3/4	3
LCDX750-12EF-3				1/2	1.25	2.17	1.66	.32	4.20	Yellow	P115	L115	115H	1 3/4	3
LCDX750-12GF-3				1/2	1.50	2.17	1.66	.32	4.45	Yellow	P115	L115	115H	1 3/4	3
LCDX750-12F-3				1/2	1.75	2.17	1.66	.32	4.70	Yellow	P115	L115	115H	1 3/4	3
LCDX750-58GF-3				5/8	1.50	2.17	1.66	.32	4.45	Yellow	P115	L115	115H	1 3/4	3

‡See pages D3.70 – D3.73 for tool and die information.

\*Not UL Listed or CSA Certified with Class K flex conductor when crimped with Burdny tools.

\*\*Consult cable manufacturer for voltage stress relief instructions with applications greater than 2000 V.

◆NEMA hole sizes and spacing.

A. System Overview



## Flex Conductor, Two-Hole, Standard Barrel with Window, Narrow Tongue Lug

B1. Cable Ties

**For Use with Flexible, Extra-Flexible, and Code Stranded Copper Conductors**

### Type LCDXN

- Narrow tongue width for limited space applications
- Can be used with code conductor and flex conductor class: G, H, I, K, M and Diesel Locomotive
- Generously beveled wire entry prevents bent back strands when inserting conductor into barrel
- Color-coded barrels marked with Panduit and specified competitor die index numbers for proper crimp die selection
- Inspection window to visually assure full conductor insertion
- Tin-plated to inhibit corrosion
- UL Listed and CSA Certified to 35 KV\*\* and temperature rated to 90°C when crimped with Panduit and specified competitor crimping tools and dies
- Available with NEMA hole sizes and spacing

C1. Wiring Duct



C2. Surface Raceway

C3. Abrasion Protection

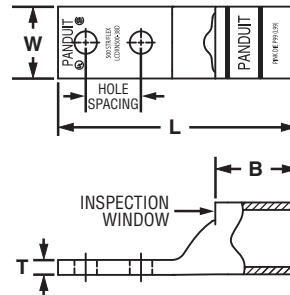

C4. Cable Management

Part Number	Flex Conductor Size		Code Conductor Size	Stud Hole Size (In.)	Stud Hole Spacing (In.)	Figure Dimensions (In.)				Panduit Color Code	Panduit Die Index No.‡	Burndy Die Index No.‡	T&B Die Index No.‡	Wire Strip Length (In.)	Std. Pkg. Qty.
	Class G, H, I, K, M	Diesel Locomotive				W	B	T	L						
<b>LCDXN2-14A-E*</b>	#2 AWG	#2 AWG	#2 AWG	1/4	.63	.47	.59	.11	2.13	Brown	P33	10	33	11/16	20
<b>LCDXN4/0-38D-X</b>	4/0 AWG	4/0 AWG	4/0 AWG	3/8	1.00	.81	1.03	.16	3.34	Purple	P54	15	54	1 1/16	10
<b>LCDXN350-38D-6</b>	350 kcmil	373.7 kcmil	—	3/8	1.00	1.06	1.29	.22	3.74	Blue	P76	19	76H	1 3/8	6
<b>LCDXN500-38D-6</b>	500 kcmil	535.3 kcmil	—	3/8	1.00	1.30	1.48	.28	4.32	Pink	P99	L99	99H	1 9/16	6
<b>LCDXN750-38D-3</b>	—	777.7 kcmil	—	3/8	1.00	1.50	1.66	.34	4.62	Yellow	P115	L115	115H	1 3/4	3
◆ <b>LCDXN750-12-3</b>	—	777.7 kcmil	—	1/2	1.75	1.50	1.66	.35	5.55	Yellow	P115	L115	115H	1 3/4	3

‡See pages D3.70 – D3.73 for tool and die information.

\*Not UL Listed or CSA Certified with Class K flex conductor when crimped with Burndy tools.

\*\*Consult cable manufacturer for voltage stress relief instructions with applications greater than 2000 V.

◆NEMA hole sizes and spacing.

E1. Labeling Systems

E2. Labels

E3. Pre-Printed & Write-On Markers

E4. Permanent Identification

E5. Lockout/Tagout & Safety Solutions

F. Index



## Flex Conductor, Two-Hole, Standard Barrel with Window, Narrow Tongue Lug, 45°

For Use with Flexible Copper Conductors

### Type LCDXN-H

- Narrow tongue width for limited space applications
- Can be used with code conductor and flex conductor class: G, H, I, K, M and Diesel Locomotive
- Generously beveled wire entry prevents bent back strands when inserting conductor into barrel
- Color-coded barrels marked with Panduit and specified competitor die index numbers for proper crimp die selection

- Inspection window to visually assure full conductor insertion
- Tin-plated to inhibit corrosion
- UL Listed and CSA Certified to 35 KV\*\* and temperature rated to 90°C when crimped with Panduit and specified competitor crimping tools and dies



Part Number	Flex Conductor Size		Code Conductor Size	Stud Hole Size (In.)	Stud Hole Spacing (In.)	Figure Dimensions (In.)				Panduit Color Code	Panduit Die Index No.‡	Burndy Die Index No.‡	T&B Die Index No.‡	Wire Strip Length (In.)	Std. Pkg. Qty.
	Class G, H, I, K, M	Diesel Locomotive				W	B	T	L						
LCDXN2-14AH-E*	#2 AWG	#2 AWG	#2 AWG	1/4	0.63	0.47	0.59	0.11	1.92	Brown	P33	10	33	11/16	20
LCDXN750-38DH-3	—	777.7 kcmil	—	3/8	1.00	1.50	1.66	0.35	4.22	Yellow	P115	L115	115H	1 3/4	3

‡See pages D3.70 – D3.73 for tool and die information.

\*Not UL Listed or CSA Certified with Class K flex conductor when crimped with Burndy tools.

\*\*Consult cable manufacturer for voltage stress relief instructions with applications greater than 2000 V.



## Flex Conductor, Two-Hole, Standard Barrel with Window, Narrow Tongue Lug, 90°

For Use with Flexible Copper Conductors

### Type LCDXN-F

- Narrow tongue width for limited space applications
- Can be used with code conductor and flex conductor class: G, H, I, K, M and Diesel Locomotive
- Generously beveled wire entry prevents bent back strands when inserting conductor into barrel
- Color-coded barrels marked with Panduit and specified competitor die index numbers for proper crimp die selection

- Inspection window to visually assure full conductor insertion
- Tin-plated to inhibit corrosion
- UL Listed and CSA Certified to 35 KV\*\* and temperature rated to 90°C when crimped with Panduit and specified competitor crimping tools and dies

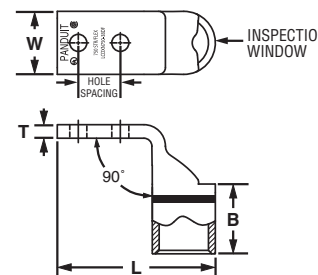

Part Number	Flex Conductor Size		Code Conductor Size	Stud Hole Size (In.)	Stud Hole Spacing (In.)	Figure Dimensions (In.)				Panduit Color Code	Panduit Die Index No.‡	Burndy Die Index No.‡	T&B Die Index No.‡	Wire Strip Length (In.)	Std. Pkg. Qty.
	Class G, H, I, K, M	Diesel Locomotive				W	B	T	L						
LCDXN2-14AF-E*	#2 AWG	#2 AWG	#2 AWG	1/4	0.63	0.47	0.59	0.11	1.94	Brown	P33	10	33	11/16	20
LCDXN750-38DF-3	—	777.7 kcmil	—	3/8	1.00	1.50	1.66	0.35	3.76	Yellow	P115	L115	115H	1 3/4	3

‡See pages D3.70 – D3.73 for tool and die information.

\*Not UL Listed or CSA Certified with class K flex conductor when crimped with Burndy tools.

\*\*Consult cable manufacturer for voltage stress relief instructions with applications greater than 2000 V.

A. System Overview

B1. Cable Ties

B2. Cable Accessories

B3. Stainless Steel Ties

C1. Wiring Duct

C2. Surface Raceway

C3. Abrasion Protection

C4. Cable Management

D1. Terminals

D2. Power Connectors

D3. Grounding Connectors

E1. Labeling Systems

E2. Labels

E3. Pre-Printed & Write-On Markers

E4. Permanent Identification

E5. Lockout/Tagout & Safety Solutions

F. Index

A. System Overview



## Flex Conductor, Two-Hole, Long Barrel with Window Lug

B1. Cable Ties

**For Use with Flexible, Extra-Flexible, and Code Stranded Copper Conductors**

### Type LCCX

B2. Cable Accessories

B3. Stainless Steel Ties

- Can be used with code conductor and flex conductor class: G, H, I, K, M and Diesel Locomotive
- Long barrel maximizes number of crimps and provides premium wire pull-out strength and electrical performance
- Generously beveled wire entry prevents bent back strands when inserting conductor into barrel
- Color-coded barrels marked with Panduit and specified competitor die index numbers for proper crimp die selection
- Inspection window to visually assure full conductor insertion
- Tin-plated to inhibit corrosion
- UL Listed and CSA Certified to 35 KV\*\* and temperature rated to 90°C when crimped with Panduit and specified competitor crimping tools and dies
- Meets J-STD-607-A and TIA-942 requirements for network systems grounding applications
- Available with NEMA hole sizes and spacing

C1. Wiring Duct

C2. Surface Raceway

C3. Abrasion Protection

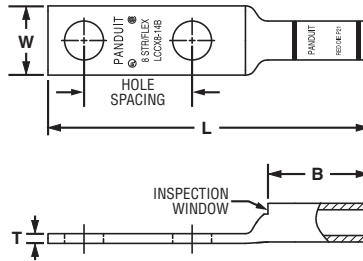

Figure 1

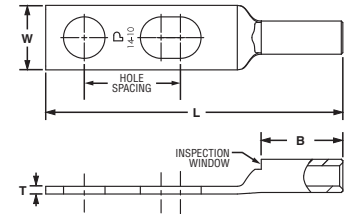

Figure 2: Slotted

C4. Cable Management

D1. Terminals

D2. Power Connectors

D3. Grounding Connectors

E1. Labeling Systems

E2. Labels

E3. Pre-Printed & Write-On Markers

E4. Permanent Identification

E5. Lockout/Tagout & Safety Solutions

F. Index

Part Number	Flex Conductor Size		Code Conductor Size	Stud Hole Size (In.)	Stud Hole Spacing (In.)	Figure Dimensions (In.)				Panduit Color Code	Panduit Die Index No.‡	Burndy Die Index No.‡	T&B Die Index No.‡	Wire Strip Length (In.)	Std. Pkg. Qty.			
	Class G, H, I, K, M	Diesel Locomotive				W	B	T	L									
LCCX8-10A-L	#8 AWG	#8 AWG	#8 AWG	#10	0.63	0.41	0.70	0.08	2.01	Red	P21	49	21	3/4	50			
LCCX8-10B-L				#10	0.75	0.41	0.70	0.08	2.14	Red	P21	49	21	3/4	50			
LCCX8-10AB-L^				#10	0.63 – 0.75	0.41	0.70	0.08	2.14	Red	P21	49	21	3/4	50			
LCCX8-14A-L				1/4	0.63	0.48	0.70	0.07	2.10	Red	P21	49	21	3/4	50			
LCCX8-14B-L				1/4	0.75	0.48	0.70	0.07	2.23	Red	P21	49	21	3/4	50			
LCCX8-14AB-L^				1/4	0.63 – 0.75	0.48	0.70	0.07	2.23	Red	P21	49	21	3/4	50			
LCCX8-14D-L				1/4	1.00	0.48	0.70	0.07	2.48	Red	P21	49	21	3/4	50			
LCCX8-38D-L				3/8	1.00	0.60	0.70	0.05	2.70	Red	P21	49	21	3/4	50			
LCCX6-10B-L				#6 AWG	#6 AWG	#6 AWG	#10	0.75	0.46	1.07	0.08	2.52	Blue	P24	7	24	1 1/8	50
LCCX6-14A-L							1/4	0.63	0.48	1.07	0.08	2.49	Blue	P24	7	24	1 1/8	50
LCCX6-14B-L							1/4	0.75	0.48	1.07	0.08	2.61	Blue	P24	7	24	1 1/8	50
LCCX6-14AB-L^							1/4	0.63 – 0.75	0.48	1.07	0.08	2.61	Blue	P24	7	24	1 1/8	50
LCCX6-14D-L	1/4	1.00	0.48				1.07	0.08	2.86	Blue	P24	7	24	1 1/8	50			
LCCX6-38A-L	3/8	0.63	0.62				1.07	0.06	2.71	Blue	P24	7	24	1 1/8	50			
LCCX6-38C-L	3/8	0.88	0.62				1.07	0.06	2.96	Blue	P24	7	24	1 1/8	50			
LCCX6-38AC-L^	3/8	0.63 – 0.88	0.62				1.07	0.06	2.96	Blue	P24	7	24	1 1/8	50			
LCCX6-38D-L	3/8	1.00	0.62				1.07	0.06	3.08	Blue	P24	7	24	1 1/8	50			
LCCX4-14A-L	#4 AWG	#5, #4, #3 AWG	#4 AWG				1/4	0.63	0.55	1.05	0.09	2.49	Gray	P29	8	29	1 1/8	50
LCCX4-14B-L							1/4	0.75	0.55	1.05	0.09	2.63	Gray	P29	8	29	1 1/8	50
LCCX4-14AB-L^							1/4	0.63 – 0.75	0.55	1.05	0.09	2.63	Gray	P29	8	29	1 1/8	50
LCCX4-14CE-L^				1/4	0.88 – 1.25	0.55	1.05	0.09	3.12	Gray	P29	8	29	1 1/8	50			
LCCX4-38B-L				3/8	0.75	0.62	1.05	0.08	2.84	Gray	P29	8	29	1 1/8	50			
LCCX4-38D-L				3/8	1.00	0.62	1.05	0.08	3.09	Gray	P29	8	29	1 1/8	50			
LCCX4-38BD-L^				3/8	0.75 – 1.00	0.62	1.05	0.08	3.09	Gray	P29	8	29	1 1/8	50			

‡See pages D3.70 – D3.73 for tool and die information.

\*Not UL Listed or CSA Certified with Class K flex conductor when crimped with Burndy tools.

\*\*Consult cable manufacturer for voltage stress relief instructions with applications greater than 2000 V.

^Slotted lug, refer to Figure 2.

◆NEMA hole sizes and spacing.





## Flex Conductor, Two-Hole, Long Barrel with Window Lug (continued)

Part Number	Flex Conductor Size		Code Conductor Size	Stud Hole Size (In.)	Stud Hole Spacing (In.)	Figure Dimensions (In.)				Panduit Color Code	Panduit Die Index No.†	Burndy Die Index No.‡	T&B Die Index No.‡	Wire Strip Length (In.)	Std. Pkg. Qty.
	Class G, H, I, K, M	Diesel Locomotive				W	B	T	L						
LCCX2-14A-E*	#2 AWG	#2 AWG	#2 AWG	1/4	0.63	0.70	1.36	0.11	2.89	Brown	P33	10	33	1 7/16	20
LCCX2-14B-E*				1/4	0.75	0.70	1.36	0.11	3.01	Brown	P33	10	33	1 7/16	20
LCCX2-38D-E*				3/8	1.00	0.70	1.36	0.11	3.46	Brown	P33	10	33	1 7/16	20
LCCX2-12-E*				1/2	1.75	0.75	1.36	0.09	4.63	Brown	P33	10	33	1 7/16	20
LCCX1-14A-X	#1 AWG	#1 AWG	#1 AWG	1/4	0.63	0.76	1.44	0.12	3.07	Green	P37	11	37	1 1/2	10
LCCX1-14B-X				1/4	0.75	0.76	1.44	0.12	3.19	Green	P37	11	37	1 1/2	10
LCCX1-14D-X				1/4	1.00	0.76	1.44	0.12	3.44	Green	P37	11	37	1 1/2	10
LCCX1-56C-X				5/16	0.88	0.76	1.44	0.12	3.37	Green	P37	11	37	1 1/2	10
LCCX1-56D-X				5/16	1.00	0.76	1.44	0.12	3.50	Green	P37	11	37	1 1/2	10
LCCX1-38D-X				3/8	1.00	0.76	1.44	0.12	3.57	Green	P37	11	37	1 1/2	10
LCCX1/0-14A-X	1/0 AWG	1/0 AWG	1/0 AWG	1/4	0.63	0.85	1.50	0.13	3.23	Pink	P42	12	42	1 9/16	10
LCCX1/0-14B-X				1/4	0.75	0.85	1.50	0.13	3.36	Pink	P42	12	42	1 9/16	10
LCCX1/0-38D-X				3/8	1.00	0.85	1.50	0.13	3.67	Pink	P42	12	42	1 9/16	10
LCCX1/0-12-X				1/2	1.75	0.85	1.50	0.13	4.83	Pink	P42	12	42	1 9/16	10
LCCX2/0-14A-X	2/0 AWG	2/0 AWG	2/0 AWG	1/4	0.63	0.96	1.50	0.13	3.27	Black	P45	13	45	1 9/16	10
LCCX2/0-14B-X				1/4	0.75	0.96	1.50	0.13	3.39	Black	P45	13	45	1 9/16	10
LCCX2/0-38D-X				3/8	1.00	0.96	1.50	0.13	3.70	Black	P45	13	45	1 9/16	10
LCCX2/0-12-X				1/2	1.75	0.96	1.50	0.13	4.87	Black	P45	13	45	1 9/16	10
LCCX3/0-14B-X	3/0 AWG	3/0 AWG	3/0 AWG	1/4	0.75	1.06	1.56	0.14	3.48	Orange	P50	14	50	1 5/8	10
LCCX3/0-38D-X				3/8	1.00	1.06	1.56	0.14	3.81	Orange	P50	14	50	1 5/8	10
LCCX4/0-14B-X	4/0 AWG	4/0 AWG	4/0 AWG	1/4	0.75	1.19	2.24	0.16	4.07	Purple	P54	15	54	2 5/16	10
LCCX4/0-38D-X				3/8	1.00	1.19	2.24	0.16	4.55	Purple	P54	15	54	2 5/16	10
LCCX4/0-12-X				1/2	1.75	1.19	2.24	0.16	5.73	Purple	P54	15	54	2 5/16	10
LCCX250-14B-X	250 kcmil	262.6 kcmil	—	1/4	0.75	1.28	2.24	0.17	4.11	Yellow	P62	16	62	2 5/16	10
LCCX250-38D-X				3/8	1.00	1.28	2.24	0.17	4.59	Yellow	P62	16	62	2 5/16	10
LCCX250-12-X				1/2	1.75	1.28	2.24	0.17	5.77	Yellow	P62	16	62	2 5/16	10
LCCX300-38D-6	300 kcmil	313.1 kcmil	—	3/8	1.00	1.39	2.30	0.18	4.67	Red	P71	18	71H	2 3/8	6
LCCX350-14B-6	350 kcmil	373.7 kcmil	—	1/4	0.75	1.54	2.50	0.22	4.47	Blue	P76	19	76H	2 9/16	6
LCCX350-38D-6				3/8	1.00	1.54	2.50	0.22	4.95	Blue	P76	19	76H	2 9/16	6
LCCX350-12-6				1/2	1.75	1.54	2.50	0.22	6.13	Blue	P76	19	76H	2 9/16	6
LCCX450-12-6	450 kcmil	444.4 kcmil	—	1/2	1.75	1.70	2.69	0.26	6.37	Brown	P87	20	87	2 3/4	6
LCCX500-38D-6	500 kcmil	535.3 kcmil	—	3/8	1.00	1.89	2.88	0.26	5.72	Pink	P99	L99	99H	2 15/16	6
LCCX500-12-6				1/2	1.75	1.89	2.88	0.26	6.66	Pink	P99	L99	99H	2 15/16	6
LCCX650-12-6				—	646.4 kcmil	—	1/2	1.75	1.95	2.94	0.30	6.75	Black	P106	24

†See pages D3.70 – D3.73 for tool and die information.

\*Not UL Listed or CSA Certified with Class K flex conductor when crimped with Burndy tools.

\*\*Consult cable manufacturer for voltage stress relief instructions with applications greater than 2000 V.

^Slotted lug, refer to Figure 2.

◆NEMA hole sizes and spacing.

A. System Overview

B1. Cable Ties

B2. Cable Accessories

B3. Stainless Steel Ties

C1. Wiring Duct

C2. Surface Raceway

C3. Abrasion Protection

C4. Cable Management

D1. Terminals

D2. Power Connectors

D3. Grounding Connectors

E1. Labeling Systems

E2. Labels

E3. Pre-Printed & Write-On Markers

E4. Permanent Identification

E5. Lockout/Tagout & Safety Solutions

F. Index

A. System Overview



## Flex Conductor, Two-Hole, Long Barrel with Window Lug, 45° Angle

B1. Cable Ties

**For Use with Flexible, Extra-Flexible, and Code Stranded Copper Conductors**

### Type LCCX-H

B2. Cable Accessories

- Can be used with code conductor and flex conductor class: G, H, I, K, M and Diesel Locomotive
- Long barrel maximizes number of crimps and provides premium wire pull-out strength and electrical performance
- Generously beveled wire entry prevents bent back strands when inserting conductor into barrel
- Color-coded barrels marked with Panduit and specified competitor die index numbers for proper crimp die selection
- Inspection window to visually assure full conductor insertion
- Tin-plated to inhibit corrosion
- UL Listed and CSA Certified to 35 KV\*\* and temperature rated to 90°C when crimped with Panduit and specified competitor crimping tools and dies
- Meets J-STD-607-A and TIA-942 requirements for network systems grounding applications
- Available with NEMA hole sizes and spacing

C1. Wiring Duct



C2. Surface Raceway

C3. Abrasion Protection

C4. Cable Management

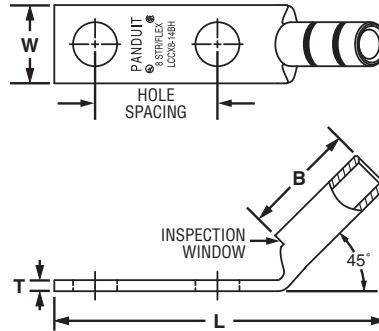

D1. Terminals

D2. Power Connectors

D3. Grounding Connectors

E1. Labeling Systems

E2. Labels

E3. Pre-Printed & Write-On Markers

E4. Permanent Identification

E5. Lockout/Tagout & Safety Solutions

F. Index

Part Number	Flex Conductor Size		Code Conductor Size	Stud Hole Size (In.)	Stud Hole Spacing (In.)	Figure Dimensions (In.)				Panduit Color Code	Panduit Die Index No.†	Burdny Die Index No.‡	T&B Die Index No.‡	Wire Strip Length (In.)	Std. Pkg. Qty.
	Class G, H, I, K, M	Diesel Locomotive				W	B	T	L						
LCCX8-10AH-L	#8 AWG	#8 AWG	#8 AWG	#10	.63	.41	.70	.08	1.82	Red	P21	49	21	3/4	50
LCCX8-10BH-L				#10	.75	.41	.70	.08	1.95	Red	P21	49	21	3/4	50
LCCX8-14AH-L				1/4	.63	.48	.70	.07	1.91	Red	P21	49	21	3/4	50
LCCX8-14BH-L				1/4	.75	.48	.70	.07	2.03	Red	P21	49	21	3/4	50
LCCX8-14DH-L				1/4	1.00	.48	.70	.07	2.28	Red	P21	49	21	3/4	50
LCCX8-38DH-L				3/8	1.00	.60	.70	.05	2.49	Red	P21	49	21	3/4	50
LCCX6-10BH-L	#6 AWG	#6 AWG	#6 AWG	#10	.75	.46	1.07	.08	2.22	Blue	P24	7	24	1 1/8	50
LCCX6-14AH-L				1/4	.63	.48	1.07	.08	2.18	Blue	P24	7	24	1 1/8	50
LCCX6-14BH-L				1/4	.75	.48	1.07	.08	2.31	Blue	P24	7	24	1 1/8	50
LCCX6-14DH-L				1/4	1.00	.48	1.07	.08	2.56	Blue	P24	7	24	1 1/8	50
LCCX6-38AH-L				3/8	.63	.62	1.07	.06	2.39	Blue	P24	7	24	1 1/8	50
LCCX6-38CH-L				3/8	.88	.62	1.07	.06	2.64	Blue	P24	7	24	1 1/8	50
LCCX6-38DH-L	3/8	1.00	.62	1.07	.06	2.77	Blue	P24	7	24	1 1/8	50			
LCCX4-14AH-L	#4 AWG	#5, #4, #3 AWG	#4 AWG	1/4	.63	.55	1.05	.09	2.20	Gray	P29	8	29	1 1/8	50
LCCX4-14BH-L				1/4	.75	.55	1.05	.09	2.32	Gray	P29	8	29	1 1/8	50
LCCX4-38BH-L				3/8	.75	.62	1.05	.08	2.54	Gray	P29	8	29	1 1/8	50
LCCX4-38DH-L				3/8	1.00	.62	1.05	.08	2.79	Gray	P29	8	29	1 1/8	20
LCCX2-14AH-E*	#2 AWG	#2 AWG	#2 AWG	1/4	.63	.70	1.36	.11	2.46	Brown	P33	10	33	1 7/16	20
LCCX2-14BH-E*				1/4	.75	.70	1.36	.11	2.58	Brown	P33	10	33	1 7/16	20
LCCX2-38DH-E*				3/8	1.00	.70	1.36	.11	3.04	Brown	P33	10	33	1 7/16	20
LCCX2-12H-E*				1/2	1.75	.75	1.36	.09	4.20	Brown	P33	10	33	1 7/16	10
LCCX1-14AH-X	#1 AWG	#1 AWG	#1 AWG	1/4	.63	.76	1.44	.12	2.61	Green	P37	11	37	1 1/2	10
LCCX1-14BH-X				1/4	.75	.76	1.44	.12	2.73	Green	P37	11	37	1 1/2	10
LCCX1-14DH-X				1/4	1.00	.76	1.44	.12	2.98	Green	P37	11	37	1 1/2	10
LCCX1-56CH-X				5/16	.88	.76	1.44	.12	2.91	Green	P37	11	37	1 1/2	10
LCCX1-56DH-X				5/16	1.00	.76	1.44	.12	3.04	Green	P37	11	37	1 1/2	10
LCCX1-38DH-X				3/8	1.00	.76	1.44	.12	3.11	Green	P37	11	37	1 1/2	10

†See pages D3.70 – D3.73 for tool and die information.

\*Not UL Listed or CSA Certified with Class K flex conductor when crimped with Burdny tools.

\*\*Consult cable manufacturer for voltage stress relief instructions with applications greater than 2000 V.

◆NEMA hole sizes and spacing.



## Flex Conductor, Two-Hole, Long Barrel with Window Lug, 45° Angle (continued)

Part Number	Flex Conductor Size		Code Conductor Size	Stud Hole Size (In.)	Stud Hole Spacing (In.)	Figure Dimensions (In.)				Panduit Color Code	Panduit Die Index No.‡	Burndy Die Index No.‡	T&B Die Index No.‡	Wire Strip Length (In.)	Std. Pkg. Qty.
	Class G, H, I, K, M	Diesel Locomotive				W	B	T	L						
LCCX1/0-14AH-X	1/0 AWG	1/0 AWG	1/0 AWG	1/4	.63	.85	1.50	.13	2.76	Pink	P42	12	42	1 9/16	10
LCCX1/0-14BH-X				1/4	.75	.85	1.50	.13	2.88	Pink	P42	12	42	1 9/16	10
LCCX1/0-38DH-X				3/8	1.00	.85	1.50	.13	3.20	Pink	P42	12	42	1 9/16	10
LCCX1/0-12H-X				1/2	1.75	.85	1.50	.13	4.36	Pink	P42	12	42	1 9/16	10
LCCX2/0-14AH-X	2/0 AWG	2/0 AWG	2/0 AWG	1/4	.63	.96	1.50	.13	2.78	Black	P45	13	45	1 9/16	10
LCCX2/0-14BH-X				1/4	.75	.96	1.50	.13	2.91	Black	P45	13	45	1 9/16	10
LCCX2/0-38DH-X				3/8	1.00	.96	1.50	.13	3.22	Black	P45	13	45	1 9/16	10
LCCX2/0-12H-X				1/2	1.75	.96	1.50	.13	4.38	Black	P45	13	45	1 9/16	10
LCCX3/0-14BH-X	3/0 AWG	3/0 AWG	3/0 AWG	1/4	.75	1.06	1.56	.14	2.98	Orange	P50	14	50	1 5/8	10
LCCX3/0-38DH-X				3/8	1.00	1.06	1.56	.14	3.31	Orange	P50	14	50	1 5/8	10
LCCX4/0-14BH-X	4/0 AWG	4/0 AWG	4/0 AWG	1/4	.75	1.19	2.24	.16	3.45	Purple	P54	15	54	2 5/16	10
LCCX4/0-38DH-X				3/8	1.00	1.19	2.24	.16	3.93	Purple	P54	15	54	2 5/16	10
LCCX4/0-12H-X				1/2	1.75	1.19	2.24	.16	5.11	Purple	P54	15	54	2 5/16	10
LCCX250-14BH-X	250 kcmil	262.6 kcmil	—	1/4	.75	1.28	2.24	.17	3.48	Yellow	P62	16	62	2 5/16	10
LCCX250-38DH-X				3/8	1.00	1.28	2.24	.17	3.96	Yellow	P62	16	62	2 5/16	6
LCCX300-38DH-6	300 kcmil	313.1 kcmil	—	3/8	1.00	1.39	2.30	.18	4.07	Red	P71	18	71H	2 3/8	6
LCCX350-14BH-6	350 kcmil	373.7 kcmil	—	1/4	.75	1.54	2.50	.22	3.81	Blue	P76	19	76H	2 9/16	6
LCCX350-38DH-6				3/8	1.00	1.54	2.50	.22	4.29	Blue	P76	19	76H	2 9/16	6
LCCX350-12H-6				1/2	1.75	1.54	2.50	.22	5.47	Blue	P76	19	76H	2 9/16	6

‡See pages D3.70 – D3.73 for tool and die information.

\*Not UL Listed or CSA Certified with Class K flex conductor when crimped with Burndy tools.

\*\*Consult cable manufacturer for voltage stress relief instructions with applications greater than 2000 V.

◆NEMA hole sizes and spacing.

A. System Overview

B1. Cable Ties

B2. Cable Accessories

B3. Stainless Steel Ties

C1. Wiring Duct

C2. Surface Raceway

C3. Abrasion Protection

C4. Cable Management

D1. Terminals

D2. Power Connectors

D3. Grounding Connectors

E1. Labeling Systems

E2. Labels

E3. Pre-Printed & Write-On Markers

E4. Permanent Identification

E5. Lockout/Tagout & Safety Solutions

F. Index

A. System Overview



## Flex Conductor, Two-Hole, Long Barrel with Window Lug, 90° Angle

B1. Cable Ties

**For Use with Flexible, Extra-Flexible, and Code Stranded Copper Conductors**

### Type LCCX-F

- Can be used with code conductor and flex conductor class: G, H, I, K, M and Diesel Locomotive
- Long barrel maximizes number of crimps and provides premium wire pull-out strength and electrical performance
- Generously beveled wire entry prevents bent back strands when inserting conductor into barrel
- Color-coded barrels marked with Panduit and specified competitor die index numbers for proper crimp die selection
- Inspection window to visually assure full conductor insertion
- Tin-plated to inhibit corrosion
- UL Listed and CSA Certified to 35 KV\*\* and temperature rated to 90°C when crimped with Panduit and specified competitor crimping tools and dies
- Meets J-STD-607-A and TIA-942 requirements for network systems grounding applications
- Available with NEMA hole sizes and spacing

B2. Cable Accessories

B3. Stainless Steel Ties

C1. Wiring Duct

C2. Surface Raceway

C3. Abrasion Protection

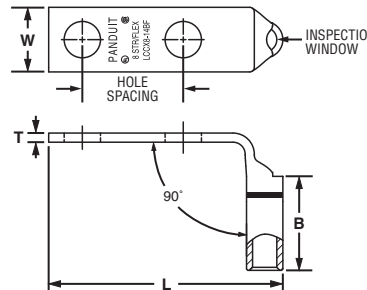

C4. Cable Management

D1. Terminals

D2. Power Connectors

D3. Grounding Connectors

E1. Labeling Systems

E2. Labels

E3. Pre-Printed & Write-On Markers

E4. Permanent Identification

E5. Lockout/Tagout & Safety Solutions

F. Index

Part Number	Flex Conductor Size		Code Conductor Size	Stud Hole Size (In.)	Stud Hole Spacing (In.)	Figure Dimensions (In.)				Panduit Color Code	Panduit Die Index No.‡	Burndy Die Index No.	T&B Die Index No.	Wire Strip Length (In.)	Std. Pkg. Qty.
	Class G, H, I, K, M	Diesel Locomotive				W	B	T	L						
LCCX8-10AF-L				#10	.63	.41	.70	.08	1.53	Red	P21	49	21	3/4	50
LCCX8-10BF-L				#10	.75	.41	.70	.08	1.65	Red	P21	49	21	3/4	50
LCCX8-14AF-L	#8 AWG	#8 AWG	#8 AWG	1/4	.63	.48	.70	.07	1.62	Red	P21	49	21	3/4	50
LCCX8-14BF-L				1/4	.75	.48	.70	.07	1.74	Red	P21	49	21	3/4	50
LCCX8-14DF-L				1/4	1.00	.48	.70	.07	1.99	Red	P21	49	21	3/4	50
LCCX8-38DF-L				3/8	1.00	.60	.70	.05	2.21	Red	P21	49	21	3/4	50
LCCX6-10BF-L	#6 AWG	#6 AWG	#6 AWG	#10	.75	.46	1.07	.08	1.69	Blue	P24	7	24	1 1/8	50
LCCX6-14AF-L				1/4	.63	.48	1.07	.08	1.66	Blue	P24	7	24	1 1/8	50
LCCX6-14BF-L				1/4	.75	.48	1.07	.08	1.78	Blue	P24	7	24	1 1/8	50
LCCX6-14DF-L				1/4	1.00	.48	1.07	.08	2.03	Blue	P24	7	24	1 1/8	50
LCCX6-38AF-L				3/8	.63	.62	1.07	.06	1.88	Blue	P24	7	24	1 1/8	50
LCCX6-38CF-L				3/8	.88	.62	1.07	.06	2.13	Blue	P24	7	24	1 1/8	50
LCCX6-38DF-L	3/8	1.00	.62	1.07	.06	2.25	Blue	P24	7	24	1 1/8	50			
LCCX4-14AF-L	#4 AWG	#5, #4, #3 AWG	#4 AWG	1/4	.63	.55	1.05	.09	1.74	Gray	P29	8	29	1 1/8	50
LCCX4-14BF-L				1/4	.75	.55	1.05	.09	1.87	Gray	P29	8	29	1 1/8	50
LCCX4-38BF-L				3/8	.75	.62	1.05	.08	2.09	Gray	P29	8	29	1 1/8	50
LCCX4-38DF-L				3/8	1.00	.62	1.05	.08	2.34	Gray	P29	8	29	1 1/8	50
LCCX2-14AF-E*	#2 AWG	#2 AWG	#2 AWG	1/4	.63	.70	1.36	.11	1.94	Brown	P33	10	33	1 7/16	20
LCCX2-14BF-E*				1/4	.75	.70	1.36	.11	2.06	Brown	P33	10	33	1 7/16	20
LCCX2-38DF-E*				3/8	1.00	.70	1.36	.11	2.51	Brown	P33	10	33	1 7/16	20
LCCX2-12F-E*				1/2	1.75	.75	1.36	.09	3.68	Brown	P33	10	33	1 7/16	20
LCCX1-14AF-X	#1 AWG	#1 AWG	#1 AWG	1/4	.63	.76	1.44	.12	2.08	Green	P37	11	37	1 1/2	10
LCCX1-14BF-X				1/4	.75	.76	1.44	.12	2.20	Green	P37	11	37	1 1/2	10
LCCX1-14DF-X				1/4	1.00	.76	1.44	.12	2.45	Green	P37	11	37	1 1/2	10
LCCX1-56CF-X				5/16	.88	.76	1.44	.12	2.38	Green	P37	11	37	1 1/2	10
LCCX1-56DF-X				5/16	1.00	.76	1.44	.12	2.51	Green	P37	11	37	1 1/2	10
LCCX1-38DF-X	3/8	1.00	.76	1.44	.12	2.58	Green	P37	11	37	1 1/2	10			
LCCX1/0-14AF-X	1/0 AWG	1/0 AWG	1/0 AWG	1/4	.63	.85	1.50	.13	2.22	Pink	P42	12	42	1 9/16	10
LCCX1/0-14BF-X				1/4	.75	.85	1.50	.13	2.34	Pink	P42	12	42	1 9/16	10
LCCX1/0-38DF-X				3/8	1.00	.85	1.50	.13	2.66	Pink	P42	12	42	1 9/16	10
LCCX1/0-12F-X				1/2	1.75	.85	1.50	.13	3.82	Pink	P42	12	42	1 9/16	10

‡See pages D3.70 – D3.73 for tool and die information.

\*Not UL Listed or CSA Certified with Class K flex conductor when crimped with Burndy tools.

\*\*Consult cable manufacturer for voltage stress relief instructions with applications greater than 2000 V.



## Flex Conductor, Two-Hole, Long Barrel with Window Lug, 90° Angle (continued)

Part Number	Flex Conductor Size		Code Conductor Size	Stud Hole Size (In.)	Stud Hole Spacing (In.)	Figure Dimensions (In.)				Panduit Color Code	Panduit Die Index No.‡	Burndy Die Index No.	T&B Die Index No.	Wire Strip Length (In.)	Std. Pkg. Qty.
	Class G, H, I, K, M	Diesel Locomotive				W	B	T	L						
LCCX2/0-14AF-X	2/0 AWG	2/0 AWG	2/0 AWG	1/4	.63	.96	1.50	.13	2.29	Black	P45	13	45	1 9/16	10
LCCX2/0-14BF-X				1/4	.75	.96	1.50	.13	2.42	Black	P45	13	45	1 9/16	10
LCCX2/0-38DF-X				3/8	1.00	.96	1.50	.13	2.73	Black	P45	13	45	1 9/16	10
LCCX2/0-12F-X				1/2	1.75	.96	1.50	.13	3.89	Black	P45	13	45	1 9/16	10
LCCX3/0-14BF-X	3/0 AWG	3/0 AWG	3/0 AWG	1/4	.75	1.06	1.56	.14	2.50	Orange	P50	14	50	1 5/8	10
LCCX3/0-38DF-X				3/8	1.00	1.06	1.56	.14	2.84	Orange	P50	14	50	1 5/8	10
LCCX4/0-14BF-X	4/0 AWG	4/0 AWG	4/0 AWG	1/4	.75	1.19	2.24	.16	2.69	Purple	P54	15	54	2 5/16	10
LCCX4/0-38DF-X				3/8	1.00	1.19	2.24	.16	2.88	Purple	P54	15	54	2 5/16	10
LCCX4/0-12F-X				1/2	1.75	1.19	2.24	.16	4.06	Purple	P54	15	54	2 5/16	10
LCCX250-14BF-X	250 kcmil	262.6 kcmil	—	1/4	.75	1.28	2.24	.17	2.46	Yellow	P62	16	62	2 5/16	10
LCCX250-38DF-X				3/8	1.00	1.28	2.24	.17	2.94	Yellow	P62	16	62	2 5/16	10
LCCX300-38DF-6	300 kcmil	313.1 kcmil	—	3/8	1.00	1.39	2.30	.18	3.02	Red	P71	18	71H	2 3/8	6
LCCX350-14BF-6	350 kcmil	373.7 kcmil	—	1/4	.75	1.54	2.50	.22	2.65	Blue	P76	19	76H	2 9/16	6
LCCX350-38DF-6				3/8	1.00	1.54	2.50	.22	3.13	Blue	P76	19	76H	2 9/16	6
LCCX350-12F-6				1/2	1.75	1.54	2.50	.22	4.31	Blue	P76	19	76H	2 9/16	6

‡See pages D3.70 – D3.73 for tool and die information.

\*Not UL Listed or CSA Certified with Class K flex conductor when crimped with Burndy tools.

\*\*Consult cable manufacturer for voltage stress relief instructions with applications greater than 2000 V.

◆NEMA hole sizes and spacing.



## Flex Conductor, Two-Hole, Long Barrel with Window, Narrow Tongue Lug

### For use with Flexible and Extra-Flexible Stranded Copper Conductors

- Narrow tongue width for limited space applications
- Can be used with flex conductor class: G, H, I, K, M and Diesel Locomotive
- Long barrel maximizes number of crimps and provides premium wire pull-out strength and electrical performance
- Generously beveled wire entry prevents bent back strands when inserting conductor into barrel
- Color-coded barrels marked with Panduit and specified competitor die index numbers for proper crimp die selection
- Inspection window to visually assure full conductor insertion
- Tin-plated to inhibit corrosion
- UL Listed and CSA Certified to 35 KV\*\* and temperature rated to 90°C when crimped with Panduit and specified competitor crimping tools and dies
- Meets J-STD-607-A and TIA-942 requirements for network systems grounding applications
- Available with NEMA hole sizes and spacing

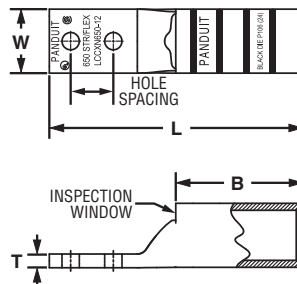

Part Number	Flex Conductor Size		Stud Hole Size (In.)	Stud Hole Spacing (In.)	Figure Dimensions (In.)				Panduit Color Code	Panduit Die Index No.‡	Burndy Die Index No.‡	T&B Die Index No.‡	Wire Strip Length (In.)	Std. Pkg. Qty.
	Class G,H, I, K, M	Diesel Locomotive			W	B	T	L						
◆ LCCXN450-12-6	450 kcmil	444.4 kcmil	1/2	1.75	1.19	2.69	0.33	6.41	Brown	P87	20	87H	2 3/4	6
◆ LCCXN500-12-6	500 kcmil	535.3 kcmil	1/2	1.75	1.30	2.88	0.32	6.71	Pink	P99	L99	99H	2 15/16	6
◆ LCCXN650-12-6	—	646.4 kcmil	1/2	1.75	1.35	2.94	0.36	6.78	Black	P106	24	106	3	6

‡See pages D3.70 – D3.73 for tool and die information.

\*\*Consult cable manufacturer for voltage stress relief instructions with applications greater than 2000 V.

◆NEMA hole sizes and spacing.

A. System Overview

B1. Cable Ties

B2. Cable Accessories

B3. Stainless Steel Ties

C1. Wiring Duct

C2. Surface Raceway

C3. Abrasion Protection

C4. Cable Management

D1. Terminals

D2. Power Connectors

D3. Grounding Connectors

E1. Labeling Systems

E2. Labels

E3. Pre-Printed & Write-On Markers

E4. Permanent Identification

E5. Lockout/Tagout & Safety Solutions

F. Index

A. System Overview



## Flex Conductor, Two-Hole, Long Barrel, Flared NEBS Lug

B1. Cable Ties

**For Use with Flexible and Extra-Flexible Copper Conductors**

### Type LCCF

- Can be used with flex conductor class: K, M, and Diesel Locomotive
- Enclosed barrel prevents corrosive material from entering barrel when used in harsh environments
- Long barrel maximizes the number of crimps and provides premium wire pull-out strength and electrical performance
- Tin-plated to inhibit corrosion
- Flared entry prevents bent back strands when inserting fine strand conductor into barrel
- UL Listed and CSA Certified to 35 KV\*\* and temperature rated to 90°C when crimped with Panduit crimping tools and dies
- Color-coded barrels marked with Panduit die index numbers for proper crimp die selection
- **Tested by Telcordia – meets NEBS Level 3**
- Available with NEMA hole sizes and spacing

C1. Wiring Duct



C2. Surface Raceway

C3. Abrasion Protection

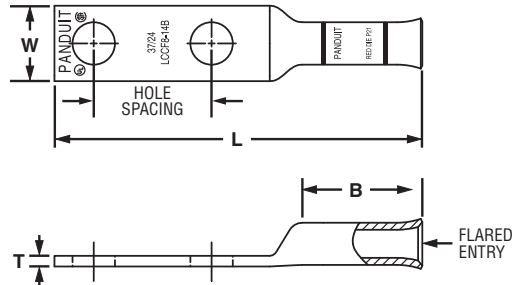

C4. Cable Management

Part Number	Flex Conductor Size		Stud Hole Size (In.)	Stud Hole Spacing (In.)	Figure Dimensions (In.)				Panduit Color Code	Panduit Die Index No.‡	Wire Strip Length (In.)	Std. Pkg. Qty.
	Class K and M	Diesel Locomotive			W	B	T	L				
LCCF8-14A-L	—	#8 AWG	1/4	.63	.48	.76	.07	2.22	Red	P21	13/16	50
LCCF8-14B-L			1/4	.75	.48	.76	.07	2.34	Red	P21	13/16	50
LCCF8-38D-L			3/8	1.00	.60	.76	.05	2.81	Red	P21	13/16	50
<b>LCCF6-14A-L</b>	#6 AWG	#6 AWG	1/4	.63	.48	1.22	.08	2.71	Blue	P24	1 5/16	50
<b>LCCF6-14B-L</b>			1/4	.75	.48	1.22	.08	2.83	Blue	P24	1 5/16	50
<b>LCCF6-38D-L</b>			3/8	1.00	.62	1.22	.06	3.30	Blue	P24	1 5/16	50
<b>LCCF4-14A-L</b>	#4 AWG	#4 AWG	1/4	.63	.55	1.23	.09	2.75	Gray	P29	1 5/16	50
<b>LCCF4-14B-L</b>			1/4	.75	.55	1.23	.09	2.88	Gray	P29	1 5/16	50
<b>LCCF4-38D-L</b>			3/8	1.00	.62	1.23	.08	3.35	Gray	P29	1 5/16	50
<b>LCCF2-14A-E</b>	#2 AWG	#2 AWG	1/4	.63	.70	1.36	.11	3.00	Brown	P33	1 7/16	20
<b>LCCF2-14B-E</b>			1/4	.75	.70	1.36	.11	3.12	Brown	P33	1 7/16	20
<b>LCCF2-56B-E</b>			5/16	.75	.70	1.36	.11	3.25	Brown	P33	1 7/16	20
<b>LCCF2-38D-E</b>			3/8	1.00	.70	1.36	.11	3.57	Brown	P33	1 7/16	20
<b>LCCF2-12-E</b>			1/2	1.75	.75	1.36	.09	4.74	Brown	P33	1 7/16	20
<b>LCCF1-14A-X</b>	#1 AWG	#1 AWG	1/4	.63	.76	1.44	.12	3.18	Pink	P42	1 1/2	10
<b>LCCF1-14B-X</b>			1/4	.75	.76	1.44	.12	3.31	Pink	P42	1 1/2	10
<b>LCCF1-56C-X</b>			5/16	.88	.76	1.44	.12	3.49	Pink	P42	1 1/2	10
<b>LCCF1-38D-X</b>			3/8	1.00	.76	1.44	.12	3.69	Pink	P42	1 1/2	10
<b>LCCF1-12-X</b>			1/2	1.75	.80	1.44	.12	4.86	Pink	P42	1 1/2	10

‡See pages D3.74, D3.75 for tool and die information.

\*\*Consult cable manufacturer for voltage stress relief instructions with applications greater than 2000 V.

◆NEMA hole sizes and spacing.

E3. Pre-Printed & Write-On Markers

E4. Permanent Identification

E5. Lockout/Tagout & Safety Solutions

F. Index



## Flex Conductor, Two-Hole, Long Barrel, Flared NEBS Lug (continued)

Part Number	Flex Conductor Size		Stud Hole Size (In.)	Stud Hole Spacing (In.)	Figure Dimensions (In.)				Panduit Color Code	Panduit Die Index No.‡	Wire Strip Length (In.)	Std. Pkg. Qty.
	Class K and M	Diesel Locomotive			W	B	T	L				
LCCF1/0-14A-X	1/0 AWG	1/0 AWG	1/4	.63	.85	1.50	.13	3.38	Black	P45	1 9/16	10
LCCF1/0-14B-X			1/4	.75	.85	1.50	.13	3.51	Black	P45	1 9/16	10
LCCF1/0-56C-X			5/16	.88	.85	1.50	.13	3.63	Black	P45	1 9/16	10
LCCF1/0-38D-X			3/8	1.00	.85	1.50	.13	3.82	Black	P45	1 9/16	10
LCCF1/0-12-X			1/2	1.75	.85	1.50	.13	4.98	Black	P45	1 9/16	10
LCCF2/0-14A-X	2/0 AWG	2/0 AWG	1/4	.63	.96	1.50	.13	3.43	Orange	P50	1 9/16	10
LCCF2/0-14B-X			1/4	.75	.96	1.50	.13	3.56	Orange	P50	1 9/16	10
LCCF2/0-38D-X			3/8	1.00	.96	1.50	.13	3.87	Orange	P50	1 9/16	10
LCCF2/0-12-X			1/2	1.75	.96	1.50	.13	5.03	Orange	P50	1 9/16	10
LCCF3/0-14B-X	3/0 AWG	3/0 AWG	1/4	.75	1.06	1.56	.14	3.66	Purple	P54	1 5/8	10
<b>LCCF3/0-38D-X</b>			3/8	1.00	1.06	1.56	.14	3.99	Purple	P54	1 5/8	10
LCCF3/0-12-X			1/2	1.75	1.06	1.56	.14	5.13	Purple	P54	1 5/8	10
LCCF4/0-14B-X	4/0 AWG	4/0 AWG	1/4	.75	1.17	1.61	.14	3.60	Yellow	P62	1 11/16	10
LCCF4/0-38D-X			3/8	1.00	1.17	1.61	.14	4.09	Yellow	P62	1 11/16	10
LCCF4/0-38-X			3/8	1.75	1.17	1.61	.14	4.84	Yellow	P62	1 11/16	10
<b>LCCF4/0-12-X</b>			1/2	1.75	1.17	1.61	.14	5.23	Yellow	P62	1 11/16	10
LCCF250-14B-X	250 kcmil	262.6 kcmil	1/4	.75	1.28	2.24	.17	4.33	White	P66	2 5/16	10
LCCF250-38D-X			3/8	1.00	1.28	2.24	.17	4.81	White	P66	2 5/16	10
LCCF250-12E-X			1/2	1.25	1.28	2.24	.17	5.49	White	P66	2 5/16	10
LCCF250-12-X			1/2	1.75	1.28	2.24	.17	5.99	White	P66	2 5/16	10
LCCF300-14B-6	300 kcmil	313.1 kcmil	1/4	.75	1.38	2.30	.18	4.44	Red	P71	2 3/8	6
LCCF300-38D-6			3/8	1.00	1.38	2.30	.18	4.92	Red	P71	2 3/8	6
LCCF300-12-6			1/2	1.75	1.38	2.30	.18	6.10	Red	P71	2 3/8	6
LCCF350-14B-6	350 kcmil	373.7 kcmil	1/4	.75	1.53	2.50	.22	4.70	Blue	P76	2 9/16	6
LCCF350-38D-6			3/8	1.00	1.53	2.50	.22	5.18	Blue	P76	2 9/16	6
LCCF350-12E-6			1/2	1.25	1.53	2.50	.22	5.86	Blue	P76	2 9/16	6
LCCF350-12-6			1/2	1.75	1.53	2.50	.22	6.36	Blue	P76	2 9/16	6
LCCF400-38D-6	400 kcmil	444.4 kcmil	3/8	1.00	1.70	2.69	.26	5.45	Brown	P87	2 3/4	6
LCCF400-12-6			1/2	1.75	1.70	2.69	.26	6.63	Brown	P87	2 3/4	6
<b>LCCF500-12-6</b>	500 kcmil	535.3 kcmil	1/2	1.75	1.89	2.88	.26	7.04	Pink	P99	2 15/16	6
LCCF600-12-6	—	646.4 kcmil	1/2	1.75	1.95	2.94	.29	7.13	Black	P106	3	6
LCCF750-38D-3	—	777.7 kcmil	3/8	1.00	2.17	3.00	.32	6.35	Orange	P107	3 1/16	3
<b>LCCF750-12-3</b>			1/2	1.75	2.17	3.00	.32	7.29	Orange	P107	3 1/16	3

‡See pages D3.74, D3.75 for tool and die information.

\*\*Consult cable manufacturer for voltage stress relief instructions with applications greater than 2000 V.

◆NEMA hole sizes and spacing.

A.  
System Overview

B1.  
Cable Ties

B2.  
Cable Accessories

B3.  
Stainless Steel Ties

C1.  
Wiring Duct

C2.  
Surface Raceway

C3.  
Abrasion Protection

C4.  
Cable Management

D1.  
Terminals

D2.  
Power Connectors

D3.  
Grounding Connectors

E1.  
Labeling Systems

E2.  
Labels

E3.  
Pre-Printed & Write-On Markers

E4.  
Permanent Identification

E5.  
Lockout/Tagout & Safety Solutions

F.  
Index

A. System Overview



## Flex Conductor, Two-Hole, Long Barrel, Flared NEBS Lug, 45° Angle

B1. Cable Ties

### For Use with Flexible and Extra-Flexible Copper Conductors

#### Type LCCF-H

- Can be used with flex conductor class: K, M, and Diesel Locomotive
- Long barrel maximizes the number of crimps and provides premium wire pull-out strength and electrical performance
- Flared entry prevents bent back strands when inserting fine strand conductor into barrel
- Color-coded barrels marked with Panduit die index numbers for proper crimp die selection
- Enclosed barrel prevents corrosive material from entering barrel when used in harsh environments
- Tin-plated to inhibit corrosion
- UL Listed and CSA Certified to 35 KV\*\* and temperature rated to 90°C when crimped with Panduit crimping tools and dies
- **Tested by Telcordia – meets NEBS Level 3**
- Available with NEMA hole sizes and spacing

C1. Wiring Duct

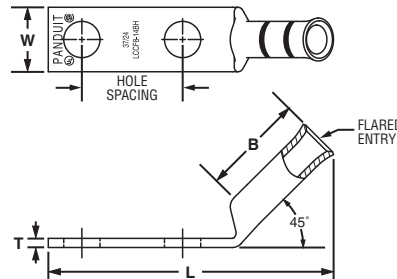

C2. Surface Raceway

C3. Abrasion Protection

C4. Cable Management

D1. Terminals

D2. Power Connectors

D3. Grounding Connectors

E1. Labeling Systems

E2. Labels

E3. Pre-Printed & Write-On Markers

E4. Permanent Identification

E5. Lockout/Tagout & Safety Solutions

F. Index

Part Number	Flex Conductor Size		Stud Hole Size (In.)	Stud Hole Spacing (In.)	Figure Dimensions (In.)				Panduit Color Code	Panduit Die Index No.‡	Wire Strip Length (In.)	Std. Pkg. Qty.
	Class K and M	Diesel Locomotive			W	B	T	L				
LCCF8-14AH-L	—	#8 AWG	1/4	.63	.48	.76	.07	2.00	Red	P21	13/16	50
LCCF8-14BH-L			1/4	.75	.48	.76	.07	2.12	Red	P21	13/16	50
LCCF8-38DH-L			3/8	1.00	.60	.76	.05	2.58	Red	P21	13/16	50
LCCF6-14AH-L	#6 AWG	#6 AWG	1/4	.63	.48	1.22	.08	2.36	Blue	P24	1 5/16	50
LCCF6-14BH-L			1/4	.75	.48	1.22	.08	2.48	Blue	P24	1 5/16	50
LCCF6-38DH-L			3/8	1.00	.62	1.22	.06	2.94	Blue	P24	1 5/16	50
LCCF4-14AH-L	#4 AWG	#4 AWG	1/4	.63	.55	1.23	.09	2.41	Gray	P29	1 5/16	50
LCCF4-14BH-L			1/4	.75	.55	1.23	.09	2.54	Gray	P29	1 5/16	50
LCCF4-38DH-L			3/8	1.00	.62	1.23	.08	3.00	Gray	P29	1 5/16	50
LCCF2-14AH-E	#2 AWG	#2 AWG	1/4	.63	.70	1.36	.11	2.56	Brown	P33	1 7/16	20
LCCF2-14BH-E			1/4	.75	.70	1.36	.11	2.68	Brown	P33	1 7/16	20
LCCF2-56BH-E			5/16	.75	.70	1.36	.11	2.81	Brown	P33	1 7/16	20
LCCF2-38DH-E			3/8	1.00	.70	1.36	.11	3.13	Brown	P33	1 7/16	20
LCCF2-12H-E			1/2	1.75	.75	1.36	.09	4.30	Brown	P33	1 7/16	20
LCCF1-14AH-X	#1 AWG	#1 AWG	1/4	.63	.76	1.44	.12	2.71	Pink	P42	1 1/2	10
LCCF1-14BH-X			1/4	.75	.76	1.44	.12	2.84	Pink	P42	1 1/2	10
LCCF1-56CH-X			5/16	.88	.76	1.44	.12	3.02	Pink	P42	1 1/2	10
LCCF1-38DH-X			3/8	1.00	.76	1.44	.12	3.22	Pink	P42	1 1/2	10
LCCF1-12H-X			1/2	1.75	.80	1.44	.12	4.38	Pink	P42	1 1/2	10
LCCF1/0-14AH-X	1/0 AWG	1/0 AWG	1/4	.63	.85	1.50	.13	2.90	Black	P45	1 9/16	10
LCCF1/0-14BH-X			1/4	.75	.85	1.50	.13	3.02	Black	P45	1 9/16	10
LCCF1/0-56CH-X			5/16	.88	.85	1.50	.13	3.15	Black	P45	1 9/16	10
LCCF1/0-38DH-X			3/8	1.00	.85	1.50	.13	3.34	Black	P45	1 9/16	10
LCCF1/0-12H-X			1/2	1.75	.85	1.50	.13	4.50	Black	P45	1 9/16	10
LCCF2/0-14AH-X	2/0 AWG	2/0 AWG	1/4	.63	.96	1.50	.13	2.92	Orange	P50	1 9/16	10
LCCF2/0-14BH-X			1/4	.75	.96	1.50	.13	3.05	Orange	P50	1 9/16	10
LCCF2/0-38DH-X			3/8	1.00	.96	1.50	.13	3.36	Orange	P50	1 9/16	10
LCCF2/0-12H-X			1/2	1.75	.96	1.50	.13	4.52	Orange	P50	1 9/16	10
LCCF3/0-14BH-X	3/0 AWG	3/0 AWG	1/4	.75	1.06	1.56	.14	3.14	Purple	P54	1 5/8	10
LCCF3/0-38DH-X			3/8	1.00	1.06	1.56	.14	3.47	Purple	P54	1 5/8	10
LCCF3/0-12H-X			1/2	1.75	1.06	1.56	.14	4.61	Purple	P54	1 5/8	10

‡See pages D3.74, D3.75 for tool and die information.

\*\*Consult cable manufacturer for voltage stress relief instructions with applications greater than 2000 V.

◆NEMA hole sizes and spacing.





## Flex Conductor, Two-Hole, Long Barrel, Flared NEBS Lug, 45° Angle (continued)

Part Number	Flex Conductor Size		Stud Hole Size (In.)	Stud Hole Spacing (In.)	Figure Dimensions (In.)				Panduit Color Code	Panduit Die Index No.‡	Wire Strip Length (In.)	Std. Pkg. Qty.
	Class K and M	Diesel Locomotive			W	B	T	L				
LCCF4/0-14BH-X	4/0 AWG	4/0 AWG	1/4	.75	1.17	1.61	.14	3.06	Yellow	P62	1 11/16	10
LCCF4/0-38DH-X			3/8	1.00	1.17	1.61	.14	3.55	Yellow	P62	1 11/16	10
LCCF4/0-38H-X			3/8	1.75	1.17	1.61	.14	4.30	Yellow	P62	1 11/16	10
◆ LCCF4/0-12H-X	250 kcmil	262.6 kcmil	1/2	1.75	1.17	1.61	.14	4.69	Yellow	P62	1 11/16	10
LCCF250-14BH-X			1/4	.75	1.28	2.24	.17	3.66	White	P66	2 5/16	10
LCCF250-38DH-X			3/8	1.00	1.28	2.24	.17	4.14	White	P66	2 5/16	10
LCCF250-12EH-X	300 kcmil	313.1 kcmil	1/2	1.25	1.28	2.24	.17	4.82	White	P66	2 5/16	10
◆ LCCF250-12H-X			1/2	1.75	1.28	2.24	.17	5.32	White	P66	2 5/16	10
LCCF300-14BH-6			1/4	.75	1.38	2.30	.18	3.77	Red	P71	2 3/8	6
LCCF300-38DH-6	350 kcmil	373.7 kcmil	3/8	1.00	1.38	2.30	.18	4.25	Red	P71	2 3/8	6
◆ LCCF300-12H-6			1/2	1.75	1.38	2.30	.18	5.43	Red	P71	2 3/8	6
LCCF350-14BH-6			1/4	.75	1.53	2.50	.22	3.98	Blue	P76	2 9/16	6
LCCF350-38DH-6	400 kcmil	444.4 kcmil	3/8	1.00	1.53	2.50	.22	4.46	Blue	P76	2 9/16	6
LCCF350-12EH-6			1/2	1.25	1.53	2.50	.22	5.14	Blue	P76	2 9/16	6
◆ LCCF350-12H-6			1/2	1.75	1.53	2.50	.22	5.64	Blue	P76	2 9/16	6
LCCF400-38DH-6	500 kcmil	535.3 kcmil	3/8	1.00	1.70	2.69	.26	4.66	Brown	P87	2 3/4	6
◆ LCCF400-12H-6			1/2	1.75	1.70	2.69	.26	5.84	Brown	P87	2 3/4	6
◆ LCCF500-12H-6			1/2	1.75	1.89	2.88	.26	6.18	Pink	P99	2 15/16	6
◆ LCCF600-12H-6	—	646.4 kcmil	1/2	1.75	1.95	2.94	.29	6.25	Black	P106	3	6
LCCF750-38DH-3	—	777.7 kcmil	3/8	1.00	2.17	3.00	.32	5.45	Orange	P107	3 1/16	3
◆ LCCF750-12H-3			1/2	1.75	2.17	3.00	.32	6.39	Orange	P107	3 1/16	3

‡See pages D3.74, D3.75 for tool and die information.

\*\*Consult cable manufacturer for voltage stress relief instructions with applications greater than 2000 V.

◆NEMA hole sizes and spacing.

A.  
System Overview

B1.  
Cable Ties

B2.  
Cable Accessories

B3.  
Stainless Steel Ties

C1.  
Wiring Duct

C2.  
Surface Raceway

C3.  
Abrasion Protection

C4.  
Cable Management

D1.  
Terminals

D2.  
Power Connectors

D3.  
Grounding Connectors

E1.  
Labeling Systems

E2.  
Labels

E3.  
Pre-Printed & Write-On Markers

E4.  
Permanent Identification

E5.  
Lockout/Tagout & Safety Solutions

F.  
Index

A. System Overview



## Flex Conductor, Two-Hole, Long Barrel, Flared NEBS Lug, 90° Angle

B1. Cable Ties

**For Use with Flexible and Extra-Flexible Copper Conductors**

### Type LCCF-F

B2. Cable Accessories

- Can be used with flex conductor class: K, M, and Diesel Locomotive
- Long barrel maximizes the number of crimps and provides premium wire pull-out strength and electrical performance
- Flared entry prevents bent back strands when inserting fine strand conductor into barrel
- Color-coded barrels marked with Panduit die index numbers for proper crimp die selection
- Enclosed barrel prevents corrosive material from entering barrel when used in harsh environments
- Tin-plated to inhibit corrosion
- UL Listed and CSA Certified to 35 KV\*\* and temperature rated to 90°C when crimped with Panduit crimping tools and dies
- **Tested by Telcordia – meets NEBS Level 3**
- Available with NEMA hole sizes and spacing

B3. Stainless Steel Ties

C1. Wiring Duct



C2. Surface Raceway

C3. Abrasion Protection

C4. Cable Management

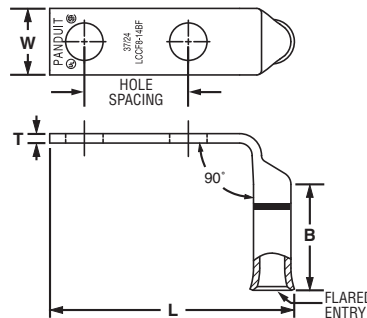

D1. Terminals

D2. Power Connectors

D3. Grounding Connectors

E1. Labeling Systems

E2. Labels

E3. Pre-Printed & Write-On Markers

E4. Permanent Identification

E5. Lockout/Tagout & Safety Solutions

F. Index

Part Number	Flex Conductor Size		Stud Hole Size (In.)	Stud Hole Spacing (In.)	Figure Dimensions (In.)				Panduit Color Code	Panduit Die Index No.‡	Wire Strip Length (In.)	Std. Pkg. Qty.
	Class K and M	Diesel Locomotive			W	B	T	L				
LCCF8-14AF-L	—	#8 AWG	1/4	.63	.48	.76	.07	1.64	Red	P21	13/16	50
LCCF8-14BF-L			1/4	.75	.48	.76	.07	1.77	Red	P21	13/16	50
LCCF8-38DF-L			3/8	1.00	.60	.76	.05	2.24	Red	P21	13/16	50
LCCF6-14AF-L	#6 AWG	#6 AWG	1/4	.63	.48	1.22	.08	1.69	Blue	P24	1 5/16	50
LCCF6-14BF-L			1/4	.75	.48	1.22	.08	1.81	Blue	P24	1 5/16	50
LCCF6-38DF-L			3/8	1.00	.62	1.22	.06	2.28	Blue	P24	1 5/16	50
LCCF4-14AF-L	#4 AWG	#4 AWG	1/4	.63	.55	1.23	.09	1.78	Gray	P29	1 5/16	50
LCCF4-14BF-L			1/4	.75	.55	1.23	.09	1.91	Gray	P29	1 5/16	50
LCCF2-14BF-E			1/4	.75	.70	1.36	.11	2.10	Brown	P33	1 7/16	20
LCCF2-56BF-E	#2 AWG	#2 AWG	5/16	.75	.70	1.36	.11	2.23	Brown	P33	1 7/16	20
LCCF2-38DF-E			3/8	1.00	.70	1.36	.11	2.55	Brown	P33	1 7/16	20
LCCF2-12F-E			1/2	1.75	.79	1.36	.09	3.72	Brown	P33	1 7/16	20
LCCF1-14AF-X	#1 AWG	#1 AWG	1/4	.63	.76	1.44	.12	2.11	Pink	P42	1 1/2	10
LCCF1-14BF-X			1/4	.75	.76	1.44	.12	2.24	Pink	P42	1 1/2	10
LCCF1-56CF-X			5/16	.88	.76	1.44	.12	2.42	Pink	P42	1 1/2	10
LCCF1-38DF-X			3/8	1.00	.76	1.44	.12	2.62	Pink	P42	1 1/2	10
LCCF1-12F-X			1/2	1.75	.80	1.44	.11	3.79	Pink	P42	1 1/2	10
LCCF1/0-14AF-X			1/0 AWG	1/0 AWG	1/4	.63	.85	1.50	.13	2.27	Black	P45
LCCF1/0-14BF-X	1/4	.75			.85	1.50	.13	2.39	Black	P45	1 9/16	10
LCCF1/0-56CF-X	5/16	.88			.85	1.50	.13	2.52	Black	P45	1 9/16	10
LCCF1/0-38DF-X	3/8	1.00			.85	1.50	.13	2.70	Black	P45	1 9/16	10
LCCF1/0-12F-X	1/2	1.75			.85	1.50	.13	3.87	Black	P45	1 9/16	10
LCCF2/0-14AF-X	2/0 AWG	2/0 AWG			1/4	.63	.96	1.50	.13	2.33	Orange	P50
LCCF2/0-14BF-X			1/4	.75	.96	1.50	.13	2.46	Orange	P50	1 9/16	10
LCCF2/0-38DF-X			3/8	1.00	.96	1.50	.13	2.77	Orange	P50	1 9/16	10
LCCF2/0-12F-X			1/2	1.75	.96	1.50	.13	3.93	Orange	P50	1 9/16	10
LCCF3/0-14BF-X			3/0 AWG	3/0 AWG	1/4	.75	1.06	1.56	.14	2.56	Purple	P54
LCCF3/0-38DF-X	3/8	1.00			1.06	1.56	.14	2.89	Purple	P54	1 5/8	10
LCCF3/0-12F-X	1/2	1.75			1.06	1.56	.14	4.03	Purple	P54	1 5/8	10

‡See pages D3.74, D3.75 for tool and die information.

\*\*Consult cable manufacturer for voltage stress relief instructions with applications greater than 2000 V.



## Flex Conductor, Two-Hole, Long Barrel, Flared NEBS Lug, 90° Angle (continued)

Part Number	Flex Conductor Size		Stud Hole Size (In.)	Stud Hole Spacing (In.)	Figure Dimensions (In.)				Panduit Color Code	Panduit Die Index No.‡	Wire Strip Length (In.)	Std. Pkg. Qty.
	Class K and M	Diesel Locomotive			W	B	T	L				
LCCF4/0-14BF-X	4/0 AWG	4/0 AWG	1/4	.75	1.17	1.61	.14	2.48	Yellow	P62	1 11/16	10
LCCF4/0-38DF-X			3/8	1.00	1.17	1.61	.14	2.97	Yellow	P62	1 11/16	10
LCCF4/0-38F-X			3/8	1.75	1.17	1.61	.14	3.72	Yellow	P62	1 11/16	10
◆ LCCF4/0-12F-X	250 kcmil	262.6 kcmil	1/2	1.75	1.17	1.61	.14	4.11	Yellow	P62	1 11/16	10
LCCF250-14BF-X			1/4	.75	1.28	2.24	.17	2.54	White	P66	2 5/16	10
LCCF250-38DF-X			3/8	1.00	1.28	2.24	.17	3.02	White	P66	2 5/16	10
◆ LCCF250-12EF-X	250 kcmil	262.6 kcmil	1/2	1.25	1.28	2.24	.17	3.70	White	P66	2 5/16	10
LCCF250-12F-X			1/2	1.75	1.28	2.24	.17	4.20	White	P66	2 5/16	10
◆ LCCF300-14BF-6	300 kcmil	313.1 kcmil	1/4	.75	1.38	2.30	.18	2.61	Red	P71	2 3/8	6
LCCF300-38DF-6			3/8	1.00	1.38	2.30	.18	3.09	Red	P71	2 3/8	6
◆ LCCF300-12F-6			1/2	1.75	1.38	2.30	.18	4.27	Red	P71	2 3/8	6
◆ LCCF350-14BF-6	350 kcmil	373.7 kcmil	1/4	.75	1.53	2.50	.22	2.73	Blue	P76	2 9/16	6
LCCF350-38DF-6			3/8	1.00	1.53	2.50	.22	3.21	Blue	P76	2 9/16	6
LCCF350-12EF-6			1/2	1.25	1.53	2.50	.22	3.89	Blue	P76	2 9/16	6
◆ LCCF350-12F-6	350 kcmil	373.7 kcmil	1/2	1.75	1.53	2.50	.22	4.39	Blue	P76	2 9/16	6
◆ LCCF400-38DF-6			3/8	1.00	1.70	2.69	.26	3.33	Brown	P87	2 3/4	6
◆ LCCF400-12F-6	400 kcmil	444.4 kcmil	1/2	1.75	1.70	2.69	.26	4.51	Brown	P87	2 3/4	6
◆ LCCF500-12F-6	500 kcmil	535.3 kcmil	1/2	1.75	1.89	2.88	.26	4.67	Pink	P99	2 15/16	6
◆ LCCF600-12F-6	—	646.4 kcmil	1/2	1.75	1.95	2.88	.29	4.73	Black	P106	3	6
◆ LCCF750-38DF-3	—	777.7 kcmil	3/8	1.00	2.17	3.00	.32	3.96	Orange	P107	3 1/16	3
◆ LCCF750-12F-3			1/2	1.75	2.17	3.00	.32	4.90	Orange	P107	3 1/16	3

‡See pages D3.74, D3.75 for tool and die information.

\*\*Consult cable manufacturer for voltage stress relief instructions with applications greater than 2000 V.

◆NEMA hole sizes and spacing.

A.  
System Overview

B1.  
Cable Ties

B2.  
Cable Accessories

B3.  
Stainless Steel Ties

C1.  
Wiring Duct

C2.  
Surface Raceway

C3.  
Abrasion Protection

C4.  
Cable Management

D1.  
Terminals

D2.  
Power Connectors

D3.  
Grounding Connectors

E1.  
Labeling Systems

E2.  
Labels

E3.  
Pre-Printed & Write-On Markers

E4.  
Permanent Identification

E5.  
Lockout/Tagout & Safety Solutions

F.  
Index

A. System Overview



## Flex Conductor, Standard Barrel, Flared, NEBS Butt Splice

B1. Cable Ties

**For Use with Flexible and Extra-Flexible Copper Conductors**

### Type SCSF

- Can be used with flex conductor class: K, M, and Diesel Locomotive
- Flared entry prevents bent back strands when inserting fine strand conductor into barrel
- Color-coded barrels marked with Panduit die index numbers for proper crimp die selection
- Internal wire stops to prevent over-insertion of conductor
- Tin-plated to inhibit corrosion
- UL Listed and CSA Certified to 35 KV\*\* and temperature rated to 90°C when crimped with Panduit crimping tools and dies
- **Tested by Telcordia – meets NEBS Level 3**
- American Bureau of Shipping approved

B2. Cable Accessories

B3. Stainless Steel Ties

C1. Wiring Duct

C2. Surface Raceway

C3. Abrasion Protection

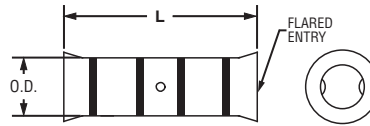

C4. Cable Management

D1. Terminals

D2. Power Connectors

D3. Grounding Connectors

Part Number	Flex Conductor Size		Figure Dimensions (In.)		Panduit Color Code	Panduit Die Index No.‡	Wire Strip Length (In.)	Std. Pkg. Qty.
	Class K and M	Diesel Locomotive	Barrel O.D.	L				
SCSF8-L	—	#8 AWG	0.27	1.50	Red	P21	11/16	50
SCSF6-L	#6 AWG	#6 AWG	0.31	1.75	Blue	P24	13/16	50
SCSF4-L	#4 AWG	#4 AWG	0.38	1.75	Gray	P29	13/16	50
SCSF2-E	#2 AWG	#2 AWG	0.47	1.87	Brown	P33	7/8	20
SCSF1-X	#1 AWG	#1 AWG	0.52	1.87	Pink	P42	7/8	10
SCSF1/0-X	1/0 AWG	1/0 AWG	0.58	2.50	Black	P45	1 3/16	10
SCSF2/0-X	2/0 AWG	2/0 AWG	0.64	2.50	Orange	P50	1 3/16	10
SCSF3/0-X	3/0 AWG	3/0 AWG	0.71	2.50	Purple	P54	1 3/16	10
SCSF4/0-X	4/0 AWG	4/0 AWG	0.77	2.50	Yellow	P62	1 3/16	10
SCSF250-X	250 kcmil	262.6 kcmil	0.88	2.50	White	P66	1 3/16	10
SCSF300-6	300 kcmil	313.1 kcmil	0.95	2.56	Red	P71	1 1/4	6
SCSF350-6	350 kcmil	373.7 kcmil	1.06	2.94	Blue	P76	1 1/2	6

‡See pages D3.74, D3.75 for tool and die information.

\*\*Consult cable manufacturer for voltage stress relief instructions with applications greater than 2000 V.

E1. Labeling Systems

E2. Labels

E3. Pre-Printed & Write-On Markers

E4. Permanent Identification

E5. Lockout/Tagout & Safety Solutions

F. Index

## Code/Flex Conductor, with Window, In-Line Reducing Splice Kit

### Type RSCK

- Includes all components in one package for making a complete electrical connection: Panduit copper compression RSC in-line reducing splice (see pages D2.105 – D2.106) and crystal clear PVC heat shrink sleeves pre-cut to length to insulate reducing splice
- Panduit RSC in-line reducing splice is UL Listed and temperature rated to 90°C when crimped with Panduit crimping tools and dies
- Panduit crystal clear PVC heat shrink has a UL 224 VW-1 flammability rating and passes Telcordia GR-347-CORE Compression and Cut-Through Penetration Test and Abrasion Resistance Test
- Panduit crystal clear PVC heat shrink is UL Recognized with a temperature rating of 150°C, high temperature insulating property
- Rated for 600 V applications when Panduit crystal clear PVC heat shrink is applied



Part Number	Part Description	Std. Pkg. Qty.
RSCK4-6-1	Kit contains: 1 pc. RSC4-6-L copper compression in-line reducing splice. 1 pc. HSTTPN50-713-Q crystal clear PVC heat shrink 1/2" dia. x 7.125" long.	1
RSCK2-6-1	Kit contains: 1 pc. RSC2-6-Q copper compression in-line reducing splice. 1 pc. HSTTPN62-750-Q crystal clear PVC heat shrink 5/8" dia. x 7.500" long.	1
RSCK2-4-1	Kit contains: 1 pc. RSC2-4-Q copper compression in-line reducing splice. 1 pc. HSTTPN62-750-Q crystal clear PVC heat shrink 5/8" dia. x 7.500" long.	1
RSCK1/0-6-1	Kit contains: 1 pc. RSC1/0-6-X copper compression in-line reducing splice. 1 pc. HSTTPN75-775-Q crystal clear PVC heat shrink 3/4" dia. x 7.750" long. 1 pc. HSTTPN50-438-L crystal clear PVC heat shrink 1/2" dia. x 4.375" long.	1
RSCK1/0-4-1	Kit contains: 1 pc. RSC1/0-4-X copper compression in-line reducing splice. 1 pc. HSTTPN75-775-Q crystal clear PVC heat shrink 3/4" dia. x 7.750" long. 1 pc. HSTTPN50-438-L crystal clear PVC heat shrink 1/2" dia. x 4.375" long.	1
RSCK2/0-6-1	Kit contains: 1 pc. RSC2/0-6-X copper compression in-line reducing splice. 1 pc. HSTTPN75-775-Q crystal clear PVC heat shrink 3/4" dia. x 7.750" long. 1 pc. HSTTPN50-438-L crystal clear PVC heat shrink 1/2" dia. x 4.375" long.	1
RSCK2/0-4-1	Kit contains: 1 pc. RSC2/0-4-X copper compression in-line reducing splice. 1 pc. HSTTPN75-775-Q crystal clear PVC heat shrink 3/4" dia. x 7.750" long. 1 pc. HSTTPN50-438-L crystal clear PVC heat shrink 1/2" dia. x 4.375" long.	1
RSCK4/0-6-1	Kit contains: 1 pc. RSC4/0-6-X copper compression in-line reducing splice. 1 pc. HSTTPN100-775-Q crystal clear PVC heat shrink 1" dia. x 7.750" long. 1 pc. HSTTPN50-438-L crystal clear PVC heat shrink 1/2" dia. x 4.375" long.	1
RSCK4/0-4-1	Kit contains: 1 pc. RSC4/0-4-X copper compression in-line reducing splice. 1 pc. HSTTPN100-775-Q crystal clear PVC heat shrink 1" dia. x 7.750" long. 1 pc. HSTTPN50-438-L crystal clear PVC heat shrink 1/2" dia. x 4.375" long.	1

Table continues on page D2.104

A.  
System  
Overview

## Code/Flex Conductor, with Window, In-Line Reducing Splice Kit (continued)

B1.  
Cable Ties

B2.  
Cable  
Accessories



B3.  
Stainless  
Steel Ties

Part Number	Part Description	Std. Pkg. Qty.
<b>RSC4/0-1/0-1</b>	Kit contains: 1 pc. RSC4/0-1/0-X copper compression in-line reducing splice. 1 pc. HSTTPN100-775-Q crystal clear PVC heat shrink 1" dia. x 7.750" long. 1 pc. HSTTPN75-775-Q crystal clear PVC heat shrink 3/4" dia. x 7.750" long.	1
<b>RSC4/0-2/0-1</b>	Kit contains: 1 pc. RSC4/0-2/0-X copper compression in-line reducing splice. 1 pc. HSTTPN100-775-Q crystal clear PVC heat shrink 1" dia. x 7.750" long. 1 pc. HSTTPN75-775-Q crystal clear PVC heat shrink 3/4" dia. x 7.750" long.	1
<b>RSC500-X4/0-1</b>	Kit contains: 1 pc. RSC500-X4/0-6 copper compression in-line reducing splice. 1 pc. HSTTPN150-925-X crystal clear PVC heat shrink 1 1/2" dia. x 9.250" long.	1
<b>RSC500-X350-1</b>	Kit contains: 1 pc. RSC500-X350-6 copper compression in-line reducing splice. 1 pc. HSTTPN150-925-X crystal clear PVC heat shrink 1 1/2" dia. x 9.250" long.	1
<b>RSC750-4/0-1</b>	Kit contains: 1 pc. RSC750-4/0-6 copper compression in-line reducing splice. 1 pc. HSTTPN150-925-X crystal clear PVC heat shrink 1 1/2" dia. x 9.250" long. 1 pc. HSTTPN100-775-Q crystal clear PVC heat shrink 1" dia. x 7.750" long.	1
<b>RSC750-X4/0-1</b>	Kit contains: 1 pc. RSC750-X4/0-6 copper compression in-line reducing splice. 1 pc. HSTTPN150-925-X crystal clear PVC heat shrink 1 1/2" dia. x 9.250" long.	1
<b>RSC750-X350-1</b>	Kit contains: 1 pc. RSC750-X350-6 copper compression in-line reducing splice. 1 pc. HSTTPN150-925-X crystal clear PVC heat shrink 1 1/2" dia. x 9.250" long.	1
<b>RSC750-500-1</b>	Kit contains: 1 pc. RSC750-500-6 copper compression in-line reducing splice. 1 pc. HSTTPN150-925-X crystal clear PVC heat shrink 1 1/2" dia. x 9.250" long.	1
<b>RSC750-X500-1</b>	Kit contains: 1 pc. RSC750-X500-6 copper compression in-line reducing splice. 1 pc. HSTTPN150-925-X crystal clear PVC heat shrink 1 1/2" dia. x 9.250" long.	1
<b>RSC750-750-1</b>	Kit contains: 1 pc. RSC750-750-6 copper compression in-line reducing splice. 1 pc. HSTTPN150-925-X crystal clear PVC heat shrink 1 1/2" dia. x 9.250" long.	1
<b>RSCX750-4/0-1</b>	Kit contains: 1 pc. RSCX750-4/0-3 copper compression in-line reducing splice. 1 pc. HSTTPN200-950-X crystal clear PVC heat shrink 2" dia. x 9.500" long. 1 pc. HSTTPN100-775-Q crystal clear PVC heat shrink 1" dia. x 7.750" long.	1
<b>RSCX750-750-1</b>	Kit contains: 1 pc. RSCX750-750-3 copper compression in-line reducing splice. 1 pc. HSTTPN200-950-X crystal clear PVC heat shrink 2" dia. x 9.500" long.	1

C1.  
Wiring  
Duct

C2.  
Surface  
Raceway

C3.  
Abrasion  
Protection

C4.  
Cable  
Management

D1.  
Terminals

D2.  
Power  
Connectors

D3.  
Grounding  
Connectors

E1.  
Labeling  
Systems

E2.  
Labels

E3.  
Pre-Printed  
& Write-On  
Markers

E4.  
Permanent  
Identification

E5.  
Lockout/  
Tagout  
& Safety  
Solutions

F.  
Index



## Code/Flex Conductor, with Window, In-Line Reducing Splice

For Use with Stranded Copper Code and Class I Flex Conductors

### Type RSC

- Low profile design provides minimum space requirements
- Manufactured from seamless, high conductivity copper tubing
- Color-coded barrels marked with Panduit and specified competitor die index numbers for proper crimp die selection
- Inspection windows in each barrel to visually assure full conductor insertion
- Generous internally beveled wire entry for easy conductor insertion
- Tin-plated to inhibit corrosion
- UL Listed and CSA Certified to 35 KV\*\* and temperature rated to 90°C when crimped with Panduit and specified competitor crimping tools and dies
- Also sold as a kit with crystal clear PVC heat shrink (see pages D2.103, D2.104)



Part Number		Copper Conductor Size	Figure Dimensions (In.)		Panduit Color Code	Panduit Die Index No.‡	Burdny Die Index No.‡	T&B Die Index No.‡	Wire Strip Length (In.)	Std. Pkg. Qty.
			B	L						
RSC4-6-L	Reduces From	#4 – 3 AWG STR,#2 AWG SOL	1.05	2.54	Gray	P29	8	29	1	1
	Reduces To	#6 AWG	1.38		Blue	P24	7	24	1 5/16	
RSC2-6-Q	Reduces From	#2 AWG	1.05	2.62	Brown	P33	10	33	1	1
	Reduces To	#6 AWG	1.38		Blue	P24	7	34	1 5/16	
RSC2-4-Q	Reduces From	#2 AWG	1.05	2.50	Brown	P33	10	33	1	1
	Reduces To	#4 – 3 AWG STR,#2 AWG SOL	1.38		Gray	P29	8	29	1 5/16	
RSC1/0-6-X	Reduces From	1/0 AWG	1.05	2.81	Pink	P42	12	42	1	1
	Reduces To	#6 AWG	1.38		Blue	P24	7	24	1 5/16	
RSC1/0-4-X	Reduces From	1/0 AWG	1.05	2.70	Pink	P42	12	42	1	1
	Reduces To	#4 – 3 AWG STR,#2 AWG SOL	1.38		Gray	P29	8	29	1 5/16	
RSC2/0-6-X	Reduces From	2/0 AWG	1.13	2.99	Black	P45	13	45	1 1/16	1
	Reduces To	#6 AWG	1.38		Blue	P24	7	24	1 5/16	
RSC2/0-4-X	Reduces From	2/0 AWG	1.13	2.88	Black	P45	13	45	1 1/16	1
	Reduces To	#4 – 3 AWG STR,#2 AWG SOL	1.38		Gray	P29	8	29	1 5/16	
RSC4/0-6-X	Reduces From	4/0 AWG	1.13	3.24	Purple	P54	15	54	1 1/16	1
	Reduces To	#6 AWG	1.38		Blue	P24	7	24	1 5/16	
RSC4/0-4-X	Reduces From	4/0 AWG	1.13	3.12	Purple	P54	15	54	1 1/16	1
	Reduces To	#4 – 3 AWG STR,#2 AWG SOL	1.38		Gray	P29	8	29	1 5/16	
RSC4/0-1/0-X	Reduces From	4/0 AWG	1.16	3.13	Purple	P54	15	54	1 1/16	1
	Reduces To	1/0 AWG	1.63		Pink	P42	12	42	1 9/16	
RSC4/0-2/0-X	Reduces From	4/0 AWG	1.16	2.90	Purple	P54	15	54	1 1/16	1
	Reduces To	2/0 AWG	1.50		Black	P45	13	45	1 7/16	
RSC500-X4/0-6	Reduces From	500 kcmil	1.94	3.97	Brown	P87	20	87	1 7/8	1
	Reduces To	4/0 Flex	1.50		Yellow	P62	16	62	1 7/16	
RSC500-X350-6	Reduces From	500 kcmil	1.94	4.38	Brown	P87	20	87	1 7/8	1
	Reduces To	350 Flex	1.94		Blue	P76	19	76	1 7/8	

‡See pages D3.76 – D3.81 for tool and die information.

\*\*Consult cable manufacturer for voltage stress relief instructions with applications greater than 2000 V.

Table continues on page D2.106

A. System Overview

B1. Cable Ties

B2. Cable Accessories

B3. Stainless Steel Ties

C1. Wiring Duct

C2. Surface Raceway

C3. Abrasion Protection

C4. Cable Management

D1. Terminals

D2. Power Connectors

D3. Grounding Connectors

E1. Labeling Systems

E2. Labels

E3. Pre-Printed & Write-On Markers

E4. Permanent Identification

E5. Lockout/Tagout & Safety Solutions

F. Index

A.  
System  
Overview



## Code/Flex Conductor, with Window, In-Line Reducing Splice (continued)

B1.  
Cable Ties

B2.  
Cable  
Accessories

B3.  
Stainless  
Steel Ties

C1.  
Wiring  
Duct

C2.  
Surface  
Raceway

C3.  
Abrasion  
Protection

C4.  
Cable  
Management

D1.  
Terminals

D2.  
Power  
Connectors

D3.  
Grounding  
Connectors

E1.  
Labeling  
Systems

E2.  
Labels

E3.  
Pre-Printed  
& Write-On  
Markers

E4.  
Permanent  
Identification

E5.  
Lockout/  
Tagout  
& Safety  
Solutions

F.  
Index

Part Number		Copper Conductor Size	Figure Dimensions (In.)		Panduit Color Code	Panduit Die Index No.‡	Burdy Die Index No.‡	T&B Die Index No.‡	Wire Strip Length (In.)	Std. Pkg. Qty.
			B	L						
<b>RSC750-4/0-6</b>	Reduces From	750 kcmil	2.06	4.66	Black	P106	24	106	2	1
	Reduces To	4/0 AWG	1.50		Purple	P54	15	54	1 5/8	
<b>RSC750-X4/0-6</b>	Reduces From	750 kcmil	2.06	4.54	Black	P106	24	106	2	1
	Reduces To	4/0 Flex	1.50		Yellow	P62	16	62	1 7/16	
<b>RSC750-X350-6</b>	Reduces From	750 kcmil	2.06	4.45	Black	P106	24	106	2	1
	Reduces To	350 Flex	1.94		Blue	P76	19	76	1 7/8	
<b>RSC750-500-6</b>	Reduces From	750 kcmil	2.06	4.45	Black	P106	24	106	2	1
	Reduces To	500 kcmil	1.94		Brown	P87	20	87	1 7/8	
<b>RSC750-X500-6</b>	Reduces From	750 kcmil	2.06	4.63	Black	P106	24	106	2	1
	Reduces To	500 Flex	2.06		Pink	P99	400	99	2	
<b>RSC750-750-6</b>	Reduces From	750 kcmil	2.06	4.63	Black	P106	24	106	2	1
	Reduces To	750 kcmil	2.06		Black	P106	24	106	2	
<b>RSCX750-4/0-3</b>	Reduces From	750 Flex	2.06	5.04	Yellow	P115	115	115	2	1
	Reduces To	4/0 AWG	1.50		Purple	P54	15	54	1 5/8	
<b>RSCX750-750-3</b>	Reduces From	750 Flex	2.06	4.50	Yellow	P115	115	115	2	1
	Reduces To	750 kcmil	2.06		Black	P106	24	106	2	

‡See pages D3.76 – D3.81 for tool and die information.

\*\*Consult cable manufacturer for voltage stress relief instructions with applications greater than 2000 V.



## Part Number System for Metric Lugs



**LCMA**                      **150**                      —                      **10**                      —

150 = 150mm<sup>2</sup>                      10 = 10mm



**X**

1 = 1                      X = 10                      C = 100  
5 = 5                      L = 50

## Part Number System for Pan-Lug™ Compression Metric Lugs

<b>LCMA</b>	<b>150</b>	—	<b>10</b>	—	<b>X</b>
Type	Conductor Size		Stud Hole Size		Standard Package Size
			5 = #5		1 = 1
			6 = 6mm		5 = 5
			8 = 8mm		6 = 6
			10 = 10mm		X = 10
			12 = 12mm		Q = 25
			14 = 14mm		L = 50
			16 = 16mm		C = 100
			20 = 20mm		
			00 = Blank Tongue*		

## Metric Conductor, One-Hole, Standard Barrel with Window Lug

### For Use with Class 2 Stranded Copper Conductors

#### Type LCMA

- Inspection window to visually assure full conductor insertion
- Tin-plated to inhibit corrosion
- UL Listed, UL Recognized, and CSA Certified to 35 KV\*\* and temperature rated to 90°C when crimped with Panduit tools and dies

- Product information marked on connector for selection and installation
- Rounded tongue convenient for use in tight spaces
- Internally beveled wire entry for fast and easy installation

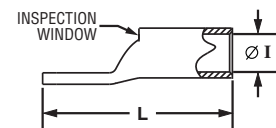
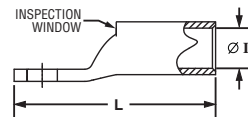
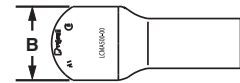
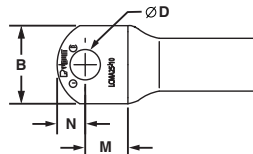

Part Number	Copper Conductor Size Class 2R (mm <sup>2</sup> )	Current Rating (Amps)	Stud Hole Size (mm)	Figure Dimensions (mm)						Panduit Die Index No.‡	Std. Pkg. Qty.
				ØI	B	M	N	L	ØD		
LCMA6-5-C*	4 – 6	30	M5	3.8	10.0	7.8	6.2	27.5	5.5	P10	100
LCMA6-6-C*	4 – 6	30	M6	3.8	10.8	7.8	6.2	27.5	6.6	P10	100
LCMA6-8-C*	4 – 6	30	M8	3.8	13.0	8.0	8.0	30.5	9.0	P10	100

‡See page D3.83 for tool and die information.

\*UL Recognized only.

\*\*Consult cable manufacturer for voltage stress relief instructions with applications greater than 2000 V.

Table continues on page D2.108

A. System Overview

B1. Cable Ties

B2. Cable Accessories

B3. Stainless Steel Ties

C1. Wiring Duct

C2. Surface Raceway

C3. Abrasion Protection

C4. Cable Management

D1. Terminals

D2. Power Connectors

D3. Grounding Connectors

E1. Labeling Systems

E2. Labels

E3. Pre-Printed & Write-On Markers

E4. Permanent Identification

E5. Lockout/Tagout & Safety Solutions

F. Index

# PANDUIT® ELECTRICAL SOLUTIONS

A. System Overview



## Metric Conductor, One-Hole, Standard Barrel with Window Lug (continued)

B1. Cable Ties

B2. Cable Accessories

B3. Stainless Steel Ties

C1. Wiring Duct

C2. Surface Raceway

C3. Abrasion Protection

C4. Cable Management

D1. Terminals

D2. Power Connectors

D3. Grounding Connectors

E1. Labeling Systems

E2. Labels

E3. Pre-Printed & Write-On Markers

E4. Permanent Identification

E5. Lockout/Tagout & Safety Solutions

F. Index

Part Number	Copper Conductor Size Class 2R (mm <sup>2</sup> )	Current Rating (Amps)	Stud Hole Size (mm)	Figure Dimensions (mm)						Panduit Die Index No.‡	Std. Pkg. Qty.
				ØI	B	M	N	L	ØD		
LCMA10-5-C	10	—	M5	4.5	11.0	9.8	6.0	30.8	5.5	P21	100
LCMA10-6-C	10	—	M6	4.5	11.0	9.8	6.0	30.8	6.6	P21	100
LCMA10-8-C	10	—	M8	4.5	13.0	8.5	8.0	30.8	9.0	P21	100
LCMA10-10-C	10	—	M10	4.4	14.5	8.5	8.0	30.8	11.0	P21	100
LCMA16-5-C*	16	65	M5	5.5	13.0	10.3	6.5	34.5	5.5	P24	100
LCMA16-6-C*	16	65	M6	5.5	13.0	10.3	6.5	34.5	6.6	P24	100
LCMA16-8-C*	16	65	M8	5.5	13.0	10.3	6.5	34.5	9.0	P24	100
LCMA16-10-C*	16	65	M10	5.5	15.0	10.2	8.0	36.7	11.0	P24	100
LCMA25-6-C	25	—	M6	6.9	14.0	10.0	8.0	37.0	6.6	P29	100
LCMA25-8-C	25	—	M8	6.9	15.5	10.0	8.0	37.0	9.0	P29	100
LCMA25-10-C	25	—	M10	6.9	15.5	10.0	8.0	37.0	11.0	P29	100
LCMA35-6-C	35	—	M6	8.2	15.5	12.3	8.5	42.0	6.6	P29	100
LCMA35-8-C	35	—	M8	8.2	15.5	12.3	8.5	42.0	9.0	P29	100
LCMA35-10-C	35	—	M10	8.2	15.5	12.3	8.5	42.0	11.0	P29	100
LCMA35-12-C	35	—	M12	8.2	21.5	14.5	11.5	48.0	14.0	P29	100
LCMA50-6-L	50	—	M6	9.8	18.0	11.5	10.0	46.5	6.6	P37	50
LCMA50-8-L	50	—	M8	9.8	18.0	11.5	10.0	46.5	9.0	P37	50
LCMA50-10-L	50	—	M10	9.8	18.0	11.5	10.0	46.5	11.0	P37	50
LCMA50-12-L	50	—	M12	9.8	23.0	14.0	11.0	50.0	14.0	P37	50
LCMA70-6-L	70	—	M6	11.5	20.8	14.5	11.5	53.5	6.6	P45	50
LCMA70-8-L	70	—	M8	11.5	20.8	14.5	11.5	53.5	9.0	P45	50
LCMA70-10-L	70	—	M10	11.5	20.8	14.5	11.5	53.5	11.0	P45	50
LCMA70-12-L	70	—	M12	11.5	20.8	14.5	11.5	53.5	14.0	P45	50
LCMA95-8-L	95	—	M8	13.5	24.5	15.0	13.5	60.5	9.0	P54	50
LCMA95-10-L	95	—	M10	13.5	24.5	15.0	13.5	60.5	11.0	P54	50
LCMA95-12-L	95	—	M12	13.5	24.5	15.0	13.5	60.5	14.0	P54	50
LCMA95-16-L	95	—	M16	13.5	24.5	15.0	13.5	60.5	18.0	P54	50
LCMA120-8-L	120	—	M8	15.2	27.5	15.5	14.5	65.0	9.0	P62	50
LCMA120-10-L	120	—	M10	15.2	27.5	15.5	14.5	65.0	11.0	P62	50
LCMA120-12-L	120	—	M12	15.2	27.5	15.5	14.5	65.0	14.0	P62	50
LCMA120-16-L	120	—	M16	15.2	27.5	15.5	14.5	65.0	18.0	P62	50
LCMA150-8-X	150	—	M8	16.5	30.5	18.0	16.5	70.5	9.0	P66	10
LCMA150-10-X	150	—	M10	16.5	30.5	18.0	16.5	70.5	11.0	P66	10
LCMA150-12-X	150	—	M12	16.5	30.5	18.0	16.5	70.5	14.0	P66	10
LCMA150-16-X	150	—	M16	16.5	30.5	18.0	16.5	70.5	18.0	P66	10
LCMA150-20-X	150	—	M20	16.5	30.5	22.0	16.5	74.0	22.0	P66	10
LCMA185-10-X	185	—	M10	18.6	33.5	16.5	17.5	72.5	11.0	P76	10
LCMA185-12-X	185	—	M12	18.6	33.5	16.5	17.5	72.5	14.0	P76	10
LCMA185-16-X	185	—	M16	18.6	33.5	16.5	17.5	72.5	18.0	P76	10
LCMA185-20-X	185	—	M20	18.6	33.5	21.0	17.5	77.0	22.0	P76	10
LCMA240-10-X	240	—	M10	20.8	37.5	21.0	19.5	86.5	11.0	P87	10
LCMA240-12-X	240	—	M12	20.8	37.5	21.0	19.5	86.5	14.0	P87	10
LCMA240-16-X	240	—	M16	20.8	37.5	21.0	19.5	86.5	18.0	P87	10
LCMA240-20-X	240	—	M20	20.8	37.5	21.0	19.5	86.5	22.0	P87	10
LCMA300-10-5	300	—	M10	23.5	42.5	22.0	20.0	94.5	11.0	P94	5
LCMA300-12-5	300	—	M12	23.5	42.5	22.0	20.0	94.5	14.0	P94	5
LCMA300-16-5	300	—	M16	23.5	42.5	22.0	20.0	94.5	18.0	P94	5
LCMA300-20-5	300	—	M20	23.5	42.5	22.0	20.0	94.5	22.0	P94	5
LCMA400-12-5	400	—	M12	27.0	49.5	26.5	23.5	107.0	14.0	P106	5
LCMA400-16-5	400	—	M16	27.0	49.5	26.5	23.5	107.0	18.0	P106	5
LCMA400-20-5	400	—	M20	27.0	49.5	26.5	23.5	107.0	22.0	P106	5
LCMA500-12-1	500	—	M12	31.0	57.5	28.5	25.5	120.0	14.0	P125	1
LCMA500-16-1	500	—	M16	31.0	57.5	28.5	25.5	120.0	18.0	P125	1
LCMA500-20-1	500	—	M20	31.0	57.5	28.5	25.5	120.0	22.0	P125	1
LCMA500-00-1*	500	—	Blank	31.0	57.5	—	—	120.0	—	P125	1
LCMA630-16-1	630	—	M16	34.5	63.0	28.5	27.5	131.0	18.0	P125	1
LCMA630-20-1	630	—	M20	34.5	63.0	28.5	27.5	131.0	22.0	P125	1
LCMA630-00-1*	630	—	Blank	34.5	63.0	—	—	131.0	—	P125	1

‡See page D3.83 for tool and die information.

\*UL Recognized only.

\*\*Consult cable manufacturer for voltage stress relief instructions with applications greater than 2000 V.



## Metric Conductor, Two-Hole, Standard Barrel with Window Lug

For Use with Class 2 Stranded Copper Conductors

### Type LCMD

- Inspection window to visually assure full conductor insertion
- Tin-plated to inhibit corrosion
- UL Listed, UL Recognized, and CSA Certified to 35 KV\*\* and temperature rated to 90°C when crimped with Panduit tools and dies
- Product information marked on connector for selection and installation
- Internally beveled wire entry for fast and easy installation

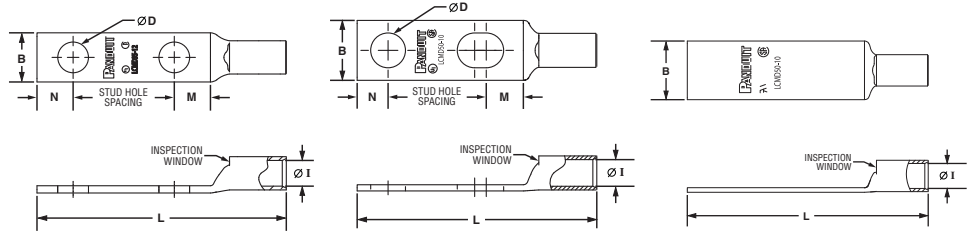

Part Number	Copper Conductor Size Class 2R (mm <sup>2</sup> )	Current Rating (Amps)	Stud Hole Size (mm)	Stud Hole Spacing (mm)	Figure Dimensions (mm)						Panduit Die Index No.‡	Std. Pkg. Qty.
					ØI	B	M	N	L	ØD		
LCMD6-5CD-Q*	4 – 6	30	M5	22.0 – 25.0	3.8	10.0	7.8	6.2	52.5	5.5	P10	25
LCMD10-6CD-Q	10	—	M6	22.0 – 25.0	4.5	11.0	9.8	6.0	55.8	6.6	P21	25
LCMD10-8-Q	10	—	M8	44.5	4.5	13.0	8.5	8.0	75.3	9.0	P21	25
LCMD10-00-Q*	10	—	Blank	—	4.4	14.5	—	—	75.3	—	P21	25
LCMD16-6CD-Q*	16	65	M6	22.0 – 25.0	5.5	13.0	10.3	6.5	59.5	6.6	P24	25
LCMD16-8-Q*	16	65	M8	44.5	5.5	13.0	10.3	6.5	79.0	9.0	P24	25
LCMD16-00-Q*	16	65	Blank	—	5.5	15.0	—	—	81.2	—	P24	25
LCMD25-8CD-Q*	25	—	M8	22.0 – 25.0	6.9	15.5	10.0	8.0	62.0	9.0	P29	25
LCMD25-8-Q	25	—	M8	44.5	6.9	15.5	10.0	8.0	81.5	9.0	P29	25
LCMD25-10-Q	25	—	M10	44.5	6.9	15.5	10.0	8.0	81.5	11.0	P29	25
LCMD25-12-Q	25	—	M12	44.5	7.1	20.0	14.5	11.5	89.5	14.0	P29	25
LCMD25-00-Q*	25	—	Blank	—	7.1	20.0	—	—	89.5	—	P29	25
LCMD35-8CD-Q	35	—	M8	22.0 – 25.0	8.2	15.5	12.3	8.5	67.0	9.0	P29	25
LCMD35-10-Q	35	—	M10	44.5	8.2	15.5	12.3	8.5	86.5	11.0	P29	25
LCMD35-12-Q	35	—	M12	44.5	8.2	21.5	14.5	11.5	92.5	14.0	P29	25
LCMD35-00-Q*	35	—	Blank	—	8.2	21.5	—	—	92.5	—	P29	25
LCMD50-10CD-X	50	—	M10	22.0 – 25.0	9.8	18.0	11.5	10.0	71.5	11.0	P37	10
LCMD50-10-X	50	—	M10	44.5	9.8	18.0	11.5	10.0	91.0	11.0	P37	10
LCMD50-12-X	50	—	M12	44.5	9.8	23.0	14.0	11.0	94.5	14.0	P37	10
LCMD50-00-X*	50	—	Blank	—	9.8	23.0	—	—	94.5	—	P37	10
LCMD70-10CD-X	70	—	M10	22.0 – 25.0	11.5	20.5	14.5	11.0	78.5	11.0	P45	10
LCMD70-10-X	70	—	M10	44.5	11.5	20.8	14.5	11.5	98.0	11.0	P45	10
LCMD70-12-X	70	—	M12	44.5	11.5	20.8	14.5	11.5	98.0	14.0	P45	10
LCMD70-00-X*	70	—	Blank	—	11.5	20.8	—	—	98.0	—	P45	10
LCMD95-10CD-X	95	—	M10	22.0 – 25.0	13.5	24.5	15.0	13.0	85.5	11.0	P54	10
LCMD95-12-X	95	—	M12	44.5	13.5	24.5	15.0	13.5	105.0	14.0	P54	10
LCMD95-14-X	95	—	M14	44.5	13.5	24.5	15.0	13.5	105.0	16.0	P54	10
LCMD95-00-X*	95	—	Blank	—	13.5	24.5	—	—	105.0	—	P54	10

‡See page D3.83 for tool and die information.

\*UL Recognized only.

\*\*Consult cable manufacturer for voltage stress relief instructions with applications greater than 2000 V.

Table continues on page D2.110

A. System Overview

B1. Cable Ties

B2. Cable Accessories

B3. Stainless Steel Ties

C1. Wiring Duct

C2. Surface Raceway

C3. Abrasion Protection

C4. Cable Management

D1. Terminals

D2. Power Connectors

D3. Grounding Connectors

E1. Labeling Systems

E2. Labels

E3. Pre-Printed & Write-On Markers

E4. Permanent Identification

E5. Lockout/Tagout & Safety Solutions

F. Index

A.  
System  
Overview



## Metric Conductor, Two-Hole, Standard Barrel with Window Lug (continued)

B1.  
Cable Ties

B2.  
Cable  
Accessories

B3.  
Stainless  
Steel Ties

C1.  
Wiring  
Duct

C2.  
Surface  
Raceway

C3.  
Abrasion  
Protection

C4.  
Cable  
Management

D1.  
Terminals

D2.  
Power  
Connectors

D3.  
Grounding  
Connectors

E1.  
Labeling  
Systems

E2.  
Labels

E3.  
Pre-Printed  
& Write-On  
Markers

E4.  
Permanent  
Identification

E5.  
Lockout/  
Tagout  
& Safety  
Solutions

F.  
Index

Part Number	Copper Conductor Size Class 2R (mm <sup>2</sup> )	Current Rating (Amps)	Stud Hole Size (mm)	Stud Hole Spacing (mm)	Figure Dimensions (mm)						Panduit Die Index No.‡	Std. Pkg. Qty.
					ØI	B	M	N	L	ØD		
<b>LCMD120-10CD-X</b>	120	—	M10	22.0 – 25.0	15.2	27.5	15.5	14.0	90.0	11.0	P62	10
<b>LCMD120-12-X</b>	120	—	M12	44.5	15.2	27.5	15.5	14.5	109.5	14.0	P62	10
<b>LCMD120-14-X</b>	120	—	M14	44.5	15.2	27.5	15.5	14.5	109.5	16.0	P62	10
<b>LCMD120-00-X*</b>	120	—	Blank	—	15.2	27.5	—	—	109.5	—	P62	10
<b>LCMD150-10CD-X</b>	150	—	M10	22.0 – 25.0	16.5	30.5	18.0	16.0	95.5	11.0	P66	10
<b>LCMD150-12-X</b>	150	—	M12	44.5	16.5	30.5	18.0	16.5	115.0	14.0	P66	10
<b>LCMD150-14-X</b>	150	—	M14	44.5	16.5	30.5	22.0	16.5	118.5	16.0	P66	10
<b>LCMD150-00-X*</b>	150	—	Blank	—	16.5	30.5	—	—	118.5	—	P66	10
<b>LCMD185-10CD-X</b>	185	—	M10	22.0 – 25.0	18.6	33.5	16.5	17.0	97.5	11.0	P76	10
<b>LCMD185-12-X</b>	185	—	M12	44.5	18.6	33.5	16.5	17.5	117.0	14.0	P76	10
<b>LCMD185-14-X</b>	185	—	M14	44.5	18.6	33.5	21.0	17.5	121.5	16.0	P76	10
<b>LCMD185-00-X*</b>	185	—	Blank	—	18.6	33.5	—	—	121.5	—	P76	10
<b>LCMD240-10CD-5</b>	240	—	M10	22.0 – 25.0	20.8	37.5	21.0	19.0	111.5	11.0	P87	5
<b>LCMD240-12-5</b>	240	—	M12	44.5	20.8	37.5	21.0	19.5	131.0	14.0	P87	5
<b>LCMD240-14-5</b>	240	—	M14	44.5	20.8	37.5	21.0	19.5	131.0	16.0	P87	5
<b>LCMD240-00-5*</b>	240	—	Blank	—	20.8	37.5	—	—	131.0	—	P87	5
<b>LCMD300-12-5</b>	300	—	M12	44.5	23.5	42.5	22.0	20.0	139.0	14.0	P94	5
<b>LCMD300-14-5</b>	300	—	M14	44.5	23.5	42.5	22.0	20.0	139.0	16.0	P94	5
<b>LCMD300-00-5*</b>	300	—	Blank	—	23.5	42.5	—	—	139.0	—	P94	5
<b>LCMD400-12-5</b>	400	—	M12	44.5	27.0	49.5	26.5	23.5	151.5	14.0	P106	5
<b>LCMD400-14-5</b>	400	—	M14	44.5	27.0	49.5	26.5	23.5	151.5	16.0	P106	5
<b>LCMD400-16-5</b>	400	—	M16	44.5	27.0	49.5	26.5	23.5	151.5	18.0	P106	5
<b>LCMD400-00-5*</b>	400	—	Blank	—	27.0	49.5	—	—	151.5	—	P106	5
<b>LCMD500-12-1</b>	500	—	M12	44.5	31.0	57.5	28.5	25.5	164.5	14.0	P125	1
<b>LCMD500-14-1</b>	500	—	M14	44.5	31.0	57.5	28.5	25.5	164.5	16.0	P125	1
<b>LCMD500-16-1</b>	500	—	M16	44.5	31.0	57.5	28.5	25.5	164.5	18.0	P125	1
<b>LCMD500-00-1*</b>	500	—	Blank	—	31.0	57.5	—	—	164.5	—	P125	1
<b>LCMD630-12-1</b>	630	—	M12	44.5	34.5	63.0	28.5	27.5	175.5	14.0	P125	1
<b>LCMD630-14-1</b>	630	—	M14	44.5	34.5	63.0	28.5	27.5	175.5	16.0	P125	1
<b>LCMD630-16-1</b>	630	—	M16	44.5	34.5	63.0	28.5	27.5	175.5	18.0	P125	1
<b>LCMD630-00-1*</b>	630	—	Blank	—	34.5	63.0	—	—	175.5	—	P125	1

‡See page D3.83 for tool and die information.

\*UL Recognized only.

\*\*Consult cable manufacturer for voltage stress relief instructions with applications greater than 2000 V.



## Metric Conductor, Standard Barrel, Butt Splice

For Use with Class 2 Stranded Copper Conductors

### Type SCMS

- Tin-plated to inhibit corrosion
- UL Listed, UL Recognized, and CSA Certified to 35 KV\*\* and temperature rated to 90°C when crimped with Panduit tools and dies
- Product information marked on connector for selection and installation
- Internally beveled wire entry for fast and easy installation



Part Number	Copper Conductor Size Class 2R (mm <sup>2</sup> )	Current Rating (Amps)	Figure Dimensions (mm)		Panduit Die Index No. ‡	Std. Pkg. Qty.
			ØI	L		
SCMS10-C*	10	50	4.5	30.0	P21	100
SCMS16-C*	16	65	5.5	35.0	P24	100
SCMS25-L	25	—	6.9	36.0	P29	50
SCMS35-L	35	—	8.2	36.0	P29	50
SCMS50-L	50	—	9.8	49.0	P37	50
SCMS70-L	70	—	11.5	52.0	P45	50
SCMS95-Q	95	—	13.5	54.0	P54	25
SCMS120-Q	120	—	15.2	57.0	P62	25
SCMS150-X	150	—	16.5	57.0	P66	10
SCMS185-X	185	—	18.6	61.0	P76	10
SCMS240-X	240	—	20.8	72.0	P87	10
SCMS300-5	300	—	23.5	75.0	P94	5
SCMS400-5	400	—	27.0	95.0	P106	5
SCMS500-6	500	—	31.0	96.0	P125	6
SCMS630-6	630	—	34.5	131.0	P125	6

‡See page D3.83 for tool and die information.

\*UL Recognized only.

\*\*Consult cable manufacturer for voltage stress relief instructions with applications greater than 2000 V.

A. System Overview

B1. Cable Ties

B2. Cable Accessories

B3. Stainless Steel Ties

C1. Wiring Duct

C2. Surface Raceway

C3. Abrasion Protection

C4. Cable Management

D1. Terminals

D2. Power Connectors

D3. Grounding Connectors

E1. Labeling Systems

E2. Labels

E3. Pre-Printed & Write-On Markers

E4. Permanent Identification

E5. Lockout/Tagout & Safety Solutions

F. Index

A. System Overview



## Code Conductor, One-Hole, Aluminum Lug

B1. Cable Ties

**For Use with Stranded Aluminum or Copper Code Conductors**

### Type LAA

B2. Cable Accessories

- Manufactured from high conductivity thick wall wrought aluminum
- Factory pre-filled with joint compound and sealed with easy pull-out end plug to inhibit corrosion
- Color-coded end plug and Panduit and specified competitor die index numbers marked on barrel for proper crimp die selection

- Enclosed barrel prevents corrosive material from entering barrel when used in harsh environments
- Tin-plated to inhibit corrosion
- UL Listed and CSA Certified to 35 KV\*\* and temperature rated to 90°C when crimped with Panduit and specified competitor crimping tools and dies

B3. Stainless Steel Ties

C1. Wiring Duct

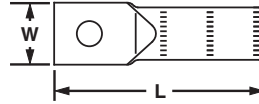

C2. Surface Raceway

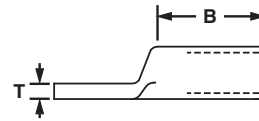

C3. Abrasion Protection

C4. Cable Management

Part Number	Aluminum or Copper Conductor Size	Stud Hole Size (In.)	Figure Dimensions (In.)				Panduit Color Code	Panduit Die Index No.‡	Burndy Die Index No.‡	T&B Die Index No.‡	Wire Strip Length (In.)	Std. Pkg. Qty.
			W	B	T	L						
LAA6-14-X	#6 AWG	1/4	0.55	0.86	0.11	2.20	Gray	P29	346	29	1	10
LAA6-56-X		5/16	0.55	1.00	0.11	2.20	Gray	P29	346	29	1	10
LAA4-14-X	#4 AWG	1/4	0.66	1.05	0.19	2.05	Green	P37	375	37	1 1/16	10
LAA4-56-X		5/16	0.69	1.08	0.16	2.23	Green	P37	375	37	1 1/16	10
LAA4-38-X	#2 AWG	3/8	0.69	0.92	0.16	2.33	Green	P37	375	37	1 1/16	10
LAA2-14-X		1/4	0.75	0.98	0.17	2.63	Pink	P42	348	42	1	10
LAA2-56-X	#2 AWG	5/16	0.75	0.98	0.17	2.63	Pink	P42	348	42	1	10
LAA2-38-X		3/8	0.75	0.98	0.17	2.63	Pink	P42	348	42	1	10
LAA1-14-X	#1 AWG	1/4	0.75	0.98	0.17	2.63	Gold	P45	471	45	1	10
LAA1-56-X		5/16	0.75	0.98	0.17	2.63	Gold	P45	471	45	1	10
LAA1-38-X	1/0 AWG	3/8	0.75	0.98	0.17	2.63	Gold	P45	471	45	1	10
LAA1/0-56-X		5/16	0.88	1.30	0.25	3.23	Tan	P50	296	50	1 9/16	10
LAA1/0-38-X	1/0 AWG	3/8	0.88	1.30	0.25	3.23	Tan	P50	296	50	1 9/16	10
LAA1/0-12-X		1/2	0.88	1.30	0.25	3.23	Tan	P50	296	50	1 9/16	10
LAA2/0-38-5	2/0 AWG	3/8	0.95	1.31	0.23	3.19	Olive	P54	297	54	1 9/16	5
LAA2/0-12-5		1/2	0.95	1.30	0.23	3.19	Olive	P54	297	54	1 9/16	5
LAA3/0-38-5	3/0 AWG	3/8	1.07	1.50	0.25	3.44	Ruby	P60	467	60	1 9/16	5
LAA3/0-12-5		1/2	1.07	1.50	0.25	3.44	Ruby	P60	467	60	1 9/16	5
LAA4/0-38-5	4/0 AWG	3/8	1.19	1.44	0.32	3.56	White	P66	298	66	1 3/4	5
LAA4/0-12-5		1/2	1.19	1.44	0.32	3.56	White	P66	298	66	1 3/4	5
LAA250-38-5	250 kcmil	3/8	1.24	1.56	0.30	3.63	Red	P71	324	71	1 9/16	5
LAA250-12-5		1/2	1.24	1.56	0.30	3.63	Red	P71	324	71	1 9/16	5
LAA300-38-2	300 kcmil	3/8	1.38	2.25	0.34	4.05	Blue	P76	470	76	2 5/16	2
LAA300-12-2		1/2	1.38	2.25	0.34	4.05	Blue	P76	470	76	2 5/16	2
LAA350-12-2	350 kcmil	1/2	1.50	2.25	0.38	4.30	Brown	P87	299	87	2 5/16	2
LAA400-58-2	400 kcmil	5/8	1.61	2.50	0.41	4.92	Green	P94	472	94	2 9/16	2
LAA500-12-2	500 kcmil	1/2	1.75	3.00	0.44	5.56	Pink	P99	300	99	3 1/16	2
LAA500-58-2		5/8	1.75	3.00	0.44	5.56	Pink	P99	300	99	3 1/16	2
LAA750-58-1	750 kcmil	5/8	1.75	3.38	0.53	6.55	Red	P125	301	115	3 7/16	1
LAA1000-58-1	1000 kcmil	5/8	2.56	4.50	0.61	7.38	Brown	P161	302	161	4 3/4	1

‡See pages D3.84, D3.85 for tool and die information.

\*\*Consult cable manufacturer for voltage stress relief instructions with applications greater than 2000 V.

See page D2.118 for Panduit joint compounds recommended for pad to pad and conductor connections.



## Code Conductor, Two-Hole, Aluminum Lug

For Use with Stranded Aluminum or Copper Code Conductors

### Type LAB

- Manufactured from high conductivity thick wall wrought aluminum
- Factory pre-filled with joint compound and sealed with easy pull-out end plug to inhibit corrosion
- Color-coded end plug and Panduit and specified competitor die index numbers marked on barrel for proper crimp die selection
- Enclosed barrel prevents corrosive material from entering barrel when used in harsh environments
- Tin-plated to inhibit corrosion
- UL Listed and CSA Certified to 35 KV\*\* and temperature rated to 90°C when crimped with Panduit and specified competitor crimping tools and dies
- Available with NEMA hole sizes and spacing

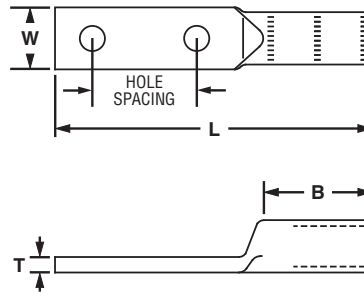

Part Number	Aluminum or Copper Conductor Size	Stud Hole Size (In.)	Stud Hole Spacing (In.)	Figure Dimensions (In.)				Panduit Color Code	Panduit Die Index No.‡	Burdny Die Index No.‡	T&B Die Index No.‡	Wire Strip Length (In.)	Std. Pkg. Qty.
				W	B	T	L						
◆ LAB1/0-38-X	1/0 AWG	3/8	1.75	0.88	1.55	0.25	5.33	Tan	P50	296	50	1 9/16	10
◆ LAB2/0-12-5	2/0 AWG	1/2	1.75	0.94	1.55	0.25	5.55	Olive	P54	297	54	1 9/16	5
◆ LAB3/0-12-5	3/0 AWG	1/2	1.75	1.03	1.55	0.27	5.55	Ruby	P60	467	60	1 9/16	5
◆ LAB4/0-12-5	4/0 AWG	1/2	1.75	1.19	1.80	0.31	5.98	White	P66	298	66	1 3/4	5
◆ LAB250-12-5	250 kcmil	1/2	1.75	1.25	1.80	0.31	6.05	Red	P71	324	71	1 3/4	5
◆ LAB300-12-2	300 kcmil	1/2	1.75	1.36	2.30	0.34	6.61	Blue	P76	470	76	2 5/16	2
◆ LAB350-12-2	350 kcmil	1/2	1.75	1.50	2.30	0.38	6.61	Brown	P87	299	87	2 5/16	2
◆ LAB400-12-2	400 kcmil	1/2	1.75	1.66	2.55	0.38	6.92	Green	P94	472	94	2 9/16	2
◆ LAB500-12-2	500 kcmil	1/2	1.75	1.72	3.05	0.44	7.36	Pink	P99	300	99	3 1/16	2
◆ LAB600-12-2	600 kcmil	1/2	1.75	1.72	3.05	0.50	7.55	Black	P106	473	106	3 1/16	2
◆ LAB750-12-1	750 kcmil	1/2	1.75	1.72	3.42	0.56	7.31	Red	P125	301	115	3 7/16	1
◆ LAB800-12-1	800 kcmil	1/2	1.75	1.72	3.42	0.59	8.30	Gray	P140	474	125	3 7/16	1
◆ LAB1000-12-1	1000 kcmil	1/2	1.75	2.56	4.67	0.63	9.67	Brown	P161	302	161	4 3/4	1

‡See pages D3.84, D3.85 for tool and die information.

\*\*Consult cable manufacturer for voltage stress relief instructions with applications greater than 2000 V.

See page D2.118 for Panduit joint compounds recommended for pad to pad and conductor connections.

◆NEMA hole sizes and spacing.

A. System Overview

B1. Cable Ties

B2. Cable Accessories

B3. Stainless Steel Ties

C1. Wiring Duct

C2. Surface Raceway

C3. Abrasion Protection

C4. Cable Management

D1. Terminals

D2. Power Connectors

D3. Grounding Connectors

E1. Labeling Systems

E2. Labels

E3. Pre-Printed & Write-On Markers

E4. Permanent Identification

E5. Lockout/Tagout & Safety Solutions

F. Index

A.  
System  
Overview

## Belleville Compression Washers

B1.  
Cable Ties

### Type CW

- Conical spring washer for use when assembling aluminum connectors to copper and/or steel pads, compensates for differing rates of thermal expansion to keep hardware assembly from loosening

- For assembly information, see page D2.158
- Made from hardened steel to provide high strength
- Cadmium-plated to inhibit corrosion

B2.  
Cable  
Accessories



B3.  
Stainless  
Steel Ties

C1.  
Wiring  
Duct

Part Number	Stud Hole Size (In.)	Figure Dimensions (In.)			Std. Pkg. Qty.
		D	H	T	
CW-14-L	1/4	.68	.09	.05	50
CW-56-L	5/16	.81	.08	.06	50
CW-38-L	3/8	.93	.10	.07	50
CW-12-Q	1/2	1.18	.12	.09	25
CW-58-Q	5/8	1.49	.15	.12	25

C2.  
Surface  
Raceway

C3.  
Abrasion  
Protection

C4.  
Cable  
Management

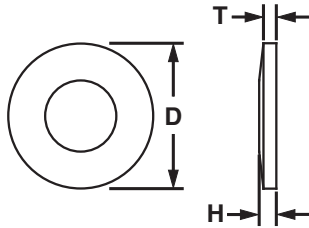

D1.  
Terminals

D2.  
Power  
Connectors

D3.  
Grounding  
Connectors

E1.  
Labeling  
Systems

E2.  
Labels

E3.  
Pre-Printed  
& Write-On  
Markers

E4.  
Permanent  
Identification

E5.  
Lockout/  
Tagout  
& Safety  
Solutions

F.  
Index





## Code Conductor, Aluminum Splice

For Use with Stranded Aluminum-to-Aluminum or Copper-to-Copper Conductors

### Type SA

- Manufactured from high conductivity thick wall wrought aluminum
- Factory pre-filled with joint compound and sealed with easy pull-out end plug to inhibit corrosion
- Color-coded end plugs and Panduit and specified competitor die index numbers marked on barrel for proper crimp die selection
- Tin-plated to inhibit corrosion
- Internal solid center prevents over-insertion of conductor
- UL Listed and CSA Certified to 35 KV\*\* and temperature rated to 90°C when crimped with Panduit and specified competitor crimping tools and dies

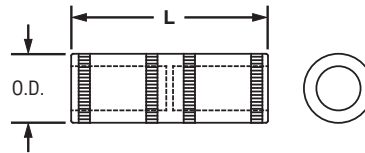

Part Number	Aluminum or Copper Conductor Size	Figure Dimensions (In.)		Panduit Color Code	Panduit Die Index No.‡	Burdny Die Index No.‡	T&B Die Index No.‡	Wire Strip Length (In.)	Std. Pkg. Qty.
		Barrel O.D.	L						
SA6-X	#6 AWG	0.34	1.62	Gray	P29	346	29	3/4	10
SA4-X	#4 AWG	0.48	2.13	Green	P37	375	37	7/8	10
SA2-X	#2 AWG	0.53	2.00	Pink	P42	348	45	7/16	10
SA1-X	#1 AWG	0.53	2.00	Gold	P45	471	45	7/16	10
SA1/0-X	1/0 AWG	0.64	2.12	Tan	P50	296	50	1	10
SA2/0-5	2/0 AWG	0.69	2.31	Olive	P54	297	54	1 1/8	5
SA3/0-5	3/0 AWG	0.76	2.62	Ruby	P60	467	60	1 1/4	5
SA4/0-5	4/0 AWG	0.88	2.75	White	P66	298	66	1 5/16	5
SA250-5	250 kcmil	0.91	2.94	Red	P71	324	71	1 7/16	5
SA300-2	300 kcmil	1.01	3.12	Blue	P76	470	76	1 1/2	2
SA350-2	350 kcmil	1.12	3.37	Brown	P87	299	87	1 5/8	2
SA400-2	400 kcmil	1.19	3.75	Green	P94	472	94	1 13/16	2
SA500-2	500 kcmil	1.32	3.87	Pink	P99	300	99	1 7/8	2
SA600-2	600 kcmil	1.44	4.12	Black	P106	473	106	2	2
SA750-1	750 kcmil	1.60	4.62	Red	P125	301	115	2 1/4	1
SA800-1	800 kcmil	1.66	4.75	Gray	P140	474	125	2 5/16	1
SA1000-1	1000 kcmil	1.84	5.25	Brown	P161	302	161	2 9/16	1

‡See pages D3.84, D3.85 for tool and die information.

\*\*Consult cable manufacturer for voltage stress relief instructions with applications greater than 2000 V.

See page D2.118 for Panduit joint compounds recommended for pad to pad and conductor connections.

A. System Overview

B1. Cable Ties

B2. Cable Accessories

B3. Stainless Steel Ties

C1. Wiring Duct

C2. Surface Raceway

C3. Abrasion Protection

C4. Cable Management

D1. Terminals

D2. Power Connectors

D3. Grounding Connectors

E1. Labeling Systems

E2. Labels

E3. Pre-Printed & Write-On Markers

E4. Permanent Identification

E5. Lockout/Tagout & Safety Solutions

F. Index

A. System Overview

## Code Conductor, Aluminum, Reducing Splice

B1. Cable Ties

### For Reducing Stranded Aluminum-to-Aluminum or Aluminum-to-Copper Conductors

B2. Cable Accessories

#### Type SAR

- Dual rated for use with aluminum or copper conductors
- Factory pre-filled with joint compound and sealed with easy pull-out end plug to inhibit corrosion
- Color-coded end plug and Panduit and specified competitor die index numbers marked on barrel for proper crimp die selection
- Tin-plated to inhibit corrosion
- For use up to 35 KV\*\* and temperature rated 90°C when crimped with Panduit and specified competitor crimping tools and dies

B3. Stainless Steel Ties



C1. Wiring Duct

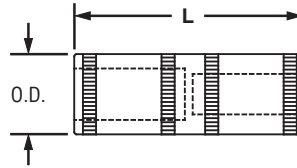

C2. Surface Raceway

C3. Abrasion Protection

Part Number	Aluminum Conductor Size From	Aluminum or Copper Conductor Size To	Figure Dimensions (In.)		Panduit Color Code	Panduit Die Index No.‡	Burdny Die Index No.‡	T&B Die Index No.‡	Wire Strip Length (In.)	Std. Pkg. Qty.
			Barrel O.D.	L						
<b>SAR2-4-X</b>	#2 AWG	#4 AWG	0.64	4.25	Tan	P50	296	50	2 1/16	10
<b>SAR1/0-2-X</b>	1/0 AWG	#2 AWG	0.64	4.25	Tan	P50	296	50	2 1/16	10
<b>SAR3/0-1/0-5</b>	3/0 AWG	1/0 AWG	0.91	4.98	Red	P71	324	71	2 5/16	5
<b>SAR4/0-2/0-5</b>	4/0 AWG	2/0 AWG	0.91	5.24	Red	P71	324	71	2 3/16	5
<b>SAR350-4/0-2</b>	350 kcmil	4/0 AWG	1.12	6.63	Brown	P87	299	87	3 3/16	2
<b>SAR500-350-2</b>	500 kcmil	350 kcmil	1.32	8.60	Pink	P99	300	99	4 1/4	2
<b>SAR600-500-2</b>	600 kcmil	500 kcmil	1.49	9.25	Black	P106	473	106	4	2
<b>SAR750-600-2</b>	750 kcmil	600 kcmil	1.60	9.88	Red	P125	301	115	4 7/16	2

C4. Cable Management

D1. Terminals

‡See pages D3.86 – D3.87 for tool and die information.

D2. Power Connectors

\*\*Consult cable manufacturer for voltage stress relief instructions with applications greater than 2000 V.

See pages D2.118 for Panduit joint compounds recommended for pad to pad and conductor connections.

D3. Grounding Connectors

E1. Labeling Systems

E2. Labels

E3. Pre-Printed & Write-On Markers

E4. Permanent Identification

E5. Lockout/Tagout & Safety Solutions

F. Index

## Code Conductor, Aluminum, Bi-Metallic Pin Connector

**Provides Copper Pigtail for Connecting Aluminum Conductors to a Copper or Aluminum/Copper Rated Mechanical Lug**

### Type BPC

- Factory pre-filled with joint compound and sealed with easy pull-out end plug to inhibit corrosion
- Panduit die index number and color code embossed on barrel for proper crimp die selection
- Insulating rubber sleeve included to insulate aluminum barrel from contact with copper connector when attached to pin
- Tin-plated to inhibit corrosion
- UL Listed per UL 486B; temperature rated 90°C and for use up to 600 V when crimped with Panduit and specified competitor crimping tools and dies

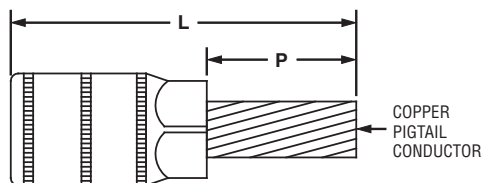

Part Number	Aluminum Conductor Size	Copper Pigtail Size	Figure Dimensions (In.)		Panduit Color Code	Panduit Die Index No.‡	Burdny Die Index No.‡	T&B Die Index No.‡	Wire Strip Length (In.)	Std. Pkg. Qty.
			L	P						
BPC6-L	#6 AWG	#8 AWG	2.45	0.88	Tan	P50	296	50	1 1/16	50
BPC4-L	#4 AWG	#6 AWG	2.45	0.88	Tan	P50	296	50	1 1/16	50
BPC2-L	#2 AWG	#4 AWG	2.45	0.88	Tan	P50	296	50	1 1/16	50
BPC1-X	#1 AWG	#3 AWG	2.58	1.00	Tan	P50	296	50	1 1/16	10
BPC1/0-X	1/0 AWG	#2 AWG	3.33	1.25	Red	P71	298	76	1 5/16	10
BPC2/0-X	2/0 AWG	#1 AWG	3.33	1.25	Red	P71	298	76	1 5/16	10
BPC3/0-X	3/0 AWG	1/0 AWG	3.46	1.38	Red	P71	298	76	1 5/16	10
BPC4/0-X	4/0 AWG	2/0 AWG	3.46	1.38	Red	P71	298	76	1 5/16	10
BPC250-X	250 kcmil	3/0 AWG	3.71	1.50	Green	P94	299	99, 87	1 7/16	10
BPC300-X	300 kcmil	4/0 AWG	4.10	1.63	Green	P94	299	99, 87	1 7/16	10
BPC350-X	350 kcmil	4/0 AWG	4.10	1.63	Green	P94	299	99, 87	1 7/16	10
BPC400-X	400 kcmil	250 kcmil	4.35	1.88	Black	P106	300	106	1 7/16	10
BPC500-X	500 kcmil	350 kcmil	4.35	1.88	Black	P106	300	106	1 7/16	10
BPC600-6	600 kcmil	350 kcmil	4.77	1.88	Red	P125	936	115	1 15/16	6
BPC750-6	750 kcmil	500 kcmil	4.90	2.00	Red	P125	936	115	1 15/16	6

‡See pages D3.88 – D3.89 for tool and die information.

See pages D2.118 for Panduit joint compounds recommended for pad to pad and conductor connections.

A. System Overview

B1. Cable Ties

B2. Cable Accessories

B3. Stainless Steel Ties

C1. Wiring Duct

C2. Surface Raceway

C3. Abrasion Protection

C4. Cable Management

D1. Terminals

D2. Power Connectors

D3. Grounding Connectors

E1. Labeling Systems

E2. Labels

E3. Pre-Printed & Write-On Markers

E4. Permanent Identification

E5. Lockout/Tagout & Safety Solutions

F. Index

A.  
System  
Overview

## Joint Compounds

B1.  
Cable Ties

### For Use with Aluminum Connectors

B2.  
Cable  
Accessories

#### Type CMP

- Oxide inhibitor for compression conductor connections lowers electrical resistance of compression joint while sealing out air and moisture to prevent the formation of surface oxides

- Wide operating temperature range; can be used in a wide range of electrical and environmental conditions
- Packaged in convenient dispenser bottles

B3.  
Stainless  
Steel Ties



C1.  
Wiring  
Duct

C2.  
Surface  
Raceway

C3.  
Abrasion  
Protection

C4.  
Cable  
Management

D1.  
Terminals

D2.  
Power  
Connectors

D3.  
Grounding  
Connectors

E1.  
Labeling  
Systems

E2.  
Labels

E3.  
Pre-Printed  
& Write-On  
Markers

E4.  
Permanent  
Identification

E5.  
Lockout/  
Tagout  
& Safety  
Solutions

F.  
Index

Part Number	Part Description	Std. Pkg. Qty.
<b>CMP-100-1</b>	Contact aid for pad-to-pad or thread-to-thread aluminum connections, 8 oz. Operating temperature range -60°F (-51°C) to 400°F (204°C).	1
<b>CMP-200-1</b>	Contact aid for cable connections with compression connections made on aluminum conductor, 8 oz. Operating temperature range -40°F (-40°C) to 400°F (204°C). Compatible with all insulating materials.	1

## PAN-LUG™ MECHANICAL CONNECTORS

Panduit offers a broad variety of mechanical lugs, splices, and split bolt connectors suitable for a wide range of electrical terminations using code conductor. Designed to be reusable and installed without special tooling, Pan-Lug™ Mechanical Connectors provide quality performance, ease of installation, and lowest installed cost.



- Functional product information is marked directly on the connector, facilitating the identification, ordering, and usage of the mechanical connector
- Incorporate wide wire range-taking capability to minimize inventory requirements
- Made from high strength, high conductivity electrolytic copper and aluminum alloy materials to provide optimum connectivity for power and grounding applications
- UL Listed and CSA Certified, as noted

Pan-Lug™ Mechanical Connectors include split bolt connectors, copper mechanical lugs, aluminum mechanical lugs and aluminum multi-tap connectors with clear PVC insulation. Products are available in stamped and formed, extruded and cast varieties of multiple barrel and tongue configurations to provide solutions for diverse power and grounding needs. Panduit offers a wide assortment of Pan-Lug™ Power and Grounding Connectors to meet customer needs and today's application requirements.

A.  
System  
Overview

B1.  
Cable Ties

B2.  
Cable  
Accessories

B3.  
Stainless  
Steel Ties

C1.  
Wiring  
Duct

C2.  
Surface  
Raceway

C3.  
Abrasion  
Protection

C4.  
Cable  
Management

D1.  
Terminals

D2.  
Power  
Connectors

D3.  
Grounding  
Connectors

E1.  
Labeling  
Systems

E2.  
Labels

E3.  
Pre-Printed  
& Write-On  
Markers

E4.  
Permanent  
Identification

E5.  
Lockout/  
Tagout  
& Safety  
Solutions

F.  
Index

A. System Overview

## Features and Benefits – Pan-Lug™ Mechanical Connectors

B1. Cable Ties

### Copper Split Bolt Connectors

Part number and conductor range marked on part for easy identification

Waxed body to prohibit binding of contact pad or nut

Extra-long body available to connect two taps with one run



Hex head with large wrench flats for easy assembly

250 kcmil and larger sizes have contact serrations for higher pull-out strength

Made from high strength copper alloy

### Cast Copper Connectors

Made from high strength copper alloy

Serrated barrel available for high pull-out strength

Flat bottom allows full contact surface mounting



Inspection windows to assure complete conductor insertion

Part number and conductor range marked on part for easy identification

C3. Abrasion Protection

### Stamped and Formed Copper Connectors

Made from high strength, electrolytic copper alloy

Part number and conductor range marked on part for easy identification

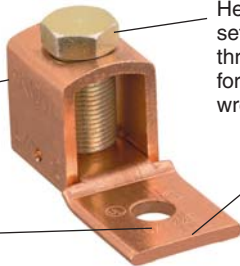

Hex head bolt (slotted set screw used up through 1/0 AWG sizes) for assembly with a wrench or screwdriver

Two styles of tongues available: fixed and floating

### Aluminum Connectors

Dual rated for aluminum or copper conductors

Made from high strength, extruded aluminum alloy

Part number and conductor range marked on part for easy identification

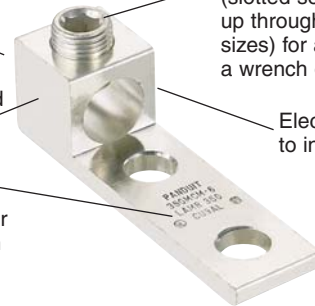

Hex socket set screw (slotted set screw used up through 2/0 AWG sizes) for assembly with a wrench or screwdriver

Electro tin-plated to inhibit corrosion

D1. Terminals

D2. Power Connectors

D3. Grounding Connectors

### Multi-Tap Connectors

Hex socket set screws (slotted set screw for smallest size) for assembly with a wrench or screwdriver

Pre-insulated aluminum body to eliminate the need for taping

Dual-sided conductor entry

Made from high strength, extruded aluminum alloy

Clear PVC insulation for visual inspection of the complete conductor insertion

Factory pre-filled with oxide inhibitor to prevent oxidation

Available with two isolated mounting holes at either end of connector to facilitate direct mounting using 1/4" bolts.



E5. Lockout/Tagout & Safety Solutions

F. Index



Panduit designs and manufactures a full line of labeling products, software, and printers to assist you with your labeling requirements. See pages E1.1 – E2.22.



Pan-Steel® Stainless Cable Ties provide a strong, durable method of bundling and fastening, in all indoor, outdoor, and underground applications. See pages B3.2 – B3.19.



Panduit provides a complete selection of nylon cable ties to bundle, mount, and identify in countless indoor, outdoor, and harsh environment applications. See pages B1.1 – B1.84.

## Selection Guide – Pan-Lug™ Mechanical Connectors, Cast Copper

1. Select Connector Type and Stud Hole Size Desired			2. Determine Conductor Size and then Select Panduit Part Number																												
UL LISTED ‡	Mechanical Connector Type	Stud Hole Size (In.)	Copper Code Conductor Size																												
			#14 AWG	#12 AWG	#10 AWG	#8 AWG	#6 AWG	#4 AWG	#2 AWG	#1 AWG	1/0 AWG	2/0 AWG	3/0 AWG	4/0 AWG	250 kcmil	300 kcmil	350 kcmil	500 kcmil	600 kcmil	750 kcmil	800 kcmil	1000 kcmil									
			Panduit Part Number																												
	One-Hole, Straight Tongue HL	1/4	HL1-25-X■*			HL4-1-X■*			HL8-1-X*			HL13-1-5			HL21-1-5			HL30-1-2			HL50-1-2										
		3/8																													
		1/2																													
	One-Hole, Straight Tongue HLB	1/4	HLB4-1-X■*																												
	One-Hole, Straight Tongue HLA-90	1/4	HLA4-1-90-X■*			HLA8-1-90-X*			HLA13-1-90-5			HLA21-1-90-5																			
		3/8																													
	Two-Hole, Straight Tongue HL-2	1/4	HL1-2-25-X■*			HL4-2-X■*			HL8-2-X*			HL13-2-5			HL21-2-5			HL30-2-2			HL50-2-2										
		5/16																													
		3/8																													
	Two-Hole, Straight Tongue HL-2N	1/2				HL8-2N-X◆*			HL13-2N-5◆			HL21-2N-5◆			HL30-2N-2◆																
		1/2																													
	Two-Hole, Straight Tongue H2L-2N	1/2				H2L4-2N-X◆■*			H2L8-2N-2◆*			H2L13-2N-2◆			H2L21-2N-2◆			H2L30-2N-1◆													
		1/2																													
	Two-Way Connector HC	—				HC4-3■*			HC8-3*			HC13-3			HC21-1			HC30-1			HC50-1										
		—																													
	Two-Hole, Straight Tongue HHL-2N	1/2				HHL8-2N-X◆*			HHL13-2N-5◆			HHL21-2N-5◆			HHL30-2N-1◆																
		1/2																													
	One-Hole, Straight Tongue PNL	1/4	PNL-4-C■*																												
		5/16				PNL-1/0-L*																									
		3/8							PNL-250-Q*																						
		1/2										PNL-500-3*																			
	One-Hole, Straight Tongue ML	3/16	ML8-CY■^*																												
		1/4	ML4-CY■^*																												
		5/16				ML1/0-LY^*																									
	Two-Hole, Straight Tongue PNL-2	5/16				PNL-1/0-2-L*			ML250-QY^*																						
		3/8							PNL-250-2-Q*																						
		1/2										PNL-500-2-3*																			
	Two-Way Connector PNL-C	—				PNLC-1/0-3*			PNLC-250-1*			PNLC-500-1*																			
		—																													

‡Type PNL is also CSA Certified, Type PNL-C is not UL Listed or CSA Certified. Type ML is cULus Listed.

◆NEMA hole sizes and spacing.





■Uses slotted set screw.

\*Denotes minimum conductor size is solid conductor.

^Also available tin-plated.

- A. System Overview
- B1. Cable Ties
- B2. Cable Accessories
- B3. Stainless Steel Ties
- C1. Wiring Duct
- C2. Surface Raceway
- C3. Abrasion Protection
- C4. Cable Management
- D1. Terminals
- D2. Power Connectors
- D3. Grounding Connectors
- E1. Labeling Systems
- E2. Labels
- E3. Pre-Printed & Write-On Markers
- E4. Permanent Identification
- E5. Lockout/Tagout & Safety Solutions
- F. Index







## Selection Guide – Pan-Lug™ Mechanical Connectors, Stamped and Formed

		1. Select Connector Type and Stud Hole Size Desired				2. Determine Conductor Size and then Select Panduit Part Number																	
UL LISTED	Mechanical Connector Type	Current Rating AMPS	Stud Hole Size (In.)	Copper Code Conductor Size																			
				#14 AWG	#12 AWG	#10 AWG	#8 AWG	#6 AWG	#4 AWG	#2 AWG	#1 AWG	1/0 AWG	2/0 AWG	3/0 AWG	4/0 AWG	250 kcmil	350 kcmil	400 kcmil	500 kcmil	600 kcmil	750 kcmil	800 kcmil	1000 kcmil
				Panduit Part Number																			
	One-Hole, Offset Tongue <b>CB</b>	25	1/8	CB25-18CY ■																			
		50	3/16	CB35-36-CY • ■																			
		70	1/4	CBA70-14-CY ■																			
		90		CB70-14-CY • ■																			
		125		CB125-14-QY ■																			
		175	3/8	CB175-38-QY																			
		225	5/16	CB225-56-QY																			
		300	3/8	CB300-38-QY																			
		400		CB400-38-3Y																			
<b>D2.139</b>		650	1/2																CB650-12-3Y				
	Two-Hole, Offset Tongue <b>CO</b>	50	3/16	CO35-36-QY • ■ <sup>(1)</sup>																			
		90	1/4	CO70-14-QY • ■ <sup>(1)</sup>																			
		125	5/16	CO125-14-QY ■ <sup>(1)</sup>																			
		225		CO225-56-QY <sup>(1)</sup>																			
		300	3/8	CO300-38-3Y <sup>(3)</sup>																			
		400		CO400-38-3Y <sup>(2)</sup>																			
<b>D2.140</b>		650	1/2																CO650-12-3Y ◆ <sup>(2)</sup>				
	One-Hole, Straight "Fixed" Tongue <b>CX</b>	35	3/16	CX35-36-CY ■ * ^																			
		70	1/4	CX70-14-CY • ■ * ^																			
		125	5/16	CX125-14-QY ■ ^																			
		225		CX225-56-QY^																			
<b>D2.136</b>																							
	One-Hole, Straight Tongue <b>CS</b>	25	1/8	CS25-18-CY ■																			
		50	3/16	CS35-36-CY • ■																			
		70	1/4	CSA70-14-CY ■																			
		90		CS70-14-CY • ■																			
		125		CS125-14-QY ■																			
		175	3/8	CS175-38-QY																			
		225	5/16	CS225-56-QY																			
		300	3/8	CS300-38-QY																			
		400		CS400-38-3Y																			
<b>D2.137</b>		650	1/2																CS650-12-3Y				
	Two-Hole, Straight Tongue <b>CD</b>	50	3/16	CD35-36-QY • ■ <sup>(1)</sup>																			
		90	1/4	CD70-14-QY • ■ <sup>(1)</sup>																			
		125	5/16	CD125-14-QY ■ <sup>(1)</sup>																			
		225		CD225-56-QY <sup>(1)</sup>																			
		300	3/8	CD300-38-3Y <sup>(1)</sup>																			
		400		CD400-38-3Y ◆ <sup>(2)</sup>																			
<b>D2.138</b>		650	1/2																CD650-12-3Y ◆ <sup>(2)</sup>				

\*Multiple conductor combinations.  
 \*UL Listed and CSA Certified.  
 ◆NEMA hole sizes and spacing.  
 ■Uses slotted set screw.  
 (1) 1.00" stud hole spacing.  
 (2) 1.75" stud hole spacing.  
 (3) 1.87" stud hole spacing.  
 ^Also available tin-plated.

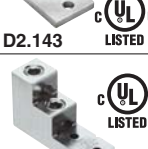

## Selection Guide – Pan-Lug™ Mechanical Connectors, Aluminum

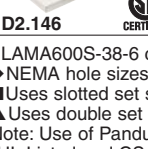
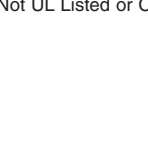
1. Select Connector Type and Stud Hole Size Desired				2. Determine Conductor Size and then Select Panduit Part Number																																	
Mechanical Connector Type	Stud Hole Size (In.)	Aluminum/Copper Code Conductor Size																																			
		#14 AWG	#12 AWG	#10 AWG	#8 AWG	#6 AWG	#4 AWG	#2 AWG	#1 AWG	1/0 AWG	2/0 AWG	3/0 AWG	4/0 AWG	250 kcmil	300 kcmil	350 kcmil	500 kcmil	600 kcmil	750 kcmil	800 kcmil	1000 kcmil																
		Panduit Part Number																																			
 <b>D2.141</b>	One Barrel, One-Hole <b>LAMA</b>	1/4	LAMA6-14-QY■			LAMA2-14-QY■			LAMA1/0-14-QY■			LAMA2/0-14-QY			LAMA1/0-56-Q■			LAMA250-56-QY			LAMA300-56-QY*			LAMA350-38-QY			LAMA500-38-6Y			LAMA600-38-6Y			LAMA600S-38-6Y‡*				
			5/16	LAMA250-56-QY			LAMA300-56-QY*			LAMA350-38-QY			LAMA500-38-6Y			LAMA600-38-6Y			LAMA600S-38-6Y‡*																		
				3/8	LAMA250-56-QY			LAMA300-56-QY*			LAMA350-38-QY			LAMA500-38-6Y			LAMA600-38-6Y			LAMA600S-38-6Y‡*																	
			5/8		LAMA250-56-QY			LAMA300-56-QY*			LAMA350-38-QY			LAMA500-38-6Y			LAMA600-38-6Y			LAMA600S-38-6Y‡*																	
		 <b>D2.142</b>		One Barrel, Two-Hole <b>LAMB</b>	1/2	LAMB350-12-6Y◆			LAMB600-12-3Y◆			LAMB1000-12-3◆▲*																									
 <b>D2.142</b>	Two Barrel, One-Hole <b>LAM2A</b>		1/4			LAM2A1/0-14-6Y■			LAM2A2/0-14-6Y			LAM2A250-38-6Y			LAM2A350-12-6Y			LAM6A600-12-6Y*			LAM2A1000-58-6Y*																
		3/8		LAM2A250-38-6Y			LAM2A350-12-6Y			LAM6A600-12-6Y*			LAM2A1000-58-6Y*																								
			1/2	LAM2A250-38-6Y			LAM2A350-12-6Y			LAM6A600-12-6Y*			LAM2A1000-58-6Y*																								
		5/8		LAM2A250-38-6Y			LAM2A350-12-6Y			LAM6A600-12-6Y*			LAM2A1000-58-6Y*																								
 <b>D2.143</b>	Two Barrel, Two-Hole <b>LAM2B</b>		1/2	LAM2B350-12-3Y◆			LAM2LB600-12-3◆▲*			LAM2LB1000-12-3◆▲*																											
		 <b>D2.144</b>		Two Barrel, Two-Hole <b>LAM2SB</b>	3/8	LAM2SB600-38-1Y*			LAM2SB750-38-1Y*			LAM2SSB500-141Y▲																									
1/4	LAM2SB600-38-1Y*					LAM2SB750-38-1Y*			LAM2SSB500-141Y▲																												
	 <b>D2.144</b>	Three Barrel, Two-Hole <b>LAM3B</b>	3/8	LAM3B1/0-38-6Y■			LAM3B3/0-12-3Y◆			LAM3B250-12-1Y◆			LAM3B350-12-1Y◆			LAM3LB600-12-1◆▲			LAM3LB1000-121Y▲◆																		
1/2				LAM3B1/0-38-6Y■			LAM3B3/0-12-3Y◆			LAM3B250-12-1Y◆			LAM3B350-12-1Y◆			LAM3LB600-12-1◆▲			LAM3LB1000-121Y▲◆																		
	 <b>D2.145</b>	Three Barrel, Four-Hole <b>LAM3D</b>	1/2	LAM3D3/0-12-3Y◆			LAM3D250-12-1Y◆			LAM3D350-12-1Y◆			LAM3LD600-12-1◆▲			LAM3LD1000-121Y◆▲																					
LAM3D3/0-12-3Y◆				LAM3D250-12-1Y◆			LAM3D350-12-1Y◆			LAM3LD600-12-1◆▲			LAM3LD1000-121Y◆▲																								
 <b>D2.146</b>	Four Barrel, Two-Hole <b>LAM4SB</b>	3/8	LAM4SB600-38-1Y			LAM4SB750-38-1Y																															
			LAM4SB600-38-1Y			LAM4SB750-38-1Y																															
 <b>D2.146</b>	Four Barrel, Four-Hole <b>LAM4D</b>	1/2	LAM4D250-12-1Y◆			LAM4D350-12-1Y◆			LAM4LD600-12-1◆▲			LAM4LD1000-12-1◆▲																									
			LAM4D250-12-1Y◆			LAM4D350-12-1Y◆			LAM4LD600-12-1◆▲			LAM4LD1000-12-1◆▲																									

‡LAMA600S-38-6 can also be used with (2) 250 kcmil-1/0 AWG conductors.

◆NEMA hole sizes and spacing.

■Uses slotted set screws.

▲Uses double set screws.

Note: Use of Panduit oxide inhibiting joint compound CMP-100 is recommended for use with aluminum mechanical connectors.

\*UL Listed and CSA Certified.

•Not UL Listed or CSA Certified.

A. System Overview

B1. Cable Ties

B2. Cable Accessories

B3. Stainless Steel Ties

C1. Wiring Duct

C2. Surface Raceway

C3. Abrasion Protection

C4. Cable Management

D1. Terminals

D2. Power Connectors

D3. Grounding Connectors

E1. Labeling Systems

E2. Labels

E3. Pre-Printed & Write-On Markers

E4. Permanent Identification

E5. Lockout/Tagout & Safety Solutions

F. Index

## Selection Guide – Pan-Lug™ Mechanical Connectors, Split Bolts and Multi-Taps

1. Select Split Bolt Style Desired      2. Determine Conductor Range and then Select Panduit Part Number

### Copper Split Bolt Connectors – SBC

For Use with Copper Code Conductors



Panduit Part Number	Conductor Size Range**		Panduit Part Number	Copper Conductor Range**	
	Min.	Max.		Min.	Max.
SBC8-C	#10 STR	#8 STR	SBC1/0-L	#4 STR	1/0 STR
SBC8L-C^	#16 STR	#8 STR	SBC2/0-Q	#2 STR	2/0 STR
SBC6S-C	#8 STR	#6 STR	SBC3/0-Q	#1 STR	3/0 STR
SBC6SL-C^	#8 STR	#6 STR	SBC250-Q	#1 STR	250 kcmil
SBC4S-C	#8 STR	#6 STR	SBC350-1	2/0 STR	350 kcmil
SBC4SL-C^	#8 STR	#6 STR	SBC500-1	300 kcmil	500 kcmil
SBC3-C	#8 STR	#4 STR	SBC750-1	#8 SOL	750 kcmil
SBC2-C	#6 STR	#2 STR	SBC1000-1	#8 SOL	1000 kcmil
SBC2L-C^	#14 STR	#2 STR			

^Long body accommodates two tap conductors with single run; not CSA Certified.  
\*\*The conductor sizes shown are for equal run and tap combinations

### Tin Plated Copper Split Bolt Connectors – SBCT

For Use with Combinations of Copper and Aluminum Conductors



Panduit Part Number	Copper and Aluminum Conductor Range		
	Range of Equal Run and Tap		Min. Tap with One Max. Run
	Min.	Max.	
SBCT8-C	#8 STR	#6 SOL	#14 STR
SBCT6-C	#6 STR	#10 STR	#10 STR
SBCT3-C	#8 STR	#4 STR	#10 STR
SBCT2-C	#6 STR	#2 STR	#14 STR
SBCT1/0-L	#4 STR	1/0 STR	#10 STR
SBCT2/0-Q	#2 STR	2/0 STR	#8 STR
Copper Conductor Range			
SBCT10-C	#16 STR	#10 STR	#16 STR
SBCT3/0-Q	#1 STR	3/0 STR	#8 STR
SBCT250-Q	#1 STR	250 kcmil	#8 STR
SBCT350-1	2/0 STR	350 kcmil	1/0 STR
SBCT500-1	300 kcmil	500 kcmil	2/0 STR
SBCT750-1	2/0 STR	750 kcmil	2/0 STR
SBCT1000-1	4/0 STR	1000 kcmil	4/0 STR

### Dual Rated Aluminum Split Bolt Connectors – SBA

For Use with Aluminum and Copper Conductor Combinations



Panduit Part Number	Aluminum to Aluminum, Aluminum to Copper, Copper to Copper Conductors		
	Max. Run to Max. Tap	Min. Run to Min. Tap	Max. Run to Min. Tap
SBA6-C	#6 STR – #6 STR	#10 SOL – #10 SOL	#6 STR – #10 SOL
SBA4-C	#4 STR – #4 STR	#8 SOL – #10 SOL	#4 STR – #10 SOL
SBA2-C	#2 STR – #2 STR	#6 SOL – #8 STR	#2 STR – #8 STR
SBA1/0-Q	1/0 STR – 1/0 STR	#2 STR (Compact) – #8 SOL	1/0 STR – #8 SOL
SBA2/0-Q	2/0 STR – 2/0 STR	#2 STR (Compact) – #8 STR	2/0 STR – #8 STR
SBA4/0-Q	4/0 STR – 4/0 STR	#2 STR (Compact) – #6 STR	4/0 STR – #6 STR
SBA350-1^	350 kcmil – 350 kcmil	1/0 STR (Compact) – #4 STR	350 kcmil – #4 STR
SBA500-1^	500 kcmil – 500 kcmil	400 kcmil (Compact) – #2 STR (Compact)	500 kcmil – #2 STR (Compact)

^Not CSA Certified.

### Multi-Tap Connectors with Clear Insulation

For Use with Aluminum and Copper Code Conductor Combinations



D2.149 – D2.154



Type	Description	No. of Ports	Copper or Aluminum Code Conductor Range
PCSB	Double-sided wire entry	2 to 14	14 AWG Solid to 750 kcmil
PCSB-S	Single-sided wire entry	2 to 14	14 AWG Solid to 750 kcmil
PISR	In-Line Splice/Reducer	2	14 AWG Stranded to 500 kcmil
PCSBMT	Double-sided wire entry mountable	4 to 12	14 AWG Solid to 600 kcmil
PSCBMT-S	Single-sided wire entry mountable	4 to 12	14 AWG Solid to 600 kcmil

A. System Overview

B1. Cable Ties

B2. Cable Accessories

B3. Stainless Steel Ties

C1. Wiring Duct

C2. Surface Raceway

C3. Abrasion Protection

C4. Cable Management

D1. Terminals

D2. Power Connectors

D3. Grounding Connectors

E1. Labeling Systems

E2. Labels

E3. Pre-Printed & Write-On Markers

E4. Permanent Identification

E5. Lockout/Tagout & Safety Solutions

F. Index



## Split Bolt, Copper

For Use with Copper Code Conductors

### Type SBC

- Made from high strength copper alloy to resist corrosion and provide premium electrical and mechanical performance
- Offered with extra long body to allow connection of one or two taps to a single run conductor
- Wide wire range-taking capability minimizes inventory requirements
- Nut hex provides correct fit with socket, box, or open end wrenches resulting in proper torquing of electrical connection
- Pressure bar provides secure connection on a full range of conductor combinations used with each connector assuring premium wire pull-out strength
- UL Listed and CSA Certified for use up to 600 V and temperature rated 90°C



Part Number	Copper Conductor			Max. Conductor Copperweld STR	Figure Dimensions (In.)			Std. Pkg. Qty.
	Range of Equal Run & Tap		Min. Tap with One Max. Run		E	W	L	
	Min.	Max.						
<b>SBC8-C</b>	#10 STR	#8 STR	#16 STR	—	0.39	0.55	0.86	100
<b>SBC8L-C*</b>	#16 STR	#8 STR	#16 STR	—	0.38	0.50	0.84	100
<b>SBC6S-C</b>	#8 STR	#6 STR	#16 STR	—	0.41	0.62	0.95	100
<b>SBC6SL-C*</b>	#8 STR	#6 STR	#16 STR	—	0.41	0.63	1.10	100
<b>SBC4S-C</b>	#8 STR	#6 STR	#14 STR	—	0.45	0.69	0.98	100
<b>SBC4SL-C*</b>	#8 STR	#6 STR	#14 STR	—	0.45	0.69	1.30	100
<b>SBC3-C</b>	#8 STR	#4 STR	#14 STR	—	0.58	0.81	1.16	100
<b>SBC2-C</b>	#6 STR	#2 STR	#14 STR	—	0.59	0.86	1.23	100
<b>SBC2L-C*</b>	#14 STR	#2 STR	#14 STR	3 No. 7	0.63	0.81	1.55	100
<b>SBC1/0-L</b>	#4 STR	1/0 STR	#14 STR	—	0.75	0.93	1.55	50
<b>SBC2/0-Q</b>	#2 STR	2/0 STR	#14 STR	—	0.79	1.05	1.72	25
<b>SBC3/0-Q</b>	#1 STR	3/0 STR	#8 STR	—	0.95	1.24	2.07	25
<b>SBC250-Q</b>	#1 STR	250 kcmil	#8 STR	—	1.03	1.36	2.09	25
<b>SBC350-1</b>	2/0 STR	350 kcmil	1/0 STR	—	1.16	1.48	2.42	1
<b>SBC500-1</b>	300 kcmil	500 kcmil	2/0 STR	—	1.33	1.74	2.83	1
<b>SBC750-1</b>	#8 SOL	750 kcmil	#8 SOL	19 No. 5	1.94	2.13	3.75	1
<b>SBC1000-1</b>	#8 SOL	1000 kcmil	#8 SOL	—	2.25	2.50	4.00	1

\*Long body accommodates two tap conductors with single run; not CSA Certified.

A.  
System  
Overview

B1.  
Cable Ties

B2.  
Cable  
Accessories

B3.  
Stainless  
Steel Ties

C1.  
Wiring  
Duct

C2.  
Surface  
Raceway

C3.  
Abrasion  
Protection

C4.  
Cable  
Management

D1.  
Terminals

D2.  
Power  
Connectors

D3.  
Grounding  
Connectors

E1.  
Labeling  
Systems

E2.  
Labels

E3.  
Pre-Printed  
& Write-On  
Markers

E4.  
Permanent  
Identification

E5.  
Lockout/  
Tagout  
& Safety  
Solutions

F.  
Index

A. System Overview



## Split Bolt, Copper, Tin-Plated

B1. Cable Ties

### For Specified Combinations of Copper and Aluminum Code Conductors

#### Type SBCT

B2. Cable Accessories

- Made from high strength copper alloy to provide premium electrical and mechanical performance
- Tin-plated to inhibit corrosion and oxidation
- Offered with dual rating for use with aluminum or copper conductors
- Wide wire range-taking capability minimizes inventory requirements
- Nut hex provides correct fit with socket, box, or open end wrenches resulting in proper torquing of electrical connection
- Free floating pressure bar separates conductors of dissimilar materials for secure connection on a full range of conductor combinations
- UL Listed and CSA Certified for use up to 600 V and UL temperature rated 90°C

B3. Stainless Steel Ties

C1. Wiring Duct



C2. Surface Raceway

C3. Abrasion Protection

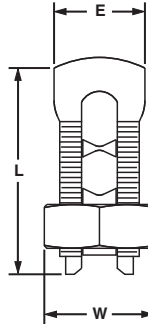

C4. Cable Management

Part Number	Copper and Aluminum Code Conductor			ACSR Range	Max. Conductor	Figure Dimensions (In.)			Std. Pkg. Qty.	
	Range of Equal Run and Tap		Min. Tap with One Max. Run			Copperweld	E	W		L
	Min.	Max.								

#### UL Listed and CSA Certified with Copper and Aluminum Conductors

<b>SBCT8-C</b>	#8 STR	#6 SOL	#14 STR	—	—	0.41	0.62	1.06	100
<b>SBCT6-C</b>	#6 STR	#10 STR	#10 STR	—	—	0.49	0.68	1.10	100
<b>SBCT3-C</b>	#8 STR	#4 STR	#10 STR	—	—	0.58	0.81	1.24	100
<b>SBCT2-C</b>	#6 STR	#2 STR	#14 STR	—	—	0.60	0.86	1.45	100
<b>SBCT1/0-L</b>	#4 STR	1/0 STR	#10 STR	—	—	0.75	0.93	1.73	50
<b>SBCT2/0-Q</b>	#2 STR	2/0 STR	#8 STR	—	—	0.79	1.05	1.71	25

#### UL Listed and CSA Certified with Copper Code Conductors Only

<b>SBCT10-C</b>	#16 STR	#10 STR	#16 STR	—	—	0.38	0.49	0.87	100
<b>SBCT3/0-Q</b>	#1 STR	3/0 STR	#8 STR	—	—	0.75	1.25	2.12	25
<b>SBCT250-Q</b>	#1 STR	250 kcmil	#8 STR	—	—	1.03	1.36	2.22	25
<b>SBCT350-1</b>	2/0 STR	350 kcmil	1/0 STR	—	—	1.17	1.49	2.55	1
<b>SBCT500-1</b>	300 kcmil	500 kcmil	2/0 STR	—	—	1.32	1.74	2.95	1
<b>SBCT750-1</b>	2/0 STR	750 kcmil	2/0 STR	4/0 – 666.6	19 No. 5	1.93	2.11	3.78	1
<b>SBCT1000-1</b>	4/0 STR	1000 kcmil	4/0 STR	300 – 900	—	2.29	2.53	4.02	1

D1. Terminals

D2. Power Connectors

D3. Grounding Connectors

E1. Labeling Systems

E2. Labels

E3. Pre-Printed & Write-On Markers

E4. Permanent Identification

E5. Lockout/Tagout & Safety Solutions

F. Index

The use of Panduit oxide inhibiting joint compound (CMP-100) is recommended. See pages D2.118 and D2.155.



## Split Bolt, Aluminum

For Use with Copper and Aluminum Code Conductors

### Type SBA

- Made from lightweight, durable aluminum alloy to resist corrosion and provide premium electrical and mechanical performance
- Dual rated for use with aluminum to aluminum, aluminum to copper, and copper to copper conductor combinations
- Tin-plated to inhibit corrosion and oxidation
- Wide wire range-taking capability minimizes inventory requirements

- True hex design for body and nut hex provides correct fit with socket, box, or open end wrenches resulting in proper torquing of electrical connection
- Free floating pressure bar separates conductors of dissimilar materials for secure connection on a full range of conductor combinations
- UL Listed and CSA Certified for use up to 600 V and UL temperature rated 90°C

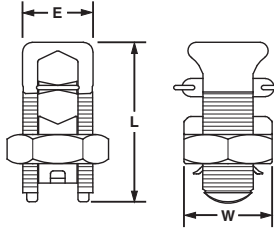

Part Number	Max. Run to Max. Tap	Min. Run to Min. Tap	Max. Run to Min. Tap	Figure Dimensions (In.)			Std. Pkg. Qty.
				E	W	L	
SBA6-C	#6 STR – #6 STR	#10 SOL – #10 SOL	#6 STR – #10 SOL	0.56	0.75	1.58	100
SBA4-C	#4 STR – #4 STR	#8 SOL – #10 SOL	#4 STR – #10 SOL	0.62	0.81	1.38	100
SBA2-C	#2 STR – #2 STR	#6 SOL – #8 STR	#2 STR – #8 STR	0.69	0.94	1.58	100
SBA1/0-Q	1/0 STR – 1/0 STR	#2 STR (Compact) – #8 SOL	1/0 STR – #8 SOL	0.75	1.00	1.92	25
SBA2/0-Q	2/0 STR – 2/0 STR	#2 STR (Compact) – #8 STR	2/0 STR – #8 STR	0.88	1.12	1.92	25
SBA4/0-Q	4/0 STR – 4/0 STR	#2 STR (Compact) – #6 STR	4/0 STR – #6 STR	1.13	1.49	2.54	25
^ SBA350-1	350 kcmil – 350 kcmil	1/0 STR (Compact) – #4 STR	350 kcmil – #4 STR	1.50	1.69	3.24	1
^ SBA500-1	500 kcmil – 500 kcmil	400 kcmil (Compact) – #2 STR (Compact)	500 kcmil – #2 STR (Compact)	1.73	2.00	3.62	1

The use of Panduit oxide inhibiting joint compound (CMP-100) is recommended. See page D2.155.

^Not CSA Certified.



## Two-Bolt Connector, Bronze

For Use with Copper Code Conductors

### Type VT

- Made from high strength bronze for heavy duty connections and to inhibit corrosion
- Cap swivels for easy installation of conductors
- Rubber washer retains hardware to connector and eliminates loose parts

- High strength silicon-bronze hardware provides premium mechanical performance when assembled to conductor
- Wide wire range-taking capability minimizes inventory requirements
- UL Listed for use up to 600 V and 90°C temperature rated

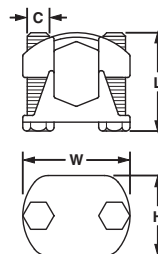

Part Number	Copper Conductor Size		Figure Dimensions (In.)				Hex Size (In.)	Std. Pkg. Qty.
	Run	Tap	L	W	H	C		
VT-0-Q	#2 STR – 1/0 STR	#10 STR – 1/0 STR	1.50	1.44	0.94	0.31	1/2	25
VT-1-Q	#2 STR – 2/0 STR	#10 STR – 2/0 STR	1.50	1.56	1.13	0.31	1/2	25
VT-2-Q	1/0 STR – 4/0 STR	#10 STR – 4/0 STR	1.75	1.84	1.34	0.38	9/16	25
VT-3-12	250 kcmil – 350 kcmil	#10 STR – 350 kcmil	2.00	2.31	1.63	0.50	3/4	12
VT-4-12	250 kcmil – 500 kcmil	#10 STR – 500 kcmil	2.25	2.44	1.69	0.50	3/4	12
VT-5-6	400 kcmil – 800 kcmil	3/0 STR – 800 kcmil	2.50	2.69	1.88	0.50	9/16	6
VT-6-6	500 kcmil – 1000 kcmil	3/0 STR – 1000 kcmil	2.75	3.06	2.25	0.63	15/16	6

A. System Overview

## **Two-Bolt Connector, Bronze, Tin-Plated**

B1. Cable Ties

**For Use with Copper and Aluminum Code Conductors**

### Type VTA

- Made from high strength bronze for heavy duty connections
- Tin-plated to inhibit corrosion and oxidation
- Cap swivels for easy installation of conductors
- Rubber washer retains hardware to connector and eliminates loose parts
- High strength silicon-bronze hardware provides premium mechanical performance when assembled to conductor
- Offered for use with aluminum conductors, but not UL Listed
- UL Listed for use up to 600 V and 90°C temperature rated when used with copper code conductor

B2. Cable Accessories

B3. Stainless Steel Ties



C1. Wiring Duct

C2. Surface Raceway

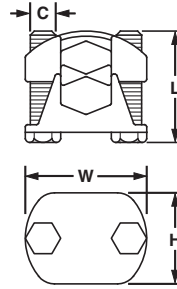

C3. Abrasion Protection

Part Number	Copper Conductor Size Range		Copperweld Solid	Aluminum		Figure Dimensions (In.)				Hex Size (In.)	Std. Pkg. Qty.
	Run	Tap		AWG	ACSR	L	W	H	C		
<b>VTA-0-Q</b>	2 STR – 1/0 STR	10 STR – 1/0 STR	2/0	1/0 STR	1	1.25	1.44	0.94	5/16	1/2	25
<b>VTA-1-Q</b>	2 STR – 2/0 STR	10 STR – 2/0 STR	3/0	—	—	1.50	1.56	1.13	5/16	1/2	25
<b>VTA-2-Q</b>	1/0 STR – 4/0 STR	10 STR – 4/0 STR	4/0	—	—	1.75	1.84	1.34	3/8	9/16	25
<b>VTA-3-12</b>	250 – 350 kcmil	10 STR – 350 kcmil	—	—	—	2.00	2.31	1.63	1/2	3/4	12
<b>VTA-4-12</b>	250 – 500 kcmil	10 STR – 500 kcmil	—	—	—	2.25	2.44	1.69	1/2	3/4	12
<b>VTA-5-6</b>	400 – 800 kcmil	3/0 STR – 800 kcmil	—	—	—	2.50	2.69	1.88	1/2	3/4	6
<b>VTA-6-6</b>	500 – 1000 kcmil	3/0 STR – 1000 kcmil	—	—	—	2.75	3.06	2.25	5/8	15/16	6

\*Not UL Listed.

C4. Cable Management

D1. Terminals

D2. Power Connectors

D3. Grounding Connectors

## **One-Hole, Straight Tongue, Barrel Post Lug**

**For Use with Copper Code Conductors**

### Type ML

- Made from high strength electrolytic copper to provide premium electrical and mechanical performance
- Compact design saves space
- Wide wire range-taking capability minimizes inventory requirements
- Inspection window to visually assure full conductor insertion
- Plated steel set screw provides high strength, durable electrical contact between conductor and connector
- Flat bottom allows for complete contact with mounting surface
- UL Listed for use up to 600 V and temperature rated 90°C

E1. Labeling Systems

E2. Labels



E3. Pre-Printed & Write-On Markers

E4. Permanent Identification

E5. Lockout/Tagout & Safety Solutions

F. Index

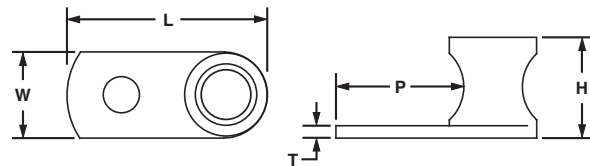

Part Number	Copper Conductor Size Range	Stud Hole Size (In.)	Hex Key Size (In.)	Figure Dimensions (In.)					Std. Pkg. Qty.
				L	W	H	T	P	
<b>ML8-CY</b>	#14 SOL – #8 STR	3/16	**	0.81	0.38	0.42	0.08	0.48	100
<b>ML4-CY</b>	#14 SOL – #4 STR	1/4	**	1.11	0.54	0.55	0.09	0.63	100
<b>ML1/0-LY</b>	#14 SOL – 1/0 STR	5/16	1/4	1.54	0.73	0.79	0.09	0.80	50
<b>ML250-QY</b>	#6 STR – 250 kcmil	3/8	1/4	1.94	0.94	1.06	0.12	1.00	25

\*\*Uses slotted head set screw.

## One-Hole, Straight Tongue, Tin-Plated, Barrel Post Lug

For Use with Copper Code Conductors

### Type ML-T

- Made from high strength, electrolytic copper to provide premium electrical and mechanical performance
- Tin-plated to inhibit corrosion
- Compact design saves space
- Wide wire range-taking capability minimizes inventory requirements
- Inspection window to visually assure full conductor insertion
- Plated steel set screw provides high strength, durable electrical contact between conductor and connector
- Flat bottom allows for complete contact with mounting surface
- UL Listed for use up to 600 V and temperature rated 90°C



Part Number	Copper Conductor Size Range	Stud Hole Size (In.)	Hex Key Size (In.)	Figure Dimensions (In.)					Std. Pkg. Qty.
				L	W	H	T	P	
ML8T-CY	#14 SOL – #8 STR	3/16	**	0.81	0.38	0.42	0.08	0.48	100
ML4T-CY	#14 SOL – #4 STR	1/4	**	1.11	0.54	0.55	0.09	0.63	100
ML1/0T-LY	#14 SOL – 1/0 STR	5/16	1/4	1.58	0.73	0.79	0.09	0.80	50
ML250T-QY	#6 STR – 250 kcmil	3/8	1/4	1.94	0.94	1.06	0.12	1.00	25

\*\*Uses slotted head set screw.

## One-Hole, Straight Tongue Lug

For Use with Copper Code Conductors

### Type PNL

- Cast from high strength corrosion resistant copper alloy to provide premium electrical and mechanical performance
- Compact design saves space
- Wide wire range-taking capability minimizes inventory requirements
- Inspection window to visually assure full conductor insertion
- Plated steel set screw provides high strength, durable electrical contact between conductor and connector
- Flat bottom allows for complete contact with mounting surface
- UL Listed and CSA Certified for use up to 600 V and UL temperature rated 90°C

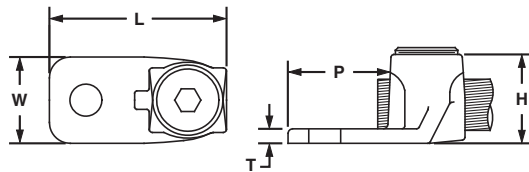

Part Number	Copper Conductor Size Range	Stud Hole Size (In.)	Hex Key Size (In.)	Figure Dimensions (In.)					Std. Pkg. Qty.
				L	W	H	T	P	
PNL-4-C	#14 SOL – #4 STR	1/4	**	1.25	0.53	0.56	0.14	0.66	100
PNL-1/0-L	#8 SOL – 1/0 STR	5/16	1/4	1.59	0.73	0.78	0.14	0.85	50
PNL-250-Q	#6 SOL – 250 kcmil	3/8	5/16	1.97	0.94	1.05	0.13	1.00	25
PNL-500-3	#4 SOL – 500 kcmil	1/2	3/8	3.00	1.38	1.47	0.25	1.63	3
PNL-1000-3	500 kcmil – 1000 kcmil	1/2	1/2	3.88	1.75	2.00	0.38	2.13	3

\*\*Uses slotted head set screw.

A. System Overview

B1. Cable Ties

B2. Cable Accessories

B3. Stainless Steel Ties

C1. Wiring Duct

C2. Surface Raceway

C3. Abrasion Protection

C4. Cable Management

D1. Terminals

D2. Power Connectors

D3. Grounding Connectors

E1. Labeling Systems

E2. Labels

E3. Pre-Printed & Write-On Markers

E4. Permanent Identification

E5. Lockout/Tagout & Safety Solutions

F. Index

A. System Overview

## **UL LISTED** One-Hole, Straight Tongue Lug with Internal Pressure Plate

B1. Cable Ties

**For Use with Copper Code Conductors**

### Type HL

B2. Cable Accessories

- Cast from high strength corrosion resistant copper alloy to provide premium electrical and mechanical performance
- Compact design saves space
- Wide wire range-taking capability minimizes inventory requirements
- Pressure plate\* provides uniform clamping force on conductor for premium electrical performance
- Plated steel set screw provides high strength, durable electrical contact between conductor and connector
- Flat bottom allows for complete contact with mounting surface
- Inspection window to visually assure full conductor insertion
- UL Listed for use up to 600 V and temperature rated 90°C

B3. Stainless Steel Ties

C1. Wiring Duct



C2. Surface Raceway

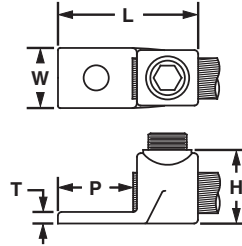

C3. Abrasion Protection

C4. Cable Management

Part Number	Copper Conductor Size Range	Stud Hole Size (in.)	Hex Key Size (in.)	Figure Dimensions (in.)					Std. Pkg. Qty.
				L	W	H	T	P	
HL1-25-X	#14 SOL – #8 STR	1/4	**	1.38	0.56	0.79	0.19	0.81	10
HL4-1-X	#8 SOL – #4 STR	1/4	**	1.38	0.56	0.79	0.19	0.81	10
HL8-1-X	#4 SOL – #1 STR	1/4	7/16	1.56	0.75	0.90	0.22	0.69	10
HL13-1-5	#1 STR – 2/0 STR	3/8	9/16	1.88	0.81	1.14	0.22	0.88	5
HL21-1-5	2/0 STR – 4/0 STR	3/8	9/16	2.19	1.00	1.31	0.25	1.00	5
HL30-1-2	4/0 STR – 300 kcmil	1/2	5/8	2.50	1.06	1.47	0.31	1.25	2
HL50-1-2	300 kcmil – 500 kcmil	1/2	3/4	3.00	1.38	1.65	0.34	1.50	2

\*HL1-25-X and HL4-1-X do not include pressure plates.

\*\*Uses slotted head set screw.

D1. Terminals

D2. Power Connectors

## **UL LISTED** One-Hole, Straight Tongue, Flag Lug

D3. Grounding Connectors

**For Use with Copper Code Conductors**

### Type HLB

E1. Labeling Systems

- Provides connection of conductor at right angles to terminal bar
- Cast from high strength corrosion resistant copper alloy to provide premium electrical and mechanical performance
- Compact design saves space
- Wire range-taking capability minimizes inventory requirements
- Internal pressure plate provides uniform clamping force on conductor for premium electrical performance
- Flush bottom allows for complete contact with mounting surface
- Inspection window to visually assure full conductor insertion
- UL Listed for use up to 600 V and temperature rated 90°C

E2. Labels

E3. Pre-Printed & Write-On Markers



E4. Permanent Identification

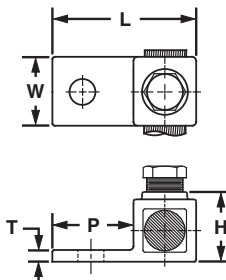

E5. Lockout/Tagout & Safety Solutions

Part Number	Copper Conductor Size Range	Stud Hole Size (in.)	Hex Key Size (in.)	Figure Dimensions (in.)					Std. Pkg. Qty.
				L	W	H	T	P	
HLB4-1-X	#8 SOL – #4 STR	1/4	**	1.25	0.50	0.79	0.19	0.63	10

\*\*Uses slotted head set screw.

F. Index



## UL LISTED One-Hole, Straight Tongue, 90° Lug

For Use with Copper Code Conductors

### Type HLA-90

- Provides connection of conductor at right angles to terminal bar
- Cast from high strength corrosion resistant copper alloy to provide premium electrical and mechanical performance
- Compact design saves space
- Wide wire range-taking capability minimizes inventory requirements
- Internal pressure plate provides uniform clamping force on conductor for premium electrical performance
- Flush bottom allows for complete contact with mounting surface
- UL Listed for use up to 600 V and temperature rated 90°C

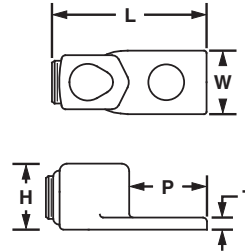

Part Number	Copper Conductor Size Range	Stud Hole Size (In.)	Hex Key Size (In.)	Figure Dimensions (In.)					Std. Pkg. Qty.
				L	W	H	T	P	
HLA4-1-90-X	#8 SOL – #4 STR	1/4	**	1.81	0.56	0.73	0.19	0.63	10
HLA8-1-90-X	#4 SOL – #1 STR	1/4	7/16	1.50	0.75	0.75	0.22	0.69	10
HLA13-1-90-5	#1 STR – 2/0 STR	3/8	9/16	2.38	0.81	1.00	0.22	0.88	5
HLA21-1-90-5	2/0 STR – 4/0 STR	3/8	9/16	2.69	1.00	1.14	0.25	1.00	5

\*\*Uses slotted head set screw.

## UL LISTED Two-Hole, Straight Tongue Lug

For Use with Copper Code Conductors

### Type PNL-2

- Cast from high strength corrosion resistant copper alloy to provide premium electrical and mechanical performance
- Wide wire range-taking capability minimizes inventory requirements
- Inspection window to visually assure full conductor insertion
- Plated steel set screw provides high strength, durable electrical contact between conductor and connector
- Flat bottom allows for complete contact with mounting surface
- UL Listed for use up to 600 V and temperature rated 90°C

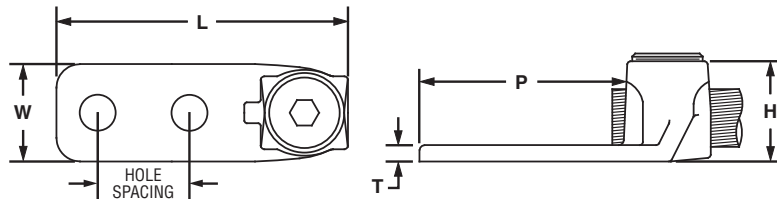

Part Number	Copper Conductor Size Range	Stud Hole Size (In.)	Stud Hole Spacing (In.)	Hex Key Size (In.)	Figure Dimensions (In.)					Std. Pkg. Qty.
					L	W	H	T	P	
PNL-1/0-2-L	#8 SOL – 1/0 STR	5/16	1.00	1/4	2.75	0.75	0.84	0.19	2.00	50
PNL-250-2-Q	#6 SOL – 250 kcmil	3/8	1.00	1/4	2.88	0.94	1.03	0.22	2.02	25
PNL-500-2-3	#4 SOL – 500 kcmil	3/8	1.00	3/8	3.38	1.38	1.47	0.31	2.00	3
PNL-1000-2-3	500 kcmil – 1000 kcmil	1/2	1.50	3/8	4.88	1.75	2.00	0.38	3.13	3

A. System Overview

**UL LISTED** **Two-Hole, Straight Tongue Lug with Internal Pressure Plate**

B1. Cable Ties

**For Use with Copper Code Conductors**  
**Type HL-2**

B2. Cable Accessories

- Cast from high strength corrosion resistant copper alloy to provide premium electrical and mechanical performance
- Wide wire range-taking capability minimizes inventory requirements
- Internal pressure plate provides uniform clamping force on conductor for premium electrical performance
- Plated steel set screw provides high strength, durable electrical contact between conductor and connector
- Inspection window to visually assure full conductor insertion
- Flat bottom allows for complete contact with mounting surface
- UL Listed for use up to 600 V and temperature rated 90°C

B3. Stainless Steel Ties

C1. Wiring Duct



C2. Surface Raceway

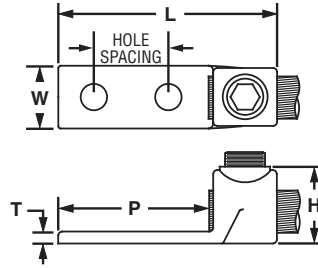

C3. Abrasion Protection

C4. Cable Management

Part Number	Copper Conductor Size Range	Stud Hole Size (In.)	Stud Hole Spacing (In.)	Hex Key Size (In.)	Figure Dimensions (In.)					Std. Pkg. Qty.
					L	W	H	T	P	
<b>HL1-2-25-X</b>	#14 SOL – #8 STR	1/4	0.63	**	2.00	0.56	0.70	0.19	1.25	10
<b>HL4-2-X</b>	#8 SOL – #4 STR	1/4	0.63	**	2.00	0.56	0.69	0.18	1.25	10
<b>HL8-2-X</b>	#4 SOL – #1 STR	1/4	0.75	7/16	2.44	0.75	0.92	0.22	1.50	10
<b>HL13-2-5</b>	#1 STR – 2/0 STR	3/8	1.00	9/16	2.88	0.81	1.07	0.22	1.88	5
<b>HL21-2-5</b>	2/0 STR – 4/0 STR	3/8	1.00	9/16	3.00	1.00	1.33	0.25	1.75	5
<b>HL30-2-2</b>	4/0 STR – 300 kcmil	3/8	1.00	5/8	3.13	1.06	1.45	0.31	2.00	2
<b>HL50-2-2</b>	300 kcmil – 500 kcmil	3/8	1.00	3/4	3.44	1.38	1.66	0.34	2.00	2

\*\*Uses slotted head set screw.

D1. Terminals

D2. Power Connectors

D3. Grounding Connectors

E1. Labeling Systems

E2. Labels

E3. Pre-Printed & Write-On Markers

E4. Permanent Identification

E5. Lockout/Tagout & Safety Solutions

F. Index



## Two-Hole, Straight Tongue Lug with NEMA Hole Sizes and Spacing

For Use with Copper Code Conductors

### Type HL-2N

- Cast from high strength corrosion resistant copper alloy to provide premium electrical and mechanical performance
- Wide wire range-taking capability minimizes inventory requirements
- Internal pressure plate provides uniform clamping force on conductor for premium electrical performance
- Internal barrel serrations allow for premium wire pull-out strength
- Inspection window to visually assure full conductor insertion
- Flat bottom allows for complete contact with mounting surface
- UL Listed for use up to 600 V and temperature rated 90°C
- Available with NEMA hole sizes and spacing

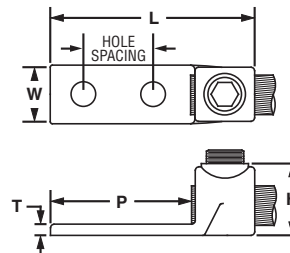

Part Number	Copper Conductor Size Range	Stud Hole Size (In.)	Stud Hole Spacing (In.)	Hex Key Size (In.)	Figure Dimensions (In.)					Std. Pkg. Qty.
					L	W	H	T	P	
◆ HL8-2N-X	#4 SOL – #1 STR	1/2	1.75	7/16	3.94	1.00	0.90	0.22	3.00	10
◆ HL13-2N-5	#1 STR – 2/0 STR	1/2	1.75	9/16	4.25	1.00	1.07	0.22	3.00	5
◆ HL21-2N-5	2/0 STR – 4/0 STR	1/2	1.75	9/16	4.19	1.25	1.34	0.25	3.00	5
◆ HL30-2N-2	4/0 STR – 300 kcmil	1/2	1.75	5/8	4.25	1.25	1.46	0.31	3.00	2

◆NEMA hole sizes and spacing.



## Two-Hole, Straight Tongue, Tandem Set Screw Lug

For Use with Copper Code Conductors

### Type HHL-2N

- Cast from high strength corrosion resistant copper alloy to provide premium electrical and mechanical performance
- Double set screws provide additional wire secureness for use in heavy duty applications
- Wide wire range-taking capability minimizes inventory requirements
- Internal pressure plate provides uniform clamping force on conductor for premium electrical performance
- Internal barrel serrations allow for premium wire pull-out strength
- Inspection window to visually assure full conductor insertion
- Flat bottom allows for complete contact with mounting surface
- UL Listed for use up to 600 V and temperature rated 90°C
- Available with NEMA hole sizes and spacing

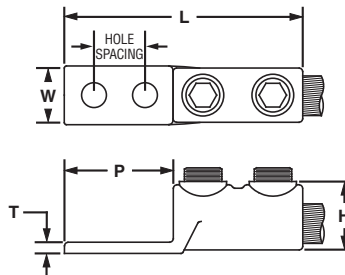

Part Number	Copper Conductor Size Range	Stud Hole Size (In.)	Stud Hole Spacing (In.)	Hex Key Size (In.)	Figure Dimensions (In.)					Std. Pkg. Qty.
					L	W	H	T	P	
◆ HHL8-2N-X	#4 SOL – #1 STR	1/2	1.75	7/16	5.13	1.00	0.80	0.22	3.00	10
◆ HHL13-2N-5	#1 STR – 2/0 STR	1/2	1.75	9/16	4.88	1.25	1.00	0.22	3.00	5
◆ HHL21-2N-5	2/0 STR – 4/0 STR	1/2	1.75	9/16	5.63	1.50	1.37	0.25	3.00	5
◆ HHL30-2N-1	4/0 STR – 300 kcmil	1/2	1.75	5/8	5.88	1.50	1.45	0.31	3.00	1

◆NEMA hole sizes and spacing.

A. System Overview

B1. Cable Ties

B2. Cable Accessories

B3. Stainless Steel Ties

C1. Wiring Duct

C2. Surface Raceway

C3. Abrasion Protection

C4. Cable Management

D1. Terminals

D2. Power Connectors

D3. Grounding Connectors

E1. Labeling Systems

E2. Labels

E3. Pre-Printed & Write-On Markers

E4. Permanent Identification

E5. Lockout/Tagout & Safety Solutions

F. Index

## **Two-Hole, Straight Tongue, Two-Barrel Lug**

**For Use with Copper Code Conductors**

### Type H2L-2N

- Allows for termination of two copper conductors
- Cast from high strength corrosion resistant copper alloy to provide premium electrical and mechanical performance
- Wide wire range-taking capability minimizes inventory requirements
- Internal pressure plate provides uniform clamping force on conductor for premium electrical performance
- Internal barrel serrations provide premium wire pull-out strength
- Inspection window to visually assure full conductor insertion
- Flat bottom allows for complete contact with mounting surface
- UL Listed for use up to 600 V and temperature rated 90°C
- Available with NEMA hole sizes and spacing

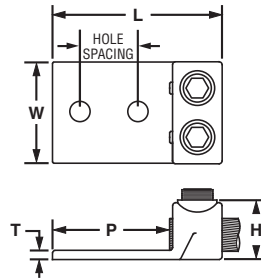

Part Number	Copper Conductor Size Range	Stud Hole Size (In.)	Stud Hole Spacing (In.)	Hex Key Size (In.)	Figure Dimensions (In.)					Std. Pkg. Qty.
					L	W	H	T	P	
◆ H2L4-2N-X	#8 SOL – #4 STR	1/2	1.75	**	3.75	1.25	0.76	0.19	3.00	10
◆ H2L8-2N-2	#4 SOL – #1 STR	1/2	1.75	7/16	3.94	1.38	0.92	0.22	3.00	2
◆ H2L13-2N-2	#1 STR – 2/0 STR	1/2	1.75	9/16	4.00	1.63	1.06	0.22	3.00	2
◆ H2L21-2N-2	2/0 STR – 4/0 STR	1/2	1.75	9/16	4.19	1.88	1.34	0.31	3.00	2
◆ H2L30-2N-1	4/0 STR – 300 kcmil	1/2	1.75	5/8	4.38	2.00	1.45	0.31	3.00	1

\*\*Uses slotted head set screw.  
◆NEMA hole sizes and spacing.

## **Two-Hole, Straight Tongue, Two-Barrel, Tin-Plated Lug**

**For Use with Copper Code Conductors**

### Type P2NLT

- Allows for termination of two copper conductors
- Cast from high strength corrosion resistant copper alloy to provide premium electrical and mechanical performance
- Tin-plated to inhibit corrosion
- Wide wire range-taking capability minimizes inventory requirements
- Internal barrel serrations provide premium wire pull-out strength
- Inspection window to visually assure full conductor insertion
- Plated steel set screw provides high strength, durable electrical contact
- Flat bottom allows for complete contact with mounting surface
- UL Listed for use up to 600 V and temperature rated 90°C
- Available with NEMA hole sizes and spacing

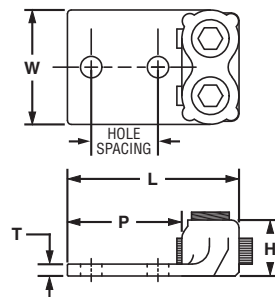

Part Number	Copper Conductor Size Range	Stud Hole Size (In.)	Stud Hole Spacing (In.)	Hex Key Size (In.)	Figure Dimensions (In.)					Std. Pkg. Qty.
					L	W	H	T	P	
◆ P2NLT-500-3	#4 SOL – 500 kcmil	1/2	1.75	3/8	4.50	2.50	1.47	0.38	3.00	3

◆NEMA hole sizes and spacing.

## Two-Set Screw Splice

**For Use with Copper Code Conductors**

### Type PNLC

- Cast from high strength corrosion resistant copper alloy to provide premium electrical and mechanical performance
- Wide wire range-taking capability minimizes inventory requirements
- Plated steel set screw provides high strength, durable electrical contact between conductor and connector
- Internal wire stops to prevent over-insertion of conductor
- For use up to 600 V and temperature rated 90°C

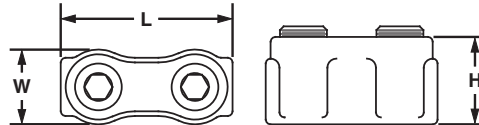

Part Number	Copper Conductor Size Range	Hex Key Size (In.)	Figure Dimensions (In.)			Std. Pkg. Qty.
			L	W	H	
PNLC-1/0-3	#8 SOL – 1/0 STR	1/4	1.63	0.72	0.84	3
PNLC-250-1	#6 SOL – 250 kcmil	3/8	2.13	0.97	1.06	1
PNLC-500-1	#4 SOL – 500 kcmil	3/8	3.00	1.38	1.47	1

## Two-Set Screw Splice with Internal Pressure Plate

**For Use with Copper Code Conductors**

### Type HC

- Cast from high strength corrosion resistant copper alloy to provide premium electrical and mechanical performance
- Wide wire range-taking capability minimizes inventory requirements
- Internal pressure plate provides uniform clamping force on conductor for premium electrical performance
- Internal barrel serrations provide premium wire pull-out strength
- Internal wire stops to prevent over-insertion of conductor
- UL Listed for use up to 600 V and temperature rated 90°C

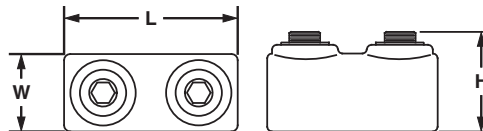

Part Number	Copper Conductor Size Range	Hex Key Size (In.)	Figure Dimensions (In.)			Std. Pkg. Qty.
			L	W	H	
HC4-3*	#8 SOL – #4 STR	**	1.25	0.50	0.56	3
HC8-3*	#4 SOL – #1 STR	7/16	1.75	0.69	0.81	3
HC13-3	#1 STR – 2/0 STR	9/16	2.00	0.81	0.94	3
HC21-1	2/0 STR – 4/0 STR	9/16	2.25	1.00	1.19	1
HC30-1	4/0 STR – 300 kcmil	5/8	2.56	1.19	1.44	1
HC50-1	300 kcmil – 500 kcmil	3/4	3.00	1.38	1.63	1

\*Includes swivel screws, not internal pressure plate.

\*\*Uses slotted head set screw.

A. System Overview

B1. Cable Ties

B2. Cable Accessories

B3. Stainless Steel Ties

C1. Wiring Duct

C2. Surface Raceway

C3. Abrasion Protection

C4. Cable Management

D1. Terminals

D2. Power Connectors

D3. Grounding Connectors

E1. Labeling Systems

E2. Labels

E3. Pre-Printed & Write-On Markers

E4. Permanent Identification

E5. Lockout/Tagout & Safety Solutions

F. Index

A. System Overview

**UL LISTED** **CSA CERTIFIED** **One-Hole, Straight Fixed Tongue Lug**

B1. Cable Ties

**For Use with Stranded Copper Code Conductors**

**Type CX**

- Made from high strength electrolytic copper to provide premium electrical and mechanical performance
- Compact design saves space
- Wide wire range-taking capability minimizes inventory requirements
- Inspection window to visually assure full conductor insertion
- Plated steel set screw provides high strength, durable electrical contact between conductor and connector
- UL Listed and CSA Certified for use up to 600 V

B2. Cable Accessories

B3. Stainless Steel Ties



C1. Wiring Duct

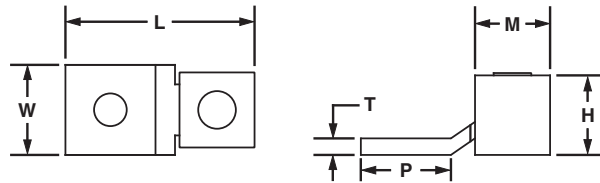

C2. Surface Raceway

Part Number	Copper Conductor Size Range	Current Rating (Amps)	Stud Hole Size (In.)	Hex Size (In.)	Figure Dimensions (In.)						Std. Pkg. Qty.
					L	W	H	T	P	M	
<b>CX35-36-CY</b>	#14 AWG – #6 AWG	35	3/16	**	1.02	0.38	0.48	0.07	0.44	0.38	100
<b>CX70-14-CY</b>	#14 AWG – #4 AWG, (2) #14 AWG, (2) #12 AWG	70	1/4	**	1.27	0.50	0.57	0.08	0.59	0.50	100
<b>CX125-14-QY*</b>	#4 AWG – 1/0 AWG	125	1/4	**	1.53	0.62	0.77	0.13	0.84	0.62	25
<b>CX225-56-QY*</b>	#2 AWG – 4/0 AWG	225	5/16	3/16	2.19	1.00	1.13	0.13	1.06	1.00	25

\*cULus Listed for use up to 600V.  
\*\*Uses slotted head set screw.

C4. Cable Management

D1. Terminals

**UL LISTED** **CSA CERTIFIED** **One-Hole, Straight Fixed Tongue, Tin-Plated Lug**

D2. Power Connectors

**For Use with Stranded Copper Code Conductors**

**Type CX-T**

- Made from high strength electrolytic copper to provide premium electrical and mechanical performance
- Tin-plated to inhibit corrosion
- Compact design saves space
- Wide wire range-taking capability minimizes inventory requirements
- Inspection window to visually assure full conductor insertion
- Plated steel set screw provides high strength, durable electrical contact between conductor and connector
- UL Listed and CSA Certified for use up to 600 V

D3. Grounding Connectors



E1. Labeling Systems

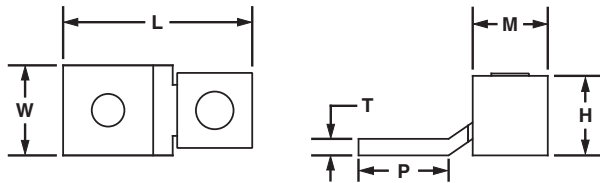

E2. Labels

Part Number	Copper Conductor Size Range	Current Rating (Amps)	Stud Hole Size (In.)	Hex Size (In.)	Figure Dimensions (In.)						Std. Pkg. Qty.
					L	W	H	T	P	M	
<b>CX35-36T-CY</b>	#14 AWG – #6 AWG	35	3/16	**	1.02	0.38	0.48	0.07	0.44	0.38	100
<b>CX70-14T-CY</b>	#14 AWG – #4 AWG, (2) #14 AWG, (2) #12 AWG	70	1/4	**	1.27	0.50	0.57	0.08	0.59	0.50	100
<b>CX125-56T-QY*</b>	#4 AWG – 1/0 AWG	125	5/16	**	1.53	0.62	0.77	0.13	0.84	0.62	25
<b>CX225-38T-QY*</b>	#2 AWG – 4/0 AWG	225	3/8	3/16	2.19	1.00	1.13	0.13	1.06	1.00	25
<b>CX225-56T-QY*</b>	#2 AWG – 4/0 AWG	225	5/16	3/16	2.19	1.00	1.13	0.13	1.06	1.00	25

\*cULus Listed for use up to 600V.  
\*\*Uses slotted head set screw.

E3. Pre-Printed & Write-On Markers

E4. Permanent Identification

E5. Lockout/Tagout & Safety Solutions

F. Index

**cUL<sup>US</sup> LISTED One-Hole, Straight Floating Tongue Lug**

**For Use with Stranded Copper Code Conductors**

**Type CS**

- Made from high strength electrolytic copper to provide premium electrical and mechanical performance
- Wide wire range-taking capability minimizes inventory requirements
- Internal pressure bar and V-bottom collar provide uniform clamping force on conductor to assure positive contact between conductor and connector
- Inspection window to visually assure full conductor insertion
- Plated steel set screw provides high strength, durable electrical contact between conductor and connector
- cULus Listed and CSA Certified for use up to 600 V



Part Number	Copper Conductor Size Range	Current Rating (Amps)	Stud Hole Size (In.)	Hex Size (In.)	Figure Dimensions (In.)						Std. Pkg. Qty.
					L	W	H	T	P	M	
<b>CS25-18-CY</b>	#14 AWG – #10 AWG	25	1/8	**	1.16	0.32	0.36	0.07	0.75	0.28	100
<b>CS35-36-CY</b>	#14 AWG – #6 AWG, (2) #10 AWG, (2) #12 AWG, (2) #14 AWG, (1) #10 AWG with (1) #12 AWG, (1) #12 AWG with (1) #14 AWG	50	3/16	**	1.14	0.38	0.49	0.07	0.60	0.43	100
<b>CSA70-14-CY</b>	#14 AWG – #4 AWG	70	1/4	**	1.30	0.50	0.64	0.08	0.71	0.50	100
<b>CS70-14-CY</b>	#12 AWG – #2 AWG, (1) #8 AWG with (1) #4 AWG, (1) #8 AWG with (1) #6 AWG	90	1/4	**	1.50	0.50	0.64	0.08	0.81	0.50	100
<b>CS125-14-QY</b>	#2 AWG – 1/0 AWG	125	1/4	**	1.94	0.62	0.88	0.13	1.00	0.60	25
<b>CS175-38-QY</b>	#4 AWG – 3/0 AWG	175	3/8	3/16	2.19	0.75	1.01	0.16	1.25	0.72	25
<b>CS225-56-QY</b>	#6 AWG – 4/0 AWG	225	5/16	3/16	2.38	1.00	1.13	0.13	1.19	0.94	25
<b>CS300-38-QY</b>	#1 AWG – 350 kcmil	300	3/8	5/16	3.19	1.00	1.39	0.19	1.63	1.23	25
<b>CS400-38-3Y</b>	1/0 AWG – 500 kcmil	400	3/8	5/16	3.88	1.50	1.61	0.19	2.19	1.41	3
<b>CS650-12-3Y</b>	600 kcmil – 1000 kcmil	650	1/2	3/8	5.13	2.00	2.32	0.25	2.82	1.85	3

\*\*Uses slotted head set screw.

A. System Overview

B1. Cable Ties

B2. Cable Accessories

B3. Stainless Steel Ties

C1. Wiring Duct

C2. Surface Raceway

C3. Abrasion Protection

C4. Cable Management

D1. Terminals

D2. Power Connectors

D3. Grounding Connectors

E1. Labeling Systems

E2. Labels

E3. Pre-Printed & Write-On Markers

E4. Permanent Identification

E5. Lockout/Tagout & Safety Solutions

F. Index

A. System Overview

B1. Cable Ties

B2. Cable Accessories

B3. Stainless Steel Ties

C1. Wiring Duct

C2. Surface Raceway

C3. Abrasion Protection

C4. Cable Management

D1. Terminals

D2. Power Connectors

D3. Grounding Connectors

E1. Labeling Systems

E2. Labels

E3. Pre-Printed & Write-On Markers

E4. Permanent Identification

E5. Lockout/Tagout & Safety Solutions

F. Index

**cUL<sup>US</sup> LISTED Two-Hole, Straight Floating Tongue Lug**

**For Use with Stranded Copper Code Conductors**

**Type CD**

- Made from high strength electrolytic copper to provide premium electrical and mechanical performance
- Wide wire range-taking capability minimizes inventory requirements
- Internal pressure bar and V-bottom collar provide uniform clamping force on conductor to assure positive contact between conductor and connector
- Inspection window to visually assure full conductor insertion
- Plated steel set screw provides high strength, durable electrical contact between conductor and connector
- cULus Listed and CSA Certified for use up to 600 V
- Available with NEMA hole sizes and spacing

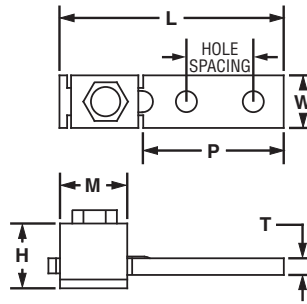

Part Number	Copper Conductor Size Range	Current Rating (Amps)	Stud Hole Size (In.)	Stud Hole Spacing (In.)	Hex Size (In.)	Figure Dimensions (In.)						Std. Pkg. Qty.
						L	W	H	T	P	M	
<b>CD35-36-QY</b>	#14 AWG – #6 AWG, (2) #10 AWG, (2) #12 AWG, (2) #14 AWG, (1) #10 AWG with (1) #12 AWG, (1) #12 AWG with (1) #14 AWG	50	3/16	1.00	**	2.13	0.38	0.49	0.07	1.60	0.43	25
<b>CD70-14-QY</b>	#12 AWG – #2 AWG (1) #8 AWG with (1) #4 AWG, (1) #8 AWG with (1) #6 AWG	90	1/4	1.00	**	2.26	0.50	0.64	0.09	1.63	0.50	25
<b>CD125-14-QY</b>	#2 – 1/0 AWG	125	1/4	1.00	**	2.94	0.62	0.88	0.13	1.88	0.60	25
<b>CD225-56-QY</b>	#6 AWG – 4/0 AWG	225	5/16	1.00	3/16	3.38	1.00	1.13	0.13	2.13	.94	25
<b>CD300-38-3Y</b>	#1 AWG – 350 kcmil	300	3/8	1.00	5/16	4.94	1.00	1.39	0.19	3.32	1.23	3
◆ <b>CD400-38-3Y</b>	1/0 AWG – 500 kcmil	400	3/8	1.75	5/16	5.62	1.50	1.61	0.19	3.57	1.41	3
◆ <b>CD650-12-3Y</b>	600 kcmil – 1000 kcmil	650	1/2	1.75	3/8	6.88	2.00	2.32	0.25	4.69	1.85	3

\*\*Uses slotted head set screw.  
◆NEMA hole sizes and spacing.





## One-Hole, Offset Floating Tongue Lug

**For Use with Stranded Copper Code Conductors**

### Type CB

- Made from high strength electrolytic copper to provide premium electrical and mechanical performance
- Wide wire range-taking capability minimizes inventory requirements
- Internal pressure bar and V-bottom collar provide uniform clamping force on conductor to assure positive contact between conductor and connector
- Inspection window to visually assure full conductor insertion
- Plated steel set screw provides high strength, durable electrical contact between conductor and connector
- cULus Listed and CSA Certified for use up to 600 V

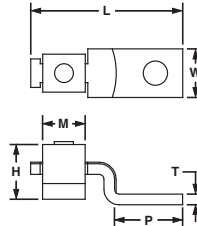

Part Number	Copper Conductor Size Range	Current Rating (Amps)	Stud Hole Size (In.)	Hex Size (In.)	Figure Dimensions (In.)						Std. Pkg. Qty.
					L	W	H	T	P	M	
<b>CB25-18-CY</b>	#14 AWG – #10 AWG	25	1/8	**	1.00	0.31	0.36	0.07	0.55	0.28	100
<b>CB35-36-CY</b>	#14 AWG – #6 AWG, (2) #10 AWG, (2) #12 AWG, (2) #14 AWG, (1) #10 AWG with (1) #12 AWG, (1) #12 AWG with (1) #14 AWG	50	3/16	**	1.24	0.39	0.49	0.07	0.59	0.43	100
<b>CBA70-14-CY</b>	#14 AWG – #4 AWG	70	1/4	**	1.31	0.47	0.64	0.08	0.61	0.50	100
<b>CB70-14-CY</b>	#8 AWG – #2 AWG, (1) #8 AWG with (1) #4 AWG, (1) #8 AWG with (1) #6 AWG	90	1/4	**	1.55	0.47	0.64	0.08	0.80	0.50	100
<b>CB125-14-QY</b>	#6 AWG – 1/0 AWG	125	1/4	**	1.98	0.62	0.88	0.10	1.02	0.60	25
<b>CB175-38-QY</b>	#4 AWG – 3/0 AWG	175	3/8	3/16	2.20	0.74	1.01	0.12	1.18	0.72	25
<b>CB225-56-QY</b>	#2 AWG – 4/0 AWG	225	5/16	3/16	2.55	0.99	1.13	0.12	1.33	0.94	25
<b>CB300-38-QY</b>	1/0 AWG – 350 kcmil	300	3/8	5/16	2.83	0.99	1.39	0.12	1.33	1.23	25
<b>CB400-38-3Y</b>	1/0 AWG – 500 kcmil	400	3/8	5/16	4.09	1.49	1.61	0.17	2.22	1.61	3
<b>CB650-12-3Y</b>	600 kcmil – 1000 kcmil	650	1/2	3/8	4.84	2.00	2.32	0.25	2.44	1.85	3

\*\*Uses slotted head set screw.

A. System Overview

B1. Cable Ties

B2. Cable Accessories

B3. Stainless Steel Ties

C1. Wiring Duct

C2. Surface Raceway

C3. Abrasion Protection

C4. Cable Management

D1. Terminals

D2. Power Connectors

D3. Grounding Connectors

E1. Labeling Systems

E2. Labels

E3. Pre-Printed & Write-On Markers

E4. Permanent Identification

E5. Lockout/Tagout & Safety Solutions

F. Index

A. System Overview

**cULus LISTED Two-Hole, Offset Floating Tongue Lug**

B1. Cable Ties

**For Use with Stranded Copper Code Conductors**

B2. Cable Accessories

**Type CO**

- Made from high strength electrolytic copper to provide premium electrical and mechanical performance
- Wide wire range-taking capability minimizes inventory requirements
- Internal pressure bar and V-bottom collar provide uniform clamping force on conductor to assure positive contact between conductor and connector
- Inspection window to visually assure full conductor insertion
- Plated steel set screw provides high strength, durable electrical contact between conductor and connector
- cULus Listed and CSA Certified for use up to 600 V
- Available with NEMA hole sizes and spacing

B3. Stainless Steel Ties

C1. Wiring Duct



C2. Surface Raceway

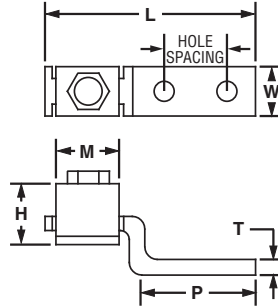

C3. Abrasion Protection

C4. Cable Management

Part Number	Copper Conductor Size Range	Current Rating (Amps)	Stud Hole Size (In.)	Stud Hole Spacing (In.)	Hex Size (In.)	Figure Dimensions (In.)						Std. Pkg. Qty.
						L	W	H	T	P	M	
<b>CO35-36-QY</b>	#14 AWG – #6 AWG, (2) #10 AWG, (2) #12 AWG, (2) #14 AWG, (1) #10 AWG with (1) #12 AWG, (1) #12 AWG with (1) #14 AWG	50	3/16	1.00	**	2.19	0.38	0.49	0.07	1.46	0.43	25
<b>CO70-14-QY</b>	#12 AWG – #1 AWG, (1) #8 AWG with (1) #4 AWG, (1) #8 AWG with (1) #6 AWG	90	1/4	1.00	**	2.50	0.50	0.64	0.09	1.60	0.50	25
<b>CO125-14-QY</b>	#2 AWG – 1/0 AWG	125	1/4	1.00	**	2.97	0.63	0.88	0.13	1.87	0.60	25
<b>CO225-56-QY</b>	#6 AWG – 4/0 AWG	225	5/16	1.00	3/16	3.62	1.00	1.13	0.13	2.28	0.94	25
<b>CO300-38-3Y</b>	#1 AWG – 350 kcmil	300	3/8	1.87	5/16	5.69	1.00	1.39	0.19	3.99	1.23	3
<b>CO400-38-3Y</b>	1/0 AWG – 500 kcmil	400	3/8	1.75	5/16	6.00	1.50	1.61	0.19	3.79	1.41	3
◆ <b>CO650-12-3Y</b>	600 kcmil – 1000 kcmil	650	1/2	1.75	3/8	6.25	2.00	2.32	0.25	3.68	1.85	3

\*\*Uses slotted head set screw.  
◆NEMA hole sizes and spacing.

E1. Labeling Systems

E2. Labels

E3. Pre-Printed & Write-On Markers

E4. Permanent Identification

E5. Lockout/Tagout & Safety Solutions

F. Index



## One-Hole, Single Barrel Lug

For Use with Stranded Aluminum or Copper Code Conductors

### Type LAMA

- Made from high strength, extruded aluminum alloy to provide premium electrical and mechanical performance
- Tin-plated to inhibit corrosion
- Compact design saves space
- Wide wire range-taking capability minimizes inventory requirements
- Inspection window to visually assure full conductor insertion
- Plated steel or aluminum set screw provides high strength, durable electrical contact between conductor and connector
- UL Listed and CSA Certified for use up to 600 V and UL temperature rated 90°C



Part Number	Conductor Size Range	Stud Hole Size (In.)	Hex Key Size (In.)	Figure Dimensions (In.)					Std. Pkg. Qty.
				L	W	H	T	P	
<b>LAMA6-14-QY</b>	#14 AWG – #6 AWG	1/4	**	1.06	0.50	0.50	0.09	0.68	25
<b>LAMA2-14-QY</b>	#14 AWG – #2 AWG	1/4	**	1.16	0.50	0.55	0.10	0.69	25
<b>LAMA1/0-14-QY</b>	#14 AWG – 1/0 AWG	1/4	**	1.47	0.62	0.79	0.19	0.85	25
<b>LAMA1/0-56-Q</b>	#14 AWG – 1/0 AWG	5/16	**	1.47	0.62	0.79	0.19	0.85	25
<b>LAMA2/0-14-QY</b>	#14 AWG – 2/0 AWG	1/4	3/16	1.47	0.62	0.79	0.19	0.85	25
<b>LAMA250-56-QY</b>	#6 AWG – 250 kcmil	5/16	5/16	2.01	1.00	1.13	0.25	0.99	25
<b>LAMA300-56-QY*</b>	#6 AWG – 300 kcmil	5/16	5/16	2.00	1.00	1.13	0.25	1.00	25
<b>LAMA350-38-QY</b>	#6 AWG – 350 kcmil	3/8	5/16	2.25	1.13	1.25	0.25	1.12	25
<b>LAMA500-38-6Y</b>	#4 AWG – 500 kcmil	3/8	1/2	2.81	1.50	1.56	0.31	1.59	6
<b>LAMA600-38-6Y</b>	#2 AWG – 600 kcmil	3/8	1/2	3.18	1.60	1.57	0.44	1.81	6
<b>LAMA600S-38-6Y*‡</b>	#4 AWG – 600 kcmil – (2) 1/0 AWG – 250 kcmil	3/8	3/8	2.81	1.38	1.81	0.31	1.50	6
<b>LAMA1000-58-6Y*</b>	500 kcmil – 1000 kcmil	5/8	3/8	3.50	1.75	1.94	0.50	1.88	6

The use of Panduit oxide inhibiting joint compound (CMP-100) is recommended for pad to pad and conductor connections. See page D2.155.

\*UL Listed and CSA Certified.

\*\*Uses slotted head set screw.

‡Accommodates two conductors for conductor range 1/0 AWG – 250 kcmil.

A. System Overview

B1. Cable Ties

B2. Cable Accessories

B3. Stainless Steel Ties

C1. Wiring Duct

C2. Surface Raceway

C3. Abrasion Protection

C4. Cable Management

D1. Terminals

D2. Power Connectors

D3. Grounding Connectors

E1. Labeling Systems

E2. Labels

E3. Pre-Printed & Write-On Markers

E4. Permanent Identification

E5. Lockout/Tagout & Safety Solutions

F. Index

A. System Overview

B1. Cable Ties

B2. Cable Accessories

B3. Stainless Steel Ties

C1. Wiring Duct

C2. Surface Raceway

C3. Abrasion Protection

C4. Cable Management

D1. Terminals

D2. Power Connectors

D3. Grounding Connectors

E1. Labeling Systems

E2. Labels

E3. Pre-Printed & Write-On Markers

E4. Permanent Identification

E5. Lockout/Tagout & Safety Solutions

F. Index

**UL LISTED** **Two-Hole, Single Barrel Lug**

**For Use with Stranded Aluminum or Copper Code Conductors**

**Type LAMB**

- Made from high strength, extruded aluminum alloy to provide premium electrical and mechanical performance
- Tin-plated to inhibit corrosion
- Compact design saves space
- Wide wire range-taking capability minimizes inventory requirements
- Inspection window to visually assure full conductor insertion
- Plated steel or aluminum set screw provides high strength, durable electrical contact between conductor and connector
- LAMLB provided with dual set screws for premium clamping of conductor to connector for heavy duty applications
- UL Listed and CSA Certified for use up to 600 V and UL temperature rated 90°C
- Available with NEMA hole sizes and spacing

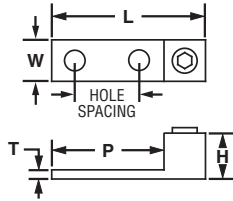

Figure 1

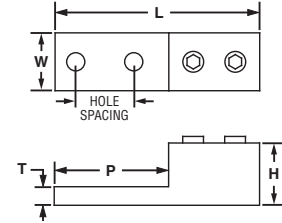

Figure 2

Part Number	Figure No.	Conductor Size Range	Stud Hole Size (In.)	Stud Hole Spacing (In.)	Hex Key Size (In.)	Figure Dimensions (In.)					Std. Pkg. Qty.
						L	W	H	T	P	
LAMB350-12-6Y	1	#6 AWG – 350 kcmil	1/2	1.75	5/16	4.19	1.13	1.28	0.28	3.05	6
LAMB600-12-3Y	1	#2 AWG – 600 kcmil	1/2	1.75	1/2	4.69	1.60	1.57	0.44	3.31	3
LAMLB1000-12-3*	2	500 – 1000 kcmil	1/2	1.75	1/2	6.19	1.63	1.88	0.56	3.44	3

The use of Panduit oxide inhibiting joint compound (CMP-100) is recommended for pad to pad and conductor connections. See page D2.155.

\*UL Listed and CSA Certified.  
uNEMA hole sizes and spacing.

**UL LISTED** **One-Hole, Two-Barrel Lug**

**For Use with Stranded Aluminum or Copper Code Conductors**

**Type LAM2A**

- Dual barrel provides termination of two conductors
- Made from high strength, extruded aluminum alloy to provide premium electrical and mechanical performance
- Tin-plated to inhibit corrosion
- Wide wire range-taking capability minimizes inventory requirements
- Inspection window to visually assure full conductor insertion
- Plated steel or aluminum set screw provides high strength, durable electrical contact between conductor and connector
- UL Listed and CSA Certified for use up to 600 V and UL temperature rated 90°C
- Available with NEMA hole sizes and spacing

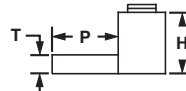
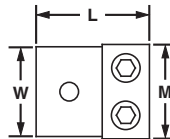

Part Number	Conductor Size Range	Stud Hole Size (In.)	Hex Key Size (In.)	Figure Dimensions (In.)						Std. Pkg. Qty.
				L	W	H	T	P	M	
LAM2A1/0-14-6Y	#14 AWG – 1/0 AWG	1/4	**	1.47	1.13	0.78	0.19	0.85	1.13	6
LAM2A2/0-14-6Y	#14 AWG – 2/0 AWG	1/4	3/16	1.47	1.20	0.78	0.19	0.85	1.20	6
LAM2A250-38-6Y	#6 AWG – 250 kcmil	3/8	3/8	2.56	1.50	1.19	0.25	1.56	1.64	6
LAM2A350-12-6Y	#6 AWG – 350 kcmil	1/2	5/16	2.87	1.73	1.25	0.25	1.74	1.91	6
LAM2A600-12-6Y*	#2 AWG – 600 kcmil	1/2	3/8	3.19	2.00	1.56	0.44	1.81	2.38	6
LAM2A1000-58-6Y*	500 kcmil – 1000 kcmil	5/8	3/8	3.50	3.50	1.94	0.50	1.88	3.50	6

The use of Panduit oxide inhibiting joint compound (CMP-100) is recommended for pad to pad and conductor connections. See page D2.155.

\*UL Listed and CSA Certified.

\*\*Uses slotted head set screw.



## One-Hole, Vertical Two-Barrel Lug

For Use with Stranded Aluminum or Copper Code Conductors

### Type LAM2SA

- Dual barrel provides termination of two conductors
- Made from high strength, extruded aluminum alloy to provide premium electrical and mechanical performance
- Tin-plated to inhibit corrosion
- Wide wire range-taking capability minimizes inventory requirements
- Inspection window to visually assure full conductor insertion
- Plated steel or aluminum set screw provides high strength, durable electrical contact between conductor and connector
- UL Listed and CSA Certified for use up to 600 V and UL temperature rated 90°C

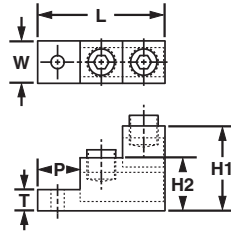

Part Number	Conductor Size Range	Stud Hole Size (In.)	Hex Key Size (In.)	Figure Dimensions (In.)						Std. Pkg. Qty.
				L	W	H1	H2	T	P	
LAM2SA300-56-3	#6 AWG – 300 kcmil	5/16	5/16	3.00	1.00	2.00	1.25	0.50	1.00	3

The use of Panduit oxide inhibiting joint compound (CMP-100) is recommended for pad to pad and conductor connections. See page D2.155.



## Two-Hole, Two-Barrel Lug

For Use with Stranded Aluminum or Copper Code Conductors

### Type LAM2B

- Dual barrel provides termination of two conductors
- Made from high strength, extruded aluminum alloy to provide premium electrical and mechanical performance
- Tin-plated to inhibit corrosion
- Wide wire range-taking capability minimizes inventory requirements
- Inspection window to visually assure full conductor insertion
- Plated steel or aluminum set screw provides high strength, durable electrical contact between conductor and connector
- LAM2LB connector provided with dual set screws for premium clamping of conductor to connector for heavy duty applications
- UL Listed for use up to 600 V and temperature rated 90°C
- Available with NEMA hole sizes and spacing



Figure 1

Figure 2

Part Number	Figure No.	Conductor Size Range	Stud Hole Size (In.)	Stud Hole Spacing (In.)	Hex Key Size (In.)	Figure Dimensions (In.)					Std. Pkg. Qty.
						L	W	H	T	P	
◆ LAM2B350-12-3Y	1	#6 AWG – 350 kcmil	1/2	1.75	5/16	4.19	1.91	1.28	0.25	3.06	3
◆ LAM2LB600-12-3*	2	#2 AWG – 600 kcmil	1/2	1.75	3/8	5.50	2.85	1.50	0.38	3.25	3
◆ LAM2LB1000-12-3*	2	500 – 1000 kcmil	1/2	1.75	1/2	6.19	3.48	1.88	0.56	3.44	3

The use of Panduit oxide inhibiting joint compound (CMP-100) is recommended for pad to pad and conductor connections. See page D2.155.

\*UL Listed and CSA Certified.

◆NEMA hole sizes and spacing.

A. System Overview

B1. Cable Ties

B2. Cable Accessories

B3. Stainless Steel Ties

C1. Wiring Duct

C2. Surface Raceway

C3. Abrasion Protection

C4. Cable Management

D1. Terminals

D2. Power Connectors

D3. Grounding Connectors

E1. Labeling Systems

E2. Labels

E3. Pre-Printed & Write-On Markers

E4. Permanent Identification

E5. Lockout/Tagout & Safety Solutions

F. Index

A. System Overview

B1. Cable Ties

B2. Cable Accessories

B3. Stainless Steel Ties

C1. Wiring Duct

C2. Surface Raceway

C3. Abrasion Protection

C4. Cable Management

D1. Terminals

D2. Power Connectors

D3. Grounding Connectors

E1. Labeling Systems

E2. Labels

E3. Pre-Printed & Write-On Markers

E4. Permanent Identification

E5. Lockout/Tagout & Safety Solutions

F. Index



## Two-Hole, Vertical Two-Barrel Lug

**For Use with Stranded Aluminum or Copper Code Conductors**

### Type LAM2SB

- Dual barrel provides termination of two conductors
- Vertical configuration saves space
- Made from high strength, extruded aluminum alloy to provide premium electrical and mechanical performance
- Tin-plated to inhibit corrosion
- Wide wire range-taking capability minimizes inventory requirements

- Inspection window to visually assure full conductor insertion
- Plated steel or aluminum set screw provides high strength, durable electrical contact between conductor and connector
- UL Listed and CSA Certified for use up to 600 V and UL temperature rated 90°C

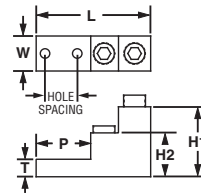

Figure 1

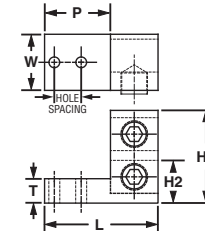

Figure 2

Part Number	Figure No.	Conductor Size Range	Stud Hole Size (In.)	Stud Hole Spacing (In.)	Hex Key Size (In.)	Figure Dimensions (In.)					Std. Pkg. Qty.	
						L	W	H1	H2	T		P
LAM2SB600-38-1Y*	1	#2 AWG – 600 kcmil	3/8	1.38	3/8	4.91	1.50	3.00	1.88	0.75	2.34	1
LAM2SB750-38-1Y*	1	1/0 AWG – 750 kcmil	3/8	1.38	3/8	4.91	1.50	3.00	1.88	0.75	2.34	1
LAM2SSB500-141Y	2	4/0 AWG – 500 kcmil	1/4	0.69	1/2	2.91	1.44	2.38	1.77	0.63	1.69	1

The use of Panduit oxide inhibiting joint compound (CMP-100) is recommended for pad to pad and conductor connections. See page D2.155.  
\*UL Listed and CSA Certified.



## Two-Hole, Three-Barrel Lug

**For Use with Stranded Aluminum or Copper Code Conductors**

### Type LAM3B

- Triple barrel provides termination of three conductors
- Made from high strength, extruded aluminum alloy to provide premium electrical and mechanical performance
- Tin-plated to inhibit corrosion
- Wide wire range-taking capability minimizes inventory requirements
- Inspection window to visually assure full conductor insertion
- Plated steel or aluminum set screw provides high strength, durable electrical contact between conductor and connector

- LAM3LB connector is provided with dual set screws to allow premium clamping of conductor to connector for heavy duty applications
- For use up to 600 V and temperature rated 90°C
- Available with NEMA hole sizes and spacing

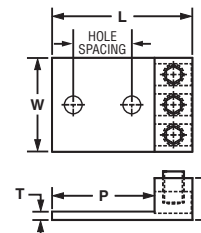

Figure 1

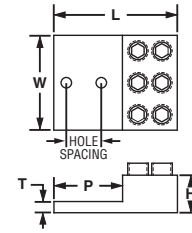

Figure 2

Part Number	Figure No.	Conductor Size Range	Stud Hole Size (In.)	Stud Hole Spacing (In.)	Hex Key Size (In.)	Figure Dimensions (In.)					Std. Pkg. Qty.
						L	W	H	T	P	
LAM3B1/0-38-6Y	1	#14 AWG – 1/0 AWG	3/8	1.00	**	2.91	2.00	0.88	0.25	2.16	6
◆ LAM3B3/0-12-3Y	1	#6 AWG – 3/0 AWG	1/2	1.75	1/4	4.25	2.81	1.19	0.31	3.25	3
◆ LAM3B250-12-1Y	1	#6 AWG – 250 kcmil	1/2	1.75	5/16	4.00	2.82	1.19	0.31	3.00	1
◆ LAM3B350-12-1Y	1	#6 AWG – 350 kcmil	1/2	1.75	5/16	4.50	3.50	1.38	0.31	3.25	1
◆ LAM3LB600-12-1	2	#2 AWG – 600 kcmil	1/2	1.75	3/8	5.50	4.32	1.50	0.38	3.25	1
◆ LAM3LB1000-121Y	2	500 kcmil – 1000 kcmil	1/2	1.75	1/2	6.19	5.27	1.88	0.56	3.44	1

The use of Panduit oxide inhibiting joint compound (CMP-100) is recommended for pad to pad and conductor connections. See page D2.155.

\*\*Uses slotted head set screw.

◆NEMA hole sizes and spacing.



## Four-Hole, Three-Barrel Lug

**For Use with Stranded Aluminum or Copper Code Conductors**

### Type LAM3D

- Triple barrel provides termination of three conductors
- Made from high strength, extruded aluminum alloy to provide premium electrical and mechanical performance
- Tin-plated to inhibit corrosion
- Wide wire range-taking capability minimizes inventory requirements
- Inspection window to visually assure full conductor insertion

- Plated steel or aluminum set screw provides high strength, durable electrical contact between conductor and connector
- LAM3LD connector is provided with dual set screws to allow premium clamping of conductor to connector for heavy duty applications
- For use up to 600 V and temperature rated 90°C
- Available with NEMA hole sizes and spacing

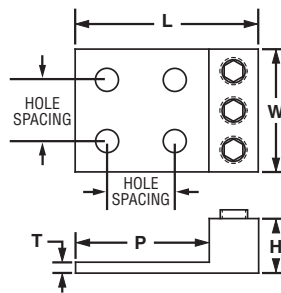

Figure 1

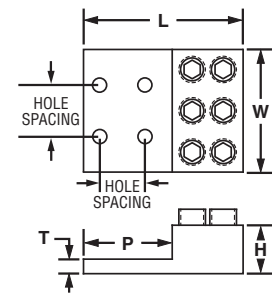

Figure 2

Part Number	Figure No.	Conductor Size Range	Stud Hole Size (In.)	Stud Hole Spacing (In.)	Hex Key Size (In.)	Figure Dimensions (In.)					Std. Pkg. Qty.
						L	W	H	T	P	
◆ LAM3D3/0-12-3Y	1	#6 AWG – 3/0 AWG	1/2	1.75	1/4	4.25	2.81	1.19	0.31	3.25	3
◆ LAM3D250-12-1Y	1	#6 AWG – 250 kcmil	1/2	1.75	5/16	4.25	3.00	1.19	0.31	3.25	1
◆ LAM3D350-12-1Y	1	#6 AWG – 350 kcmil	1/2	1.75	5/16	4.50	3.50	1.38	0.31	3.25	1
◆ LAM3LD600-12-1	2	#2 AWG – 600 kcmil	1/2	1.75	3/8	5.50	4.32	1.50	0.38	3.25	1
◆ LAM3LD1000-121Y	2	500 kcmil – 1000 kcmil	1/2	1.75	1/2	6.19	5.27	1.88	0.56	3.44	1

The use of Panduit oxide inhibiting joint compound (CMP-100) is recommended for pad to pad and conductor connections. See page D2.155.

◆NEMA hole sizes and spacing.

A.  
System  
Overview

B1.  
Cable  
Ties

B2.  
Cable  
Accessories

B3.  
Stainless  
Steel Ties

C1.  
Wiring  
Duct

C2.  
Surface  
Raceway

C3.  
Abrasion  
Protection

C4.  
Cable  
Management

D1.  
Terminals

D2.  
Power  
Connectors

D3.  
Grounding  
Connectors

E1.  
Labeling  
Systems

E2.  
Labels

E3.  
Pre-Printed  
& Write-On  
Markers

E4.  
Permanent  
Identification

E5.  
Lockout/  
Tagout  
& Safety  
Solutions

F.  
Index

A. System Overview



## Two-Hole, Vertical Four-Barrel Lug

**For Use with Stranded Aluminum or Copper Code Conductors**

B1. Cable Ties

### Type LAM4SB

- Four barrels provide termination of four conductors
- Vertical configuration saves space
- Made from high strength, extruded aluminum alloy to provide premium electrical and mechanical performance
- Tin-plated to inhibit corrosion

B2. Cable Accessories

- Wide wire range-taking capability minimizes inventory requirements
- Inspection window to visually assure full conductor insertion
- Plated steel or aluminum set screw provides high strength, durable electrical contact between conductor and connector
- UL Listed and CSA Certified for use up to 600 V and UL temperature rated 90°C

B3. Stainless Steel Ties



C1. Wiring Duct

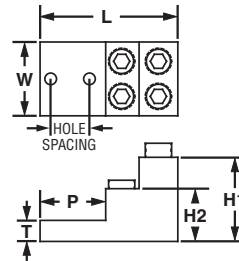

C2. Surface Raceway

C3. Abrasion Protection

Part Number	Conductor Size Range	Stud Hole Size (In.)	Stud Hole Spacing (In.)	Hex Key Size (In.)	Figure Dimensions (In.)						Std. Pkg. Qty.
					L	W	H1	H2	T	P	
LAM4SB600-38-1Y	#2 AWG – 600 kcmil	3/8	1.38	3/8	4.91	2.47	3.00	1.88	0.75	2.34	1
LAM4SB750-38-1Y	1/0 AWG – 750 kcmil	3/8	1.38	3/8	4.91	2.84	3.00	1.88	0.75	2.34	1

The use of Panduit oxide inhibiting joint compound (CMP-100) is recommended for pad to pad and conductor connections. See page D2.155.

C4. Cable Management



## Four-Hole, Four-Barrel Lug

**For Use with Stranded Aluminum or Copper Code Conductors**

D1. Terminals

### Type LAM4D

- Four barrels provide termination of four conductors
- Made from high strength, extruded aluminum alloy to provide premium electrical and mechanical performance
- Tin-plated to inhibit corrosion
- Wide wire range-taking capability minimizes inventory requirements
- Inspection window to visually assure full conductor insertion

- Plated steel or aluminum set screw provides high strength, durable electrical contact between conductor and connector
- LAM4LD connector is provided with dual set screws to allow premium clamping of conductor to connector for heavy duty applications
- For use up to 600 V and temperature rated 90°C
- Available with NEMA hole sizes and spacing

D2. Power Connectors

D3. Grounding Connectors

E1. Labeling Systems



E2. Labels

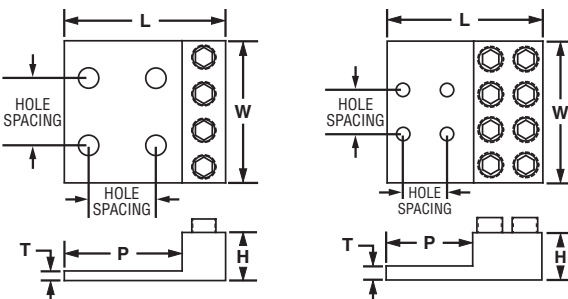

Figure 1

Figure 2

E3. Pre-Printed & Write-On Markers

E4. Permanent Identification

Part Number	Figure No.	Conductor Size Range	Stud Hole Size (In.)	Stud Hole Spacing (In.)	Hex Key Size (In.)	Figure Dimensions (In.)					Std. Pkg. Qty.
						L	W	H	T	P	
◆ LAM4D250-12-1Y	1	# 6 AWG – 250 kcmil	1/2	1.75	5/16	4.25	4.04	1.19	0.31	3.25	1
◆ LAM4D350-12-1Y	1	# 6 AWG – 350 kcmil	1/2	1.75	5/16	4.50	4.72	1.37	0.31	3.25	1
◆ LAM4LD600-12-1	2	#2 – 600 kcmil	1/2	1.75	3/8	5.50	5.31	1.50	0.38	3.25	1
◆ LAM4LD1000-12-1	2	350 – 1000 kcmil	1/2	1.75	3/8	6.19	7.11	1.88	0.56	3.44	1

The use of Panduit oxide inhibiting joint compound (CMP-100) is recommended for pad to pad and conductor connections. See page D2.155.

◆NEMA hole sizes and spacing.

F. Index



## Transformer Lug Kit

**For Use with Stranded Aluminum or Copper Code Conductors**

### Type KLM

- Kits include all of the connectors and hardware to make a complete transformer connection in a single convenient package
- Lugs are made from high strength, extruded aluminum alloy and are tin-plated to inhibit corrosion and oxidation
- Plated steel cap screws, belleville and flat washers, and hex nuts are provided to assure that terminal to bus connections are made using proper hardware resulting in true torque to pressure performance
- Hardware is packaged in a sealed plastic bag to prevent lost hardware prior to installation
- KLM6-800 and KLM350-800 kits include lugs that accommodate 750 kcmil conductors used with large transformers
- Lugs are UL Listed and CSA Certified for use up to 600 V and UL temperature rated 90°C



Part Number	Transformer KVA Rating	Aluminum Mechanical Lug		Conductor Size Range	Hardware (Sizes in Inches)					
		Part No.	Qty.		Hex Bolt Size	Qty.	Nut Size	Qty.	Washer Size	Qty.
KLM14-250Y	15 – 37.5 KVA 1PH 15 – 45 KVA 3PH	LAMA2-14	8	#14 – 2 AWG	1/4 – 20 x 3/4 HH	8	1/4 – 20 HN	8	1/4 FLAT	16
		LAMA250-56	4						#6 AWG – 250 kcmil	1/4 – 20 x 2 HH
KLM6-250Y	50 – 75 KVA 1 PH 75 – 112.5 KVA 3 PH	LAMA250-56	12	#6 AWG – 250 kcmil	1/4 – 20 x 3/4 HH 1/4 – 20 x 2 HH	8 8	1/4 – 20 HN	16	1/4 FLAT 1/4 CMP	32 16
KLM6-600Y	100 – 167 KVA 1PH 150 – 300 KVA 3 PH	LAMA250-56	3	#6 AWG – 250 kcmil #4 AWG – 600 kcmil	1/4 – 20 x 3/4 HH 3/8 – 16 x 2 HH	3 16	1/4 – 20 HN 3/8 – 16 HN	3 16	3/8 FLAT	32
		LAMA600-38	3						1/4 FLAT 3/8 CMP 1/4 CMP	6 16 3
KLM6-800Y	100 – 167 KVA 1 PH 150 – 300 KVA 3 PH	LAM2A350-12	6	#6 AWG – 350 kcmil 350 kcmil – 800 kcmil	1/2 – 13 x 2 HH 1/2 – 13 x 2 1/2 HH	5 6	1/2 – 13 HN	11	1/2 FLAT	22
		LAM2A800-58	7						1/2 FLAT 1/2 CMP	11
KLM350-800Y	500 KVA 3 PH	LAM2A800-58	15	350 kcmil – 800 kcmil	1/2 – 13 x 2 HH 1/2 – 13 x 2 1/2 HH	7 4	1/2 – 13 HN	11	1/2 FLAT 1/2 CMP	22 11

Suffix: HH = Hex Head; HN = Hex Nut; FLAT = Flat Washer; CMP = Compression Washer.

The use of Panduit oxide inhibiting joint compound (CMP-100) is recommended for pad to pad and conductor connections. See page D2.155.

A.  
System  
Overview

B1.  
Cable Ties

B2.  
Cable  
Accessories

B3.  
Stainless  
Steel Ties

C1.  
Wiring  
Duct

C2.  
Surface  
Raceway

C3.  
Abrasion  
Protection

C4.  
Cable  
Management

D1.  
Terminals

D2.  
Power  
Connectors

D3.  
Grounding  
Connectors

E1.  
Labeling  
Systems

E2.  
Labels

E3.  
Pre-Printed  
& Write-On  
Markers

E4.  
Permanent  
Identification

E5.  
Lockout/  
Tagout  
& Safety  
Solutions

F.  
Index

A. System Overview



## Splicer/Reducer

B1. Cable Ties

**For Use with Stranded Aluminum or Copper Code Conductors**

### Type SR

B2. Cable Accessories

- Made from high strength extruded aluminum alloy to provide premium electrical and mechanical performance
- Tin-plated to inhibit corrosion
- Rounded bottoms to facilitate taping

- Solid center barrier prevents contact of dissimilar metal conductors
- Wide wire range-taking capability minimizes inventory requirements
- UL Listed and CSA Certified for use up to 600 V and UL temperature rated 90°C

B3. Stainless Steel Ties

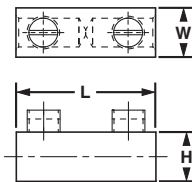

Figure 1

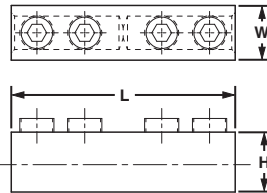

Figure 2

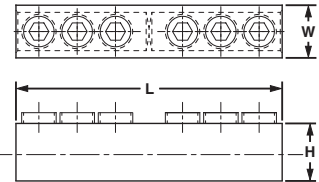

Figure 3

C1. Wiring Duct

C2. Surface Raceway

C3. Abrasion Protection

C4. Cable Management

D1. Terminals

D2. Power Connectors

D3. Grounding Connectors

E1. Labeling Systems

E2. Labels

E3. Pre-Printed & Write-On Markers

E4. Permanent Identification

E5. Lockout/Tagout & Safety Solutions

F. Index

Part Number	Figure No.	Conductor Size Range		Figure Dimensions (In.)			Hex Key Size (In.)	Std. Pkg. Qty.
		Max.	Min.	L	W	H		
SR-2-XY	1	#2 AWG STR, #10 AWG SOL	#14 AWG STR, #14 AWG SOL	1.38	0.50	0.56	**	10
SR-0-XY	1	1/0 AWG STR, #10 AWG SOL	#14 AWG STR, #14 AWG SOL	1.91	0.75	0.75	**	10
SR-4/0-XY	1	4/0 AWG	#6 AWG	2.31	1.00	1.13	5/16	10
SR-250-XY	2	250 kcmil	#6 AWG	3.94	1.00	1.13	5/16	10
SR-350-XY	2	350 kcmil	#6 AWG	4.19	1.13	1.19	5/16	10
SR-500-3Y	2	500 kcmil	3/0 AWG	5.00	1.37	1.40	3/8	3
SR-750-1Y	2	750 kcmil	250 kcmil	6.25	1.63	1.75	1/2	1
SR-1000-1Y	3	1000 kcmil	500 kcmil	8.69	1.72	1.88	9/16	1

The use of Panduit oxide inhibiting joint compound (CMP-100) is recommended. See page D2.155.

\*\*Uses slotted screws.



## Multi-Tap Connector with Clear Insulation, Single-Sided

For Use with Aluminum or Copper Code Conductors

### Type PCSB-S

- Flexible design – can be used as a tap, splice, or dead end connector
- Body made from high strength, extruded aluminum alloy to provide premium electrical and mechanical performance
- Insulated with clear PVC to eliminate the need for taping and allow for visual inspection of the complete conductor insertion
- Each port pre-filled with oxide inhibiting joint compound seals out air and moisture to deter surface oxidation
- Wide wire range-taking capability minimizes inventory requirements
- Plated steel or aluminum set screw provides high strength, durable electrical contact between conductor and connector
- UL Listed and CSA Certified for use up to 600 V and temperature rated 90°C\*

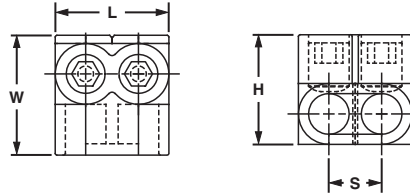

Part Number	Conductor Size Range	No. of Ports	Figure Dimensions (in.)				Hex Key Size (in.)	Std. Pkg. Qty.	
			L	W	H	S			
PCSB4-2S-12Y	#4 – #14 AWG STR #10 – #14 AWG SOL	2	1.23	1.25	1.25	0.53	1/8	12	
PCSB4-3S-12Y		3	1.76	1.25	1.25	0.53	1/8	12	
PCSB4-4S-6Y		4	2.29	1.25	1.25	0.53	1/8	6	
PCSB4-5S-6Y		5	2.82	1.25	1.25	0.53	1/8	6	
PCSB4-6S-6Y		6	3.35	1.25	1.25	0.53	1/8	6	
PCSB4-10S-4Y		10	5.47	1.25	1.25	0.53	1/8	4	
PCSB4-12S-3Y		12	6.53	1.25	1.25	0.53	1/8	3	
PCSB4-14S-2Y		14	7.59	1.25	1.25	0.53	1/8	2	
PCSB2/0-2S-6		2/0 – #14 AWG STR #10 – #14 AWG SOL	2	1.52	1.31	1.38	0.67	3/16	6
PCSB2/0-3S-6Y			3	2.19	1.31	1.38	0.67	3/16	6
PCSB2/0-4S-6Y	4		2.86	1.31	1.38	0.67	3/16	6	
PCSB2/0-5S-4Y	5		3.53	1.31	1.38	0.67	3/16	4	
PCSB2/0-6S-4Y	6		4.20	1.31	1.38	0.67	3/16	4	
PCSB2/0-8S-3Y	8		5.55	1.31	1.38	0.67	3/16	3	
PCSB2/0-10S-2Y	10		6.89	1.31	1.38	0.67	3/16	2	
PCSB2/0-12S-1Y	12		8.24	1.31	1.38	0.67	3/16	1	
PCSB2/0-14S-1Y	14		9.58	1.31	1.38	0.67	3/16	1	
PCSB250-2S-6Y	250 kcmil – #10 AWG STR		2	2.03	2.00	2.13	0.94	5/16	6
PCSB250-3S-6Y			3	2.97	2.00	2.13	0.94	5/16	6
PCSB250-4S-6Y			4	3.91	2.00	2.13	0.94	5/16	6
PCSB250-5S-4Y			5	4.84	2.00	2.13	0.94	5/16	4
PCSB250-6S-4Y			6	5.78	2.00	2.13	0.94	5/16	4
PCSB250-8S-3Y		8	7.66	2.00	2.13	0.94	5/16	3	
PCSB250-10S-2Y		10	9.53	2.00	2.13	0.94	5/16	2	
PCSB250-12S-2Y		12	11.41	2.00	2.13	0.94	5/16	2	
PCSB250-14S-1Y		14	13.29	2.00	2.13	0.94	5/16	1	
PCSB350-2S-4Y		350 kcmil – #10 AWG STR	2	2.17	2.25	2.50	1.00	5/16	4
PCSB350-3S-4Y			3	3.17	2.25	2.50	1.00	5/16	4
PCSB350-4S-3Y			4	4.17	2.25	2.50	1.00	5/16	3
PCSB350-5S-3Y			5	5.17	2.25	2.50	1.00	5/16	3
PCSB350-6S-2Y			6	6.17	2.25	2.50	1.00	5/16	2
PCSB350-8S-2Y	8		8.17	2.25	2.50	1.00	5/16	2	
PCSB350-10S-2Y	10		10.17	2.25	2.50	1.00	5/16	2	
PCSB350-12S-1Y	12		12.17	2.25	2.50	1.00	5/16	1	
PCSB350-14S-1Y	14		14.17	2.25	2.50	1.00	5/16	1	
PCSB600-2S-4Y	600 kcmil – #6 AWG STR		2	2.72	2.25	2.75	1.28	3/8	4
PCSB600-3S-3Y			3	4.00	2.25	2.75	1.28	3/8	3
PCSB600-4S-2Y			4	5.28	2.25	2.75	1.28	3/8	2
PCSB600-5S-2Y			5	6.56	2.25	2.75	1.28	3/8	2
PCSB600-6S-2Y			6	7.84	2.25	2.75	1.28	3/8	2
PCSB600-8S-2Y		8	10.41	2.25	2.75	1.28	3/8	2	
PCSB600-10S-1Y		10	12.97	2.25	2.75	1.28	3/8	1	
PCSB600-12S-1Y		12	15.93	2.25	2.75	1.28	3/8	1	
PCSB600-14S-1Y		14	18.09	2.25	2.75	1.28	3/8	1	
PCSB750-2S-1		750 kcmil – #2 AWG STR	2	2.88	2.63	3.00	1.38	3/8	1

\*PCSB750-2S-1 is not UL Listed or CSA Certified.

A. System Overview

B1. Cable Ties

B2. Cable Accessories

B3. Stainless Steel Ties

C1. Wiring Duct

C2. Surface Raceway

C3. Abrasion Protection

C4. Cable Management

D1. Terminals

D2. Power Connectors

D3. Grounding Connectors

E1. Labeling Systems

E2. Labels

E3. Pre-Printed & Write-On Markers

E4. Permanent Identification

E5. Lockout/Tagout & Safety Solutions

F. Index

A. System Overview



## Multi-Tap Connector with Clear Insulation, Double-Sided

B1. Cable Ties

**For Use with Aluminum or Copper Code Conductors**

### Type PCSB

- Flexible design – can be used as a tap, splice, or dead end connector
- Body made from high strength, extruded aluminum alloy to provide premium electrical and mechanical performance
- Insulated with clear PVC to eliminate the need for taping and allow for visual inspection of the complete conductor insertion
- Each port pre-filled with oxide inhibiting joint compound seals out air and moisture to deter surface oxidation
- Wide wire range-taking capability minimizes inventory requirements
- Dual-sided entry allows offset and opposite entry for primary and secondary conductors
- Plated steel or aluminum set screw provides high strength, durable electrical contact between conductor and connector
- UL Listed and CSA Certified for use up to 600 V and temperature rated 90°C

B2. Cable Accessories

B3. Stainless Steel Ties

C1. Wiring Duct

C2. Surface Raceway

C3. Abrasion Protection



C4. Cable Management

D1. Terminals

D2. Power Connectors

D3. Grounding Connectors

E1. Labeling Systems

E2. Labels

E3. Pre-Printed & Write-On Markers

E4. Permanent Identification

E5. Lockout/Tagout & Safety Solutions

F. Index

Part Number	Conductor Size Range	No. of Ports	Figure Dimensions (in.)				Hex Key Size (in.)	Std. Pkg. Qty.	
			L	W	H	S			
<b>PCSB4-2-12Y</b>	#4 – #14 AWG STR #10 – #14 AWG SOL	2	1.23	1.50	1.25	0.53	1/8	12	
<b>PCSB4-3-12Y</b>		3	1.76	1.50	1.25	0.53	1/8	12	
<b>PCSB4-4-6Y</b>		4	2.29	1.50	1.25	0.53	1/8	6	
<b>PCSB4-5-6Y</b>		5	2.82	1.50	1.25	0.53	1/8	6	
<b>PCSB4-6-6Y</b>		6	3.35	1.50	1.25	0.53	1/8	6	
<b>PCSB4-8-4Y</b>		8	4.41	1.50	1.25	0.53	1/8	4	
<b>PCSB4-10-4Y</b>		10	5.47	1.50	1.25	0.53	1/8	4	
<b>PCSB4-12-3Y</b>		12	6.53	1.50	1.25	0.53	1/8	3	
<b>PCSB4-14-2Y</b>		14	7.59	1.50	1.25	0.53	1/8	2	
<b>PCSB2/0-2-12</b>		2/0 – #14 AWG STR #10 – #14 AWG SOL	2	1.52	1.56	1.38	0.67	3/16	12
<b>PCSB2/0-3-6</b>			3	2.19	1.56	1.38	0.67	3/16	6
<b>PCSB2/0-4-6</b>			4	2.86	1.56	1.38	0.67	3/16	6
<b>PCSB2/0-5-6</b>			5	3.53	1.56	1.38	0.67	3/16	6
<b>PCSB2/0-6-6</b>			6	4.20	1.56	1.38	0.67	3/16	6
<b>PCSB2/0-8-4</b>	8		5.55	1.56	1.38	0.67	3/16	4	
<b>PCSB2/0-10-2Y</b>	10		6.89	1.56	1.38	0.67	3/16	2	
<b>PCSB2/0-12-2Y</b>	12		8.24	1.56	1.38	0.67	3/16	2	
<b>PCSB2/0-14-1Y</b>	14		9.58	1.56	1.38	0.67	3/16	1	
<b>PCSB250-2-6Y</b>	250 kcmil – #10 AWG STR		2	2.03	2.63	2.13	0.94	5/16	6
<b>PCSB250-3-6Y</b>		3	2.97	2.63	2.13	0.94	5/16	6	
<b>PCSB250-4-6Y</b>		4	3.91	2.63	2.13	0.94	5/16	6	
<b>PCSB250-5-4Y</b>		5	4.84	2.63	2.13	0.94	5/16	4	
<b>PCSB250-6-4Y</b>		6	5.78	2.63	2.13	0.94	5/16	4	
<b>PCSB250-8-3Y</b>		8	7.66	2.63	2.13	0.94	5/16	3	
<b>PCSB250-10-2Y</b>		10	9.53	2.63	2.13	0.94	5/16	2	
<b>PCSB250-12-2Y</b>		12	11.41	2.63	2.13	0.94	5/16	2	
<b>PCSB250-14-1Y</b>		14	13.29	2.63	2.13	0.94	5/16	1	

‡‡Not UL Listed or CSA Certified.



## Multi-Tap Connector with Clear Insulation, Double-Sided (continued)

Part Number	Conductor Size Range	No. of Ports	Figure Dimensions (In.)				Hex Key Size (In.)	Std. Pkg. Qty.
			L	W	H	S		
<b>PCSB350-2-4</b>	350 kcmil – #10 AWG STR #10 AWG SOL	2	2.17	3.00	2.50	1.00	3/8	4
PCSB350-3-4		3	3.17	3.00	2.50	1.00	3/8	4
PCSB350-4-3		4	4.17	3.00	2.50	1.00	3/8	3
PCSB350-5-3		5	5.17	3.00	2.50	1.00	3/8	3
PCSB350-6-2		6	6.17	3.00	2.50	1.00	3/8	2
PCSB350-8-2		8	8.17	3.00	2.50	1.00	3/8	2
PCSB350-10-2Y		10	10.17	3.00	2.50	1.00	5/16	2
PCSB350-12-1Y		12	12.17	3.00	2.50	1.00	5/16	1
PCSB350-14-1Y		14	14.17	3.00	2.50	1.00	5/16	1
PCSB600-2-4Y		600 kcmil – #6 AWG STR	2	2.72	3.00	2.75	1.28	3/8
PCSB600-3-3Y	3		4.00	3.00	2.75	1.28	3/8	3
PCSB600-4-2Y	4		5.28	3.00	2.75	1.28	3/8	2
PCSB600-5-2	5		6.56	3.00	2.75	1.28	3/8	2
PCSB600-6-2Y	6		7.84	3.00	2.75	1.28	3/8	2
PCSB600-8-2Y	8		10.41	3.00	2.75	1.28	3/8	2
PCSB600-10-1Y	10		12.97	3.00	2.75	1.28	3/8	1
PCSB600-12-1Y	12		15.53	3.00	2.75	1.28	3/8	1
PCSB600-14-1Y	14		18.09	3.00	2.75	1.28	3/8	1
PCSB750-2-2Y‡‡	750 kcmil – #2 AWG STR		2	2.88	3.38	3.00	1.38	3/8
PCSB750-3-2Y‡‡		3	4.25	3.38	3.00	1.38	3/8	2
PCSB750-4-2Y‡‡		4	5.63	3.38	3.00	1.38	3/8	2
PCSB750-5-1Y‡‡		5	7.00	3.38	3.00	1.38	3/8	1
PCSB750-6-1Y‡‡		6	8.38	3.38	3.00	1.38	3/8	1
PCSB750-8-1Y‡‡		8	11.13	3.38	3.00	1.38	3/8	1
PCSB750-10-1Y‡‡		10	13.88	3.38	3.00	1.38	3/8	1

‡‡Not UL Listed or CSA Certified.

A.  
System  
Overview

B1.  
Cable Ties

B2.  
Cable  
Accessories

B3.  
Stainless  
Steel Ties

C1.  
Wiring  
Duct

C2.  
Surface  
Raceway

C3.  
Abrasion  
Protection

C4.  
Cable  
Management

D1.  
Terminals

D2.  
Power  
Connectors

D3.  
Grounding  
Connectors

E1.  
Labeling  
Systems

E2.  
Labels

E3.  
Pre-Printed  
& Write-On  
Markers

E4.  
Permanent  
Identification

E5.  
Lockout/  
Tagout  
& Safety  
Solutions

F.  
Index

A. System Overview



## In-Line Splicer/Reducer with Clear Insulation

B1. Cable Ties

### For Use with Aluminum or Copper Code Conductors

#### Type PISR

- Flexible design – can be used as a splice or reducer
- Dual rated for use with copper or aluminum conductors
- Made from high strength, extruded aluminum alloy to provide premium electrical and mechanical performance
- Insulated with clear PVC to eliminate the need for taping and allow for visual inspection of the complete conductor insertion
- Each port pre-filled with oxide inhibiting joint compound seals out air and moisture to deter surface oxidation
- Wide wire range-taking capability minimizes inventory requirements
- Plated steel or aluminum set screw provides high strength, durable electrical contact between conductor and connector
- UL Listed and CSA Certified for use up to 600 V and UL temperature rated 90°C

B2. Cable Accessories

B3. Stainless Steel Ties

C1. Wiring Duct

C2. Surface Raceway

C3. Abrasion Protection

C4. Cable Management

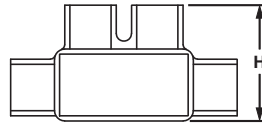
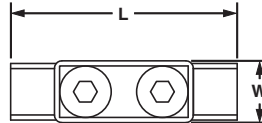

D1. Terminals

D2. Power Connectors

D3. Grounding Connectors

E1. Labeling Systems

E2. Labels

E3. Pre-Printed & Write-On Markers

E4. Permanent Identification

E5. Lockout/Tagout & Safety Solutions

F. Index

Part Number	Conductor Size Range	Figure Dimensions (In.)			Std. Pkg. Qty.
		L	W	H	
<b>PISR2-1</b>	#2 AWG STR – #14 AWG STR, #8 AWG SOL – #10 AWG SOL	2.38	0.75	1.25	1
<b>PISR1/0-1</b>	1/0 AWG STR – #14 AWG STR, #8 AWG SOL – #14 AWG SOL	2.91	0.95	1.41	1
<b>PISR250-1</b>	250 kcmil – #10 AWG STR, #8 AWG SOL – #10 AWG SOL	4.00	1.25	2.24	1
<b>PISR350-1</b>	350 kcmil – #10 AWG STR, #8 AWG SOL – #10 AWG SOL	4.63	1.40	2.34	1
<b>PISR500-1</b>	500 kcmil – #6 AWG STR	5.25	1.72	2.63	1



## Multi-Tap Connector with Clear Insulation, Single-Sided, with Mounting Holes

For Use with Aluminum or Copper Code Conductors

### Type PCSBMT-S

- Flexible design – can be used as a tap, splice, or dead end connector
- Body made from high strength, extruded aluminum alloy to provide premium electrical and mechanical performance
- Two isolated mounting holes at either end of connector facilitate direct mounting using 1/4" bolts
- Insulated with clear PVC to eliminate the need for taping and allow for visual inspection of the complete conductor insertion
- Each port pre-filled with oxide inhibiting joint compound seals out air and moisture to deter surface oxidation
- Wide wire range-taking capability minimizes inventory requirements
- Plated steel or aluminum set screw provides high strength, durable electrical contact between conductor and connector
- UL Listed and CSA Certified for use up to 600 V and temperature rated 90°C

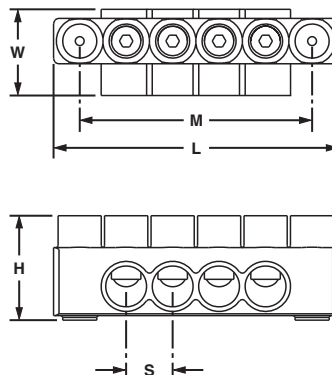

Part Number	Conductor Size Range	No. of Ports	Figure Dimensions (In.)					Mounting Hole Size (In.)	Hex Key Size (In.)	Std. Pkg. Qty.
			L	W	H	S	M			
PCSBMT2/0-4S-3Y	2/0 – #14 AWG STR #10 – #14 AWG SOL	4	4.20	1.31	1.50	0.67	3.61	1/4	3/16	3
PCSBMT2/0-6S-2Y		6	5.55	1.31	1.50	0.67	4.96	1/4	3/16	2
PCSBMT2/0-8S-2Y		8	6.89	1.31	1.50	0.67	6.30	1/4	3/16	2
PCSBMT2/0-10S2Y		10	8.24	1.31	1.50	0.67	7.65	1/4	3/16	2
PCSBMT2/0-12S1Y		12	9.58	1.31	1.50	0.67	8.99	1/4	3/16	1
PCSBMT250-4S-2Y	250 kcmil – #10 AWG STR	4	5.78	2.00	2.25	0.94	4.94	1/4	5/16	2
PCSBMT250-6S-2Y		6	7.66	2.00	2.25	0.94	6.82	1/4	5/16	2
PCSBMT250-8S-2Y		8	9.53	2.00	2.25	0.94	8.69	1/4	5/16	2
PCSBMT250-10S2Y		10	11.41	2.00	2.25	0.94	10.57	1/4	5/16	2
PCSBMT250-12S1Y		12	13.29	2.00	2.25	0.94	12.45	1/4	5/16	1
PCSBMT350-4S-2Y	350 kcmil – #10 AWG STR	4	6.17	2.25	2.63	1.00	5.25	1/4	5/16	2
PCSBMT350-6S-2Y		6	8.17	2.25	2.63	1.00	7.25	1/4	5/16	2
PCSBMT350-8S-2Y		8	10.17	2.25	2.63	1.00	9.25	1/4	5/16	2
PCSBMT350-10S1Y		10	12.17	2.25	2.63	1.00	11.25	1/4	5/16	1
PCSBMT350-12S1Y		12	14.17	2.25	2.63	1.00	13.25	1/4	5/16	1
PCSBMT600-4S-2Y	600 kcmil – #6 AWG STR	4	7.84	2.25	2.88	1.28	6.65	1/4	3/8	2
PCSBMT600-6S-2Y		6	10.41	2.25	2.88	1.28	9.22	1/4	3/8	2
PCSBMT600-8S-2Y		8	12.97	2.25	2.88	1.28	11.78	1/4	3/8	2
PCSBMT600-10S1Y		10	15.53	2.25	2.88	1.28	14.34	1/4	3/8	1
PCSBMT600-12S1Y		12	18.09	2.25	2.88	1.28	16.90	1/4	3/8	1

A. System Overview

B1. Cable Ties

B2. Cable Accessories

B3. Stainless Steel Ties

C1. Wiring Duct

C2. Surface Raceway

C3. Abrasion Protection

C4. Cable Management

D1. Terminals

D2. Power Connectors

D3. Grounding Connectors

E1. Labeling Systems

E2. Labels

E3. Pre-Printed & Write-On Markers

E4. Permanent Identification

E5. Lockout/Tagout & Safety Solutions

F. Index

A. System Overview



## Multi-Tap Connector with Clear Insulation, Double-Sided, with Mounting Holes

B1. Cable Ties

**For Use with Aluminum or Copper Code Conductors**

### Type PCSBMT

- Flexible design – can be used as a tap, splice, or dead end connector
- Body made from high strength, extruded aluminum alloy to provide premium electrical and mechanical performance
- Two isolated mounting holes at either end of connector facilitate direct mounting using 1/4" bolts
- Insulated with clear PVC to eliminate the need for taping and allow for visual inspection of the complete conductor insertion
- Each port pre-filled with oxide inhibiting joint compound seals out air and moisture to deter surface oxidation
- Wide wire range-taking capability minimizes inventory requirements
- Dual-sided entry allows offset and opposite entry for primary and secondary conductors
- Plated steel or aluminum set screw provides high strength, durable electrical contact between conductor and connector
- UL Listed and CSA Certified for use up to 600 V and temperature rated 90°C

C1. Wiring Duct

C2. Surface Raceway

C3. Abrasion Protection

C4. Cable Management

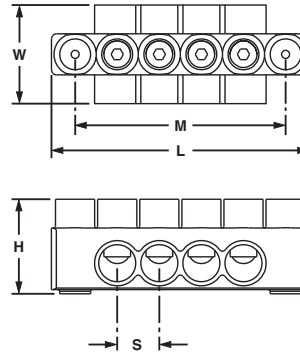

Part Number	Conductor Size Range	No. of Ports	Figure Dimensions (In.)					Mounting Hole Size (In.)	Hex Key Size (In.)	Std. Pkg. Qty.
			L	W	H	S	M			
PCSBMT2/0-4-3Y	2/0 – #14 AWG STR, #10 – #14 AWG SOL	4	4.20	1.56	1.50	0.67	3.61	1/4	3/16	3
PCSBMT2/0-6-2Y		6	5.55	1.56	1.50	0.67	4.96	1/4	3/16	2
PCSBMT2/0-8-2Y		8	6.89	1.56	1.50	0.67	6.30	1/4	3/16	2
PCSBMT2/0-10-2Y		10	8.24	1.56	1.50	0.67	7.65	1/4	3/16	2
PCSBMT2/0-12-1Y		12	9.58	1.56	1.50	0.67	8.99	1/4	3/16	1
PCSBMT250-4-2Y		250 kcmil – #10 AWG STR	4	5.78	2.63	2.26	0.94	4.94	1/4	5/16
PCSBMT250-6-2Y	6		7.66	2.63	2.26	0.94	6.82	1/4	5/16	2
PCSBMT250-8-2Y	8		9.53	2.63	2.26	0.94	8.69	1/4	5/16	2
PCSBMT250-10-2Y	10		11.41	2.63	2.26	0.94	10.57	1/4	5/16	2
PCSBMT250-12-1Y	12		13.29	2.63	2.26	0.94	12.45	1/4	5/16	1
PCSBMT350-4-2Y	350 kcmil – #10 AWG STR		4	6.17	3.00	2.63	1.00	5.25	1/4	5/16
PCSBMT350-6-2Y		6	8.17	3.00	2.63	1.00	7.25	1/4	5/16	2
PCSBMT350-8-2Y		8	10.17	3.00	2.63	1.00	9.25	1/4	5/16	2
PCSBMT350-10-1Y		10	12.17	3.00	2.63	1.00	11.25	1/4	5/16	1
PCSBMT350-12-1Y		12	14.17	3.00	2.63	1.00	13.25	1/4	5/16	1
PCSBMT600-4-2Y		600 kcmil – #6 AWG STR	4	7.84	3.00	2.88	1.28	6.65	1/4	3/8
PCSBMT600-6-2Y	6		10.41	3.00	2.88	1.28	9.22	1/4	3/8	2
PCSBMT600-8-2Y	8		12.97	3.00	2.88	1.28	11.78	1/4	3/8	2
PCSBMT600-10-1Y	10		15.53	3.00	2.88	1.28	14.34	1/4	3/8	1
PCSBMT600-12-1Y	12		18.09	3.00	2.88	1.28	16.90	1/4	3/8	1



## Belleville Compression Washers

### Type CW

- Conical spring washer for use when assembling aluminum connectors to copper and/or steel pads, compensates for differing rates of thermal expansion to keep hardware assembly from loosening

- For assembly information, see page D2.158
- Made from hardened steel to provide high strength
- Cadmium-plated to inhibit corrosion



Part Number	Stud Hole Size (In.)	Figure Dimensions (In.)			Std. Pkg. Qty.
		D	H	T	
CW-14-L	1/4	0.68	0.09	0.05	50
CW-56-L	5/16	0.81	0.08	0.06	50
CW-38-L	3/8	0.93	0.10	0.07	50
CW-12-Q	1/2	1.18	0.12	0.09	25
CW-58-Q	5/8	1.49	0.15	0.12	25

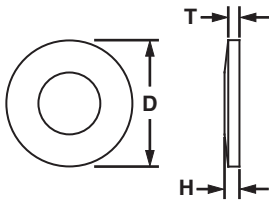

## Joint Compounds

### For Use with Aluminum Connectors

### Type CMP

- Oxide inhibitor for compression conductor connections lowers electrical resistance of compression joint while sealing out air and moisture to prevent the formation of surface oxides

- Wide operating temperature range; can be used in a wide range of electrical and environmental conditions
- Packaged in convenient dispenser bottles



Part Number	Description	Std. Pkg. Qty.
CMP-100-1	Contact aid for pad-to-pad or thread-to-thread aluminum connections, 8 oz. Operating temperature range -60°F (-51°C) to 400°F (204°C).	1

A.  
System  
Overview

B1.  
Cable Ties

B2.  
Cable  
Accessories

B3.  
Stainless  
Steel Ties

C1.  
Wiring  
Duct

C2.  
Surface  
Raceway

C3.  
Abrasion  
Protection

C4.  
Cable  
Management

D1.  
Terminals

D2.  
Power  
Connectors

D3.  
Grounding  
Connectors

E1.  
Labeling  
Systems

E2.  
Labels

E3.  
Pre-Printed  
& Write-On  
Markers

E4.  
Permanent  
Identification

E5.  
Lockout/  
Tagout  
& Safety  
Solutions

F.  
Index

A.  
System  
Overview

## Guidelines for Installing Aluminum Mechanical Connectors

B1.  
Cable Ties

B2.  
Cable  
Accessories

B3.  
Stainless  
Steel Ties



### 1. Select the correct connector for your application.

- Always use an aluminum conductor with an aluminum connector
- Verify that the connector is marked for the conductor size and type that you are using

C1.  
Wiring  
Duct

C2.  
Surface  
Raceway

C3.  
Abrasion  
Protection



### 2. Remove the insulation from insulated cable.

- See page D3.38 for Panduit cable stripping tools
- Use care to avoid nicking the conductor strands
- Strip the insulation to the proper length as listed in the installation instructions provided with Panduit connectors

C4.  
Cable  
Management

D1.  
Terminals

D2.  
Power  
Connectors



### 3. Clean the exposed conductor using a wire brush or an emery cloth.

- In a similar manner, clean an unplated connector pad and the surface to which the connector will be attached
- Solvent should be used to clean plated parts that are dirty, but the plating should never be disturbed with abrasives

D3.  
Grounding  
Connectors

E1.  
Labeling  
Systems

E2.  
Labels



### 4. Apply Panduit joint compound to the clean conductor for mechanical connector applications (see page D2.155).

- Joint compound will deter the formation of surface oxides after installation
- Aluminum compression connectors and insulated mechanical connectors are pre-filled with joint compound

E3.  
Pre-Printed  
& Write-On  
Markers

E4.  
Permanent  
Identification

E5.  
Lockout/  
Tagout/  
& Safety  
Solutions

### 5. Insert the conductor into the connector and:

- For mechanical connectors, tighten the screws to the recommended torque values
- For compression connectors, use the recommended die and crimping tool to make the proper compression connection



F.  
Index

## Panduit Power Connector Approvals



Logo (Symbol)	Agency	Spec/Approval	Applicable Products
	Underwriters Laboratories, Inc.	UL 486A-486B Wire Connectors and Soldering Lugs for use in US and Canada	As shown on product pages.
	Underwriters Laboratories, Inc.	UL 486A-486B Wire Connectors and Soldering Lugs for use in US	As shown on product pages.
	Underwriters Laboratories, Inc.	UL 486A-486B Wire Connectors and Soldering Lugs for use in US	As shown on product pages.
	Canadian Standards Association	C22.2 No. 65-03 Wire Connectors	As shown on product pages.
	American Bureau of Shipping	ABS Rules Steel Vessel Rules 1-1-4/7.7, 4-8-3/9.19, 4-8-4/21.27	Copper compression connectors LCA, LCAF, LCAS, LCAX, LCB, LCC, LCD, S-R, LCDX, SCS, SCSF
<b>NEBS Level 3</b>	Telcordia Technologies, Inc.	Network Equipment – Building Systems	Copper compression connectors LCAS, LCA, LCD, LCB, LCC, LCAF, LCCF, SCSS, SCS, SCL, SCSF

A.  
System  
Overview

B1.  
Cable Ties

B2.  
Cable  
Accessories

B3.  
Stainless  
Steel Ties

C1.  
Wiring  
Duct

C2.  
Surface  
Raceway

C3.  
Abrasion  
Protection

C4.  
Cable  
Management

D1.  
Terminals

D2.  
Power  
Connectors

D3.  
Grounding  
Connectors

E1.  
Labeling  
Systems

E2.  
Labels

E3.  
Pre-Printed  
& Write-On  
Markers

E4.  
Permanent  
Identification

E5.  
Lockout/  
Tagout/  
& Safety  
Solutions

F.  
Index

A. System Overview

B1. Cable Ties

B2. Cable Accessories

B3. Stainless Steel Ties

C1. Wiring Duct

C2. Surface Raceway

C3. Abrasion Protection

C4. Cable Management

D1. Terminals

D2. Power Connectors

D3. Grounding Connectors

E1. Labeling Systems

E2. Labels

E3. Pre-Printed & Write-On Markers

E4. Permanent Identification

E5. Lockout/Tagout & Safety Solutions

F. Index

## Recommended Termination Hardware

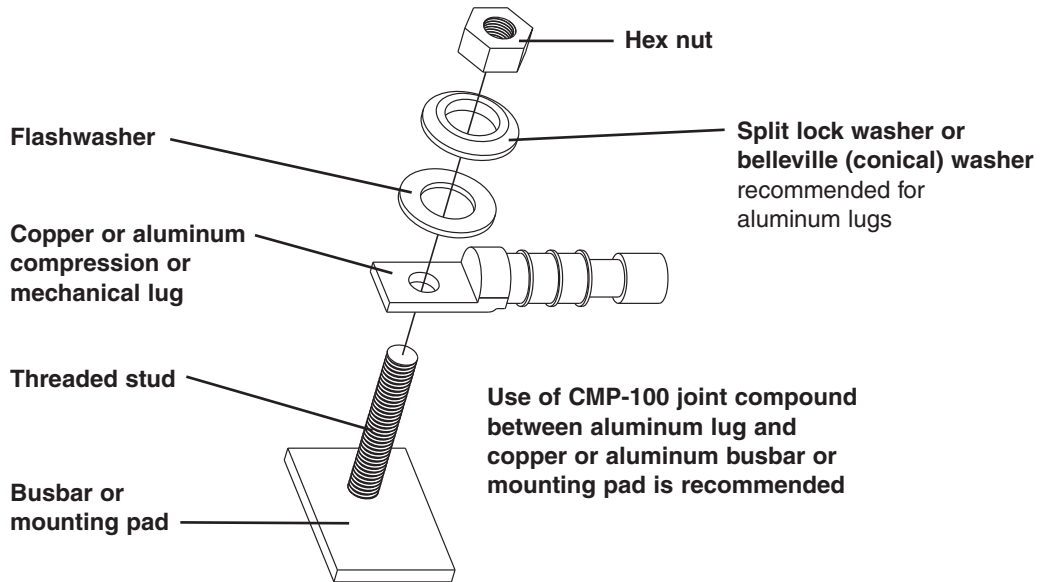

## Recommended Hardware Material

Material Configuration of Lug/Mounting Surface

Copper to Copper	Aluminum to Copper	Aluminum to Aluminum	Copper to Steel	Aluminum to Steel
<ol style="list-style-type: none"> <li>Silicon bronze</li> <li>Stainless steel</li> </ol>	<ol style="list-style-type: none"> <li>Silicon bronze</li> <li>Aluminum</li> <li>Stainless steel</li> </ol>	<ol style="list-style-type: none"> <li>Aluminum</li> <li>Stainless steel</li> <li>Plated silicon bronze</li> </ol>	<ol style="list-style-type: none"> <li>Silicon bronze</li> <li>Stainless steel</li> </ol>	<ol style="list-style-type: none"> <li>Aluminum</li> <li>Stainless steel</li> </ol>

## Conductor Sizes

### Copper Concentric Stranded Conductor Sizes

Conductor Size AWG or kcmil	Number of Strands	Nominal Diameter (In.)	Class
#20	7	.036 /3	B
#18	7	.045 /6	B
#16	7	.057 /6	B
#14	7	.072 /6	B
#12	7	.091 /5	B
#10	7	.116	B
#9	7	.130	B
#8	7	.146	B
#7	7	.164	B
#6	7	.184	B
#5	7	.206	B
#4	3	.254	AA
#4	7	.232	B&A
#3	3	.285	AA
#3	7	.260	B&A
#2	3	.320	AA
#2	7	.292	B&A
#1	3	.360	AA
#1	7	.328	AA
#1	19	.332	B
1/0	7	.368	A&A
1/0	12	.390	—
1/0	19	.373	B
2/0	7	.414	A&A
2/0	12	.438	—
2/0	19	.419	B
3/0	7	.464	A&A
3/0	12	.492	—
3/0	19	.470	B
4/0	7	.522	A&A
4/0	12	.522	—
4/0	19	.528	B
250	12	.600	AA
250	19	.574	A
250	37	.575	B
300	12	.657	AA
300	19	.628	A
300	37	.630	B
350	12	.710	AA
350	19	.679	A
350	37	.681	B
400	19	.726	A&AA
400	37	.728	B
450	19	.770	AA
450	37	.772	B&A
500	19	.811	AA
500	37	.813	B&A
600	37	.891	A&AA
600	61	.893	B
700	37	.963	BB
700	61	.964	B&A
750	37	.977	AA
750	61	.998	B&A
800	37	1.029	AA
800	61	1.031	B&A
900	37	1.092	AA
900	61	1.094	B&A
1000	37	1.151	AA
1000	61	1.152	B&A
1000	61	1.152	B&A

### Flexible Copper Conductor Sizes

Conductor Size AWG or kcmil	Number of Strands	Nominal Diameter (In.)	Class
#8	41/.0201	.156	I
#8	49/.0184	.166	G
#8	133/.0111	.167	H
#8	168/.010	.157	K
#8	37	.330	Locomotive (DLO)
#8	420/.0063	.162	M
#7	49/.0206	.185	G
#7	52/.0201	.185	I
#7	133/.0125	.188	H
#7	210/.010	.179	K
#7	—	—	Locomotive (DLO)
#7	532/.0063	.196	M
#6	49/.0231	.208	G
#6	63/.0201	.207	I
#6	133/.0140	.210	H
#6	266/.010	.210	K
#6	61	.410	Locomotive (DLO)
#6	665/.0063	.215	M
#5	49/.0260	.234	G
#5	84/.0201	.235	I
#5	133/.0158	.237	H
#5	336/.010	.235	K
#5	—	—	Locomotive (DLO)
#5	836/.0063	.240	M
#4	49/.0292	.263	G
#4	105/.0201	.263	I
#4	133/.0177	.266	H
#4	420/.010	.272	K
#4	105	.460	Locomotive (DLO)
#4	1064/.0063	.269	M
#3	49/.0328	.295	G
#3	133/.0199	.299	H
#3	133/.0201	.291	I
#3	532/.010	.304	K
#3	125	.480	Locomotive (DLO)
#3	1323/.0063	.305	M
#2	49/.0368	.331	G
#2	133/.0223	.335	H
#2	161/.0201	.319	I
#2	665/.010	.338	K
#2	150	.510	Locomotive (DLO)
#2	1666/.0063	.337	M
#1	133/.0251	.337	G
#1	210/.0201	.367	I
#1	259/.018	.378	H
#1	836/.010	.397	K
#1	225	.650	Locomotive (DLO)
#1	2107/.0063	.376	M
1/0	133/.0282	.423	G
1/0	259/.0202	.424	H
1/0	266/.0201	.441	I
1/0	1064/.010	.451	K
1/0	275	.680	Locomotive (DLO)
1/0	2646/.0063	.423	M
2/0	133/.0316	.474	G
2/0	259/.0227	.477	H
2/0	342/.0201	.500	I
2/0	1323/.010	.470	K
2/0	325	.720	Locomotive (DLO)
2/0	3325/.0063	.508	M

Table continues on page D2.160

A.  
System  
Overview

B1.  
Cable  
Ties

B2.  
Cable  
Accessories

B3.  
Stainless  
Steel Ties

C1.  
Wiring  
Duct

C2.  
Surface  
Raceway

C3.  
Abrasion  
Protection

C4.  
Cable  
Management

D1.  
Terminals

D2.  
Power  
Connectors

D3.  
Grounding  
Connectors

E1.  
Labeling  
Systems

E2.  
Labels

E3.  
Pre-Printed  
& Write-On  
Markers

E4.  
Permanent  
Identification

E5.  
Lockout/  
Tagout  
& Safety  
Solutions

F.  
Index

A.  
System  
Overview

## Conductor Sizes (continued)

B1.  
Cable Ties

### Flexible Copper Conductor Sizes

Conductor Size AWG or kcmil	No. of Strands/ Strand Dia.	Nominal Diameter (In.)	Class
3/0	133/.0355	.533	G
3/0	259/.0255	.536	H
3/0	418/.0201	.549	I
3/0	1666/.010	.533	K
3/0	450	.810	Locomotive (DLO)
3/0	4256/.0063	.576	M
4/0	133/.0399	.599	G
4/0	259/.0286	.601	H
4/0	532/.0201	.613	I
4/0	2107/.010	.627	K
4/0	550	.840	Locomotive (DLO)
4/0	5320/.0063	.645	M
250	259/.0311	.650	G
250	427/.0242	.653	H
250	637/.0201	.682	I
250	2499/.010	.682	K
262.6	650	.960	Locomotive (DLO)
250	6384/.0063	.713	M
300	259/.0340	.714	G
300	427/.0265	.716	H
300	735/.0201	.737	I
300	2989/.010	.768	K
313.1	775	1.040	Locomotive (DLO)
300	7581/.0063	.768	M
350	259/.0368	.773	G
350	427/.0268	.772	H
350	882/.0201	.800	I
350	3458/.010	.809	K
373.7	925	1.140	Locomotive (DLO)
350	8806/.0063	.825	M
400	259/.0393	.825	G
400	427/.0306	.826	H
400	980/.0201	.831	I
400	3990/.010	.878	K
400	—	—	Locomotive (DLO)
400	10101/.0063	.901	M
450	259/.0417	.876	G
450	427/.325	.878	H
450	1127/.0201	.894	I
450	4522/.010	.933	K
444.4	1100	1.230	Locomotive (DLO)
450	11396/.0063	.940	M
500	259/.0439	.922	G
500	427/.0342	.923	H
500	1125/.0201	.941	I
500	5054/.010	.988	K
535.3	1325	1.320	Locomotive (DLO)
500	12691/.0063	.997	M
600	427/.0375	1.013	G
600	703/.0292	1.022	H
600	1470/.0201	1.027	I
600	5985/.010	1.125	K
646.4	1600	1.450	Locomotive (DLO)
600	14945/.0063	1.084	M
700	427/.0405	1.094	G
700	703/.0316	1.106	H
700	1729/.0201	1.194	I
700	6916/.010	1.207	K
777.7	1925	1.540	Locomotive (DLO)
700	17507/.0063	1.183	M

F.  
Index

### Flexible Copper Conductor Sizes

Conductor Size AWG or kcmil	No. of Strands/ Strand Dia.	Nominal Diameter (In.)	Class
800	427/.0433	1.169	G
800	703/.0337	1.180	H
800	1995/.0201	1.290	I
800	7980/.010	1.305	K
800	—	—	Locomotive (DLO)
800	20069/.0063	1.256	M
900	427/.0459	1.239	G
900	703/.0358	1.253	H
900	2261/.0201	1.372	I
900	9065/.010	1.323	K
900	—	—	Locomotive (DLO)
900	22631/.0063	1.331	M
1000	427/.0484	1.307	G
1000	703/.0377	1.320	H
1000	2527/.0201	1.427	I
1000	10101/.010	1.419	K
1000	—	—	Locomotive (DLO)
1000	25193/.0063	1.404	M

### Copper Compact Stranded Conductor Sizes

Conductor Size AWG or kcmil	Number of Strands	Conductor Diameter (In.)	Class
#8	7	.134	Compact
#6	7	.169	Compact
#4	7	.213	Compact
#2	7	.268	Compact
#1	19	.299	Compact
1/0	19	.336	Compact
1/0	19	.376	Compact
3/0	19	.423	Compact
4/0	19	.475	Compact
250	37	.520	Compact
300	37	.570	Compact
350	37	.616	Compact
400	37	.659	Compact
450	37	.700	Compact
500	37	.736	Compact
550	61	.775	Compact
600	61	.813	Compact
650	61	.845	Compact
700	61	.877	Compact
750	61	.908	Compact
800	61	.938	Compact
900	61	.999	Compact
1000	61	1.060	Compact

## Conductor Sizes (continued)

### Copper Solid Conductor Sizes

Solid Copper Conductor Size AWG or kcmil	Conductor Diameter (In.)
#18	.040
#17	.045
#16	.050
#15	.057
#14	.064
#13	.071
#12	.080
#11	.090
#10	.101
#9	.114
#8	.128
#7	.128
#6	.162
#5	.181
#4	.204
#3	.229
#2	.257
#1	.289
1/0	.324
2/0	.364
3/0	.409
4/0	.460

### Aluminum Concentric Stranded Conductor Sizes

Class B Aluminum Concentric AWG or kcmil	Number of Strands	Diameter of each Strand (Mils)
#8	7	48.6
#7	7	54.5
#6	7	61.2
#5	7	68.8
#4	7	77.2
#3	7	86.7
#2	7	97.4
#1	19	66.4
1/0	19	74.5
2/0	19	83.7
3/0	19	94.0
4/0	19	105.5
250	37	82.2
300	37	90.0
350	37	97.3
400	37	104.0
450	37	110.3
500	37	116.2
550	61	95.0
600	61	99.2
650	61	103.2
700	61	107.1
750	61	110.9
800	61	114.5
900	61	121.5
1000	61	128.0

### Aluminum Compact Stranded Conductor Sizes

Compact Aluminum AWG or kcmil	Class ASTM B400	Number of Strands	Conductor Diameter (In.)
#8	A, B	7	.134
#6	A, B	7	.169
#4	A, B	7	.213
#3	A, B	7	.238
#2	AA, A, B	7	.268
#1	AA, A	7	.299
#1	B	19	.299
1/0	AA, A	7	.336
1/0	B	19	.336
2/0	AA, A	7	.376
2/0	B	19	.376
3/0	AA, A	7	.423
3/0	B	19	.423
4/0	AA, A	7	.475
4/0	B	19	.475
250	AA	7	.520
250	A	19	.520
250	B	37	.520
266	AA	7	.337
266	A	19	.337
300	AA	7	.570
300	A	19	.570
300	B	37	.570
336	AA	7	.603
336	A	19	.603
350	A	19	.616
350	B	37	.616
397	AA, A	19	.659
400	B	37	.659
450	B	37	.700
477	AA	19	.722
500	AA	19	.736
500	B	37	.736
550	B	61	.775
556	AA	19	.780
600	B	61	.813
650	B	61	.845
700	B	61	.877
750	B	61	.908
800	B	61	.938
900	B	61	.999
1000	B	61	1.060

A.  
System  
Overview

B1.  
Cable Ties

B2.  
Cable  
Accessories

B3.  
Stainless  
Steel Ties

C1.  
Wiring  
Duct

C2.  
Surface  
Raceway

C3.  
Abrasion  
Protection

C4.  
Cable  
Management

D1.  
Terminals

D2.  
Power  
Connectors

D3.  
Grounding  
Connectors

E1.  
Labeling  
Systems

E2.  
Labels

E3.  
Pre-Printed  
& Write-On  
Markers

E4.  
Permanent  
Identification

E5.  
Lockout/  
Tagout  
& Safety  
Solutions

F.  
Index

A. System Overview

## Common Conductor Sizes and Strandings Reference Chart

B1. Cable Ties

B2. Cable Accessories

B3. Stainless Steel Ties

C1. Wiring Duct

C2. Surface Raceway

C3. Abrasion Protection

C4. Cable Management

D1. Terminals

D2. Power Connectors

D3. Grounding Connectors

E1. Labeling Systems

E2. Labels

E3. Pre-Printed & Write-On Markers

E4. Permanent Identification

E5. Lockout/Tagout & Safety Solutions

F. Index

Conductor		Individual Strands			Overall Conductor Size			Conductor		Individual Strands			Overall Conductor Size		
		Diameter		No.	Diameter		Area			Diameter		Diameter		Area	
AWG	Metric mm <sup>2</sup>	mm	In.		mm	In.		Circ. MILS	AWG	Metric mm <sup>2</sup>	mm	In.	mm		In.
	.05	25	.05	.002	.25	.010	97		1.0	19	0.25	.010	1.30	.051	1841
	.06	41	.05	.002	.36	.014	159			1	1.13	.044	1.13	.044	1979
26		10	.13	.005	.53	.021	250	16		32	.20	.008	1.30	.051	1984
		1	.41	.016	.41	.016	256			7	.43	.017	1.30	.051	2006
		7	.16	.006	.48	.019	278			19	.29	.011	1.47	.058	2426
		19	.10	.004	.51	.020	304			65	.16	.006	1.50	.059	2580
24		41	.08	.003	.58	.023	384	14		*26	.25	.010	1.50	.059	2600
		10	.16	.006	.58	.023	397			1	1.30	.051	1.30	.051	2601
		1	.51	.020	.51	.020	400			105	.13	.005	1.50	.059	2625
		7	.20	.008	.61	.024	448			*7	.51	.020	1.52	.060	2828
	0.25	19	.13	.005	.61	.024	475		1.5	30	.25	.010	1.70	.067	2906
		65	.07	.003	.65	.026	484			21	.30	.012	1.60	.063	2930
		128	.05	.002	.65	.026	496			189	.10	.004	1.90	.075	2930
		32	.10	.004	.65	.026	496			7	.52	.020	1.60	.063	2934
22		14	.16	.006	.65	.026	556	14		1	1.38	.054	1.38	.054	2952
		1	.64	.025	.64	.025	625			45	.16	.006	1.85	.073	3786
		16	.16	.006	.76	.030	635			19	.38	.014	1.85	.073	3831
		26	.13	.005	.76	.030	650			1	1.63	.064	1.63	.064	4096
	0.38	7	.25	.010	.76	.030	700	12		*41	.25	.010	1.85	.073	4100
		19	.16	.006	.79	.031	754			*7	.64	.025	1.85	.073	4481
		48	.10	.004	.80	.031	744			50	.25	.010	2.20	.087	4844
		194	.05	.002	.80	.031	752			7	.67	.026	2.10	.083	4871
D1. Terminals		100	.07	.003	.80	.031	760	2.5		35	.30	.012	2.20	.087	4883
		7	.27	.011	.80	.031	791			315	.10	.004	2.20	.087	4883
		12	.21	.008	.80	.031	820			1	1.78	.070	1.78	.070	4911
		21	.16	.006	.80	.031	833			19	.45	.018	2.36	.093	6088
D2. Power Connectors	.5	7	.30	.012	.90	.035	977	12		*65	.25	.010	2.41	.095	6500
		16	.20	.008	.90	.035	992			165	.16	.006	2.41	.095	6549
		1	.80	.031	.80	.031	992			1	2.06	.081	2.06	.081	6561
		*10	.25	.010	.89	.035	1000			*7	.81	.032	2.44	.096	7168
D3. Grounding Connectors	20	1	.81	.032	.81	.032	1024	4.0		56	.30	.012	3.10	.122	7812
		41	.13	.005	.91	.036	1025			1	2.26	.089	2.26	.089	7917
		26	.16	.006	.91	.036	1032			511	.10	.004	3.00	.118	7921
		*7	.32	.013	.97	.038	1111			19	.52	.020	2.70	.106	7963
E1. Labeling Systems		19	.20	.008	.94	.037	1216	10		37	.40	.016	2.92	.115	9354
		7	.37	.015	1.10	.043	1485			49	.36	.014	2.95	.116	9880
		24	.20	.008	1.20	.047	1488			*7	.98	.039	2.95	.116	10376
		1	1.00	.039	1.00	.039	1550			1	2.59	.102	2.59	.102	10404
E2. Labels	.75	*16	.25	.010	1.19	0.047	1600	10		*105	.25	.010	2.95	.116	10500
		1	1.02	.040	1.02	.040	1600			84	.30	.012	3.50	.138	11718
		65	.13	.005	1.19	.047	1625			756	.10	.004	3.70	.146	11718
		41	.16	.006	1.19	.047	1627			1	2.76	.109	2.76	.109	11807
E3. Pre-Printed & Write-On Markers	18	*7	.40	.016	1.22	.048	1770	6.0		7	1.05	.041	3.20	.126	11962
		19	.25	.010	1.24	.049	1900			19	.64	.025	3.30	.130	12063

\*Strandings required for UL and CSA Certification testing.

This chart details the different conductors commonly used in the industry. For each size, either AWG or Metric, various stranding options are listed. Typically the higher stranding is used in applications requiring greater conductor flexibility.

AWG to Metric Wire Crosses	
AWG	Metric (mm <sup>2</sup> )
26 – 22	0.1 – 0.5
22 – 18	0.5 – 1.0
16 – 14	1.5 – 2.5
12 – 10	4.0 – 6.0



## Common Conductor Sizes and Strandings Reference Chart (continued)

Conductor		Individual Strands			Overall Conductor Size			Conductor		Individual Strands			Overall Conductor Size		
AWG	Metric mm <sup>2</sup>	No.	Diameter		Diameter		Area	AWG	Metric mm <sup>2</sup>	No.	Diameter		Diameter		Area
			mm	In.	mm	In.					Circ. MILS	mm	In.	mm	
	6	7	0.107	0.042	3.21	0.126	11840		95	19	2.57	0.101	12.8	0.505	187500
		1	2.77	0.109	2.77	0.109	11840			37	1.83	0.072	12.5	0.504	187500
9		7	1.1	0.0432	3.3	0.13	13000	4/0		19	2.89	0.1055	13.4	0.528	211600
		1	2.91	0.1144	2.91	0.114	13090		120	37	2.06	0.081	14.4	0.567	237.8 kcmil
8		1	3.26	0.1285	3.25	0.128	16510	250 kcmil		37	2.07	0.0822	14.6	0.575	250 kcmil
		7	1.23	0.0486	3.7	0.146	16510	300 kcmil	150	37	2.29	0.09	16	0.63	300 kcmil
	10	7	1.37	0.054	4.12	0.162	19740	350 kcmil		37	2.47	0.0973	17.3	0.681	350 kcmil
		1	3.58	0.141	3.58	0.141	19740		185	37	2.54	0.1	17.8	0.7	365.1 kcmil
7		7	1.38	0.0545	4.15	0.164	20520	400 kcmil		37	2.64	0.104	18.5	0.728	400 kcmil
		1	3.67	0.1443	3.67	0.144	20520		240	37	2.9	0.114	20.3	0.798	473.6 kcmil
6		7	1.55	0.0612	4.66	0.184	26240			61	2.26	0.089	20.3	0.801	473.6 kcmil
		1	4.11	0.162	4.11	0.162	26240	500 kcmil		37	2.95	0.1162	20.7	0.813	500 kcmil
	16	7	1.73	0.008	5.13	0.204	31580			61	2.3	0.0905	20.7	0.814	500 kcmil
5		7	1.75	0.0688	5.24	0.206	33090		300 kcmil	61	2.51	0.099	22.6	0.891	592.1 kcmil
4		7	1.96	0.0772	5.88	0.232	41740	600 kcmil		61	2.52	0.0992	22.7	0.893	600 kcmil
	25	7	2.16	0.085	6.48	0.255	49340	700 kcmil		61	2.72	0.1071	24.5	0.964	700 kcmil
		19	1.32	0.052	6.6	0.26	49340	750 kcmil		61	2.82	0.1109	25.4	0.998	750 kcmil
3		7	2.2	0.0867	6.61	0.26	52620			91	2.31	0.0908	25.4	0.998	750 kcmil
2		7	2.47	0.0974	7.42	0.292	66300		400	61	2.9	0.114	26.1	1.026	798.4 kcmil
	35	7	2.54	0.1	7.62	0.300	69070	800 kcmil		61	2.91	0.1145	26.2	1.031	800 kcmil
		19	1.55	0.001	7.75	0.305	69070			91	2.38	0.0938	26.2	1.032	800 kcmil
1		19	1.5	0.0064	8.43	0.332	83690	1000 kcmil	500	61	3.25	0.128	28.3	1.152	986.8 kcmil
	50	19	1.85	0.073	9.27	0.365	98680			91	2.66	0.1048	29.3	1.153	1000 kcmil
1/0		19	1.59	0.0745	9.46	0.373	10500		625	91	2.97	0.117	32.7	1.287	1233.7 kcmil
2/0		19	2.13	0.0837	10.6	0.419	133100								
3/0	70	19	2.18	0.086	10.9	0.43	138100								
		19	2.59	0.094	11.9	0.47	167800								
		36	1.71	0.0673	12	0.471	167800								

A.  
System  
Overview

B1.  
Cable Ties

B2.  
Cable  
Accessories

B3.  
Stainless  
Steel Ties

C1.  
Wiring  
Duct

C2.  
Surface  
Raceway

C3.  
Abrasion  
Protection

C4.  
Cable  
Management

D1.  
Terminals

D2.  
Power  
Connectors

D3.  
Grounding  
Connectors

E1.  
Labeling  
Systems

E2.  
Labels

E3.  
Pre-Printed  
& Write-On  
Markers

E4.  
Permanent  
Identification

E5.  
Lockout/  
Tagout  
& Safety  
Solutions

F.  
Index











A. System Overview

## Stud Size Chart (Inches/Millimeters)

B1. Cable Ties

B2. Cable Accessories

B3. Stainless Steel Ties



										
Standard Stud Size	<b>#2</b>	<b>#4</b>	<b>#5</b>	<b>#6</b>	<b>#8</b>	<b>#10</b>	<b>1/4"</b>	<b>5/16"</b>	<b>3/8"</b>	<b>7/16"</b>
Stud Size Decimal Equivalent	.086"	.112"	.127"	.138"	.164"	.190"	.250"	.312"	.375"	.438"
Terminal Hole Diameter	.090"	.118"	.130"	.147"	.173"	.204"	.270"	.343"	.392** .406***	.456"
Stud Size Designation in Panduit Part Number	2	4	5	6	8	10	14	56	38	76

C1. Wiring Duct

C2. Surface Raceway

C3. Abrasion Protection

C4. Cable Management

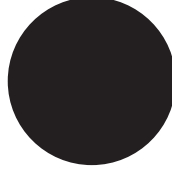
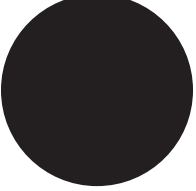
					
Standard Stud Size	<b>1/2"</b>	<b>5/8"</b>	<b>3/4"</b>	<b>7/8"</b>	<b>1"</b>
Stud Size Decimal Equivalent	.500"	.625"	.750"	.875"	1.00"
Terminal Hole Diameter	.531"	.656"	.810"	.906"	1.031"
Stud Size Designation in Panduit Part Number	12	58	34	78	1

D1. Terminals

D2. Power Connectors

D3. Grounding Connectors

\*Terminal stud.  
\*\*Power Connector stud.

E1. Labeling Systems

E2. Labels

E3. Pre-Printed & Write-On Markers

E4. Permanent Identification

E5. Lockout/Tagout & Safety Solutions

F. Index

## Equivalent Tables Decimal/Inches/Millimeters

		.0156	0,396			.2656	6,746			.5156	13,100			.7656	19,446
		.0468	1,189			.2968	7,541			.5468	13,891			.7968	20,241
		.0781	1,984			.3125	7,938			.5781	14,684			.8125	20,637
		.0937	2,380			.3437	8,730			.5937	15,080			.8437	21,480
		.1093	2,779			.3593	9,129			.6093	15,479			.8593	21,828
		.1406	3,571			.3906	9,921			.6406	16,271			.8906	22,620
		.1562	3,968			.4218	10,716			.6718	17,066			.9218	23,416
		.1875	4,763			.4531	11,509			.7031	17,859			.9531	24,208
		.2187	5,555			.4843	12,304			.7343	18,654			.9843	25,001
		.25	6,350			.5	12,700			.75	19,050			1.	25,400

## STRUCTUREDGROUND™ GROUNDING CONNECTORS

Panduit® StructuredGround™ Grounding Connectors provide innovative solutions for joining ground conductors to water pipe, ground rods, rebar, conduit, iron pipe and structural steel. Designed with the needs of the end user in mind, StructuredGround™ Grounding Connectors feature easy installation, lowest installed cost, and long-term reliability.



- Functional product information is marked directly on the connector, facilitating the identification, ordering, and usage of the grounding connector
- Compression connectors are color-coded to facilitate quick identification of the proper crimping die
- Mechanical connectors are designed for easy installation – no special tools required
- Incorporate wide wire range-taking capability to minimize inventory requirements
- Made from high strength, high conductivity electrolytic copper and aluminum alloy materials to provide optimum connectivity for both power and grounding applications
- Wide assortment of manual, controlled cycle, battery operated hydraulic and pneumatic crimping tools for reliable connections at the lowest installed cost

Panduit® StructuredGround™ Grounding Connectors are designed for use with many different code and flex conductor types and are available in a broad range of styles and sizes. A full line of manual, controlled cycle, and battery operated hydraulic crimping tools meet application needs and provide lowest installed cost. Panduit offers a wide variety of StructuredGround™ Grounding Connectors to meet customer needs and today's application requirements.

A.  
System  
Overview

B1.  
Cable Ties

B2.  
Cable  
Accessories

B3.  
Stainless  
Steel Ties

C1.  
Wiring  
Duct

C2.  
Surface  
Raceway

C3.  
Abrasion  
Protection

C4.  
Cable  
Management

D1.  
Terminals

D2.  
Power  
Connectors

D3.  
Grounding  
Connectors

E1.  
Labeling  
Systems

E2.  
Labels

E3.  
Pre-Printed  
& Write-On  
Markers

E4.  
Permanent  
Identification

E5.  
Lockout/  
Tagout  
& Safety  
Solutions

F.  
Index

A. System Overview

## Features and Benefits – StructuredGround™ Compression Connectors

B1. Cable Ties

**Bolded** features are unique to Panduit.

B2. Cable Accessories

### Copper HTAPs

**Easy-to-read, color-coded die index number for Panduit crimping dies, legible after crimping, for selection**

Part number and agency listings marked on part for easy identification

**Slotted design to reduce installation time when used with Panduit cable ties (included)**

Conductor sizes for each tap pocket marked on part

Made from high conductivity copper and electro tin-plated to inhibit corrosion



### Clear Covers for Copper HTAPs

Optically clear to allow 360° inspections

Made from high impact strength self-extinguishing plastic with UL94V-0 flammability rating and minimum oxygen index of 28

Built-in flanges retain HTAP in cover

Easy to assemble snap-on design

Molded in flash barriers protect against electrical flash over

Retainer clips to hold labels inside cover\*. Retainer clips have a write-on surface for manual marking

Corresponding Panduit HTAP part number, voltage rating, and temperature rating molded into cover half for easy identification

Low profile design minimizes space requirements

Flexible fingers closely conform to conductor preventing foreign objects from entering cover



\*Labels shown printed with Panduit® PanTher™ LS8E Printer. See page E1.2.

C4. Cable Management

### Thin Wall Copper CTAPs

Part number and conductor size marked on part for easy identification

Color-coded for proper crimp die selection

Ribbed design provides high strength

Made from high conductivity wrought copper



### Heavy Duty Copper CTAPs

Easy-to-read die index number for selection

Made from heavy wall, extruded, high conductivity copper; provides high strength and premium electrical properties

Part number and conductor size marked on part for easy identification



E1. Labeling Systems

### Access Floor Grounding Clamp **PATENTED**

Each part accommodates a wide range of copper conductor sizes – minimizes inventory

Made from high strength cast bronze

Quad bolt bonds perpendicular MCBN conductors

Bonds to the pedestal with a single bolt to simplify installation

Bonds to both square and round access floor pedestals



F. Index

## StructuredGround™ Direct Burial Compression Grounding System Roadmap

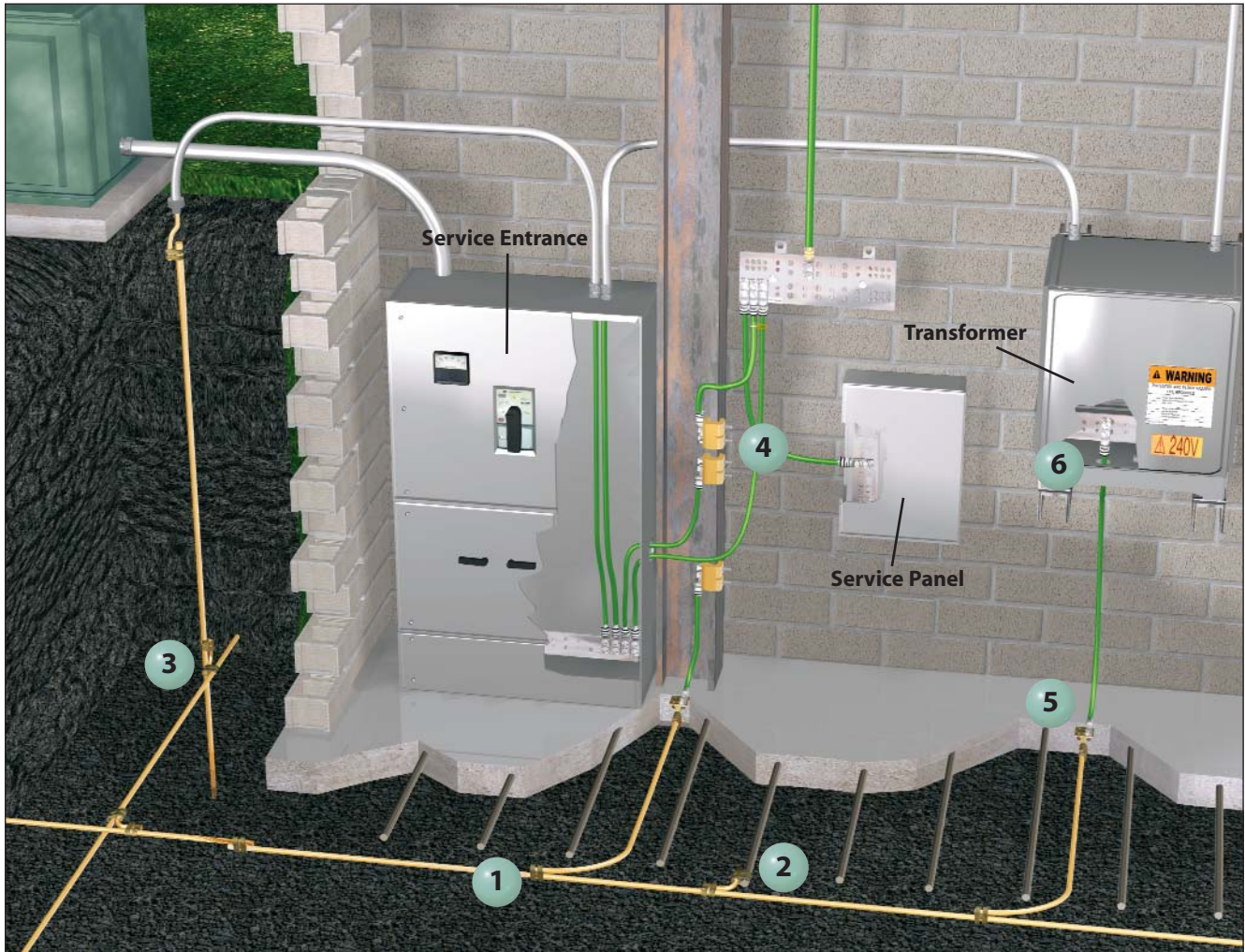

**1 Conductor to Conductor**  
E Style Grounding Connectors:  
Create bonds between parallel  
grounding conductors.  
(see page D3.8)



**2 Conductor to Rebar**  
E Style Grounding Connectors:  
Allow bonds to  
reinforcing bars.  
(see page D3.8)



**3 Conductor to Ground Rod**  
Grounding Cross Connectors:  
Create bonds between  
perpendicular grounding  
conductors.  
(see page D3.9)

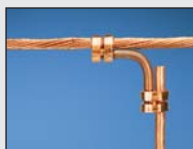

**4 Conductor to Building Steel**  
Universal Beam Grounding  
Clamp: Bonds structural  
steel to grounding  
conductor system.  
(see page D3.10)



**5 Conductor to Grounding  
Electrodes**  
Grounding Plate Connector:  
Allows bonds through  
concrete.  
(see page D3.10)



**6 Related Product LCC-W**  
Long Barrel Two-Hole Code  
Conductor Lugs:  
For use with stranded  
copper conductors.  
(see page D2.47 – D2.49)



A.  
System  
Overview

B1.  
Cable Ties

B2.  
Cable  
Accessories

B3.  
Stainless  
Steel Ties

C1.  
Wiring  
Duct

C2.  
Surface  
Raceway

C3.  
Abrasion  
Protection

C4.  
Cable  
Management

D1.  
Terminals

D2.  
Power  
Connectors

D3.  
Grounding  
Connectors

E1.  
Labeling  
Systems

E2.  
Labels

E3.  
Pre-Printed  
& Write-On  
Markers

E4.  
Permanent  
Identification

E5.  
Lockout/  
Tagout  
& Safety  
Solutions

F.  
Index

A. System Overview

## Service Entrance Grounding Roadmap

B1. Cable Ties

- Complies with J-STD-607-A and IEEE Std 1100 (IEEE Emerald Book)
- Grounding Equalizer (GE) is required when two or more Telecommunications Bonding Backbones (TBB) are used within a multi-story building; bond TBBs together with a GE at the top floor and at a minimum of every third floor in between

B2. Cable Accessories

B3. Stainless Steel Ties

C1. Wiring Duct

C2. Surface Raceway

C3. Abrasion Protection

C4. Cable Management

D1. Terminals

D2. Power Connectors

D3. Grounding Connectors

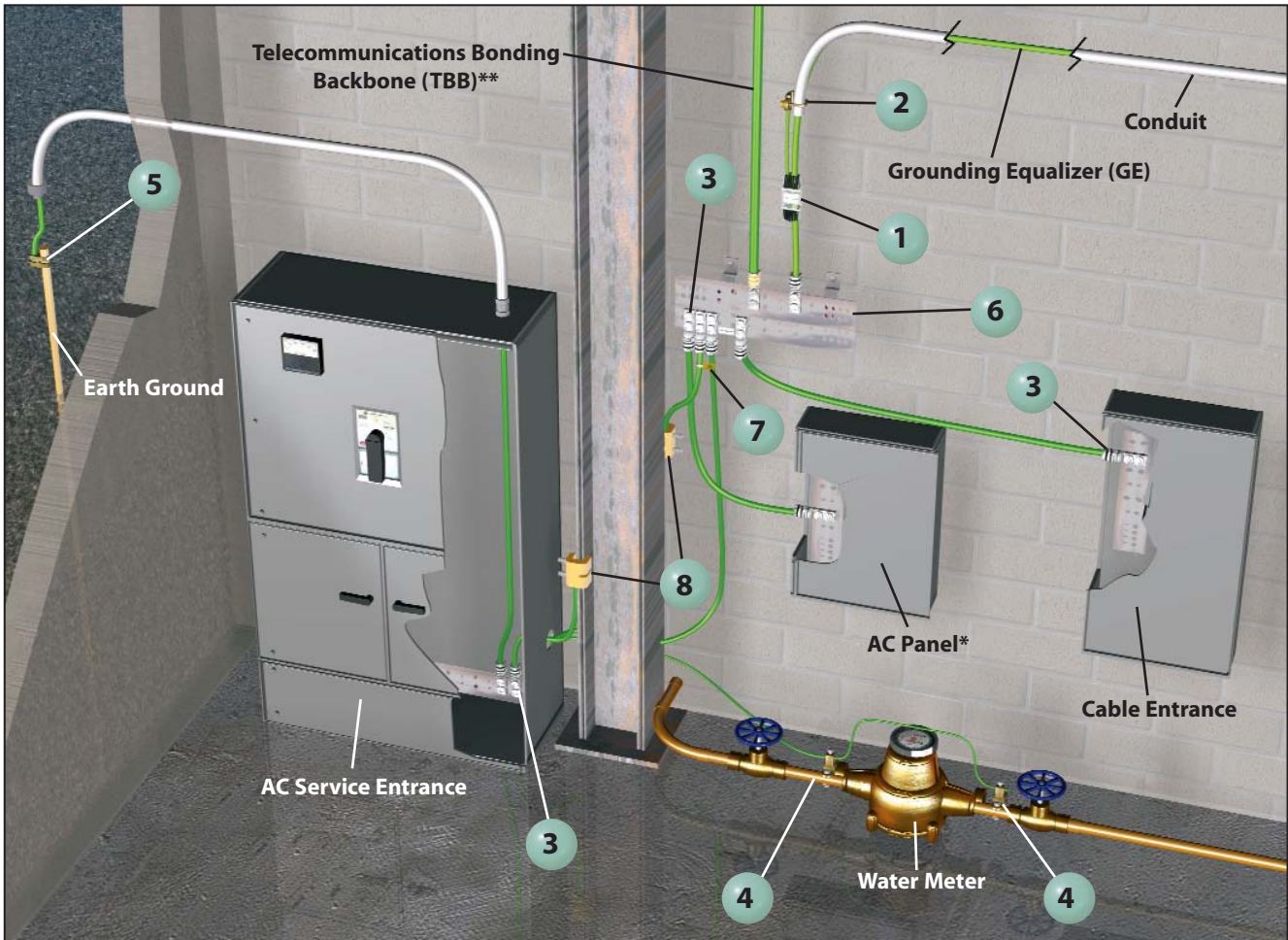

E1. Labeling Systems







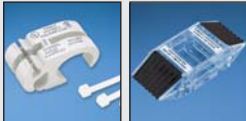

E2. Labels

E3. Pre-Printed & Write-On Markers

E4. Permanent Identification

E5. Lockout/Tagout & Safety Solutions

F. Index

<p><b>1</b> Copper Compression HTAP and Clear Cover: HTWC (see pages D3.15)</p> 	<p><b>5</b> E Style Grounding Connector: GCE (see page D3.8)</p> 
<p><b>2</b> Bronze, U-Bolt Grounding Clamp: GPL (see page D3.25) connected by a cable to <b>1</b> (HTAP)</p> 	<p><b>6</b> Telecommunications Main Grounding Busbar (TMGB) and Busbar Label (see page D3.6)</p> 
<p><b>3</b> Copper Compression, Two-Hole, Long Barrel with Window Lug: LCC-W (see pages D2.47 - D2.49)</p> 	<p><b>7</b> Telecommunications Grounding and Bonding Conductor Label Kit: LTYK (see page D3.6)</p> 
<p><b>4</b> Bronze, Water Pipe Grounding Clamp: KP (see page D3.26)</p> 	<p><b>8</b> Universal Beam Grounding Clamp: GUBC (see page D3.10)</p> 

\*AC Panel should be grounded per NEC standards. Enclosure should be grounded per manufacturer's specifications.

\*\*Specification J-STD-607-A specifies different size conductors based on the length of the Telecommunications Bonding Backbone (TBB).



## Access Floor Grounding Clamp



### Type GPQC

- Bond mesh common bonding network (MCBN) conductors to each other and bond the access floor pedestals to the conductors
- Specifically designed to bond perpendicular MCBN conductors per TIA-942
- Bond to the pedestal with a single bolt to simplify installation
- Accommodate conductors from #6 – 1/0 AWG, minimizes inventory requirements
- Bond round and square access floor pedestals for greater flexibility

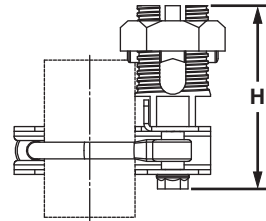
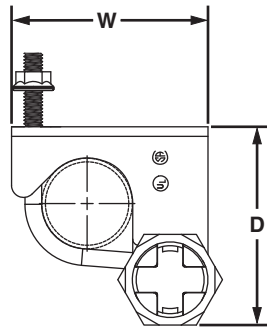
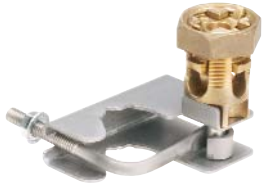

Part Number	Round Pedestal (In.)	Square Pedestal (In.)	MCBN Conductor Size Range AWG (mm <sup>2</sup> )	Figure Dimensions In. (mm)			Std. Pkg. Qty.	Std. Ctn. Qty.
				D	W	H		
GPQC07-1/0	3/4 – 7/8	—	#6 SOL – 1/0 STR (16 – 50)	4.25 (108.0)	3.38 (85.9)	3.19 (81.0)	1	10
GPQC10-1/0	1 – 1 1/8	7/8	#6 SOL – 1/0 STR (16 – 50)	4.19 (106.4)	3.38 (85.9)	3.19 (81.0)	1	10
GPQC12-1/0	1 1/4	—	#6 SOL – 1/0 STR (16 – 50)	4.53 (115.1)	3.44 (87.4)	3.19 (81.0)	1	10
GPQC15-1/0	1 1/2	—	#6 SOL – 1/0 STR (16 – 50)	4.47 (113.5)	3.44 (87.4)	3.19 (81.0)	1	10
GPQC17-1/0	1 3/4	—	#6 SOL – 1/0 STR (16 – 50)	5.19 (131.8)	4.00 (101.6)	3.19 (81.0)	1	10
GPQC20-1/0	2	—	#6 SOL – 1/0 STR (16 – 50)	5.06 (128.5)	4.00 (101.6)	3.19 (81.0)	1	10

A. System Overview

B1. Cable Ties

B2. Cable Accessories

B3. Stainless Steel Ties

C1. Wiring Duct

C2. Surface Raceway

C3. Abrasion Protection

C4. Cable Management

D1. Terminals

D2. Power Connectors

D3. Grounding Connectors

E1. Labeling Systems

E2. Labels

E3. Pre-Printed & Write-On Markers

E4. Permanent Identification

E5. Lockout/Tagout & Safety Solutions

F. Index

A. System Overview

## BICSI/J-STD-607-A Telecommunications Grounding Busbars

B1. Cable Ties

### Type GB

- Meets BICSI and J-STD-607-A requirements for network systems grounding applications
- Made of high conductivity copper and tin-plated to inhibit corrosion
- Comes pre-assembled with brackets and insulators attached for quick installation
- Insulators provide 600 V of insulation
- Use Panduit self-laminating laser/ink jet labels to identify busbars to meet TIA/EIA-606-A, see chart below

B2. Cable Accessories

B3. Stainless Steel Ties



TGB

C1. Wiring Duct

C2. Surface Raceway



TMGB

C3. Abrasion Protection

C4. Cable Management

Part Number	Bar Size	No. of Mounting Positions		Std. Pkg. Qty.
		1/4" Stud Hole with 5/8" Hole Spacing	3/8" Stud Hole with 1" Hole Spacing	
<b>Telecommunications Grounding Busbars (TGB)</b>				
GB2B0304TPI-1	1/4" x 2" x 10"	4	3	1
GB2B0306TPI-1	1/4" x 2" x 12"	6	3	1
GB2B0312TPI-1	1/4" x 2" x 20"	12	3	1
GB2B0514TPI-1	1/4" x 2" x 24"	14	5	1

<b>Telecommunications Main Grounding Busbars (TMGB)</b>				
GB4B0612TPI-1	1/4" x 4" x 12"	12	6	1
GB4B0624TPI-1	1/4" x 4" x 20"	24	6	1
GB4B1028TPI-1	1/4" x 4" x 24"	28	10	1

For additional label sizes, materials, and print technologies and to see the complete line of Panduit identification products, see pages E1.1 – E2.22.

## Component Labels for BICSI/J-STD-607-A Telecommunications Grounding Busbars

D1. Terminals



D2. Power Connectors

D3. Grounding Connectors

Suggested Label Solutions for TIA/EIA-606-A Compliance				
Telecommunications Grounding Busbar Part Number	Laser/Ink Jet Desktop Printer Label	TDP43MY Thermal Transfer Desktop Printer Label	PanTher™ LS8E Hand-Held Printer Label	Cougar™ LS9 Hand-Held Printer Label
All GB2B and GB4B Parts	C200X100FJJ	C200X100YPT	C200X100FJC	T100X000VPC-BK

For complete labeling solutions and product information, reference charts on pages E1.1 – E2.22.

E2. Labels

## Telecommunications Grounding and Bonding Conductor Label Kit

E3. Pre-Printed & Write-On Markers

- Meets labeling requirements of J-STD-607-A; each telecommunications grounding and bonding conductor shall be labeled as close as practicable to its point of termination in a readable position
- Can be applied as a wrap-around marker (parallel to cable) or flag marker (45° or 90°) to cable
- Kit includes everything needed to properly label cables; ten flame retardant cable ties and ten rigid plastic yellow tags printed with "IF THIS CONNECTOR OR CABLE IS LOOSE OR MUST BE REMOVED, PLEASE CALL THE BUILDING TELECOMMUNICATIONS MANAGER."

E4. Permanent Identification



E5. Lockout/Tagout & Safety Solutions

Part Number	Part Description	Std. Pkg. Qty.
LTYK	Label kit includes ten printed tags and ten flame retardant cable ties.	1

F. Index



## NEMA Hole Pattern Grounding Busbars

### Type GBN

- Provided with standard NEMA hole pattern spacing
- Made of high conductivity copper and tin-plated to inhibit corrosion
- Come pre-assembled with brackets and insulators attached for quick installation
- Insulators provide 600 V of insulation



Part Number	Bar Size	No. of Mounting Positions	
		1/2" Stud Hole with 1 3/4" Hole Spacing	Std. Pkg. Qty.
GB4N0007TPI-1	1/4" x 4" x 12"	7	1
GB4N0016TPI-1	1/4" x 4" x 24"	16	1
GB4N0024TPI-1	1/4" x 4" x 36"	24	1
GB4N0026TPI-1	1/4" x 4" x 48"	26	1
GB4N0034TPI-1	1/4" x 4" x 60"	34	1

## Grounding Busbar 1" Hole Spacings

### Type GBD

- Provided with 1" hole D pattern spacing
- Made of high conductivity copper and tin-plated to inhibit corrosion
- Come pre-assembled with brackets and insulators attached for quick installation
- Insulators provide 600 V of insulation



Part Number	Bar Size	No. of Mounting Positions	
		7/16" Stud Hole with 1" Hole Spacing	Std. Pkg. Qty.
GB2D0008TPI-1	1/4" x 2" x 12"	8	1
GB2D0021TPI-1	1/4" x 2" x 24"	21	1
GB2D0033TPI-1	1/4" x 2" x 36"	33	1
GB2D0044TPI-1	1/4" x 2" x 48"	44	1
GB2D0056TPI-1	1/4" x 2" x 60"	56	1

## Stainless Steel Hardware for Busbars

- Bulk hardware for attaching connectors to TMGBs and TGBs



Part Number	Part Description	Std. Pkg. Qty.
<b>1/4" Hardware</b>		
SSNTS1420-C	Stainless steel mounting hardware; 1/4" stainless steel bolts.	100
SSCW14-C	Stainless steel mounting hardware; 1/4" stainless steel Belleville washers (locking).	100
SSFW14-C	Stainless steel mounting hardware; 1/4" stainless steel flat washers.	100
SSN1420-C	Stainless steel mounting hardware; 1/4" stainless steel nuts.	100
<b>3/8" Hardware</b>		
SSNTS3816-C	Stainless steel mounting hardware; 3/8" stainless steel bolts.	100
SSCW38-C	Stainless steel mounting hardware; 3/8" stainless steel Belleville washers (locking).	100
SSFW38-C	Stainless steel mounting hardware; 3/8" stainless steel flat washers.	100
SSN3816-C	Stainless steel mounting hardware; 3/8" stainless steel nuts.	100
<b>Hardware Kit</b>		
GLMHK	Stainless steel hardware for use in mounting lugs for grounding plates and universal beam grounding clamps; includes: two hex head bolts 1/2-13 thread 1" long, two split lock washers for 1/2" diameter bolt, and two SAE flat washers for 1/2" diameter bolt.	1

A. System Overview

B1. Cable Ties

B2. Cable Accessories

B3. Stainless Steel Ties

C1. Wiring Duct

C2. Surface Raceway

C3. Abrasion Protection

C4. Cable Management

D1. Terminals

D2. Power Connectors

D3. Grounding Connectors

E1. Labeling Systems

E2. Labels

E3. Pre-Printed & Write-On Markers

E4. Permanent Identification

E5. Lockout/Tagout & Safety Solutions

F. Index

A. System Overview

B1. Cable Ties

B2. Cable Accessories

B3. Stainless Steel Ties

C1. Wiring Duct

C2. Surface Raceway

C3. Abrasion Protection

C4. Cable Management

D1. Terminals

D2. Power Connectors

D3. Grounding Connectors

E1. Labeling Systems

E2. Labels

E3. Pre-Printed & Write-On Markers

E4. Permanent Identification

E5. Lockout/Tagout & Safety Solutions

F. Index



## E Style Grounding Connectors

### Type GCE

- Wide range-taking ability and multi-conductor design provide flexibility with a minimum number of parts, allowing for conductor to conductor, conductor to rebar, and conductor to ground rod applications
- Designed for the enhanced crimp process using patent pending technology meets IEEE Std 837™ – 2002
- Slotted design allows quick and easy assembly of conductor to connector using Panduit cable ties, included
- Pre-applied conductive antioxidant compound ensures a high quality mechanical and electrical bond, speeding installation
- Color-coded and marked with Panduit die index numbers for proper crimp die selection
- UL 467 Listed and CSA 22.2 Certified for grounding and bonding suitable for direct burial in earth or concrete when crimped with Panduit or industry standard crimping tools and Panduit dies
- Complies with vibration tests per MIL-STD-202G (METHOD 201A)

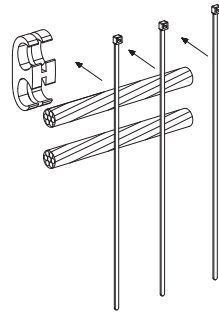

View using cable ties

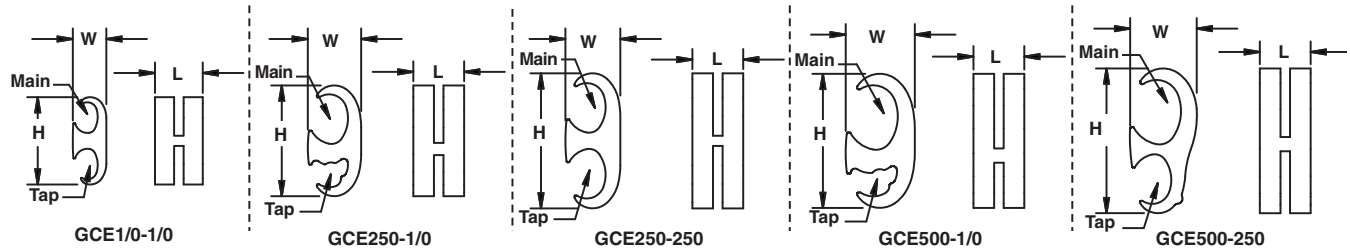
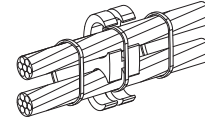
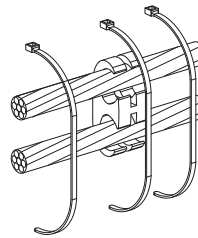

Part Number	Element	Copper Conductor Size Range AWG (mm <sup>2</sup> )	Ground Rod Size In. (mm)	Rebar Size In. (mm)	Figure Dimensions In. (mm)			Panduit Color Code	Panduit Die Index No.‡	Std. Pkg. Qty.
					L	W	H			
<b>GCE1/0-1/0</b>	Main	#6 SOL – 1/0 STR (16 – 50)	—	—	0.94 (23.9)	0.66 (16.8)	1.72 (43.7)	Red	PG10	1
	Tap									
<b>GCE250-1/0</b>	Main	1/0 STR – 250 kcmil (70 – 120)	1/2 – 5/8 (12.7 – 15.9)	3/8 – 1/2, #3 – #4 (9.5 – 12.7), (#10 – #13)	1.00 (25.4)	1.05 (26.7)	2.18 (55.4)	Black	PG25	1
	Tap									
<b>GCE250-250</b>	Main	1/0 STR – 250 kcmil (70 – 120)	1/2 – 5/8 (12.7 – 15.9)	3/8 – 1/2, #3 – #4 (9.5 – 12.7), (#10 – #13)	1.00 (25.4)	1.08 (27.4)	2.66 (67.6)	Black	PG25	1
	Tap									
<b>GCE500-1/0</b>	Main	250 – 500 kcmil (150 – 240)	1/2 – 3/4 (12.7 – 19.1)	5/8 – 3/4, #5 – #6 (15.9 – 19.1), (#16 – #19)	1.00 (25.4)	1.36 (34.5)	2.64 (67.1)	Blue	PG50	1
	Tap									
<b>GCE500-250</b>	Main	250 – 500 kcmil (150 – 240)	1/2 – 3/4 (12.7 – 19.1)	5/8 – 3/4, #5 – #6 (15.9 – 19.1), (#16 – #19)	1.00 (25.4)	1.32 (33.4)	2.85 (72.4)	Blue	PG50	1
	Tap									

‡See page D3.90 for tool and die information.



## Grounding Cross Connectors

### Type GCC

- Only a single die required to crimp each element, which speeds installation and reduces costs
- Wide range-taking ability and multi-conductor design provide flexibility with a minimum number of parts, allowing for conductor to conductor, conductor to rebar, and conductor to ground rod applications
- Designed for the enhanced crimp process using patent pending technology meets IEEE Std 837™ – 2002
- Slotted design allows quick and easy assembly of conductor to connector using Panduit cable ties, included
- Pre-applied conductive antioxidant compound ensures a high quality mechanical and electrical bond, speeding installation
- Color-coded and marked with Panduit die index numbers for proper crimp die selection
- UL 467 Listed and CSA 22.2 Certified for grounding and bonding suitable for direct burial in earth or concrete when crimped with Panduit or industry standard crimping tools and Panduit dies
- Complies with vibration tests per MIL-STD-202G (METHOD 201A)

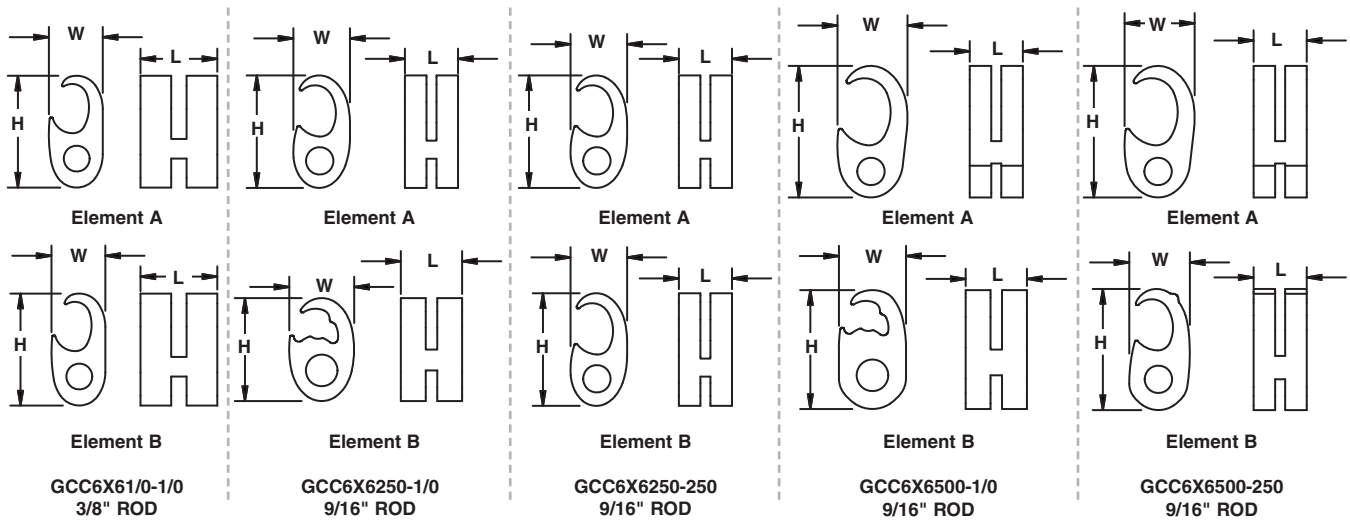

Part Number	Element	Copper Conductor Size Range AWG (mm²)	Ground Rod Size In. (mm)	Rebar Size In. (mm)	Figure Dimensions In. (mm)			Panduit Color Code	Panduit Die Index No.‡	Std. Pkg. Qty.
					L	W	H			
GCC6X610-1/0	A	#6 SOL – 1/0 STR (16 – 50)	—	—	0.94 (23.9)	0.66 (16.8)	1.37 (34.8)	Red	PG10	1
	B									
GCC6X6250-1/0	A	#2 SOL – 250 kcmil (35 – 120)	1/2 – 5/8 (12.7 – 15.9)	3/8 – 1/2, #3 – #4 (9.5 – 12.7), (#10 – #13)	1.00 (25.4)	1.06 (26.9)	2.12 (53.8)	Black	PG25	1
	B						1.68 (42.7)			
GCC6X6250-250	A	#2 SOL – 250 kcmil (35 – 120)	1/2 – 5/8 (12.7 – 15.9)	3/8 – 1/2, #3 – #4 (9.5 – 12.7), (#10 – #13)	1.00 (25.4)	1.06 (26.9)	2.12 (53.8)	Black	PG25	1
	B									
GCC6X6500-1/0	A	250 – 500 kcmil (150 – 240)	1/2 – 3/4 (12.7 – 19.1)	5/8 – 3/4, #5 – #6 (15.9 – 19.1), (#16 – #19)	1.00 (25.4)	1.32 (33.5)	2.48 (63.0)	Blue	PG50	1
	B						1.09 (27.7)			
GCC6X6500-250	A	250 – 500 kcmil (150 – 240)	1/2 – 3/4 (12.7 – 19.1)	5/8 – 3/4, #5 – #6 (15.9 – 19.1), (#16 – #19)	1.00 (25.4)	1.32 (33.5)	2.48 (63.0)	Blue	PG50	1
	B						1.16 (29.5)			

‡See page D3.90 for tool and die information.

A. System Overview

B1. Cable Ties

B2. Cable Accessories

B3. Stainless Steel Ties

C1. Wiring Duct

C2. Surface Raceway

C3. Abrasion Protection

C4. Cable Management

D1. Terminals

D2. Power Connectors

D3. Grounding Connectors

E1. Labeling Systems

E2. Labels

E3. Pre-Printed & Write-On Markers

E4. Permanent Identification

E5. Lockout/Tagout & Safety Solutions

F. Index

A. System Overview

B1. Cable Ties

B2. Cable Accessories

B3. Stainless Steel Ties

C1. Wiring Duct

C2. Surface Raceway

C3. Abrasion Protection

C4. Cable Management

D1. Terminals

D2. Power Connectors

D3. Grounding Connectors

E1. Labeling Systems

E2. Labels

E3. Pre-Printed & Write-On Markers

E4. Permanent Identification

E5. Lockout/Tagout & Safety Solutions

F. Index



## Universal Beam Grounding Clamp

### Type GUBC

- Universal, fits on a wide range of standard (angled) and wide flange (parallel) structural steel beams
- Provide a mounting pad suitable for a two-hole compression lug
- Install quickly and easily with standard 1/4" key hex wrench tooling

- UL 467 Listed and CSA 22.2 Certified for grounding and bonding suitable for direct burial in earth or concrete
- Comply with vibration tests per MIL-STD-202G (METHOD 201A)

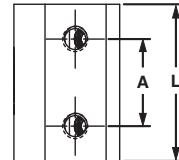
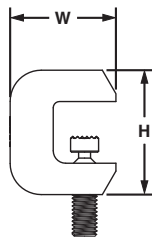
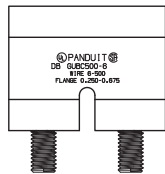

Part Number	Copper Conductor Size Range AWG (mm <sup>2</sup> )	Flange Thickness In. (mm)	Thread Size In.	Figure Dimensions In. (mm)				Std. Pkg. Qty.
				A	L	W	H	
<b>GUBC500-6</b>	#6 – 500 (16 – 240)	0.250 – 0.675 (6.3 – 17.1)	1/2 – 13	1.75 (44.4)	3.15 (80.0)	2.13 (54.0)	2.50 (63.5)	1

For stainless steel mounting hardware kit, see part number GLMHK on page D3.7.



## Grounding Plate Connector

### Type GPC

- Slotted design allows quick and easy assembly of conductor to connector using Panduit cable ties, included
- Pre-applied conductive antioxidant compound ensures a high quality mechanical and electrical bond, speeding installation
- Complies with vibration tests per MIL-STD-202G (METHOD 201A)
- Made from high conductivity copper; provides strength and premium electrical properties

- Color-coded and marked with Panduit die index numbers for proper crimp die selection
- UL 467 Listed and CSA 22.2 Certified for grounding and bonding suitable for direct burial in earth or concrete when crimped with Panduit or industry standard crimping tools and Panduit dies

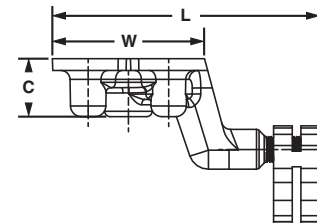
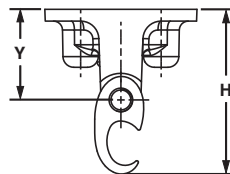
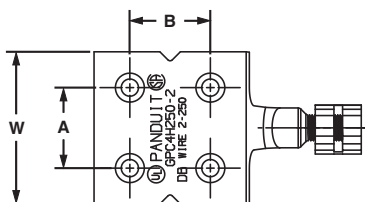

Part Number	Copper Conductor Size Range AWG (mm <sup>2</sup> )	Thread Size In.	Figure Dimensions In. (mm)							Panduit Color Code	Panduit Die Index No.‡	Std. Pkg. Qty.
			L	W	H	Y	A	B	C			
<b>GPC4H250-2</b>	#2 SOL – 250 kcmil (35 – 120)	1/2 – 13	5.81 (147.5)	3.31 (84.0)	3.58 (90.9)	1.97 (50.0)	1.75 (44.4)	1.75 (44.4)	1.26 (32.0)	Black	PG25	1

‡See page D3.90 for tool and die information.

For stainless steel mounting hardware kit, see part number GLMHK on page D3.7.



## Code Conductor, Thin Wall, CTAP

### For Copper Code Stranded Connections

#### Type CTAPF

- For copper-to-copper tapping, splicing or pigtailing
- Wide wire range-taking capability minimizes inventory requirements
- Color-coded for proper crimp die selection
- Ribbed design provides high strength

- Made from high conductivity wrought copper
- UL Listed and CSA Certified to 600 V and temperature rated to 90°C when crimped with Panduit and specified competitor crimping tools and dies<sup>^</sup>

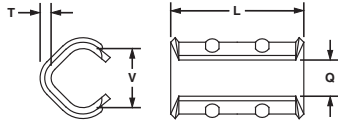

Part Number	Copper Conductor Size		Number of Ribs	Figure Dimensions In. (mm)				Panduit Color Code	Wire Strip Length In. (mm)	Std. Pkg. Qty.
	AWG Run (mm <sup>2</sup> )	AWG Tap (mm <sup>2</sup> )		L	T	V	Q			
CTAPF10-16-C*	#14 AWG (2.5)	#16 – #14 AWG (1.5 – 2.5)	0	0.41 (10.4)	0.06 (1.5)	.19 (4.8)	0.13 (3.3)	Red	1/2 (12.7)	100
	#12 AWG (4.0)	#16 – #12 AWG (1.5 – 4.0)								
	#10 AWG (6.0)	#14 AWG (2.5)								
CTAPF8-12-C‡	#10 AWG (6.0)	#10 AWG (6.0)	0	0.67 (17.0)	0.07 (1.8)	.26 (6.6)	0.19 (4.8)	Blue	11/16 (17.5)	100
	#8 AWG (10.0)	#12 AWG (4.0)								
CTAPF6-12-C‡	#8 AWG (10.0)	#10 – #8 AWG (6.0 – 10.0)	0	0.67 (17.0)	0.07 (1.8)	.32 (8.1)	0.24 (6.1)	Gray	11/16 (17.5)	100
	#6 AWG (16.0)	#12 – #10 AWG (4.0 – 6.0)								
CTAPF4-12-C‡	#6 AWG (16)	#8 – #6 AWG (10 – 16)	1	1.25 (31.8)	0.07 (1.8)	.40 (10.2)	0.28 (7.1)	Brown	1 5/16 (33.3)	100
	#5, #4 AWG (16, 25)	#12 – #8 AWG (4 – 10)								
CTAPF3-12-C‡	#5, #4 AWG (16, 25)	#6 – #5 AWG (16)	1	1.25 (31.8)	0.08 (2.0)	.46 (11.7)	0.31 (7.9)	Green	1 5/16 (33.3)	100
	#3 AWG (25)	#12 – #6 AWG (4 – 16)								
CTAPF2-12-C‡	#4 AWG (25)	#4 AWG (25)	1	1.25 (31.8)	0.08 (2.0)	.51 (13.0)	0.33 (8.4)	Pink	1 5/16 (33.3)	100
	#3 AWG (25)	#5 AWG (16)								
	#2 AWG (35)	#12 – #6 AWG (4 – 16)								
CTAPF1-12-C	#3 AWG (25)	#4 – #3 AWG (25)	2	1.82 (46.2)	0.08 (2.0)	.57 (14.5)	0.40 (10.2)	Black	1 7/8 (47.6)	100
	#2 AWG (35)	#5 – #4 AWG (16 – 25)								
	#1 AWG (35)	#12 – #5 AWG (4 – 16)								
CTAPF1/0-12-L	#2 AWG (35)	#4 – #2 AWG (25 – 35)	2	1.82 (46.2)	0.09 (2.3)	.63 (16.0)	0.42 (10.7)	Orange	1 7/8 (47.6)	50
	#1 AWG (35)	#4 – #3 AWG (25)								
	1/0 AWG (50)	#12 – #4 AWG (4 – 25)								
CTAPF2/0-12-Q	#1 AWG (35)	#2 – #1 AWG (35)	2	1.82 (46.2)	0.09 (2.3)	.71 (18.0)	0.48 (12.2)	Purple	1 7/8 (47.6)	25
	1/0 AWG (50)	#3 – #2 AWG (25 – 35)								
	2/0 AWG (70)	#12 – #3 AWG (4 – 35)								
CTAPF3/0-12-Q	1/0 AWG (50)	#1 – 1/0 AWG (50)	2	1.82 (46.2)	0.09 (2.3)	.81 (20.6)	0.55 (14.0)	Yellow	1 7/8 (47.6)	25
	2/0 AWG (70)	#2 – #1 AWG (35)								
	3/0 AWG (95)	#12 – #2 AWG (4 – 35)								

See pages D3.92 and D3.93 for tool and die information.

\*CTAPF10-16-C available with square, not flared ends.

All parts available in tin-plated; add TP before packaging code – example: CTAPF6-12TP-C.

<sup>^</sup>Note: CTAPF parts are UL Listed and CSA Certified with AWG wire only.

‡CSA Certified for grounding and bonding.

A. System Overview

B1. Cable Ties

B2. Cable Accessories

B3. Stainless Steel Ties

C1. Wiring Duct

C2. Surface Raceway

C3. Abrasion Protection

C4. Cable Management

D1. Terminals

D2. Power Connectors

D3. Grounding Connectors

E1. Labeling Systems

E2. Labels

E3. Pre-Printed & Write-On Markers

E4. Permanent Identification

E5. Lockout/Tagout & Safety Solutions

F. Index

A. System Overview

B1. Cable Ties

B2. Cable Accessories

B3. Stainless Steel Ties

C1. Wiring Duct

C2. Surface Raceway

C3. Abrasion Protection

C4. Cable Management

D1. Terminals

D2. Power Connectors

D3. Grounding Connectors

E1. Labeling Systems

E2. Labels

E3. Pre-Printed & Write-On Markers

E4. Permanent Identification

E5. Lockout/Tagout & Safety Solutions

F. Index

**UL LISTED Code Conductor, Heavy Duty, CTAP**

**For Use with Solid and Stranded Copper Code Conductors**

**Type CTAP**

- For tapping into unbroken continuous main, as a wire joint or two-way splice
- Wide wire range-taking capability minimizes inventory requirements
- Made from heavy wall, extruded, high conductivity copper; provides high strength and premium electrical properties

- UL Listed per UL 486 for use up to 35 KV\*\* and temperature rated 90°C when crimped with Panduit and specified competitor crimping tools and dies
- UL Listed per UL 467 for grounding and bonding suitable for direct burial in earth or concrete when crimped with Panduit and specified competitor crimping tools and dies^

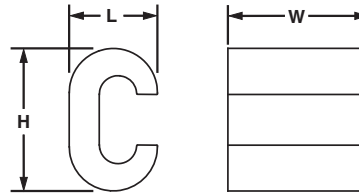

Part Number	Copper Conductor Size		Figure Dimensions In. (mm)			Panduit Die Index No.‡	Burdny Die Index No.‡	Wire Strip Length In. (mm)	Tap Cover*	Std. Pkg. Qty.
	AWG Run (mm²)	AWG Tap (mm²)	L	W	H					
<b>CTAP4-8-L</b>	#6 – #4 AWG SOL or STR (16 SOL or STR)	#8 AWG SOL or STR (10 SOL or STR)	0.46 (11.7)	0.63 (16.0)	0.73 (18.5)	PBG	BG	3/4 (19)	CVR6-1	50
<b>CTAP4-6-L</b>	#6 AWG STR, #4 AWG SOL or STR (16 SOL or STR)	#6 AWG SOL or STR (95 STR)	0.48 (12.2)	0.63 (16.0)	0.76 (19.3)	PBG	BG	3/4 (19)	CVR6-1	50
<b>CTAP4-4-L</b>	#4 AWG SOL or STR (16 SOL or STR)	#4 AWG STR (16 STR)	0.46 (11.7)	0.63 (16.0)	0.81 (20.6)	PBG	BG	3/4 (19)	CVR6-1	50
<b>CTAP2-4-Q</b>	#2 AWG SOL or STR (35 SOL or STR)	#8 – #4 AWG SOL or STR (10 – 16 SOL or STR)	0.60 (15.2)	0.76 (19.3)	0.96 (24.4)	PC	C	7/8 (22)	CVR2-1	25
<b>CTAP2-2-X</b>	#2 AWG SOL or STR (35 SOL or STR)	#2 AWG SOL or STR (25 SOL or STR)	0.60 (15.2)	0.75 (19.0)	1.05 (26.7)	PC	C	7/8 (22)	CVR2-1	10
<b>CTAP2/0-2-X</b>	1/0 – 2/0 AWG STR (70 STR)	#8 – #2 AWG SOL or STR (10 – 25 SOL or STR)	0.80 (20.3)	0.93 (23.6)	1.32 (33.5)	PO	O	1 1/16 (27)	CVR2-1	10
<b>CTAP2/0-2/0-X</b>	1/0 – 2/0 AWG STR (70 STR)	1/0 – 2/0 AWG STR (50 STR)	0.80 (20.3)	0.93 (23.6)	1.37 (34.8)	PO	O	1 1/16 (27)	CVR250-1	10
<b>CTAP4/0-2-X</b>	3/0 – 4/0 AWG STR (95 STR)	#6 – #2 AWG SOL or STR (16 – 35 SOL or STR)	0.94 (23.9)	1.08 (27.4)	1.66 (42.2)	PD3	F	1 1/4 (32)	CVR500-1	10
<b>CTAP4/0-2/0-X</b>	3/0 – 4/0 AWG STR (95 STR)	1/0 – 2/0 AWG STR (50 – 70 STR)	1.00 (25.4)	1.08 (27.3)	1.57 (39.9)	PD3	F	1 1/4 (32)	CVR500-1	10
<b>CTAP4/0-4/0-X</b>	3/0 – 4/0 AWG STR (95 STR)	3/0 – 4/0 AWG STR (95 STR)	1.00 (25.4)	1.08 (27.4)	1.57 (39.9)	PD3	F	1 1/4 (32)	CVR500-1	10

‡See page D3.91 for tool and die information.

\*See page D3.13 for type CVR CTAP covers.

\*\*Consult cable manufacturer for voltage stress relief instructions with applications greater than 2000 V.

^Note: CTAP parts are UL Listed and CSA Certified with AWG wire only.

**UL LISTED** **CSA CERTIFIED** **Clear Covers for HTCT HTAPs**

**Type CLRCVR**

- Made of high impact plastic to provide high impact strength and 360° inspections of crimped connection to assure the crimp is complete and the correct die was used
- Incorporate dual self-latching spring loaded latches and supplied with two Panduit UL 94 V-0 cable ties to allow for easy snap-on assembly and ensure covers are secured
- Low profile design minimizes space requirements
- Each cover half supports installation information labels inside plastic retainer strips to allow labels to be viewed on either side of cover and to protect labels from being removed

- Incorporate molded in flash barriers which encompass the HTAP installation providing protection against electrical flash over
- UL 94 V-0 flame rating and oxygen index of 28 providing self-extinguishing, flame retardant properties
- Part number, voltage rating, temperature rating and HTCT part number molded into cover for easy identification
- See page D3.33 for detailed installation instructions



Part Number	Use with HTAP Part Number	Figure Dimensions In. (mm)			Std. Pkg. Qty.
		L	W	H	
CLRCVR1-1	HTCT6X-6X	4.48 (113.8)	1.41 (35.8)	1.20 (30.5)	1
CLRCVR2-1	HTCT2-2	5.10 (129.5)	1.66 (42.2)	1.40 (35.6)	1
CLRCVR3-1	HTCT250-2, HTCT250-250	5.35 (135.9)	2.16 (54.9)	1.40 (35.6)	1

**UL LISTED** **CSA CERTIFIED** **Black Covers for Copper HTAPs and CTAPs**

- Used to insulate connectors and protect tap connections from corrosive environments
- UL Listed and CSA Certified with approved connectors for use up to 600 V and temperature rated to 90° C

- Made of durable, weather-resistant black polypropylene
- Double locking latches provide secure cover installation

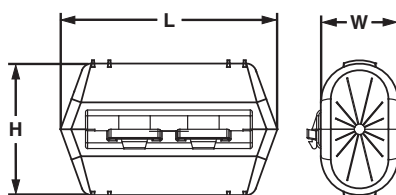

Part Number	Use with CTAP Part Number	Use with HTAP Part Number	Figure Dimensions (In.)			Std. Pkg. Qty.
			L	W	H	
CVR6-1	CTAP4-8-L, CTAP4-6-L, CTAP4-4-L	HTCT6X-6X-1	2.00	1.20	1.26	1
CVR2-1	CTAP2-4-Q, CTAP2-2-X, CTAP2/0-2-X	HTCT2-2-1	3.38	1.40	2.00	1
CVR250-1	CTAP2/0-2/0-X	HTCT250-2-1, HTCT250-250-1	3.38	1.55	2.05	1
CVR500-1*	CTAP4/0-2-X, CTAP4/0-2/0-X, CTAP4/0-4/0-X	—	3.86	1.97	2.66	1
CVR1000-1*	—	—	5.62	2.45	3.72	1

For information on copper HTAPs, see page D3.14  
 For information on copper CTAPs, see page D3.12  
 \*Not CSA Certified.

A. System Overview

B1. Cable Ties

B2. Cable Accessories

B3. Stainless Steel Ties

C1. Wiring Duct

C2. Surface Raceway

C3. Abrasion Protection

C4. Cable Management

D1. Terminals

D2. Power Connectors

D3. Grounding Connectors

E1. Labeling Systems

E2. Labels

E3. Pre-Printed & Write-On Markers

E4. Permanent Identification

E5. Lockout/Tagout & Safety Solutions

F. Index

A. System Overview



## Code/Flex Conductor HTAP

B1. Cable Ties

### For Making Parallel and Multiple Tap Connections on Code and Flex Conductors

#### Type HTCT

B2. Cable Accessories

- Used to tap into continuous conductors as a splice or pigtailling
- Each HTAP terminates a wide range of conductor sizes and combinations of code and flex conductors Class G, H, I and Diesel Locomotive to suit a variety of applications
- Slotted design allows quick and easy assembly of conductor to HTAP using three Panduit 94V-0 cable ties included
- Tap grooves are separated from one another allowing them to function independently so HTAP can be used with a single or multiple taps providing maximum design and installation flexibility
- Color-coded and marked with Panduit die index numbers for proper crimp die selection
- UL Listed and CSA Certified for applications up to 600 V when crimped with Panduit and specified competitor crimping tools and Panduit crimping dies<sup>‡</sup>
- Tin-plated to inhibit corrosion

B3. Stainless Steel Ties

C1. Wiring Duct

C2. Surface Raceway

C3. Abrasion Protection



C4. Cable Management

D1. Terminals

D2. Power Connectors

D3. Grounding Connectors

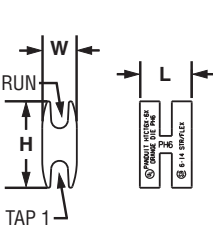

HTCT6X-6X

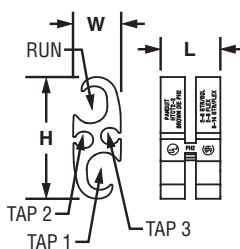

HTCT2-2

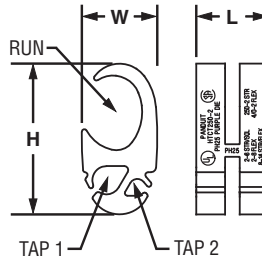

HTCT250-2

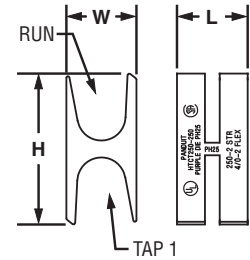

HTCT250-250

Part Number	Wire Strand Type	Copper Conductor Size Range				Figure Dimensions In. (mm)			Panduit Die Color and Die No.‡	Wire Strip Length In. (mm)	Std. Pkg. Qty.
		Run	Tap 1	Tap 2	Tap 3	L	W	H			
HTCT6X-6X-1	Code	#6 – #14 AWG (10 – 2.5)	#6 – #14 AWG (10 – 2.5)	—	—	0.60 (15.2)	0.40 (10.2)	1.00 (25.4)	Orange PH6	11/16 (18)	1
	Flex	#6 – #14 AWG (10 – 2.5)	#6 – #14 AWG (10 – 2.5)	—	—						
HTCT2-2-1	Code	#2 – #6 AWG STR/SOL (25 – 16)	#2 – #6 AWG STR/SOL (25 – 16)	#8 – #14 AWG (6 – 2.5)	#8 – #14 AWG (6 – 2.5)	0.76 (19.3)	0.61 (15.5)	1.55 (39.4)	Brown PH2	13/16 (21)	1
	Flex	#2 – #8 AWG (25 – 10)	#2 – #8 AWG (25 – 10)	#8 – #14 AWG (6 – 2.5)	#8 – #14 AWG (6 – 2.5)						
HTCT250-2-1	Code	250 kcmil – #2 AWG (120 – 35)	#2 – #6 AWG STR/SOL (25 – 16)	#8 – #14 AWG (6 – 2.5)	—	0.92 (23.4)	0.96 (24.4)	1.92 (48.8)	Purple PH25	1 (25)	1
	Flex	4/0 – #2 AWG (95 – 35)	#2 – #8 AWG (25 – 10)	#8 – #14 AWG (6 – 2.5)	—						
HTCT250-250-1	Code	250 kcmil – #2 AWG (120 – 35)	250 kcmil – #2 AWG (120 – 35)	—	—	0.90 (22.9)	0.89 (22.6)	1.92 (48.8)	Purple PH25	1 (25)	1
	Flex	4/0 – #2 AWG (95 – 35)	4/0 – #2 AWG (95 – 35)	—	—						

‡See page D3.94 for tool and die information.

^Note: HTCT parts are UL Listed and CSA Certified with AWG wire only.

E1. Labeling Systems

E2. Labels

E3. Pre-Printed & Write-On Markers

E4. Permanent Identification

E5. Lockout/Tagout & Safety Solutions

F. Index



**UL LISTED** **CSA CERTIFIED** **Code/Flex Conductor HTAP Kit**

**Type HTWC**

- Include all components to make a complete HTAP and cover installation: HTCT HTAP, matching CLRCVR clear cover, and cable ties
- Each HTCT HTAP designed to terminate a wide range of copper code and flex conductor combinations to accommodate a variety of applications
- HTAPs incorporate a unique slotted design that allows for quick and easy installation using supplied Panduit cable ties; saves time and cost
- Matching clear covers are made from high impact plastic and provide high impact strength and 360° viewing of installed HTAP
- Clear covers have a UL 94 V-0 flame rating and an oxygen index of 28 providing self-extinguishing, flame retardant properties
- UL Listed and CSA Certified for applications up to 600 V when crimped with Panduit and specified competitor crimping tools and Panduit crimping dies<sup>^</sup>
- See page D3.33 for detailed installation instructions

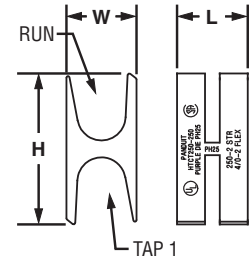
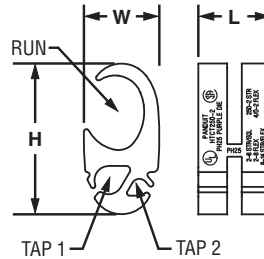
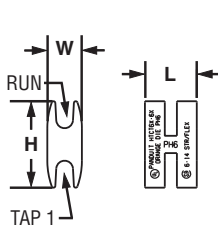

Part Number	Components		Wire Strand Type	Copper Conductor Size Range AWG (mm <sup>2</sup> )				Std. Pkg. Qty.
	HTAP Part No.	Clear Cover Part No.		Run	Tap 1	Tap 2	Tap 3	
HTWC6X-6X-1	HTCT6X-6X-1	CLRCVR1-1	Code	#6 – #14 AWG (10 – 2.5)	#6 – #14 AWG (10 – 2.5)	—	—	1
			Flex	#6 – #10 AWG (10 – 2.5)	#6 – #14 AWG (10 – 2.5)	—	—	
HTWC2-2-1	HTCT2-2-1	CLRCVR2-1	Code	#2 – #6 AWG STR/SOL (25 – 16)	#2 – #6 AWG STR/SOL (25 – 16)	#8 – #14 AWG (6 – 2.5)	#8 – #14 AWG (6 – 2.5)	1
			Flex	#2 – #8 AWG (25 – 10)	#2 – #8 AWG (25 – 10)	#8 – #14 AWG (6 – 2.5)	#8 – #14 AWG (6 – 2.5)	
HTWC250-2-1	HTCT250-2-1	CLRCVR3-1	Code	250 kcmil – #2 AWG (120 – 35)	#2 – #6 AWG STR/SOL (25 – 16)	#8 – #14 AWG (6 – 2.5)	—	1
			Flex	4/0 – #2 AWG (95 – 35)	#2 – #8 AWG (25 – 10)	#8 – #14 AWG (6 – 2.5)	—	
HTWC250-250-1	HTCT250-250-1	CLRCVR3-1	Code	250 kcmil – #2 AWG (120 – 35)	250 kcmil – #2 AWG (120 – 35)	—	—	1
			Flex	4/0 – #2 AWG (95 – 35)	4/0 – #2 AWG (95 – 35)	—	—	

See pages D3.13 – D3.14 for more information on HTAPs and clear covers, including tap sizes and locations.

<sup>^</sup>Note: HTCT parts are UL Listed and CSA Certified with AWG wire only.

A. System Overview

B1. Cable Ties

B2. Cable Accessories

B3. Stainless Steel Ties

C1. Wiring Duct

C2. Surface Raceway

C3. Abrasion Protection

C4. Cable Management

D1. Terminals

D2. Power Connectors

D3. Grounding Connectors

E1. Labeling Systems

E2. Labels

E3. Pre-Printed & Write-On Markers

E4. Permanent Identification

E5. Lockout/Tagout & Safety Solutions

F. Index

A. System Overview

B1. Cable Ties

B2. Cable Accessories

B3. Stainless Steel Ties

C1. Wiring Duct

C2. Surface Raceway

C3. Abrasion Protection

C4. Cable Management

D1. Terminals

D2. Power Connectors

D3. Grounding Connectors

E1. Labeling Systems

E2. Labels

E3. Pre-Printed & Write-On Markers

E4. Permanent Identification

E5. Lockout/Tagout & Safety Solutions

F. Index

## Features and Benefits – StructuredGround™ Mechanical Connectors

### Bronze Grounding Clamp

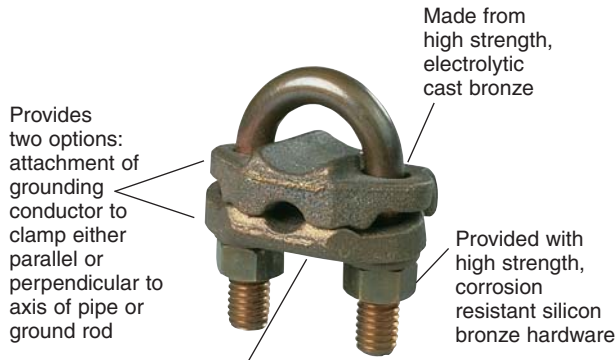

Part number, conductor range, rod and pipe size range and "DB" suitable for direct burial marked on part for easy identification



### Bronze Service Post Connector

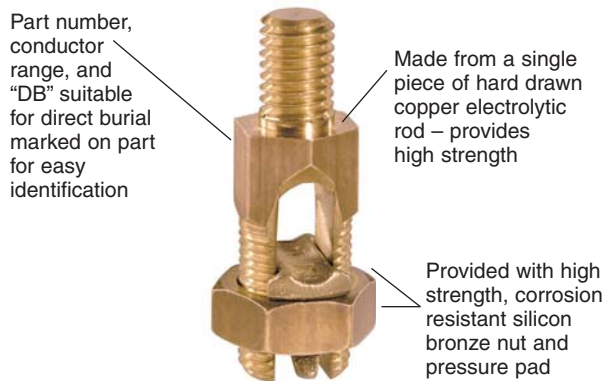

Available in configurations for use with one or two copper conductors with either a standard or long stud length



### Bronze Water Pipe Clamp

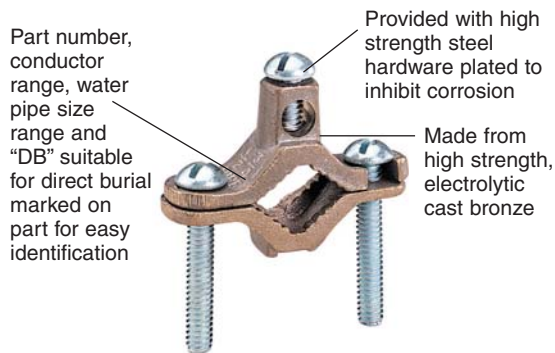

Each part accommodates a wide range of copper conductor sizes and water pipe sizes – minimizes inventory





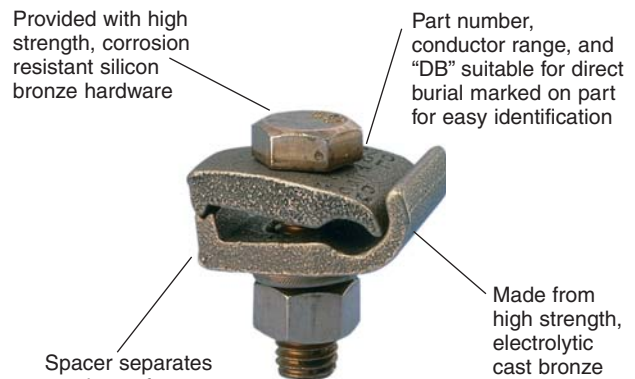

### Bronze Grounding Clamp

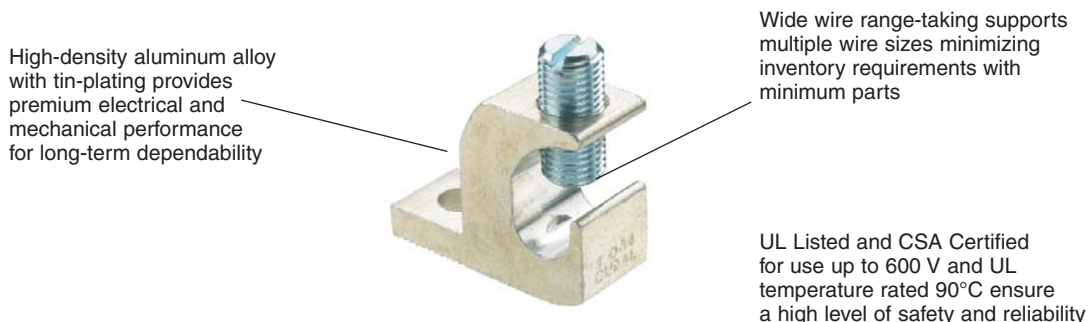

### Aluminum Lay-In Lug



## Selection Guide – StructuredGround™ Mechanical Connectors

UL Listed Direct Burial	Service Post Type	Stud Size (In.)	Thread Length (In.)	Copper Code Conductor Size																			
				#12 AWG	#10 AWG	#8 AWG	#7 AWG	#6 AWG	#4 AWG	#3 AWG	#2 AWG	#1 AWG	1/0 AWG	2/0 AWG	3/0 AWG	4/0 AWG	250 kcmil	300 kcmil	350 kcmil	400 kcmil	500 kcmil		
				Panduit Part Number																			
	Bronze Service Post One Conductor SP1	1/4-20	1/2	SP1-8-C*																			
			1	SP1-8L-C*																			
		1/4-20	1/2		SP1-7-C*																		
			1		SP1-7L-C*																		
		5/16-18	9/16		SP1-4-C*																		
			1		SP1-4L-C*																		
		3/8-16	5/8		SP1-3-C*																		
			1 1/8		SP1-3L-C*																		
			5/8		SP1-2-C																		
		1/2-13	1 1/8		SP1-2L-C																		
			3/4		SP1-1/0-L*																		
			1 1/4		SP1-1/0L-L*																		
			3/4		SP1-2/0-Q*																		
		5/8-11	1 1/4		SP1-2/0L-Q*																		
			1		SP1-4/0-Q*																		
			1 1/2		SP1-4/0L-Q*																		
			1		SP1-350-12																		
		3/4-10	1 1/2		SP1-350L-12																		
			1 1/2		SP1-500-12																		
			1 3/8		SP1-500L-12																		
		1 3/4																					
	Bronze Service Post Two Conductors SP2	1/4-20	1/2	SP2-8-C*																			
			1	SP2-8L-C*																			
		1/4-20	1/2		SP2-7-C*																		
			1		SP2-7L-C*																		
		5/16-18	9/16		SP2-4-C*																		
			1		SP2-4L-C*																		
		3/8-16	5/8		SP2-3-C*																		
			1 1/8		SP2-3L-C*																		
			5/8		SP2-2-C*																		
		1/2-13	1 1/8		SP2-2L-C*																		
			3/4		SP2-1/0-L*																		
			1 1/4		SP2-1/0L-L*																		
			3/4		SP2-2/0-Q*																		
		5/8-11	1 1/4		SP2-2/0L-Q*																		
			1		SP2-4/0-Q*																		
			1 1/2		SP2-4/0L-Q*																		
			1		SP2-350-12																		
		3/4-10	1 1/2		SP2-350L-12																		
			1 3/8		SP2-500-12																		
			1 3/4		SP2-500L-12																		
	Bronze Service Post One Conductor SPF1	1/4-20	1/4	SPF1-8-C*																			
				SPF1-7-C*																			
		5/16-18	5/16		SPF1-4-C*																		
		3/8-16	3/8		SPF1-3-C																		
				SPF1-2-C																			
		1/2-13	7/16		SPF1-1/0-L*																		
			1/2		SPF1-2/0-Q*																		
5/8-11	5/8		SPF1-4/0-Q																				
3/4-10	3/4		SPF1-350-12																				
3/4-10	3/4		SPF1-500-12																				
	Bronze Service Post Two Conductors SPF2	1/4-20	1/4	SPF2-8-C*																			
				SPF2-7-C*																			
		5/16-18	5/16		SPF2-4-C*																		
		3/8-16	3/8		SPF2-3-C*																		
				SPF2-2-C*																			
		1/2-13	7/16		SPF2-1/0-L*																		
			1/2		SPF2-2/0-Q*																		
5/8-11	5/8		SPF2-4/0-Q*																				
		SPF2-350-12																					
3/4-10	3/4		SPF2-500-12																				

\*Denotes minimum conductor size is solid conductor.

For technical assistance in the U.S., call 866-405-6654 (outside the U.S., see inside back cover for directory)

A.  
System Overview

B1.  
Cable Ties

B2.  
Cable Accessories

B3.  
Stainless Steel Ties

C1.  
Wiring Duct

C2.  
Surface Raceway

C3.  
Abrasion Protection

C4.  
Cable Management

D1.  
Terminals

D2.  
Power Connectors

D3.  
Grounding Connectors

E1.  
Labeling Systems

E2.  
Labels

E3.  
Pre-Printed & Write-On Markers

E4.  
Permanent Identification

E5.  
Lockout/Tagout & Safety Solutions

F.  
Index

## Selection Guide – StructuredGround™ Mechanical Connectors (continued)

A. System Overview	UL Listed Direct Burial	Ground Clamp Type	Ground Rod Size (In.)	Pipe Size (In.)	Copper Code Conductor Size																			
					#14 AWG	#12 AWG	#10 AWG	#8 AWG	#7 AWG	#6 AWG	#4 AWG	#3 AWG	#2 AWG	#1 AWG	1/0 AWG	2/0 AWG	3/0 AWG	4/0 AWG	250 kcmil	300 kcmil	350 kcmil	400 kcmil	500 kcmil	
Panduit Part Number																								
B1. Cable Ties	 D3.24	One Barrel, One-Hole LI	—	—	<b>LI-50S-C@ #10 stud hole</b>					<b>LI-112-L@ 1/4" stud hole</b>					<b>LI-252S-Q@ 5/16" stud hole</b>									
B2. Cable Accessories	 D3.25	Bronze Ground Clamp One Conductor GPL	5/8 or 3/4	3/8	<b>GPL-4-Q*</b>					<b>GPL-5-Q*</b>					<b>GPL-6-Q*</b>									
B3. Stainless Steel Ties			7/8 or 1	1/2 or 3/4	<b>GPL-8-Q*</b>					<b>GPL-9-Q*</b>					<b>GPL-10-Q*</b>									
C1. Wiring Duct			—	1	<b>GPL-14-X*</b>					<b>GPL-15-X*</b>					<b>GPL-16-X*</b>									
C2. Surface Raceway			—	1 1/4	<b>GPL-20-X*</b>					<b>GPL-21-X*</b>					<b>GPL-22-X*</b>									
C3. Abrasion Protection			—	1 1/2	<b>GPL-26-X*</b>					<b>GPL-27-X*</b>					<b>GPL-28-X*</b>									
C4. Cable Management			—	2	<b>GPL-32-3*</b>					<b>GPL-33-3*</b>					<b>GPL-34-3*</b>									
			—	2 1/2	<b>GPL-39-3*</b>					<b>GPL-40-3*</b>														
			—	3	<b>GPL-44-1*</b>					<b>GPL-45-1*</b>					<b>GPL-46-1*</b>									
			—	3 1/2	<b>GPL-51-1*</b>					<b>GPL-52-1*</b>														
			—	4	<b>GPL-57-1*</b>					<b>GPL-58-1*</b>														
D1. Terminals	 D3.26	Bronze Ground Clamp Two Conductors GU	—	1	<b>GU-2-X* ‡</b>																			
	—	1 1/4	<b>GU-4-X* ‡</b>																					
	—	2																<b>GU-13-3 ‡</b>						
D2. Power Connectors	 D3.26	Bronze Ground Clamp KP	—	1/2-#1	<b>KP1-C* @</b>																			
	—	1 1/4-#2	<b>KP2-L* @</b>																					
D3. Grounding Connectors	 D3.27	Bronze Ground Clamp KLS	—	1/2-1	<b>KLS-0-Q* ‡ 1/2" hub size</b>																			
	—	1/2-1	<b>KLS-1-Q* ‡ 3/4" hub size</b>																					
	—	1/2-1	<b>KLS-1A-X* ‡ 1" hub size</b>																					
E1. Labeling Systems	 D3.27	Bronze Ground Clamp KH	—	1/2-1	<b>KH-1-L* ‡ 1/2" hub size</b>																			
	—	1 1/4-2	<b>KH-2-L* ‡ 1/2" hub size</b>																					
E2. Labels	 D3.28	Aluminum Ground Clamp GC	—	1/2-3/4-1	<b>GC-15A-Q @ DR</b>																			
	—	1 1/4-1 1/2-2	<b>GC-18A-X @ DR</b>																					
	—	2 1/2-3-3 1/2-4	<b>GC-22A-4 @ DR</b>																					
E3. Pre-Printed & Write-On Markers	 D3.28	Bronze Ground Rod Clamp WB	1/2	—	<b>WB12-L*</b>																			
	—	5/8	<b>WB34-X</b>																					
	—	3/4	<b>WB34-X</b>																					
E4. Permanent Identification	 D3.28	Bronze Ground Rod Clamp WB	5/8	—	<b>WB58-Q</b>																			
	—	5/8	<b>GMS-1-X*</b>																					
E5. Lockout/Tagout & Safety Solutions	 D3.29	Bronze Ground Clamp GMS	—	—	<b>GMS-2-Q*</b>										<b>GMS-3-Q*</b>									
	—	—	<b>GM-2-Q*</b>																					
F. Index	 D3.29	Bronze Ground Clamp GM	—	—											<b>GM-3-Q*</b>									

\*Denotes minimum conductor size is solid conductor.

@Denotes not UL Listed for Direct Burial.

DR Denotes Dual Rated for use with copper or aluminum conductors.

‡Denotes not UL Listed or CSA Certified.

## Panduit Grounding Connector Approvals



Logo (Symbol)	Agency	Spec/Approval	Applicable Products
	Underwriters Laboratories, Inc.	UL 486A Wire Connectors and Soldering Lugs for use in US and Canada	As shown on product pages.
	Underwriters Laboratories, Inc.	UL 486A – 486B Wire Connectors and Soldering Lugs for use in US	As shown on product pages.
	Underwriters Laboratories, Inc.	UL 467 Grounding and Bonding Equipment for use in US and Canada	As shown on product pages.
	Underwriters Laboratories, Inc.	UL 467 Grounding and Bonding Equipment for use in US	As shown on product pages.
	Canadian Standards Association	C22.2 No. 65-03 Wire Connectors	As shown on product pages.
	Canadian Standards Association	C22.2 No. 41-M1987 (R1999) Grounding and Bonding Equipment	As shown on product pages.
	Institute of Electrical and Electronics Engineers	IEEE Std. 837™ - 2002 IEEE Standard for Qualifying Permanent Connection used in Substation Grounding	As shown on product pages.

A.  
System Overview

B1.  
Cable Ties

B2.  
Cable Accessories

B3.  
Stainless Steel Ties

C1.  
Wiring Duct

C2.  
Surface Raceway

C3.  
Abrasion Protection

C4.  
Cable Management

D1.  
Terminals

D2.  
Power Connectors

D3.  
Grounding Connectors

E1.  
Labeling Systems

E2.  
Labels

E3.  
Pre-Printed & Write-On Markers

E4.  
Permanent Identification

E5.  
Lockout/Tagout & Safety Solutions

F.  
Index

A. System Overview

B1. Cable Ties

B2. Cable Accessories

B3. Stainless Steel Ties

C1. Wiring Duct

C2. Surface Raceway

C3. Abrasion Protection

C4. Cable Management

D1. Terminals

D2. Power Connectors

D3. Grounding Connectors

E1. Labeling Systems

E2. Labels

E3. Pre-Printed & Write-On Markers

E4. Permanent Identification

E5. Lockout/Tagout & Safety Solutions

F. Index



## Service Post Connector, Male Stud, Single Conductor, Bronze

### Type SP1

- For grounding one copper code conductor to steel structures, busbars, or transformers or for tapping from busbar with hex nut and washer
- Made from high copper content, hard drawn copper rod provides high strength
- Offered with standard and long stud lengths to accommodate a variety of mounting applications
- Wide wire range-taking capability minimizes inventory requirements
- True hex design for body and nut hex provides correct fit with socket, box, or open end wrenches resulting in proper torquing of electrical connection
- Pressure bar provides secure connection on a full range of conductor combinations used with each connector providing premium wire pull-out strength
- UL Listed for grounding and bonding and suitable for direct burial in earth or concrete

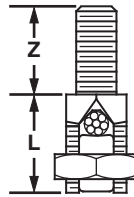

Part Number	Conductor Size Range	Stud Size*	Figure Dimensions In. (mm)		Nut Hex (In.)	Body Hex (In.)	Std. Pkg. Qty.
			L	Z			
SP1-8-C	#12 SOL – #8 STR	1/4 – 20	0.63 (16.0)	0.50 (12.7)	0.50	0.38	100
SP1-8L-C			0.63 (16.0)	1.00 (25.4)			
SP1-7-C	#8 SOL – #7 STR	1/4 – 20	0.88 (22.4)	0.50 (12.7)	0.69	0.50	100
SP1-7L-C			0.88 (22.4)	1.00 (25.4)			
SP1-4-C	#10 SOL – #4 STR	5/16 – 18	0.94 (23.9)	0.56 (14.2)	0.75	0.56	100
SP1-4L-C			0.94 (23.9)	1.00 (25.4)			
SP1-3-C	#6 SOL – #3 STR	3/8 – 16	1.06 (26.9)	0.63 (16)	0.81	0.63	100
SP1-3L-C			1.06 (26.9)	1.13 (28.7)			
SP1-2-C	#4 STR – #2 STR	3/8 – 16	1.06 (26.9)	0.63 (16)	0.88	0.69	100
SP1-2L-C			1.06 (26.9)	1.13 (28.7)			
SP1-1/0-L	#6 SOL – 1/0 STR	1/2 – 13	1.31 (33.3)	0.75 (19.1)	1.00	0.75	50
SP1-1/0L-L			1.31 (33.3)	1.25 (31.8)			
SP1-2/0-Q	#1 SOL – 2/0 STR	1/2 – 13	1.44 (36.6)	0.75 (19.1)	1.13	0.88	25
SP1-2/0L-Q			1.44 (36.6)	1.25 (31.8)			
SP1-4/0-Q	3/0 SOL – 4/0 STR	5/8 – 11	1.69 (42.9)	1.00 (25.4)	1.38	1.13	25
SP1-4/0L-Q			1.69 (42.9)	1.50 (38.1)			
SP1-350-12	4/0 STR – 350 kcmil	5/8 – 11	2.00 (50.8)	1.00 (25.4)	1.50	1.25	12
SP1-350L-12			2.00 (50.8)	1.50 (38.1)			
SP1-500-12	250 kcmil – 500 kcmil	3/4 – 10	2.31 (58.7)	1.38 (35.1)	1.81	1.50	12
SP1-500L-12			2.31 (58.7)	1.75 (44.5)			

\*UNC threads.



## Service Post Connector, Male Stud, Two Conductor, Bronze

### Type SP2

- For grounding two copper code conductors to steel structures, busbars, or transformers or for tapping from busbar with hex nut and washer
- Made from high copper content, hard drawn copper rod provides high strength
- Offered with standard and long stud lengths to accommodate a variety of mounting applications
- Wide wire range-taking capability minimizes inventory requirements
- True hex design for body and nut hex provides correct fit with socket, box, or open end wrenches resulting in proper torquing of electrical connection
- Pressure bar provides secure connection on a full range of conductor combinations used with each connector providing premium wire pull-out strength
- UL Listed for grounding and bonding and suitable for direct burial in earth or concrete



Part Number	Conductor Size Range	Stud Size*	Figure Dimensions In. (mm)		Nut Hex (In.)	Body Hex (In.)	Std. Pkg. Qty.
			L	Z			
SP2-8-C	#12 SOL – #8 STR	1/4 – 20	0.75 (19.0)	0.50 (12.7)	0.50	0.38	100
SP2-8L-C			0.75 (19.0)	1.00 (25.4)			
SP2-7-C	#10 SOL – #7 STR	1/4 – 20	1.00 (25.4)	0.50 (12.7)	0.69	0.50	100
SP2-7L-C			1.00 (25.4)	1.00 (25.4)			
SP2-4-C	#10 SOL – #4 STR	5/16 – 18	1.16 (29.5)	0.56 (14.2)	0.75	0.56	100
SP2-4L-C			1.16 (29.5)	1.00 (25.4)			
SP2-3-C	#10 SOL – #3 STR	3/8 – 16	1.09 (27.7)	0.63 (16)	0.81	0.63	100
SP2-3L-C			1.09 (27.7)	1.13 (28.7)			
SP2-2-C	#10 SOL – #2 STR	3/8 – 16	1.38 (35.1)	0.63 (16)	0.88	0.69	100
SP2-2L-C			1.28 (32.5)	1.13 (28.7)			
SP2-1/0-L	#2 SOL – 1/0 STR	1/2 – 13	1.69 (42.9)	0.75 (19.1)	1.00	0.75	50
SP2-1/0L-L			1.69 (42.9)	1.25 (31.8)			
SP2-2/0-Q	#2 SOL – 2/0 STR	1/2 – 13	1.88 (47.8)	0.75 (19.1)	1.13	0.88	25
SP2-2/0L-Q			1.88 (47.8)	1.25 (31.8)			
SP2-4/0-Q	#1 SOL – 4/0 STR	5/8 – 11	2.25 (57.2)	1.00 (25.4)	1.38	1.13	25
SP2-4/0L-Q			2.25 (57.2)	1.50 (38.1)			
SP2-350-12	#1 STR – 350 kcmil	5/8 – 11	2.69 (68.3)	1.00 (25.4)	1.50	1.25	12
SP2-350L-12			2.69 (68.3)	1.50 (38.1)			
SP2-500-12	3/0 STR – 500 kcmil	3/4 – 10	3.19 (81.0)	1.38 (35.1)	1.81	1.50	12
SP2-500L-12			3.19 (81.0)	1.75 (44.5)			

\*UNC threads.

A.  
System  
Overview

B1.  
Cable Ties

B2.  
Cable  
Accessories

B3.  
Stainless  
Steel Ties

C1.  
Wiring  
Duct

C2.  
Surface  
Raceway

C3.  
Abrasion  
Protection

C4.  
Cable  
Management

D1.  
Terminals

D2.  
Power  
Connectors

D3.  
Grounding  
Connectors

E1.  
Labeling  
Systems

E2.  
Labels

E3.  
Pre-Printed  
& Write-On  
Markers

E4.  
Permanent  
Identification

E5.  
Lockout/  
Tagout  
& Safety  
Solutions

F.  
Index

A. System Overview

B1. Cable Ties

B2. Cable Accessories

B3. Stainless Steel Ties

C1. Wiring Duct

C2. Surface Raceway

C3. Abrasion Protection

C4. Cable Management

D1. Terminals

D2. Power Connectors

D3. Grounding Connectors

E1. Labeling Systems

E2. Labels

E3. Pre-Printed & Write-On Markers

E4. Permanent Identification

E5. Lockout/Tagout & Safety Solutions

F. Index

**UL LISTED** **Service Post Connector, Female Thread, Single Conductor, Bronze**

**Type SPF1**

- For grounding one copper code conductor to steel structures, busbars, or transformers or for tapping from busbar using external studs, screws, or bolts
- Made from high copper content, hard drawn copper rod provides high strength
- Wide wire range-taking capability minimizes inventory requirements
- True hex design for body and nut hex provides correct fit with socket, box, or open end wrenches resulting in proper torquing of electrical connection
- Pressure bar provides secure connection on a full range of conductor combinations used with each connector providing premium wire pull-out strength
- UL Listed for grounding and bonding and suitable for direct burial in earth or concrete

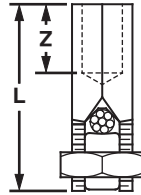

Part Number	Conductor Size Range	Thread Size*	Figure Dimensions In. (mm)		Nut Hex (In.)	Body Hex (In.)	Std. Pkg. Qty.
			L	Z			
<b>SPF1-8-C</b>	#12 SOL – #8 STR	1/4 – 20	0.91 (23.1)	0.25 (6.4)	0.50	0.38	100
<b>SPF1-7-C</b>	#10 SOL – #7 STR	1/4 – 20	1.13 (28.7)	0.25 (6.4)	0.69	0.50	100
<b>SPF1-4-C</b>	#8 SOL – #4 STR	5/16 – 18	1.44 (36.6)	0.31 (7.9)	0.75	0.56	100
<b>SPF1-3-C</b>	#6 STR – #3 STR	3/8 – 16	1.50 (38.1)	0.38 (9.7)	0.81	0.63	100
<b>SPF1-2-C</b>	#6 STR – #2 STR	3/8 – 16	1.63 (41.4)	0.38 (9.7)	0.88	0.69	100
<b>SPF1-1/0-L</b>	#2 SOL – 1/0 STR	1/2 – 13	1.88 (47.8)	0.44 (11.2)	1.00	0.75	50
<b>SPF1-2/0-Q</b>	#1 SOL – 2/0 STR	1/2 – 13	2.06 (52.3)	0.50 (12.7)	1.13	0.88	25
<b>SPF1-4/0-Q</b>	1/0 STR – 4/0 STR	5/8 – 11	2.38 (60.5)	0.63 (16)	1.38	1.13	25
<b>SPF1-350-12</b>	4/0 STR – 350 kcmil	5/8 – 11	2.63 (66.8)	0.63 (16)	1.50	1.25	12
<b>SPF1-500-12</b>	300 kcmil – 500 kcmil	3/4 – 10	3.13 (79.5)	0.75 (19.1)	1.81	1.50	12

\*UNC threads.





## Service Post Connector, Female Thread, Two Conductor, Bronze

### Type SPF2

- For grounding two copper code conductors to steel structures, busbars, or transformers or for tapping from busbar using external threaded studs, screws, or bolts
- Made from high copper content, hard drawn copper rod provides high strength
- Wide wire range-taking capability minimizes inventory requirements
- True hex design for body and nut hex provides correct fit with socket, box, or open end wrenches resulting in proper torquing of electrical connection
- Pressure bar provides secure connection on a full range of conductor combinations used with each connector providing premium wire pull-out strength
- UL Listed for grounding and bonding and suitable for direct burial in earth or concrete



Part Number	Conductor Size Range	Thread Size*	Figure Dimensions In. (mm)		Nut Hex (In.)	Body Hex (In.)	Std. Pkg. Qty.
			L	Z			
SPF2-8-C	#12 SOL – #8 STR	1/4 – 20	1.13 (28.7)	0.25 (6.4)	0.50	0.38	100
SPF2-7-C	#10 SOL – #7 STR	1/4 – 20	1.44 (36.6)	0.25 (6.4)	0.69	0.50	100
SPF2-4-C	#10 SOL – #4 STR	5/16 – 18	1.56 (39.6)	0.31 (7.9)	0.75	0.56	100
SPF2-3-C	#10 SOL – #3 STR	3/8 – 16	1.63 (41.4)	0.38 (9.7)	0.81	0.63	100
SPF2-2-C	#10 SOL – #2 STR	3/8 – 16	1.94 (49.3)	0.38 (9.7)	0.88	0.69	100
SPF2-1/0-L	#2 SOL – 1/0 STR	1/2 – 13	2.13 (54.1)	0.44 (11.2)	1.00	0.75	50
SPF2-2/0-Q	#2 SOL – 2/0 STR	1/2 – 13	2.31 (58.7)	0.50 (12.7)	1.13	0.88	25
SPF2-4/0-Q	#1 SOL – 4/0 STR	5/8 – 11	2.50 (63.5)	0.63 (16)	1.38	1.13	25
SPF2-350-12	#1 STR – 350 kcmil	5/8 – 11	2.69 (68.3)	0.63 (16)	1.50	1.25	12
SPF2-500-12	3/0 STR – 500 kcmil	3/4 – 10	3.31 (84.1)	0.75 (19.1)	1.81	1.50	12

\*UNC threads.

A.  
System  
Overview

B1.  
Cable Ties

B2.  
Cable  
Accessories

B3.  
Stainless  
Steel Ties

C1.  
Wiring  
Duct

C2.  
Surface  
Raceway

C3.  
Abrasion  
Protection

C4.  
Cable  
Management

D1.  
Terminals

D2.  
Power  
Connectors

D3.  
Grounding  
Connectors

E1.  
Labeling  
Systems

E2.  
Labels

E3.  
Pre-Printed  
& Write-On  
Markers

E4.  
Permanent  
Identification

E5.  
Lockout/  
Tagout  
& Safety  
Solutions

F.  
Index

A. System Overview



## One-Hole Aluminum Lay-In Lug

B1. Cable Ties

### Type LI

B2. Cable Accessories

- Used for quick installation of a continuous grounding conductor
- Made from high strength, extruded aluminum alloy to provide premium electrical and mechanical performance
- Tin-plated to inhibit corrosion
- Wide wire range-taking capability minimizes inventory requirements
- UL Listed and CSA Certified for use up to 600 V and UL temperature rated 90°C

B3. Stainless Steel Ties

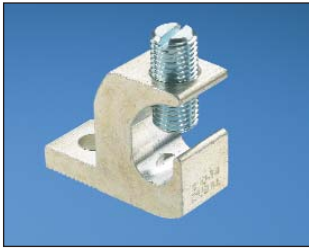

C1. Wiring Duct



C2. Surface Raceway

C3. Abrasion Protection

Part Number	Conductor Size Range	Stud Hole Size (In.)	Hex Key Size (In.)	Figure Dimensions In. (mm)			Std. Pkg. Qty.
				L	W	H	
LI-50S-C	#14 – #4 AWG	0.22	**	1.07 (27.2)	0.38 (9.7)	0.78 (19.8)	100
LI-112S-L	#14 – 1/0 AWG	0.27	**	1.50 (38.1)	0.60 (15.2)	1.17 (29.7)	50
LI-252S-Q	#6 AWG – 250 kcmil	0.33	9/16	2.20 (55.9)	0.80 (20.3)	1.79 (45.5)	25

C4. Cable Management

The use of Panduit oxide inhibiting joint compound (CMP) is recommended for pad to pad and conductor connections. See below.  
\*\*Uses slotted head set screw.

D1. Terminals

## Joint Compounds

D2. Power Connectors

### Type CMP

- Oxide inhibitor for compression conductor connections lowers electrical resistance of compression joint while sealing out air and moisture to prevent the formation of surface oxides
- Wide operating temperature range; can be used in a wide range of electrical and environmental conditions
- Packaged in convenient dispenser bottles

D3. Grounding Connectors



E1. Labeling Systems

E2. Labels

E3. Pre-Printed & Write-On Markers

E4. Permanent Identification

E5. Lockout/Tagout & Safety Solutions

F. Index

Part Number	Part Description	Std. Pkg. Qty.
<b>CMP-100-1</b>	Contact aid for pad-to-pad or thread-to-thread aluminum connections, 8 oz. Operating temperature range -60°F (-51°C) to 400°F (204°C).	1
<b>CMP-200-1</b>	Contact aid for cable connections with compression connections made on aluminum conductor, 8 oz. Operating temperature range -40°F (-40°C) to 400°F (204°C). Compatible with all insulating materials.	1
<b>CMP-300-1</b>	Contact aid for copper-to-copper and copper-to-steel connections, 8 oz. Operating temperature range -40°F (-40°C) to 350°F (177°C). Good for all voltages and suitable for grounding. Also used for anti-seizing thread lubricant.	1
<b>CMP-300-4-1</b>	Contact aid for copper-to-copper and copper-to-steel connections, 4 oz. Operating temperature range -40°F (-40°C) to 350°F (177°C). Good for all voltages and suitable for grounding. Also used for anti-seizing thread lubricant.	1

**UL LISTED** **Grounding Clamp, U-Bolt, Bronze**

**Type GPL**

- Used to ground copper conductor parallel or at a right angle to a rod, tube, or pipe
- Made from high strength, electrolytic cast bronze
- High strength silicon bronze hardware provides long term reliable assembly
- Accommodates a wide range of pipe, tube, rod and conductor sizes – minimizes inventory requirements
- UL Listed for grounding and bonding and suitable for direct burial in earth or concrete

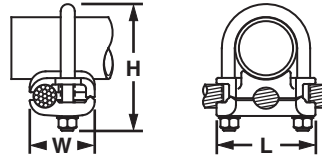

Part Number	Ground Rod Size (In.)	Iron Pipe Size (In.)	Conductor Size Range	Figure Dimensions In. (mm)			Bolt Dia. (In.)	Hex Size (In.)	Std. Pkg. Qty.
				L	W	H			
GPL-4-Q	5/8 or 3/4	3/8	#8 SOL – #4 STR	2.00 (50.8)	1.38 (35.1)	2.75 (69.9)	3/8	9/16	25
GPL-5-Q	5/8 or 3/4	3/8	#4 SOL – 2/0 STR	2.00 (50.8)	1.63 (41.4)	2.75 (69.9)	3/8	9/16	25
GPL-6-Q	5/8 or 3/4	3/8	2/0 SOL – 250 kcmil	2.00 (50.8)	1.88 (47.8)	2.75 (69.9)	3/8	9/16	25
GPL-8-Q	7/8 or 1	1/2 or 3/4	#8 SOL – #4 STR	2.38 (60.5)	1.38 (35.1)	2.63 (66.8)	3/8	9/16	25
GPL-9-Q	7/8 or 1	1/2 or 3/4	#4 SOL – 2/0 STR	2.38 (60.5)	1.63 (41.4)	2.63 (66.8)	3/8	9/16	25
GPL-10-Q	7/8 or 1	1/2 or 3/4	2/0 SOL – 250 kcmil	2.38 (60.5)	1.88 (47.8)	3.00 (76.2)	3/8	9/16	25
GPL-14-X	—	1	#8 SOL – #4 STR	2.63 (66.8)	1.38 (35.1)	2.75 (69.9)	3/8	9/16	10
GPL-15-X	—	1	#4 SOL – 2/0 STR	2.63 (66.8)	1.63 (41.4)	2.75 (69.9)	3/8	9/16	10
GPL-16-X	—	1	2/0 SOL – 250 kcmil	2.63 (66.8)	1.88 (47.8)	3.25 (82)	3/8	9/16	10
GPL-20-X	—	1 1/4	#8 SOL – #4 STR	3.00 (76.2)	1.38 (35.1)	3.50 (88.9)	3/8	9/16	10
GPL-21-X	—	1 1/4	#4 SOL – 2/0 STR	3.00 (76.2)	1.63 (41.4)	3.50 (88.9)	3/8	9/16	10
GPL-22-X	—	1 1/4	2/0 SOL – 250 kcmil	3.00 (76.2)	1.88 (47.8)	3.50 (88.9)	3/8	9/16	10
GPL-26-X	—	1 1/2	#8 SOL – #4 STR	3.25 (82.6)	1.38 (35.1)	4.00 (101.6)	3/8	9/16	10
GPL-27-X	—	1 1/2	#4 SOL – 2/0 STR	3.25 (82.6)	1.63 (41.4)	4.00 (101.6)	3/8	9/16	10
GPL-28-X	—	1 1/2	2/0 SOL – 250 kcmil	3.25 (82.6)	1.88 (47.8)	4.00 (101.6)	3/8	9/16	10
GPL-32-3	—	2	#8 SOL – #4 STR	3.75 (95.3)	1.38 (35.1)	4.25 (107.9)	3/8	9/16	3
GPL-33-3	—	2	#4 SOL – 2/0 STR	3.75 (95.3)	1.63 (41.4)	4.25 (107.9)	3/8	9/16	3
GPL-34-3	—	2	2/0 SOL – 250 kcmil	3.75 (95.3)	1.88 (47.8)	4.25 (107.9)	3/8	9/16	3
GPL-39-3	—	2 1/2	#4 SOL – 2/0 STR	4.25 (107.9)	1.63 (41.4)	5.00 (127)	3/8	9/16	3
GPL-40-3	—	2 1/2	2/0 SOL – 250 kcmil	4.25 (107.9)	1.88 (47.8)	5.00 (127)	3/8	9/16	3
GPL-44-1	—	3	#8 SOL – #4 STR	4.75 (120.6)	1.38 (35.1)	5.50 (140)	3/8	9/16	1
GPL-45-1	—	3	#4 SOL – 2/0 STR	4.75 (120.6)	1.63 (41.4)	5.50 (139.7)	3/8	9/16	1
GPL-46-1	—	3	2/0 SOL – 250 kcmil	4.75 (120.6)	1.88 (47.8)	5.50 (139.7)	3/8	9/16	1
GPL-51-1	—	3 1/2	#4 SOL – 2/0 STR	5.25 (133.4)	1.63 (41.4)	6.25 (158.8)	3/8	9/16	1
GPL-52-1	—	3 1/2	2/0 SOL – 250 kcmil	5.25 (133.4)	1.88 (47.8)	6.25 (158)	3/8	9/16	1
GPL-57-1	—	4	#4 SOL – 2/0 STR	5.75 (146.0)	1.63 (41.4)	6.38 (162.1)	3/8	9/16	1
GPL-58-1	—	4	2/0 SOL – 250 kcmil	5.75 (146.0)	1.88 (47.8)	6.38 (162.1)	3/8	9/16	1
GPL-75-X	—	6	#4 SOL – 2/0 STR	7.88 (200.2)	1.58 (40.1)	7.85 (199.4)	3/8	1 1/4	10

A. System Overview

B1. Cable Ties

B2. Cable Accessories

B3. Stainless Steel Ties

C1. Wiring Duct

C2. Surface Raceway

C3. Abrasion Protection

C4. Cable Management

D1. Terminals

D2. Power Connectors

D3. Grounding Connectors

E1. Labeling Systems

E2. Labels

E3. Pre-Printed & Write-On Markers

E4. Permanent Identification

E5. Lockout/Tagout & Safety Solutions

F. Index

**UL LISTED** Grounding Clamp, U-Bolt, for Two Cables, Bronze

**Type GU**

- Used to ground two copper code conductors parallel to a rod, tube, or pipe
- Made from high strength, electrolytic cast bronze
- High strength silicon bronze hardware provides long term reliable assembly
- Accommodates a wide range of pipe, tube, rod and conductor sizes – minimizes inventory requirements
- UL Listed for grounding and bonding and suitable for direct burial in earth or concrete

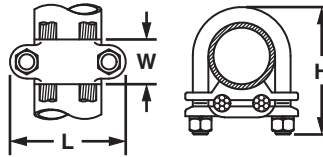

Part Number	Iron Pipe Size (In.)	Conductor Size Range	Figure Dimensions In. (mm)			Bolt Dia. (In.)	Hex Size (In.)	Std. Pkg. Qty.
			L	W	H			
<b>GU-2-X</b>	1	#4 SOL – 2/0 STR	2.75 (70.0)	1.13 (28.6)	3.25 (82.6)	3/8	9/16	10
<b>GU-4-X</b>	1 1/4	#8 SOL – #4 STR	3.00 (76.2)	1.13 (28.6)	3.25 (82.6)	3/8	9/16	10
<b>GU-13-3</b>	2	300 kcmil – 500 kcmil	4.00 (102.0)	1.50 (38.1)	4.63 (118.0)	1/2	3/4	3

**UL LISTED** Grounding Clamp for Water Pipes, Bronze

**Type KP**

- Used to ground copper code conductor to water pipe or copper tube
- Cast from high strength, electrolytic bronze to provide reliable grounding connections
- Plated steel screws provide high strength and inhibit corrosion
- Accommodates a wide range of pipe, tube, rod and conductor sizes – minimizes inventory requirements
- UL Listed for grounding and bonding and suitable for direct burial in earth or concrete



Part Number	Water Pipe Range (In.)	Conductor Size Range	Figure Dimensions In. (mm)		Std. Pkg. Qty.
			L	W	
<b>KP1-C</b>	1/2 – 1	#10 SOL – #2 STR	2.28 (57.9)	0.66 (16.8)	100
<b>KP2-L</b>	1 1/4 – 2	#10 SOL – #2 STR	3.58 (90.9)	0.73 (18.5)	50



## Grounding Clamp for Water Pipe with Copper Strap, Bronze

### Type KLS

- Used to ground copper code conductor to rigid conduit systems
- Cast from high strength, electrolytic bronze to provide reliable grounding connections
- Plated steel screws provide high strength and inhibit corrosion
- Pure copper contact strip included to isolate conduit system from water pipe vibrations

- High strength bronze conduit hub also included to provide durable connection of conduit to copper strap
- Accommodates a wide range of pipe, tube, and conductor sizes – minimizes inventory requirements
- UL Listed for grounding and bonding and suitable for direct burial in earth or concrete

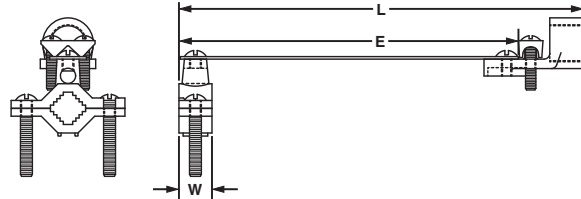

Part Number	Conduit Hub Size	Water Pipe Range (In.)	Conductor Size Range	Figure Dimensions In. (mm)			Std. Pkg. Qty.
				L	W	E	
KLS-0-Q	1/2	1/2 – 1	#8 SOL – #4 STR	8.22 (58.7)	0.66 (16.8)	6.88 (174.8)	25
KLS-1-Q	3/4	1/2 – 1	#8 SOL – #4 STR	8.22 (58.7)	0.66 (16.8)	6.88 (174.8)	25
KLS-1A-X	1	1/2 – 1	#8 SOL – #4 STR	8.38 (58.7)	0.66 (16.8)	6.88 (174.8)	10



## Grounding Clamp for Conduit, Bronze

### Type KH

- Used to ground copper code conductor to rigid conduit systems
- Cast from high strength, electrolytic bronze to provide reliable grounding connections
- Plated steel screws provide high strength and inhibit corrosion
- Includes high strength bronze conduit hub to ensure a durable connection of conduit to copper strap

- Accommodates a wide range of pipe, tube, and conductor sizes – minimizes inventory requirements
- UL Listed for grounding and bonding and suitable for direct burial in earth or concrete



Part Number	Conduit Hub Size	Water Pipe Range (In.)	Conductor Size Range	Figure Dimensions In. (mm)				Std. Pkg. Qty.
				L	W	E	D	
KH-1-L	1/2	1/2 – 1	#10 SOL – #4 STR	2.31 (58.7)	0.66 (16.8)	2.54 (64.5)	1.85 (47)	50
KH-2-L	1/2	1 1/4 – 2	#10 SOL – #4 STR	3.60 (91.4)	0.79 (20.1)	3.02 (76.7)	1.85 (47)	50

A. System Overview

B1. Cable Ties

B2. Cable Accessories

B3. Stainless Steel Ties

C1. Wiring Duct

C2. Surface Raceway

C3. Abrasion Protection

C4. Cable Management

D1. Terminals

D2. Power Connectors

D3. Grounding Connectors

E1. Labeling Systems

E2. Labels

E3. Pre-Printed & Write-On Markers

E4. Permanent Identification

E5. Lockout/Tagout & Safety Solutions

F. Index

A. System Overview

B1. Cable Ties

B2. Cable Accessories

B3. Stainless Steel Ties

C1. Wiring Duct

C2. Surface Raceway

C3. Abrasion Protection

C4. Cable Management

D1. Terminals

D2. Power Connectors

D3. Grounding Connectors

E1. Labeling Systems

E2. Labels

E3. Pre-Printed & Write-On Markers

E4. Permanent Identification

E5. Lockout/Tagout & Safety Solutions

F. Index

## UL LISTED Grounding Clamp for Water Pipes, Aluminum

### Type GC

- Dual-rated for grounding aluminum or copper code conductors to copper water pipe, galvanized pipe, or steel conduit
- Made from high strength, extruded aluminum alloy to provide long term durability
- Tin-plated to inhibit corrosion and oxidation and for low contact resistance
- Plated steel screws provide high strength and inhibit corrosion
- Accommodates a wide range of pipe, tube, and conductor sizes – minimizes inventory requirements
- UL Listed for grounding and bonding

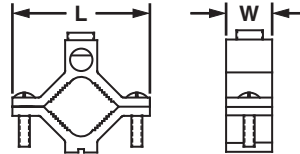

Part Number	Conduit Pipe or Water Tube Size	Conductor Size Range	Figure Dimensions In. (mm)		Std. Pkg. Qty.
			L	W	
<b>GC-15A-Q</b>	1/2 – 3/4 – 1	#14 AWG – 1/0 AWG	2.25 (57.2)	0.69 (17.5)	25
<b>GC-18A-X</b>	1 1/4 – 1, 1/2 – 2	#6 AWG – 250 kcmil	3.75 (95.3)	0.81 (20.6)	10
<b>GC-22A-4</b>	2 1/2 – 3 – 3 1/2 – 4	#6 AWG – 250 kcmil	6.31 (95.3)	1.00 (25.4)	4

## UL LISTED CSA CERTIFIED Grounding Rod Clamp, Bronze

### Type WB

- Used for grounding copper conductor parallel to ground rods
- Made from high strength, seamless electrolytic bronze to provide long term durability
- High strength silicon bronze hardware provides long term reliable assembly
- Accommodates a wide range of rod and conductor sizes – minimizes inventory requirements
- UL Listed and CSA Certified for grounding and bonding and suitable for direct burial in earth and concrete

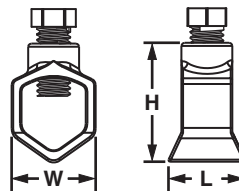

Part Number	Ground Rod Size	Conductor Size Range	Figure Dimensions In. (mm)			Hex Size In.	Std. Pkg. Qty.
			L	W	H		
<b>WB12-L</b>	1/2	#2 – #10 STR, #10 SOL	0.88 (22.4)	0.84 (21.3)	1.28 (32.5)	1/2	50
<b>WB34-X</b>	5/8 3/4	1/0 – #8 STR, #2 – #8 STR	1.03 (26.2)	1.06 (26.9)	1.54 (39.1)	1/2	10
<b>WB58-Q</b>	5/8	1/0 – #8 STR	1.04 (26.4)	0.92 (23.4)	1.40 (35.6)	1/2	25



## Grounding Clamp with Spacer for Flat Surfaces, Bronze

### Type GM

- Used to ground copper code conductor to flat surfaces
- Cast from high strength, electrolytic bronze to provide reliable grounding connections
- High strength silicon bronze hardware for long term reliable assembly
- Accommodates a wide range of conductor sizes – minimizes inventory requirements
- Incorporates spacer plate to separate conductor from mounting surface
- UL Listed for grounding and bonding and suitable for direct burial in earth or concrete

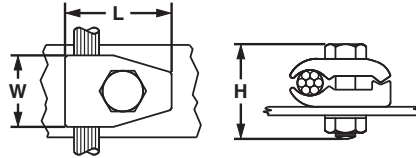

Part Number	Conductor Size Range	Figure Dimensions In. (mm)			Hex Size (In.)		Std. Pkg. Qty.
		L	W	H	Bolt	Nut	
GM-2-Q	#4 SOL – 2/0 STR	1.63 (41.4)	1.13 (28.7)	1.75 (44.5)	9/16	9/16	25
GM-3-Q	2/0 SOL – 250 kcmil	2.13 (54.1)	1.50 (38.1)	2.00 (50.8)	3/4	3/4	25



## Grounding Clamp for Flat Surfaces, Bronze

### Type GMS

- Used to ground copper code conductor to flat surfaces
- Cast from high strength, electrolytic bronze to provide reliable grounding connections
- High strength silicon bronze hardware for long term reliable assembly
- Accommodates a wide range of conductor sizes – minimizes inventory requirements
- UL Listed for grounding and bonding and suitable for direct burial in earth or concrete

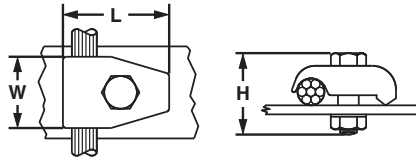

Part Number	Conductor Size Range	Figure Dimensions In. (mm)			Hex Size (In.)		Std. Pkg. Qty.
		L	W	H	Bolt	Nut	
GMS-1-X	#8 SOL – #4 STR	1.25 (31.8)	1.00 (25.4)	1.63 (41.4)	9/16	9/16	10
GMS-2-Q	#4 SOL – 2/0 STR	1.63 (41.4)	1.13 (28.7)	1.75 (44.5)	9/16	9/16	25
GMS-3-Q	2/0 SOL – 250 kcmil	2.13 (54.1)	1.50 (38.1)	2.00 (50.8)	3/4	3/4	25

A. System Overview

B1. Cable Ties

B2. Cable Accessories

B3. Stainless Steel Ties

C1. Wiring Duct

C2. Surface Raceway

C3. Abrasion Protection

C4. Cable Management

D1. Terminals

D2. Power Connectors

D3. Grounding Connectors

E1. Labeling Systems

E2. Labels

E3. Pre-Printed & Write-On Markers

E4. Permanent Identification

E5. Lockout/Tagout & Safety Solutions

F. Index

A.  
System  
Overview



## Flat Braided Bonding Straps

B1.  
Cable Ties

### Type BS

B2.  
Cable  
Accessories

- Used to electrically bond enclosure doors, motors, and machine frames in the construction of control panels or machine structures
- Flat ferrule end design helps to reduce the effects of EMI (Electromagnetic Interference)
- Available with internationally recognized green and yellow insulation for grounding application
- Made of high conductivity copper and tin-plated to inhibit corrosion
- Seamless ferrule ends provide mechanical strength for improved reliability
- UL 467 Listed and CSA Certified

B3.  
Stainless  
Steel Ties

C1.  
Wiring  
Duct

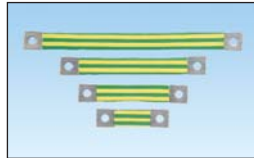

One Hole, Insulated



One-Hole, Non-Insulated



Two-Hole, Non-Insulated

C2.  
Surface  
Raceway

C3.  
Abrasion  
Protection

C4.  
Cable  
Management

D1.  
Terminals

D2.  
Power  
Connectors

D3.  
Grounding  
Connectors

E1.  
Labeling  
Systems

E2.  
Labels

E3.  
Pre-Printed  
& Write-On  
Markers

E4.  
Permanent  
Identification

E5.  
Lockout/  
Tagout  
& Safety  
Solutions

F.  
Index

Part Number	Conductor Size	Length In. (mm)	Width In. (mm)	Thickness In. (mm)	Ferrule Length In. (mm)	Stud Hole Size In. (mm)	Stud Hole Spacing In. (mm)	Std. Pkg. Qty.
<b>One-Hole, Insulated</b>								
BS100445	#4 AWG	4.00 (101.6)	1.06 (27.0)	0.13 (3.3)	1.00 (25.4)	3/8 (M10)	—	1
BS100645	#4 AWG	6.00 (152.4)	1.06 (27.0)	0.13 (3.3)	1.00 (25.4)	3/8 (M10)	—	1
BS100845	#4 AWG	8.00 (203.2)	1.06 (27.0)	0.13 (3.3)	1.00 (25.4)	3/8 (M10)	—	1
BS101245	#4 AWG	12.00 (304.8)	1.06 (27.0)	0.13 (3.3)	1.00 (25.4)	3/8 (M10)	—	1
<b>One-Hole, Non-Insulated</b>								
BS100445U	#4 AWG	4.00 (101.6)	1.06 (27.0)	0.13 (3.3)	1.00 (25.4)	3/8 (M10)	—	1
BS100645U	#4 AWG	6.00 (152.4)	1.06 (27.0)	0.13 (3.3)	1.00 (25.4)	3/8 (M10)	—	1
BS100845U	#4 AWG	8.00 (203.2)	1.06 (27.0)	0.13 (3.3)	1.00 (25.4)	3/8 (M10)	—	1
BS101245U	#4 AWG	12.00 (304.8)	1.06 (27.0)	0.13 (3.3)	1.00 (25.4)	3/8 (M10)	—	1
<b>Two-Hole, Non-Insulated</b>								
BS201246EU	#4 AWG	12.00 (304.8)	1.06 (27.0)	0.13 (3.3)	2.50 (36.5)	3/8 (M10)	1.25 (31.8)	1
BS201846EU	#4 AWG	18.00 (457.2)	1.06 (27.0)	0.13 (3.3)	2.50 (36.5)	3/8 (M10)	1.25 (31.8)	1
BS202446EU	#4 AWG	24.00 (609.6)	1.06 (27.0)	0.13 (3.3)	2.50 (36.5)	3/8 (M10)	1.25 (31.8)	1



## COMPRESSION CONNECTOR CRIMPING TOOLS

Panduit offers a wide range of tools to provide solutions for installing compression lugs and splices. Panduit installation tools provide quality performance, ease of installation, and lowest installed cost. The long-term reliability of Panduit installation tools provides the highest level of service to meet and surpass customer requirements.



- Ergonomic design to minimize operator effort
- Controlled cycle mechanisms ensuring reliability and repeatability in every crimp made
- Crimping dies are color coded to easily match the compression connector to the proper die
- UL Listed and CSA Certified terminations with Panduit compression connectors, as noted

Panduit compression connector crimping tools are available in an assortment of styles including manually operated mechanical and hydraulic, battery operated hydraulic, and AC powered hydraulic to meet a variety of installation needs. Uni-Die™ Dieless Crimping Tools crimp a variety of sizes and eliminate the need to purchase crimping dies. Fully self-contained, lithium-ion battery powered crimping tools provide the ease of push button crimping with up to 35% more crimps per battery charge and up to a 30% faster crimp cycle time than comparable tools with NiCd or NiMH batteries.

A.  
System  
Overview

B1.  
Cable Ties

B2.  
Cable  
Accessories

B3.  
Stainless  
Steel Ties

C1.  
Wiring  
Duct

C2.  
Surface  
Raceway

C3.  
Abrasion  
Protection

C4.  
Cable  
Management

D1.  
Terminals

D2.  
Power  
Connectors

D3.  
Grounding  
Connectors

E1.  
Labeling  
Systems

E2.  
Labels

E3.  
Pre-Printed  
& Write-On  
Markers

E4.  
Permanent  
Identification

E5.  
Lockout/  
Tagout  
& Safety  
Solutions

F.  
Index

A. System Overview

B1. Cable Ties

B2. Cable Accessories

B3. Stainless Steel Ties

C1. Wiring Duct

C2. Surface Raceway

C3. Abrasion Protection

C4. Cable Management

D1. Terminals

D2. Power Connectors

D3. Grounding Connectors

E1. Labeling Systems

E2. Labels

E3. Pre-Printed & Write-On Markers

E4. Permanent Identification

E5. Lockout/Tagout & Safety Solutions

F. Index

## Crimping Guidelines for Panduit® Pan-Lug™ Compression Lugs and Splices

### 1. Select the proper Panduit compression connector for the conductor type and size being used.



- Panduit compression connectors are identified with the proper conductor size and conductor type marked on the tongue or barrel of the connector

- The proper conductor size and type to be used with each connector can also be found in the installation instructions included with Panduit product packaging and in the tool charts\* in this catalog

PANDUIT PART NUMBER	STUD WIRE SIZE	WIRE RANGE-TANGING WITH OUR DYE TOOLS (SEE NOTE)	WIRE STRIP LENGTH (IN.)	CRIMPING TOOL
LOG SPALICE	6 AWG	---	3/4	RED P24 (3)
LCB, LCC, SCL	6 AWG	---	1-1/16	---
LCB, LCC, SCL	6 AWG	---	1-1/4	BLUE P24 (3)
LCB4, LCC4, LCC4-12** SCL4	2 AWG SCL	4 AWG	1-1/8	GRAY P29 (3)
LCB2, LCC2 SCL2	2 AWG	6-2 AWG	1-1/4	BROWN P33 (3)
LCB1, LCC1 SCL1	1 AWG	6-1 AWG	1-3/8	GREEN P37 (3)
LCB1B, LCC1B SCL1B	1/0 AWG	6-1/0 AWG	1-1/2	---
LCB2B, LCC2B SCL2B	2/0 AWG	4-2/0 AWG	1-5/8	---
LCB3B, LCC3B SCL3B	3/0 AWG	2-3/0 AWG	1-8/10	---

### 2. Strip the conductor to the proper strip length. As specified:

- On the Panduit product packaging label or
- On the installation instructions included with Panduit product packaging or
- In the tool charts\* in this catalog

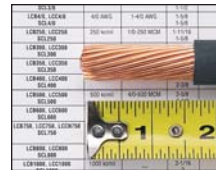

Make sure the conductor is not stripped too long, which would result in exposed wire between the barrel of the connector and the cable insulation.

Make sure the conductor is not stripped too short, which would result in a less than complete contact area with the connector when the conductor is inserted in the barrel.

Do not nick or cut strands of conductor during crimping, which would result in a less than premium conductor termination.



Make sure conductor strands are free from corrosion.

### 3. Select the proper crimping die and crimping tool to be used with the connector.

Use crimping tools and dies that provide a UL Listed and/or CSA Certified electrical termination, to assure a safe and reliable connection.

Many Panduit compression connectors are UL Listed and CSA Certified when crimped with Panduit and specified competitor crimping tools and dies. These tools and dies are listed in the tool charts\* in this catalog. Panduit crimping tools and dies to be used with each connector are also listed on the installation instructions included with Panduit product packaging.



Panduit compression connectors are color-coded and marked with Panduit and specified competitor die index numbers. Select the proper crimping die to be used by matching the color code and die index number marked on the connector to the same markings on the crimping die.

### 4. Crimp the connector.

Insert the conductor into the barrel of the connector. The conductor should stop against the end of the barrel of the lug, or wire stop in the butt splice, upon complete insertion of the conductor in the barrel. Some lugs are offered with inspection windows that provide visual inspection of the complete conductor insertion.



Review the installation instructions included with the Panduit product packaging or the tool charts\* for the proper number of crimps to be placed in the connector. Make the first crimp in the barrel nearest the tongue of the lug, or wire stop in a butt splice, and make successive crimps in the barrel working towards the conductor entry at the end of

MIN. CRIMP (3)	LC	FIN. CRIMP (3)
CD-200-2/0	STD	CD-2001-2/0
ACK P45 (3)	(2)	BLACK P45 (3)
CD-200-3/0	STD	CD-2001-3/0
ANGE P50 (3)	(2)	ORANGE P50 (3)
CD-200-4/0	STD	CD-2001-4/0
RPLE P54 (3)	(2)	PURPLE P54 (3)
CD-200-250	STD	CD-2001-250
LOW P62 (3)	(3)	YELLOW P62 (3)
CD-200-300	STD	CD-2001-300
HTE P66 (3)	(3)	WHITE P66 (3)
CD-200-350	STD	CD-2001-350
RED P71 (3)	(3)	RED P71 (3)
CD-200-400	STD	CD-2001-400



#### Identify

the barrel. Use the color-coded or knurled band markings on the barrel of the connector to evenly space the placement of the crimps in the barrel.

When properly crimped, the die index number engraved in the crimping die will be embossed into the barrel of the connector. The crimp should be placed in the connector so the die index number can be easily read when the connector is installed.



\* See tool charts on pages D3.56 – D3.94.

## Crimping Guidelines for Panduit® StructuredGround™ Compression Connectors

### TAP Installation

1. Locate desired position of TAP along main wire run. Allow clearance for tap wires (and cover installation if applicable). See clear cover table on page D3.13.
2. Strip insulation from wires to the length shown in the TAP table on page D3.14. Use care to avoid damaging the conductors.
3. Position wires in the appropriate tap grooves.
4. For easier installation, apply one of the flame retardant cable ties (provided) around the wires and through the slots in the TAP. **The head of the cable tie must be positioned along the side of the TAP as shown in Figure A.** Tension and cut off excess length of tie. Additional cable ties may be used adjacent to the TAP to secure the wires.
5. Install the correct dies (see page D3.94) into the crimping tool. Position the locator die into the stationary die holder. **Note: The color code and die index number shown on the HTAP and crimping dies must match.**
6. Position the TAP against the locator in the stationary die holder of the crimping tool.
7. After crimping, if desired, cut off the cable tie head or remove the entire cable tie. **Note: In some cases, the cable tie head must be cut off in order for the crimped connector to fit inside the insulating cover.**

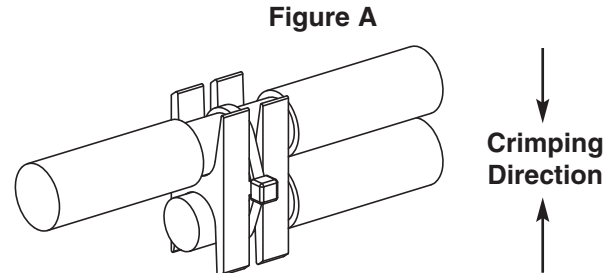

### HTAP Cover Installation

1. If labels are being utilized, cut labels to the dimensions shown below. **Note: When using a Panduit® Pan-Ther™ LS8E printer, the length dimensions can be easily programmed to provide cut-off marks.**
2. Position the label(s) in the pockets inside the cover and snap in the label retainer(s) as shown in Figure B. Information can be marked on the matte finish label retainers in lieu of using a separate label.
3. Position one cover half around the crimped connector assembly. Align the second cover half with the first and snap together.
4. Install the two flame retardant cable ties (provided) in the grooved areas on the cover. Tension and cut off excess lengths of ties.

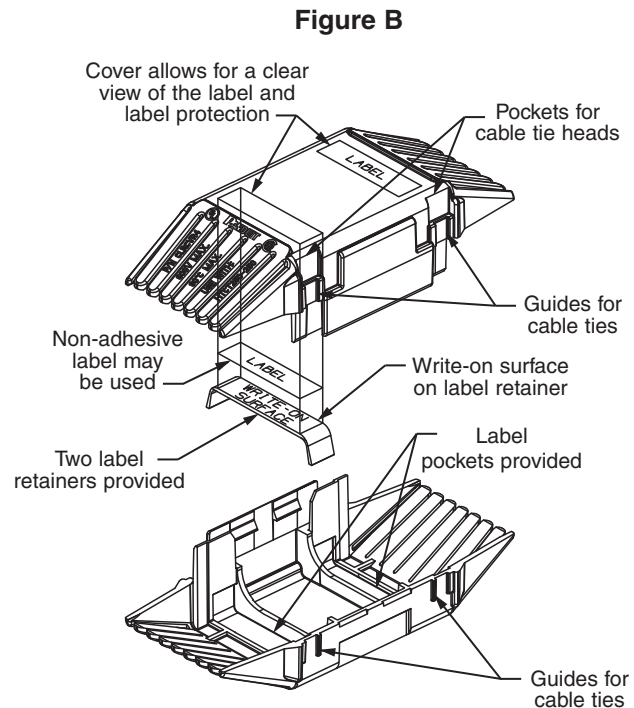

**Note: Configuration of cover may differ slightly from illustration.**

**Label Size Information**

Clear Cover Part Number	Label Height (Max.)	Label Length (Wrap-Around Style)	Label Length (Flat Style)
CLRCVR1-1	.38	1.56	1.00
CLRCVR2-1	.38	1.87	1.25
CLRCVR3-1	.38	2.37	1.75

A. System Overview

B1. Cable Ties

B2. Cable Accessories

B3. Stainless Steel Ties

C1. Wiring Duct

C2. Surface Raceway

C3. Abrasion Protection

C4. Cable Management

D1. Terminals

D2. Power Connectors

D3. Grounding Connectors

E1. Labeling Systems

E2. Labels

E3. Pre-Printed & Write-On Markers

E4. Permanent Identification

E5. Lockout/Tagout & Safety Solutions

F. Index

A. System Overview

B1. Cable Ties

B2. Cable Accessories

B3. Stainless Steel Ties

C1. Wiring Duct

C2. Surface Raceway

C3. Abrasion Protection

C4. Cable Management

D1. Terminals

D2. Power Connectors

D3. Grounding Connectors

E1. Labeling Systems

E2. Labels

E3. Pre-Printed & Write-On Markers

E4. Permanent Identification

E5. Lockout/Tagout & Safety Solutions

F. Index

## Selection Guide – Compression Connector Tools

Tool Selection Guide for Crimping Panduit Copper Compression Lugs and Splices for use with Copper Code Conductors																					
Conductor Type	Connector Type	Tool Type	Copper Conductor Range																		
			#14 AWG	#12 AWG	#10 AWG	#8 AWG	#6 AWG	#4 AWG	#3 AWG	#2 AWG	#1 AWG	1/0 AWG	2/0 AWG	3/0 AWG	4/0 AWG	250 kcmil	300 kcmil	350 kcmil	400 kcmil	500 kcmil	600 kcmil
Copper Code Conductor	LCAS LCA LCAN LCB LCB-W LCBH LCD LCDN LCC LCC-W LCCN LCCH SCSS SCS SCL SCH SCT PS RSC	Manual Crimping Tools	CT-100A – Plier Type (pg. D1.83)																		
			CT-200 – Plier Type (pg. D1.83)																		
			CT-1570 – Controlled Cycle (pg. D1.84)																		
			CT-1701 – Controlled Cycle (pg. D1.84)																		
			CT-1700* – Controlled Cycle (pg. D1.84)																		
		Manual Hydraulic Crimping Tools	CT-720 – Die Type (pg. D3.37)																		
			CT-930 – 14 ton (pg. D3.39)																		
			CT-980 Uni-Die™ Dieless – 6.2 ton (pg. D3.52)																		
			CT-3001 – In-Line – 6 ton (pg. D3.40)																		
			CT-2002/L – Open "C-head" – 6 ton (pg. D3.41)																		
			CT-2930/L – 14 ton (pg. D3.43)																		
			CT-2940/L – 15 ton (pg. D3.44)																		
			CT-2980/L Uni-Die™ Dieless – 6.2 ton (pg. D3.53)																		
			CT-930CH – 14 ton (pg. D3.45)																		
			CT-930LPCH – 10.5 ton (pg. D3.48)																		
		Remote Crimp Heads	CT-940CH – 15 ton (pg. D3.46)																		
			CT-980CH Uni-Die™ Dieless – 6.2 ton (pg. D3.54)																		
			CT-980LPCH Uni-Die™ Dieless – 4.7 ton (pg. D3.54)																		

See tool charts on pages D3.56 – D3.94 for selection of crimping dies and number of crimps used with specific tool and connector combinations.

\*CT-1700 is not used for PSC splices.

## Selection Guide – Compression Connector Tools (continued)

Tool Selection Guide for Crimping Panduit Copper Compression Lugs and Splices for use with Copper Flex Conductor																												
Conductor Type	Connector Type	Tool Type	Copper Conductor Range																									
			#8 AWG	#6 AWG	#4 AWG	#3 AWG	#2 AWG	#1 AWG	1/0 AWG	2/0 AWG	3/0 AWG	4/0 AWG	250 kcmil	262 kcmil	300 kcmil	313 kcmil	350 kcmil	373 kcmil	400 kcmil	450 kcmil	500 kcmil	535 kcmil	600 kcmil	646 kcmil	750 kcmil	777 kcmil		
Copper Code and Flex Conductor	LCAX LCAXN LCBX LCDXN LCCX LCCXN Maximum Code Conductor Size 4/0 AWG	Manual Crimping Tool	CT-1700 – Controlled Cycle (pg. D1.84)																									
		Manual Hydraulic Crimping Tool	CT-930 – 14 ton (pg. D3.39)																									
		Lithium-Ion Battery Powered Hydraulic Crimping Tools	CT-3001 – In-Line – 6 ton (pg. D3.40)																									
			CT-2002/L – Open “C-head” – 6 ton (pg. D3.41)																									
			CT-2930/L – 14 ton (pg. D3.43)																									
			CT-2940/L – 15 ton (pg. D3.44)																									
		Remote Crimp Heads	CT-930CH – 14 ton (pg. D3.45)																									
			CT-940CH – 15 ton (pg. D3.46)																									
Copper Flex Conductor	LCAF LCCF SCSF RSC	Manual Hydraulic Crimping Tool	CT-930 – 14 ton (pg. D3.39)																									
		Lithium-Ion Battery Powered Hydraulic Crimping Tools	CT-2930/L – 14 ton (pg. D3.43)																									
			CT-2940/L – 15 ton (pg. D3.44)																									
		Remote Crimp Heads	CT-930CH – 14 ton (pg. D3.45)																									
			CT-940CH – 15 ton (pg. D3.46)																									

See tool charts on pages D3.56 – D3.94 for selection of crimping dies and number of crimps used with specific tool and connector combinations.

Selection guide continues on page D3.36

A. System Overview

B1. Cable Ties

B2. Cable Accessories

B3. Stainless Steel Ties

C1. Wiring Duct

C2. Surface Raceway

C3. Abrasion Protection

C4. Cable Management

D1. Terminals

D2. Power Connectors

D3. Grounding Connectors

E1. Labeling Systems

E2. Labels

E3. Pre-Printed & Write-On Markers

E4. Permanent Identification

E5. Lockout/Tagout & Safety Solutions

F. Index

A. System Overview

B1. Cable Ties

B2. Cable Accessories

B3. Stainless Steel Ties

C1. Wiring Duct

C2. Surface Raceway

C3. Abrasion Protection

C4. Cable Management

D1. Terminals

D2. Power Connectors

D3. Grounding Connectors

E1. Labeling Systems

E2. Labels

E3. Pre-Printed & Write-On Markers

E4. Permanent Identification

E5. Lockout/Tagout & Safety Solutions

F. Index

## Selection Guide – Compression Connector Tools (continued)

Tool Selection Guide for Crimping Panduit Aluminum Compression Lugs and Splices for use with Copper or Aluminum Code Conductor																			
Conductor Type	Connector Type	Tool Type	Copper or Aluminum Conductor Range																
			#6 AWG	#4 AWG	#3 AWG	#2 AWG	#1 AWG	1/0 AWG	2/0 AWG	3/0 AWG	4/0 AWG	250 kcmil	300 kcmil	350 kcmil	400 kcmil	500 kcmil	600 kcmil	750 kcmil	800 kcmil
Copper or Aluminum Code Conductor	LAA LAB SA	Manual Crimping Tools	CT-1700 – Controlled Cycle (pg. D1.84)																
			CT-720 – Die Type (pg. D3.37)																
		Manual Hydraulic Crimping Tool	CT-930 – 14 ton (pg. D3.39)																
			Lithium-Ion Battery Powered Hydraulic Crimping Tools	CT-2930/L – 14 ton (pg. D3.43)															
		Remote Crimp Heads		CT-2940/L – 15 ton (pg. D3.44)															
			Remote Crimp Heads	CT-930CH – 14 ton (pg. D3.45)															
		Remote Crimp Heads		CT-940CH – 15 ton (pg. D3.46)															

See tool charts on pages D3.56 – D3.94 for selection of crimping dies and number of crimps used with specific tool and connector combinations.

## Die Type, Manual, Crimping Tool

- High quality, durable tool construction provides long term dependability



- Develops 6 tons of crimping force, crimps copper compression lugs and splices up to 500 kcmil
- Provides UL Listed and CSA Certified connections on Panduit copper and aluminum lugs, splices, and insulated terminals

Part Number	Part Description	Std. Pkg. Qty.
CT-720	Manual crimping tool for UL Listed or Recognized and CSA Certified terminations of Panduit® Pan-Lug™ copper compression lugs and splices for #8 AWG – 500 kcmil copper code conductor and aluminum compression lugs and splices for #6 AWG – 350 kcmil copper and aluminum code conductors. Provides UL Listed terminations of Panduit® Pan-Term® #8 – #2 AWG vinyl insulated terminals.  Color-coded CD-720 crimping dies, carrying/storage case and controlled cycle mechanism must be purchased separately.  Specifications: Output: 6 tons Weight: 7.7 lbs. Length: 26" Handle span: 58" (open), 2.5" (closed) Warranty: 90 days	1
CC-720	Optional controlled cycle mechanism only. Total weight of tool with CC-720 is 8.25 lbs.	1
C-720	Black steel carrying case for CT-720 crimping tool.	1

For battery powered crimping tools, see compression connector tools selection guide on pages D3.34 – D3.36.

## CD-720 Crimping Dies

- Color-coded for easy matching to color-coding marked on connectors
- Embosses die index number on connector barrels to provide post crimp inspection except CD-720PV8-2



- Part number permanently marked on crimping die for easy identification
- Provides 5-sided crimp results in terminations with premium electrical and mechanical performance

Part Number	Used to Install Panduit Compression Lug and Splice Sizes				Std. Pkg. Qty.
	Copper Conductor Size	Copper Die Color and Die No.	Aluminum Conductor Size	Aluminum Die Color and Die No.	
CD-720-1	#8 – #2 AWG	Red P21, Blue P24, Gray P29, Brown P33	#6 AWG	Gray P29	1
CD-720-2	#1 – 3/0 AWG	Green P37, Pink P42, Black P45, Orange P50	#4 – 1/0 AWG	Green P37, Pink P42, Gold P45, Tan P50	1
CD-720-3	4/0 AWG – 250 kcmil	Purple P54, Yellow P62	2/0 – 3/0 AWG	Olive P54, Ruby P62	1
CD-720-4	300 kcmil	White P66	4/0 AWG	White P66	1
CD-720-5	350 kcmil	Red P71	250 kcmil	Red P71	1
CD-720-6	400 kcmil	Blue P76	300 kcmil	Blue P76	1
CD-720-7	500 kcmil	Brown P87	350 kcmil	Brown P87	1
CD-720PV8-2	#8 – #2 AWG, vinyl insulated Pan-Term® Terminals	Red, Blue, Yellow	—	—	1

See pages D3.34 – D3.36 for connector and tool selection information.

A.  
System  
Overview

B1.  
Cable Ties

B2.  
Cable  
Accessories

B3.  
Stainless  
Steel Ties

C1.  
Wiring  
Duct

C2.  
Surface  
Raceway

C3.  
Abrasion  
Protection

C4.  
Cable  
Management

D1.  
Terminals

D2.  
Power  
Connectors

D3.  
Grounding  
Connectors

E1.  
Labeling  
Systems

E2.  
Labels

E3.  
Pre-Printed  
& Write-On  
Markers

E4.  
Permanent  
Identification

E5.  
Lockout/  
Tagout  
& Safety  
Solutions

F.  
Index

A. System Overview

## Die Type, Manual, Crimping Tool and Die Kits

B1. Cable Ties

- Available with or without controlled cycle feature to meet specific applications

- Kits available with three or full set of seven dies for crimping partial or full range of connector sizes

B2. Cable Accessories



B3. Stainless Steel Ties

C1. Wiring Duct

C2. Surface Raceway

C3. Abrasion Protection

C4. Cable Management

Part Number	Part Description	Std. Pkg. Qty.
<b>CT-720-7</b>	Basic tool kit with seven dies. Includes: <ul style="list-style-type: none"> <li>• Seven dies (CD-720-1 through CD-720-7) for installing #8 AWG – 500 kcmil copper compression connectors</li> <li>• Carrying/storage case (C-720)</li> </ul>	1
<b>CT-720-7CC</b>	Controlled cycle tool kit with seven dies. Controlled cycle mechanism factory installed on crimping tool. Includes: <ul style="list-style-type: none"> <li>• Seven dies (CD-720-1 through CD-720-7) for installing #8 AWG – 500 kcmil copper compression connectors</li> <li>• Carrying/storage case (C-720)</li> </ul>	1
<b>CT-720-3</b>	Basic tool kit with three dies. Includes: <ul style="list-style-type: none"> <li>• Three dies (CD-720-1 through CD-720-3) for installing #8 AWG – 250 kcmil copper compression connectors</li> <li>• Carrying/storage case (C-720)</li> </ul>	1
<b>CT-720-3CC</b>	Controlled cycle tool kit with three dies. Controlled cycle mechanism factory installed on crimping tool. Includes: <ul style="list-style-type: none"> <li>• Three dies (CD-720-1 through CD-720-3) for installing #8 AWG – 250 kcmil copper compression connectors</li> <li>• Carrying/storage case (C-720)</li> </ul>	1

D1. Terminals

## Cable Stripping Tool for Large Cable Sizes

D2. Power Connectors

D3. Grounding Connectors

- Provides safe and easy stripping of cable insulation for cables 3/16" to 1 9/16" diameter
- Cutting blade provides circular, spiral, and in-line insulation cutting
- Spiral cut mode, tough/hard insulations peel off easily
- In-line cut mode for use with softer insulation like neoprene
- Unique blade profile for long life, low friction stripping of difficult insulations like rubber and silicon
- Cutting blade easily adjusts to proper height to cut insulation without nicking conductor strands
- Ergonomic shape for safe comfortable use
- Compact design
- Easy-fit replacement blade, one spare blade included with tool



Part Number	Wire Range (O.D.)	Part Description	Std. Pkg. Qty.
<b>CST114-157</b>	0.18" – 1.57"	Cable stripping tool for stripping insulation from cables 3/16" to 1 9/16" diameter. Includes replacement cutting blade. Warranty: 90 days	1
<b>CST114-157B</b>	—	Blade replacement kit for CST114-157 cable stripping tool.	1

E1. Labeling Systems

E2. Labels

## Wire and Cable Stripping Tools

E3. Pre-Printed & Write-On Markers

- Strips and cuts #20 – #10 AWG wire
- Lightweight and durable for comfortable long use
- Rust resistant coating included to improve durability of tool

E4. Permanent Identification



**CST101**

E5. Lockout/Tagout & Safety Solutions



**CST115**

F. Index

Part Number	Wire Range (O.D.)	Part Description	Std. Pkg. Qty.
<b>CST101</b>	#20 – #10 AWG	V notch wire stripper.	1
<b>CST115</b>	#20 – #10 AWG	Plier nose wire stripper.	1





## Cable Cutting Tools

- Designed with optimal force transmission ratio and stepwise cutting to allow for one-hand operation
- Ergonomically formed, soft handle grips provide easy operation without fatigue

- All parts made of high-tempered special steel; blades and stressed parts are specially tempered or hardened for long term durability
- Not for use with steel and ASCR cable



CCT-500



CCT-320

Part Number	Part Description	Std. Pkg. Qty.
CCT-500	Ratchet cable cutting tool cuts both copper and aluminum solid code and stranded flex cables (AL & CU cable to 1000MCM) up to 2 - 1/32" (52mm) diameter. Approximate dimensions 14" (356mm) x 5-1/2" (140mm) x 1" (25.4mm). Tool weight 29.6 oz. (840 g). Warranty: 1 year.	1
CCT-320	Ratchet cable cutting tool cuts both copper and aluminum solid code cables (AL cable to 600MCM and CU cable to 500MCM) from 1/4" (6mm) to 1" (25mm) and stranded flex cables from 1/4" (6mm) to 1-1/4" (32mm) diameter. Approximate dimensions 10" (254mm) x 3-3/4" (95mm) x 1" (25.4mm). Tool weight 21 oz. (600 g) Warranty: 1 year.	1

## Die Type, Manual Hydraulic, 14 Ton, Crimping Tool

- Develops 14 tons of crimping force, crimps copper compression lugs and splices up to 750 kcmil
- Two-stage rapid advance hydraulic system minimizes number of pumps required to complete a crimp, saves time
- High quality, durable tool construction provides long-term dependability
- Cushioned grip prevents hands from slipping on tool, reduces fatigue
- Provides UL Listed and CSA Certified connections on Panduit® Pan-Lug™ Copper and Aluminum Lugs and Splices and Copper Taps

- Open "C-Head" design allows easy loading of crimping dies and connectors, saves time
- Uses color-coded crimping dies to provide easy matching of crimping die to connector
- Embosses die index number on connector barrels to provide post crimp inspection
- Dies installed using spring loaded die retention pins, no need for tools
- Rubber boot on crimp head provides abrasion protection
- Audible "pop-off" valve indicates crimp completion
- Crimp head rotates 180 degrees, provides versatility for use in restricted spaces



Part Number	Part Description	Std. Pkg. Qty.
CT-930	<p>Terminates Panduit® Pan-Lug™ Compression Connectors:</p> <ul style="list-style-type: none"> <li>• Copper compression lugs and splices for #8 AWG – 750 kcmil code conductor</li> <li>• Copper compression lugs and splices for #8 AWG – 600 kcmil flex conductor</li> <li>• StructuredGround™ Direct Burial Compression Grounding System Connectors for #6 AWG – 250 kcmil code conductor and select 500 kcmil conductor combinations</li> <li>• Copper compression CTAPF taps for #10 – 3/0 AWG code conductor</li> <li>• Copper compression CTAP taps for #8 – 4/0 AWG code conductor</li> <li>• Copper compression HTCT taps for #14 AWG – 250 kcmil code conductor, #14 – 4/0 AWG flex conductor</li> <li>• Aluminum compression lugs and splices for #6 AWG – 600 kcmil code conductor</li> <li>• Panduit® Pan-Term® Tubular Terminals for #8 AWG – 250 kcmil code conductor</li> </ul> <p>Specifications:                      Output: 14 tons                      Jaw opening: 1.65"                      Weight: 16.5 lbs.                      Length: 25"                      Handle span: 17 1/2" (open), 6" (closed)                      Warranty: 5 years</p> <p>CT-930 includes:                      • Tool                      • Plastic tool case with die storage</p>	1

Uses CD-920 and CD-930 color-coded crimping dies. Dies must be purchased separately, see page D3.50. CG-920 crimp force measurement gauge available, sold separately see page D3.55.

A. System Overview

B1. Cable Ties

B2. Cable Accessories

B3. Stainless Steel Ties

C1. Wiring Duct

C2. Surface Raceway

C3. Abrasion Protection

C4. Cable Management

D1. Terminals

D2. Power Connectors

D3. Grounding Connectors

E1. Labeling Systems

E2. Labels

E3. Pre-Printed & Write-On Markers

E4. Permanent Identification

E5. Lockout/Tagout & Safety Solutions

F. Index

A. System Overview

B1. Cable Ties

B2. Cable Accessories

B3. Stainless Steel Ties

C1. Wiring Duct

C2. Surface Raceway

C3. Abrasion Protection

C4. Cable Management

D1. Terminals

D2. Power Connectors

D3. Grounding Connectors

E1. Labeling Systems

E2. Labels

E3. Pre-Printed & Write-On Markers

E4. Permanent Identification

E5. Lockout/Tagout & Safety Solutions

F. Index

## **NEW!** Die Type, Lithium-Ion Powered Hydraulic, 6 Ton, In-Line Crimping Tool

- Lithium-ion battery powered, provides fingertip operation and up to 90% more crimps per battery charge than tools powered with NiCd or NiMH batteries
- Batteries incorporate LED fuel gage so battery charge level can be checked to allow for continuous operation
- In-line tool design with low profile, 180° rotating, enclosed crimp head design for reaching into tight spaces
- Approximately 2.9 second crimp cycle time provides quick terminations, 26% faster than tools with NiCd or NiMH batteries
- Lightweight and ergonomically balanced for easy operation without fatigue, weighs 7.15 lbs. with battery
- Battery charger charges expended batteries completely in 30-60 minutes
- Self-contained unit, completely portable
- Compatible with CD-2001 and CDM-2001 color-coded crimping dies to provide easy matching of crimping die to connector
- Develops 6 tons of crimping force, up to 389 crimps per battery charge using Panduit 500 kcmil copper lugs and splices
- Embosses die index number on connector barrels to provide post crimp inspection
- Provides UL Listed and CSA Certified connections on Panduit copper lugs, splices and taps
- Dies installed using spring loaded die retention pins, no need for tools
- Audible “pop-off” valve indicates crimp completion
- Tool provided with two, Milwaukee® M18™ XC high capacity lithium-ion 18VDC rechargeable batteries, battery charger, wrist strap and tool bag



CT-3001 and CT-3001/E



**FREE! Heavy-Duty Soft Sided Tool Bag Included**



PTB-HO (sold separately)



Part Number	Charger Voltage	Part Description	Std. Pkg. Qty.
CT-3001	120 VAC	Terminates Panduit Compression Connectors: <ul style="list-style-type: none"> <li>• Copper compression lugs and splices for #8 AWG – 500 kcmil code conductor</li> <li>• Copper compression lugs for #8 AWG – 373 kcmil flex conductor</li> <li>• Copper compression CTAPF taps for #10 – 3/0 AWG code conductor</li> <li>• Copper compression CTAP taps for #8 – #2 AWG code conductor</li> <li>• Copper compression S Series Pan-Term® Tubular Terminals for #8 AWG – 250 kcmil code conductor</li> <li>• Copper compression lugs and splices for 10mm² – 240mm² class 2R conductor</li> </ul> Specifications: Output: 6 tons (54 Kn) Jaw opening: 1.8" (45.7mm) Weight: 7.15 lbs. (3.2 kg) with battery Length: 19.5" (495.3mm), Height: 4.5" (114.3mm), Width: 2.88" (73mm) Warranty: 3 years on tool, 5 years on batteries and charger	1
CT-3001/E	230 VAC	Tool includes: <ul style="list-style-type: none"> <li>• Two Milwaukee® M18™ XC high capacity lithium-ion 18VDC rechargeable batteries</li> <li>• One Milwaukee® battery charger</li> <li>• Heavy-duty bag with storage for tool, batteries, charger and crimping dies; includes 58 pockets and a shoulder strap for added convenience; 18"L x 7"W x 14"H*</li> </ul>	1
PTB-HO	—	Streamlined holster for CT-3001 Series tools. Can be secured to installer's tool belt or ladder/fixture with quick connect hooks provided.	1

Compatible with CD-2001 and CDM-2001 crimping dies, sold separately, see page D3.42.

\*Tool bag also sold separately, see part number PTB-GP on page D3.55.



## Die Type, Lithium-Ion Powered Hydraulic, 6 Ton, Crimping Tool with Open “C-Head”

- Lithium-Ion battery powered, provides fingertip operation and up to 120% more crimps per battery charge than tools powered with NiCd or NiMH batteries
- Pistol grip tool design with low profile, open “C-Head” provides easy loading of crimping dies and rotates 180°, for reaching into tight spaces
- Lightweight and ergonomically balanced for easy operation without fatigue, weighs 11.75 lbs. with battery
- Self-contained unit, completely portable
- Develops 6 tons of crimping force, crimps copper compression lugs and splices up to 500 kcmil, up to 260 crimps per battery charge using Panduit 500 kcmil copper lugs and splices
- Provides UL Listed and CSA Certified connections on Panduit copper lugs, splices, and taps
- Audible “pop-off” valve indicates crimp completion
- Tool provided with two, Milwaukee® M18™ XC high capacity lithium-ion 18VDC rechargeable batteries, battery charger, shoulder strap, and tool bag
- Batteries incorporate LED fuel gage so battery charge level can be checked to allow for continuous operation
- Approximately 3.1 second crimp cycle time provides quick terminations, 18% faster than tools using NiCd or NiMH batteries
- Battery charger charges expended batteries completely in 30-60 minutes
- Compatible with CD-2001 and CDM-2001 color-coded crimping dies to provide easy matching of crimping die to connector
- Embosses die index number on connector barrels to provide post crimp inspection
- Dies installed using spring loaded die retention pins, no need for tools



**FREE! Heavy-Duty Soft Sided Tool Bag Included**

Part Number	Charger Voltage	Part Description	Std. Pkg. Qty.
CT-2002/L	120 VAC	<p>Terminates Panduit Compression Connectors:</p> <ul style="list-style-type: none"> <li>• Copper compression lugs and splices for #8 AWG – 500 kcmil code conductor</li> <li>• Copper compression lugs for #8 AWG – 373 kcmil flex conductor</li> <li>• Copper compression S Series, Pan-Term™ Tubular Terminals for #8 – 250 kcmil code conductor</li> <li>• Copper compression lugs and splices for 10mm<sup>2</sup> – 240mm<sup>2</sup> class 2R conductor</li> <li>• Copper compression CTAPF taps for #10 – 3/0 AWG code conductor</li> <li>• Copper compression CTAP taps for #8 – #2 AWG code conductor</li> </ul> <p>Specifications:                      Output: 6 tons (54 Kn)                      Jaw opening: .95" (24.1mm)                      Weight: 11.75 lbs. (5.3 kg) with battery                      Length: 13.5" (334mm), Height: 15" (381mm), Width: 3" (76.2mm)                      Warranty: 5 years on tool, batteries and charger</p> <p>CT-2002/L includes:</p> <ul style="list-style-type: none"> <li>• Two Milwaukee® M18™ XC high capacity lithium-ion 18VDC rechargeable batteries</li> <li>• One Milwaukee® battery charger</li> <li>• One shoulder strap</li> <li>• Heavy-duty bag with storage for tools, batteries, charger, and crimping dies; includes 58 pockets and a shoulder strap for added convenience; 18"L x 7"W x 14"H*</li> <li>• Tool incorporates D3 die pocket</li> </ul>	1

Compatible with CD-2001 and CDM-2001 crimping dies, sold separately, see page D3.42.

\*Tool bag also sold separately, see part number PTB-GP on page D3.55.

A. System Overview

B1. Cable Ties

B2. Cable Accessories

B3. Stainless Steel Ties

C1. Wiring Duct

C2. Surface Raceway

C3. Abrasion Protection

C4. Cable Management

D1. Terminals

D2. Power Connectors

D3. Grounding Connectors

E1. Labeling Systems

E2. Labels

E3. Pre-Printed & Write-On Markers

E4. Permanent Identification

E5. Lockout/Tagout & Safety Solutions

F. Index

A. System Overview

B1. Cable Ties

B2. Cable Accessories

B3. Stainless Steel Ties

C1. Wiring Duct

C2. Surface Raceway

C3. Abrasion Protection

C4. Cable Management

D1. Terminals

D2. Power Connectors

D3. Grounding Connectors

E1. Labeling Systems

E2. Labels

E3. Pre-Printed & Write-On Markers

E4. Permanent Identification

E5. Lockout/Tagout & Safety Solutions

F. Index

## CD-2001 Crimping Dies

- Color-coded to provide easy matching to color-coding marked on connectors
- Embosses die index number on connector barrels to provide post crimp inspection
- Part number permanently marked on crimping die for easy identification
- Provide circumferential crimp results in terminations with premium electrical and mechanical performance



CD-2001

Part Number	Used to Install Panduit Compression Lug and Splice Sizes				Std. Pkg. Qty.
	Copper Die Color and Die No.	Copper Code Conductor Size	Copper Code and Flex Conductor Size for LCAX, LCBX, LCDX, LCCX	Copper Metric Class 2R Conductor Size	
CD-2001-8	Red P21	#8 AWG	#8 AWG	10mm <sup>2</sup>	1
CD-2001-6	Blue P24	#6 AWG	#6 AWG	16mm <sup>2</sup>	1
CD-2001-4	Gray P29	#4 AWG STR #3 AWG STR #2 AWG SOL	#4 AWG #5, #4, #3 AWG DLO flex	25mm <sup>2</sup> 35mm <sup>2</sup>	1
CD-2001-2	Brown P33	#2 AWG	#2 AWG	—	1
CD-2001-1	Green P37	#1 AWG	#1 AWG	50mm <sup>2</sup>	1
CD-2001-1/0	Pink P42	1/0 AWG	1/0 AWG	—	1
CD-2001-2/0	Black P45	2/0 AWG	2/0 AWG	70mm <sup>2</sup>	1
CD-2001-3/0	Orange P50	3/0 AWG	3/0 AWG	—	1
CD-2001-4/0	Purple P54	4/0 AWG	4/0 AWG	95mm <sup>2</sup>	1
CD-2001-250	Yellow P62	250 kcmil	250 kcmil flex 262 kcmil flex	120mm <sup>2</sup>	1
CD-2001-300	White P66	300 kcmil	—	150mm <sup>2</sup>	1
CD-2001-350	Red P71	350 kcmil	300 kcmil flex 313 kcmil flex	—	1
CD-2001-400	Blue P76	400 kcmil	350 kcmil flex 373 kcmil flex	185mm <sup>2</sup>	1
CD-2001-500	Brown P87	500 kcmil	—	240mm <sup>2</sup>	1

Part Number	Used to Install Panduit Tap Part Numbers			Std. Pkg. Qty.
	Copper Die Color and Die No.	Copper Tap	No. of Crimps	
CD-2001-8	Red P21	CTAPF10-16-C	1	1
CD-2001-6	Blue P24	CTAPF8-12-C	1	1
CD-2001-4	Gray P29	CTAPF6-12-C	1	1
CD-2001-2	Brown P33	CTAPF4-12-C	2	1
CD-2001-1	Green P37	CTAPF3-12-C	2	1
CD-2001-1/0	Pink P42	CTAPF2-12-C	2	1
CD-2001-2/0	Black P45	CTAPF1-12-C	3	1
CD-2001-3/0	Orange P50	CTAPF1/0-12-L	3	1
CD-2001-4/0	Purple P54	CTAPF2/0-12-Q	3	1
CD-2001-250	Yellow P62	CTAPF3/0-12-Q	3	1
CD-2001-BG	PBG	CTAP4-8-L	1	1
	PBG	CTAP4-6-L	1	
	PBG	CTAP4-4-L	1	
CD-2001-C	P-C	CTAP2-4-Q	2	1
	P-C	CTAP2-2-X	2	

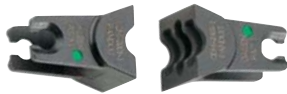

CDM-2001

### Multi-Crimp Dies – Multiple Crimps in One Tool Cycle

CDM-2001-2	Brown P33M	CTAPF4-12-C	1	1
CDM-2001-1	Green P37M	CTAPF3-12-C	1	1
CDM-2001-1/0	Pink P42M	CTAPF2-12-C	1	1
CDM-2001-2/0	Black P45M	CTAPF1-12-C	2	1
CDM-2001-3/0	Orange P50M	CTAPF1/0-12-L	2	1



## Die Type, Lithium-Ion Powered Hydraulic, 14 Ton, Crimping Tool

- Lithium-Ion battery powered, provides fingertip operation and up to 63% more crimps per battery charge than tools powered with NiCd or NiMH batteries
- Pistol grip tool design with open "C-Head" provides easy loading of crimping dies and rotates 180°, for reaching into tight spaces
- Ergonomically balanced for easy operation without fatigue, weighs 17.9 lbs. with battery
- Self-contained unit, completely portable
- Develops 14 tons of crimping force, crimps copper compression lugs and splices up to 750 kcmil, up to 78 crimps per battery charge using Panduit 500 kcmil copper lugs and splices
- Provides UL Listed and CSA Certified connections on Panduit copper and aluminum lugs and splices and copper taps
- Audible "pop-off" valve indicates crimp completion or Ram automatically retracts when crimp cycle is complete
- Tool provided with two, Milwaukee® M18™ XC high capacity lithium-ion 18VDC rechargeable batteries, battery charger, shoulder strap, and tool bag
- Batteries incorporate LED fuel gage so battery charge level can be checked to allow for continuous operation
- Approximately 9.6 second crimp cycle time provides quick terminations, 30% faster than tools using NiCd or NiMH batteries
- Battery charger charges expended batteries completely in 30-60 minutes
- Compatible with CD-920, CDM-920, and CD-930 color-coded crimping dies to provide easy matching of crimping die to connector
- Embosses die index number on connector barrels to provide post crimp inspection
- Dies installed using spring loaded die retention pins, no need for tools



CT-2930/L and CT-2930/LE



FREE! Heavy-Duty Soft Sided Tool Bag Included



Part Number	Charger Voltage	Part Description	Std. Pkg. Qty.
CT-2930/L	120 VAC	<p>Terminates Panduit compression connectors:</p> <ul style="list-style-type: none"> <li>• Copper compression lugs and splices for #8 AWG – 750 kcmil code conductor</li> <li>• Copper compression lugs for #8 AWG – 600 kcmil flex conductor</li> <li>• Copper compression S Series, Pan-Term™ Tubular Terminals for #8 AWG – 250 kcmil code conductor</li> <li>• Copper compression lugs and splices for 10mm<sup>2</sup> – 400mm<sup>2</sup> class 2R conductor</li> <li>• StructuredGround™ Direct Burial Compression Grounding System connectors #6 AWG – 250 kcmil code conductor and select 500 kcmil conductor combinations</li> <li>• Copper compression CTAPF taps for #10 – 3/0 AWG code conductor</li> <li>• Copper compression CTAP taps for #8 – 4/0 AWG code conductor</li> <li>• Copper compression HTCT taps for #14 AWG – 250 kcmil code conductor, #14-4/0 AWG flex conductor</li> <li>• Aluminum compression lugs and splices for #6 AWG – 600 kcmil code conductor</li> </ul> <p>Specifications:                      Output: 14 tons (124.5 Kn)                      Jaw opening: 1.65" (41.9mm)                      Weight: 17.90 lbs. (8.1 kg) with battery                      Length: 14.5" (368.3mm), Height: 16.5" (419.1mm), Width: 3.25" (82.6mm)                      Warranty: 5 years on tool, batteries, and charger</p>	1
CT-2930/LE	230 VAC	<p>Tool includes:</p> <ul style="list-style-type: none"> <li>• Two Milwaukee® M18™ XC high capacity lithium-ion 18VDC rechargeable batteries</li> <li>• One Milwaukee® battery charger</li> <li>• One shoulder strap</li> <li>• Heavy-duty bag with storage for tool, batteries, charger, and crimping dies; includes 58 pockets and a shoulder strap for added convenience; 18"L x 7"W x 14"H*</li> </ul>	1

Compatible with CD-920, CDM-920, and CD-930 crimping dies, sold separately, see page D3.50.

\*Tool bag also sold separately, see part number PTB-GP on page D3.55.

A. System Overview

B1. Cable Ties

B2. Cable Accessories

B3. Stainless Steel Ties

C1. Wiring Duct

C2. Surface Raceway

C3. Abrasion Protection

C4. Cable Management

D1. Terminals

D2. Power Connectors

D3. Grounding Connectors

E1. Labeling Systems

E2. Labels

E3. Pre-Printed & Write-On Markers

E4. Permanent Identification

E5. Lockout/Tagout & Safety Solutions

F. Index

A. System Overview

B1. Cable Ties

B2. Cable Accessories

B3. Stainless Steel Ties

C1. Wiring Duct

C2. Surface Raceway

C3. Abrasion Protection

C4. Cable Management

D1. Terminals

D2. Power Connectors

D3. Grounding Connectors

E1. Labeling Systems

E2. Labels

E3. Pre-Printed & Write-On Markers

E4. Permanent Identification

E5. Lockout/Tagout & Safety Solutions

F. Index



## NEW! Die Type, Lithium-Ion Powered Hydraulic, 15 Ton, Crimping Tool

- Lithium-ion battery powered, provides fingertip operation and up to 43% more crimps per battery charge than tools powered with NiCd or NiMH batteries
- Flip-top crimp head allows easy loading of crimping dies and connectors and rotates 180°
- Ergonomically balanced for easy operation without fatigue, weighs 24.4 lbs. with battery
- Self-contained unit, completely portable
- Develops 15 tons of crimping force, crimps copper compression lugs, splices and taps up to 1000 kcmil, up to 63 crimps per battery charge when crimping Panduit 500 kcmil copper lugs
- Provides UL Listed and CSA Certified connections on Panduit copper and aluminum lugs and splices and copper taps
- Audible “pop-off” valve indicates crimp completion
- Tool provided with two, Milwaukee® M18™ XC high capacity lithium-ion 18VDC rechargeable batteries, battery charger, and shoulder strap
- Batteries incorporate LED fuel gage so battery charge level can be checked to allow for continuous operation
- Approximately 8.8 second crimp cycle time provides quick terminations, 27% faster than tools using NiCd or NiMH batteries
- Battery charger charges expended batteries completely in 30-60 minutes
- Compatible with CD-940, CD-920, CDM-920, and CD-930 color-coded crimping dies to provide easy matching of crimping die to connector
- Embosses die index number on connector barrels to provide post crimp inspection
- Dies installed using spring loaded die retention pins, no need for tools



CT-2940/L and CT-2940/LE



Part Number	Charger Voltage	Part Description	Std. Pkg. Qty.
CT-2940/L	120 VAC	Terminates Panduit Compression Connectors: <ul style="list-style-type: none"> <li>• Copper compression lugs and splices for #8 AWG – 1000 kcmil code conductor</li> <li>• Copper compression lugs for #8 AWG – 777.7 kcmil flex conductor</li> <li>• Copper compression S Series, Pan-Term™ Tubular Terminals for #8 – 250 kcmil code conductor</li> <li>• Copper compression lugs and splices for 10mm<sup>2</sup> – 630mm<sup>2</sup> class 2R conductor</li> <li>• StructuredGround™ Direct Burial Compression Grounding System connectors #6 AWG – 500 kcmil code conductor</li> <li>• Copper compression CTAPF taps for #10 – 3/0 AWG code conductor</li> <li>• Copper compression CTAP taps for #8 – 4/0 AWG code conductor</li> <li>• Copper compression HTCT taps for #14 AWG – 250 kcmil code conductor, #14 – 4/0 AWG flex conductor</li> <li>• Aluminum compression lugs and splices for #6 AWG – 1000 kcmil code conductor</li> </ul>	1
CT-2940/LE	230 VAC	Specifications: Output: 15 tons (136 Kn) Jaw opening: 2" (50.8mm) Weight: 24.35 lbs. (11.0 kg) with battery Length: 22" (558.8mm), Height: 10.75" (273.1mm), Width: 3.75" (95.3mm) Warranty: 5 years on tool, batteries and charger  Tool includes: <ul style="list-style-type: none"> <li>• Two Milwaukee® M18™ XC high capacity lithium-ion 18VDC rechargeable batteries</li> <li>• One Milwaukee® battery charger</li> <li>• One shoulder strap</li> <li>• Plastic tool case with storage for tool, batteries, charger, shoulder strap and crimping dies</li> </ul>	1

Compatible with CD-940 crimping dies, sold separately, see page D3.51.

Also works with CD-920, CDM-920, and CD-930 crimping dies, on page D3.50 with CD-940-DA die adapter, sold separately, see page D3.51.

## Die Type, Remote Hydraulic, 14 Ton, Crimp Head

- Develops 14 tons of crimping force when used with 10,000 psi hydraulic pump and hose, crimps copper compression lugs and splices up to 750 kcmil
- Incorporates Parker type quick-connect fittings to ease installation and save time
- High quality, durable tool construction provides long-term dependability
- Provides UL Listed and CSA Certified connections on Panduit® Pan-Lug™ Copper and Aluminum Lugs and Splices and Copper Taps
- Open “C-Head” design allows easy loading of crimping dies and connectors, saves time
- Uses color-coded crimping dies to provide easy matching of crimping die to connector
- Embosses die index number on connector barrels for post crimp inspection
- Dies installed using spring loaded die retention pins, no need for tools
- Cast in handle allows crimp head to be mounted in a bench vice



Part Number	Part Description	Std. Pkg. Qty.
CT-930CH	<p>Terminates Panduit compression connectors:</p> <ul style="list-style-type: none"> <li>• Copper compression lugs and splices for #8 AWG – 750 kcmil code conductor</li> <li>• Copper compression lugs for #8 AWG – 600 kcmil flex conductor</li> <li>• Copper compression S Series, Pan-Term™ Tubular Terminals for #8 AWG – 250 kcmil code conductor</li> <li>• Copper compression lugs and splices for 10mm<sup>2</sup> – 400mm<sup>2</sup> class 2R conductor</li> <li>• StructuredGround™ Direct Burial Compression Grounding System connectors #6 AWG – 250 kcmil code conductor and select 500 kcmil conductor combinations</li> <li>• Copper compression CTAPF taps for #10 – 3/0 AWG code conductor</li> <li>• Copper compression CTAP taps for #8 – 4/0 AWG code conductor</li> <li>• Copper compression HTCT taps for #14 AWG – 250 kcmil code conductor, #14-4/0 AWG flex conductor</li> <li>• Aluminum compression lugs and splices for #6 AWG – 600 kcmil code conductor</li> </ul> <p>Use with Panduit CT-901HP hydraulic pump and CT-900HPH 10' hydraulic hose.*</p> <p>Specifications:                      Output: 14 tons                      Jaw opening: 1.65"                      Weight: 11 lbs.                      Length: 12 1/4"                      Height: 5"                      Width: 3"                      Warranty: 5 years</p> <p>CT-930CH includes:</p> <ul style="list-style-type: none"> <li>• Tool</li> <li>• Steel tool case</li> <li>• Supplied with female Parker type quick-connect fitting assembled to tool</li> </ul>	1

Uses CD-920 and CD-930 color-coded crimping dies. Dies must be purchased separately, see page D3.50.

\*CT-901RCH remote control handle available, offering one hand operation of crimp head with Panduit CT-901HP hydraulic pump and CT-900HPH hose, sold separately, see page D3.47. CG-920 crimp force measurement gauge available, sold separately, see page D3.55.

A.  
System  
Overview

B1.  
Cable Ties

B2.  
Cable  
Accessories

B3.  
Stainless  
Steel Ties

C1.  
Wiring  
Duct

C2.  
Surface  
Raceway

C3.  
Abrasion  
Protection

C4.  
Cable  
Management

D1.  
Terminals

D2.  
Power  
Connectors

D3.  
Grounding  
Connectors

E1.  
Labeling  
Systems

E2.  
Labels

E3.  
Pre-Printed  
& Write-On  
Markers

E4.  
Permanent  
Identification

E5.  
Lockout/  
Tagout  
& Safety  
Solutions

F.  
Index

A. System Overview

## Die Type, Remote Hydraulic, 15 Ton, Crimp Head

B1. Cable Ties

• Develops 15 tons of crimping force when used with 10,000 psi hydraulic pump and hose, crimps copper compression lugs and splices up to 1,000 kcmil

• Open “C-Head” design allows easy loading of crimping dies and connectors, saves time

B2. Cable Accessories

• Incorporates Parker type quick-connect fittings to ease installation and save time

• Uses color-coded crimping dies to provide easy matching of crimping die to connector

• High quality, durable tool construction provides long-term dependability

• Embosses die index number on connector barrels for post crimp inspection

B3. Stainless Steel Ties

• Provides UL Listed and CSA Certified connections on Panduit® Pan-Lug™ Copper and Aluminum Lugs and Splices and Copper Taps

• Dies installed using spring loaded die retention pins, no need for tools

• Cast in handle allows crimp head to be mounted in a bench vice



Part Number	Part Description	Std. Pkg. Qty.
CT-940CH	<p>Terminates Panduit Compression Connectors:</p> <ul style="list-style-type: none"> <li>• Copper compression lugs and splices for #8 AWG – 1000 kcmil code conductor</li> <li>• Copper compression lugs for #8 AWG – 777.7 kcmil flex conductor</li> <li>• Copper compression S Series, Pan-Term™ Tubular Terminals for #8 – 250 kcmil code conductor</li> <li>• Copper compression lugs and splices for 10mm<sup>2</sup> – 630mm<sup>2</sup> class 2R conductor</li> <li>• StructuredGround™ Direct Burial Compression Grounding System connectors #6 AWG – 500 kcmil code conductor</li> <li>• Copper compression CTAPF taps for #10 – 3/0 AWG code conductor</li> <li>• Copper compression CTAP taps for #8 – 4/0 AWG code conductor</li> <li>• Copper compression HTCT taps for #14 AWG – 250 kcmil code conductor, #14 – 4/0 AWG flex conductor</li> <li>• Aluminum compression lugs and splices for #6 AWG – 1000 kcmil code conductor</li> </ul> <p>Use with Panduit CT-901HP hydraulic pump and CT-900HPH 10' hydraulic hose.*</p> <p>Specifications:                      Output: 15 tons                      Jaw opening: 2"                      Weight: 14.5 lbs.                      Length: 14.5"                      Height: 4.1"                      Width: 2.5"                      Warranty: 5 years</p> <p>CT-940CH includes:                      • Tool                      • Steel tool case                      • Supplied with female Parker type quick-connect fitting assembled to tool</p>	1

Uses CD-920 and CD-930 color-coded crimping dies with CD-940-DA die adapter. Uses color-coded CD-940 crimping dies. Crimping dies and die adapter must be purchased separately, see pages D3.50 and D3.51. CG-940 crimp force measurement gauge available, sold separately, see page D3.55.

\*CT-901RCH remote control handle available, offering one hand operation of crimp head with Panduit CT-901HP hydraulic pump and CT-900HPH hose, sold separately, see page D3.47.

C1. Wiring Duct

C2. Surface Raceway

C3. Abrasion Protection

C4. Cable Management

D1. Terminals

D2. Power Connectors

D3. Grounding Connectors

E1. Labeling Systems

E2. Labels

E3. Pre-Printed & Write-On Markers

E4. Permanent Identification

E5. Lockout/Tagout & Safety Solutions

F. Index



## Hydraulic Pump and Accessories, Electric, 10,000 PSI

- Develops 10,000 psi of hydraulic pressure
- Easy to operate using manual switch or remote pendant supplied; or optional CT-901RFS foot switch or CT-901RCH remote controlled handle
- Factory set relief valve, pump stops when crimp is complete
- Convenient 120 VAC operation
- Incorporates Parker type quick-connect fittings to ease installation and save time
- Versatile, can be used with Panduit CT-930CH, CT-940CH, or CT-980CH crimp heads



CT-901HP



CT-900HPH



CT-901RCH



CT-901RFS

Part Number	Part Description	Std. Pkg. Qty.
CT-901HP	<p>Hydraulic pump. Develops 10,000 PSI output. Pump shuts off when cycle is complete. Will not release until down switch is activated. Compatible with CT-900HPH hydraulic hose, CT-930CH, CT-940CH, and CT-980CH crimp heads sold separately.*</p> <p>Specifications:                      Pump output: 10,000 psi                      Tank capacity: 2.5L incorporates sight gauge for visual inspection of fluid level                      Fluid type: Aero Shell #4 or equal                      Motor: 120 VAC 50/50Hz                      Current: 6.5 Amps                      Horsepower: 1/2 hp                      Weight: 34 lbs.                      Length: 7"                      Height: 14"                      Width: 6"                      Warranty: 5 years</p> <p>CT-901HP pump includes:                      • On/off pendant switch on 10' electric cord                      • Three prong A/C plug on 10' electric cord                      • Supplied with female Parker type quick-connect fitting assembled to pump</p>	1
CT-900HPH	Electrically non-conductive 10' hose compatible with Panduit CT-901HP hydraulic pump and CT-930CH, CT-940CH, and CT-980CH crimp heads, supplied pre-filled with hydraulic fluid for fast start up. Supplied with two male Parker type quick-connect fittings. Warranty: 5 years.	1
CT-901RCH	Remote control handle provides plastic carrying handle incorporating on/off activation switch that allows operator to hold crimp head and activate CT-901HP hydraulic pump with one hand. Use with Panduit remote hydraulic crimp heads CT-930CH, CT-940CH, and CT-980CH. Equipped with 3/8" Parker type quick-connect coupler for attaching crimp heads to Panduit CT-900HPH hydraulic hose. Includes a 10', three wire control cable that can be directly connected to the CT-901HP pump. Warranty: 5 years.	1
CT-901RFS	Dual electrical foot switch that allows convenient "hands free" operation of the Panduit CT-901HP or CT-8250HP electric hydraulic pumps used with Panduit remote hydraulic crimp heads. Supplied with 10' electric cord that can be directly connected to Panduit hydraulic pumps. Warranty: 5 years.	1

Contact Panduit Customer Service for use in production environments.  
 \*For information on crimp heads, see pages D3.45, D3.46, and D3.54.

A. System Overview

B1. Cable Ties

B2. Cable Accessories

B3. Stainless Steel Ties

C1. Wiring Duct

C2. Surface Raceway

C3. Abrasion Protection

C4. Cable Management

D1. Terminals

D2. Power Connectors

D3. Grounding Connectors

E1. Labeling Systems

E2. Labels

E3. Pre-Printed & Write-On Markers

E4. Permanent Identification

E5. Lockout/Tagout & Safety Solutions

F. Index

A. System Overview

## Die Type, Remote Hydraulic, 10.5 Ton, Crimp Head

B1. Cable Ties

- Low pressure system extends life of crimp head for high volume crimping applications

- Open “C-Head” design allows easy loading of crimping dies and connectors, saves time

B2. Cable Accessories

- Develops 10.5 tons of crimping force when used with 7,500 psi hydraulic pump and hose, crimps copper compression lugs and splices up to 250 kcmil
- Incorporates Parker type quick-connect fittings to ease installation and save time

- Uses color-coded crimping dies to provide easy matching of crimping die to connector

B3. Stainless Steel Ties

- High quality, durable tool construction and low pressure hydraulic requirements provide long-term dependability and tool life
- Provides UL Listed and CSA Certified connections on Panduit® Pan-Lug™ Copper Lugs and Splices

- Embosses die index number on connector barrels for post crimp inspection

- Dies installed using spring loaded die retention pins, no need for tools

- Cast in handle allows crimp head to be mounted in a bench vice

C1. Wiring Duct



C2. Surface Raceway

C3. Abrasion Protection

C4. Cable Management

Part Number	Part Description	Std. Pkg. Qty.
<b>CT-930LPCH</b>	<p>Remote hydraulic crimp head provides UL Listed or Recognized terminations of Panduit® Pan-Lug™ Copper Compression Lugs and Splices for #8 AWG – 250 kcmil copper code conductor and 10 – 120mm<sup>2</sup> copper class 2R conductor.</p> <p>Use with Panduit CT-8250HP hydraulic pump and CT-900LPHPH 10' hydraulic hose.*</p> <p>Specifications:                      Output: 10.5 tons                      Jaw opening: 1.65"                      Weight: 11 lbs.                      Length: 12 1/4"                      Height: 5"                      Width: 3"                      Warranty: 5 years</p> <p>CT-930LPCH includes:                      • Tool                      • Steel tool case                      • Supplied with male Parker type quick-connect fitting assembled to tool</p>	1

Uses CD-920 color-coded crimping dies. Dies must be purchased separately, see page D3.50. PG-1 in-line pressure gauge provides visual measurement of hydraulic output pressure, sold separately, see page D3.55.  
 \*For information on hydraulic pump and hose, see page D3.49.

D1. Terminals

D2. Power Connectors

D3. Grounding Connectors

E1. Labeling Systems

E2. Labels

E3. Pre-Printed & Write-On Markers

E4. Permanent Identification

E5. Lockout/Tagout & Safety Solutions

F. Index

## Hydraulic Pump and Accessories, Electric, 7,500 PSI

- Develops 7,500 psi of hydraulic pressure
- Easy to operate using manual switch or remote pendant supplied; or optional CT-901RFS foot switch
- Factory set relief valve, pump stops when crimp is complete
- Convenient 120 VAC operation
- Incorporates Parker type quick-connect fittings to ease installation and save time
- Versatile, can be used with Panduit CT-930LPCH or CT-980LPCH crimp heads



CT-8250HP



CT-900LPHPH



CT-901RFS

Part Number	Part Description	Std. Pkg. Qty.
CT-8250HP	<p>Hydraulic pump. Develops 7,500 psi output. Pump shuts off when cycle is complete. Will not release until down switch is activated. Compatible with CT-900LPHPH hydraulic hose, CT-930LPCH, and CT-980LPCH crimp heads sold separately.*</p> <p>Specifications:                      Pump output: 7,500 psi                      Tank capacity: 2.5L incorporates sight gauge for visual inspection of fluid level                      Fluid type: Aero Shell #4 or equal                      Motor: 120 VAC 50/50Hz                      Current: 6.5 Amps                      Horsepower: 1/2 hp                      Warranty: 5 years</p> <p>Weight: 34 lbs.                      Length: 7"                      Height: 14"                      Width: 6"</p> <p>CT-8250HP pump includes:                      • On/off pendant switch on 10' electric cord                      • Three prong A/C plug on 10' electric cord                      • Supplied with male Parker type quick-connect fitting assembled to pump</p>	1
CT-900LPHPH	Electrically non-conductive 10' hose compatible with Panduit CT-8250HP hydraulic pump and CT-930LPCH and CT-980LPCH crimp heads, supplied pre-filled with hydraulic fluid for fast start up. Supplied with two female Parker type quick-connect fittings. Warranty: 5 years.	1
CT-901RFS	Dual electrical foot switch that allows convenient "hands free" operation of the Panduit CT-901HP or CT-8250HP electric hydraulic pumps used with Panduit remote hydraulic crimp heads. Supplied with 10' electric cord that can be directly connected to Panduit hydraulic pumps. Warranty: 5 years.	1

\*For more information on crimp heads, see pages D3.48 and D3.54.

PG-1 in-line pressure gauge provides visual measurement of hydraulic output pressure, sold separately, see page D3.55.

A.  
System  
Overview

B1.  
Cable Ties

B2.  
Cable  
Accessories

B3.  
Stainless  
Steel Ties

C1.  
Wiring  
Duct

C2.  
Surface  
Raceway

C3.  
Abrasion  
Protection

C4.  
Cable  
Management

D1.  
Terminals

D2.  
Power  
Connectors

D3.  
Grounding  
Connectors

E1.  
Labeling  
Systems

E2.  
Labels

E3.  
Pre-Printed  
& Write-On  
Markers

E4.  
Permanent  
Identification

E5.  
Lockout/  
Tagout  
& Safety  
Solutions

F.  
Index

A. System Overview

## CD-920 Crimping Dies

B1. Cable Ties

- Color-coded for easy matching to color-coding marked on connectors
- Embosses die index number on connector barrels for post crimp inspection

- Part number permanently marked on crimping die for easy identification
- Provides circumferential crimp results in terminations with premium electrical and mechanical performance

B2. Cable Accessories

B3. Stainless Steel Ties

C1. Wiring Duct

C2. Surface Raceway

C3. Abrasion Protection

C4. Cable Management

D1. Terminals

D2. Power Connectors

D3. Grounding Connectors

E1. Labeling Systems

E2. Labels

E3. Pre-Printed & Write-On Markers

E4. Permanent Identification

E5. Lockout/Tagout & Safety Solutions

F. Index

### Used to Install Panduit Compression Lug and Splice Sizes

Part Number	Copper Die Color and Die No.	Copper Code Conductor Size	Copper Code and Flex Conductor Size for LCAX, LCBX LCDX, LCCX	Copper Flex Conductor Size for LCAF, LCCF, SCSF	Copper Metric Class 2R Conductor Size	Aluminum Die Color and Die No.	Aluminum Code Conductor Size	Std. Pkg. Qty.
CD-920-8	Red P21	#8 AWG	#8 AWG	#8 AWG	10mm <sup>2</sup>	—	—	1
CD-920-6	Blue P24	#6 AWG	#6 AWG	#6 AWG	16mm <sup>2</sup>	—	—	1
CD-920-4	Gray P29	#4 AWG STR #3 AWG STR #2 AWG SOL	#4 AWG #5, #4, #3 AWG DLO flex	#4 AWG	25mm <sup>2</sup> 35mm <sup>2</sup>	Gray P29	#6 AWG	1
CD-920-2	Brown P33	#2 AWG	#2 AWG	#2 AWG	—	—	—	1
CD-920-1	Green P37	#1 AWG	#1 AWG	—	50mm <sup>2</sup>	Green P37	#4 AWG	1
CD-920-1/0	Pink P42	1/0 AWG	1/0 AWG	#1 AWG	—	Pink P42	#2 AWG	1
CD-920-2/0	Black P45	2/0 AWG	2/0 AWG	1/0 AWG	70mm <sup>2</sup>	Gold P45	#1 AWG	1
CD-920-3/0	Orange P50	3/0 AWG	3/0 AWG	2/0 AWG	—	Tan P50	1/0 AWG	1
CD-920-4/0	Purple P54	4/0 AWG	4/0 AWG	3/0 AWG	95mm <sup>2</sup>	Olive P54	2/0 AWG	1
CD-920-250	Yellow P62	250 kcmil	250 kcmil flex 262 kcmil flex	4/0 AWG	120mm <sup>2</sup>	Ruby P62	3/0 AWG	1
CD-920-300	White P66	300 kcmil	—	250 kcmil 262 kcmil	150mm <sup>2</sup>	White P66	4/0 AWG	1
CD-920-350	Red P71	350 kcmil	300 kcmil flex 313 kcmil flex	300 kcmil 313 kcmil	—	Red P71	250 kcmil	1
CD-920-400	Blue P76	400 kcmil	350 kcmil flex 373 kcmil flex	350 kcmil 373 kcmil	185mm <sup>2</sup>	Blue P76	300 kcmil	1
CD-920-500	Brown P87	500 kcmil	444 kcmil flex 450 kcmil flex	444 kcmil 450 kcmil	240mm <sup>2</sup>	Brown P87	350 kcmil	1
CD-920-600	Green P94	600 kcmil	—	—	300mm <sup>2</sup>	Green P94	400 kcmil	1
CD-920-500A	Pink P99	500 kcmil	500 kcmil flex 535 kcmil flex 600 kcmil flex	500 kcmil 535 kcmil	—	Pink P99	500 kcmil	1
CD-920-750	Black P106	750 kcmil	—	646 kcmil	400mm <sup>2</sup>	Black P106	600 kcmil	1



CD-920



CD-930H



CD-930G

### Used to Install Panduit Tap Part Numbers

Part Number	Copper Die Color and Die No.	Copper Tap	No. of Crimps	Std. Pkg. Qty.
CD-920H-6	Orange PH6	HTCT6X-6X-1	1	1
CD-920H-2	Brown PH2	HTCT2-2-1	1	1
CD-930H-250	Purple PH25	HTCT250-2-1, HTCT250-250-1	1	1
CD-920-BG	PBG	CTAP4-8-L, CTAP4-6-L, CTAP4-4-L	1	1
CD-920-C	PC	CTAP2-4-Q, CTAP2-2-X	1	1
CD-920-D3	PD3	CTAP4/0-2-X, CTAP4/0-2/0-X, CTAP4/0-4/0-X	1	1
CD-920-O	PO	CTAP2/0-2-X, CTAP2/0-2/0-X	1	1

### Multiple Crimp Dies – Multiple Crimps in One Tool Cycle

CDM-920-2	Brown P33M	CTAPF4-12-C	1	1
CDM-920-1	Green P37M	CTAPF3-12-C	1	1
CDM-920-1/0	Pink P42M	CTAPF2-12-C	1	1
CDM-920-2/0	Black P45M	CTAPF1-12-C	1	1
CDM-920-3/0	Orange P50M	CTAPF1/0-12-L	1	1
CDM-920-4/0	Purple P54M	CTAPF2/0-12-Q	1	1
CDM-920-250	Yellow P62M	CTAPF3/0-12-Q	1	1

### Used to Install StructuredGround™ Direct Burial Grounding Connector Part Numbers

Part Number	Copper Die Color and Die No.	Copper Tap	Std. Pkg. Qty.
CD-930G-1/0	Red PG10	GCE1/0-1/0, GCC6X61/0-1/0	1
CD-930G-250	Black PG25	GCE250-1/0, GCE250-250, GCC6X6250-1/0, GCC6X6250-250, GPC4H250-2	1
CD-930G-500	Blue PG50	GCE500-1/0, GCE500-250, GCC6X6500-1/0, GCC6X6500-250	1

## CD-940 Crimping Dies

- Color-coded for easy matching to color-coding marked on connectors
- Embosses die index number on connector barrels for post crimp inspection
- Part number permanently marked on crimping die for easy identification
- Provides circumferential crimp results in terminations with premium electrical and mechanical performance

Part Number	Used to Install Panduit Compression Lug and Splice Sizes							Std. Pkg. Qty.
	Copper Die Color and Die No.	Copper Code Conductor Size	Copper Code and Flex Conductor Size for LCAX, LCBX LCDX, LCCX	Copper Flex Conductor Size for LCAF, LCCF, SCSF	Copper Metric Class 2R Conductor Size	Aluminum Die Color and Die No.	Aluminum Code Conductor Size	
CD-940-750	Black P106	750 kcmil	—	646 kcmil	400mm <sup>2</sup>	—	—	1
CD-940-800	Orange P107	800 kcmil	—	777 kcmil	—	—	—	1
CD-940-1000	White P125	1000 kcmil	—	—	500mm <sup>2</sup> 630mm <sup>2</sup>	—	—	1
CD-940-750X	Yellow P115	—	777.7 kcmil flex	—	—	—	—	1
CD-940-750A	—	—	—	—	—	Red P125	750 kcmil	1
CD-940-800A	—	—	—	—	—	Gray P140	800 kcmil	1
CD-940-1000A	—	—	—	—	—	Brown P161	1000 kcmil	1



CD-940



CD-940-DA

Part Number	Part Description	Std. Pkg. Qty.
CD-940-DA	Die adapter for use with Panduit CT-940CH and CT-2940 crimping tools required for installation of Panduit CD-920, CDM-920, and CD-930 crimping dies in these tools.	1

A.  
System  
Overview

B1.  
Cable Ties

B2.  
Cable  
Accessories

B3.  
Stainless  
Steel Ties

C1.  
Wiring  
Duct

C2.  
Surface  
Raceway

C3.  
Abrasion  
Protection

C4.  
Cable  
Management

D1.  
Terminals

D2.  
Power  
Connectors

D3.  
Grounding  
Connectors

E1.  
Labeling  
Systems

E2.  
Labels

E3.  
Pre-Printed  
& Write-On  
Markers

E4.  
Permanent  
Identification

E5.  
Lockout/  
Tagout  
& Safety  
Solutions

F.  
Index

A.  
System  
Overview

## Uni-Die™ Dieless, Manual Hydraulic, 6.2 Ton, Crimping Tool

B1.  
Cable Ties

- Dieless crimping tool design eliminates purchase or lost crimping dies, saves cost

- Provides UL Listed and CSA Certified connections on Panduit® Pan-Lug™ Copper Lugs and Splices

B2.  
Cable  
Accessories

- Develops 6.2 tons of crimping force with four point indenter system, crimps copper compression lugs and splices up to 750 kcmil

- Provides UL Listed and CSA Certified wire range-taking capability on Panduit® Pan-Lug™ Copper Lugs and Splices, minimizes connector inventory and saves cost

B3.  
Stainless  
Steel Ties

- Two-stage rapid advance hydraulic system minimizes number of pumps required to complete a crimp

- Flip-top crimp head design allows easy loading of connectors, saves time

- High quality, durable tool construction provides long-term dependability

- Audible “pop-off” valve indicates crimp completion

- Cushioned grips prevent hands from slipping on tool, reduces fatigue

- Crimp head rotates 360 degrees, provides versatility for use in restricted spaces

C1.  
Wiring  
Duct

- Incorporates aluminum crimp head and fiberglass handles, results in lightweight tool and ease of operation

C2.  
Surface  
Raceway



C3.  
Abrasion  
Protection

C4.  
Cable  
Management

D1.  
Terminals

D2.  
Power  
Connectors

D3.  
Grounding  
Connectors

E1.  
Labeling  
Systems

E2.  
Labels

E3.  
Pre-Printed  
& Write-On  
Markers

E4.  
Permanent  
Identification

E5.  
Lockout/  
Tagout  
& Safety  
Solutions

F.  
Index

Part Number	Part Description	Std. Pkg. Qty.
CT-980	<p>Manual hydraulic Uni-Die™ Dieless Crimping Tool provides UL Listed or Recognized and CSA Certified terminations of Panduit® Pan-Lug™ Copper Compression Lugs and Splices for #4 AWG – 750 kcmil copper code conductor.</p> <p>Specifications:                      Output: 6.2 tons                      Jaw opening: 1.46"                      Weight: 10.5 lbs.                      Length: 13"                      Height: 12"                      Width: 3"                      Handle span: 15" (open), 5.75" (closed)                      Warranty: 5 years</p> <p>CT-980 includes:                      • Tool                      • Plastic tool case</p>	1

CG-980 pressure gauge for measuring tool output force available, sold separately, see page D3.55.



## Uni-Die™ Dieless, Lithium-Ion Powered Hydraulic, 6.2 Ton, Crimping Tool

- Lithium-Ion battery powered, provides fingertip operation and up to 135% more crimps per battery charge than tools powered with NiCd or NiMH batteries
- Dieless crimping tool design eliminates the cost of crimping dies
- Provides wire range-taking capability with Panduit copper compression connectors, allows use of a minimum of lug sizes to crimp a wide range of wire sizes
- Aluminum alloy flip-top crimp head allows easy loading of connectors and rotates 360°
- Ergonomically balanced and lightweight for easy operation without fatigue, weighs 11.75 lbs. with battery
- Self-contained unit, completely portable
- Develops 6.2 tons of crimping force, crimps copper compression lugs and splices up to 750 kcmil, up to 183 crimps per battery charge when crimping Panduit 500 kcmil copper lugs

- Provides UL Listed and CSA Certified connections on Panduit copper lugs and splices
- Audible “pop-off” valve indicates crimp completion
- Tool provided with two, Milwaukee® M18™ XC high capacity lithium-ion 18VDC rechargeable batteries, battery charger, shoulder strap, and tool bag
- Batteries incorporate LED fuel gage so battery charge level can be checked to allow for continuous operation
- Approximately 3.5 second crimp cycle time provides quick terminations, 25% faster than tools using NiCd or NiMH batteries
- Battery charger charges expended batteries completely in 30-60 minutes



CT-2980/L and CT-2980/LE



FREE! Heavy-Duty Soft Sided Tool Bag Included



Part Number	Charger Voltage	Part Description	Std. Pkg. Qty.
CT-2980/L	120 VAC	<p>Terminates Panduit Compression Connectors:</p> <ul style="list-style-type: none"> <li>• Copper compression lugs and splices for #4 AWG – 750 kcmil code conductor</li> </ul> <p>Specifications:                      Output: 6.2 tons (56 Kn)                      Jaw opening: 1.50" (38.1mm)                      Weight: 11.75 lbs. (8.3 kg) with battery                      Length: 14.75" (374.7mm), Height: 15" (381mm), Width: 3" (76.2mm)                      Warranty: 5 years on tool, batteries and charger</p> <p>Tool includes:</p> <ul style="list-style-type: none"> <li>• Two Milwaukee® M18™ XC high capacity lithium-ion 18VDC rechargeable batteries</li> <li>• One Milwaukee battery charger</li> <li>• One shoulder strap</li> <li>• Heavy-duty bag with storage for tool, batteries, and charger; includes 58 pockets and a shoulder strap for added convenience; 18"L x 7"W x 14"H*</li> </ul>	1
CT-2980/LE	230 VAC		1

\*Tool bag also sold separately, see part number PTB-GP on page D3.55.

A. System Overview

B1. Cable Ties

B2. Cable Accessories

B3. Stainless Steel Ties

C1. Wiring Duct

C2. Surface Raceway

C3. Abrasion Protection

C4. Cable Management

D1. Terminals

D2. Power Connectors

D3. Grounding Connectors

E1. Labeling Systems

E2. Labels

E3. Pre-Printed & Write-On Markers

E4. Permanent Identification

E5. Lockout/Tagout & Safety Solutions

F. Index

A. System Overview

## Uni-Die™ Dieless, Remote Hydraulic, 6.2 Ton, Crimp Head

B1. Cable Ties

• Dieless crimping tool design eliminates purchase or lost crimping dies, saves cost

• Provides UL Listed and CSA Certified connections on Panduit® Pan-Lug™ Copper Lugs and Splices

B2. Cable Accessories

• Develops 6.2 tons of crimping force when used with 10,000 psi hydraulic pump and hose, crimps copper compression lugs and splices up to 750 kcmil

• Provides UL Listed and CSA Certified wire range-taking capability on Panduit® Pan-Lug™ Copper Lugs and Splices, minimizes connector inventory and saves cost

B3. Stainless Steel Ties

• Incorporates Parker type quick-connect fittings to ease installation and save time

• Flip-top crimp head design allows easy loading of splices, saves time

C1. Wiring Duct



C2. Surface Raceway

C3. Abrasion Protection

C4. Cable Management

Part Number	Part Description	Std. Pkg. Qty.
<b>CT-980CH</b>	Remote hydraulic Uni-Die™ dieless crimp head provides UL Listed or Recognized and CSA Certified terminations of Panduit® Pan-Lug™ Copper Compression Lugs and Splices for #4 AWG – 750 kcmil copper code conductor.  Use with Panduit CT-901HP hydraulic pump and CT-900HPH 10' hydraulic hose.*  Specifications: Output: 6.2 tons Jaw opening: 1.46" Weight: 6.5 lbs. Length: 10.5" Height: 5.3" Width: 2.5" Warranty: 5 years  CT-980CH includes: • Tool • Steel tool case • Supplied with female Parker type quick-connect fitting assembled to tool	1

\*CT-901RCH remote control handle available, offering one hand operation of crimp head with Panduit CT-901HP hydraulic pump and CT-900HPH hose, sold separately, see page D3.47. CG-980 crimp force measurement gauge available, sold separately, see page D3.55.

D1. Terminals

## Uni-Die™ Dieless, Remote Hydraulic, 4.7 Ton, Crimp Head

D2. Power Connectors

• Low pressure system extends life of crimp head for high volume crimping application

• Incorporates Parker type quick-connect fittings to ease installation and save time

D3. Grounding Connectors

• Dieless crimping tool design eliminates purchase or lost crimping dies, saves cost

• Provides UL Listed and CSA Certified connections on Panduit® Pan-Lug™ Copper Lugs and Splices

• Develops 4.7 tons of crimping force when used with 7,500 psi hydraulic pump and hose, crimps copper compression lugs and splices up to 250 kcmil

• Flip-top crimp head design allows easy loading of splices, saves time

E1. Labeling Systems



E2. Labels

E3. Pre-Printed & Write-On Markers

E4. Permanent Identification

E5. Lockout/Tagout & Safety Solutions

F. Index

Part Number	Part Description	Std. Pkg. Qty.
<b>CT-980LPCH</b>	Remote hydraulic crimp head provides UL Listed or Recognized and CSA Certified terminations of Panduit® Pan-Lug™ Copper Compression Lugs and Splices for #4 AWG – 250 kcmil code conductor.  Use with Panduit CT-8250HP hydraulic pump and CT-900LPHPH 10' hydraulic hose.*  Specifications: Output: 4.7 tons Weight: 6.5 lbs. Length: 10.5" with coupler Height: 5.3" Width: 2.5" Warranty: 5 years  CT-980LPCH includes: • Tool • Steel tool case • Supplied with male Parker type quick-connect fitting assembled to tool	1

PG-1SC in-line pressure gauge provides visual measurement of hydraulic output pressure, sold separately, see page D3.55.

\*For information on hydraulic pump and hose, see page D3.49.



## Pressure Gauges

- Provide easy visual reading of output force for hydraulic crimping tools
- Factory calibrated to provide accuracy and quality assurance control of crimping tools in the field

- Easy-to-read crimp force tolerance zone for applicable tools marked on gauge
- Blank dies for fixture supplied with test gauge for easy mounting and operation of gauge with crimping tool



CG-920



CG-940



CG-980



PG-1

Part Number	Part Description	Std. Pkg. Qty.
CG-920	Compression gauge – used to measure crimping force generated by Panduit crimping tools: CT-930, CT-930CH, CT-930LPCH, and CT-2930/L.  CG-920 includes: • Pressure gauge • Blank die set • Steel storage case • Warranty: 90 days	1
CG-940	Compression gauge – used to measure output force generated by Panduit crimping tools: CT-940CH and CT-2940/L.  CG-940 includes: • Pressure gauge • Blank die set • Steel storage case • Warranty: 90 days	1
CG-980	Compression gauge – used to insure proper compression force for Uni-Die™ Dieless Crimping Tools: CT-980, CT-980CH, and CT-2980/L.  CG-980 includes: • Pressure gauge • Fixture for mounting gauge in crimping tool • Steel storage case • Warranty: 90 days	1
PG-1	In-line pressure gauge provides visual identification of hydraulic output pressure when used with Panduit CT-930CH, CT-940CH, and CT-980CH crimp heads, CT-901HP pump and CT-900HPH hose. Includes steel storage case. Warranty: 90 days	1
PG-1SC	In-line pressure gauge provides visual identification of hydraulic output pressure when used with Panduit CT-930LPCH and CT-980LPCH crimp heads, CT-8250HP pump and CT-900LPHPH hose. Includes steel storage case. Warranty: 90 days	1

## Accessories for Battery-Powered Hydraulic Crimping Tools



PTB-GP



CT-LIBCKIT



CT-LIBA



Part Number	Part Description	Std. Pkg. Qty.
PTB-GP	Heavy-duty bag for crimping tools and accessories. Includes 58 pockets and a shoulder strap for added convenience. 18"L x 7"W x 14"H.	1
CT-LIBCKIT	Kit to convert Panduit CT-2001, CT-2002, CT-2930, CT-2940 and CT-2980 NiCd battery powered crimping tools to lithium-ion powered. Kit includes one Panduit CT-LIBA battery adapter, two Milwaukee® M18™ XC high capacity lithium-ion 18VDC rechargeable batteries, and one 120 VAC Milwaukee® battery charger.	1
CT-LIBCKIT/E	Kit to convert Panduit CT-2001, CT-2002, CT-2930, CT-2940 and CT-2980 NiCd battery powered crimping tools to lithium-ion powered. Kit includes one Panduit CT-LIBA battery adapter, two Milwaukee® M18™ XC high capacity lithium-ion 18VDC rechargeable batteries, and one 230 VAC Milwaukee® battery charger.	1
CT-LIBA	Lithium-ion battery adapter to convert Panduit CT-2001, CT-2002, CT-2930, CT-2940 and CT-2980 NiCd tools to Milwaukee® M18™ XC high capacity lithium-ion batteries (48-11-1828).	1

A. System Overview

B1. Cable Ties

B2. Cable Accessories

B3. Stainless Steel Ties

C1. Wiring Duct

C2. Surface Raceway

C3. Abrasion Protection

C4. Cable Management

D1. Terminals

D2. Power Connectors

D3. Grounding Connectors

E1. Labeling Systems

E2. Labels

E3. Pre-Printed & Write-On Markers

E4. Permanent Identification

E5. Lockout/Tagout & Safety Solutions

F. Index

A. System Overview  
 B1. Cable Ties  
 B2. Cable Accessories  
 B3. Stainless Steel Ties  
 C1. Wiring Duct  
 C2. Surface Raceway  
 C3. Abrasion Protection  
 C4. Cable Management  
 D1. Terminals  
 D2. Power Connectors  
 D3. Grounding Connectors  
 E1. Labeling Systems  
 E2. Labels  
 E3. Pre-Printed & Write-On Markers  
 E4. Permanent Identification  
 E5. Lockout/Tagout & Safety Solutions  
 F. Index

**For use with Copper Conductors**

## Installation Tooling and Die Selections for: Types LCAS and SCSS

**How to read this chart**  
 For LCA6 lug and CT-2001 crimping tool:

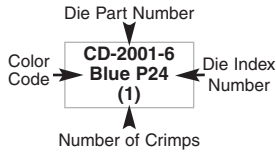

			Panduit (See Compression Connector Tools Selection Guide, Pages D3.34 – D3.36)					Thomas & Betts		
Panduit Part Number	Std. Wire Size	Wire Strip Length (In.)	CT-1700 <sup>①</sup>	CT-720	CT-920, CT-920CH, CT-930, CT-930CH, CT-2930, CT-2930/L, CT-2930/LE, CT-930LPCH, CT-2931, CT-2940 <sup>③</sup> , CT-2940/L <sup>③</sup> , CT-2940/LE <sup>③</sup> , CT-2920, CT-940CH <sup>③</sup>	Uni-Die™ CT-980, CT-2980, CT-2980/L, CT-2980/LE, CT-980CH, CT-2981, CT-980LPCH, CT-2950	CT-2001, CT-2001/L, CT-2001/LE, CT-2002, CT-2002/L, CT-3001, CT-3001/E,	TBM20S, TBM25S	TBM5	TBM6, TBM6S, TBM8, 25000
L=Lug S=Splice			Die Part Number/Color Code and Die Index Number/(Number Of Crimps)							
LCAS8	#8 AWG	1/2	Red P21 (2)	CD-720-1 Red P21 (1)	CD-920-8 Red P21 (1)	—	CD-2001-8 Red P21 (1)	Red 21 (2)	Red 21 (1)	Red 21 (1)
		7/16	Blue P24 (2)	CD-720-1 Blue P24 (1)	CD-920-6 Blue P24 (1)	—	CD-2001-6 Blue P24 (1)	Blue 24 (2)	Blue 24 (1)	Blue 24 (1)
LCAS6	#6 AWG	9/16	Blue P24 (2)	CD-720-1 Blue P24 (1)	CD-920-6 Blue P24 (1)	—	CD-2001-6 Blue P24 (1)	Blue 24 (2)	Blue 24 (1)	Blue 24 (1)
		7/16	Gray P29 (2)	CD-720-1 Gray P29 (1)	CD-920-4 Gray P29 (1)	(1)	CD-2001-4 Gray P29 (1)	Gray 29 (2)	Gray 29 (2)	Gray 29 (2)
LCAS4	#4 AWG	5/8	Gray P29 (2)	CD-720-1 Gray P29 (1)	CD-920-4 Gray P29 (1)	(1)	CD-2001-4 Gray P29 (1)	Gray 29 (2)	Gray 29 (2)	Gray 29 (2)
		7/16	Brown P33 (2)	CD-720-1 Brown P33 (1)	CD-920-2 Brown P33 (1)	(1)	CD-2001-2 Brown P33 (1)	Brown 33 (2)	Brown 33 (2)	Brown 33 (2)
LCAS2	#2 AWG	5/8	Brown P33 (2)	CD-720-1 Brown P33 (1)	CD-920-2 Brown P33 (1)	(1)	CD-2001-2 Brown P33 (1)	Brown 33 (2)	Brown 33 (2)	Brown 33 (2)
		9/16	Green P37 (3)	CD-720-2 Green P37 (1)	CD-920-1 Green P37 (1)	(1)	CD-2001-1 Green P37 (1)	—	Green 37 (1)	Green 37 (1)
LCAS1	#1 AWG	11/16	Green P37 (3)	CD-720-2 Green P37 (1)	CD-920-1 Green P37 (1)	(1)	CD-2001-1 Green P37 (1)	—	Green 37 (1)	Green 37 (1)
		3/4	—	CD-720-2 Pink P42 (1)	CD-920-1/0 Pink P42 (1)	(1)	CD-2001-1/0 Pink P42 (1)	—	Pink 42 (1)	Pink 42 (1)
SCSS1/0	1/0 AWG	11/16	—	CD-720-2 Pink P42 (1)	CD-920-1/0 Pink P42 (1)	(1)	CD-2001-1/0 Pink P42 (1)	—	Pink 42 (1)	Pink 42 (1)
		3/4	—	CD-720-2 Black P45 (2)	CD-920-2/0 Black P45 (1)	(1)	CD-2001-2/0 Black P45 (2)	—	Black 45 (2)	Black 45 (2)
LCAS2/0	2/0 AWG	3/4	—	CD-720-2 Black P45 (2)	CD-920-2/0 Black P45 (1)	(1)	CD-2001-2/0 Black P45 (2)	—	Black 45 (2)	Black 45 (2)
		7/8	—	CD-720-2 Orange P50 (2)	CD-920-3/0 Orange P50 (1)	(1)	CD-2001-3/0 Orange P50 (2)	—	Orange 50 (2)	Orange 50 (2)
SCSS3/0	3/0 AWG	3/4	—	CD-720-2 Orange P50 (2)	CD-920-3/0 Orange P50 (1)	(1)	CD-2001-3/0 Orange P50 (2)	—	Orange 50 (2)	Orange 50 (2)
		1	—	CD-720-3 Purple P54 (2)	CD-920-4/0 Purple P54 (1)	(1)	CD-2001-4/0 Purple P54 (2)	—	Purple 54 (2)	Purple 54 (2)
LCAS4/0	4/0 AWG	13/16	—	CD-720-3 Purple P54 (2)	CD-920-4/0 Purple P54 (1)	(1)	CD-2001-4/0 Purple P54 (2)	—	Purple 54 (2)	Purple 54 (2)
		1-1/8	—	CD-720-3 Yellow P62 (2)	CD-920-250 Yellow P62 (1)	(1)	CD-2001-250 Yellow P62 (2)	—	Yellow 62 (2)	Yellow 62 (2)
SCSS250	250 kcmil	1-1/8	—	CD-720-3 Yellow P62 (2)	CD-920-250 Yellow P62 (1)	(1)	CD-2001-250 Yellow P62 (2)	—	Yellow 62 (2)	Yellow 62 (2)
		1-1/16	—	CD-720-3 Yellow P62 (2)	CD-920-250 Yellow P62 (1)	(1)	CD-2001-250 Yellow P62 (2)	—	Yellow 62 (2)	Yellow 62 (2)

①The CT-1700 crimp die pockets are integrated into the tool frame.  
 ③CD-920 dies can be used with CT-940CH and CT-2940 tools with the CD-940-DA adapter.

For use with  
Copper  
Conductors

## Installation Tooling and Die Selections for: Types LCAS and SCSS (continued)

Thomas & Betts				Burndy				Anderson	Penn-Union	Greenlee
TBM12, 13642M	TBM15, TBM15I, TBM15BSCR	TBM8-750M-I, TBM8-750, TBM8-750BSCR, TBM750BSCR <sup>④</sup>	TBM14M, TBM14BSCR, BPLT14BSCR, 13100A	Y2MR, Y1MRTC, Y1MR	MY29	Y35, Y35BH, Y39, Y39BH, Y45, Y46, Y750, Y750-2, Y750BH, Y750BH-2, Y750HS, PAT750, BAT750, BAT35	Y644M, Y644HS, Y644MBH, PAT644, BAT644	VC6	TDY-1	1989
Die Part Number/Color Code and Die Index Number/(Number of Crimps)										
Red 21 (1)	Red 21 (1)	STD (1)	Red 21 (1)	Red (2)	#8 (1)	U8CRT Red 49 (1)	—	—	—	—
Blue 24 (1)	Blue 24 (1)	STD (1)	Blue 24 (1)	Blue (2)	#6 (1)	U5CRT Blue 7 (1)	STD (1)	STD (1)	—	—
Gray 29 (1)	Gray 29 (1)	STD (1)	Gray 29 (1)	Gray (2)	#4 (1)	U4CRT Gray 8 (1)	STD (1)	STD (1)	STD (1)	STD (1)
Brown 33 (1)	Brown 33 (1)	STD (1)	Brown 33 (1)	Brown (2)	#2 (1)	U2CRT Brown 10 (1)	STD (1)	STD (1)	STD (1)	STD (1)
Green 37 (1)	Green 37 (1)	STD (1)	Green 37 (1)	—	#1 (1)	U1CRT Green 11 (1)	STD (1)	STD (1)	STD (1)	STD (1)
Pink 42 (1)	Pink 42H <sup>②</sup> (2)	STD (1)	Pink 42H <sup>②</sup> (2)	—	1/0 (1)	U25RT Pink 12 (1)	STD (1)	STD (1)	STD (1)	STD (1)
Black 45 (1)	Black 45 (1)	STD (1)	Black 45 (1)	—	2/0 (1)	U26RT Black 13 (1)	STD (1)	STD (1)	STD (1)	STD (1)
Orange 50 (1)	Orange 50 (1)	STD (1)	Orange 50 (1)	—	3/0 (1)	U27RT Orange 14 (1)	STD (1)	STD (1)	STD (1)	STD (1)
Purple 54 (1)	Purple 54H <sup>②</sup> (2)	STD (1)	Purple 54H <sup>②</sup> (2)	—	4/0 (1)	U28RT Purple 15 (1)	STD (1)	STD (1)	STD (1)	STD (1)
Yellow 62 (1)	Yellow 62 (1)	STD (1)	Yellow 62 (1)	—	250 (1)	U29RT Yellow 16 (1)	STD (1)	STD (2)	—	Yellow (2)

②Half width dies.

④Minimum size: #4 AWG lugs and splices.

A.  
System  
Overview

B1.  
Cable Ties

B2.  
Cable  
Accessories

B3.  
Stainless  
Steel Ties

C1.  
Wiring  
Duct

C2.  
Surface  
Raceway

C3.  
Abrasion  
Protection

C4.  
Cable  
Management

D1.  
Terminals

D2.  
Power  
Connectors

D3.  
Grounding  
Connectors

E1.  
Labeling  
Systems

E2.  
Labels

E3.  
Pre-Printed  
& Write-On  
Markers

E4.  
Permanent  
Identification

E5.  
Lockout/  
Tagout  
& Safety  
Solutions

F.  
Index

A. System Overview

B1. Cable Ties

B2. Cable Accessories

B3. Stainless Steel Ties

C1. Wiring Duct

C2. Surface Raceway

C3. Abrasion Protection

C4. Cable Management

D1. Terminals

D2. Power Connectors

D3. Grounding Connectors

E1. Labeling Systems

E2. Labels

E3. Pre-Printed & Write-On Markers

E4. Permanent Identification

E5. Lockout/Tagout & Safety Solutions

F. Index

**For use with Copper Conductors**

## Installation Tooling and Die Selections for: Types LCA, LCA<sup>N</sup>, LCD, LCD<sup>N</sup> and SCS

**How to read this chart**

For LCA6 lug and CT-2001 crimping tool:

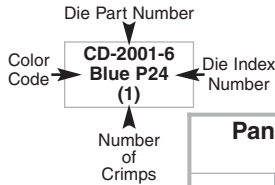

**Panduit (See Compression Connector Tools Selection Guide, Pages D3.34 – D3.36)**

**Thomas & Betts**

Panduit Part Number	Std. Wire Size	Wire Strip Length (In.)	Panduit (See Compression Connector Tools Selection Guide, Pages D3.34 – D3.36)							Thomas & Betts		
			CT-1570	CT-1701 <sup>①</sup>	CT-1700 <sup>①</sup>	CT-720	CT-920, CT-920CH, CT-930, CT-930CH, CT-930LPCH <sup>Ⓞ</sup> , CT-2920, CT-2930, CT-2930/L, CT-2930/LE, CT-2931, CT-940CH <sup>Ⓞ</sup> , CT-2940 <sup>Ⓞ</sup> , CT-2940/L <sup>Ⓞ</sup> , CT-2940/LE <sup>Ⓞ</sup>	Uni-Die™ Dieless CT-980, CT-2980, CT-2980/L, CT-2980/LE, CT-980LPCH <sup>Ⓞ</sup> , CT-980CH, CT-2950 <sup>Ⓞ</sup> , CT-2981 Extended Wire Range	CT-2001, CT-2001/L, CT-2001/LE, CT-2002, CT-2002/L, CT-3001, CT-3001/E	TBM20S, TBM25S	TBM6, TBM6S, 25000, TBM5, TBM8	TBM12, 13642M
Die Part Number/Color Code and Die Index Number/(Number of Crimps)												
LCA10 LCD10	#14 – #10 AWG STR, #12 – #10 AWG SOL	7/16	12-10 (1)	P10 (1)	—	—	—	—	—	—	—	—
LCA8 LCA <sup>N</sup> 8 LCD8 LCD <sup>N</sup> 8	#8 AWG	5/8	—	—	Red P21 (2)	CD-720-1 Red P21 (1)	CD-920-8 Red P21 (1)	—	CD-2001-8 Red P21 (1)	Red 21 (2)	Red 21 (1)	Red 21 (1)
SCS8		11/16										
LCA6 LCA <sup>N</sup> 6 LCD6 LCD <sup>N</sup> 6	#6 AWG	7/8	—	—	Blue P24 (2)	CD-720-1 Blue P24 (1)	CD-920-6 Blue P24 (1)	—	CD-2001-6 Blue P24 (1)	Blue 24 (2)	Blue 24 (1)	Blue 24 (1)
SCS6		13/16										
LCA4 LCA <sup>N</sup> 4 LCD4 LCD <sup>N</sup> 4	#4 – #3 AWG STR, #2 AWG SOL	7/8	—	—	Gray P29 (2)	CD-720-1 Gray P29 (1)	CD-920-4 Gray P29 (1)	#4 – #2 AWG #2 AWG SOL Only (1)	CD-2001-4 Gray P29 (1)	Gray 29 (2)	Gray 29 (1)	Gray 29 (1)
SCS4		13/16										
LCA2 LCA <sup>N</sup> 2 LCD2 LCD <sup>N</sup> 2	#2 AWG	15/16	—	—	Brown P33 (2)	CD-720-1 Brown P33 (1)	CD-920-2 Brown P33 (1)	#6 – #2 AWG (1)	CD-2001-2 Brown P33 (1)	Brown 33 (2)	Brown 33 (1)	Brown 33 (1)
SCS2		7/8										
LCA1 LCA <sup>N</sup> 1 LCD1 LCD <sup>N</sup> 1	#1 AWG	15/16	—	—	Green P37 (3)	CD-720-2 Green P37 (1)	CD-920-1 Green P37 (1)	#6 – #1 AWG (1)	CD-2001-1 Green P37 (1)	—	Green 37 (1)	Green 37 (1)
SCS1		7/8										
LCA1/0 LCA <sup>N</sup> 1/0 LCD1/0 LCD <sup>N</sup> 1/0	1/0 AWG	1	—	—	—	CD-720-2 Pink P42 (1)	CD-920-1/0 Pink P42 (1)	#6 – 1/0 AWG (1)	CD-2001-1/0 Pink P42 (1)	—	Pink 42 (1)	Pink 42 (1)
SCS1/0		7/8										
LCA2/0 LCA <sup>N</sup> 2/0 LCD2/0 LCD <sup>N</sup> 2/0	2/0 AWG	1-1/16	—	—	—	CD-720-2 Black P45 (2)	CD-920-2/0 Black P45 (2)	#4 – 2/0 AWG (1)	CD-2001-2/0 Black P45 (2)	—	Black 45 (2)	Black 45 (1)
SCS2/0		15/16										
LCA3/0 LCA <sup>N</sup> 3/0 LCD3/0 LCD <sup>N</sup> 3/0	3/0 AWG	1-3/16	—	—	—	CD-720-2 Orange P50 (2)	CD-920-3/0 Orange P50 (2)	#2 – 3/0 AWG (1)	CD-2001-3/0 Orange P50 (2)	—	Orange 50 (2)	Orange 50 (1)
SCS3/0		1										

①The CT-1700 and CT-1701 crimp die pockets are integrated into the tool frame.  
 ②CD-920 dies can be used with CT-940CH and CT-2940 tools with CD-940-DA adapter.

③Maximum size: 500 kcmil lugs and 250 kcmil splices.  
 ④Maximum size: 250 kcmil lugs and splices. No extended wire range.

For use with  
Copper  
Conductors

## Installation Tooling and Die Selections for: Types LCA, LCA<sup>®</sup>, LCD, LCDN and SCS (continued)

Thomas & Betts			Burndy				Anderson	Penn-Union	Greenlee	
TBM15, TBM15I, TBM15BSCR	TBM8-750M-1, TBM8-750, TBM8-750BSCR, TBM750BSCR <sup>®</sup>	TBM14M, TBM14BSCR, BPLT14BSCR, 13100A	Y2MR, Y1MR, Y1MRTC	MY29	BAT35, Y39BH, Y35BH, Y750, Y750BH, Y750-2, Y750HS, Y750BH-2, Y39, PAT750, Y35, BAT750	Y45 <sup>Ⓣ</sup> , Y46 <sup>Ⓣ</sup>	Y644M, Y644HS, PAT644, BAT644, Y644MBH	VC6	TDY-1	1989
Die Part Number/Color Code and Die Index Number/(Number of Crimps)										
—	—	—	—	—	—	—	—	—	—	—
Red 21 (1)	STD (1)	Red 21 (1)	Red 49 (1)	#8 (1)	U8CRT Red 49 (1)	U8CRT Red 49 (1)	—	—	—	—
Blue 24 (1)	STD (1)	Blue 24 (1)	Blue 7 (2)	#6 (1)	U5CRT Blue 7 (1)	U5CRT Blue 7 (1)	STD (1)	STD (1)	—	—
Gray 29 (1)	STD (1)	Gray 29 (1)	Gray 8 (2)	#4 (1)	U4CRT Gray 8 (1)	U4CRT Gray 8 (1)	STD (1)	STD (1)	—	STD (1)
Brown 33 (1)	STD (1)	Brown 33 (1)	Brown 10 (2)	#2 (1)	U2CRT Brown 9 [solid]/ Brown 10 [stranded] (1)	U2CRT Brown 9 [solid]/ Brown 10 [stranded] (1)	STD (1)	STD (1)	STD (1)	STD (1)
Green 37 (1)	STD (1)	Green 37 (1)	—	#1 (1)	U1CRT Green 11 (1)	U1CRT Green 11 (1)	STD (1)	STD (1)	STD (1)	STD (1)
Pink 42H <sup>Ⓣ</sup> (2)	STD (1)	Pink 42H <sup>Ⓣ</sup> (2)	—	1/0 (1)	U25RT Pink 12 (1)	U25RT Pink 12 (1)	STD (1)	STD (1)	STD (1)	STD (1)
Black 45 (1)	STD (1)	Black 45 (1)	—	2/0 (1)	U26RT Black 13 (1)	U26RT Black 13 (1)	STD (1)	STD (1)	STD (1)	STD (1)
Orange 50 (1)	STD (1)	Orange 50 (1)	—	3/0 (1)	U27RT Orange 14 (1)	U27RT Orange 14 (1)	STD (1)	STD (1)	STD (1)	STD (1)

<sup>Ⓣ</sup>Half width dies.

<sup>Ⓣ</sup>Requires U die adapter.

<sup>®</sup>Minimum size: #4 AWG lugs and splices.

Chart continues on pages D3.60 – D3.61

A.  
System  
Overview

B1.  
Cable Ties

B2.  
Cable  
Accessories

B3.  
Stainless  
Steel Ties

C1.  
Wiring  
Duct

C2.  
Surface  
Raceway

C3.  
Abrasion  
Protection

C4.  
Cable  
Management

D1.  
Terminals

D2.  
Power  
Connectors

D3.  
Grounding  
Connectors

E1.  
Labeling  
Systems

E2.  
Labels

E3.  
Pre-Printed  
& Write-On  
Markers

E4.  
Permanent  
Identification

E5.  
Lockout/  
Tagout/  
& Safety  
Solutions

F.  
Index

A. System Overview

B1. Cable Ties

B2. Cable Accessories

B3. Stainless Steel Ties

C1. Wiring Duct

C2. Surface Raceway

C3. Abrasion Protection

C4. Cable Management

D1. Terminals

D2. Power Connectors

D3. Grounding Connectors

E1. Labeling Systems

E2. Labels

E3. Pre-Printed & Write-On Markers

E4. Permanent Identification

E5. Lockout/Tagout & Safety Solutions

F. Index

**For use with Copper Conductors**

## Installation Tooling and Die Selections for: Types LCA, LCA<sub>N</sub>, LCD, LCD<sub>N</sub> and SCS (continued)

			Panduit (See Compression Connector Tools Selection Guide, Pages D3.34 – D3.36)				Thomas & Betts		
Panduit Part Number	Std. Wire Size	Wire Strip Length (In.)	CT-720	CT-920, CT-920CH, CT-930, CT-930CH, CT-930LPCH <sup>⑥</sup> , CT-2920, CT-2930, CT-2930/L, CT-2930/LE, CT-2931, CT-940CH <sup>③</sup> , CT-2940 <sup>③</sup> , CT-2940/L <sup>③</sup> , CT-2940/LE <sup>③</sup>	CT-980, CT-2980, CT-2980/L, CT-2980/LE, CT-980LPCH <sup>⑥</sup> , CT-980CH, CT-2950 <sup>⑤</sup> , CT-2981 Extended Wire Range	CT-2001, CT-2001/L, CT-2001/LE, CT-2002, CT-2002/L, CT-3001, CT-3001/E	TBM5	TBM6, TBM6S, 25000, TBM8	TBM12, 13642M
			Die Part Number/Color Code and Die Index Number/(Number of Crimps)						
LCA4/0	4/0 AWG	1-1/4	CD-720-3 Purple P54 (2)	CD-920-4/0 Purple P54 (2)	1 – 4/0 AWG (1)	CD-2001-4/0 Purple P54 (2)	Purple 54 (2)	Purple 54 (2)	Purple 54 (1)
LCA <sub>N</sub> 4/0									
LCD4/0									
LCD <sub>N</sub> 4/0									
SCS4/0		1							
LCA250	250 kcmil	1-5/16	CD-720-3 Yellow P62 (2)	CD-920-250 Yellow P62 (2)	1/0 AWG – 250 kcmil (2)	CD-2001-250 Yellow P62 (2)	Yellow 62 (2)	Yellow 62 (2)	Yellow 62 (1)
LCA <sub>N</sub> 250									
LCD250									
LCD <sub>N</sub> 250									
SCS250		1-1/16							
LCA300	300 kcmil	1-1/2	CD-720-4 White P66 (2)	CD-920-300 White P66 (2)	2/0 AWG – 300 kcmil (2)	CD-2001-300 White P66 (2)	—	White 66 (2)	White 66H <sup>②</sup> (1)
LCA <sub>N</sub> 300									
LCD300									
LCD <sub>N</sub> 300									
SCS300		1-1/16							
LCA350	350 kcmil	1-1/2	CD-720-5 Red P71 (2)	CD-920-350 Red P71 (2)	3/0 AWG – 350 kcmil (2)	CD-2001-350 Red P71 (2)	—	Red 71 (2)	Red 71H <sup>②</sup> (2)
LCA <sub>N</sub> 350									
LCD350									
LCD <sub>N</sub> 350									
SCS350		1-1/8							
LCA400	400 kcmil	1-9/16	CD-720-6 Blue P76 (2)	CD-920-400 Blue P76 (2)	4/0 AWG – 400 kcmil (2)	CD-2001-400 Blue P76 (3)	—	Blue 76 (2)	Blue 76H <sup>②</sup> (2)
LCA <sub>N</sub> 400									
LCD400									
LCD <sub>N</sub> 400									
SCS400		1-3/16							
LCA500	500 kcmil	1-13/16	CD-720-7 Brown P87 (2)	CD-920-500 Brown P87 (2)	4/0 AWG – 500 kcmil (2)	CD-2001-500 Brown P87 (3)	—	Brown 87 (2)	Brown 87H <sup>②</sup> (2)
LCA <sub>N</sub> 500									
LCD500									
LCD <sub>N</sub> 500									
SCS500		1-3/8							
LCA600	600 kcmil	1-13/16	—	CD-920-600 Green P94 (2)	250 – 600 kcmil (2)	—	—	—	Green 94H <sup>②</sup> (2)
LCA <sub>N</sub> 600									
LCD600									
LCD <sub>N</sub> 600									
SCS600		1-3/8							
LCA750	750 kcmil	1-15/16	—	CD920-750 CD-940-750 <sup>④</sup> Black P106 (2)	500 – 750 kcmil (2)	—	—	—	Black 106H <sup>②</sup> (2)
LCA <sub>N</sub> 750									
LCD750									
LCD <sub>N</sub> 750									
SCS750		1-5/8							
LCD1000	1000 kcmil	1-15/16	—	CD-940-1000 <sup>④</sup> White P125 (4)	—	—	—	—	—
SCS1000		1-7/8							

②Half width dies.  
 ③CD-920 dies can be used with CT-940CH and CT-2940 tools with CD-940-DA adapter.  
 ④CD-940 dies to be used exclusively with CT-940CH and CT-2940 tools.  
 ⑤Maximum size: 500 kcmil lugs and 250 kcmil splices.  
 ⑥Maximum size: 250 kcmil lugs and splices. No extended wire range.

For use with  
Copper  
Conductors

## Installation Tooling and Die Selections for: Types LCA, LCAN, LCD, LCDN and SCS (continued)

Thomas & Betts			Burndy					Anderson	Penn-Union	Greenlee
TBM15, TBM15I, TBM15BSCR	TBM8-750M-1, TBM8-750, TBM8-750BSCR, TBM750BSCR <sup>®</sup>	TBM14M, TBM14BSCR, BPLT14BSCR, 13100A	Y2MR, Y1MR, Y1MRTC	MY29	BAT35, Y35BH, Y750, Y39BH, Y750BH, Y750-2, Y750HS, Y750BH-2, Y39, PAT750, Y35, BAT750	Y45 <sup>Ⓣ</sup> , Y46 <sup>Ⓣ</sup>	Y644M, Y644HS, PAT644, BAT644, Y644MBH	VC6	TDY-1	1989
Die Part Number/Color Code and Die Index Number/(Number of Crimps)										
Purple 54H <sup>Ⓣ</sup> (2)	STD (1)	Purple 54H <sup>Ⓣ</sup> (2)	—	4/0 (1)	U28RT Purple 15 (1)	U28RT Purple 15 (1)	STD (1)	STD (1)	STD (1)	STD (1)
Yellow 62 (1)	STD (1)	Yellow 62 (1)	—	250 (1)	U29RT Yellow 16 (1)	U29RT Yellow 16 (1)	STD (1)	STD (2)	STD (1)	STD (1)
White 66 (1)	STD (1)	White 66 (1)	—	—	U30RT White 17 (2)	U30RT White 17 (2)	STD (1)	STD (2)	STD (1)	STD (1)
Red 71H <sup>Ⓣ</sup> (2)	STD (1)	Red 71H <sup>Ⓣ</sup> (2)	—	—	U31RT Red 18 (2)	U31RT Red 18 (2)	STD (1)	STD (2)	STD (1)	STD (1)
Blue 76H <sup>Ⓣ</sup> (2)	STD (1)	Blue 76 (1)	—	—	U32RT Blue 19 (2)	U32RT Blue 19 (2)	STD (1)	STD (2)	STD (1)	STD (1)
Brown 87H <sup>Ⓣ</sup> (2)	STD (1)	Brown 87H <sup>Ⓣ</sup> (2)	—	—	U34RT Brown 20 (2)	U34RT Brown 20 (2)	STD (1)	STD (2)	STD (1)	STD (1)
Green 94H <sup>Ⓣ</sup> (2)	STD (1)	Green 94H <sup>Ⓣ</sup> (2)	—	—	U36RT Green 22 (2)	U36RT Green 22 (2)	STD (1)	—	STD (1)	—
Black 106H <sup>Ⓣ</sup> (2)	STD (1)	Black 106H <sup>Ⓣ</sup> (2)	—	—	U39RT Black 24 (3)	U39RT Black 24 (3)	STD (1)	—	STD (1)	—
125H <sup>Ⓣ</sup> (2)	—	125H <sup>Ⓣ</sup> (2)	—	—	—	S44RT White 27 (4)	—	—	—	—

ⓉHalf width dies.

ⓉRequires U die adapter.

ⓉMinimum size: #4 AWG lugs and splices.

A.  
System  
Overview

B1.  
Cable Ties

B2.  
Cable  
Accessories

B3.  
Stainless  
Steel Ties

C1.  
Wiring  
Duct

C2.  
Surface  
Raceway

C3.  
Abrasion  
Protection

C4.  
Cable  
Management

D1.  
Terminals

D2.  
Power  
Connectors

D3.  
Grounding  
Connectors

E1.  
Labeling  
Systems

E2.  
Labels

E3.  
Pre-Printed  
& Write-On  
Markers

E4.  
Permanent  
Identification

E5.  
Lockout/  
Tagout  
& Safety  
Solutions

F.  
Index

A. System Overview

B1. Cable Ties

B2. Cable Accessories

B3. Stainless Steel Ties

C1. Wiring Duct

C2. Surface Raceway

C3. Abrasion Protection

C4. Cable Management

D1. Terminals

D2. Power Connectors

D3. Grounding Connectors

E1. Labeling Systems

E2. Labels

E3. Pre-Printed & Write-On Markers

E4. Permanent Identification

E5. Lockout/Tagout & Safety Solutions

F. Index

**For use with Copper Conductors**

## Installation Tooling and Die Selections for: Types LCB, LCBN, LCC, LCCN and SCL

How to read this chart

For LCB6 lug and CT-2001 crimping tool:

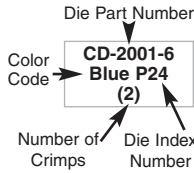

**Panduit (See Compression Connector Tools Selection Guide, Pages D3.34 – D3.36)**

**Thomas & Betts**

Panduit Part Number	Std. Wire Size	Wire Strip Length (In.)	Panduit (See Compression Connector Tools Selection Guide, Pages D3.34 – D3.36)							Thomas & Betts							
			CT-1570	CT-1701 <sup>①</sup>	CT-1700 <sup>①</sup>	CT-720	CT-920, CT-920CH, CT-930, CT-930CH, CT-2920, CT-2930, CT-2930/L, CT-2930/LE, CT-2931, CT-930LPCH <sup>②</sup> , CT-940CH <sup>②</sup> , CT-2940 <sup>②</sup> , CT-2940/L <sup>②</sup> , CT-2940/LE <sup>②</sup>	Uni-Die™ CT-980, CT-980CH, CT-2950 <sup>②</sup> , CT-2980, CT-2980/L, CT-2980/LE, CT-2981, CT-980LPCH <sup>②</sup> , Extended Wire Range	CT-2001, CT-2001/L, CT-2001/LE, CT-2002, CT-2002/L, CT-3001, CT-3001/E	TBM20S, TBM25S	TBM5	TBM6, TBM6S, 25000, TBM8	TBM12, 13642M				
L = Lug S = Splice			Die Part Number/Color Code and Die Index Number/(Number Of Crimps)														
LCB10 LCC10	#14 – #10 AWG STR, #12 – #10 AWG SOL	9/16	12-10 (2)	P10 (2)	—	—	—	—	—	—	—	—	—	—	—	—	—
LCB8 LCBN8 LCC8 LCCN8 SCL8	#8 AWG	3/4 1-1/16	—	—	Red P21 (3)	CD-720-1 Red P21 (2)	CD-920-8 Red P21 (1)	—	CD-2001-8 Red P21 (2)	Red 21 (3)	Red 21 (1)	Red 21 (1)	Red 21 (1)	—	—	—	—
LCB6 LCBN6 LCC6 LCCN6 SCL6	#6 AWG	1-1/8	—	—	Blue P24 (3)	CD-720-1 Blue P24 (2)	CD-920-6 Blue P24 (1)	—	CD-2001-6 Blue P24 (2)	Blue 24 (3)	Blue 24 (1)	Blue 24 (1)	Blue 24 (1)	—	—	—	—
LCB4 LCBN4 LCC4 LCCN4 SCL4	#4 – #3 AWG STR, #2 AWG SOL	1-1/8	—	—	Gray P29 (3)	CD-720-1 Gray P29 (2)	CD-920-4 Gray P29 (1)	#4 – #2 AWG #2 AWG SOL Only (1)	CD-2001-4 Gray P29 (2)	Gray 29 (3)	Gray 29 (1)	Gray 29 (1)	Gray 29 (1)	—	—	—	—
LCB2 LCBN2 LCC2 LCCN2 SCL2	#2 AWG	1-1/4	—	—	Brown P33 (3)	CD-720-1 Brown P33 (2)	CD-920-2 Brown P33 (1)	#6 – #2 AWG (1)	CD-2001-2 Brown P33 (2)	Brown 33 (3)	Brown 33 (1)	Brown 33 (1)	Brown 33 (1)	—	—	—	—
LCB1 LCBN1 LCC1 LCCN1 SCL1	#1 AWG	1-7/16 1-3/8	—	—	Green P37 (4)	CD-720-2 Green P37 (2)	CD-920-1 Green P37 (1)	#6 – #1 AWG (1)	CD-2001-1 Green P37 (2)	—	Green 37 (1)	Green 37 (1)	Green 37 (1)	—	—	—	—
LCB1/0 LCBN1/0 LCC1/0 LCCN1/0 SCL1/0	1/0 AWG	1-1/2 1-3/8	—	—	—	CD-720-2 Pink P42 (2)	CD-920-1/0 Pink P42 (2)	#6 – 1/0 AWG (2)	CD-2001-1/0 Pink P42 (2)	—	Pink 42 (2)	Pink 42 (2)	Pink 42 (2)	—	—	—	—
LCB2/0 LCBN2/0 LCC2/0 LCCN2/0 SCL2/0	2/0 AWG	1-9/16 1-1/2	—	—	—	CD-720-2 Black P45 (3)	CD-920-2/0 Black P45 (3)	#4 – 2/0 AWG (2)	CD-2001-2/0 Black P45 (3)	—	Black 45 (3)	Black 45 (3)	Black 45 (2)	—	—	—	—
LCB3/0 LCBN3/0 LCC3/0 LCCN3/0 SCL3/0	3/0 AWG	1-9/16 1-1/2	—	—	—	CD-720-2 Orange P50 (3)	CD-920-3/0 Orange P50 (3)	#2 – 3/0 AWG (2)	CD-2001-3/0 Orange P50 (3)	—	Orange 50 (3)	Orange 50 (3)	Orange 50 (2)	—	—	—	—
LCB4/0 LCBN4/0 LCC4/0 LCCN4/0 SCL4/0	4/0 AWG	1-5/8	—	—	—	CD-720-3 Purple P54 (3)	CD-920-4/0 Purple P54 (3)	#1 – 4/0 AWG (2)	CD-2001-4/0 Purple P54 (3)	—	Purple 54 (3)	Purple 54 (3)	Purple 54 (2)	—	—	—	—
LCB250 LCBN250 LCC250 LCCN250 SLC250	250 kcmil	1-11/16 1-5/8	—	—	—	CD-720-3 Yellow P62 (4)	CD-920-250 Yellow P62 (3)	1/0 AWG – 250 kcmil (3)	CD-2001-250 Yellow P62 (3)	—	Yellow 62 (4)	Yellow 62 (4)	Yellow 62 (2)	—	—	—	—

①The CT-1700 and CT-1701 crimp die pockets are integrated into the tool frame.  
③CD-920 dies can be used with CT-940CH and CT-2940 tools with CD-940-DA adapter.

⑤Maximum size: 500 kcmil lugs and 250 kcmil splices.  
⑥Maximum size: 250 kcmil lugs and splices. No extended wire range.



For use with  
Copper  
Conductors

## Installation Tooling and Die Selections for: Types LCB, LCBN, LCC, LCCN and SCL (continued)

Thomas & Betts			Burndy					Anderson	Penn-Union	Greenlee
TBM15, TBM15I, TBM15BSCR	TBM8-750M-1, TBM8-750, TBM750BSCR®, TBM8-750BSCR	TBM14M, TBM14BSCR, BPLT14BSCR, 13100A	Y2MR, Y1MR, Y1MRTC	MY29	Y35, Y35BH, Y39, Y39BH, Y750, Y750-2, Y750BH, Y750HS, Y750BH-2, PAT750, BAT750, BAT35	Y45Ⓣ, Y46Ⓣ	Y644M, Y644HS, Y644MBH, PAT644, BAT644	VC6	TDY-1	1989
Die Part Number/Color Code and Die Index Number/(Number of Crimps)										
—	—	—	—	—	—	—	—	—	—	—
Red 21 (1)	STD (1)	Red 21 (1)	Red 49 (2)	#8 (1)	U8CRT Red 49 (1)	U8CRT Red 49 (1)	—	—	—	—
Blue 24 (1)	STD (1)	Blue 24 (1)	Blue 7 (2)	#6 (1)	U5CRT Blue 7 (1)	U5CRT Blue 7 (1)	STD (1)	STD (1)	—	—
Gray 29 (1)	STD (1)	Gray 29 (1)	Gray 8 (2)	#4 (1)	U4CRT Gray 8 (1)	U4CRT Gray 8 (1)	STD (1)	STD (1)	—	STD (1)
Brown 33 (1)	STD (1)	Brown 33 (1)	Brown 10 (2)	#2 (1)	U2CRT Brown 9 (solid) /Brown 10 (stranded) (2)	U2CRT Brown 9 (solid) /Brown 10 (stranded) (2)	STD (1)	STD (1)	STD (1)	STD (1)
Green 37 (1)	STD (1)	Green 37 (1)	—	#1 (1)	U1CRT Green 11 (2)	U1CRT Green 11 (2)	STD (1)	STD (1)	STD (1)	STD (1)
Pink 42HⓉ (4)	STD (2)	Pink 42H Ⓣ (4)	—	1/0 (2)	U25RT Pink 12 (2)	U25RT Pink 12 (2)	STD (1)	STD (1)	STD (1)	STD (1)
Black 45 (2)	STD (2)	Black 45 (2)	—	2/0 (2)	U26RT Black 13 (2)	U26RT Black 13 (2)	STD (1)	STD (1)	STD (1)	STD (1)
Orange 50 (2)	STD (2)	Orange 50 (2)	—	3/0 (2)	U27RT Orange 14 (2)	U27RT Orange 14 (2)	STD (1)	STD (2)	STD (1)	STD (1)
Purple 54HⓉ (4)	STD (2)	Purple 54H Ⓣ (4)	—	4/0 (2)	U28RT Purple 15 (2)	U28RT Purple 15 (2)	STD (1)	STD (2)	STD (1)	STD (1)
<b>LCB250</b> <b>LCBN250</b> <b>LCC250</b> <b>LCCN250</b>	250 kcmil	1-11/16	—	—	—	CD-720-3 Yellow P62 (4)	CD-920-250 Yellow P62 (3)	1/0 AWG – 250 kcmil (3)	CD-2001- 250 Yellow P62 (3)	—

ⓉHalf width dies.

ⓉRequires U die adapter.

ⓉMinimum size: #4 AWG lugs and splices.

Chart continues on pages D3.64 – D3.65

For technical assistance in the U.S., call 866-405-6654 (outside the U.S., see inside back cover for directory)

A.  
System  
Overview

B1.  
Cable Ties

B2.  
Cable  
Accessories

B3.  
Stainless  
Steel Ties

C1.  
Wiring  
Duct

C2.  
Surface  
Raceway

C3.  
Abrasion  
Protection

C4.  
Cable  
Management

D1.  
Terminals

D2.  
Power  
Connectors

D3.  
Grounding  
Connectors

E1.  
Labeling  
Systems

E2.  
Labels

E3.  
Pre-Printed  
& Write-On  
Markers

E4.  
Permanent  
Identification

E5.  
Lockout/  
Tagout  
& Safety  
Solutions

F.  
Index

A. System Overview

B1. Cable Ties

B2. Cable Accessories

B3. Stainless Steel Ties

C1. Wiring Duct

C2. Surface Raceway

C3. Abrasion Protection

C4. Cable Management

D1. Terminals

D2. Power Connectors

D3. Grounding Connectors

E1. Labeling Systems

E2. Labels

E3. Pre-Printed & Write-On Markers

E4. Permanent Identification

E5. Lockout/Tagout & Safety Solutions

F. Index

**For use with Copper Conductors**

## Installation Tooling and Die Selections for: Types LCB, LCBN, LCC, LCCN and SCL (continued)

Panduit Part Number L=Lug S=Splice	Std. Wire Size	Wire Strip Length (In.)	Panduit (See Compression Connector Tools Selection Guide, Pages D3.34 – D3.36)				Thomas & Betts	
			CT-720	CT-920, CT-920CH, CT-930, CT-930CH, CT-2920, CT-2930, CT-2930/L, CT-2930/LE, CT-2931, CT-930LPCH <sup>⑥</sup> , CT-940CH <sup>③</sup> , CT-2940 <sup>③</sup> , CT-2940/L <sup>③</sup> , CT-2940/LE <sup>③</sup>	Uni-Die™ CT-980, CT-980CH, CT-2950 <sup>⑤</sup> , CT-2980, CT-2980/L, CT-2980/LE, CT2981, CT-980LPCH <sup>⑥</sup> Extended Wire Range <sup>⑨</sup>	CT-2001, CT-2001/L, CT-2001/LE, CT-2002, CT-2002/L, CT-3001, CT-3001/E	TBM6, TBM6S, 25000, TBM8	TBM12, 13642M
Die Part Number/Color Code and Die Index Number/(Number Of Crimps)								
LCB300 LCBN300 LCC300 LCCN300 SCL300	300 kcmil	2-5/16 2	CD-720-4 White P66 (4)	CD-920-300 White P66 (3)	2/0 AWG – 300 kcmil (3)	CD-2001-300 White P66 (3)	White 66 (4)	White 66 <sup>②</sup> (4)
LCB350 LCBN350 LCC350 LCCN350 SCL350	350 kcmil	2-5/16 2	CD-720-5 Red P71 (4)	CD-920-350 Red P71 (3)	3/0 AWG – 350 kcmil (3)	CD-2001-350 Red P71 (3)	Red 71 (4)	Red 71H <sup>②</sup> (4)
LCB400 LCBN400 LCC400 LCCN400 SCL400	400 kcmil	2-3/8 2-1/8	CD-720-6 Blue P76 (4)	CD-920-400 Blue P76 (3)	4/0 AWG – 400 kcmil (3)	CD-2001-400 Blue P76 (4)	Blue 76 (4)	Blue 76H <sup>②</sup> (4)
LCB500 LCBN500 LCC500 LCCN500 SCL500	500 kcmil	2-9/16 2-1/4	CD-720-7 Brown P87 (4)	CD-920-500 Brown P87 (3)	4/0 AWG – 500 kcmil (3)	CD-2001-500 Brown P87 (4)	Brown 87 (4)	Brown 87H <sup>②</sup> (4)
LCB600 LCBN600 LCC600 LCCN600 SCL600	600 kcmil	2-3/4 2-11/16	—	CD-920-600 Green P94 (4)	250 – 600 kcmil (3)	—	—	Green 94H <sup>②</sup> (4)
LCB750 LCBN750 LCC750 LCCN750 SCL750	750 kcmil	2-15/16 2-7/8	—	CD-920-750 CD-940-750 <sup>④</sup> Black P106 (4)	500 – 750 kcmil (3)	—	—	Black 106H <sup>②</sup> (4)
LCB800 LCBN800 LCC800 LCCN800	800 kcmil	3	—	CD-940-800 <sup>④</sup> Orange P107 (4)	—	—	—	—
LCB1000 LCBN1000 LCC1000 LCCN1000 SCL1000	1000 kcmil	3-1/16 3	—	CD-940-1000 <sup>④</sup> White P125 (4)	—	—	—	Yellow 125H <sup>②</sup> (4)

②Half width dies.  
 ③CD-920 dies can be used with CT-940CH and CT-2940 tools with CD-940-DA adapter.  
 ④CD-940 dies to be used exclusively with CT-940CH and CT-2940 tools.  
 ⑤Maximum size: 500 kcmil lugs and 250 kcmil splices.  
 ⑥Maximum size: 250 kcmil lugs and splices. No extended wire range.  
 ⑨Maximum size: 500 kcmil lugs and splices.

For use with  
Copper  
Conductors

## Installation Tooling and Die Selections for: Types LCB, LCBN, LCC, LCCN and SCL (continued)

Thomas & Betts			Burdny			Anderson	Penn-Union	Greenlee
TBM15, TBM15I, TBM15BSCR	TBM8-750M-1, TBM8-750, TBM750BSCR®, TBM8-750BSCR	TBM14M, TBM14BSCR, BPLT14BSCR, 13100A	Y35, Y35BH, Y39, Y39BH, Y750, Y750-2, Y750BH, Y750HS, Y750BH-2, PAT750, BAT750, BAT35	Y45 <sup>②</sup> , Y46 <sup>②</sup>	Y644M, Y644HS, Y644MBH, PAT644, BAT644	VC6	TDY-1	1989
Die Part Number/Color Code and Die Index Number/(Number Of Crimps)								
White 66 (3)	STD (3)	White 66 (3)	U30RT White 17 (3)	U30RT White 17 (3)	STD (1)	STD (3)	STD (2)	STD (1)
Red 71 <sup>②</sup> (4)	STD (3)	Red 71 (4)	U31RT Red 18 (3)	U31RT Red 18 (3)	STD (1)	STD (3)	STD (2)	STD (1)
Blue <sup>②</sup> (4)	STD (3)	Blue 76 (4)	U32RT Blue 19 (3)	U32RT Blue 19 (3)	STD (1)	STD (3)	STD (2)	STD (1)
Brown 87 <sup>②</sup> (4)	STD (3)	Brown 87 (4)	U34RT Brown 20 (3)	U34RT Brown 20 (3)	STD (1)	STD (3)	STD (2)	STD (1)
Green 94 <sup>②</sup> (4)	STD (4)	Green 94 (4)	U36RT Green 22 (4)	U36RT Green 22 (4)	STD (1)	—	STD (4)	—
Black 106 <sup>②</sup> (4)	STD (4)	Black 106 (4)	U39RT Black 24 (5)	U39RT Black 24 (5)	STD (1)	—	STD (2)	—
—	—	—	—	—	—	—	—	—
125 <sup>②</sup> (4)	—	125 <sup>②</sup> (4)	—	S44RT White 27 (6)	—	—	—	—

②Half width dies.

⑦Requires U die adapter.

⑧Minimum size: #4 AWG lugs and splices.

A.  
System  
Overview

B1.  
Cable Ties

B2.  
Cable  
Accessories

B3.  
Stainless  
Steel Ties

C1.  
Wiring  
Duct

C2.  
Surface  
Raceway

C3.  
Abrasion  
Protection

C4.  
Cable  
Management

D1.  
Terminals

D2.  
Power  
Connectors

D3.  
Grounding  
Connectors

E1.  
Labeling  
Systems

E2.  
Labels

E3.  
Pre-Printed  
& Write-On  
Markers

E4.  
Permanent  
Identification

E5.  
Lockout/  
Tagout  
& Safety  
Solutions

F.  
Index

A. System Overview

B1. Cable Ties

B2. Cable Accessories

B3. Stainless Steel Ties

C1. Wiring Duct

C2. Surface Raceway

C3. Abrasion Protection

C4. Cable Management

D1. Terminals

D2. Power Connectors

D3. Grounding Connectors

E1. Labeling Systems

E2. Labels

E3. Pre-Printed & Write-On Markers

E4. Permanent Identification

E5. Lockout/Tagout & Safety Solutions

F. Index

**For use with Copper Conductors**

## Installation Tooling and Die Selections for: Types LCBH, LCCH, and SCH

How to read this chart

For LCBH6 lug and CT-2001 crimping tool:

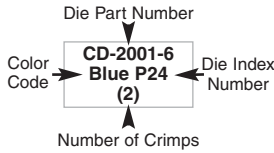

**Panduit (See Compression Connector Tools Selection Guide, Pages D3.34 – D3.36)**

**Thomas & Betts**

Panduit Part Number	Std. Wire Size	Wire Strip Length (In.)	Panduit (See Compression Connector Tools Selection Guide, Pages D3.34 – D3.36)				Thomas & Betts				
			CT-1700 <sup>①</sup>	CT-720	CT-920, CT-920CH, CT-2920, CT-930, CT-930CH, CT-2930, CT-2930/L, CT-2930/LE, CT-2931, CT-930LPCH <sup>②</sup> , CT-940CH <sup>②</sup> , CT-2940 <sup>③</sup> , CT-2940/L <sup>③</sup> , CT-2940/LE <sup>③</sup>	Uni-Die™ CT-980, CT-980CH, CT-2950 <sup>⑤</sup> , CT-2980 <sup>⑤</sup> , CT-2980/L <sup>⑤</sup> , CT-2980/LE <sup>⑤</sup> , CT-2981 <sup>⑤</sup> , CT-980LPCH <sup>⑤</sup> Wire Range	CT-2001, CT-2001/L, CT-2001/LE, CT-2002, CT-2002/L, CT-3001, CT-3001/E	TBM5	TBM6, TBM6S, 25000, TBM8	TBM12 13642M	
L = Lug S = Splice			Die Part Number/Color Code and Die Index Number/(Number Of Crimps)								
LCBH6 LCCH6	#6 AWG	1-1/8	Blue P24 (3)	CD-720-1 Blue P24 (2)	CD-920-6 Blue P24 (1)	—	CD-2001-6 Blue P24 (2)	Blue 24 (1)	Blue 24 (1)	Blue 24 (1)	
SCH6		15/16									
LCBH4 LCCH4	#4 AWG	1-1/8	Gray P29 (3)	CD-720-1 Gray P29 (2)	CD-920-4 Gray P29 (1)	#2 AWG SOL, #3 AWG STR (1)	CD-2001-4 Gray P29 (2)	Gray 29 (1)	Gray 29 (1)	Gray 29 (1)	
SCH4		15/16									
LCBH2 LCCH2	#2 AWG	1-1/4	Brown P33 (3)	CD-720-1 Brown P33 (2)	CD-920-2 Brown P33 (1)	#6 – #4 AWG (1)	CD-2001-2 Brown P33 (2)	Brown 33 (1)	Brown 33 (1)	Brown 33 (1)	
SCH2		1									
LCBH1 LCCH1	#1 AWG	1-7/16	Green P37 (3)	CD-720-2 Green P37 (2)	CD-920-1 Green P37 (1)	#6 – #2 AWG (1)	CD-2001-1 Green P37 (2)	Green 37 (1)	Green 37 (1)	Green 37 (1)	
SCH1		1									
LCBH1/0 LCCH1/0	1/0 AWG	1-1/2	—	CD-720-2 Pink P42 (2)	CD-920-1/0 Pink P42 (2)	#6 – #1 AWG (2)	CD-2001-1/0 Pink P42 (2)	Pink 42 (2)	Pink 42 (2)	Pink 42 (2)	
SCH1/0		1									
LCBH2/0 LCCH2/0	2/0 AWG	1-9/16	—	CD-720-2 Black P45 (3)	CD-920-2/0 Black P45 (3)	#4 – 1/0 AWG (2)	CD-2001-2/0 Black P45 (3)	Black 45 (3)	Black 45 (3)	Black 45 (2)	
SCH2/0		1-1/16									
LCBH3/0 LCCH3/0	3/0 AWG	1-9/16	—	CD-720-2 Orange P50 (3)	CD-920-3/0 Orange P50 (3)	#2 – 2/0 AWG (2)	CD-2001-3/0 Orange P50 (3)	Orange 50 (3)	Orange 50 (3)	Orange 50 (2)	
SCH3/0		1-3/16									
LCBH4/0 LCCH4/0	4/0 AWG	1-5/8	—	CD-720-3 Purple P54 (3)	CD-920-4/0 Purple P54 (3)	#1 – 3/0 AWG (2)	CD-2001-4/0 Purple P54 (3)	Purple 54 (3)	Purple 54 (3)	Purple 54 (3)	
SCH4/0		1-3/16									
LCBH250 LCCH250	250 kcmil	1-11/16	—	CD-720-3 Yellow P62 (4)	CD-920-250 Yellow P62 (3)	1/0 – 4/0 AWG (3)	CD-2001-250 Yellow P62 (3)	Yellow 62 (4)	Yellow 62 (4)	Yellow 62 (2)	
SCH250		1-1/4									
LCBH300 LCCH300	300 kcmil	2-5/16	—	CD-720-4 White P66 (4)	CD-920-300 White P66 (3)	2/0 AWG – 250 kcmil (3)	CD-2001-300 White P66 (3)	—	White 66 (4)	White 66H <sup>②</sup> (4)	
SCH300		2									
LCBH350 LCCH350	350 kcmil	2-5/16	—	CD-720-5 Red P71 (4)	CD-920-350 Red P71 (3)	3/0 AWG – 300 kcmil (3)	CD-2001-350 Red P71 (3)	—	Red 71 (4)	Red 71H <sup>②</sup> (4)	
SCH350		2									
LCBH400 LCCH400	400 kcmil	2-3/8	—	CD-720-6 Blue P76 (4)	CD-920-400 Blue P76 (3)	4/0 AWG – 350 kcmil (3)	CD-2001-400 Blue P76 (4)	—	Blue 76 (4)	Blue 76H <sup>②</sup> (4)	
SCH400		2-1/8									
LCBH500 LCCH500	500 kcmil	2-9/16	—	CD-720-7 Brown P87 (4)	CD-920-500 Brown P87 (3)	4/0 AWG – 400 kcmil (3)	CD-2001-500 Brown P87 (4)	—	Brown 87 (4)	Brown 87H <sup>②</sup> (4)	
SCH500		2-1/4									
LCBH600 LCCH600	600 kcmil	2-3/4	—	—	CD-920-600 Green P94 (4)	250 – 500 kcmil (3)	—	—	—	Green 94H <sup>②</sup> (4)	
SCH600		2-11/16									
LCBH750 LCCH750	750 kcmil	2-15/16	—	—	CD-920-750, CD-940-750 <sup>④</sup> Black P106 (4)	500 – 600 kcmil (3)	—	—	—	Black 106H <sup>②</sup> (4)	
SCH750		2-7/8									
LCBH1000 LCCH1000	1000 kcmil	3-1/16	—	—	CD-940-1000 <sup>④</sup> Green P125 (4)	—	—	—	—	125H <sup>②</sup> (4)	
SCH1000		3									

①The CT-1700 crimp die pockets are integrated into the tool frame.

②Half width dies.

③CD-920 dies can be used with CT-940CH and CT-2940 tools with CD-940-DA adapter.

④CD-940 dies to be used exclusively with CT-940CH and CT-2940 tools.

⑤Maximum size: 500 kcmil lugs and 250 kcmil splices.

⑥Maximum size: 250 kcmil lugs and splices. No extended wire range.

⑦Maximum size: 500 kcmil lugs and splices.

For use with  
Copper  
Conductors

## Installation Tooling and Die Selections for: Types LCBH, LCCH, and SCH (continued)

Thomas & Betts			Burdndy				Anderson	Penn-Union	Greenlee
TBM15, TBM15I, TBM15BSCR	TBM8-750M-1, TBM8-750, TBM8-750BSCR, TBM750BSCR®	TBM14M, TBM14BSCR, BPLT14BSCR, 13100A	MY29	Y39, Y35, Y35BH, BAT35, Y750, Y750BH-2, Y750HS, Y750-2, BAT750, PAT750, Y39BH, Y750BH	Y45 <sup>Ⓣ</sup> , Y46 <sup>Ⓣ</sup>	Y644, Y644HS, PAT644, BAT644, Y644MBH	VC6	TDY-1	1989
Die Part Number/Color Code and Die Index Number/(Number of Crimps)									
Blue 24 (1)	STD (1)	Blue 24 (1)	6 (1)	U5CRT Blue 7 (1)	U5CRT Blue 7 (1)	STD (1)	STD (1)	—	—
Gray 29 (1)	STD (1)	Gray 29 (1)	4 (1)	U4CRT Gray 8 (1)	U4CRT Gray 8 (1)	STD (1)	STD (1)	—	STD (1)
Brown 33 (1)	STD (1)	Brown 33 (1)	2 (1)	U2CRT Brown 10 (2)	U2CRT Brown 10 (2)	STD (1)	STD (1)	STD (1)	STD (1)
Green 37 (1)	STD (1)	Green 37 (1)	1 (1)	U1CRT Green 11 (2)	U1CRT Green 11 (2)	STD (1)	STD (1)	STD (1)	STD (1)
Pink 42H <sup>Ⓣ</sup> (4)	STD (2)	Pink 42H <sup>Ⓣ</sup> (4)	1/0 (2)	U25RT Pink 12 (2)	U25RT Pink 12 (2)	STD (1)	STD (1)	STD (1)	STD (1)
Black 45 (2)	STD (2)	Black 45 (2)	2/0 (2)	U26RT Black 13 (2)	U26RT Black 13 (2)	STD (1)	STD (1)	STD (1)	STD (1)
Orange 50 (2)	STD (2)	Orange 50 (2)	3/0 (2)	U27RT Orange 14 (2)	U27RT Orange 14 (2)	STD (1)	STD (2)	STD (1)	STD (1)
Purple 54H <sup>Ⓣ</sup> (4)	STD (2)	Purple 54H <sup>Ⓣ</sup> (4)	4/0 (2)	U28RT Purple 15 (2)	U28RT Purple 15 (2)	STD (1)	STD (2)	STD (1)	STD (1)
Yellow 62 (2)	STD (2)	Yellow 62 (2)	250 (2)	U29RT Yellow 16 (2)	U29RT Yellow 16 (2)	STD (1)	STD (2)	STD (2)	STD (1)
White 66H <sup>Ⓣ</sup> (4)	STD (3)	White 66 (4)	—	U30RT White 17 (3)	U30RT White 17 (3)	STD (1)	STD (3)	STD (2)	STD (1)
Red 71H <sup>Ⓣ</sup> (4)	STD (3)	Red 71H <sup>Ⓣ</sup> (4)	—	U31RT Red 18 (3)	U31RT Red 18 (3)	STD (1)	STD (3)	STD (2)	STD (1)
Blue 76H <sup>Ⓣ</sup> (4)	STD (3)	Blue 76 (4)	—	U32RT Blue 19 (3)	U32RT Blue 19 (3)	STD (1)	STD (3)	STD (2)	STD (1)
Brown 87H <sup>Ⓣ</sup> (4)	STD (3)	Brown 87H <sup>Ⓣ</sup> (4)	—	U34RT Brown 20 (3)	U34RT Brown 20 (3)	STD (1)	STD (3)	STD (2)	STD (1)
Green 94H <sup>Ⓣ</sup> (4)	STD (4)	Green 94H <sup>Ⓣ</sup> (4)	—	U36RT Green 22 (4)	U36RT Green 22 (4)	STD (1)	—	STD (2)	—
Black 106H <sup>Ⓣ</sup> (4)	STD (4)	Black 106H <sup>Ⓣ</sup> (4)	—	U39RT Black 24 (5)	U39RT Black 24 (5)	STD (1)	—	STD (2)	—
125H <sup>Ⓣ</sup> (4)	—	125H <sup>Ⓣ</sup> (4)	—	—	S44RT White 27 (6)	—	—	—	—

ⓉHalf width dies.

ⓉRequires U die adapter.

ⓉMinimum size: #4 AWG lugs and splices.

A.  
System  
Overview

B1.  
Cable Ties

B2.  
Cable  
Accessories

B3.  
Stainless  
Steel Ties

C1.  
Wiring  
Duct

C2.  
Surface  
Raceway

C3.  
Abrasion  
Protection

C4.  
Cable  
Management

D1.  
Terminals

D2.  
Power  
Connectors

D3.  
Grounding  
Connectors

E1.  
Labeling  
Systems

E2.  
Labels

E3.  
Pre-Printed  
& Write-On  
Markers

E4.  
Permanent  
Identification

E5.  
Lockout/  
Tagout  
& Safety  
Solutions

F.  
Index

A. System Overview

B1. Cable Ties

B2. Cable Accessories

B3. Stainless Steel Ties

C1. Wiring Duct

C2. Surface Raceway

C3. Abrasion Protection

C4. Cable Management

D1. Terminals

D2. Power Connectors

D3. Grounding Connectors

E1. Labeling Systems

E2. Labels

E3. Pre-Printed & Write-On Markers

E4. Permanent Identification

E5. Lockout/Tagout & Safety Solutions

F. Index

**For use with Copper Conductors**

## Installation Tooling and Die Selections for: Type SCT

**How to read this chart**

For SCT2-2 splice and CT-2001 crimping tool:



Panduit (See Compression Connector Tools Selection Guide, Pages D3.34 – D3.36)			Thomas & Betts						
Panduit Part Number	Std. Wire Size	Wire Strip Length (In.)	CT-1700 <sup>①</sup>	CT-720	CT-920, CT-920CH, CT-2920, CT-930, CT-930CH, CT-2930, CT-2930/L, CT-2930/LE, CT-2931, CT-940CH <sup>③</sup> , CT-2940 <sup>③</sup> , CT-2940/L <sup>③</sup> , CT-2940/LE <sup>③</sup>	CT-980, CT-980CH, CT-2950 <sup>④</sup> , CT-2980, CT-2980/L, CT-2980/LE, CT-2981	CT-2001, CT-2001/L, CT-2001/LE, CT-2002, CT-2002/L, CT-3001, CT-3001/E	TBM5	TBM8
	Main Tap	Main Tap	Die Part Number/Color Code and Die Index Number/(Number of Crimps)						
SCT2-2	#2 AWG	2	Brown P33 (3)	CD-720-1 Brown P33 (2)	CD-920-2 Brown P33 (1)	STD (1)	CD-2001-2 Brown P33 (2)	Brown 33 (1)	Brown 33 (1)
	#2 AWG	1-9/16							
SCT1/0-1/0	1/0 AWG	2-1/16	Pink P42 (3)	CD-720-2 Pink P42 (2)	CD-920-1/0 Pink P42 (2)	STD (1)	CD-2001-1/0 Pink P42 (2)	Pink 42 (2)	Pink 43 (2)
	1/0 AWG	1-9/16							
SCT2/0-2/0	2/0 AWG	2-1/16	—	CD-720-2 Black P45 (3)	CD-920-2/0 Black P45 (3)	STD (1)	CD-2001-2/0 Black P45 (3)	Black 45 (3)	Black 45 (3)
	2/0 AWG	1-9/16							
SCT4/0-1/0	4/0 AWG	2-1/16	—	CD-720-2 Pink P42 (3)	CD-920-1/0 Pink P42 (3)	STD (1)	CD-2001-1/0 Pink P42 (3)	Pink 42 (3)	Pink 42 (3)
	1/0 AWG	1-9/16							
SCT4/0-4/0	4/0 AWG	2-1/8	—	CD-720-3 Purple P54 (3)	CD-920-4/0 Purple P54 (3)	STD (1)	CD-2001-4/0 Purple P54 (3)	Purple 54 (3)	Purple 54 (3)
	4/0 AWG	1-11/16							
SCT250-250	250 kcmil	2-3/16	—	CD-720-3 Yellow P62 (4)	CD-920-250 Yellow P62 (3)	STD (1)	CD-2001-250 Yellow P62 (3)	Yellow 62 (4)	Yellow 62 (4)
	250 kcmil	1-11/16							
SCT300-300	300 kcmil	2-13/16	—	CD-720-4 White P65 (4)	CD-920-300 White P65 (3)	STD (1)	CD-2001-300 White P66 (3)	—	White 66 (4)
	300 kcmil	2-1/16							
SCT350-350	350 kcmil	2-13/16	—	CD-720-5 Red P71 (4)	CD-920-350 Red P71 (3)	STD (1)	CD-2001-350 Red P71 (3)	—	Red 71 (4)
	350 kcmil	2-1/16							
SCT500-4/0	500 kcmil	2-15/16	—	CD-720-7 Brown P87 (4)	CD-920-500 Brown P87 (3)	STD (1)	CD-2001-500 Brown P87 (4)	—	Brown 87 (4)
	4/0 AWG	2-15/16		CD-720-3 Purple P54 (4)	CD-920-4/0 Purple P54 (4)		CD-2001-4/0 Purple P54 (4)		
SCT500-500	500 kcmil	3-1/8	—	CD-720-7 Brown P87 (4)	CD-920-500 Brown P87 (3)	STD (1)	CD-2001-500 Brown P87 (4)	—	Brown 87 (4)
	500 kcmil	2-9/16							

① The CT-1700 crimp die pockets are integrated into the tool frame.  
 ③ CD-920 dies can be used with CT-940CH and CT-2940 tools with CD-940-DA adapter.  
 ④ Maximum size: 250 kcmil.

**For use with  
Copper  
Conductors**

## Installation Tooling and Die Selections for: Type SCT (continued)

Thomas & Betts				Burndy			Anderson	Penn-Union	Greenlee
TBM12 13642M	TBM15, TBM15I, TBM15BSCR	TBM8-750M-1, TBM8-750, TBM8-750BSCR	TBM14M, TBM14BSCR, BPLT14BSCR, 13100A	MY29	Y39, Y35, Y35BH, Y750HS, Y750, BAT35, Y45, Y39BH, Y46, Y750-2, BAT750, PAT750, Y750BH-2, Y750BH	Y644, Y644HS, PAT644, BAT644, Y644MBH	VC6	TDY-1	1989
Die Part Number/Color Code and Die Index Number/(Number of Crimps)									
Brown 33 (1)	Brown 33 (1)	STD (1)	Brown 33 (1)	2 (1)	U2CRT Brown 10 (2)	STD (1)	STD (1)	STD (1)	STD (1)
Pink 42H <sup>Ⓜ</sup> (2)	Pink 42H <sup>Ⓜ</sup> (4)	STD (2)	Pink 42H <sup>Ⓜ</sup> (4)	1/0 (2)	U25RT Pink 12 (2)	STD (1)	STD (1)	STD (1)	STD (1)
Black 45 (2)	Black 45 (2)	STD (2)	Black 45 (2)	2/0 (2)	U26RT Black 13 (2)	STD (1)	STD (1)	STD (1)	STD (1)
Pink 42 (2)	Pink 42H <sup>Ⓜ</sup> (4)	STD (2)	Pink 42H <sup>Ⓜ</sup> (4)	1/0 (2)	U25RT Pink 12 (2)	STD (1)	STD (2)	STD (1)	STD (1)
Purple 54 (2)	Purple 54H (4)	STD (2)	Purple 54H <sup>Ⓜ</sup> (4)	4/0 (2)	U28RT Purple 15 (2)	STD (1)	STD (2)	STD (1)	STD (1)
Yellow 62 (2)	Yellow 62 (2)	STD (2)	Yellow 62 (2)	250 (2)	U29RT Yellow 16 (2)	STD (1)	STD (2)	STD (1)	STD (1)
White 66H <sup>Ⓜ</sup> (4)	White 66H <sup>Ⓜ</sup> (4)	STD (3)	White 66H <sup>Ⓜ</sup> (4)	—	U30RT White 17 (3)	STD (1)	STD (3)	STD (2)	STD (1)
Red 71H <sup>Ⓜ</sup> (4)	Red 71H <sup>Ⓜ</sup> (4)	STD (3)	Red 71 (3)	—	U31RT Red 18 (3)	STD (1)	STD (3)	STD (2)	STD (1)
Brown 87H <sup>Ⓜ</sup> (4)	Brown 87H <sup>Ⓜ</sup> (4)	STD (3)	Brown 87 (3)	—	U34RT Brown 20 (3)	STD (1)	STD (3)	STD (2)	STD (1)
Olive 54 (4)	Olive 54H <sup>Ⓜ</sup> (4)		Olive 54H <sup>Ⓜ</sup> (3)	—	U28RT Purple 15 (3)				
Brown 87H <sup>Ⓜ</sup> (4)	Brown 87H <sup>Ⓜ</sup> (4)	STD (3)	Brown 87H <sup>Ⓜ</sup> (4)	—	U34RT Brown 20 (3)	STD (1)	STD (3)	STD (2)	STD (1)

ⓂHalf width dies.

A.  
System  
Overview

B1.  
Cable Ties

B2.  
Cable  
Accessories

B3.  
Stainless  
Steel Ties

C1.  
Wiring  
Duct

C2.  
Surface  
Raceway

C3.  
Abrasion  
Protection

C4.  
Cable  
Management

D1.  
Terminals

D2.  
Power  
Connectors

D3.  
Grounding  
Connectors

E1.  
Labeling  
Systems

E2.  
Labels

E3.  
Pre-Printed  
& Write-On  
Markers

E4.  
Permanent  
Identification

E5.  
Lockout/  
Tagout  
& Safety  
Solutions

F.  
Index

A. System Overview

B1. Cable Ties

B2. Cable Accessories

B3. Stainless Steel Ties

C1. Wiring Duct

C2. Surface Raceway

C3. Abrasion Protection

C4. Cable Management

D1. Terminals

D2. Power Connectors

D3. Grounding Connectors

E1. Labeling Systems

E2. Labels

E3. Pre-Printed & Write-On Markers

E4. Permanent Identification

E5. Lockout/Tagout & Safety Solutions

F. Index

**For use with Copper Conductors**

## Installation Tooling and Die Selections for: Types LCAX, LCAXN, LCBX, LCDX, LCDXN and LCCX

### How to read this chart

For LCAX6 Lug and CT-2001 crimping tool:

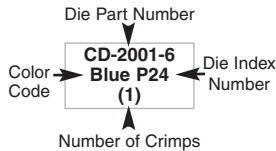

### Panduit (See Compression Connector Tools Selection Guide, Pages D3.34 – D3.36)

Panduit Part Number	Std. Wire Size	Cable Classes	Wire Strip Length (In.)	Die Part Number/Color Code and Die Index Number (Number Of Crimps)		
				CT-1700 <sup>①</sup>	CT-2001, CT-2001/L, CT-2001/LE, CT-2002, CT-2002/L, CT-3001, CT-3001/E	CT-920, CT-920CH, CT-2920, CT-930, CT-930CH, CT-2930, CT-2930/L, CT-2930/LE, CT-2931, CT-2940 <sup>③</sup> , CT-2940/L <sup>③</sup> , CT-2940/LE <sup>③</sup> , CT-940CH <sup>③</sup>
LCAX8, LCDX8, LCDXN8, LCEX8, LCJX8	#8 AWG	Compact, B, G, H, I, K, M, Locomotive (DLO)	1/2	Red P21 (2)	CD-2001-8 Red P21 (1)	CD-920-8 Red P21 (1)
LCBX8, LCCX8			3/4	Red P21 (3)	CD-2001-8 Red P21 (2)	
LCAX6, LCDX6, LCDXN6, LCEX6, LCJX6	#6 AWG	Compact, B, G, H, I, K, M, Locomotive (DLO)	9/16	Blue P24 (2)	CD-2001-6 Blue P24 (1)	CD-920-6 Blue P24 (1)
LCBX6, LCCX6			1-1/8	Blue P24 (3)	CD-2001-6 Blue P24 (2)	
LCAX4, LCDX4, LCDXN4, LCEX4, LCJX4	#4 AWG	Compact, B, G, H, I, K, M	5/8	Gray P29 (2)	CD-2001-4 Gray P29 (1)	CD-920-4 Gray P29 (1)
	#5, #4, #3	Locomotive (DLO)				
LCBX4, LCCX4	#4 AWG	Compact, B, G, H, I, K, M	1-1/8	Gray P29 (3)	CD-2001-4 Gray P29 (2)	
	#5, #4, #3	Locomotive (DLO)				
LCAX2, LCDX2, LCDXN2, LCEX2, LCJX2	#2 AWG	Compact, B, G, H, I, K, M, Locomotive (DLO)	11/16	Brown P33 (2)	CD-2001-2 Brown P33 (1)	CD-920-2 Brown P33 (1)
LCBX2, LCCX2			1-7/16	Brown P33 (3)	CD-2001-2 Brown P33 (2)	
LCAX1, LCDX1, LCDXN1, LCEX1, LCJX1	#1 AWG	Compact, B, G, H, I, K, M, Locomotive (DLO)	3/4	—	CD-2001-1 Green P37 (1)	CD-920-1 Green P37 (1)
LCBX1, LCCX1			1-1/2	—	CD-2001-1 Green P37 (2)	CD-920-1 Green P37 (2)
LCAX1/0, LCDX1/0, LCDXN1/0, LCEX1/0, LCJX1/0	1/0 AWG	Compact, B, G, H, I, K, M, Locomotive (DLO)	3/4	—	CD-2001-1/0 Pink P42 (2)	CD-920-1/0 Pink P42 (1)
LCBX1/0, LCCX1/0			1-9/16	—	CD-2001-1/0 Pink P42 (3)	CD-920-1/0 Pink P42 (3)
LCAX2/0, LCDX2/0, LCDXN2/0, LCEX2/0, LCJX2/0	2/0 AWG	Compact, B, G, H, I, K, M, Locomotive (DLO)	7/8	—	CD-2001-2/0 Black P45 (2)	CD-920-2/0 Black P45 (1)
LCBX2/0, LCCX2/0			1-9/16	—	CD-2001-2/0 Black P45 (3)	CD-920-2/0 Black P45 (3)
LCAX3/0, LCDX3/0, LCDXN3/0, LCEX3/0, LCJX3/0	3/0 AWG	Compact, B, G, H, I, K, M, Locomotive (DLO)	1	—	CD-2001-3/0 Orange P50 (2)	CD-920-3/0 Orange P50 (1)
LCBX3/0, LCCX3/0			1-5/8	—	CD-2001-3/0 Orange P50 (3)	CD-920-3/0 Orange P50 (3)

①The CT-1700 crimp die pockets are integrated into the tool frame.  
 ②CD-920 dies can be used with CT-940CH and CT-2940 tools with CD-940-DA adapter.  
 ③Does not include class K flex conductor with Burndy tools.  
 ④Does not include class M flex conductor with Thomas and Betts tools.  
 ⑤Does not include class K and M flex conductor with Thomas and Betts tools.  
 ⑥Does not include class K flex conductor with Thomas and Betts tools.



For use with  
Copper  
Conductors

## Installation Tooling and Die Selections for: Types LCAX, LCAXN, LCBX, LCDX, LCDXN and LCCX (continued)

Thomas & Betts						Burdny			
TBM12	TBM8	TBM6, 25000	TBM6BSCR, TBM6H	TBM8-750, TBM8-750M-1	TBM14BSCR, TBM14M, TBM15	BCT500HS, Y500CT-HS	Y644M	Y35, Y39, Y750, Y46 <sup>®</sup> , Y750-2, Y750BH, BAT35-14V, BAT750-14V, Pat750-18V	MRC840
Die Part Number/Color Code and Die Index Number/(Number of Crimps)									
TBM12D-1 Red 21 (1)	13461 Red 21 (1)	13475 & 13477 Red 21 (1)	6TON21 Red 21 (1)	STD (1)	15520 Red 21 (1)	W8CRT Red 49 (1)	—	U8CRT Red 49 (1)	Red 49 (1)
TBM12D-1 Red 21 (2)	13461 Red 21 (2)	13475 & 13477 Red 21 (2)	6TON21 Red 21 (2)	STD (2)	15520 Red 21 (2)	W8CRT Red 49 (2)	—	U8CRT Red 49 (2)	Red 49 (2)
TBM12D-1 Blue 24 (1)	13461 Blue 24 (1)	13475 & 13477 Blue 24 (1)	6TON24 Blue 24 (1)	STD (1)	15522 Blue 24 (1)	W5CRT Blue 7 (1)	(1)	U5CRT Blue 7 (1)	Blue 7 (1)
TBM12D-1 Blue 24 (2)	13461 Blue 24 (2)	13475 & 13477 Blue 24 (2)	6TON24 Blue 24 (2)	STD (2)	15522 Blue 24 (2)	W5CRT Blue 7 (2)	(2)	U5CRT Blue 7 (2)	Blue 7 (2)
TBM12D-2 Gray 29 (1)	13461 Gray 29 (1)	13472 & 13476 Gray 29 (1)	6TON29 Gray 29 (1)	STD (1)	15527-CK Gray 29 (1)	W4CRT Gray 8 (1)	(1)	U4CRT Gray 8 (1)	—
TBM12D-2 Gray 29 (3)	13461 Gray 29 (2)	13472 & 13476 Gray 29 (3)	6TON29 Gray 29 (2)	STD (3)	15527-CK Gray 29 (2)	W4CRT Gray 8 (2)	(2)	U4CRT Gray 8 (2)	—
TBM12D-2 Brown 33 (1)	13461 Brown 33 (1)	13474 & 13477 Brown 33 (1)	6TON33 Brown 33 (1)	STD (1)	15528 Brown 33 (1)	W2CRT Brown 10 (1)	(1)	U2CRT Brown 10 (1)	—
TBM12D-2 Brown 33 (3)	13461 Brown 33 (3)	13474 & 13477 Brown 33 (3)	6TON33 Brown 33 (2)	STD (3)	15528 Brown 33 (2)	W2CRT Brown 10 (2)	(2)	U2CRT Brown 10 (2)	—
TBM12D-1 Green 37 (1)	13462 Green 37 (1)	13474 & 13477 Green 37 (1)	6TON37 Green 37 (1)	STD (1)	15513-CK Green 37 (1)	W1CRT-1 Green 11 (1)	(1)	U1CRT Green 11 (1)	—
TBM12D-3 Green 37 (3)	13462 Green 37 (3)	13474 & 13477 Green 37 (3)	6TON37 Green 37 (2)	STD (3)	15513-CK Green 37 (2)	W1CRT-1 Green 11 (2)	(2)	U1CRT Green 11 (2)	—
TBM12D-3 Pink 42 (1)	13462 Pink 42 (1)	13475 & 13477 Pink 42 (2)	6TON42 Pink 42 (2)	STD (1)	15508 Pink 42 (2)	W25RT Pink 12 (2)	(1)	U25RT Pink 12 (1)	—
TBM12D-3 Pink 42 (3)	13462 Pink 42 (3)	13475 & 13477 Pink 42 (3)	6TON42 Pink 42 (3)	STD (3)	15508 Pink 42 (3)	W25RT Pink 12 (3)	(2)	U25RT Pink 12 (2)	—
TBM12D-4 Blk/Gold 45 (1)	13462 Black 45 (2)	13474 & 13477 Black 45 (2)	6TON45 Black 45 (2)	STD (1)	15526 Black 45 (1)	W26RT Black 13 (2)	(1)	U26RT Black 13 (1)	—
TBM12D-4 Blk/Gold 45 (3)	13462 Black 45 (4)	13474 & 13477 Black 45 (3)	6TON45 Black 45 (3)	STD (3)	15526 Black 45 (2)	W26RT Black 13 (3)	(2)	U26RT Black 13 (2)	—
TBM12D-4 Org/Tan 50 (1)	13462 Orange 50 (2)	13474 & 13477 Orange 50 (2)	6TON50 Orange 50 (2)	STD (1)	15530 Orange 50 (2)	W27RT Orange 14 (2)	(1)	U27RT Orange 14 (1)	—
TBM12D-4 Org/Tan 50 (3)	13462 Orange 50 (4)	13474 & 13477 Orange 50 (3)	6TON50 Orange 50 (3)	STD (3)	15530 Orange 50 (3)	W27RT Orange 14 (4)	(2)	U27RT Orange 14 (2)	—

®Requires U die adapter.

Chart continues on pages D3.72–D3.73

A.  
System  
Overview

B1.  
Cable Ties

B2.  
Cable  
Accessories

B3.  
Stainless  
Steel Ties

C1.  
Wiring  
Duct

C2.  
Surface  
Raceway

C3.  
Abrasion  
Protection

C4.  
Cable  
Management

D1.  
Terminals

D2.  
Power  
Connectors

D3.  
Grounding  
Connectors

E1.  
Labeling  
Systems

E2.  
Labels

E3.  
Pre-Printed  
& Write-On  
Markers

E4.  
Permanent  
Identification

E5.  
Lockout/  
Tagout  
& Safety  
Solutions

F.  
Index

A. System Overview

B1. Cable Ties

B2. Cable Accessories

B3. Stainless Steel Ties

C1. Wiring Duct

C2. Surface Raceway

C3. Abrasion Protection

C4. Cable Management

D1. Terminals

D2. Power Connectors

D3. Grounding Connectors

E1. Labeling Systems

E2. Labels

E3. Pre-Printed & Write-On Markers

E4. Permanent Identification

E5. Lockout/Tagout & Safety Solutions

F. Index

**For use with Copper Conductors**

## Installation Tooling and Die Selections for: Types LCAX, LCAXN, LCBX, LCDX, LCDXN and LCCX (continued)

### Panduit (See Compression Connector Tools Selection Guide, Pages D3.34 – D3.36)

Panduit Part Number	Std. Wire Size	Cable Classes	Wire Strip Length (In.)	Die Part Number/Color Code and Die Index Number/(Number Of Crimps)		
				CT-1700 <sup>①</sup>	CT-2001, CT-2001/L, CT-2001/LE, CT-2002, CT-2002/L, CT-3001, CT-3001/E	CT-920, CT-920CH, CT-2920, CT-930, CT-930CH, CT-2930, CT-2930/L, CT-2930/LE, CT-2931, CT-2940 <sup>②</sup> , CT-2940/L <sup>②</sup> , CT-2940/LE <sup>②</sup> , CT-940CH <sup>③</sup>
LCAX4/0, LCDX4/0, LCDXN4/0, LCEX4/0, LCJX4/0	4/0 AWG	Compact, B, G, H, I, K, M, Locomotive (DLO) <sup>⑦</sup>	1-1/16	—	CD-2001-4/0 Purple P54 (2)	CD-920-4/0 Purple P54 (1)
LCBX4/0, LCCX4/0			2-5/16		CD-2001-4/0 Purple P54 (3)	CD-920-4/0 Purple P54 (3)
LCAX250, LCAXN250, LCDX250, LCDXN250, LCEX250, LCJX250	250 kcmil	G, H, I, K, M	1-1/16	—	CD-2001-250 Yellow P62 (2)	CD-920-250 Yellow P62 (1)
LCBX250, LCCX250	262.6 kcmil	Locomotive (DLO)	2-5/16		CD-2001-250 Yellow P62 (3)	CD-920-250 Yellow P62 (3)
LCAX300, LCDX300, LCDXN300, LCEX300, LCJX300	300 kcmil	G, H, I, K, M	1-1/4	—	CD-2001-350 Red P71 (2)	CD-920-350 Red P71 (2)
	313.1 kcmil	Locomotive (DLO)			CD-2001-350 Red P71 (4)	CD-920-350 Red P71 (3)
LCBX300, LCCX300	300 kcmil	G, H, I, K, M	2-3/8	—	—	—
	313.1 kcmil	Locomotive (DLO)				
LCAX350, LCDX350, LCDXN350, LCEX350, LCJX350	350 kcmil	G, H, I, K, M	1-3/8	—	—	—
	373.7 kcmil	Locomotive (DLO)				
LCBX350, LCCX350	350 kcmil	G, H, I, K, M	2-9/16	—	—	—
	373.7 kcmil	Locomotive (DLO)				
LCAX450, LCDX450, LCDXN450, LCEX450, LCJX450	450 kcmil	G, H, I, K, M	1-7/16	—	—	—
	444.4 kcmil	Locomotive (DLO)				
LCBX450, LCCX450	450 kcmil	G, H, I, K, M	2-3/4	—	—	—
	444.4 kcmil	Locomotive (DLO)				
LCAX500, LCDX500, LCDXN500, LCEX500, LCJX500	500 kcmil	G, H, I, K, M	1-9/16	—	—	CD-920-500A Pink P99 (2)
LCBX500, LCCX500	535.3 kcmil	Locomotive (DLO)	2-15/16			CD-920-500A Pink P99 (4)
LCAX600, LCDX600, LCDXN600, LCEX600, LCJX600	600 kcmil	G, H, I	1-9/16	—	—	CD-920-500A Pink P99 (2)
LCAX650, LCDX650, LCDXN650, LCEX650, LCJX650	646.4 kcmil	Locomotive (DLO)	1-1/2			CD-940-750 <sup>④</sup> Black P106 (2)
LCAX750, LCDX750, LCDXN750, LCEX750, LCJX750	777.7 kcmil	Locomotive (DLO)	1-3/4	—	—	CD-940-750X <sup>④</sup> Yellow (2)

①The CT-1700 crimp die pockets are integrated into the tool frame.  
 ②CD-920 dies can be used with CT-940CH and CT-2940 tools with CD-940-DA adapter.  
 ③CD-940 dies to be used exclusively with CT-940CH and CT-2940 tools.  
 ⑦Does not include class M flex conductor with Thomas and Betts tools.

**For use with  
Copper  
Conductors**

## Installation Tooling and Die Selections for: Types LCAX, LCAXN, LCBX, LCDX, LCDXN and LCCX (continued)

Thomas & Betts						Burndy			
TBM12	TBM8	TBM6, 25000	TBM6BSCR, TBM6H	TBM8-750, TBM8-750M-1	TBM14BSCR, TBM14M, TBM15	BCT500HS, Y500CT-HS	Y644M	Y35, Y39, Y750, Y46 <sup>Ⓢ</sup> , Y750-2, Y750BH, BAT35-14V, BAT750-14V, PAT750-18V	MRC840
Die Part Number/Color Code and Die Index Number (Number of Crimps)									
TBM12D-5 Purp/Olive 54 (1)	—	—	6TON54 Purple 54 (2)	STD (1)	15511 Purple 54 (2)	W28RT Purple 15 (2)	(1)	U28RT Purple 15 (1)	—
TBM12D-5 Purp/Olive 54 (4)	—	—	6TON54 Purple 54 (4)	STD (4)	15511 Purple 54 (4)	W28RT Purple 15 (4)	(3)	U28RT Purple 15 (3)	—
TBM12D-5 Yellow 62 (1)	—	—	6TON62 Yellow 62 (2)	STD (1)	15510-CK Yellow 62 (1)	W29RT Yellow 16 (2)	(1)	U29RT Yellow 16 (1)	—
TBM12D-5 Yellow 62 (3)	—	—	6TON62 Yellow 62 (4)	STD (4)	15510-CK Yellow 62 (2)	W29RT Yellow 16 (4)	(3)	U29RT Yellow 16 (3)	—
TBM12D-4 Red 71H <sup>Ⓢ</sup> (2)	—	—	6TON71 Red 71H <sup>Ⓢ</sup> (2)	STD (2)	15514-CK Red 71H <sup>Ⓢ</sup> (2)	W31RT Red 18 (2)	(1)	U31RT Red 18 (2)	—
TBM12D-4 Red 71H <sup>Ⓢ</sup> (4)	—	—	6TON71 Red 71H <sup>Ⓢ</sup> (4)	STD (4)	15514-CK Red 71H <sup>Ⓢ</sup> (4)	W31RT Red 18 (4)	(3)	U31RT Red 18 (4)	—
TBM12D-4 Blue 76H <sup>Ⓢ</sup> (2)	—	—	6TON76 Blue 76H <sup>Ⓢ</sup> (2)	STD (2)	15512 Blue 76H <sup>Ⓢ</sup> (2)	W32RT Blue 19 (3)	(1)	U32RT Blue 19 (2)	—
TBM12D-4 Blue 76H <sup>Ⓢ</sup> (4)	—	—	6TON76 Blue 76H <sup>Ⓢ</sup> (4)	STD (4)	15512 Blue 76H <sup>Ⓢ</sup> (4)	W32RT Blue 19 (4)	(3)	U32RT Blue 19 (4)	—
TBM12D-3 Brown 87H <sup>Ⓢ</sup> (2)	—	—	6TON87 Brown 87H <sup>Ⓢ</sup> (2)	STD (2)	15506 Brown 87H <sup>Ⓢ</sup> (2)	—	(1)	U34RT Brown 20 (2)	—
TBM12D-3 Brown 87H <sup>Ⓢ</sup> (4)	—	—	6TON87 Brown 87H <sup>Ⓢ</sup> (4)	STD (4)	15506 Brown 87H <sup>Ⓢ</sup> (4)	—	(4)	U34RT Brown 20 (4)	—
TBM12D-2 Pink 99H <sup>Ⓢ</sup> (2)	—	—	—	STD (2)	15505 Pink 99H <sup>Ⓢ</sup> (2)	—	(1)	U38XRT Pink L99 (2)	—
TBM12D-2 Pink 99H <sup>Ⓢ</sup> (4)	—	—	—	STD (4)	15505 Pink 99H <sup>Ⓢ</sup> (4)	—	(4)	U38XRT Pink L99 (4)	—
TBM12D-2 Pink 99H <sup>Ⓢ</sup> (2)	—	—	—	STD (2)	15505 Pink 99H <sup>Ⓢ</sup> (2)	—	(1)	U38RT Pink 400 (2)	—
TBM12D-2 Black 106H <sup>Ⓢ</sup> (2)	—	—	—	—	15515-CK Black 106H <sup>Ⓢ</sup> (2)	—	(1)	U39RT Black 24 (2)	—
TBM12D-1 Yellow 115H <sup>Ⓢ</sup> (2)	—	—	—	—	15504 Yellow 115H <sup>Ⓢ</sup> (2)	—	(1)	U44XRT Yellow L115 (2)	—

ⓈHalf width dies.

ⓈRequires U die adapter.

A.  
System  
Overview

B1.  
Cable Ties

B2.  
Cable  
Accessories

B3.  
Stainless  
Steel Ties

C1.  
Wiring  
Duct

C2.  
Surface  
Raceway

C3.  
Abrasion  
Protection

C4.  
Cable  
Management

D1.  
Terminals

D2.  
Power  
Connectors

D3.  
Grounding  
Connectors

E1.  
Labeling  
Systems

E2.  
Labels

E3.  
Pre-Printed  
& Write-On  
Markers

E4.  
Permanent  
Identification

E5.  
Lockout/  
Tagout  
& Safety  
Solutions

F.  
Index

- A. System Overview
- B1. Cable Ties
- B2. Cable Accessories
- B3. Stainless Steel Ties
- C1. Wiring Duct
- C2. Surface Raceway
- C3. Abrasion Protection
- C4. Cable Management
- D1. Terminals
- D2. Power Connectors
- D3. Grounding Connectors
- E1. Labeling Systems
- E2. Labels
- E3. Pre-Printed & Write-On Markers
- E4. Permanent Identification
- E5. Lockout/Tagout & Safety Solutions
- F. Index

**For use with Copper Conductors**

## Installation Tooling and Die Selections for: Types LCAF, LCCF, and SCSF

### How to read this chart

For LCAF6 Lug and CT-2931 crimping tool:



**Panduit (See Compression Connector Tools Selection Guide, Pages D3.34 – D3.36)**

**CT-930, CT-930CH, CT-2930, CT-2930/L, CT-2930/LE, CT-2931, CT-920, CT-920CH, CT-2920, CT-940CH<sup>①</sup>, CT-2940<sup>①</sup> CT-2940/L<sup>①</sup>, CT-2940/LE<sup>①</sup>**

### Die Part Number/Color Code and Die Index Number/ (Number Of Crimps)

Panduit Part Number	Std. Wire Size	Cable Classes	Wire Strip Length (In.)	Die Part Number/Color Code and Die Index Number/ (Number Of Crimps)	
				for LCAF, SCSF Parts	for LCCF Parts
LCAF8 LCCF8 SCSF8	#8 AWG	Locomotive (DLO)	13/16 7/8 11/16	CD-920-8 Red P21 (1)	
LCAF6 LCCF6 SCSF6	#6 AWG	K, M, Locomotive (DLO)	7/8 1-5/16 13/16	CD-920-6 Blue P24 (1)	CD-920-6 Blue P24 (2)
LCAF4 LCCF4 SCSF4	#4 AWG	K, M, Locomotive (DLO)	7/8 1-5/16 13/16	CD-920-4 Gray P29 (1)	CD-920-4 Gray P29 (2)
LCAF2 LCCF2 SCSF2	#2 AWG	K, M, Locomotive (DLO)	15/16 1-7/16 7/8	CD-920-2 Brown P33 (1)	CD-920-2 Brown P33 (2)
LCAF1 LCCF1 SCSF1	#1 AWG	K, M, Locomotive (DLO)	1 1-1/2 7/8	CD-920-1/0 Pink P42 (1)	CD-920-1/0 Pink P42 (2)
LCAF1/0 LCCF1/0 SCSF1/0	1/0 AWG	K, M, Locomotive (DLO)	1-7/16 1-9/16 1-3/16	CD-920-2/0 Black P45 (2)	
LCAF2/0 LCCF2/0 SCSF2/0	2/0 AWG	K, M, Locomotive (DLO)	1-7/16 1-9/16 1-3/16	CD-920-3/0 Orange P50 (2)	
LCAF3/0 LCCF3/0 SCSF3/0	3/0 AWG	K, M, Locomotive (DLO)	1-7/16 1-5/8 1-3/16	CD-920-4/0 Purple P54 (2)	
LCAF4/0 LCCF4/0 SCSF4/0	4/0 AWG	K, M, Locomotive (DLO)	1-7/16 1-11/16 1-3/16	CD-920-250 Yellow P62 (2)	

<sup>①</sup>CD-920 dies can be used with CT-940CH and CT-2940 tools with CD-940-DA adapter.

For use with  
Copper  
Conductors

## Installation Tooling and Die Selections for: Types LCAF, LCCF, and SCSF (continued)

				Panduit (See Compression Connector Tools Selection Guide, Pages D3.34 – D3.36)	
				CT-930, CT-930CH, CT-2930, CT-2930/L, CT-2930/LE, CT-2931, CT-920, CT-920CH, CT-2920, CT-940CH <sup>①</sup> , CT-2940 <sup>①</sup> , CT-2940/L <sup>①</sup> , CT-2940/LE <sup>①</sup>	
				Die Part Number/Color Code and Die Index Number/ (Number Of Crimps)	
Panduit Part Number	Std. Wire Size	Cable Classes	Wire Strip Length (In.)	for LCAF, SCSF Parts	for LCCF Parts
L = Lug S = Splice					
LCAF250	250 kcmil 262.6 kcmil	K, M, Locomotive (DLO)	1-3/4	CD-920-300 White P66 (2)	CD-920-300 White P66 (3)
LCCF250			2-5/16		
SCSF250			1-3/16		
LCAF300	300 kcmil 313.1 kcmil	K, M, Locomotive (DLO)	1-3/4	CD-920-350 Red P71 (2)	CD-920-350 Red P71 (3)
LCCF300			2-3/8		
SCSF300			1-1/4		
LCAF350	350 kcmil 373.7 kcmil	K, M, Locomotive (DLO)	1-15/16	CD-920-400 Blue P76 (2)	CD-920-400 Blue P76 (3)
LCCF350			2-9/16		
SCSF350			1-1/2		
LCAF400	400 kcmil 444.4 kcmil	K, M, Locomotive (DLO)	2-1/4	CD-920-500 Brown P87 (2)	CD-920-500 Brown P87 (3)
LCCF400			2-3/4		
SCSF400			1-11/16		
LCAF500	500 kcmil 535.3 kcmil	K, M, Locomotive (DLO)	2-5/16	CD-920-500A Pink P99 (2)	CD-920-500A Pink P99 (3)
LCCF500			2-15/16		
SCSF500			1-5/8		
LCAF600 <sup>③</sup>	646.4 kcmil	Locomotive (DLO)	2-3/8	CD-920-750 Black P106 (2)	CD-920-750 Black P106 (3)
LCCF600 <sup>③</sup>			3		
SCSF600 <sup>③</sup>			1-5/8		
LCAF750 <sup>③</sup>	777.7 kcmil	Locomotive (DLO)	2-7/16	CD-940-800 <sup>②</sup> Orange P107 (2)	CD-940-800 <sup>②</sup> Orange P107 (4)
LCCF750 <sup>③</sup>			3-1/16		
SCSF750 <sup>③</sup>			1-5/8		

① CD-920 dies can be used with CT-940CH and CT-2940 tools with CD-940-DA adapter.

② CD-940 dies to be used exclusively with CT-940CH and CT-2940 tools.

③ Can only be crimped with CT-940CH and CT-2940 tools.

A.  
System  
Overview

B1.  
Cable Ties

B2.  
Cable  
Accessories

B3.  
Stainless  
Steel Ties

C1.  
Wiring  
Duct

C2.  
Surface  
Raceway

C3.  
Abrasion  
Protection

C4.  
Cable  
Management

D1.  
Terminals

D2.  
Power  
Connectors

D3.  
Grounding  
Connectors

E1.  
Labeling  
Systems

E2.  
Labels

E3.  
Pre-Printed  
& Write-On  
Markers

E4.  
Permanent  
Identification

E5.  
Lockout/  
Tagout  
& Safety  
Solutions

F.  
Index

A. System Overview

B1. Cable Ties

B2. Cable Accessories

B3. Stainless Steel Ties

C1. Wiring Duct

C2. Surface Raceway

C3. Abrasion Protection

C4. Cable Management

D1. Terminals

D2. Power Connectors

D3. Grounding Connectors

E1. Labeling Systems

E2. Labels

E3. Pre-Printed & Write-On Markers

E4. Permanent Identification

E5. Lockout/Tagout & Safety Solutions

F. Index

**For use with Copper Conductors**

## Installation Tooling and Die Selections for: Type RSC In-Line Reducing Splice

### How to read this chart

For RSC4-6 splice and CT-2001 crimping tool:



Panduit Part Number	Reducing From			Reducing To		
	Standard Wire Size	Cable Classes	Wire Strip Length (In.)	Standard Wire Size	Cable Classes	Wire Strip Length (In.)
<b>RSC4-6</b>	#4 – #3 AWG STR, #2 AWG SOL	B, C, Compact	1	#6 AWG	B, C, Compact	1-5/16
<b>RSC2-6</b>	#2 AWG	B, C, Compact	1	#6 AWG	B, C, Compact	1-5/16
<b>RSC2-4</b>	#2 AWG	B, C, Compact	1	#4 – #3 AWG STR, #2 AWG SOL	B, C, Compact	1-5/16
<b>RSC1/0-6</b>	1/0 AWG	B, C, Compact	1	#6 AWG	B, C, Compact	1-5/16
<b>RSC1/0-4</b>	1/0 AWG	B, C, Compact	1	#4 – #3 AWG STR, #2 AWG SOL	B, C, Compact	1-5/16
<b>RSC2/0-6</b>	2/0 AWG	B, C, Compact	1-1/16	#6 AWG	B, C, Compact	1-5/16
<b>RSC2/0-4</b>	2/0 AWG	B, C, Compact	1-1/16	#4 – #3 AWG STR, #2 AWG SOL	B, C, Compact	1-5/16
<b>RSC4/0-6</b>	4/0 AWG	B, C, Compact	1-1/16	#6 AWG	B, C, Compact	1-5/16
<b>RSC4/0-4</b>	4/0 AWG	B, C, Compact	1-1/16	#4 – #3 AWG STR, #2 AWG SOL	B, C, Compact	1-5/16
<b>RSC4/0-1/0</b>	4/0 AWG	B, C, Compact	1-1/16	1/0 AWG	B, C, Compact	1-9/16
<b>RSC4/0-2/0</b>	4/0 AWG	B, C, Compact	1-1/16	2/0 AWG	B, C, Compact	1-7/16
<b>RSC500-X4/0</b>	500 kcmil	B, C, Compact	1-7/8	4/0 AWG	I	1-7/16
<b>RSC500-X350</b>	500 kcmil	B, C, Compact	1-7/8	350 kcmil	I	1-7/8
<b>RSC750-4/0</b>	750 kcmil	B, C, Compact	2	4/0 AWG	B, C, Compact	1-5/8
<b>RSC750-X4/0</b>	750 kcmil	B, C, Compact	2	4/0 AWG	I	1-7/16
<b>RSC750-X350</b>	750 kcmil	B, C, Compact	2	350 kcmil	I	1-7/8
<b>RSC750-500</b>	750 kcmil	B, C, Compact	2	500 kcmil	B, C, Compact	1-7/8
<b>RSC750-X500</b>	750 kcmil	B, C, Compact	2	500 kcmil	I	2
<b>RSC750-750</b>	750 kcmil	B, C, Compact	2	750 kcmil	B, C, Compact	2
<b>RSCX750-4/0</b>	750 kcmil	I	2	4/0 AWG	B, C, Compact	1-5/8
<b>RSCX750-750</b>	750 kcmil	I	2	750 kcmil	B, C, Compact	2

For use with  
Copper  
Conductors

## Installation Tooling and Die Selections for: Type RSC In-Line Reducing Splice (continued)

Panduit (See Compression Connector Tools Selection Guide, Pages D3.34–D3.36)							
CT-1700 <sup>①</sup>		CT-720		CT-2001, CT-2001/L, CT-2001/LE, CT-2002, CT-2002/L, CT-3001, CT-3001/E		CT-930 <sup>⑤</sup> , CT-930CH <sup>⑤</sup> , CT-920 <sup>⑥</sup> , CT-920CH <sup>⑥</sup> , CT-2920 <sup>⑥</sup> , CT-2940 <sup>③</sup> , CT-2940/L <sup>③</sup> , CT-2940/LE <sup>③</sup> , CT-940CH <sup>③</sup> , CT-2930 <sup>⑤</sup> , CT-2930/L, CT-2930/LE <sup>⑤</sup> , CT-2931 <sup>⑤</sup>	
Reducing From	Reducing To	Reducing From	Reducing To	Reducing From	Reducing To	Reducing From	Reducing To
Die Part Number/Color Code and Die Index Number/ (Number Of Crimps)							
Gray P29 (2)	Blue P24 (2)	CD-720-1 Gray P29 (1)	CD-720-1 Blue P24 (1)	CD-2001-4 Gray P29 (1)	CD-2001-6 Blue P24 (1)	CD-920-4 Gray P29 (1)	CD-920-6 Blue P24 (1)
Brown P33 (2)	Blue P24 (2)	CD-720-1 Brown P33 (1)	CD-720-1 Blue P24 (1)	CD-2001-2 Brown P33 (1)	CD-2001-6 Blue P24 (1)	CD-920-2 Brown P33 (1)	CD-920-6 Blue P24 (1)
Brown P33 (2)	Gray P29 (2)	CD-720-1 Brown P33 (1)	CD-720-1 Gray P29 (1)	CD-2001-2 Brown P33 (1)	CD-2001-4 Gray P29 (1)	CD-920-2 Brown P33 (1)	CD-920-4 Gray P29 (1)
—	—	CD-720-2 Pink P42 (1)	CD-720-1 Blue P24 (1)	CD-2001-1/0 Pink P42 (1)	CD-2001-6 Blue P24 (1)	CD-920-1/0 Pink P42 (1)	CD-920-6 Blue P24 (1)
—	—	CD-720-2 Pink P42 (1)	CD-720-1 Gray P29 (1)	CD-2001-1/0 Pink P42 (1)	CD-2001-4 Gray P29 (1)	CD-920-1/0 Pink P42 (1)	CD-920-4 Gray P29 (1)
—	—	CD-720-2 Black P45 (2)	CD-720-1 Blue P24 (1)	CD-2001-2/0 Black P45 (2)	CD-2001-6 Blue P24 (1)	CD-920-2/0 Black P45 (1)	CD-920-6 Blue P24 (1)
—	—	CD-720-2 Black P45 (2)	CD-720-1 Gray P29 (1)	CD-2001-2/0 Black P45 (2)	CD-2001-4 Gray P29 (1)	CD-920-2/0 Black P45 (1)	CD-920-4 Gray P29 (1)
—	—	CD-720-3 Purple P54 (2)	CD-720-1 Blue P24 (1)	CD-2001-4/0 Purple P54 (2)	CD-2001-6 Blue P24 (1)	CD-920-4/0 Purple P54 (1)	CD-920-6 Blue P24 (1)
—	—	CD-720-3 Purple P54 (2)	CD-720-1 Gray P29 (1)	CD-2001-4/0 Purple P54 (2)	CD-2001-4 Gray P29 (1)	CD-920-4/0 Purple P54 (1)	CD-920-4 Gray P29 (1)
—	—	CD-720-3 Purple P54 (2)	CD-720-2 Pink P42 (2)	CD-2001-4/0 Purple P54 (2)	CD-2001-1/0 Pink P42 (2)	CD-920-4/0 Purple P54 (1)	CD-920-1/0 Pink P42 (2)
—	—	CD-720-3 Purple P54 (2)	CD-720-2 Black P45 (2)	CD-2001-4/0 Purple P54 (2)	CD-2001-2/0 Black P45 (2)	CD-920-4/0 Purple P54 (1)	CD-920-2/0 Black P45 (2)
—	—	CD-720-7 Brown P87 (2)	CD-720-3 Yellow P62 (2)	CD-2001-500 Brown P87 (3)	CD-2001-250 Yellow P62 (2)	CD-920-500 Brown P87 (2)	CD-920-250 Yellow P62 (2)
—	—	CD-720-7 Brown P87 (2)	CD-720-6 Blue P76 (2)	CD-2001-500 Brown P87 (3)	CD-2001-400 Blue P76 (3)	CD-920-500 Brown P87 (2)	CD-920-400 Blue P76 (2)
—	—	—	—	—	—	CD-920-750, CD-940-750 <sup>④</sup> Black P106 (2)	CD-920-4/0 Purple P54 (1)
—	—	—	—	—	—	CD-920-750, CD-940-750 <sup>④</sup> Black P106 (2)	CD-920-250 Yellow P62 (1)
—	—	—	—	—	—	CD-920-750, CD-940-750 <sup>④</sup> Black P106 (2)	CD-920-400 Blue P76 (2)
—	—	—	—	—	—	CD-920-750, CD-940-750 <sup>④</sup> Black P106 (2)	CD-920-500 Brown P87 (2)
—	—	—	—	—	—	CD-920-750, CD-940-750 <sup>④</sup> Black P106 (2)	CD-920-500A Pink P99 (2)
—	—	—	—	—	—	CD-920-750, CD-940-750 <sup>④</sup> Black P106 (2)	CD-920-750, CD-940-750 Black P106 (2)
—	—	—	—	—	—	CD-940-750X <sup>④</sup> Yellow P115 (2)	CD-920-4/0 Purple P54 (1)
—	—	—	—	—	—	CD-940-750X <sup>④</sup> Yellow P115 (2)	CD-940-750 <sup>④</sup> Black P106 (2)

①The CT-1700 crimp die pockets are integrated into the tool frame.  
 ②CD-920 dies can be used with CT-940CH and CT-2940 tools with CD-940-DA adapter.  
 ③CD-940 dies to be used with CT-940CH and CT-2940 tools.  
 ④Maximum conductor size: 500 kcmil class I and 750 kcmil class I, B, C, Compact.  
 ⑤Maximum conductor size: 250 kcmil class I and 400 kcmil class I, B, C, Compact.

For Burndy tooling, see pages D3.78 – D3.79  
 For Thomas and Betts tooling, see pages D3.80 – D3.81

A.  
System  
Overview

B1.  
Cable Ties

B2.  
Cable  
Accessories

B3.  
Stainless  
Steel Ties

C1.  
Wiring  
Duct

C2.  
Surface  
Raceway

C3.  
Abrasion  
Protection

C4.  
Cable  
Management

D1.  
Terminals

D2.  
Power  
Connectors

D3.  
Grounding  
Connectors

E1.  
Labeling  
Systems

E2.  
Labels

E3.  
Pre-Printed  
& Write-On  
Markers

E4.  
Permanent  
Identification

E5.  
Lockout/  
Tagout  
& Safety  
Solutions

F.  
Index

A.  
System  
Overview

B1.  
Cable Ties

B2.  
Cable  
Accessories

B3.  
Stainless  
Steel Ties

C1.  
Wiring  
Duct

C2.  
Surface  
Raceway

C3.  
Abrasion  
Protection

C4.  
Cable  
Management

D1.  
Terminals

D2.  
Power  
Connectors

D3.  
Grounding  
Connectors

E1.  
Labeling  
Systems

E2.  
Labels

E3.  
Pre-Printed  
& Write-On  
Markers

E4.  
Permanent  
Identification

E5.  
Lockout/  
Tagout  
& Safety  
Solutions

F.  
Index

**For use with  
Copper  
Conductors**

## Installation Tooling and Die Selections for: Type RSC In-Line Reducing Splice (continued)

Panduit Part Number	Reducing From			Reducing To		
	Standard Wire Size	Cable Classes	Wire Strip Length (In.)	Standard Wire Size	Cable Classes	Wire Strip Length (In.)
RSC4-6	#4 – #3 AWG STR, #2 AWG SOL	B, C, Compact	1	#6 AWG	B, C, Compact	1-5/16
RSC2-6	#2 AWG	B, C, Compact	1	#6 AWG	B, C, Compact	1-5/16
RSC2-4	#2 AWG	B, C, Compact	1	#4 – #3 AWG STR, #2 AWG SOL	B, C, Compact	1-5/16
RSC1/0-6	1/0 AWG	B, C, Compact	1	#6 AWG	B, C, Compact	1-5/16
RSC1/0-4	1/0 AWG	B, C, Compact	1	#4 – #3 AWG STR, #2 AWG SOL	B, C, Compact	1-5/16
RSC2/0-6	2/0 AWG	B, C, Compact	1-1/16	#6 AWG	B, C, Compact	1-5/16
RSC2/0-4	2/0 AWG	B, C, Compact	1-1/16	#4 – #3 AWG STR, #2 AWG SOL	B, C, Compact	1-5/16
RSC4/0-6	4/0 AWG	B, C, Compact	1-1/16	#6 AWG	B, C, Compact	1-5/16
RSC4/0-4	4/0 AWG	B, C, Compact	1-1/16	#4 – #3 AWG STR, #2 AWG SOL	B, C, Compact	1-5/16
RSC4/0-1/0	4/0 AWG	B, C, Compact	1-1/16	1/0 AWG	B, C, Compact	1-9/16
RSC4/0-2/0	4/0 AWG	B, C, Compact	1-1/16	2/0 AWG	B, C, Compact	1-7/16
RSC500-X4/0	500 kcmil	B, C, Compact	1-7/8	4/0 AWG	I	1-7/16
RSC500-X350	500 kcmil	B, C, Compact	1-7/8	350 kcmil	I	1-7/8
RSC750-4/0	750 kcmil	B, C, Compact	2	4/0 AWG	B, C, Compact	1-5/8
RSC750-X4/0	750 kcmil	B, C, Compact	2	4/0 AWG	I	1-7/16
RSC750-X350	750 kcmil	B, C, Compact	2	350 kcmil	I	1-7/8
RSC750-500	750 kcmil	B, C, Compact	2	500 kcmil	B, C, Compact	1-7/8
RSC750-X500	750 kcmil	B, C, Compact	2	500 kcmil	I	2
RSC750-750	750 kcmil	B, C, Compact	2	750 kcmil	B, C, Compact	2
RSCX750-4/0	750 kcmil	I	2	4/0 AWG	B, C, Compact	1-5/8
RSCX750-750	750 kcmil	I	2	750 kcmil	B, C, Compact	2



For use with  
Copper  
Conductors

## Installation Tooling and Die Selections for: Type RSC In-Line Reducing Splice (continued)

Burndy					
Y1MR, Y2MR		Y1MRTC		Y35, Y35BH, Y39, Y39BH, Y45, Y46, Y750, Y750HS, Y750-2, Y750BH-2, BAT35, BAT750, PAT644, PAT750	
Reducing From	Reducing To	Reducing From	Reducing To	Reducing From	Reducing To
Die Part Number/Color Code and Die Index Number/ (Number of Crimps)					
Gray (2)	Blue (3)	White (2)	Blue (3)	U4CR Gray 8 (1)	U5CRT Blue 7 (1)
Brown (2)	Blue (3)	Brown (2)	Blue (3)	U2CRT Brown 10 (1)	U5CRT Blue 7 (1)
Brown (2)	Gray (3)	Brown (2)	White (3)	U2CRT Brown 10 (1)	U4CRT Gray 8 (1)
—	—	—	—	U25RT Pink 12 (1)	U5CRT Blue 7 (1)
—	—	—	—	U25RT Pink 12 (1)	U4CRT Gray 8 (1)
—	—	—	—	U26RT Black 13 (1)	U5CRT Blue 7 (1)
—	—	—	—	U26RT Black 13 (1)	U4CRT Gray 8 (1)
—	—	—	—	U28RT Purple 15 (1)	U5CRT Blue 7 (1)
—	—	—	—	U28RT Purple 15 (1)	U4CRT Gray 8 (1)
—	—	—	—	U28RT Purple 15 (1)	U25RT Pink 12 (2)
—	—	—	—	U28RT Purple 15 (1)	U26RT Black 13 (1)
—	—	—	—	U34RT Brown 20 (2)	U29RT Yellow 16 (1)
—	—	—	—	U34RT Brown 20 (2)	U32RT Blue 19 (2)
—	—	—	—	U39RT Black 24 (3)	U28RT Purple 15 (1)
—	—	—	—	U39RT Black 24 (3)	U29RT Yellow 16 (1)
—	—	—	—	U39RT Black 24 (3)	U32RT Blue 19 (2)
—	—	—	—	U39RT Black 24 (3)	U34RT Brown 20 (2)
—	—	—	—	U39RT Black 24 (3)	U38XRT Pink L99 (3)
—	—	—	—	U39RT Black 24 (3)	U39RT Black 24 (3)
—	—	—	—	—	—
—	—	—	—	—	—

For Panduit tooling, see pages D3.76 – D3.77  
For Thomas and Betts tooling, see pages D3.80 – D3.81

A.  
System  
Overview

B1.  
Cable Ties

B2.  
Cable  
Accessories

B3.  
Stainless  
Steel Ties

C1.  
Wiring  
Duct

C2.  
Surface  
Raceway

C3.  
Abrasion  
Protection

C4.  
Cable  
Management

D1.  
Terminals

D2.  
Power  
Connectors

D3.  
Grounding  
Connectors

E1.  
Labeling  
Systems

E2.  
Labels

E3.  
Pre-Printed  
& Write-On  
Markers

E4.  
Permanent  
Identification

E5.  
Lockout/  
Tagout  
& Safety  
Solutions

F.  
Index

A.  
System  
Overview

B1.  
Cable Ties

B2.  
Cable  
Accessories

B3.  
Stainless  
Steel Ties

C1.  
Wiring  
Duct

C2.  
Surface  
Raceway

C3.  
Abrasion  
Protection

C4.  
Cable  
Management

D1.  
Terminals

D2.  
Power  
Connectors

D3.  
Grounding  
Connectors

E1.  
Labeling  
Systems

E2.  
Labels

E3.  
Pre-Printed  
& Write-On  
Markers

E4.  
Permanent  
Identification

E5.  
Lockout/  
Tagout  
& Safety  
Solutions

F.  
Index

**For use with  
Copper  
Conductors**

## Installation Tooling and Die Selections for: Type RSC In-Line Reducing Splice (continued)

Panduit Part Number	Reducing From			Reducing To		
	Standard Wire Size	Cable Classes	Wire Strip Length	Standard Wire Size	Cable Classes	Wire Strip Length
RSC4-6	#4 – #3 AWG STR #2 AWG Solid	B, C, Compact	1	6 AWG	B, C, Compact	1-5/16
RSC2-6	#2 AWG	B, C, Compact	1	6 AWG	B, C, Compact	1-5/16
RSC2-4	#2 AWG	B, C, Compact	1	4-3 AWG 2 Solid	B, C, Compact	1-5/16
RSC1/0-6	1/0 AWG	B, C, Compact	1	6 AWG	B, C, Compact	1-5/16
RSC1/0-4	1/0 AWG	B, C, Compact	1	4 – 3 AWG 2 Solid	B, C, Compact	1-5/16
RSC2/0-6	2/0 AWG	B, C, Compact	1-1/16	6 AWG	B, C, Compact	1-5/16
RSC2/0-4	2/0 AWG	B, C, Compact	1-1/16	4 – 3 AWG 2 Solid	B, C, Compact	1-5/16
RSC4/0-6	4/0 AWG	B, C, Compact	1-1/16	6 AWG	B, C, Compact	1-5/16
RSC4/0-4	4/0 AWG	B, C, Compact	1-1/16	4 – 3 AWG 2 Solid	B, C, Compact	1-5/16
RSC4/0-1/0	4/0 AWG	B, C, Compact	1-1/16	1/0 AWG	B, C, Compact	1-9/16
RSC4/0-2/0	4/0 AWG	B, C, Compact	1-1/16	2/0 AWG	B, C, Compact	1-7/16
RSC500-X4/0	500 kcmil	B, C, Compact	1-7/8	4/0 AWG	I	1-7/16
RSC500-X350	500 kcmil	B, C, Compact	1-7/8	350 kcmil	I	1-7/8
RSC750-4/0	750 kcmil	B, C, Compact	2	4/0 AWG	B, C, Compact	1-5/8
RSC750-X4/0	750 kcmil	B, C, Compact	2	4/0 AWG	I	1-7/16
RSC750-X350	750 kcmil	B, C, Compact	2	350 AWG	I	1-7/8
RSC750-500	750 kcmil	B, C, Compact	2	500 kcmil	B, C, Compact	1-7/8
RSC750-X500	750 kcmil	B, C, Compact	2	500 kcmil	I	2
RSC750-750	750 kcmil	B, C, Compact	2	750 kcmil	B, C, Compact	2
RSCX750-4/0	750 kcmil	I	2	4/0 AWG	B, C, Compact	1-5/8
RSCX750-750	750 kcmil	I	2	750 kcmil	B, C, Compact	2

For use with  
Copper  
Conductors

## Installation Tooling and Die Selections for: Type RSC In-Line Reducing Splice (continued)

Thomas & Betts							
TBM20S, TBM25S		TBM5, TBM6, TBM8		TBM12, 13642M		TBM14BSCR, BPLT14BSCR, 13100A, TBM14M	
Reducing From	Reducing To	Reducing From	Reducing To	Reducing From	Reducing To	Reducing From	Reducing To
Color Code/Die Index Number/ (Number of Crimps)							
Gray 29 (2)	Blue 24 (3)	Gray 29 (1)	Blue 24 (1)	Gray 29 (1)	Blue 24 (1)	Gray 29 (1)	Blue 24 (1)
Brown 33 (2)	Blue 24 (3)	Brown 33 (1)	Blue 24 (1)	Brown 33 (1)	Blue 24 (1)	Brown 33 (1)	Blue 24 (1)
Brown 33 (2)	Gray 29 (3)	Brown 33 (1)	Gray 29 (1)	Brown 33 (1)	Gray 29 (1)	Brown 33 (1)	Gray 29 (1)
—	—	Pink 42 (1)	Blue 24 (1)	Pink 42 (1)	Blue 24 (1)	Pink 42H <sup>®</sup> (2)	Blue 24 (1)
—	—	Pink 42 (1)	Gray 29 (1)	Pink 42 (1)	Gray 29 (1)	Pink 42H <sup>®</sup> (2)	Gray 29 (1)
—	—	Black 45 (2)	Blue 24(1)	Black/Gold 45 (1)	Blue 24 (1)	Black 45 (1)	Blue 24 (1)
—	—	Black 45 (2)	Gray 29 (1)	Black/Gold 45 (1)	Gray 29 (1)	Black 45 (1)	Gray 29 (1)
—	—	Purple 54 (2)	Blue 24 (1)	Purple/Olive 54 (1)	Blue 24 (1)	Olive 54H <sup>®</sup> (2)	Blue 24 (1)
—	—	Purple 54 (2)	Gray 29 (1)	Purple/Olive 54 (1)	Gray 29 (1)	Olive 54H <sup>®</sup> (2)	Gray 29 (1)
—	—	Purple 54 (2)	Pink 42 (2)	Purple/Olive 54 (1)	Pink 42 (2)	Olive 54H <sup>®</sup> (2)	Pink 42H <sup>®</sup> (4)
—	—	Purple 54 (2)	Black 45 (2)	Purple/Olive 54 (1)	Black/Gold 45 (1)	Olive 54H <sup>®</sup> (2)	Black 45 (1)
—	—	—	—	Brown 87H <sup>®</sup> (2)	Yellow 62 (1)	Brown 87H <sup>®</sup> (2)	Yellow 62 (1)
—	—	—	—	Brown 87H <sup>®</sup> (2)	Blue 76H <sup>®</sup> (2)	Brown 87H <sup>®</sup> (2)	Blue 76 (1)
—	—	—	—	Black/Orange 106H <sup>®</sup> (2)	Purple/Olive 54 (1)	Black 106H <sup>®</sup> (2)	Olive 54H <sup>®</sup> (2)
—	—	—	—	Black/Orange 106H <sup>®</sup> (2)	Yellow 62 (1)	Black 106H <sup>®</sup> (2)	Yellow 62 (1)
—	—	—	—	Black/Orange 106H <sup>®</sup> (2)	Blue 76H <sup>®</sup> (2)	Black 106H <sup>®</sup> (2)	Blue 76 (1)
—	—	—	—	Black/Orange 106H <sup>®</sup> (2)	Brown 87H <sup>®</sup> (2)	Black 106H <sup>®</sup> (2)	Brown 87H <sup>®</sup> (2)
—	—	—	—	Black/Orange 106H <sup>®</sup> (2)	Pink 99H (2)	Black 106H <sup>®</sup> (2)	Pink 99H (2)
—	—	—	—	Black/Orange 106H <sup>®</sup> (2)	Black/Orange 106H <sup>®</sup> (2)	Black 106H <sup>®</sup> (2)	Black 106H <sup>®</sup> (2)
—	—	—	—	—	—	—	—
—	—	—	—	—	—	—	—

®Half width dies.

For Panduit tooling, see pages D3.76 – D3.77  
For Burndy tooling, see pages D3.78 – D3.79

A.  
System  
Overview

B1.  
Cable Ties

B2.  
Cable  
Accessories

B3.  
Stainless  
Steel Ties

C1.  
Wiring  
Duct

C2.  
Surface  
Raceway

C3.  
Abrasion  
Protection

C4.  
Cable  
Management

D1.  
Terminals

D2.  
Power  
Connectors

D3.  
Grounding  
Connectors

E1.  
Labeling  
Systems

E2.  
Labels

E3.  
Pre-Printed  
& Write-On  
Markers

E4.  
Permanent  
Identification

E5.  
Lockout/  
Tagout  
& Safety  
Solutions

F.  
Index

A. System Overview

B1. Cable Ties

B2. Cable Accessories

B3. Stainless Steel Ties

C1. Wiring Duct

C2. Surface Raceway

C3. Abrasion Protection

C4. Cable Management

D1. Terminals

D2. Power Connectors

D3. Grounding Connectors

E1. Labeling Systems

E2. Labels

E3. Pre-Printed & Write-On Markers

E4. Permanent Identification

E5. Lockout/Tagout & Safety Solutions

F. Index

**For use with Copper Conductors**

## Installation Tooling and Die Selections for: Type PSC

### How to read this chart

For PSCBRN-L parallel splice and CT-2001 crimping tool:

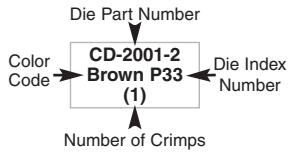

### Panduit Crimping Tool Part Number (See Compression Connector Tools Selection Guide, pages D3.34 – D3.36)

Panduit Splice Part Number	Wire Strip Length (In.)	Uni-Die™ Dieless CT-980, CT-980CH, CT-2950, CT-2980, CT-2980/L, CT-2980/LE, CT-2981	CT-2001, CT-2001/L, CT-2001/LE, CT-2002, CT-2002/L, CT-3001, CT-3001/E	CT-920, CT-930, CT-2940*, CT-2940/L*, CT-2940/LE*, CT-920CH, CT-930CH, CT-940CH*, CT-2920, CT-2930, CT-2930/L, CT-2930/LE, CT-2931
		Die Part Number/Color Code and Die Index Number/(Number of Crimps)		
PSCRED-L	7/16	—	CD-2001-8 Red P21 (1)	CD-920-8 Red P21 (1)
PSCBLU-L	7/16	—	CD-2001-6 Blue P24 (1)	CD-920-6 Blue P24 (1)
PSCGRY-L	7/16	(1)	CD-2001-4 Gray P29 (1)	CD-920-4 Gray P29 (1)
PSCBRN-L	11/16	(1)	CD-2001-2 Brown P33 (1)	CD-920-2 Brown P33 (1)
PSCGRN-L	11/16	(1)	CD-2001-1 Green P37 (1)	CD-920-1 Green P37 (1)
PSCPNK-L	11/16	(1)	CD-2001-1/0 Pink P42 (1)	CD-920-1/0 Pink P42 (1)
PSCBLK-Q	7/8	(1)	CD-2001-2/0 Black P45 (1)	CD-920-2/0 Black P45 (1)
PSCORG-Q	7/8	(1)	CD-2001-3/0 Orange P50 (1)	CD-920-3/0 Orange P50 (1)
PSCPUR-Q	1	(1)	CD-2001-4/0 Purple P54 (1)	CD-920-4/0 Purple P54 (1)
PSCYEL-Q	1 1/16	(1)	CD-2001-250 Yellow P62 (1)	CD-920-250 Yellow P62 (1)

\*CD-920 dies can be used with CT-940CH and CT-2940 tools with the CD-940-DA die adapter.

For use with  
Copper  
Conductors

## Installation Tooling and Die Selections for: Types LCMA, LCMD, and SCMS

### How to read this chart

For LCMA16  
lug and CT-2001  
crimping tool:

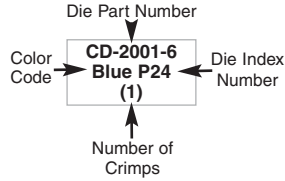

Panduit Tool P/N	
Die Part Number/Color Code and Die Index Number (Number of Crimps)	
CT-2001, CT-2001/L, CT-2001/LE, CT-2002, CT-2002/L, CT-3001, CT-3001/E	CT-930LPCH***, CT-920, CT-920CH, CT-2931, CT-2920, CT-930, CT-930CH, CT-2930, CT-2930/L, CT-2930/LE, CT-940CH*, CT-2940*, CT-2940/L*, CT-2940/LE*
—	—
CD-2001-8 Red P21 (1)	CD-920-8 Red P21 (1)
CD-2001-6 Blue P24 (1)	CD-920-6 Blue P24 (1)
CD-2001-4 Gray P29 (1)	CD-920-4 Gray P29 (1)
CD-2001-4 Gray P29 (1)	CD-920-4 Gray P29 (1)
CD-2001-1 Green P37 (1)	CD-920-1 Green P37 (1)
CD-2001-2/0 Black P45 (2)	CD-920-2/0 Black P45 (2)
CD-2001-4/0 Purple P54 (2)	CD-920-4/0 Purple P54 (2)
CD-2001-250 Yellow P62 (2)	CD-920-250 Yellow P62 (2)
CD-2001-300 White P66 (2)	CD-920-300 White P66 (2)
CD-2001-400 Blue P76 (2)	CD-920-400 Blue P76 (2)
CD-2001-500 Brown P87 (2)	CD-920-500 Brown P87 (2)
—	CD-920-600 Green P94 (2)
—	CD-920-750 CD-940-750** Black P106(2)
—	CD-940-1000** White P125 (3)
—	CD-940-1000** White P125 (4)

Panduit Part Number	Wire Size	Wire Type	Wire Strip Length (mm)	Current Rating	CT-100, CT-200, CT-1570 (Manual)	CT-600 (Air)	CT-1701 (Manual)
LCMA6, LCMD6	4-6mm <sup>2</sup>	Class 2R	11.0 11.0	30A	22-10 (1)	CT-570CH 12-10 (1)	P10 (1)
LCMA10, LCMD10, SCMS10	10mm <sup>2</sup>	Class 2R	12.5 12.5 16.5	— — 50A	—	—	—
LCMA16, LCMD16, SCMS16	16mm <sup>2</sup>	Class 2R	16.0 16.0 19.0	65A	—	—	—
LCMA25, LCMD25, SCMS25	25mm <sup>2</sup>	Class 2R	16.5 16.5 19.5	—	—	—	—
LCMA35, LCMD35, SCMS35	35mm <sup>2</sup>	Class 2R	19.0 19.0 19.5	—	—	—	—
LCMA50, LCMD50, SCMS50	50mm <sup>2</sup>	Class 2R	21.8 21.8 26.0	—	—	—	—
LCMA70, LCMD70, SCMS70	70mm <sup>2</sup>	Class 2R	24.8 24.8 27.5	—	—	—	—
LCMA95, LCMD95, SCMS95	95mm <sup>2</sup>	Class 2R	26.0 26.0 28.5	—	—	—	—
LCMA120, LCMD120, SCMS120	120mm <sup>2</sup>	Class 2R	26.0 26.0 30.0	—	—	—	—
LCMA150, LCMD150, SCMS150	150mm <sup>2</sup>	Class 2R	29.0 29.0 30.0	—	—	—	—
LCMA185, LCMD185, SCMS185	185mm <sup>2</sup>	Class 2R	29.7 29.7 32.0	—	—	—	—
LCMA240, LCMD240, SCMS240	240mm <sup>2</sup>	Class 2R	36.5 36.5 37.5	—	—	—	—
LCMA300, LCMD300, SCMS300	300mm <sup>2</sup>	Class 2R	41.8 41.8 39.0	—	—	—	—
LCMA400, LCMD400, SCMS400	400mm <sup>2</sup>	Class 2R	46.3 46.3 49.0	—	—	—	—
LCMA500, LCMD500, SCMS500	500mm <sup>2</sup>	Class 2R	48.0 48.0 49.5	—	—	—	—
LCMA630, LCMD630, SCMS630	630mm <sup>2</sup>	Class 2R	57.7 57.7 67.0	—	—	—	—

\*CD-920 dies can be used with CT-940CH and CT-2940 tools with CD-940-DA adapter.

\*\*CD-940 dies to be used exclusively with CT-940CH and CT-2940 tools.

\*\*\*Maximum size: 120mm lugs and splices.

A.  
System  
Overview

B1.  
Cable Ties

B2.  
Cable  
Accessories

B3.  
Stainless  
Steel Ties

C1.  
Wiring  
Duct

C2.  
Surface  
Raceway

C3.  
Abrasion  
Protection

C4.  
Cable  
Management

D1.  
Terminals

D2.  
Power  
Connectors

D3.  
Grounding  
Connectors

E1.  
Labeling  
Systems

E2.  
Labels

E3.  
Pre-Printed  
& Write-On  
Markers

E4.  
Permanent  
Identification

E5.  
Lockout/  
Tagout  
& Safety  
Solutions

F.  
Index

A. System Overview

B1. Cable Ties

B2. Cable Accessories

B3. Stainless Steel Ties

C1. Wiring Duct

C2. Surface Raceway

C3. Abrasion Protection

C4. Cable Management

D1. Terminals

D2. Power Connectors

D3. Grounding Connectors

E1. Labeling Systems

E2. Labels

E3. Pre-Printed & Write-On Markers

E4. Permanent Identification

E5. Lockout/Tagout & Safety Solutions

F. Index

**For use with Copper or Aluminum Conductors**

## Installation Tooling and Die Selections for: Types LAA, LAB, and SA

### How to read this chart

For LAA6 and CT-2931 crimping tool:

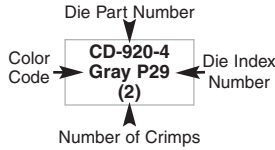

### Panduit (See Compression Connector Tools Selection Guide, Pages D3.34 – D3.36)

Panduit Part Number L = Lug S = Splice	Std. Wire Size	Wire Strip Length (In.)	Panduit (See Compression Connector Tools Selection Guide, Pages D3.34 – D3.36)		
			CT-1700 <sup>①</sup>	CT-720	CT-930, CT-930CH, CT-920, CT-920CH, CT-2920, CT-2930, CT-2930/L, CT-2930/LE, CT-2931, CT-2940 <sup>②</sup> , CT-2940/L <sup>③</sup> , CT-2940/LE <sup>③</sup> , CT-940CH <sup>③</sup>
Die Part Number/Color Code and Die Index Number/(Number Of Crimps)					
LAA6	#6 AWG	1	Gray P29 (5)	CD-720-1 Gray P29 (2)	CD-920-4 Gray P29 (2)
SA6		3/4			
LAA4	#4 AWG	1-1/16	Green P37 (5)	CD-720-2 Green P37 (2)	CD-920-1 Green P37 (2)
SA4		7/8			
LAA2	#2 AWG	1	—	CD-720-2 Pink P42 (2)	CD-920-1/0 Pink P42 (2)
SA2		7/16			
LAA1	#1 AWG	1	—	CD-720-2 Gold P45 (3)	CD-920-2/0 Gold P45 (2)
SA1		7/16			
LAA1/0	1/0 AWG	1-9/16	—	CD-720-2 Tan P50 (3)	CD-920-3/0 Tan P50 (2)
LAB1/0					
SA1/0		1			
LAA2/0	2/0 AWG	1-9/16	—	CD-720-3 Olive P54 (3)	CD-920-4/0 Olive P54 (2)
LAB2/0					
SA2/0		1-1/8			
LAA3/0	3/0 AWG	1-9/16	—	CD-720-3 Ruby P60 (4)	CD-920-250 Ruby P60 (2)
LAB3/0					
SA3/0		1-1/4			
LAA4/0	4/0 AWG	1-3/4	—	CD-720-4 White P66 (4)	CD-920-300 White P66 (2)
LAB4/0					
SA4/0		1-5/16			
LAA250	250 kcmil	1-3/4	—	CD-720-5 Red P71 (4)	CD-920-350 Red P71 (2)
LAB250					
SA250		1-7/16			
LAA300	300 kcmil	2-5/16	—	CD-720-6 Blue P76 (4)	CD-920-400 Blue P76 (2)
LAB300					
SA300		1-1/2			
LAA350	350 kcmil	2-5/16	—	CD-720-7 Brown P87 (4)	CD-920-500 Brown P87 (2)
LAB350					
SA350		1-5/8			
LAA400	400 kcmil	2-9/16	—	—	CD-920-600 Green P94 (4)
LAB400					
SA400		1-13/16			
LAA500	500 kcmil	3-1/16	—	—	CD-920-500A Pink P99 (4)
LAB500					
SA500		1-7/8			
LAA600	600 kcmil	3-1/16	—	—	CD-920-750, CD-940-750 <sup>④</sup> Black P106 (4)
LAB600					
SA600		2			
LAA750	750 kcmil	3-7/16	—	—	CD-940-750A <sup>④</sup> Red P125 (4)
LAB750					
SA750		2-1/4			
LAA800	800 kcmil	3-7/16	—	—	CD-940-800A <sup>④</sup> Gray P140 (4)
LAB800					
SA800		2-5/16			
LAA1000	1000 kcmil	4-3/4	—	—	CD-940-1000A <sup>④</sup> Brown P161 (4)
LAB1000					
SA1000		2-9/16			

①The CT-1700 crimp die pockets are integrated into the tool frame.

②CD-920 dies can be used with CT-940CH and CT-2940 tools with CD-940-DA die adapter. Maximum size splice is 250 kcmil with CT-920, CT-920CH, and CT-2920 tools.

③CD-940 dies to be used exclusively with CT-940CH and CT-2940 tools.

For use with  
Copper or  
Aluminum  
Conductors

## Installation Tooling and Die Selections for: Types LAA, LAB, and SA (continued)

Panduit Part Number L = Lug S = Splice	Std. Wire Size	Wire Strip Length (In.)	Thomas & Betts			Burdny				Anderson
			TBM5	TBM8	TBM15, TBMISI, TBMISBSCR	MY29	Y35	Y39	Y45, Y46	VC8
			Die Part Number/Color Code and Die Index Number/(Number of Crimps)							
LAA6	#6 AWG	1	Gray 29	Gray 29	Gray 29	6AL	U6CABT Gray 346	U6CABT Gray 346	U6CABT Gray 346	STD
SA6		3/4	(2)	(2)	(2)	(1)	(1)	(1)	(1)	(1)
LAA4	#4 AWG	1-1/16	Green 37	Green 37	Green 37	4AL	U4CABT Green 375	U4CABT Green 375	U4CABT Green 375	STD
SA4		7/8	(2)	(2)	(2)	(1)	(1)	(1)	(1)	(1)
LAA2	#2 AWG	1	Pink 42	Pink 42	Pink 42	2AL	U2CABT Pink 348	U2CABT Pink 348	U2CABT Pink 348	STD
SA2		7/16	(3)	(3)	(2)	(1)	(2)	(2)	(2)	(1)
LAA1	#1 AWG	1	Gold 45	Gold 45	Gold 45	1AL	U1CART Gold 471	U1CART Gold 471	U1CART Gold 471	STD
SA1		7/16	(3)	(3)	(2)	(1)	(2)	(2)	(2)	(1)
LAA1/0	1/0 AWG	1-9/16	Tan 50	Tan 50	Tan 50	1/0AL	U25ART Tan 298	U25ART Tan 298	U25ART Tan 298	STD
LAB1/0		1	(3)	(3)	(2)	(1)	(2)	(2)	(2)	(2)
SA1/0										
LAA2/0	2/0 AWG	1-9/16	Olive 54	Olive 54	Olive 54	2/0AL	U26ART Olive 297	U26ART Olive 297	U26ART Olive 297	STD
LAB2/0		1-1/8	(3)	(3)	(3)	(2)	(2)	(2)	(2)	(2)
SA2/0										
LAA3/0	3/0 AWG	1-9/16	Ruby 60	Ruby 60	Ruby 60	3/0AL	U27ART Ruby 467	U27ART Ruby 467	U27ART Ruby 467	STD
LAB3/0		1-1/4	(4)	(4)	(2)	(2)	(2)	(2)	(2)	(2)
SA3/0										
LAA4/0	4/0 AWG	1-3/4	—	White 66	White 66	4/0AL	U28ART White 298	U28ART White 298	U28ART White 298	STD
LAB4/0		1-5/16			(4)	(2)	(2)	(2)	(2)	(2)
SA4/0										
LAA250	250 kcmil	1-3/4	—	Red 71	Red 71H <sup>®</sup>	—	U29ART Red 324	U29ART Red 324	U29ART Red 324	STD
LAB250		1-7/16			(4)	(4)		(2)	(2)	(2)
SA250										
LAA300	300 kcmil	2-5/16	—	Blue 76	Blue 76	—	U30ART Blue 470	U30ART Blue 470	U30ART Blue 470	STD
LAB300		1-1/2			(4)	(2)		(2)	(2)	(2)
SA300										
LAA350	350 kcmil	2-5/16	—	Brown 87	Brown 87H <sup>®</sup>	—	U31ART Brown 299	U31ART Brown 299	U31ART Brown 299	STD
LAB350		1-5/8			(4)	(4)		(2)	(2)	(2)
SA350										
LAA400	400 kcmil	2-9/16	—	—	Green 94H <sup>®</sup>	—	U32ART Green 472	U32ART Green 472	U32ART Green 472	—
LAB400		1-13/16			(4)		(4)	(4)	(4)	
SA400										
LAA500	500 kcmil	3-1/16	—	—	Pink 99H <sup>®</sup>	—	U34ART Pink 300	U34ART Pink 300	U34ART Pink 300	—
LAB500		1-7/8			(4)		(4)	(4)	(4)	
SA500										
LAA600	600 kcmil	3-1/16	—	—	Black 106	—	U36ART Black 473	U36ART Black 473	U36ART Black 473	—
LAB600		2			(3)		(4)	(4)	(4)	
SA600										
LAA750	750 kcmil	3-7/16	—	—	Yellow 115H <sup>®</sup>	—	—	S39ART Red 301	S39ART Red 301	—
LAB750		2-1/4			(4)			(4)	(4)	
SA750										
LAA800	800 kcmil	3-7/16	—	—	125H <sup>®</sup>	—	—	Gray 474	Gray 474	—
LAB800		2-5/16			(4)			(4)	(4)	
SA800										
LAA1000	1000 kcmil	4-3/4	—	—	161	—	—	S44ART Brown 302	S44ART Brown 302	—
LAB1000		2-9/16			(5)			(4)	(4)	
SA1000										

®Half width dies.

## Installation Tooling and Die Selections for: Type SAR

**For use with Copper or Aluminum Conductors**

### How to read this chart

For SAR2-4 splice and CT-2001 crimping tool:

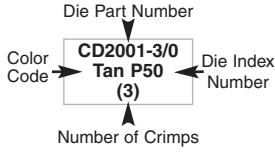

### Panduit (See Compression Connector Tools Selection Guide, Pages D3.34 – D3.36)

	CT-2001, CT-2001L, CT-2001/LE, CT-2002, CT-2002/L, CT-3001, CT-3001/E	CT-920, CT-920CH, CT-930, CT-930CH, CT-2930, CT-2930/L, CT-2930/LE, CT-2931, CT-930LPCH, CT-2920, CT-940CH <sup>②</sup> , CT-2940 <sup>②</sup> , CT-2940/L <sup>②</sup> , CT-2940/LE <sup>②</sup>	
CT-720	Die Part Number/Color Code and Die Index Number/ (Number Of Crimps)		
<b>SAR2-4</b>	CD-720-2 Tan P50 (3)	CD-2001-3/0 Tan P50 (3)	CD-920-3/0 Tan P50 (2)
<b>SAR1/0-2</b>	CD-720-2 Tan P50 (3)	CD-2001-3/0 Tan P50 (3)	CD-920-3/0 Tan P50 (2)
<b>SAR3/0-1/0</b>	CD-720-5 Red P71 (3)	CD-2001-350 Red P71 (4)	CD-920-350 Red P71 (2)
<b>SAR4/0-2/0</b>	CD-720-5 Red P71 (3)	CD-2001-350 Red P71 (4)	CD-920-350 Red P71 (2)
<b>SAR350-4/0</b>	CD-720-7 Brown P87 (4)	—	CD-920-500 Brown P87 (4)
<b>SAR500-350</b>	—	—	CD-920-500A Pink P99 (4)
<b>SAR600-500</b>	—	—	CD-920-750, CD-940-750 <sup>③</sup> Black P106 (4)
<b>SAR750-600</b>	—	—	CD-940-750 <sup>③</sup> Red P125 (4)

②CD-920 dies can be used with CT-940CH and CT-2940 tools with CD-940-DA die adapter. Maximum size splice is 250 kcmil with Panduit CT-920, CT-920CH and CT-2920 tools and Burndy Y35, Y35BH and BAT35 tools.

③CD-940 dies to be used exclusively with CT-940CH and CT-2940 tools.

Panduit Part Number	Aluminum Wire Size	Aluminum or Copper Wire Size	Wire Strip Length (both ends) (In.)
<b>SAR2-4</b>	#2 AWG	#4 AWG	2-1/16
<b>SAR1/0-2</b>	1/0 AWG	#2 AWG	2-1/16
<b>SAR3/0-1/0</b>	3/0 AWG	1/0 AWG	2-5/16
<b>SAR4/0-2/0</b>	4/0 AWG	2/0 AWG	2-3/16
<b>SAR350-4/0</b>	350 kcmil	4/0 AWG	3-3/16
<b>SAR500-350</b>	500 kcmil	350 kcmil	4-1/4
<b>SAR600-500</b>	600 kcmil	500 kcmil	4
<b>SAR750-600</b>	750 kcmil	600 kcmil	4-7/16

- A. System Overview
- B1. Cable Ties
- B2. Cable Accessories
- B3. Stainless Steel Ties
- C1. Wiring Duct
- C2. Surface Raceway
- C3. Abrasion Protection
- C4. Cable Management
- D1. Terminals
- D2. Power Connectors
- D3. Grounding Connectors
- E1. Labeling Systems
- E2. Labels
- E3. Pre-Printed & Write-On Markers
- E4. Permanent Identification
- E5. Lockout/Tagout & Safety Solutions
- F. Index



For use with  
Copper or  
Aluminum  
Conductors

## Installation Tooling and Die Selections for: Type SAR (continued)

Thomas & Betts			Burndy			Anderson
TBM5	TBM8	TBM15, TBM15I, TBM15BSCR	MY29	Y35, Y39, Y750, Y750-HS, BAT35, BAT750, PAT750, Y35BH, Y39BH, Y750BH, Y750-2, Y750BH-2	Y45, Y46	VC6
<b>Die Part Number/Color Code and Die Index Number/ (Number of Crimps)</b>						
Tan 50 (3)	Tan 50 (3)	Tan 50 (2)	1/0 AL (1)	U25ART Tan 296 (2)	U25ART Tan 296 (2)	STD (1)
Tan 50 (3)	Tan 50 (3)	Tan 50 (2)	1/0 AL (1)	U25ART Tan 296 (2)	U25ART Tan 296 (2)	STD (1)
—	Red 71 (4)	Red 71H <sup>①</sup> (4)	—	U29ART Red 324 (2)	U29ART Red 324 (2)	STD (2)
—	Red 71 (4)	Red 71H <sup>①</sup> (4)	—	U29ART Red 324 (2)	U29ART Red 324 (2)	STD (2)
—	Brown 87 (4)	Brown 87H <sup>①</sup> (4)	—	U31ART Brown 299 (2)	U31ART Brown 299 (2)	STD (2)
—	—	Pink 99H <sup>①</sup> (4)	—	U34ART Pink 300 (4)	U34ART Pink 300 (4)	—
—	—	Black 106 (3)	—	U36ART Black 473 (4)	U36ART Black 473 (4)	—
—	—	Yellow 115H <sup>①</sup> (4)	—	—	P39ART Red 301 (4)	—

①Half width dies.

A.  
System  
Overview

B1.  
Cable Ties

B2.  
Cable  
Accessories

B3.  
Stainless  
Steel Ties

C1.  
Wiring  
Duct

C2.  
Surface  
Raceway

C3.  
Abrasion  
Protection

C4.  
Cable  
Management

D1.  
Terminals

D2.  
Power  
Connectors

D3.  
Grounding  
Connectors

E1.  
Labeling  
Systems

E2.  
Labels

E3.  
Pre-Printed  
& Write-On  
Markers

E4.  
Permanent  
Identification

E5.  
Lockout/  
Tagout  
& Safety  
Solutions

F.  
Index

A. System Overview

B1. Cable Ties

B2. Cable Accessories

B3. Stainless Steel Ties

C1. Wiring Duct

C2. Surface Raceway

C3. Abrasion Protection

C4. Cable Management

D1. Terminals

D2. Power Connectors

D3. Grounding Connectors

E1. Labeling Systems

E2. Labels

E3. Pre-Printed & Write-On Markers

E4. Permanent Identification

E5. Lockout/Tagout & Safety Solutions

F. Index

**For use with Copper or Aluminum Conductors**

## Installation Tooling and Die Selections for: Type BPC

How to read this chart

For BPC6 connector and CT-2001 crimping tool:

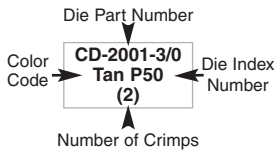

**Panduit (See Compression Connector Tools Selection Guide, Pages D3.34 – D3.36)**

**CT-2001, CT-2001/L, CT-2001/LE, CT-2002, CT-2002/L, CT-3001, CT-3001/E**

**CT-930, CT-930CH, CT-2930, CT-2930/L, CT-2930/LE, CT-2931, CT-920, CT-920CH, CT-2940<sup>②</sup>, CT-2940/L<sup>②</sup>, CT-2940/LE<sup>②</sup>, CT-2920, CT-940CH<sup>②</sup>**

Panduit Part Number	Standard Wire Size	Wire Strip Length (In.)	Die Part Number/Color Code and Die Index Number/(Number Of Crimps)		
			CT-720	CT-2001, CT-2001/L, CT-2001/LE, CT-2002, CT-2002/L, CT-3001, CT-3001/E	CT-930, CT-930CH, CT-2930, CT-2930/L, CT-2930/LE, CT-2931, CT-920, CT-920CH, CT-2940 <sup>②</sup> , CT-2940/L <sup>②</sup> , CT-2940/LE <sup>②</sup> , CT-2920, CT-940CH <sup>②</sup>
<b>BPC6</b>	#6 AWG	1-1/16	CD-720-2 Tan P50 (2)	CD-2001-3/0 Tan P50 (2)	CD-920-3/0 Tan P50 (2)
<b>BPC4</b>	#4 AWG	1-1/16	CD-720-2 Tan P50 (2)	CD-2001-3/0 Tan P50 (2)	CD-920-3/0 Tan P50 (2)
<b>BPC2</b>	#2 AWG	1-1/16	CD-720-2 Tan P50 (2)	CD-2001-3/0 Tan P50 (2)	CD-920-3/0 Tan P50 (2)
<b>BPC1</b>	#1 AWG	1-1/16	CD-720-2 Tan P50 (2)	CD-2001-3/0 Tan P50 (2)	CD-920-3/0 Tan P50 (2)
<b>BPC1/0</b>	1/0 AWG	1-5/16	CD-720-5 Red P71 (2)	CD-2001-350 Red P71 (3)	CD-920-350 Red P71 (2)
<b>BPC2/0</b>	2/0 AWG	1-5/16	CD-720-5 Red P71 (2)	CD-2001-350 Red P71 (3)	CD-920-350 Red P71 (2)
<b>BPC3/0</b>	3/0 AWG	1-5/16	CD-720-5 Red P71 (2)	CD-2001-350 Red P71 (3)	CD-920-350 Red P71 (2)
<b>BPC4/0</b>	4/0 AWG	1-5/16	CD-720-5 Red P71 (2)	CD-2001-350 Red P71 (3)	CD-920-350 Red P71 (2)
<b>BPC250</b>	250 kcmil	1-7/16	—	—	CD-920-600 Green P94 (2)
<b>BPC300</b>	300 kcmil	1-7/16	—	—	CD-920-600 Green P94 (2)
<b>BPC350</b>	350 kcmil	1-7/16	—	—	CD-920-600 Green P94 (2)
<b>BPC400</b>	400 kcmil	1-7/16	—	—	CD-920-750, CD-940-750 <sup>③</sup> Black P106 (2)
<b>BPC500</b>	500 kcmil	1-7/16	—	—	CD-920-750, CD-940-750 <sup>③</sup> Black P106 (2)
<b>BPC600</b>	600 kcmil	1-15/16	—	—	CD-940-750A <sup>③</sup> Red P125 (2)
<b>BPC750</b>	750 kcmil	1-15/16	—	—	CD-940-750A <sup>③</sup> Red P125 (2)

②CD-920 dies can be used with CT-940CH and CT-2940 tools with CD-940-DA die adapter. Maximum size splice is 250 kcmil with CT-920, CT-920CH, and CT-2920 tools.

③CD-940 dies to be used exclusively with CT-940CH and CT-2940 tools.

For use with  
Copper or  
Aluminum  
Conductors

## Installation Tooling and Die Selections for: Type BPC (continued)

Thomas & Betts			Burndy	
13642M	TBM8	TBM15, TBM15I, TBM15BSCR	Y35, BAT35	Y39, Y45, Y46, Y39BH
Die Part Number/Color Code and Die Index Number/(Number of Crimps)				
Orange 50 (2)	Tan 50 (2)	Orange 50 (2)	U25ART Tan 296 (2)	U25ART Tan 296 (2)
Orange 50 (2)	Tan 50 (2)	Orange 50 (2)	U25ART Tan 296 (2)	U25ART Tan 296 (2)
Orange 50 (2)	Tan 50 (2)	Orange 50 (2)	U25ART Tan 296 (2)	U25ART Tan 296 (2)
Orange 50 (2)	Tan 50 (2)	Orange 50 (2)	U25ART Tan 296 (2)	U25ART Tan 296 (2)
Blue 76H <sup>①</sup> (2)	Blue 76 (2)	Blue 76 (2)	U28ART White 298 (2)	U28ART White 298 (2)
Blue 76H <sup>①</sup> (2)	Blue 76 (2)	Blue 76 (2)	U28ART White 298 (2)	U28ART White 298 (2)
Blue 76H <sup>①</sup> (2)	Blue 76 (2)	Blue 76 (2)	U28ART White 298 (2)	U28ART White 298 (2)
Blue 76H <sup>①</sup> (2)	Blue 76 (2)	Blue 76 (2)	U28ART White 298 (2)	U28ART White 298 (2)
Pink 99H <sup>①</sup> (2)	Brown 87 (3)	Brown 87H <sup>①</sup> (2)	U31ART Brown 299 (2)	U31ART Brown 299 (2)
Pink 99H <sup>①</sup> (2)	Brown 87 (3)	Brown 87H <sup>①</sup> (2)	U31ART Brown 299 (2)	U31ART Brown 299 (2)
Pink 99H <sup>①</sup> (2)	Brown 87 (3)	Brown 87H <sup>①</sup> (2)	U31ART Brown 299 (2)	U31ART Brown 299 (2)
Black 106H <sup>①</sup> (3)	—	Black 106H <sup>①</sup> (3)	U34ART Pink 300 (3)	U34ART Pink 300 (3)
Black 106H <sup>①</sup> (3)	—	Black 106H <sup>①</sup> (3)	U34ART Pink 300 (3)	U34ART Pink 300 (3)
Yellow 115H <sup>①</sup> (3)	—	Yellow 115H <sup>①</sup> (3)	—	U39ART-2 Yellow 936 (3)
Yellow 115H <sup>①</sup> (3)	—	Yellow 115H <sup>①</sup> (3)	—	U39ART-2 Yellow 936 (3)

① Half width dies.

A.  
System  
Overview

B1.  
Cable Ties

B2.  
Cable  
Accessories

B3.  
Stainless  
Steel Ties

C1.  
Wiring  
Duct

C2.  
Surface  
Raceway

C3.  
Abrasion  
Protection

C4.  
Cable  
Management

D1.  
Terminals

D2.  
Power  
Connectors

D3.  
Grounding  
Connectors

E1.  
Labeling  
Systems

E2.  
Labels

E3.  
Pre-Printed  
& Write-On  
Markers

E4.  
Permanent  
Identification

E5.  
Lockout/  
Tagout  
& Safety  
Solutions

F.  
Index

A. System Overview

B1. Cable Ties

B2. Cable Accessories

B3. Stainless Steel Ties

C1. Wiring Duct

C2. Surface Raceway

C3. Abrasion Protection

C4. Cable Management

D1. Terminals

D2. Power Connectors

D3. Grounding Connectors

E1. Labeling Systems

E2. Labels

E3. Pre-Printed & Write-On Markers

E4. Permanent Identification

E5. Lockout/Tagout & Safety Solutions

F. Index

**For use with Copper Conductors**

## Installation Tooling and Die Selections for: Types GCE, GCC and GPC

### How to read this chart

For GCE250-1/0 and CT-2930 tool:



Installation Tools		
12 TON	14 TON	15 TON
<b>Panduit</b>		
CT-2931	CT-930 CT-930CH CT-2930 CT-2930/L CT-2930/LE	CT-940CH CT-2940 CT-2940/L CT-2940/LE
<b>Burndy</b>		
Y750, Y750-2, Y750BH, Y750BH-2, BAT750-14V, PAT750-18V, PAT750C-18V, PAT750XT-18V, PAT750CX-18V, LPHY750	—	Y46, Y46C, LPHY46
<b>Thomas &amp; Betts</b>		
	TBM14M, TBM14MC, 13100A, TBM14RH, TBM14BSCR, BPLT14BSCRI	TBM15 TBM15BSCR
Panduit Crimp Die Part Number/Color Code/Die Index Number/(Number of Crimps)		
CD-930G-1/0		
Red		
PG10		
(1)		
CD-930G-250		
Black		
PG25		
(1)		
CD-930G-250		
Black		
PG25		
(1)		
CD-930G-500		
Blue		
PG50		
(1)		
CD-930G-500		
Blue		
PG50		
(1)		

Panduit Part Number	Element	Copper Conductor Size Range	Ground Rod Size (In.)	Rebar Size (In.)
GCE1/0-1/0	Main	#6 AWG SOL – 1/0 AWG STR	—	—
	Tap	#6 AWG SOL – 1/0 AWG STR	—	—
GCC6X61/0-1/0	A	#6 AWG SOL – 1/0 AWG STR	—	—
	B	#6 AWG SOL – 1/0 AWG STR	—	—
GCE250-1/0	Main	1/0 AWG SOL – 250 kcmil	1/2 – 5/8	3/8 – 1/2, #3 – #4
	Tap	#6 AWG SOL – 1/0 AWG STR	—	—
GCC6X6250-1/0	A	#2 AWG SOL – 250 kcmil	1/2 – 5/8	3/8 – 1/2, #3 – #4
	B	#6 AWG SOL – 1/0 AWG STR	—	—
GCE250-250	Main	1/0 AWG SOL – 250 kcmil	1/2 – 5/8	3/8 – 1/2, #3 – #4
	Tap	1/0 AWG SOL – 250 kcmil	1/2 – 5/8	3/8 – 1/2, #3 – #4
GCE6X6250-250	A	#2 AWG SOL – 250 kcmil	1/2 – 5/8	3/8 – 1/2, #3 – #4
	B	#2 AWG SOL – 250 kcmil	1/2 – 5/8	3/8 – 1/2, #3 – #4
GPC4H250-2		#2 AWG SOL – 250 kcmil	—	—
GCE500-1/0	Main	250 – 500 kcmil	1/2 – 3/4	5/8 – 3/4, #5 – #6
	Tap	#6 AWG SOL – 1/0 AWG STR	—	—
GCC6X6500-1/0	A	250 – 500 kcmil	1/2 – 3/4	5/8 – 3/4, #5 – #6
	B	#6 AWG SOL – 1/0 AWG STR	—	—
GCE500-250	Main	250 – 500 kcmil	1/2 – 3/4	5/8 – 3/4, #5 – #6
	Tap	1/0 AWG SOL – 250 kcmil	—	—
GCC6X6500-250	A	250 – 500 kcmil	1/2 – 3/4	5/8 – 3/4, #5 – #6
	B	#2 AWG SOL – 250 kcmil	—	—

15 ton tools require the CD-940-DA adapter when used with CD-930G series crimping dies. Panduit crimping dies must be used with all tooling (Panduit and competitor).

**For use with  
Copper  
Conductors**

## Installation Tooling and Die Selections for: Type CTAP

**How to read  
this chart**

For  
CTAPF4-6 tap  
and CT-2001  
crimping tool:

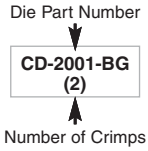

Panduit Part Number	Conductor Size		Wire Strip Length (In.)	Panduit		Burdny	
	Main	Tap		CT-920, CT-920CH, CT-930, CT-2920, CT-930CH, CT-2930, CT-2930/L, CT-2930/LE, CT-2931, CT-940CH <sup>①</sup> , CT-2940 <sup>①</sup> , CT-2940/L <sup>①</sup> , CT-2940/LE <sup>①</sup>	CT-2001, CT-2001/L, CT-2001/LE, CT-2002, CT-2002/L, CT-3001, CT-3001/E	MD6, MD7	BAT35, BAT750, PAT750, Y35, Y35BH, Y39, Y39BH, Y45, Y46, Y750, Y750HS, Y750BH
Crimp Die Number/Index Number or Color Code/(Number Of Crimps)							
CTAP4-8	#6 – #4 AWG SOL or STR	#8 AWG SOL or STR	3/4	CD-920-BG (1)	CD-2001-BG (1)	W-BG (1) BG (2)	U-BG (1)
CTAP4-6	#6 AWG STR, #4 AWG SOL or STR	#6 AWG SOL or STR	3/4	CD-920-BG (1)	CD-2001-BG (2)	W-BG (1) BG (2)	U-BG (1)
CTAP4-4	#4 AWG SOL or STR	#4 AWG STR	3/4	CD-920-BG (1)	CD-2001-BG (1)	W-BG (1) BG (2)	U-BG (1)
CTAP2-4	#2 AWG SOL or STR	#8 – #4 AWG SOL or STR	7/8	CD-920-C (1)	CD-2001-C (2)	W-C Brown (2)	U-C (1)
CTAP2-2	#2 AWG SOL or STR	#2 AWG SOL or STR	7/8	CD-920-C (1)	CD-2001-C (2)	W-C Brown (2)	U-C (1)
CTAP2/0-2	1/0 – 2/0 AWG	#8 – #2 AWG SOL or STR	1-1/16	CD-920-0 Green (1)	—	—	U-O (1) U-E (3)
CTAP2/0-2/0	1/0 – 2/0 AWG STR	1/0 – 2/0 AWG STR	1-1/16	CD-920-0 Green (1)	—	—	U-O (1) U-E (3)
CTAP4/0-2	3/0 – 4/0 AWG STR	#6 – #2 AWG SOL or STR	1-1/4	CD-920-D3 Blue (1)	—	—	U-F (2) U-D3 (1)
CTAP4/0-2/0	3/0 – 4/0 AWG STR	1/0 – 2/0 AWG STR	1-1/4	CD-920-D3 Blue (1)	—	—	U-F (2) U-D3 (1)
CTAP4/0-4/0	3/0 – 4/0 AWG STR	3/0 – 4/0 AWG STR	1-1/4	CD-920-D3 Blue (1)	—	—	U-F (2) U-D3 (1)

<sup>①</sup>CD-920 dies can be used with CT-940CH and CT-2940 tools with CD-940-DA adapter.

A.  
System  
Overview

B1.  
Cable  
Ties

B2.  
Cable  
Accessories

B3.  
Stainless  
Steel Ties

C1.  
Wiring  
Duct

C2.  
Surface  
Raceway

C3.  
Abrasion  
Protection

C4.  
Cable  
Management

D1.  
Terminals

D2.  
Power  
Connectors

D3.  
Grounding  
Connectors

E1.  
Labeling  
Systems

E2.  
Labels

E3.  
Pre-Printed  
& Write-On  
Markers

E4.  
Permanent  
Identification

E5.  
Lockout/  
Tagout  
& Safety  
Solutions

F.  
Index

A. System Overview

B1. Cable Ties

B2. Cable Accessories

B3. Stainless Steel Ties

C1. Wiring Duct

C2. Surface Raceway

C3. Abrasion Protection

C4. Cable Management

D1. Terminals

D2. Power Connectors

D3. Grounding Connectors

E1. Labeling Systems

E2. Labels

E3. Pre-Printed & Write-On Markers

E4. Permanent Identification

E5. Lockout/Tagout & Safety Solutions

F. Index

**For use with Copper Conductors**

## Installation Tooling and Die Selections for: Type CTAPF

### How to read this chart

For CTAPF6-12 tap and CT-2001 crimping tool:



Panduit Part Number	Stranded Wire Size		Panduit			
	Main	Tap	1700 <sup>①</sup>	CT-920, CT-920CH, CT-2920, CT-930, CT-930CH, CT-2930, CT-2930/L, CT-2930/LE, CT-2931, CT-940CH <sup>②</sup> , CT-2940 <sup>②</sup> , CT-2940/L <sup>②</sup> , CT-2940/LE <sup>②</sup>	CT-2001, CT-2001/L, CT-2001/LE, CT-2002, CT-2002/L, CT-3001, CT-3001E	
Die Part Number/Color Code and Die Index Number/ (Number of Crimps)						
<b>CTAPF10-16</b>	#14 AWG	#16 – #14 AWG	Red P21 (2)	—	—	CD-2001-8 Red P21 (1)
	#12 AWG	#16 – #12 AWG				
	#10 AWG	#14 AWG				
<b>CTAPF8-12</b>	#10 AWG	#10 AWG	Blue P24 (2)	—	—	CD-2001-6 Blue P24 (1)
	#8 AWG	#12 AWG				
<b>CTAPF6-12</b>	#8 AWG	#8 – #12 AWG	Gray P29 (2)	—	—	CD-2001-4 Gray P29 (1)
	#6 AWG	#12 – #10 AWG				
<b>CTAPF4-12</b>	#6 AWG	#8 – #6 AWG	Brown P33 (4)	CDM-920-2 Brown P33M (1)	CDM-2001-2 Brown P33M (1)	CD-2001-2 Brown P33 (2)
	#5, #4 AWG	#12 – #8 AWG				
<b>CTAPF3-12</b>	#5, #4 AWG	#6 – #5 AWG	Green P37 (4)	CDM-920-1 Green P37M (1)	CDM-2001-1 Green P37M (1)	CD-2001-1 Green P37 (2)
	#3 AWG	#12 – #6 AWG				
<b>CTAPF2-12</b>	#4 AWG	#4 AWG	—	CDM-920-1/0 Pink P42M (1)	CDM-2001-1/0 Pink P42M (1)	CD-2001-1/0 Pink P42 (2)
	#3 AWG	#5 AWG				
	#2 AWG	#12 – #6 AWG				
<b>CTAPF1-12</b>	#3 AWG	#4 – #3 AWG	—	CDM-920-2/0 Black P45M (1)	CDM-2001-2/0 Black P45M (2)	CD-2001-2/0 Black P45 (3)
	#2 AWG	#5 – #4 AWG				
	#1 AWG	#12 – #5 AWG				
<b>CTAPF1/0-12</b>	#2 AWG	#4 – #2 AWG	—	CDM-920-3/0 Orange P50M (1)	CDM-2001-3/0 Orange P50M (2)	CD-2001-3/0 Orange P50 (3)
	#1 AWG	#4 – #3 AWG				
	1/0 AWG	#12 – #4 AWG				
<b>CTAPF2/0-12</b>	#1 AWG	#2 – #1 AWG	—	CDM-920-4/0 Purple P54M (1)	—	CD-2001-4/0 Purple P54 (3)
	1/0 AWG	#3 – #2 AWG				
	2/0 AWG	#12 – #3 AWG				
<b>CTAPF3/0-12</b>	1/0 AWG	#1 – 1/0 AWG	—	CDM-920-250 Yellow P62M (1)	—	CD-2001-250 Yellow P62 (3)
	2/0 AWG	#2 – #1 AWG				
	3/0 AWG	#12 – #2 AWG				

①The CT-1700 crimp die pockets are integrated into the tool frame.  
 ②CDM-920 dies can be used with CT-940CH and CT-2940 tools with CD-940-DA adapter.

For use with  
Copper  
Conductors

## Installation Tooling and Die Selections for: Type CTAPF (continued)

Panduit Part Number	Stranded Wire Size		Burndy		Thomas & Betts
	Run	Tap	Y35, Y39, Y45, Y46, Y750BH-2 Y750, BAT35, BAT750, Y35BH, Y39BH, Y750BH, Y750HS, PAT750, Y750-2	Y500CT-HS, BCT500-HS, BCT500, Y500CT	TBM8-750, TBM8-750M-1, TBM8-750BSCR
			Die Part Number/Color Code and Die Index Number/ (Number of Crimps)		
CTAPF10-16	#14 AWG	#16 – #14 AWG	—	—	—
	#12 AWG	#16 – #12 AWG	—	—	—
	#10 AWG	#14 AWG	—	—	—
CTAPF8-12	#10 AWG	#10 AWG	—	—	—
	#8 AWG	#12 AWG	—	—	—
CTAPF6-12	#8 AWG	#8 – #12 AWG	—	—	—
	#6 AWG	#12 – #10 AWG	—	—	—
CTAPF4-12	#6 AWG	#8 – #6 AWG	UC4 Brown 10M (1)	WC4 Brown 10M (1)	TBM8-750C20 (1)
	#5, #4 AWG	#12 – #8 AWG	—	—	—
CTAPF3-12	#5, #4 AWG	#6 – #5 AWG	—	—	TBM8-750C2530 (1)
	#3 AWG	#12 – #6 AWG	—	—	—
CTAPF2-12	#4 AWG	#4 AWG	UC2 Pink 12M (1)	WC2 Pink 12M (1)	TBM8-750C2530 (1)
	#3 AWG	#5 AWG	—	—	—
	#2 AWG	#12 – #6 AWG	—	—	—
CTAPF1-12	#3 AWG	#4 – #3 AWG	UC1 Black 13M (1)	WC1 Black 13M (2)	TBM8-750C3540 (1)
	#2 AWG	#5 – #4 AWG	—	—	—
	#1 AWG	#12 – #5 AWG	—	—	—
CTAPF1/0-12	#2 AWG	#4 – #2 AWG	UC25 Orange 14M (1)	WC25 Orange 14M (2)	TBM8-750C3540 (1)
	#1 AWG	#4 – #3 AWG	—	—	—
	1/0 AWG	#12 – #4 AWG	—	—	—
CTAPF2/0-12	#1 AWG	#2 – #1 AWG	—	—	TBM8-750C4550 (1)
	1/0 AWG	#3 – #2 AWG	—	—	—
CTAPF3/0-12	2/0 AWG	#12 – #3 AWG	—	—	—
	1/0 AWG	#1 – 1/0 AWG	—	—	TBM8-750C4550 (1)
	2/0 AWG	#2 – #1 AWG	—	—	—
	3/0 AWG	#12 – #2 AWG	—	—	—

A.  
System  
Overview

B1.  
Cable Ties

B2.  
Cable  
Accessories

B3.  
Stainless  
Steel Ties

C1.  
Wiring  
Duct

C2.  
Surface  
Raceway

C3.  
Abrasion  
Protection

C4.  
Cable  
Management

D1.  
Terminals

D2.  
Power  
Connectors

D3.  
Grounding  
Connectors

E1.  
Labeling  
Systems

E2.  
Labels

E3.  
Pre-Printed  
& Write-On  
Markers

E4.  
Permanent  
Identification

E5.  
Lockout/  
Tagout  
& Safety  
Solutions

F.  
Index

A. System Overview

B1. Cable Ties

B2. Cable Accessories

B3. Stainless Steel Ties

C1. Wiring Duct

C2. Surface Raceway

C3. Abrasion Protection

C4. Cable Management

D1. Terminals

D2. Power Connectors

D3. Grounding Connectors

E1. Labeling Systems

E2. Labels

E3. Pre-Printed & Write-On Markers

E4. Permanent Identification

E5. Lockout/Tagout & Safety Solutions

F. Index

**For use with Copper Conductors**

## Installation Tooling and Die Selections for: Type HTCT

### How to read this chart

For HTCT6X-6X tap and CT-2931 crimping tool:

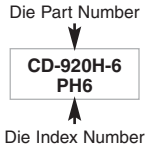

Installation Tools		
15 TON	14 TON	12 TON
<b>Panduit</b>		
CT-940CH <sup>①</sup> CT-2940 <sup>①</sup> CT-2940/L <sup>①</sup> CT-2940/LE <sup>①</sup>	CT-930, CT-930CH, CT-2930, CT-2930/L, CT-2930/LE	CT-920, CT-920CH, CT-2920, CT-2931, CT-2931/E
<b>Burndy</b>		
Y46 <sup>①</sup> Y46C <sup>①</sup>	—	Y35, Y35-2, Y35BH, Y35BH-4, Y750, Y39, Y39BH, Y750-2, Y750BH, Y750BH-2, Y750HS, BAT35, BAT750, BAT750C, PAT750, PAT750C
<b>Thomas &amp; Betts</b>		
TBM151, TBM15BSCR	TBM14M, TBM14BSCR, BPLT14BSCR, 13100A	—
<b>Panduit Crimp Die Part Number/Die Index Number (Number of Crimps = 1)</b>		
HTCT6X-6X	HTCT2-2	HTCT250-2
HTCT250-250		

Panduit Part Number	Copper Conductor Sizes (Code Cable)				Copper Conductor Sizes (Flex Cable) Types G, H, I, K, M and Locomotive (DLO)				Crimp Die Color Code
	Run	Tap 1	Tap 2	Tap 3	Main	Tap 1	Tap 2	Tap 3	
HTCT6X-6X	#6-#14 AWG	#6-#14 AWG	—	—	#6-#10 AWG	#6-#14 AWG	—	—	Orange
HTCT2-2	#2-#6 AWG	#2-#6 AWG	#8-#14 AWG	#8-#14 AWG	#2-#8 AWG	#2-#8 AWG	#8-#14 AWG	#8-#14 AWG	Brown
HTCT250-2	250 kcmil -#2 AWG	#2-#6 AWG	#8-#14 AWG	—	4/0-#2 AWG	#2-#8 AWG	#8-#14 AWG	—	Purple
HTCT250-250	250 kcmil -#2 AWG	250 kcmil -#2 AWG	—	—	4/0-#2 AWG	4/0-#2 AWG	—	—	Purple

①CD-920H and CD-930H dies can be used with CT-940CH and CT-2940 Panduit tools and Y46 and Y46C Burndy tools with CD-940-DA adapter. Panduit crimping dies must be used with all tooling (Panduit and competitor) to maintain UL/CSA certifications for applications up to 600 V.



# NOTES

A.  
System  
Overview

B1.  
Cable Ties

B2.  
Cable  
Accessories

B3.  
Stainless  
Steel Ties

C1.  
Wiring  
Duct

C2.  
Surface  
Raceway

C3.  
Abrasion  
Protection

C4.  
Cable  
Management

D1.  
Terminals

D2.  
Power  
Connectors

D3.  
Grounding  
Connectors

E1.  
Labeling  
Systems

E2.  
Labels

E3.  
Pre-Printed  
& Write-On  
Markers

E4.  
Permanent  
Identification

E5.  
Lockout/  
Tagout  
& Safety  
Solutions

F.  
Index

- A. System Overview
- B1. Cable Ties
- B2. Cable Accessories
- B3. Stainless Steel Ties
- C1. Wiring Duct
- C2. Surface Raceway
- C3. Abrasion Protection
- C4. Cable Management
- D1. Terminals
- D2. Power Connectors
- D3. Grounding Connectors
- E1. Labeling Systems
- E2. Labels
- E3. Pre-Printed & Write-On Markers
- E4. Permanent Identification
- E5. Lockout/Tagout & Safety Solutions
- F. Index

## LABELING SYSTEMS

Panduit is a global leader in reliable and innovative solutions for identification and safety. Products are engineered for a wide variety of industries and applications – including electrical, electronics, industrial and network. Panduit provides enhanced productivity, reliability, and value with leading-edge software development, materials and equipment by designing and manufacturing a full line of labeling products, software and printers to assist you with your labeling requirements.



- World-class quality – ISO 9001 and ISO 14001
- High performance and reliability
- Wide variety of system solutions to meet the most demanding requirements
- Meet and exceed the requirements of UL, CSA, ISO, NEC and OSHA
- Strong service and support network – distributor partners, knowledgeable sales people, expert technical support and world-class customer service



Panduit provides a complete range of industrial products and tools – including hand-held labeling systems, desktop labeling systems, pre-printed labels and safety systems. Use Panduit for all your identification needs for wire and cable, electrical and electronic devices, agency compliance, workplace safety and more.



## PRINTERS: THERMAL TRANSFER DESKTOP AND HAND-HELD

Panduit desktop thermal transfer printers enable fast, high quality label production for all your identification requirements. Use Panduit labeling software and desktop thermal transfer printers to produce on demand identification solutions quickly and economically. Panduit hand-held printers are designed for flexibility. Programmed with advanced functionality, Panduit printers make custom labeling easy.



### Hand-Held Printers

- Create labels at remote job sites
- Provide crisp, clear, high quality thermal transfer print
- Easily identify moves, adds, or changes

### Desktop Printers

- Compatible with Panduit® Easy-Mark™ Labeling Software
- Provide crisp, clear, high quality thermal transfer print
- Compatible with WINDOWS^ based PC operating systems

Panduit printers and our wide variety of labels provide solutions for all your project labeling needs.

^WINDOWS is a registered trademark of Microsoft Corporation in the United States and/or other countries.

A.  
System  
Overview

B1.  
Cable Ties

B2.  
Cable  
Accessories

B3.  
Stainless  
Steel Ties

C1.  
Wiring  
Duct

C2.  
Surface  
Raceway

C3.  
Abrasion  
Protection

C4.  
Cable  
Management

D1.  
Terminals

D2.  
Power  
Connectors

D3.  
Grounding  
Connectors

E1.  
Labeling  
Systems

E2.  
Labels

E3.  
Pre-Printed  
& Write-On  
Markers

E4.  
Permanent  
Identification

E5.  
Lockout/  
Tagout  
& Safety  
Solutions

F.  
Index

A. System Overview

## PanTher™ LS8E Hand-Held Thermal Transfer Printer and Accessories

- Cut-to-length functionality eliminates label waste and label trimming labor
- Partial cut feature available to provide tear-apart strips of labels
- P1™ Label Cassette contains an integrated memory device for automatic formatting, recall of last legend used, and number of labels remaining in the cassette
- Market specific labeling tools simplify label creation for electrical components, panel building, and construction and maintenance
- USB interface for importing data, system upgrades, and printing from a wireless laptop or desktop computer
- Prints self-laminating labels, heat shrink tubing, die-cut component labels and continuous tapes
- Fast loading label cassette includes both label material and ribbon to make changing labels easy
- Large graphic display with backlight for improved visibility

B1. Cable Ties

B2. Cable Accessories

B3. Stainless Steel Ties

C1. Wiring Duct

C2. Surface Raceway

C3. Abrasion Protection

C4. Cable Management

D1. Terminals

D2. Power Connectors

D3. Grounding Connectors



LS8E-KIT



LS8EQ

Part Number	Part Description	Std. Pkg. Qty.
<b>LS8EQ-KIT-ACS</b>	Includes LS8EQ printer with QWERTY keypad, one cassette of S100X150VAC self-laminating labels, six AA alkaline batteries, LS8E-ACS, LS8-CASE, LS8-PCKIT, LS8-IB, LS8-WS, quick reference card and operator's manual.	1
<b>LS8EQ-KIT</b>	Includes LS8EQ printer with QWERTY keypad, one cassette of S100X150VAC self-laminating labels, six AA alkaline batteries, LS8-CASE, LS8-PCKIT, LS8-IB, LS8-WS, quick reference card and operator's manual.	1
<b>LS8EQ</b>	Includes LS8EQ printer with QWERTY keypad, one cassette of S100X150VAC self-laminating labels, six AA alkaline batteries and quick reference card.	1
<b>LS8E-KIT-ACS</b>	Includes LS8E printer, one cassette of S100X150VAC self-laminating labels, six AA alkaline batteries, LS8E-ACS, LS8-CASE, LS8-PCKIT, LS8-IB, LS8-WS, quick reference card and operator's manual.	1
<b>LS8E-KIT</b>	Includes LS8E printer, one cassette of S100X150VAC self-laminating labels, six AA alkaline batteries, LS8-CASE, LS8-PCKIT, LS8-IB, LS8-WS, quick reference card and operator's manual.	1
<b>LS8E</b>	Includes LS8E printer, one cassette of S100X150VAC self-laminating labels, six AA alkaline batteries and quick reference card.	1
<b>LS8E-ACS*</b>	120 VAC power adapter for North America.	1
<b>LS8-CASE</b>	Rigid carrying case.	1
<b>LS8-PCKIT</b>	Includes USB cable and PC interface software for importing data, system upgrades, or printing from a wireless laptop or desktop computer.	1
<b>LS8-IB</b>	Protective impact bumper.	1
<b>LS8-WS</b>	Wrist strap.	1
<b>LS8-CLN</b>	LS8/LS8E cleaning kit – contains bottle of cleaning solution with MSDS, cleaning pen, swabs, alcohol wipes and cleaning instructions.	1

\*Cannot be used to charge batteries.

Other adapters available, replace S with A (Australia), C (China), E (Europe) and U (UK).

## Cougar™ LS9 Hand-Held Thermal Transfer Printer and Accessories

- Economical identification system provides premium quality solutions at the lowest installed cost
- Cut-to-length functionality eliminates label waste and label trimming labor
- Partial cut feature available to provide tear-apart strips of labels
- P1™ Label Cassette contains an integrated memory device for automatic formatting, recall of last legend used, and number of labels remaining in the cassette
- Prints continuous military grade heat shrink tubing
- Prints a wide variety of continuous tapes for marking of wire marking, component labeling, and safety/facility identification
- Fast loading label cassette includes both label material and ribbon to make changing labels easy

E1. Labeling Systems

E2. Labels

E3. Pre-Printed & Write-On Markers

E4. Permanent Identification

E5. Lockout/Tagout & Safety Solutions

F. Index



LS9Q

Part Number	Part Description	Std. Pkg. Qty.
<b>LS9Q</b>	Includes LS9Q printer with QWERTY keypad, one cassette of T100X000C1C-BK continuous nylon cloth tape, six AA alkaline batteries and quick reference card.	1
<b>LS9</b>	Includes LS9 printer, one cassette of T100X000VPC-BK continuous vinyl tape, six AA alkaline batteries and quick reference card.	1
<b>LS9-ACS*</b>	120 VAC power adapter for North America.	1
<b>LS9-CASE</b>	Rigid carrying case.	1
<b>LS9-IB</b>	Protective impact bumper.	1
<b>LS9-WS</b>	Wrist strap.	1
<b>LS9-CLN</b>	Cleaning kit.	1

\*Cannot be used to charge batteries.

Other adapters available, replace S with A (Australia), C (China), E (Europe) and U (UK).

## PANDUIT® Hand-Held Thermal Transfer Printing Solutions



PanTher™ LS8E



Cougar™ LS9

Self-Laminating Labels	Page E1.3	
Die-Cut Vinyl Cloth Labels	Page E1.6	
Turn-Tell™ Labels	Page E1.6	
Marker Plates	Page E1.7	
Flag Labels	Page E1.7	
Die-Cut Heat Shrink Tubing	Page E1.9	
Die-Cut Component Labels	Page E1.10	
Vinyl Cloth Continuous Tapes	Page E1.5	Page E1.5
Nylon Cloth Continuous Tapes	Page E1.5	Page E1.5
Continuous Heat Shrink Tubing	Page E1.8	Page E1.8
Continuous Tapes	Page E1.11	Page E1.11
Continuous Reflective Tapes	Page E1.12	Page E1.12

### P1™ Self-Laminating Label Cassettes for PanTher™ LS8E Hand-Held Thermal Transfer Printer

- P1™ Label Cassette contains an integrated memory device for automatic formatting, recall of last legend used, and number of labels remaining in the cassette
- Fast loading label cassette includes both label material and ribbon to make changing labels easy
- Self-laminating adhesive labels for wire/cable identification include a colored print-on area and clear overlamine
- Labels are available in a large range of wire/cable sizes



### Part Number System for Wire/Cable Labeling

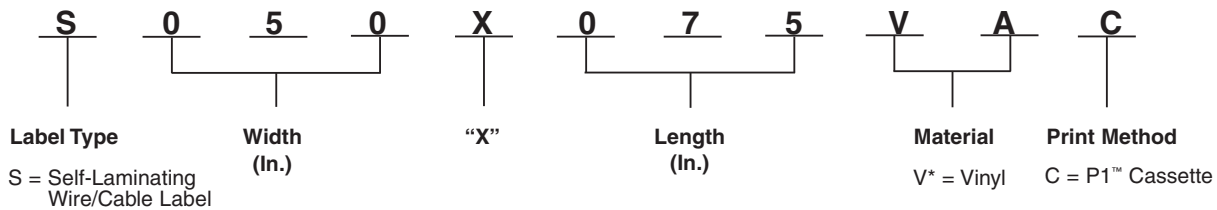

### Material/Print Method Selection Chart

Material	Print Method	Temperature Range	Features
Self-Laminating Vinyl, White Print-On (V*)	P1™ Cassette	-50°F to 225°F (-45°C to 107°C)	Indoor/outdoor rated; thin and conformable; preferred material for most general wire/cable labeling.

Table continues on page E1.4

A.  
System  
Overview

## P1™ Self-Laminating Label Cassettes for PanTher™ LS8E Hand-Held Thermal Transfer Printer (continued)

B1.  
Cable Ties

B2.  
Cable  
Accessories

B3.  
Stainless  
Steel Ties

C1.  
Wiring  
Duct

C2.  
Surface  
Raceway

C3.  
Abrasion  
Protection

C4.  
Cable  
Management

D1.  
Terminals

D2.  
Power  
Connectors

D3.  
Grounding  
Connectors

E1.  
Labeling  
Systems

E2.  
Labels

E3.  
Pre-Printed  
& Write-On  
Markers

E4.  
Permanent  
Identification

E5.  
Lockout/  
Tagout  
& Safety  
Solutions

F.  
Index

Part Number	Part Description	Width		Length		Print-On Height		Min. Cable O.D.		Max. Cable O.D.		Std. Pkg. Qty.	Std. Ctn. Qty.
		In.	mm	In.	mm	In.	mm	In.	mm	In.	mm		
<b>S050X075VAC</b>	White print-on area, vinyl label for 18 – 14 AWG wires, 450/cassette.	.50	12.70	0.75	19.05	0.25	6.35	0.08	2.02	0.16	4.04	1	10
<b>S050X125VAC</b>	White print-on area, vinyl label for 12 – 10 AWG wires, 225/cassette.	.50	12.70	1.25	31.75	0.38	9.65	0.12	3.07	0.28	7.03	1	10
<b>S050X150VAC</b>	White print-on area, vinyl label for Cat. 5e/Cat. 6 cables, 200/cassette.	.50	12.70	1.50	38.10	0.50	12.70	0.16	4.04	0.32	8.09	1	10
<b>S075X075VAC</b>	White print-on area, vinyl label for 18 – 14 AWG wires, 350/cassette.	.75	19.05	0.75	19.05	0.25	6.35	0.08	2.02	0.16	4.04	1	10
<b>S075X100VAC</b>	White print-on area, vinyl label for 12 – 10 AWG wires, 275/cassette.	.75	19.05	1.00	25.40	0.38	9.65	0.12	3.05	0.20	5.08	1	10
<b>S075X125VAC</b>	White print-on area, vinyl label for 12 – 10 AWG wires, 225/cassette.	.75	19.05	1.25	31.75	0.38	9.65	0.12	3.07	0.28	7.03	1	10
<b>S075X150VAC</b>	White print-on area, vinyl label for Cat. 5e/Cat. 6 cables, 200/cassette.	.75	19.05	1.50	38.10	0.50	12.70	0.16	4.04	0.32	8.09	1	10
<b>S100X075VAC</b>	White print-on area, vinyl label for 18 – 14 AWG wires, 350/cassette.	1.00	25.40	0.75	19.05	0.25	6.35	0.08	2.02	0.16	4.04	1	10
<b>S100X125VAC</b>	White print-on area, vinyl label for 12 – 10 AWG wires, 225/cassette.	1.00	25.40	1.25	31.75	0.38	9.65	0.12	3.07	0.28	7.03	1	10
<b>S100X150VAC</b>	White print-on area, vinyl label for Cat. 5e/Cat. 6 cables, 200/cassette.	1.00	25.40	1.50	38.10	0.50	12.70	0.16	4.04	0.32	8.09	1	10
<b>S100X150VBC</b>	Blue print-on area, vinyl label for Cat. 5e/Cat. 6 cables, 200/cassette.	1.00	25.40	1.50	38.10	0.50	12.70	0.16	4.04	0.32	8.09	1	10
<b>S100X150VDC</b>	Green print-on area, vinyl label for Cat. 5e/Cat. 6 cables, 200/cassette.	1.00	25.40	1.50	38.10	0.50	12.70	0.16	4.04	0.32	8.09	1	10
<b>S100X150VHC</b>	Red print-on area, vinyl label for Cat. 5e/Cat. 6 cables, 200/cassette.	1.00	25.40	1.50	38.10	0.50	12.70	0.16	4.04	0.32	8.09	1	10
<b>S100X150VIC</b>	Yellow print-on area, vinyl label for Cat. 5e/Cat. 6 cables, 200/cassette.	1.00	25.40	1.50	38.10	0.50	12.70	0.16	4.04	0.32	8.09	1	10
<b>S100X225VAC</b>	White print-on area, vinyl label for 8 – 4 AWG wires, 125/cassette.	1.00	25.40	2.25	57.15	0.75	19.05	0.24	6.06	0.48	12.19	1	10
<b>S100X225VBC</b>	Blue print-on area, vinyl label for 8 – 4 AWG wires, 125/cassette.	1.00	25.40	2.25	57.15	0.75	19.05	0.24	6.06	0.48	12.19	1	10
<b>S100X225VDC</b>	Green print-on area, vinyl label for 8 – 4 AWG wires, 125/cassette.	1.00	25.40	2.25	57.15	0.75	19.05	0.24	6.06	0.48	12.19	1	10
<b>S100X225VHC</b>	Red print-on area, vinyl label for 8 – 4 AWG wires, 125/cassette.	1.00	25.40	2.25	57.15	0.75	19.05	0.24	6.06	0.48	12.19	1	10
<b>S100X225VIC</b>	Yellow print-on area, vinyl label for 8 – 4 AWG wires, 125/cassette.	1.00	25.40	2.25	57.15	0.75	19.05	0.24	6.06	0.48	12.19	1	10
<b>S100X400VAC</b>	White print-on area, vinyl label for 2 – 1 AWG wires, 75/cassette.	1.00	25.40	4.00	101.60	1.00	25.40	0.32	8.09	0.95	24.26	1	10
<b>S100X650VAC</b>	White print-on area, vinyl label for 1/0 – 250 MCM wires, 50/cassette.	1.00	25.40	6.50	165.10	1.50	38.10	0.48	12.19	1.59	40.39	1	10

Order number of cassettes required.

Other colors available, replace A with B (Blue), D (Green), H (Red) and I (Yellow).

## P1™ Non-Laminated Label Cassettes

- P1™ Label Cassette contains an integrated memory device for automatic formatting, recall of last legend used, and number of labels remaining in the cassette

- Fast loading label cassette includes both label material and ribbon to make changing labels easy
- Non-laminated adhesive labels for wire/cable identification



## Part Number System for Wire/Cable Labeling

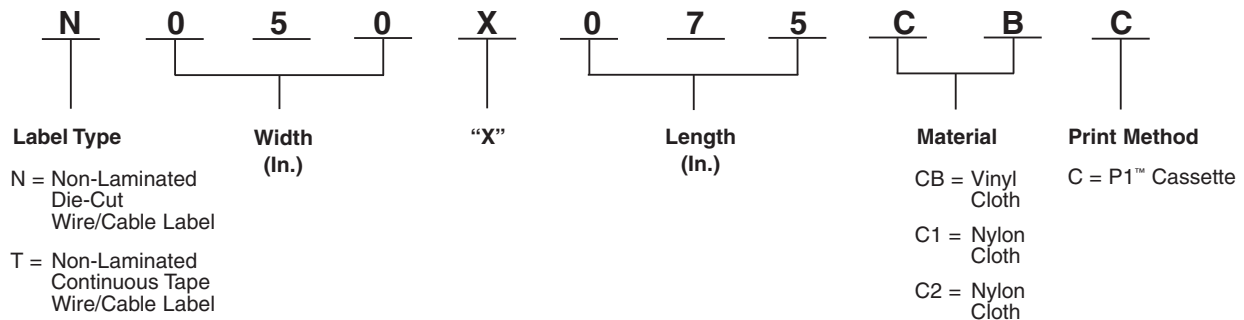

### Material/Print Method Selection Chart

Material	Print Method	Temperature Range	Features
Vinyl Cloth White Print-On (CB)	P1™ Cassette	50°F to 170°F (10°C to 77°C)	General purpose material, vinyl impregnated cloth resists oil and abrasion; material can be removed, repositioned, and reused.
Nylon Cloth White Print-On (C1) Yellow Print-On (C2)		-40°F to 285°F (-40°C to 140°C)	General purpose material for wire and cable marking as well as flat surfaces; superior legibility; not repositionable.

Part Number	Part Description	Height		Length		Std. Pkg. Qty.	Std. Ctn. Qty.
		In.	mm	Ft.	m		
<b>Continuous – For Use in PanTher™ LS8E and Cougar™ LS9 Hand-Held Thermal Transfer Printers</b>							
T050X000CBC-BK	Black on white, vinyl cloth tape.	0.50	12.7	12.5	3.8	1	10
T100X000CBC-BK	Black on white, vinyl cloth tape.	1.00	25.4	12.5	3.8	1	10
T038X000C1C-BK	Black on white, nylon cloth label tape.	0.38	9.7	18.0	5.5	1	10
T038X000C2C-BK	Black on yellow, nylon cloth label tape.	0.38	9.7	18.0	5.5	1	10
T050X000C1C-BK	Black on white, nylon cloth label tape.	0.50	12.7	18.0	5.5	1	10
T050X000C2C-BK	Black on yellow, nylon cloth label tape.	0.50	12.7	18.0	5.5	1	10
T075X000C1C-BK	Black on white, nylon cloth label tape.	0.75	19.1	18.0	5.5	1	10
T075X000C2C-BK	Black on yellow, nylon cloth label tape.	0.75	19.1	18.0	5.5	1	10
T100X000C1C-BK	Black on white, nylon cloth label tape.	1.00	25.4	18.0	5.5	1	10
T100X000C2C-BK	Black on yellow, nylon cloth label tape.	1.00	25.4	18.0	5.5	1	10

Table continues on page E1.6

A. System Overview

## P1™ Non-Laminated Label Cassettes (continued)

B1. Cable Ties

Part Number	Part Description	Width		Length		Min. Cable O.D.		Max. Cable O.D.		Std. Pkg. Qty.	Std. Ctn. Qty.
		In.	mm	In.	mm	In.	mm	In.	mm		
<b>Die-Cut – For Use in PanTher™ LS8E Hand-Held Thermal Transfer Printers</b>											
<b>N050X075CBC</b>	White, perforated vinyl cloth label for 18 – 14 AWG wires, 125/cassette.	.50	12.70	.75	19.05	.24	6.10	.51	12.95	1	10
<b>N050X150CBC</b>	White, perforated vinyl cloth label for Cat. 5e/Cat. 6 cable, 75/cassette.	.50	12.70	1.50	38.10	.48	12.19	1.02	25.91	1	10
<b>N100X125CBC</b>	White, perforated vinyl cloth label for 12 – 10 AWG wires, 75/cassette.	1.00	25.40	1.25	31.75	.40	10.16	.85	21.59	1	10
<b>N100X150CBC</b>	White, vinyl cloth label for Cat. 5e/Cat. 6 cable, 75/cassette.	1.00	25.40	1.50	38.10	.48	12.19	1.02	25.91	1	10
<b>N100X175CBC</b>	White, perforated vinyl cloth label for 8 – 4 AWG wires, 50/cassette.	1.00	25.40	1.75	44.45	.56	14.22	1.19	30.23	1	10

Order number of rolls required.

C2. Surface Raceway



## P1™ Turn-Tell™ Label Cassettes for PanTher™ LS8E Hand-Held Thermal Transfer Printer

C3. Abrasion Protection

- Fast loading P1™ Label Cassette includes both label material and ribbon to make changing labels easy
- Innovative label design allows labels to rotate for visibility from any angle, and for repositioning on the wire/cable to align legends and improve aesthetics

- Labels can be easily installed on existing terminated wires and assemblies without disconnecting the wires/cables
- Temperature range: -40°F to 200°F (-40°C to 93°C)

C4. Cable Management



D1. Terminals

D2. Power Connectors

D3. Grounding Connectors

## Part Number System for Wire/Cable Labeling

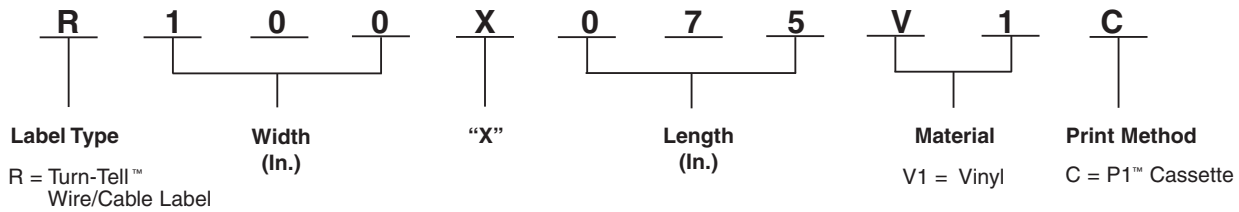

E1. Labeling Systems

E2. Labels

E3. Pre-Printed & Write-On Markers

E4. Permanent Identification

E5. Lockout/Tagout & Safety Solutions

Part Number	Part Description	Width		Length		Print-On Area Height		Min. Cable O.D.		Max. Wire O.D.		Std. Pkg. Qty.	Std. Ctn. Qty.
		In.	mm	In.	mm	In.	mm	In.	mm	In.	mm		
<b>R100X075V1C</b>	White print-on, 18 – 14 AWG wire/cable, 150/cassette.	1.00	25.4	0.75	19.1	0.25	6.4	0.12	3.1	0.16	4.1	1	10
<b>R100X125V1C</b>	White print-on, 12 – 10 AWG wire/cable, 100/cassette.	1.00	25.4	1.25	31.8	0.38	9.7	0.16	4.1	0.22	5.6	1	10
<b>R100X150V1C</b>	White print-on, Cat. 5/5e/6 cable, 100/cassette.	1.00	25.4	1.50	38.1	0.50	12.7	0.22	5.6	0.28	7.1	1	10
<b>R100X225V1C</b>	White print-on, 8 – 4 AWG wire/cable, 75/cassette.	1.00	25.4	2.25	57.2	0.75	19.1	0.28	7.1	0.39	9.9	1	10

Order number of cassettes required.

F. Index



## P1™ Marker Plate Label Cassettes for PanTher™ LS8E Hand-Held Thermal Transfer Printer

- Fast loading P1™ Label Cassette includes both label material and ribbon to make changing labels easy
- Marker plates are designed for use on larger diameter wire/cables and may be applied after all terminations are complete

- Meets requirements for MIL-STD-202F, Notice 12 Method 215J
- Temperature range: -40°F to 176°F (-40°C to 80°C)

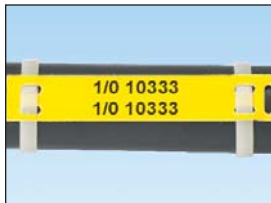

### Part Number System for Wire/Cable Labeling

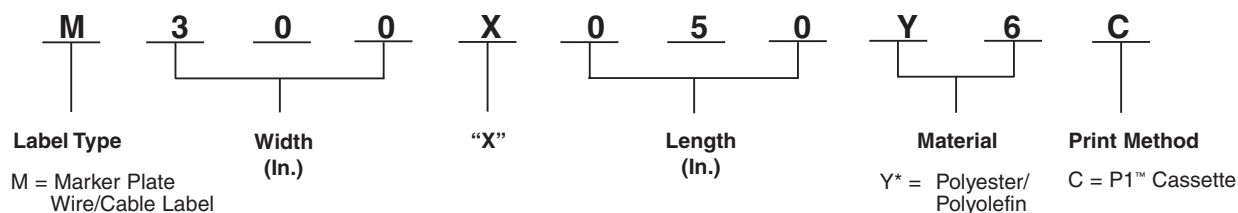

Part Number	Color	Width		Length		Print-On Area Width		Recommended Cable Tie		Std. Pkg. Qty.	Std. Ctn. Qty.
		In.	mm	In.	mm	In.	mm	Vertical	Horizontal		
M300X050Y6C	Yellow	3.00	76.2	0.50	12.7	1.80	45.7	PLT2.5I-C	PLT2.5I-C	1	10
M300X050Y7C	White	3.00	76.2	0.50	12.7	1.80	45.7	PLT2.5I-C	PLT2.5I-C	1	10

Order number of cassettes required.

## P1™ Flag Label Cassettes for PanTher™ LS8E Hand-Held Thermal Transfer Printer



- Fast loading P1™ Label Cassette includes both label material and ribbon to make changing labels easy
- Provides larger labeling area for small cables

- Innovative design allows flag labels to be applied in either adhesive or non-adhesive orientations
- Temperature range: -40°F to 302°F (-40°C to 150°C)



### Part Number System for Wire/Cable Labeling

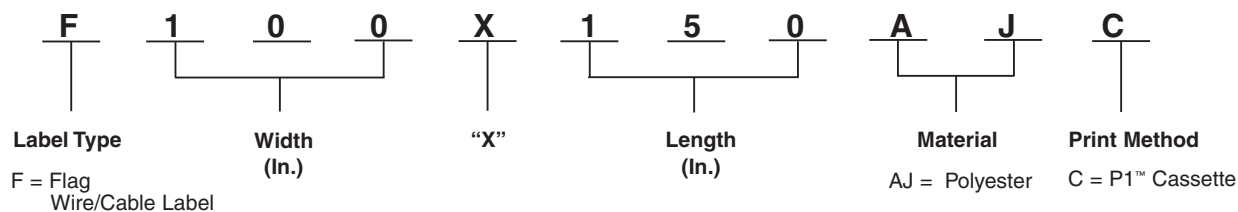

Part Number	Width		Length		Min. Cable O.D.		Max. Wire O.D.		Std. Pkg. Qty.	Std. Ctn. Qty.
	In.	mm	In.	mm	In.	mm	In.	mm		
F100X150AJC	1.00	25.4	1.50	38.1	0.12	3.1	0.20	5.1	1	10

Order number of cassettes required.

A. System Overview

## P1™ Military Grade Continuous Heat Shrink Label Cassettes for PanTher™ LS8E or Cougar™ LS9 Hand-Held Thermal Transfer Printers

B1. Cable Ties

- P1™ Label Cassette contains an integrated memory device for automatic formatting, recall of last legend used, and number of labels remaining in the cassette
- Fast loading label cassette includes both label material and ribbon to make changing labels easy

- Meets print performance requirements of MIL-M-81531 and MIL-STD-202F Method 215A, Solution A, C, and D
- Meets UL Standard 224 for flammability
- Shrink ratio 3:1
- Each cassette contains a continuous roll of non-adhesive flattened polyolefin that can be cut-to-length

B2. Cable Accessories

B3. Stainless Steel Ties



C1. Wiring Duct

C2. Surface Raceway

C3. Abrasion Protection

### Part Number System for Wire/Cable Labeling



C4. Cable Management

D1. Terminals

D2. Power Connectors

### Material/Print Method Selection Chart

Material	Print Method	Temperature Range	Features
Heat Shrinkable Polyolefin, White (H*)	P1™ Cassette	-67°F to 275°F (-55°C to 135°C)	Durable flattened polyolefin, high quality heat shrink wire/cable labels.

D3. Grounding Connectors

E1. Labeling Systems

E2. Labels

E3. Pre-Printed & Write-On Markers

E4. Permanent Identification

E5. Lockout/Tagout & Safety Solutions

F. Index

Part Number	Part Description	Width		Length		Min. Cable Diameter		Max. Cable Diameter		Std. Pkg. Qty.	Std. Ctn. Qty.
		In.	mm	Ft.	m	In.	mm	In.	mm		
<b>H000X025H1C</b>	White, 1/8" diameter heat shrinkable polyolefin, 22 – 16 AWG.	0.25	6.4	8.0	2.4	0.04	1.0	0.13	3.3	1	10
<b>H000X025H2C</b>	Yellow, 1/8" diameter heat shrinkable polyolefin, 22 – 16 AWG.	0.25	6.4	8.0	2.4	0.04	1.0	0.13	3.3	1	10
<b>H000X034H1C</b>	White, 3/16" diameter heat shrinkable polyolefin, 18 – 12 AWG.	0.34	8.6	8.0	2.4	0.06	1.5	0.19	4.8	1	10
<b>H000X034H2C</b>	Yellow, 3/16" diameter heat shrinkable polyolefin, 18 – 12 AWG.	0.34	8.6	8.0	2.4	0.06	1.5	0.19	4.8	1	10
<b>H000X044H1C</b>	White, 1/4" diameter heat shrinkable polyolefin, 16 – 10 AWG.	0.44	11.2	6.0	1.8	0.08	2.0	0.25	6.4	1	10
<b>H000X044H2C</b>	Yellow, 1/4" diameter heat shrinkable polyolefin, 16 – 10 AWG.	0.44	11.2	6.0	1.8	0.08	2.0	0.25	6.4	1	10
<b>H000X064H1C</b>	White, 3/8" diameter heat shrinkable polyolefin, 12 – 6 AWG.	0.64	16.3	6.0	1.8	0.13	3.3	0.38	9.7	1	10
<b>H000X064H2C</b>	Yellow, 3/8" diameter heat shrinkable polyolefin, 12 – 6 AWG.	0.64	16.3	6.0	1.8	0.13	3.3	0.38	9.7	1	10
<b>H000X084H1C</b>	White, 1/2" diameter heat shrinkable polyolefin, 8 – 1 AWG.	0.84	21.3	6.0	1.8	0.17	4.3	0.50	12.7	1	10
<b>H000X084H2C</b>	Yellow, 1/2" diameter heat shrinkable polyolefin, 8 – 1 AWG.	0.84	21.3	6.0	1.8	0.17	4.3	0.50	12.7	1	10

Order number of cassettes required.

## P1™ Military Grade Die-Cut Heat Shrink Label Cassettes for PanTher™ LS8E Hand-Held Thermal Transfer Printer

- P1™ Label Cassette contains an integrated memory device for automatic formatting, recall of last legend used, and number of labels remaining in the cassette
- Fast loading label cassette includes both label material and ribbon to make changing labels easy
- Meets print performance requirements of MIL-M-81531 and MIL-STD-202F Method 215A, Solution A, C, and D
- Meets UL Standard 224 for flammability
- Shrink ratio 3:1
- Each cassette contains a roll of die-cut non-adhesive flattened polyolefin



**LS8E**

### Part Number System for Wire/Cable Labeling

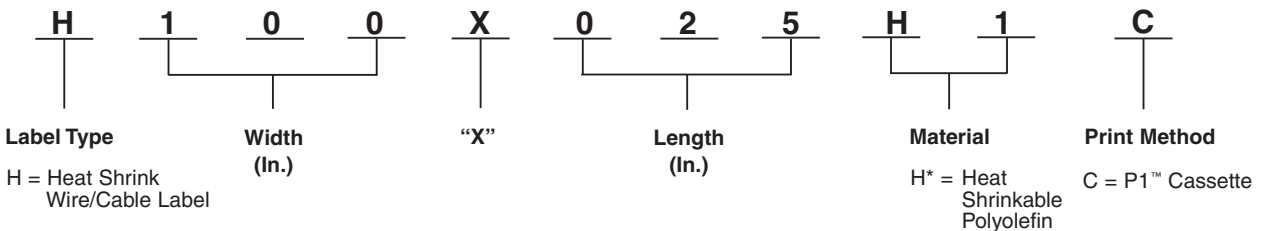

### Material/Print Method Selection Chart

Material	Print Method	Temperature Range	Features
Heat Shrinkable Polyolefin (H*)	P1™ Cassette	-67°F to 275°F (-55°C to 135°C)	Durable flattened polyolefin, high quality heat shrink wire/cable labels.

Part Number	Part Description	Width		Length		Min. Cable Diameter		Max. Cable Diameter		Std. Pkg. Qty.	Std. Ctn. Qty.
		In.	mm	In.	mm	In.	mm	In.	mm		
H100X025H1C	White, 1/8" diameter heat shrinkable polyolefin, 22 – 16 AWG, 100/cassette.	0.25	6.4	1.00	25.4	0.04	1.0	0.13	3.3	1	10
H100X025H2C	Yellow, 1/8" diameter heat shrinkable polyolefin, 22 – 16 AWG, 100/cassette.	0.25	6.4	1.00	25.4	0.04	1.0	0.13	3.3	1	10
H100X034H1C	White, 3/16" diameter heat shrinkable polyolefin, 18 – 12 AWG, 100/cassette.	0.34	8.6	1.00	25.4	0.06	1.5	0.19	4.8	1	10
H100X034H2C	Yellow, 3/16" diameter heat shrinkable polyolefin, 18 – 12 AWG, 100/cassette.	0.34	8.6	1.00	25.4	0.06	1.5	0.19	4.8	1	10
H100X044H1C	White, 1/4" diameter heat shrinkable polyolefin, 16 – 10 AWG, 100/cassette.	0.44	11.2	1.00	25.4	0.08	2.0	0.25	6.4	1	10
H100X044H2C	Yellow, 1/4" diameter heat shrinkable polyolefin, 16 – 10 AWG, 100/cassette.	0.44	11.2	1.00	25.4	0.08	2.0	0.25	6.4	1	10
H100X064H1C	White, 3/8" diameter heat shrinkable polyolefin, 12 – 6 AWG, 75/cassette.	0.64	16.3	1.00	25.4	0.13	3.3	0.38	9.7	1	10
H100X064H2C	Yellow, 3/8" diameter heat shrinkable polyolefin, 12 – 6 AWG, 75/cassette.	0.64	16.3	1.00	25.4	0.13	3.3	0.38	9.7	1	10
H100X084H1C	White, 1/2" diameter heat shrinkable polyolefin, 8 – 1 AWG, 75/cassette.	0.84	21.3	1.00	25.4	0.17	4.3	0.50	12.7	1	10
H100X084H2C	Yellow, 1/2" diameter heat shrinkable polyolefin, 8 – 1 AWG, 75/cassette.	0.84	21.3	1.00	25.4	0.17	4.3	0.50	12.7	1	10

Order number of cassettes required.

A. System Overview

## P1™ General Component Label Cassettes for PanTher™ LS8E Hand-Held Thermal Transfer Printers

B1. Cable Ties

- P1™ Label Cassette contains an integrated memory device for automatic formatting, recall of last legend used, and number of labels remaining in the cassette
- Fast loading label cassette includes both label material and ribbon to make changing labels easy

- Use for identifying flat surfaces such as components, control panels, circuit boards and general labeling
- Die-cut labels designed to provide maximum aesthetic quality and appearance
- Available in polyester and vinyl cloth materials

B2. Cable Accessories

B3. Stainless Steel Ties



C1. Wiring Duct

C2. Surface Raceway

C3. Abrasion Protection

### Part Number System for Component Labeling

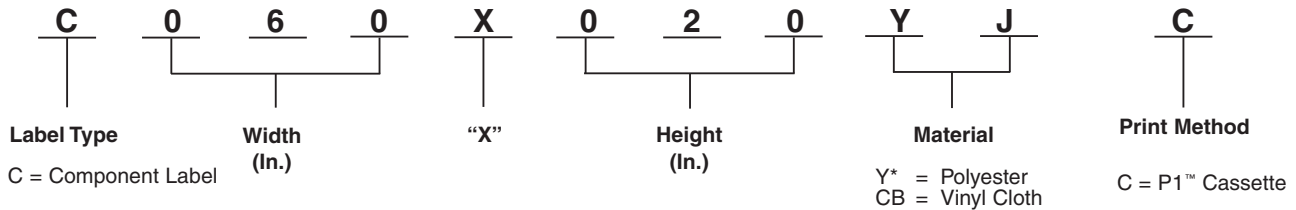

C4. Cable Management

D1. Terminals

D2. Power Connectors

### Material/Print Method Selection Chart

Material	Print Method	Temperature Range	Features
Polyester, White (YJ) Silver (YM) SuperTack Polyester, White (YP)	P1™ Cassette	-40°F to 302°F (-40°C to 150°C)	Indoor/outdoor rated; provides durability, high temperature resistance, and dimensional stability, does not stretch or easily tear.
Vinyl Cloth, White (CB)		-50°F to 170°F (10°C to 77°C)	General purpose material, vinyl impregnated cloth resists oil and abrasion; material can be removed, repositioned, and reused.

D3. Grounding Connectors

E1. Labeling Systems

E2. Labels

E3. Pre-Printed & Write-On Markers

E4. Permanent Identification

E5. Lockout/Tagout & Safety Solutions

Part Number	Part Description	Width		Height		Std. Pkg. Qty.	Std. Ctn. Qty.
		In.	mm	In.	mm		
<b>C060X020YJC</b>	White, polyester label, 750/cassette.	0.60	15.2	0.20	5.1	1	10
<b>C100X025YJC</b>	White, polyester label, 500/cassette.	1.00	25.4	0.25	6.4	1	10
<b>C100X050CBC</b>	White, vinyl cloth label, 175/cassette.	1.00	25.4	0.50	12.7	1	10
<b>C100X050YJC</b>	White, polyester label, 500/cassette.	1.00	25.4	0.50	12.7	1	10
<b>C100X050YMC</b>	Silver, polyester label, 500/cassette.	1.00	25.4	0.50	12.7	1	10
<b>C150X075YJC</b>	White, polyester label, 250/cassette.	1.50	38.1	0.75	19.1	1	10
<b>C200X050CBC</b>	White, vinyl cloth label, 50/cassette.	2.00	50.8	0.50	12.7	1	10
<b>C200X050YJC</b>	White, polyester label, 200/cassette.	2.00	50.8	0.50	12.7	1	10
<b>C200X100YJC</b>	White, polyester label, 200/cassette.	2.00	50.8	1.00	25.4	1	10
<b>C200X100YMC</b>	Silver, polyester label, 150/cassette.	2.00	50.8	1.00	25.4	1	10
<b>C200X100YPC</b>	White, high tack polyester label, 200/cassette.	2.00	50.8	1.00	25.4	1	10

Order number of cassettes required.

F. Index

## P1™ Continuous Tape Cassettes for PanTher™ LS8E and Cougar™ LS9 Hand-Held Thermal Transfer Printers

- P1™ Label Cassette contains an integrated memory device for automatic formatting, recall of last legend used, and number of labels remaining in the cassette
- Fast loading label cassette includes both label material and ribbon to make changing labels easy
- Print custom pipe markers, voltage markers, signs and bin marker labels on demand
- Available in a variety of colors, widths, and adhesive materials including continuous polyolefin, polyester, and vinyl
- For flat label applications only



### Part Number System for Continuous Tapes

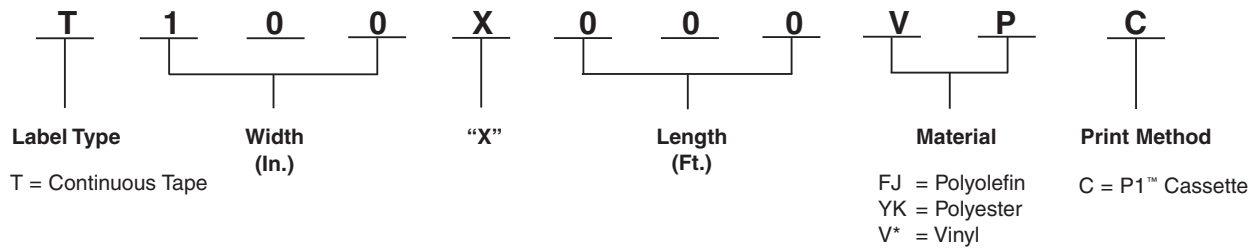

### Material/Print Method Selection Chart

Material	Print Method	Temperature Range	Features
Polyolefin, White (FJ)	P1™ Cassette	-40°F to 180°F (-40°C to 82°C)	Indoor/outdoor rated; thin conformable material for general identification; excellent print quality.
Polyester, Clear (YK)		-40°F to 257°F (-40°C to 125°C)	Indoor/outdoor rated; laminated label material protects legend from abrasion and chemicals; resistant to UV light chemical atmosphere and abrasion; excellent life and adhesion properties.
Polymer Film, White (RP), Orange (RU), Yellow (RX)		-40°F to 180°F (-40°C to 82°C)	Indoor/outdoor rated; heavy duty reflective material for flat applications and safety and facility identification; resistant to UV light, chemical atmosphere and abrasion.
Vinyl, White (VP), Blue (VQ), Green (VS), Orange (VU), Red (VV), Yellow (VX), Black (VY)		-58°F to 176°F (-50°C to 80°C)	Indoor/outdoor rated; conformable material for flat applications and safety and facility identification; can be overlaminated to increase durability.

Part Number	Part Description	Height		Length		Std. Pkg. Qty.	Std. Ctn. Qty.
		In.	mm	Ft.	m		
T019X000FJC-BK	Black on white, polyolefin module label tape.	.19	4.83	25.0	7.6	1	10
T024X000FJC-BK	Black on white, polyolefin tape, terminal block label.	.24	6.10	25.0	7.6	1	10
T031X000FJC-BK	Black on white, polyolefin tape, terminal block label.	.31	7.87	25.0	7.6	1	10
T038X000FJC-BK	Black on white, polyolefin tape, terminal block label.	.38	9.65	25.0	7.6	1	10

Order number of cassettes required.

Table continues on page E1.12

A. System Overview

## P1™ Continuous Tape Cassettes for PanTher™ LS8E and Cougar™ LS9 Hand-Held Thermal Transfer Printers (continued)

B1. Cable Ties

Part Number	Part Description	Height		Length		Std. Pkg. Qty.	Std. Ctn. Qty.
		In.	mm	Ft.	m		
<b>T038X000VPC-BK</b>	Black on white, vinyl tape.	0.38	9.65	25.0	7.6	1	10
<b>T038X000VYC-WH</b>	White on black, vinyl tape.	0.38	9.65	25.0	7.6	1	10
<b>T038X000YKC-BK</b>	Black on clear, polyester tape.	0.38	9.65	25.0	7.6	1	10
<b>T050X000VPC-BK</b>	Black on white, vinyl tape.	0.50	12.70	25.0	7.6	1	10
<b>T050X000VQC-BK</b>	Black on blue, vinyl tape.	0.50	12.70	25.0	7.6	1	10
<b>T050X000VQC-WH</b>	White on blue, vinyl tape.	0.50	12.70	25.0	7.6	1	10
<b>T050X000VSC-BK</b>	Black on green, vinyl tape.	0.50	12.70	25.0	7.6	1	10
<b>T050X000VSC-WH</b>	White on green, vinyl tape.	0.50	12.70	25.0	7.6	1	10
<b>T050X000VUC-BK</b>	Black on orange, vinyl tape.	0.50	12.70	25.0	7.6	1	10
<b>T050X000VWC-BK</b>	Black on red, vinyl tape.	0.50	12.70	25.0	7.6	1	10
<b>T050X000VWC-WH</b>	White on red, vinyl tape.	0.50	12.70	25.0	7.6	1	10
<b>T050X000VXC-BK</b>	Black on yellow, vinyl tape.	0.50	12.70	25.0	7.6	1	10
<b>T050X000VYC-WH</b>	White on black, vinyl tape.	0.50	12.70	25.0	7.6	1	10
<b>T050X000YKC-BK</b>	Black on clear, polyester tape.	0.50	12.70	25.0	7.6	1	10
<b>T050X000YKC-WH</b>	White on clear, polyester tape.	0.50	12.70	25.0	7.6	1	10
<b>T075X000VPC-BK</b>	Black on white, vinyl tape.	0.75	19.05	25.0	7.6	1	10
<b>T075X000YKC-BK</b>	Black on clear, polyester tape.	0.75	19.05	25.0	7.6	1	10
<b>T100X000VPC-BK</b>	Black on white, vinyl tape.	1.00	25.40	25.0	7.6	1	10
<b>T100X000VQC-BK</b>	Black on blue, vinyl tape.	1.00	25.40	25.0	7.6	1	10
<b>T100X000VQC-WH</b>	White on blue, vinyl tape.	1.00	25.40	25.0	7.6	1	10
<b>T100X000VSC-BK</b>	Black on green, vinyl tape.	1.00	25.40	25.0	7.6	1	10
<b>T100X000VSC-WH</b>	White on green, vinyl tape.	1.00	25.40	25.0	7.6	1	10
<b>T100X000VUC-BK</b>	Black on orange, vinyl tape.	1.00	25.40	25.0	7.6	1	10
<b>T100X000VUC-WH</b>	White on orange, vinyl tape.	1.00	25.40	25.0	7.6	1	10
<b>T100X000VWC-BK</b>	Black on red, vinyl tape.	1.00	25.40	25.0	7.6	1	10
<b>T100X000VWC-WH</b>	White on red, vinyl tape.	1.00	25.40	25.0	7.6	1	10
<b>T100X000VXC-BK</b>	Black on yellow, vinyl tape.	1.00	25.40	25.0	7.6	1	10
<b>T100X000VXC-WH</b>	White on yellow, vinyl tape.	1.00	25.40	25.0	7.6	1	10
<b>T100X000VYC-WH</b>	White on black, vinyl tape.	1.00	25.40	25.0	7.6	1	10
<b>T100X000YKC-BK</b>	Black on clear, polyester tape.	1.00	25.40	25.0	7.6	1	10
<b>T100X000YKC-WH</b>	White on clear, polyester tape.	1.00	25.40	25.0	7.6	1	10

Order number of cassettes required.

E1. Labeling Systems

## P1™ Continuous Reflective Tape Cassettes for PanTher™ LS8E and Cougar™ LS9 Hand-Held Thermal Transfer Printers

- Fast loading P1™ Label Cassette includes both label material and ribbon to make changing labels easy
- Reflective material improves label visibility in low light conditions
- For flat label applications only

E3. Pre-Printed & Write-On Markers

Part Number	Part Description	Height		Length		Std. Pkg. Qty.	Std. Ctn. Qty.
		In.	mm	Ft.	m		
<b>T100X000RPC-BK</b>	Black on white, reflective tape.	1.00	25.4	18.0	5.5	1	10
<b>T100X000RUC-BK</b>	Black on orange, reflective tape.	1.00	25.4	18.0	5.5	1	10
<b>T100X000RXC-BK</b>	Black on yellow, reflective tape.	1.00	25.4	18.0	5.5	1	10

Order number of cassettes required.

E5. Lockout/Tagout & Safety Solutions

F. Index

## TDP43MY Thermal Transfer Desktop Printer and Accessories

- Compact, lightweight design enables use in office or remote locations
- 300 dpi thermal transfer printer creates crisp, clear legends with superior legibility
- Up to 2.00 inches per second print speed for fast label production
- Use to print a wide variety of self-laminating labels, component labels, non-laminated labels, heat shrink labels, marker plates and continuous tapes up to 4.00 inches wide
- Easy-Mark™ Labeling Software and hybrid ribbon included with printer



Part Number	Description	Std. Pkg. Qty.
TDP43MY	300 dpi printer; includes printer, Panduit® Easy-Mark™ Labeling Software, RMH4BL hybrid black ribbon, AC power adapter with US and Europlug power cords, manual and quick start card.	1
TDP43ME-RS	External label roll stand – used to rear feed labels that are supplied on 3.00" cores.	1
TDP43M-CASE	Hardside carrying case. Accommodates printer, AC power adapter, ribbons, printer cable, labels and tools.	1
TDP43M-ACY	Replacement AC power adapter with power cord (US cord only).	1
PTR-CLN	Printer cleaning kit – contains bottle of cleaning solution with MSDS, cleaning pen, swabs, alcohol wipes and cleaning instructions.	1

## Ribbons for Use with the TDP43MY Thermal Transfer Desktop Printer

- **Hybrid** – Recommended for use with self-laminating, heat shrink, component and non-laminated labels
- **Wax** – Recommended for use with self-laminating and non-laminated labels
- **Resin** – Recommended for use with component labels, marker plates, and continuous tape



Part Number	Part Description	Height		Length		Std. Pkg. Qty.	Std. Ctn. Qty.
		In.	mm	Ft.	m		
RMH2BL	Black, hybrid thermal transfer ribbon. For use with self-laminating, component, heat shrink and non-laminated labels.	2.52	63.5	240.00	73.0	1	12
RMH4BL	Black, hybrid thermal transfer ribbon. For use with self-laminating, component, heat shrink and non-laminated labels.	4.33	110.0	240.00	73.0	1	12
RMW2BL	Black, wax thermal transfer ribbon. For use with self-laminating vinyl and non-laminated labels.	2.52	63.5	240.00	73.0	1	12
RMW4BL	Black, wax thermal transfer ribbon. For use with self-laminating and non-laminated labels.	4.33	110.0	240.00	73.0	1	12
RMR2BL	Black, resin thermal transfer ribbon. For use with component labels, marker plates, and continuous tape.	2.52	63.5	240.00	73.0	1	12
RMR2WH	White, resin thermal transfer ribbon. For use with component labels, marker plates, and continuous tape.	2.52	63.5	240.00	73.0	1	12
RMR4BL*	Black, resin thermal transfer ribbon. For use with component labels, marker plates, and continuous tape.	4.33	110.0	240.00	73.0	1	12
RMR4BL-A	Black, resin thermal transfer ribbon. For use with component labels, marker plates, and continuous tape.	4.33	110.0	240.0	73.0	1	12

Order number of ribbons required.

\*Other colors available, replace BL (Black) with WH (White), BU (Blue), GR (Green) or RD (Red).

A. System Overview

## TDP42HY, TDP43HY, TDP46HY Thermal Transfer Desktop Printers

B1. Cable Ties

- Rugged, high speed industrial printer
- Use to print a wide variety of self-laminating labels, component labels, non-laminated labels, marker plate, continuous tapes and heat shrink labels up to 4.00 inches wide
- 203, 305, or 609 dpi thermal transfer printers create crisp, clear legends with superior legibility
- Easy-Mark™ Labeling Software and hybrid ribbon included with printer
- Up to 10.00 inches per second print speed for fast label production

B2. Cable Accessories

B3. Stainless Steel Ties



Part Number	Part Description	Std. Pkg. Qty.
<b>TDP42HY</b>	203 dpi printer for high volume applications, Panduit® Easy-Mark™ Labeling Software, RHH4BL-S hybrid black ribbon, AC power adapter and manual.	1
<b>TDP43HY</b>	305 dpi printer for high volume applications, Panduit® Easy-Mark™ Labeling Software, RHH4BL-S hybrid black ribbon, AC power adapter and manual.	1
<b>TDP46HY</b>	609 dpi printer for high volume applications, Panduit® Easy-Mark™ Labeling Software, RHH4BL-S hybrid black ribbon, AC power adapter and manual.	1

C1. Wiring Duct

C2. Surface Raceway

C3. Abrasion Protection

C4. Cable Management

D1. Terminals

## Ribbons for use with the TDP42HY, TDP43HY and TDP46HY Thermal Transfer Desktop Printers

D2. Power Connectors

- **Hybrid** – Recommended for use with self-laminating, heat shrink, component and non-laminated labels
- **Resin** – Recommended for use with component labels, marker plates, and continuous tape
- **Wax** – Recommended for use with self-laminating and non-laminated labels

D3. Grounding Connectors



Part Number	Part Description	Height		Length		Std. Pkg. Qty.	Std. Ctn. Qty.
		In.	mm	Ft.	m		
<b>RHH4BL-S</b>	Black, hybrid thermal transfer ribbon. Recommended for use with self-laminating, heat shrink, component and non-laminated labels.	4.33	109.98	1181.0	359.96	1	2
<b>RHW4BL-S</b>	Black, wax thermal transfer ribbon. Recommended for use with self-laminating and non-laminated labels.	4.33	109.98	1181.0	359.96	1	2
<b>RHR4BL-S</b>	Black, resin thermal transfer ribbon. Recommended for use with component labels and continuous tape.	4.33	109.98	1181.0	359.96	1	2

Order number of ribbons required.

E1. Labeling Systems

E2. Labels

E3. Pre-Printed & Write-On Markers

E4. Permanent Identification

E5. Lockout/Tagout & Safety Solutions

F. Index



## LABELING SOFTWARE

Panduit labeling software is custom designed to address your requirements for wire/cable labeling, component identification, network administration, as well as, safety and facility identification. From control panel wire identification, terminal block and facility pipe marking to patch panel, faceplate and wire/cable marking, Panduit software is the solution for your on-demand identification requirements.



- Easy-Mark™ Labeling Software is an easy-to-use, intuitive general purpose labeling software
- CAD-Connect™ Labeling Software generates labels quickly and easily directly from an electronic CAD file

Panduit user-friendly software packages meet the unique requirements of your applications.

A.  
System  
Overview

B1.  
Cable Ties

B2.  
Cable  
Accessories

B3.  
Stainless  
Steel Ties

C1.  
Wiring  
Duct

C2.  
Surface  
Raceway

C3.  
Abrasion  
Protection

C4.  
Cable  
Management

D1.  
Terminals

D2.  
Power  
Connectors

D3.  
Grounding  
Connectors

E1.  
Labeling  
Systems

E2.  
Labels

E3.  
Pre-Printed  
& Write-On  
Markers

E4.  
Permanent  
Identification

E5.  
Lockout/  
Tagout  
& Safety  
Solutions

F.  
Index

A. System Overview

## Easy-Mark™ Labeling Software

B1. Cable Ties

- Easy-Mark™ Labeling Software simplifies label creation for the specific needs of your applications

- Easy-Mark™ Labeling Software is part of a complete line of innovative identification solutions from Panduit

B2. Cable Accessories

- Instructions and user interface are available in English, French, German, Italian, Spanish, Korean, Japanese, Chinese and Portuguese

- Supports most WINDOWS^ fonts drivers for standard thermal transfer, dot matrix, laser and ink jet, including Panduit thermal transfer printers

B3. Stainless Steel Ties

- Intuitive interview process allows automatic generation of labels and signs
- Software selects and formats the optimum label for your specific application
- WYSIWYG (What You See Is What You Get) user interface, alpha/numeric serialization, data import, symbol import

### System Requirements:

- WINDOWS^ 2000, XP, Vista, or 7; 64MB hard drive space and 64MB RAM (256MB RAM recommended)

C1. Wiring Duct



Part Number	Part Description	Std. Pkg. Qty.	Std. Ctn. Qty.
<b>PROG-EMCD3</b>	Easy-Mark™ Labeling Software supplied on CD-ROM.	1	10
<b>PROG-EM2GO</b>	Easy-Mark™ Portable Application, USB Flash Drive.	1	10

^WINDOWS is a registered trademark of Microsoft Corporation in the United States and/or other countries.

C2. Surface Raceway

C3. Abrasion Protection

## CAD-Connect™ Labeling Software

C4. Cable Management

- Generates labels quickly and easily directly from electronic CAD files

- Exports to alternative formats such as EXCEL^ (XLS) or Text (CSV) files for future use and documentation

D1. Terminals

- Eliminates steps and time spent manually copying CAD identifiers into labeling software

### System Requirements:

- WINDOWS^ 2000, XP, Vista, or 7; 64MB hard drive space and 64MB RAM (256MB RAM recommended)

D2. Power Connectors

- Program combines the power of an innovative wizard interview and Easy-Mark™ Labeling Software to capture and organize identifiers from electronic CAD files to automatically create and print labels

- Compatible with full versions of AutoCAD\* 2000i, 2002, 2004, 2006, 2007; AutoCAD Electrical 2005 and 2006; AutoCAD Architectural 2007 and 2008; AutoCAD Mechanical 2007 and 2008; and Visio^ 2002 and newer versions

D3. Grounding Connectors



Part Number	Part Description	Std. Pkg. Qty.	Std. Ctn. Qty.
<b>PROG-CCCD</b>	CAD-Connect™ Labeling Software, including Easy-Mark™ Labeling Software, supplied on CD-ROM.	1	10

\*AutoCAD is a registered trademark of Autodesk, Inc.

^Visio, WINDOWS, and EXCEL are registered trademarks of Microsoft Corporation in the United States and/or other countries.

E1. Labeling Systems

E2. Labels

E3. Pre-Printed & Write-On Markers

E4. Permanent Identification

E5. Lockout/Tagout & Safety Solutions

F. Index

## LABELS: LASER, INK JET, AND THERMAL TRANSFER

Panduit provides a full line of on demand printable labels designed to meet all of your identification needs.

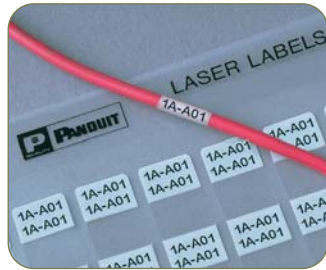

- Laser/ink jet labels supplied on 8.50" x 11.00" sheets and can be printed in commercially available laser and ink jet printers not sold by Panduit
- Thermal transfer labels supplied on rolls offer crisp, clear legends with superior legibility and can be printed on Panduit thermal transfer desktop printers or commercially available models
- Size illustrations are provided for reference

Panduit labeling solutions meet customer needs at the lowest total installed cost.



A.  
System  
Overview

B1.  
Cable Ties

B2.  
Cable  
Accessories

B3.  
Stainless  
Steel Ties

C1.  
Wiring  
Duct

C2.  
Surface  
Raceway

C3.  
Abrasion  
Protection

C4.  
Cable  
Management

D1.  
Terminals

D2.  
Power  
Connectors

D3.  
Grounding  
Connectors

E1.  
Labeling  
Systems

E2.  
Labels

E3.  
Pre-Printed  
& Write-On  
Markers

E4.  
Permanent  
Identification

E5.  
Lockout/  
Tagout  
& Safety  
Solutions

F.  
Index

A.  
System  
Overview

## Laser/Ink Jet Self-Laminating Labels

B1.  
Cable Ties



- Labels can be printed in both laser and ink jet printers
- Self-laminating adhesive labels include a colored print-on area and clear overlamine

B2.  
Cable Accessories

B3.  
Stainless  
Steel Ties

## Part Number System for Self-Laminating Labels



C1.  
Wiring  
Duct

C2.  
Surface Raceway

C3.  
Abrasion  
Protection

C4.  
Cable  
Management

## Material/Print Method Selection Guide

	Material	Print Method	Temperature Range	Features
D1. Terminals	Self-Laminating Polyester, White Print-On (YA) Blue Print-On (YB) Green Print-On (YD) Red Print-On (YH) Yellow Print-On (YI) Brown Print-On (YC) Gray Print-On (YE) Orange Print-On (YF) Purple Print-On (YG)	Laser/Ink Jet (J)	0°F to 275°F (-18°C to 135°C)	Indoor/outdoor rated; provides durability, high temperature resistance, and dimensional stability; does not stretch or easily tear; preferred material for wire/cable labeling
D2. Power Connectors				
D3. Grounding Connectors				

E1.  
Labeling Systems

E2.  
Labels

E3.  
Pre-Printed  
& Write-On  
Markers

E4.  
Permanent  
Identification

E5.  
Lockout/  
Tagout  
& Safety  
Solutions

F.  
Index

## Laser/Ink Jet Self-Laminating Labels (continued)

Part Number	Part Description	Width		Length		Print-On Height		Min. Cable O.D.		Max. Cable O.D.		Std. Pkg. Qty.	Std. Ctn. Qty.
		In.	mm	In.	mm	In.	mm	In.	mm	In.	mm		
S050X075YAJ	White print-on area, polyester label for 18 – 14 AWG wire.	0.50	12.7	0.75	19.1	0.25	6.4	0.08	2.0	0.16	4.1	5000	25000
S050X125YAJ	White print-on area, polyester label for 12 – 10 AWG wire.	0.50	12.7	1.25	31.8	0.38	9.7	0.12	3.0	0.28	7.0	5000	25000
S050X150YAJ	White print-on area, polyester label for Cat. 5e/Cat. 6/Cat. 6A cables.	0.50	12.7	1.50	38.1	0.50	12.7	0.16	4.1	0.32	8.1	5000	25000
S075X075YAJ	White print-on area, polyester label for 18 – 14 AWG wire.	0.75	19.1	0.75	19.1	0.25	6.4	0.08	2.0	0.16	4.1	2500	10000
S075X125YAJ	White print-on area, polyester label for 12 – 10 AWG wire.	0.75	19.1	1.25	31.8	0.38	9.7	0.12	3.1	0.28	7.0	2500	10000
S075X150YAJ	White print-on area, polyester label for Cat. 5e/Cat. 6/Cat. 6A cables.	0.75	19.1	1.50	38.1	0.50	12.7	0.16	4.1	0.32	8.1	2500	10000
S100X075YAJ	White print-on area, polyester label for 18 – 14 AWG wire.	1.00	25.4	0.75	19.1	0.25	6.4	0.08	2.0	0.16	4.1	2500	10000
S100X125YAJ	White print-on area, polyester label for 12 – 10 AWG wire.	1.00	25.4	1.25	31.8	0.38	9.7	0.12	3.1	0.28	7.0	2500	10000
S100X150YAJ*	White print-on area, polyester label for Cat. 5e/Cat. 6/Cat. 6A cables.	1.00	25.4	1.50	38.1	0.50	12.7	0.16	4.0	0.32	8.1	2500	10000
S100X225YAJ*	Red print-on area, polyester label for 8 – 4 AWG wire.	1.00	25.4	2.25	57.2	0.75	19.1	0.24	6.0	0.48	12.1	1000	5000
S100X400YAJ	White print-on area, polyester label for 2 – 1 AWG wire.	1.00	25.4	4.00	101.6	1.00	25.4	0.32	8.1	0.95	24.3	1000	5000
S100X650YAJ	White print-on area, polyester label for 1/0 – 350 MCM wires.	1.00	25.4	6.50	165.1	1.50	38.1	0.48	12.1	1.59	40.4	1000	5000
S150X400YAJ	White print-on area, polyester label.	1.50	38.1	4.00	101.6	1.00	25.4	0.32	8.1	0.95	24.1	1000	5000
S150X400YIJ	Yellow print-on area, polyester label.	1.50	38.1	4.00	101.6	1.00	25.4	0.32	8.1	0.95	24.1	1000	5000
S200X150YAJ	White print-on area, polyester label.	2.00	50.8	1.50	38.1	0.50	12.7	0.16	4.1	0.32	8.1	1000	5000
S200X225YAJ	White print-on area, polyester label for 8 – 4 AWG wire.	2.00	50.8	2.25	57.2	0.75	19.1	0.24	6.1	0.48	12.1	1000	5000
S200X400YAJ	White print-on area, polyester label for 2 – 1 AWG wire.	2.00	50.8	4.00	101.6	1.00	25.4	0.32	8.1	0.95	24.3	1000	5000
S200X650YAJ	White print-on area, polyester label for 1/0 – 350 MCM wires.	2.00	50.8	6.50	165.1	1.50	38.1	0.48	12.1	1.59	40.4	500	2500

Order number of labels required in multiples of Std. Pkg. Qty.

\*Other colors available, replace A with B (Blue), C (Brown), D (Green), E (Gray), F (Orange), G (Purple), H (Red) and I (Yellow).

A.  
System  
Overview

B1.  
Cable Ties

B2.  
Cable  
Accessories

B3.  
Stainless  
Steel Ties

C1.  
Wiring  
Duct

C2.  
Surface  
Raceway

C3.  
Abrasion  
Protection

C4.  
Cable  
Management

D1.  
Terminals

D2.  
Power  
Connectors

D3.  
Grounding  
Connectors

E1.  
Labeling  
Systems

E2.  
Labels

E3.  
Pre-Printed  
& Write-On  
Markers

E4.  
Permanent  
Identification

E5.  
Lockout/  
Tagout  
& Safety  
Solutions

F.  
Index

A. System Overview

## Laser/Ink Jet Non-Laminated Labels

- Labels can be printed in both laser/ink jet printers
- Use as a wrap around label or flag style labels for wire/cable labeling
- Available in polyolefin material and supplied on 8.50" x 11.00" sheets
- Panduit labeling software packages include all label formats for quick and easy label production

B1. Cable Ties

B2. Cable Accessories



B3. Stainless Steel Ties

C1. Wiring Duct

C2. Surface Raceway

### Part Number System for Non-Laminated Labels

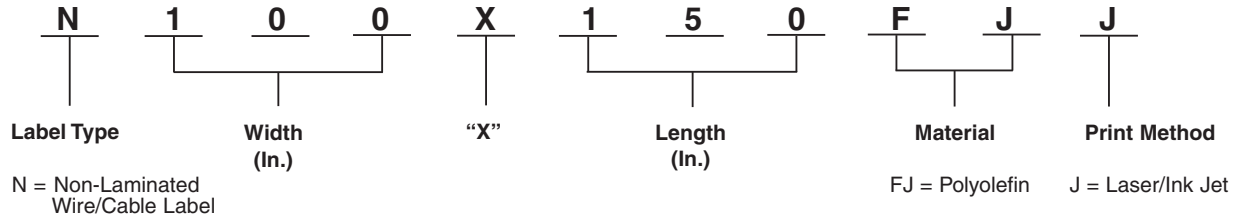

C3. Abrasion Protection

C4. Cable Management

D1. Terminals

### Material/Print Method Selection Guide

Material	Print Method	Temperature Range	Features
Polyolefin, White (FJ)	Laser/Ink Jet (J)	-40°F to 180°F (-40°C to 82°C)	Indoor/outdoor rated; conformable material for general identification; excellent print quality

D2. Power Connectors

D3. Grounding Connectors

Part Number	Part Description	Width		Length		Min. Cable O.D.		Max. Cable O.D.		Std. Pkg. Qty.	Std. Ctn. Qty.
		In.	mm	In.	mm	In.	mm	In.	mm		
<b>N025X075FJJ</b>	White, polyolefin label.	0.25	6.4	0.75	19.1	0.240	6.1	0.51	13.0	10000	50000
<b>N025X125FJJ</b>	White, polyolefin label.	0.25	6.4	1.25	31.8	0.400	10.2	0.85	22.0	10000	50000
<b>N025X150FJJ</b>	White, polyolefin label.	0.25	6.4	1.50	38.1	0.48	12.2	1.02	25.9	10000	50000
<b>N050X075FJJ</b>	White, polyolefin label.	0.50	12.7	0.75	19.1	0.240	6.1	0.51	13.0	10000	50000
<b>N050X125FJJ</b>	White, polyolefin label.	0.50	12.7	1.25	31.8	0.400	10.2	0.85	21.6	10000	50000
<b>N050X150FJJ</b>	White, polyolefin label.	0.50	12.7	1.50	38.1	0.48	12.2	1.02	25.9	5000	25000
<b>N100X075FJJ</b>	White, polyolefin label.	1.00	25.4	0.75	19.1	0.240	6.1	0.51	13.0	5000	25000
<b>N100X125FJJ</b>	White, polyolefin label.	1.00	25.4	1.25	31.8	0.400	10.2	0.85	22.0	5000	25000
<b>N100X150FJJ</b>	White, polyolefin label.	1.00	25.4	1.50	38.1	0.48	12.2	1.02	25.9	2500	10000

E1. Labeling Systems

E2. Labels

E3. Pre-Printed & Write-On Markers

E4. Permanent Identification

E5. Lockout/Tagout & Safety Solutions

F. Index

Order number of labels required in multiples of Std. Pkg. Qty.

## Laser/Ink Jet Flag Style Labels

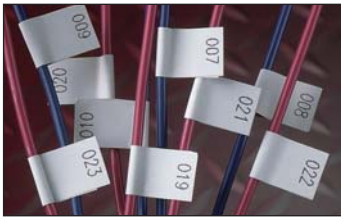

Part Number	Part Description	Width		Length		Min. Cable O.D.		Max. Cable O.D.		Std. Pkg. Qty.	Std. Ctn. Qty.
		In.	mm	In.	mm	In.	mm	In.	mm		
N050X150FJJ	White, polyolefin label.	.50	12.70	1.50	38.10	.06	1.52	.15	3.81	5000	25000
N100X150FJJ	White, polyolefin label.	1.00	25.40	1.50	38.10	.12	3.05	.22	5.58	2500	10000

Order number of labels required in multiples of Std. Pkg. Qty.

## Laser/Ink Jet Component Labels

- Labels can be printed in both laser and ink jet printers
- Use for identifying patch panels, faceplates, punchdown blocks and other network systems hardware
- Die-cut labels designed to provide maximum aesthetic quality and appearance
- Available in adhesive polyolefin and non-adhesive polyester materials



## Part Number System for Component Labels

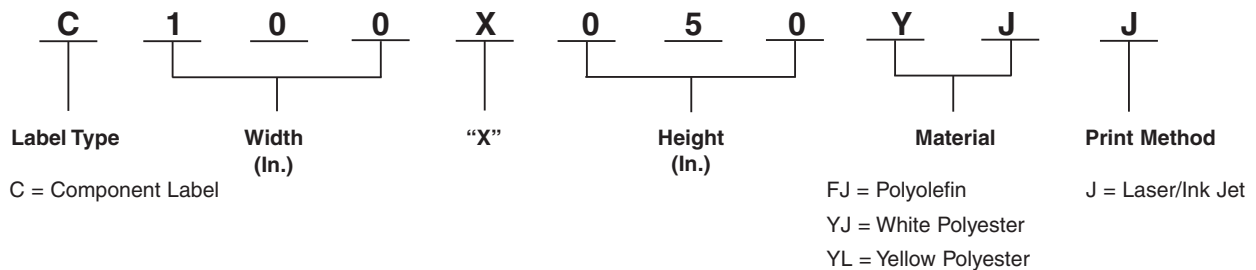

## Material/Print Method Selection Guide

Material	Print Method	Temperature Range	Features
Polyester, White (YJ) Yellow (YL)	Laser/Ink Jet (J)	-40°F to 311°F (-40°C to 154°C)	Indoor/outdoor rated; provides durability, high temperature resistance, and dimensional stability. Does not stretch or easily tear
Polyolefin, White (FJ)		-40°F to 180°F (-40°C to 82°C)	Indoor/outdoor rated; thin conformable material for general identification; excellent print quality

Table continues on page E2.6

A.  
System  
Overview

## Laser/Ink Jet Component Labels (continued)

B1.  
Cable Ties

B2.  
Cable Accessories

B3.  
Stainless  
Steel Ties

C1.  
Wiring  
Duct

C2.  
Surface Raceway

C3.  
Abrasion  
Protection

C4.  
Cable  
Management

D1.  
Terminals

D2.  
Power Connectors

D3.  
Grounding  
Connectors

E1.  
Labeling Systems

E2.  
Labels

E3.  
Pre-Printed  
& Write-On  
Markers

E4.  
Permanent  
Identification

E5.  
Lockout/  
Tagout  
& Safety  
Solutions

F.  
Index

Part Number	Part Description	Width		Height		Std. Pkg. Qty.	Std. Ctn. Qty.
		In.	mm	In.	mm		
<b>C038X038YJJ</b>	White, polyester label.	0.38	9.7	0.38	9.7	10000	50000
<b>C038X038YLJ</b>	Yellow, polyester label.	0.38	9.7	0.38	9.7	10000	50000
<b>C050X044YJJ</b>	White, polyester label.	0.50	12.7	0.44	11.2	10000	50000
<b>C060X020YJJ</b>	White, polyester label.	0.60	15.3	0.20	5.1	10000	50000
<b>C075X025YJJ</b>	White, polyester label.	0.75	19.1	0.25	6.4	10000	50000
<b>C075X025YLJ</b>	Yellow, polyester label.	0.75	19.1	0.25	6.4	10000	50000
<b>C075X050YJJ</b>	White, polyester label.	0.75	19.1	0.50	12.7	10000	50000
<b>C080X020YJJ</b>	White, polyester label.	0.80	20.3	0.20	5.1	10000	50000
<b>C100X025YJJ</b>	White, polyester label.	1.00	25.4	0.25	6.4	10000	50000
<b>C100X038YJJ</b>	White, polyester label.	1.00	25.4	0.38	9.7	5000	50000
<b>C100X050YJJ</b>	White, polyester label.	1.00	25.4	0.50	12.7	10000	50000
<b>C100X050YLJ</b>	Yellow, polyester label.	1.00	25.4	0.50	12.7	5000	25000
<b>C100X075YJJ</b>	White, polyester label.	1.00	25.4	0.75	19.1	5000	25000
<b>C100X150YJJ</b>	White, polyester label.	1.00	25.4	1.50	38.1	2500	25000
<b>C150X050YJJ</b>	White, polyester label.	1.50	38.1	0.50	12.7	2500	12500
<b>C150X075YJJ</b>	White, polyester label.	1.50	38.1	0.75	19.1	2500	12500
<b>C160X020YJJ</b>	White, polyester label.	1.60	40.6	0.20	5.1	5000	20000
<b>C200X050YJJ</b>	White, polyester label.	2.00	50.8	0.50	12.7	1000	5000
<b>C200X100FJJ</b>	White, polyolefin label, SLCT bundle marker identifier.	2.00	50.8	1.00	25.4	1000	5000
<b>C200X100YJJ</b>	White, polyester label.	2.00	50.8	1.00	25.4	1000	5000
<b>C200X100YLJ</b>	Yellow, polyester label.	2.00	50.8	1.00	25.4	1000	5000
<b>C225X450FJJ</b>	White, polyolefin label.	2.25	57.2	4.50	114.3	150	750
<b>C275X125YJJ</b>	White, polyester label.	2.75	69.9	1.25	31.8	1000	5000
<b>C300X038YJJ</b>	White, polyester label.	3.00	76.2	0.38	9.7	1000	5000
<b>C300X100YJJ</b>	White, polyester label.	3.00	76.2	1.00	25.4	1000	5000
<b>C350X100YJJ</b>	White, polyester label.	3.50	88.9	1.00	25.4	1000	5000
<b>C350X500FJJ</b>	White, polyolefin label.	3.50	88.9	5.00	127.0	100	500
<b>C400X100YJJ</b>	White, polyester label.	4.00	101.6	1.00	25.4	1000	5000
<b>C400X200YJJ</b>	White, polyester label.	4.00	101.6	2.00	50.8	1000	5000
<b>C400X400YJJ</b>	White, polyester label.	4.00	101.6	4.00	101.6	1000	4000
<b>C500X700FJJ</b>	White, polyolefin label.	5.00	127.0	7.00	177.8	50	250
<b>C788X050YJJ</b>	White, polyester label.	7.88	200.2	0.50	12.7	400	2000
<b>C850X1100YJJ</b>	White, polyester label.	8.50	215.9	11.00	279.4	25	100
<b>C850X1100YLJ</b>	Yellow, polyester label.	8.50	215.9	11.00	279.4	25	100

Order number of labels required in multiples of Std. Pkg. Qty.



## Thermal Transfer Self-Laminating Labels

- Self-laminating adhesive labels supplied on rolls, include a colored print-on area and clear overlamine
- Use with Panduit RMH4BL hybrid thermal transfer ribbon



### Material/Print Method Selection Guide

Material	Print Method	Temperature Range	Features
Self-Laminating Vinyl, White Print-On (VA)	Thermal Transfer (T)	-40°F to 200°F (-40°C to 93°C)	Indoor/outdoor rated; thin and conformable; preferred material for most general wire/cable labeling.

## Part Number System for Self-Laminating Labels



Part Number	Part Description	Width		Length		Print-On Area Height		Min. Cable O.D.		Max. Wire O.D.		Std. Pkg. Qty.	Std. Ctn. Qty.
		In.	mm	In.	mm	In.	mm	In.	mm	In.	mm		
S050X075VA1Y	White print-on area, vinyl label for 18 – 14 AWG wires.	0.50	12.7	0.75	19.1	0.25	6.4	0.08	2.03	0.16	4.0	5000	20000
S050X075VATY*	White print-on area, vinyl label for 18 – 14 AWG wires.	0.50	12.7	0.75	19.1	0.25	6.4	0.08	2.03	0.16	4.0	5000	40000
S050X125VA1Y	White print-on area, vinyl label for 12 – 10 AWG wires.	0.50	12.7	1.25	31.8	0.38	9.7	0.12	3.1	0.28	7.0	5000	20000
S050X125VATY*	White print-on area, vinyl label for 12 – 10 AWG wires.	0.50	12.7	1.25	31.8	0.38	9.7	0.12	3.1	0.28	7.0	5000	10000
S050X150VA1Y	White print-on area, vinyl label for Cat. 5e/Cat. 6 cables.	0.50	12.7	1.50	38.1	0.50	12.7	0.16	4.0	0.32	8.1	5000	60000
S050X150VATY*	White print-on area, vinyl label for Cat. 5e/Cat. 6/Cat. 6A cables.	0.50	12.7	1.50	38.1	0.50	12.7	0.16	4.0	0.32	8.1	5000	40000
S050X250VATY*	White print-on area, vinyl label for 6 – 2 AWG wires.	0.50	12.7	2.50	63.5	1.00	25.4	0.32	8.1	0.95	24.3	5000	20000

Order number of labels required in multiples of Std. Pkg. Qty.

Use with Panduit thermal transfer hybrid or wax ribbons.

\*Labels are roll mounted on 3.00" cores; when using the TDP43MY printer and 3.00" cores, the roll stand (TDP43ME-RS) is required.

**Table continues on page E2.8**

A.  
System  
Overview

## Thermal Transfer Self-Laminating Labels (continued)

B1.  
Cable Ties

B2.  
Cable Accessories

B3.  
Stainless  
Steel Ties

C1.  
Wiring  
Duct

C2.  
Surface Raceway

C3.  
Abrasion  
Protection

C4.  
Cable  
Management

D1.  
Terminals

D2.  
Power Connectors

D3.  
Grounding  
Connectors

E1.  
Labeling Systems

E2.  
Labels

E3.  
Pre-Printed  
& Write-On  
Markers

E4.  
Permanent  
Identification

E5.  
Lockout/  
Tagout  
& Safety  
Solutions

F.  
Index

Part Number	Part Description	Width		Length		Print-On Area Height		Min. Cable O.D.		Max. Wire O.D.		Std. Pkg. Qty.	Std. Ctn. Qty.
		In.	mm	In.	mm	In.	mm	In.	mm	In.	mm		
<b>S075X075VATY*</b>	White print-on area, vinyl label for 18 – 14 AWG wires.	0.75	19.1	0.75	19.1	0.25	6.4	0.08	2.03	0.16	4.04	5000	20000
<b>S075X125VATY*</b>	White print-on area, vinyl label for 12 – 10 AWG wires.	0.75	19.1	1.25	31.8	0.38	9.7	0.12	3.1	0.28	7.0	5000	20000
<b>S075X150VATY*</b>	White print-on area, vinyl label for Cat. 5e/Cat. 6/Cat. 6A cables.	0.75	19.1	1.50	38.1	0.50	12.7	0.16	4.0	0.32	8.1	5000	20000
<b>S100X075VA1Y</b>	White print-on area, vinyl label for 18 – 14 AWG wires.	1.00	25.4	0.75	19.1	0.25	6.4	0.08	2.0	0.16	4.0	2500	10000
<b>S100X075VATY*</b>	White print-on area, vinyl label for 18 – 14 AWG wires.	1.00	25.4	0.75	19.1	0.25	6.4	0.08	2.1	0.16	4.0	5000	10000
<b>S100X125VA1Y</b>	White print-on area, vinyl label for 12 – 10 AWG wires..	1.00	25.4	1.25	31.8	0.38	9.7	0.12	3.1	0.28	7.0	2500	10000
<b>S100X125VATY*</b>	White print-on area, vinyl label for 12 – 10 AWG wires.	1.00	25.4	1.25	31.8	0.38	9.7	0.12	3.1	0.28	7.0	5000	10000
<b>S100X150VA1Y</b>	White print-on area, vinyl label for Cat. 5e/Cat. 6/Cat. 6A cables.	1.00	25.4	1.50	38.1	0.50	12.7	0.16	4.0	0.32	8.1	2500	30000
<b>S100X150VATY*</b>	White print-on area, vinyl label for Cat. 5e/Cat. 6/Cat. 6A cables.	1.00	25.4	1.50	38.1	0.50	12.7	0.16	4.0	0.32	8.1	5000	20000
<b>S100X150VBTY*</b>	Blue print-on area, vinyl label for Cat. 5e/Cat. 6/Cat. 6A cables.	1.00	25.4	1.50	38.1	0.50	12.7	0.16	4.0	0.32	8.1	5000	20000
<b>S100X150VCTY*</b>	Brown print-on area, vinyl label for Cat. 5e/Cat. 6/Cat. 6A cables.	1.00	25.4	1.50	38.1	0.50	12.7	0.16	4.0	0.32	8.1	5000	20000
<b>S100X150VDTY*</b>	Green print-on area, vinyl label for Cat. 5e/Cat. 6/Cat. 6A cables.	1.00	25.4	1.50	38.1	0.50	12.7	0.16	4.0	0.32	8.1	5000	20000
<b>S100X150VETY*</b>	Gray print-on area, vinyl label for Cat. 5e/Cat. 6/Cat. 6A cables.	1.00	25.4	1.50	38.1	0.50	12.7	0.16	4.0	0.32	8.1	5000	20000
<b>S100X150VFTY*</b>	Orange print-on area, vinyl label for Cat. 5e/Cat. 6/Cat. 6A cables.	1.00	25.4	1.50	38.1	0.50	12.7	0.16	4.0	0.32	8.1	5000	20000
<b>S100X150VGTY*</b>	Purple print-on area, vinyl label for Cat. 5e/Cat. 6/Cat. 6A cables.	1.00	25.4	1.50	38.1	0.50	12.7	0.16	4.0	0.32	8.1	5000	20000
<b>S100X150VHTY*</b>	Red print-on area, vinyl label for Cat. 5e/Cat. 6/Cat. 6A cables.	1.00	25.4	1.50	38.1	0.50	12.7	0.16	4.0	0.32	8.1	5000	20000
<b>S100X150VITY*</b>	Yellow print-on area, vinyl label for Cat. 5e/Cat. 6/Cat. 6A cables.	1.00	25.4	1.50	38.1	0.50	12.7	0.16	4.0	0.32	8.1	5000	20000
<b>S100X150V0TY*</b>	Black print-on area, vinyl label for Cat. 5e/Cat. 6/Cat. 6A cables.	1.00	25.4	1.50	38.1	0.50	12.7	0.16	4.0	0.32	8.1	5000	20000
<b>S100X150V9TY*</b>	Gold print-on area, vinyl label for Cat. 5e/Cat. 6/Cat. 6A cables.	1.00	25.4	1.50	38.1	0.50	12.7	0.16	4.0	0.32	8.1	5000	20000
<b>S100X225VA1Y</b>	White print-on area, vinyl label for 8 – 4 AWG wires.	1.00	25.4	2.25	57.2	0.75	19.1	0.24	6.1	0.48	12.1	1500	18000
<b>S100X225VATY*</b>	White print-on area, vinyl label for 8 – 4 AWG wires.	1.00	25.4	2.25	57.2	0.75	19.1	0.24	6.1	0.48	12.1	5000	20000
<b>S100X225VBTY*</b>	Blue print-on area, vinyl label for 8 – 4 AWG wires.	1.00	25.4	2.25	57.2	0.75	19.1	0.24	6.1	0.48	12.1	5000	20000
<b>S100X225VCTY*</b>	Brown print-on area, vinyl label for 8 – 4 AWG wires.	1.00	25.4	2.25	57.2	0.75	19.1	0.24	6.1	0.48	12.1	5000	20000

Order number of labels required in multiples of Std. Pkg. Qty.  
Use with Panduit thermal transfer hybrid or wax ribbons.

\*Labels are roll mounted on 3.00" cores; when using the TDP43MY printer and 3.00" cores, the roll stand (TDP43M-RS) is required.

## Thermal Transfer Self-Laminating Labels (continued)

Part Number	Part Description	Width		Length		Print-On Area Height		Min. Cable O.D.		Max. Wire O.D.		Std. Pkg. Qty.	Std. Ctn. Qty.
		In.	mm	In.	mm	In.	mm	In.	mm	In.	mm		
S100X225VDTY*	Green print-on area, vinyl label for 8 – 4 AWG wires.	1.00	25.4	2.25	57.2	0.75	19.1	0.24	6.06	0.48	12.1	5000	20000
S100X225VETY*	Gray print-on area, vinyl label for 8 – 4 AWG wires.	1.00	25.4	2.25	57.2	0.75	19.1	0.24	6.1	0.48	12.1	5000	20000
S100X225VFTY*	Orange print-on area, vinyl label for 8 – 4 AWG wires.	1.00	25.4	2.25	57.2	0.75	19.1	0.24	6.1	0.48	12.1	5000	20000
S100X225VGTY*	Purple print-on area, vinyl label for 8 – 4 AWG wires.	1.00	25.4	2.25	57.2	0.75	19.1	0.24	6.1	0.48	12.1	5000	20000
S100X225VHTY*	Red print-on area, vinyl label for 8 – 4 AWG wires.	1.00	25.4	2.25	57.2	0.75	19.1	0.24	6.1	0.48	12.1	5000	20000
S100X225VITY*	Yellow print-on area, vinyl label for 8 – 4 AWG wires.	1.00	25.4	2.25	57.2	0.75	19.1	0.24	6.1	0.48	12.1	5000	20000
S100X225V0TY*	Black print-on area, vinyl label for 8 – 4 AWG wires.	1.00	25.4	2.25	57.2	0.75	19.1	0.24	6.1	0.48	12.1	5000	20000
S100X225V9TY*	Gold print-on area, vinyl label for 8 – 4 AWG wires.	1.00	25.4	2.25	57.2	0.75	19.1	0.24	6.1	0.48	12.1	5000	20000
S100X250VATY*	White print-on area, vinyl label for 6 – 2 AWG wires.	1.00	25.4	2.50	63.5	1.00	25.4	0.32	8.1	0.48	12.1	5000	20000
S100X400VA1Y	White print-on area, vinyl label for 2 – 1 AWG wires.	1.00	25.4	4.00	101.6	1.00	25.4	0.32	8.1	0.95	24.3	1000	4000
S100X400VATY*	White print-on area, vinyl label for 2 – 1 AWG wires.	1.00	25.4	4.00	101.6	1.00	25.4	0.32	8.1	0.95	24.3	2500	12500
S100X650VA1Y	White print-on area, vinyl label for 1/0 – 250 MCM wires.	1.00	25.4	6.50	165.1	1.50	38.1	0.48	12.1	1.59	40.4	250	1000
S100X650VATY*	White print-on area, vinyl label for 1/0 – 250 MCM wires.	1.00	25.4	6.50	165.1	1.50	38.1	0.48	12.1	1.59	40.4	1000	2000
S150X150VATY*	White print-on area, vinyl label for Cat. 5e/Cat. 6/Cat. 6A cables.	1.50	38.1	1.50	38.1	0.50	12.7	0.16	4.0	0.32	8.1	5000	20000
S150X225VATY*	White print-on area, vinyl label for 8 – 4 AWG wires.	1.50	38.1	2.25	57.2	0.75	19.1	0.24	6.1	0.48	12.1	5000	20000
S150X400VATY*	White print-on area, vinyl label for 2 – 1 AWG wires.	1.50	38.1	4.00	101.6	1.00	25.4	0.32	8.1	0.95	24.3	2500	10000
S200X225VA1Y	White print-on area, vinyl label for 8 – 4 AWG wires.	2.00	50.8	2.25	57.2	0.75	19.1	0.24	6.1	0.48	12.1	500	2000
S200X225VATY*	White print-on area, vinyl label for 8 – 4 AWG wires.	2.00	50.8	2.25	57.2	0.75	19.1	0.24	6.1	0.48	12.1	1000	4000
S200X250VATY*	White print-on area, vinyl label for 6 – 2 AWG wires.	2.00	50.8	2.50	63.5	1.00	25.4	0.32	8.1	0.48	12.1	1000	4000
S200X400VA1Y	White print-on area, vinyl label for 2 – 1 AWG wires.	2.00	50.8	4.00	101.6	1.00	25.4	0.32	8.1	0.95	24.3	500	2000
S200X400VATY*	White print-on area, vinyl label for 2 – 1 AWG wires.	2.00	50.8	4.00	101.6	1.00	25.4	0.32	8.1	0.95	24.3	1000	3000
S200X650VA1Y	White print-on area, vinyl label for 1/0 – 250 MCM wires.	2.00	50.8	6.50	165.1	1.50	38.1	0.48	12.1	1.59	40.4	250	1000
S200X650VATY*	White print-on area, vinyl label for 1/0 – 250 MCM wires.	2.00	50.8	6.50	165.1	1.50	38.1	0.48	12.1	1.59	40.4	1000	2000

Order number of labels required in multiples of Std. Pkg. Qty.

Use with Panduit thermal transfer hybrid or wax ribbons.

\*Labels are roll mounted on 3.00" cores; when using the TDP43MY printer and 3.00" cores, the roll stand (TDP43M-RS) is required.

A.  
System  
Overview

B1.  
Cable Ties

B2.  
Cable  
Accessories

B3.  
Stainless  
Steel Ties

C1.  
Wiring  
Duct

C2.  
Surface  
Raceway

C3.  
Abrasion  
Protection

C4.  
Cable  
Management

D1.  
Terminals

D2.  
Power  
Connectors

D3.  
Grounding  
Connectors

E1.  
Labeling  
Systems

E2.  
Labels

E3.  
Pre-Printed  
& Write-On  
Markers

E4.  
Permanent  
Identification

E5.  
Lockout/  
Tagout  
& Safety  
Solutions

F.  
Index



## NEW! Turn-Tell™ Labels

A. System Overview

B1. Cable Ties

- Innovative label design allows labels to rotate for visibility from any angle, and for repositioning on the wire/cable to align legends and improve aesthetics

- For use with Easy-Mark™ Labeling Software and desktop thermal transfer printers

B2. Cable Accessories

- Labels can be easily installed on existing terminated wires and assemblies without disconnecting the wires/cables

- Temperature range: -40°F to 200°F (-40°C to 93°C)

B3. Stainless Steel Ties

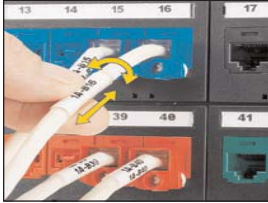

C1. Wiring Duct

C2. Surface Raceway

Part Number	Part Description	Width		Length		Print-On Area Height		Min. Cable O.D.		Max. Wire O.D.		Std. Pkg. Qty.	Std. Ctn. Qty.
		In.	mm	In.	mm	In.	mm	In.	mm	In.	mm		
<b>R100X075V1T</b>	White, 18 – 14 AWG wire/cable.	1.00	25.4	0.75	19.1	0.25	6.4	0.12	3.1	0.16	4.1	2500	10000
<b>R100X125V1T</b>	White, 12 – 10 AWG wire/cable.	1.00	25.4	1.25	31.8	0.38	9.7	0.16	4.1	0.22	5.6	2500	10000
<b>R100X150V1T</b>	White, Cat 5/5e/6 cable.	1.00	25.4	1.50	38.1	0.50	12.7	0.22	5.6	0.28	7.11	2500	10000
<b>R100X150V2T</b>	Blue, Cat 5/5e/6 cable.	1.00	25.4	1.50	38.1	0.50	12.7	0.22	5.6	0.28	7.11	2500	10000
<b>R100X150V3T</b>	Green, Cat 5/5e/6 cable.	1.00	25.4	1.50	38.1	0.50	12.7	0.22	5.6	0.28	7.11	2500	10000
<b>R100X150V7T</b>	Red, Cat 5/5e/6 cable.	1.00	25.4	1.50	38.1	0.50	12.7	0.22	5.6	0.28	7.11	2500	10000
<b>R100X150V8T</b>	Yellow, Cat 5/5e/6 cable.	1.00	25.4	1.50	38.1	0.50	12.7	0.22	5.6	0.28	7.11	2500	10000
<b>R100X225V1T</b>	White, 8 – 4 AWG wire/cable.	1.00	25.4	2.25	57.2	0.75	19.1	0.28	7.1	0.39	9.9	2500	10000
<b>R100X225V2T</b>	Blue, 8 – 4 AWG wire/cable.	1.00	25.4	2.25	57.2	0.75	19.1	0.28	7.1	0.39	9.9	2500	10000
<b>R100X225V3T</b>	Green, 8 – 4 AWG wire/cable.	1.00	25.4	2.25	57.2	0.75	19.1	0.28	7.1	0.39	9.9	2500	10000
<b>R100X225V7T</b>	Red, 8 – 4 AWG wire/cable.	1.00	25.4	2.25	57.2	0.75	19.1	0.28	7.1	0.39	9.9	2500	10000
<b>R100X225V8T</b>	Yellow, 8 – 4 AWG wire/cable.	1.00	25.4	2.25	57.2	0.75	19.1	0.28	7.1	0.39	9.9	2500	10000
<b>R100X400V1T</b>	White, 2 AWG – 250 MCM wire/cable.	1.00	25.4	4.00	101.6	1.00	25.4	0.39	9.9	0.95	24.1	1000	4000
<b>R200X225V1T</b>	White, 8 – 4 AWG wire/cable.	2.00	50.8	2.25	57.2	0.75	19.1	0.28	7.1	0.39	9.9	1000	4000
<b>R200X400V1T</b>	White, 2 AWG – 250 MCM wire/cable.	2.00	50.8	4.00	101.6	1.00	25.4	0.39	9.9	0.95	24.1	1000	4000

Order number of labels required in multiples of Std. Pkg. Qty.

D3. Grounding Connectors

## Thermal Transfer Marker Plates

E1. Labeling Systems



- Non-adhesive marker plates offer crisp, clear legends with superior legibility
- Attachable in a horizontal or vertical orientation
- Available in a variety of colors and sizes

- Use with Panduit RMR4BL resin thermal transfer ribbon

- Temperature range: -58°F to 221°F (-50°C to 105°C)

E2. Labels

E3. Pre-Printed & Write-On Markers

Part Number	Part Description	Width		Height		Print-On Area Width		Std. Pkg. Qty.	Std. Ctn. Qty.
		In.	mm	In.	mm	In.	mm		
<b>M300X100Y6T*</b>	Yellow, thermal transfer marker plate.	3.00	76.2	1.00	25.4	1.80	45.7	1	4
<b>M300X100Y7T</b>	White, thermal transfer marker plate.	3.00	76.2	1.00	25.4	1.80	45.7	1	4
<b>M300X050Y6T*</b>	Yellow, thermal transfer marker plate.	3.00	76.2	0.50	12.7	1.80	45.7	1	4
<b>M300X050Y7T</b>	White, thermal transfer marker plate.	3.00	76.2	0.50	12.7	1.80	45.7	1	4
<b>M200X100Y6T*</b>	Yellow, thermal transfer marker plate.	2.00	50.8	1.00	25.4	0.80	20.3	1	4
<b>M200X100Y7T</b>	White, thermal transfer marker plate.	2.00	50.8	1.00	25.4	0.80	20.3	1	4
<b>M200X050Y6T*</b>	Yellow, thermal transfer marker plate.	2.00	50.8	0.50	12.7	1.07	27.3	1	4
<b>M200X050Y7T</b>	White, thermal transfer marker plate.	2.00	50.8	0.50	12.7	1.07	27.3	1	4

\*Other colors available, replace Y6 with AC (Blue), AE (Green), AF (Gray), AG (Orange), and AI (Red).

Order number of marker plates required in multiples of Std. Pkg. Qty.

F. Index

## Thermal Transfer Non-Laminated Labels

- Labels offer crisp, clear legends with superior legibility
- Use as a wrap-around label or flag style marker for wire/cable labeling
- Available in vinyl cloth material for long-term or temporary labeling and supplied on rolls
- Panduit labeling software packages include all label formats for quick and easy label production



### Part Number System for Non-Laminated Labels

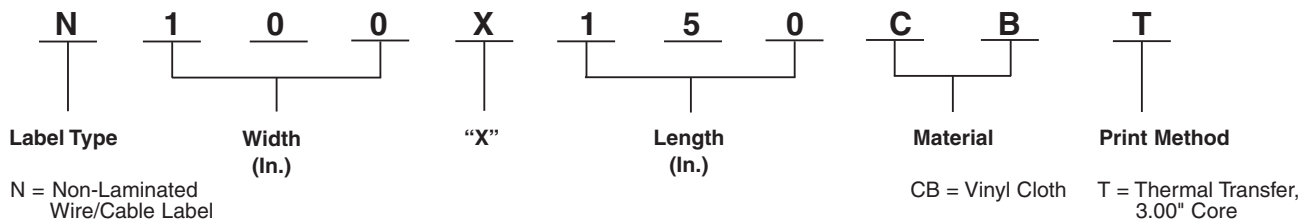

### Material/Print Method Selection Guide

Material	Print Method	Temperature Range	Features
Vinyl Cloth, White (CB)	Thermal Transfer (T)	50°F to 170°F (10°C to 77°C)	Indoor/outdoor rated; thin conformable material with repositionable adhesive allows label to be removed and reused or used in temporary applications; provides durability, high temperature resistance, and dimensional stability for rough or textured surfaces; resists oil and abrasion.

Part Number	Part Description	Width		Length		Min. Cable O.D.		Max. Cable O.D.		Std. Pkg. Qty.	Std. Ctn. Qty.
		In.	mm	In.	mm	In.	mm	In.	mm		
N025X075CBT	White, vinyl cloth label.	0.25	6.35	0.75	19.05	0.24	6.10	0.51	12.95	10000	40000
N025X125CBT	White, vinyl cloth label.	0.25	6.35	1.25	31.75	0.40	10.16	0.85	21.59	10000	40000
N025X150CBT	White, vinyl cloth label.	0.25	6.35	1.50	38.10	0.48	12.19	1.02	25.91	2500	10000
N025X175CBT	White, vinyl cloth label.	0.25	6.35	1.75	44.45	0.56	14.22	1.19	30.23	10000	40000
N050X075CBT	White, vinyl cloth label.	0.50	12.70	0.75	19.05	0.24	6.10	0.51	12.95	10000	40000
N050X100CBT	White, vinyl cloth label.	0.50	12.70	1.00	25.40	0.32	8.13	0.68	17.27	10000	40000
N050X125CBT	White, vinyl cloth label.	0.50	12.70	1.25	31.75	0.40	10.16	0.85	21.59	10000	40000
N050X150CBT	White, vinyl cloth label.	0.50	12.70	1.50	38.10	0.48	12.19	1.02	25.91	2500	10000
N050X175CBT	White, vinyl cloth label.	0.50	12.70	1.75	44.45	0.56	14.12	1.19	30.23	2500	10000
N100X075CBT	White, vinyl cloth label.	1.00	25.40	0.8	19.05	0.24	6.10	0.51	12.95	10000	40000
N100X125CBT	White, vinyl cloth label.	1.00	25.40	1.25	31.75	0.40	10.16	0.85	21.59	5000	20000
N100X150CBT	White, vinyl cloth label.	1.00	25.40	1.50	38.10	0.48	12.19	1.02	25.91	5000	20000
N100X175CBT	White, vinyl cloth label.	1.00	25.40	1.75	44.45	0.56	14.22	1.19	30.23	2500	10000

Order number of labels required in multiples of Std. Pkg. Qty.  
 Use with Panduit thermal transfer hybrid or wax ribbons found on pages E1.13 and E1.14.  
 \*Labels are roll mounted on 3.00" cores; when using the TDP43M printer and 3.00" cores, the roll stand (TDP43M-RS) is required.

A. System Overview

B1. Cable Ties

B2. Cable Accessories

B3. Stainless Steel Ties

C1. Wiring Duct

C2. Surface Raceway

C3. Abrasion Protection

C4. Cable Management

D1. Terminals

D2. Power Connectors

D3. Grounding Connectors

E1. Labeling Systems

E2. Labels

E3. Pre-Printed & Write-On Markers

E4. Permanent Identification

E5. Lockout/Tagout & Safety Solutions

F. Index

A. System Overview

## Thermal Transfer Military Grade Heat Shrink Labels

- Labels offer crisp, clear legends with superior legibility
- Meets UL Standard 224 for flammability and AMS-DTL-23053/5C (Class 1 and Class 3)
- Will meet MIL-M-81531, MIL-STD202F, and MIL-STD-883E when printed with RMH4BL or RHH4BL-S ribbons
- Shrink ratio 3:1
- Pre-cut flattened polyolefin is both thermal transfer and dot matrix printable and supplied roll mounted on plastic carrier
- Panduit labeling software packages include all label formats for quick and easy label production

B1. Cable Ties

B2. Cable Accessories



B3. Stainless Steel Ties

C1. Wiring Duct

## Part Number System for Heat Shrink Labels

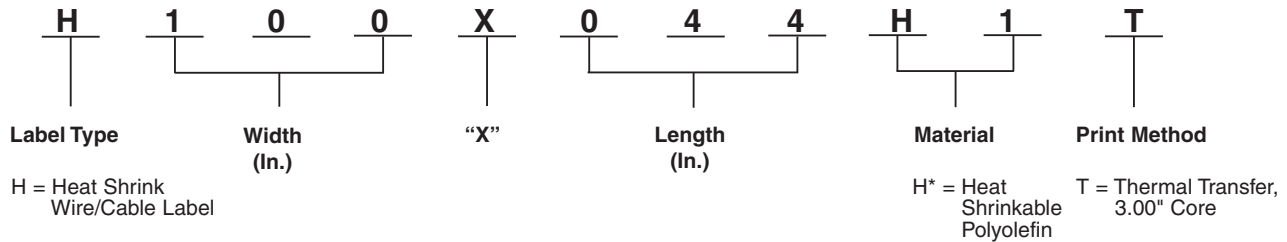

C2. Surface Raceway

C3. Abrasion Protection

C4. Cable Management

### Material/Print Method Selection Guide

Material	Print Method	Temperature Range	Features
Heat Shrinkable Polyolefin, White (H1) Yellow (H2) Black (H3) Red (H4)	Thermal Transfer (T)	-67°F to 275°F (-55°C to 135°C)	Durable flattened polyolefin, high quality heat shrink wire/cable labels.

D2. Power Connectors

D3. Grounding Connectors

E1. Labeling Systems

E2. Labels

E3. Pre-Printed & Write-On Markers

E4. Permanent Identification

E5. Lockout/Tagout & Safety Solutions

F. Index

Part Number	Part Description	Width		Length		Min. Cable O.D.		Max. Cable O.D.		Std. Pkg. Qty.
		In.	mm	In.	mm	In.	mm	In.	mm	
<b>H050X025H1T*</b>	White, 1/8" diameter polyolefin, 2000/roll.	0.50	12.7	0.25	6.4	0.04	1.0	0.13	3.3	1
<b>H050X025H1T-B</b>	White, 1/8" diameter polyolefin, 10000/roll.	0.50	12.7	0.25	6.4	0.04	1.0	0.13	3.3	1
<b>H050X034H1T*</b>	White, 3/16" diameter polyolefin, 2000/roll.	0.50	12.7	0.34	8.6	0.06	1.5	0.19	4.8	1
<b>H050X034H1T-B</b>	White, 3/16" diameter polyolefin, 10000/roll.	0.50	12.7	0.34	8.6	0.06	1.5	0.19	4.8	1
<b>H050X044H1T*</b>	White, 1/4" diameter polyolefin, 2000/roll.	0.50	12.7	0.44	11.2	0.08	2.0	0.25	6.4	1
<b>H050X044H1T-B</b>	White, 1/4" diameter polyolefin, 10000/roll.	0.50	12.7	0.44	11.2	0.08	2.0	0.25	6.4	1
<b>H050X064H1T*</b>	White, 3/8" diameter polyolefin, 2000/roll.	0.50	12.7	0.64	16.3	0.13	3.3	0.38	9.7	1
<b>H050X064H1T-B</b>	White, 3/8" diameter polyolefin, 10000/roll.	0.50	12.7	0.64	16.3	0.13	3.3	0.38	9.7	1
<b>H075X025H1T*</b>	White, 1/8" diameter polyolefin, 1000/roll.	0.75	19.1	0.25	6.4	0.04	1.0	0.13	3.3	1
<b>H075X034H1T*</b>	White, 1/8" diameter polyolefin, 1000/roll.	0.75	19.1	0.25	6.4	0.04	1.0	0.13	3.3	1
<b>H075X044H1T*</b>	White, 1/8" diameter polyolefin, 5000/roll.	0.75	19.1	0.25	6.4	0.04	1.0	0.13	3.3	1
<b>H100X025H1T*</b>	White, 1/8" diameter polyolefin, 1000/roll.	1.00	25.4	0.25	6.4	0.04	1.0	0.13	3.3	1
<b>H100X025H1T-B</b>	White, 1/8" diameter polyolefin, 5000/roll.	1.00	25.4	0.25	6.4	0.04	1.0	0.13	3.3	1
<b>H100X034H1T*</b>	White, 3/16" diameter polyolefin, 1000/roll.	1.00	25.4	0.34	8.6	0.06	1.5	0.19	4.8	1
<b>H100X034H1T-B</b>	White, 3/16" diameter polyolefin, 5000/roll.	1.00	25.4	0.34	8.6	0.06	1.5	0.19	4.8	1
<b>H100X044H1T*</b>	White, 1/4" diameter polyolefin, 1000/roll.	1.00	25.4	0.44	11.2	0.08	2.0	0.25	6.4	1
<b>H100X044H1T-B</b>	White, 1/4" diameter polyolefin, 5000/roll.	1.00	25.4	0.44	11.2	0.08	2.0	0.25	6.4	1
<b>H100X064H1T*</b>	White, 3/8" diameter polyolefin, 1000/roll.	1.00	25.4	0.64	16.3	0.13	3.3	0.38	9.7	1
<b>H100X064H1T-B</b>	White, 3/8" diameter polyolefin, 5000/roll.	1.00	25.4	0.64	16.3	0.13	3.3	0.38	9.7	1

\*Other colors available, replace H1T with H2T (Yellow), H3T (Black), and H4T (Red).  
Order number of rolls required.

## Thermal Transfer Military Grade Heat Shrink Labels (continued)

Part Number	Part Description	Width		Length		Min. Cable O.D.		Max. Cable O.D.		Std. Pkg. Qty.
		In.	mm	In.	mm	In.	mm	In.	mm	
H100X084H1T*	White, 1/2" diameter polyolefin, 1000/roll.	1.00	25.4	0.84	21.3	0.170	4.3	0.50	12.7	1
H100X165H1T*	White, 1" diameter polyolefin, 500/roll.	1.00	25.4	1.65	41.9	0.33	8.4	1.00	25.4	1
H150X025H1T*	White, 1/8" diameter polyolefin, 500/roll.	1.50	38.1	0.25	6.4	0.04	1.0	0.13	3.3	1
H150X034H1T*	White, 3/16" diameter polyolefin, 500/roll.	1.50	38.1	0.34	8.6	0.06	1.5	0.19	4.8	1
H150X044H1T*	White, 1/4" diameter polyolefin, 500/roll.	1.50	38.1	0.44	11.2	0.08	2.0	0.25	6.4	1
H200X025H1T*	White, 1/8" diameter polyolefin, 500/roll.	2.00	50.8	0.25	6.4	0.04	1.0	0.13	3.2	1
H200X025H1T-B	White, 1/8" diameter polyolefin, 2500/roll.	2.00	50.8	0.25	6.4	0.04	1.0	0.13	3.2	1
H200X034H1T*	White, 3/16" diameter polyolefin, 500/roll.	2.00	50.8	0.34	8.6	0.06	1.5	0.19	4.8	1
H200X034H1T-B	White, 3/16" diameter polyolefin, 2500/roll.	2.00	50.8	0.34	8.6	0.06	1.5	0.19	4.8	1
H200X044H1T*	White, 1/4" diameter polyolefin, 500/roll.	2.00	50.8	0.44	11.2	0.08	2.0	0.25	6.4	1
H200X044H1T-B	White, 1/4" diameter polyolefin, 2500/roll.	2.00	50.8	0.44	11.2	0.08	2.0	0.25	6.4	1
H200X064H1T*	White, 3/8" diameter polyolefin, 500/roll.	2.00	50.8	0.64	16.3	0.13	3.3	0.38	9.7	1
H200X064H1T-B	White, 3/8" diameter polyolefin, 2500/roll.	2.00	50.8	0.64	16.3	0.13	3.3	0.38	9.7	1
H200X084H1T*	White, 1/2" diameter polyolefin, 500/roll.	2.00	50.8	0.84	21.3	0.170	4.3	0.50	12.7	1
H200X084H2T	Yellow, 1/2" diameter polyolefin, 500/roll.	2.00	50.8	0.84	21.3	0.170	4.3	0.50	12.7	1
H200X165H1T*	White, 1" diameter polyolefin, 250/roll.	2.00	50.8	1.65	41.9	0.33	8.4	1.00	25.4	1

\*Other colors available, replace H1T with H2T (Yellow), H3T (Black), and H4T (Red).  
Order number of rolls required.

A.  
System  
Overview

B1.  
Cable Ties

B2.  
Cable  
Accessories

B3.  
Stainless  
Steel Ties

C1.  
Wiring  
Duct

C2.  
Surface  
Raceway

C3.  
Abrasion  
Protection

C4.  
Cable  
Management

D1.  
Terminals

D2.  
Power  
Connectors

D3.  
Grounding  
Connectors

E1.  
Labeling  
Systems

E2.  
Labels

E3.  
Pre-Printed  
& Write-On  
Markers

E4.  
Permanent  
Identification

E5.  
Lockout/  
Tagout  
& Safety  
Solutions

F.  
Index

## **NEW!** 2-Sided Military Grade Printable Heat Shrink Labels

A. System Overview

B1. Cable Ties

B2. Cable Accessories

B3. Stainless Steel Ties

C1. Wiring Duct

C2. Surface Raceway

C3. Abrasion Protection

C4. Cable Management

D1. Terminals

D2. Power Connectors

D3. Grounding Connectors

E1. Labeling Systems

E2. Labels

E3. Pre-Printed & Write-On Markers

E4. Permanent Identification

E5. Lockout/Tagout & Safety Solutions

F. Index

- Labels offer crisp, clear legends with superior legibility
- Meets UL Standard 224 for flammability and AMS-DTL-23053/5C (Class 1 and Class 3)
- Will meet MIL-M-81531, MIL-STD202F, and MIL-STD-883E when printed with RMH4BL or RHH4BL-S ribbons
- Shrink ratio 3:1
- Pre-cut flattened polyolefin is thermal transfer printable and supplied roll mounted on plastic carrier
- Panduit labeling software packages include all label formats for quick and easy label production



Part Number*	Part Description	Width		Height		Min. Cable O.D.		Max. Wire O.D.		Std. Pkg. Qty.	Std. Ctn. Qty.
		In.	mm	In.	mm	In.	mm	In.	mm		
<b>H100X025H1T-2</b>	2-sided Military Grade printable heat shrink label, white, 1/8" (3.1mm) diameter polyolefin, 1000/roll.	1.00	25.4	0.25	6.4	0.04	1.0	0.13	3.3	1	—
<b>H100X025H1T-2-B</b>	2-sided Military Grade printable heat shrink label, white, 1/8" diameter polyolefin, 5000/roll.	1.00	25.4	0.25	6.4	0.04	1.0	0.13	3.3	1	1
<b>H100X034H1T-2</b>	2-sided Military Grade printable heat shrink label, white, 3/16" (4.7mm) diameter polyolefin, 1000/roll.	1.00	25.4	0.34	8.6	0.06	1.5	0.19	4.8	1	—
<b>H100X034H1T-2-B</b>	2-sided Military Grade printable heat shrink label, white, 3/16" diameter polyolefin, 5000/roll.	1.00	25.4	0.34	8.6	0.06	1.5	0.19	4.0	1	1
<b>H100X044H1T-2</b>	2-sided Military Grade printable heat shrink label, white, 1/4" (6.3mm) diameter polyolefin, 1000/roll.	1.00	25.4	0.44	11.2	0.08	2.0	0.25	6.4	1	—
<b>H100X044H1T-2-B</b>	2-sided Military Grade printable heat shrink label, white, 1/4" diameter polyolefin, 5000/roll.	1.00	25.4	0.44	11.2	0.08	2.0	0.25	6.4	1	1
<b>H100X064H1T-2</b>	2-sided Military Grade printable heat shrink label, white, 3/8" (9.5mm) diameter polyolefin, 1000/roll.	1.00	25.4	0.64	16.3	0.13	3.3	0.38	9.7	1	—
<b>H100X064H1T-2-B</b>	2-sided Military Grade printable heat shrink label, white, 3/8" diameter polyolefin, 5000/roll.	1.00	25.4	0.64	16.3	0.13	3.3	0.38	9.7	1	—
<b>H100X084H1T-2</b>	2-sided Military Grade printable heat shrink label, white, 1/2" (12.7mm) diameter polyolefin, 1000/roll.	1.00	25.4	0.84	21.3	0.170	4.3	0.50	12.7	1	—
<b>H100X084H1T-2-B</b>	2-sided Military Grade printable heat shrink label, white, 1/2" (12.7mm) diameter polyolefin, 5000/roll.	1.00	25.4	0.84	21.3	0.17	4.3	0.50	12.7	1	1
<b>H100X122H1T-2</b>	2-sided Military Grade printable heat shrink label, white, 3/4" (19.0mm) diameter polyolefin, 500/roll.	1.00	25.4	1.22	31.0	0.04	1.0	0.13	3.3	1	—
<b>H100X165H1T-2</b>	2-sided Military Grade printable heat shrink label, white, 1" (25.4mm) diameter polyolefin, 500/roll.	1.00	25.4	1.65	41.9	0.33	8.4	1.00	25.4	1	—
<b>H200X025H1T-2</b>	2-sided Military Grade printable heat shrink label, white, 1/8" (3.1mm) diameter polyolefin, 500/roll.	2.00	50.8	0.25	6.4	0.04	1.0	0.13	3.3	1	—

\*Other color available, replace H1T with H2T (Yellow).  
Order number of labels required in multiples of Std. Pkg. Qty.



## 2-Sided Military Grade Printable Heat Shrink Labels (continued)

Part Number*	Part Description	Width		Height		Min. Cable O.D.		Max. Wire O.D.		Std. Pkg. Qty.	Std. Ctn. Qty.
		In.	mm	In.	mm	In.	mm	In.	mm		
H200X025H1T-2-B	2-sided Military Grade printable heat shrink label, white, 1/8" diameter polyolefin, 2500/roll.	2.00	50.8	0.25	6.4	0.04	1.0	0.13	3.3	1	—
H200X034H1T-2	2-sided Military Grade printable heat shrink label, white, 3/16" (4.7mm) diameter polyolefin, 500/roll.	2.00	50.8	0.34	8.7	0.06	1.5	0.19	4.8	1	—
H200X034H1T-2-B	2-sided Military Grade printable heat shrink label, white, 3/16" diameter polyolefin, 2500/roll.	2.00	50.8	0.34	8.6	0.06	1.5	0.19	4.0	1	1
H200X044H1T-2	2-sided Military Grade printable heat shrink label, white, 1/4" (6.3mm) diameter polyolefin, 500/roll.	2.00	50.8	0.44	11.2	0.08	2.0	0.25	6.4	1	—
H200X044H1T-2-B	2-sided Military Grade printable heat shrink label, white, 1/4" diameter polyolefin, 2500/roll.	2.00	50.8	0.44	11.2	0.08	2.0	0.25	6.4	1	1
H200X064H1T-2	2-sided Military Grade printable heat shrink label, white, 3/8" (9.5mm) diameter polyolefin, 500/roll.	2.00	50.8	0.64	16.3	0.13	3.3	0.38	9.7	1	—
H200X064H1T-2-B	2-sided Military Grade printable heat shrink label, white, 3/8" diameter polyolefin, 2500/roll.	2.00	50.8	0.64	16.3	0.13	3.3	0.38	9.7	1	1
H200X084H1T-2	2-sided Military Grade printable heat shrink label, white, 1/2" (12.7mm) diameter polyolefin, 500/roll.	2.00	50.8	0.84	21.3	0.170	4.3	0.50	12.7	1	—
H200X084H1T-2-B	2-sided Military Grade printable heat shrink label, white, 1/2" (12.7mm) diameter polyolefin, 2500/roll.	2.00	50.8	0.84	21.3	0.17	4.3	0.50	12.7	1	1
H200X122H1T-2	2-sided Military Grade printable heat shrink label, white, 3/4" (19.0mm) diameter polyolefin, 250/roll.	2.00	50.8	1.22	31.0	0.25	6.3	0.75	19.0	1	—
H200X165H1T-2	2-sided Military Grade printable heat shrink label, white, 1" (25.4mm) diameter polyolefin, 250/roll.	2.00	50.8	1.65	41.9	0.33	8.4	1.00	25.4	1	—

\*Other color available, replace H1T with H2T (Yellow).  
Order number of labels required in multiples of Std. Pkg. Qty.

### Heat Shrink Tools and Accessories

- Adjustable air intake regulator provides variable temperature adjustment within the units rated heat range
- Toggle type control switch provides hot/cold/off operation
- Replaceable brushes are easy to service and extend the operating life of the gun
- Unique suspended quick change heating element design prolongs life and eases servicing



Part Number	Part Description	Std. Pkg. Qty.	Std. Ctn. Qty.
HSG-115V-650	Heat gun with temperature range of 650°F (344°C) to 900°F (482°C).	1	—
HSG-A1	Shrink tube reflector for tubing up to 3/4" inside diameter. Directs heat around tubing to reduce shrink time.	1	10
HSG-A2	Shrink tube reflector for tubing up to 1 1/2" inside diameter. Directs heat around tubing to reduce shrink time.	1	10
HSG-A3	Shrink tube concentrator. Directs heat toward tubing and away from heat sensitive items.	1	10
HSG-A4	Black polyethylene case stores heat gun, stand, and all three accessories.	1	—
HSG-P1	Replacement brush/spring kit.	1	5
HSG-P2	Replacement switch 20 Amps.	1	5
HSG-P3	Replacement bearing kit.	1	5
HSG-P7	Replacement heat element 650°F.	1	—

A.  
System  
Overview

## Thermal Transfer Component Labels

- Labels offer crisp, clear legends with superior legibility
- Available in polyester, vinyl cloth, and polyimide materials and supplied on rolls

- Designed for use with thermal transfer desktop printers, including the TDP43MY and TDP42HY printers
- Panduit labeling software packages include all label formats for quick and easy label production

B1.  
Cable Ties

B2.  
Cable Accessories

B3.  
Stainless  
Steel Ties



C1.  
Wiring  
Duct

## Part Number System for Component Labels

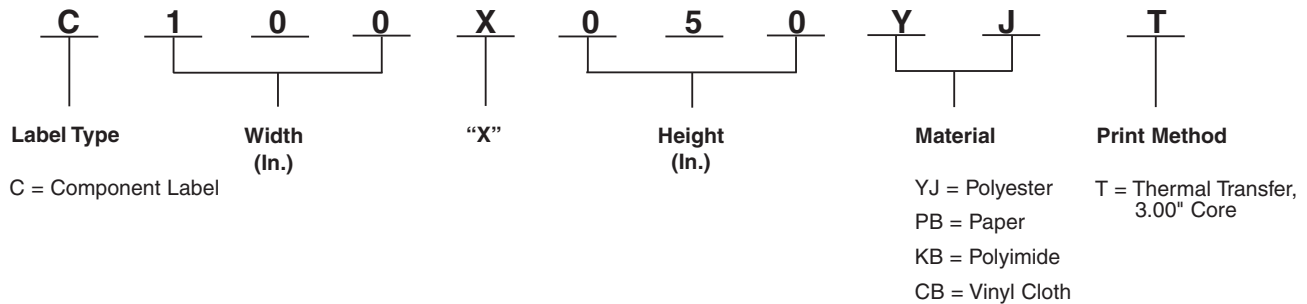

C2.  
Surface Raceway

C3.  
Abrasion  
Protection

C4.  
Cable  
Management

D1.  
Terminals

### Material/Print Method Selection Guide

Material	Print Method	Temperature Range	Features
Polyester, White (YJ)	Thermal Transfer (T)	-40°F to 302°F (-40°C to 150°C)	Indoor/outdoor rated; provides durability, high temperature resistance and dimensional stability; does not stretch or easily tear.
Paper, White (PB)		-65°F to 160°F (-54°C to 71°C)	Indoor rated; general purpose material; excellent adhesion properties when applied to a clean dry surface.
Polyimide, White (KB)		-40°F to 350°F (-40°C to 177°C)	Indoor rated; ideal for electronic components and internal circuitry applications; material is intended for applications requiring solvent and high temperature resistance performance, such as the wave solder process.
Vinyl Cloth, White (CB) Silver (YM) Clear (YK)		50°F to 170°F (10°C to 77°C)	Indoor/outdoor rated; thin conformable material with repositionable adhesive allows label to be removed and reused or used in temporary applications; provides durability, high temperature resistance, and dimensional stability for rough or textured surfaces; resists oil and abrasion.

D2.  
Power Connectors

D3.  
Grounding  
Connectors

E1.  
Labeling Systems

E2.  
Labels

E3.  
Pre-Printed  
& Write-On  
Markers

E4.  
Permanent  
Identification

E5.  
Lockout/  
Tagout/  
& Safety  
Solutions

F.  
Index

## Thermal Transfer Component Labels (continued)

Part Number	Part Description	Width		Height		Std. Pkg. Qty.	Std. Ctn. Qty.
		In.	mm	In.	mm		
C025X025KBT	White, polyimide label.	0.25	6.4	0.25	6.4	10000	40000
C025X025KCT	Tan, polyimide label.	0.25	6.4	0.25	6.4	10000	40000
C025X025YJT	White, polyester label.	0.25	6.4	0.25	6.4	10000	40000
C038X038KBT	White, polyimide label.	0.38	9.7	0.38	9.7	10000	40000
C038X038KCT	Tan, polyimide label.	0.38	9.7	0.38	9.7	10000	40000
C038X038YJT	White, polyester label.	0.38	9.7	0.38	9.7	10000	40000
C050X013KBT	White, polyimide label.	0.50	12.7	0.13	3.3	10000	40000
C050X013KCT	Tan, polyimide label.	0.50	12.7	0.13	3.3	10000	40000
C050X020KBT	White, polyimide label.	0.50	12.7	0.20	5.1	10000	40000
C050X044KCT	Tan, polyimide label.	0.50	12.7	0.44	11.2	10000	40000
C050X044CBT	White, vinyl cloth label.	0.50	12.7	0.44	11.2	10000	40000
C050X044KBT	White, polyimide label.	0.50	12.7	0.44	11.2	10000	40000
C050X044YJT	White, polyester label.	0.50	12.7	0.44	11.2	10000	40000
C060X020CBT	White, vinyl cloth label.	0.60	15.2	0.20	5.1	10000	40000
C060X020KBT	White, polyimide label.	0.60	15.2	0.20	5.1	10000	40000
C060X020KCT	Tan, polyimide label.	0.60	15.3	0.20	5.1	10000	40000
C060X020YJT	White, polyester label.	0.60	15.2	0.20	5.1	10000	40000
C065X019KBT	White, polyimide label.	0.65	16.5	0.19	4.8	10000	40000
C065X019KCT	Tan, polyimide label.	0.65	16.5	0.19	4.8	10000	40000
C075X025CBT	White, vinyl cloth label.	0.75	19.1	0.25	6.4	10000	40000
C075X025KBT	White, polyimide label.	0.75	19.1	0.25	6.4	10000	40000
C075X025KCT	Tan, polyimide label.	0.75	19.1	0.25	6.4	10000	40000
C075X025YJT	White, polyester label.	0.75	19.1	0.25	6.4	10000	40000
C080X020KBT	White, polyimide label.	0.80	20.3	0.20	5.1	10000	40000
C080X020KCT	Tan, polyimide label.	0.80	20.3	0.20	5.1	10000	40000
C080X020YJT	White, polyester label.	0.80	20.3	0.20	5.1	10000	40000
C090X025KBT	White, polyimide label.	0.90	22.9	0.25	6.4	10000	40000
C090X025KCT	Tan, polyimide label.	0.90	22.9	0.25	6.4	10000	40000
C090X025YJT	White, polyester label.	0.90	22.9	0.25	6.4	10000	40000
C100X019KBT	White, polyimide label.	1.00	25.4	0.19	4.8	10000	40000
C100X019KCT	Tan, polyimide label.	1.00	25.4	0.19	4.8	10000	40000
C100X025CBT	White, vinyl cloth label.	1.00	25.4	0.25	6.4	10000	40000
C100X025KBT	White, polyimide label.	1.00	25.4	0.25	6.4	10000	40000
C100X025KCT	Tan, polyimide label.	1.00	25.4	0.25	6.4	10000	40000
C100X025YJT	White, polyester label.	1.00	25.4	0.25	6.4	10000	40000
C100X038CBT	White, vinyl cloth label.	1.00	25.4	0.38	9.7	10000	40000
C100X038KBT	White, polyimide label.	1.00	25.4	0.38	9.7	10000	40000
C100X038KCT	Tan, polyimide label.	1.00	25.4	0.38	9.7	10000	40000
C100X038YJT	White, polyester label.	1.00	25.4	0.38	9.7	10000	40000
C100X050CBT	White, vinyl cloth label.	1.00	25.4	0.50	12.7	10000	40000
C100X050YJT	White, polyester label.	1.00	25.4	0.50	12.7	10000	40000
C125X025KBT	White, polyimide label.	1.25	31.8	0.25	6.4	10000	40000
C125X025KCT	Tan, polyimide label.	1.25	31.8	0.25	6.4	10000	40000

Order number of labels required in multiples of Std. Pkg. Qty.  
Use with Panduit thermal transfer ribbons.

Labels roll mounted on 3.00" cores; when using the TDP43MY printer and 3.00" cores, the roll stand (TDP43M-RS) is required.

Table continues on page E2.18

A.  
System  
Overview

## Thermal Transfer Component Labels (continued)

B1.  
Cable Ties

Part Number	Part Description	Width		Height		Std. Pkg. Qty.	Std. Ctn. Qty.
		In.	mm	In.	mm		
<b>C125X038YJT</b>	White, polyester label.	1.25	31.8	0.38	9.7	10000	20000
<b>C150X025KBT</b>	White, polyimide label.	1.50	38.1	0.25	6.4	5000	20000
<b>C150X025KCT</b>	Tan, polyimide label.	1.50	38.1	0.25	6.4	5000	20000
<b>C150X050YJT</b>	White, polyester label.	1.50	38.1	0.50	12.7	5000	20000
<b>C150X075YJT</b>	White, polyester label.	1.50	38.1	0.75	19.1	5000	20000
<b>C150X075YMT</b>	Silver, polyester label..	1.50	38.1	0.75	19.1	5000	20000
<b>C150X075CBT</b>	White, vinyl cloth label..	1.50	38.1	0.75	19.1	5000	20000
<b>C160X020CBT</b>	White, vinyl cloth label.	1.60	40.6	0.20	5.1	10000	40000
<b>C160X020KBT</b>	White, polyimide label.	1.60	40.6	0.20	5.1	10000	40000
<b>C160X020KCT</b>	Tan, polyimide label.	1.60	40.6	0.20	5.1	10000	40000
<b>C160X020YJT</b>	White, polyester label.	1.60	40.6	0.20	5.1	10000	40000
<b>C200X025KBT</b>	White, polyimide label.	2.00	50.8	0.25	6.4	5000	20000
<b>C200X025KCT</b>	Tan, polyimide label.	2.00	50.8	0.25	6.4	5000	20000
<b>C200X025YJT</b>	White, polyester label.	2.00	50.8	0.25	6.4	5000	20000
<b>C200X038YJT</b>	White, polyester label.	2.00	50.8	0.38	9.7	5000	20000
<b>C200X038KBT</b>	White, polyimide label.	2.00	50.8	0.38	9.7	5000	20000
<b>C200X050CBT</b>	White, vinyl cloth label.	2.00	50.8	0.50	12.7	5000	20000
<b>C200X050YJT</b>	White, polyester label.	2.00	50.8	0.50	12.7	5000	20000
<b>C200X100YJT</b>	White, polyester label.	2.00	50.8	1.00	25.4	2500	10000
<b>C200X100YKT</b>	Clear, polyester label.	2.00	50.8	1.00	25.4	2500	10000
<b>C200X100YMT</b>	Silver, polyester label.	2.00	50.8	1.00	25.4	2500	10000
<b>C275X125YMT</b>	Silver, polyester label.	2.75	69.9	1.25	31.8	2500	10000
<b>C275X125YJT</b>	White, polyester label.	2.75	69.9	1.25	31.8	2500	10000
<b>C275X125YMT</b>	Silver, polyester label.	2.75	69.9	1.25	31.8	2500	10000
<b>C300X025KBT</b>	White, polyimide label.	3.00	76.2	0.25	6.4	5000	20000
<b>C300X025KCT</b>	Tan, polyimide label.	3.00	76.2	0.25	6.4	5000	20000
<b>C300X025YJT</b>	White, polyester label.	3.00	76.2	0.25	6.4	5000	20000
<b>C300X038YJT</b>	White, polyester label.	3.00	76.2	0.38	9.7	5000	20000
<b>C300X100YJT</b>	White, polyester label.	3.00	76.2	1.00	25.4	2500	10000
<b>C300X100YMT</b>	Silver, polyester label.	3.00	76.2	1.00	25.4	2500	10000
<b>C300X200YJT</b>	White, polyester label.	3.00	76.2	2.00	50.8	1000	4000
<b>C300X200YMT</b>	Silver, polyester label.	3.00	76.2	2.00	50.8	1000	4000
<b>C400X100CBT</b>	White, vinyl cloth label.	4.00	101.6	1.00	25.4	2500	10000
<b>C400X100YJT</b>	White, polyester label.	4.00	101.6	1.00	25.4	2500	10000
<b>C400X200YJT</b>	White, polyester label.	4.00	101.6	2.00	50.8	1000	4000
<b>C400X200YMT</b>	Silver, polyester label..	4.00	101.6	2.00	50.8	1000	4000
<b>C400X300YJT</b>	White, polyester label..	4.00	101.6	3.00	76.2	2500	10000
<b>C400X400YJT</b>	White, polyester label.	4.00	101.6	4.00	101.6	1000	4000
<b>C400X600PBT</b>	White, paper label.	4.00	101.6	6.00	152.4	1000	4000
<b>C400X600YJT</b>	White, polyester label.	4.00	101.6	6.00	152.4	1000	4000

Order number of labels required in multiples of Std. Pkg. Qty.  
 Use with Panduit thermal transfer ribbons.  
 Labels roll mounted on 3.00" cores; when using the TDP43MY printer and 3.00" cores, the roll stand (TDP43M-RS) is required.

E5.  
Lockout/  
Tagout/  
& Safety  
Solutions

F.  
Index

## Thermal Transfer Tamper Evident Polyester Component Labels

• Labels offer crisp, clear legends with superior legibility

• Panduit labeling software packages include all label formats for quick and easy label production

Part Number	Part Description	Width		Length		Std. Pkg. Qty.	Std. Ctn. Qty.
		In.	mm	In.	mm		
C075X025AAT	Tamper-evident polyester, silver, for indoor/outdoor applications.	0.75	19.1	0.25	6.4	10000	40000
C100X050AAT	Tamper-evident polyester, silver, for indoor/outdoor applications.	1.00	25.4	0.50	12.7	10000	40000
C200X100AAT	Tamper-evident polyester, silver, for indoor/outdoor applications.	2.00	50.8	1.00	25.4	2500	10000
C275X125AAT	Tamper-evident polyester, silver, for indoor/outdoor applications.	2.75	69.9	1.25	31.8	2500	10000

Order number of labels required in multiples of Std. Pkg. Qty.

Use with Panduit thermal transfer ribbons.

Labels roll mounted on 3.00" cores; when using the TDP43MY printer and 3.00" cores, the roll stand (TDP43M-RS) is required.

## Thermal Transfer Raised Panel Labels



• Raised thermal transfer printable surface with high-tack adhesive for strong holding power

• Variety of sizes and colors for a wide range of applications

• Thermal transfer print technology provides crisp, clear, and durable text

• Use with Panduit RMR4BL-A and RMR4WH resin thermal transfer ribbons



Part Number	Part Description	Width		Height		Print-On Area Height		Hole Diameter		Std. Pkg. Qty.	Std. Ctn. Qty.
		In.	mm	In.	mm	In.	mm	In.	mm		

### Raised Panel Push Button Labels

C120X150APT-22	White, raised panel component label.	1.20	30.5	1.50	38.1	0.45	11.4	0.87	22.0	500	2000
C120X150A8T-22	Yellow, raised panel component label.	1.20	30.5	1.50	38.1	0.45	11.4	0.87	22.0	500	2000
C120X150AST-22	Green, raised panel component label.	1.20	30.5	1.50	38.1	0.45	11.4	0.87	22.0	500	2000
C120X150AWT-22	Red, raised panel component label.	1.20	30.5	1.50	38.1	0.45	11.4	0.87	22.0	500	2000
C120X150A0T-22	Black, raised panel component label.	1.20	30.5	1.50	38.1	0.45	11.4	0.87	22.0	500	2000
C120X150YK-22*	Clear, raised panel component overlaminate label.	1.20	30.5	1.50	38.1	—	—	0.87	22.0	500	2000
C120X190APT-22	White, raised panel component label.	1.20	30.5	1.90	48.3	0.85	21.6	0.87	22.0	500	2000
C120X190A8T-22	Yellow, raised panel component label.	1.20	30.5	1.90	48.3	0.85	21.6	0.87	22.0	500	2000
C120X190AST-22	Green, raised panel component label.	1.20	30.5	1.90	48.3	0.85	21.6	0.87	22.0	500	2000
C120X190AWT-22	Red, raised panel component label.	1.20	30.5	1.90	48.3	0.85	21.6	0.87	22.0	500	2000
C120X190A0T-22	Black, raised panel component label.	1.20	30.5	1.90	48.3	0.85	21.6	0.87	22.0	500	2000
C120X190YK-22*	Clear, raised panel component overlaminate label.	1.20	30.5	1.90	48.3	—	—	0.87	22.0	500	2000

\*Cannot print on overlaminate labels.

Order number of labels required in multiples of Std. Pkg. Qty.

Table continues on page E2.20

A.  
System  
Overview

## Thermal Transfer Raised Panel Labels (continued)

B1.  
Cable Ties

B2.  
Cable Accessories

B3.  
Stainless  
Steel Ties

C1.  
Wiring  
Duct

C2.  
Surface Raceway

C3.  
Abrasion  
Protection

C4.  
Cable  
Management

D1.  
Terminals

D2.  
Power Connectors

D3.  
Grounding  
Connectors

E1.  
Labeling Systems

E2.  
Labels

E3.  
Pre-Printed  
& Write-On  
Markers

E4.  
Permanent  
Identification

E5.  
Lockout/  
Tagout  
& Safety  
Solutions

F.  
Index

Part Number	Part Description	Width		Height		Print-On Area Height		Hole Diameter		Std. Pkg. Qty.	Std. Ctn. Qty.
		In.	mm	In.	mm	In.	mm	In.	mm		
<b>C180X180APT-30</b>	White, raised panel component label.	1.80	45.7	1.80	45.7	0.36	9.1	1.18	30.0	500	2000
<b>C180X180A8T-30</b>	Yellow, raised panel component label.	1.80	45.7	1.80	45.7	0.36	9.1	1.18	30.0	500	2000
<b>C180X180AST-30</b>	Green, raised panel component label.	1.80	45.7	1.80	45.7	0.36	9.1	1.18	30.0	500	2000
<b>C180X180AWT-30</b>	Red, raised panel component label.	1.80	45.7	1.80	45.7	0.36	9.1	1.18	30.0	500	2000
<b>C180X180A0T-30</b>	Black, raised panel component label.	1.80	45.7	1.80	45.7	0.36	9.1	1.18	30.0	500	2000
<b>C180X180YK-30*</b>	Clear, raised panel component overlamine label.	1.80	45.7	1.80	45.7	—	—	1.18	30.0	500	2000
<b>C240X240APT-30</b>	White, raised panel component label.	2.40	61.0	2.40	61.0	0.90	22.9	1.18	30.0	500	2000
<b>C240X240A8T-30</b>	Yellow, raised panel component label.	2.40	60.9	2.40	60.9	0.90	22.9	1.18	30.0	500	2000
<b>C240X240AST-30</b>	Green, raised panel component label.	2.40	60.9	2.40	60.9	0.90	22.9	1.18	30.0	500	2000
<b>C240X240AWT-30</b>	Red, raised panel component label.	2.40	60.9	2.40	60.9	0.90	22.9	1.18	30.0	500	2000
<b>C240X240A0T-30</b>	Black, raised panel component label.	2.40	60.9	2.40	60.9	0.90	22.9	1.18	30.0	500	2000
<b>C240X240YK-30*</b>	Clear, raised panel component overlamine label.	2.40	60.9	2.40	60.9	—	—	1.18	30.0	500	2000

### Raised Panel Component Labels

<b>C100X050APT</b>	White, raised panel component label.	1.00	25.4	0.50	12.7	0.50	12.7	—	—	500	2000
<b>C100X050A8T</b>	Yellow, raised panel component label.	1.00	25.4	0.50	12.7	0.50	12.7	—	—	500	2000
<b>C100X050AST</b>	Green, raised panel component label.	1.00	25.4	0.50	12.7	0.50	12.7	—	—	500	2000
<b>C100X050AWT</b>	Red, raised panel component label.	1.00	25.4	0.50	12.7	0.50	12.7	—	—	500	2000
<b>C100X050A0T</b>	Black, raised panel component label.	1.00	25.4	0.50	12.7	0.50	12.7	—	—	500	2000
<b>C100X050AMT</b>	Silver, raised panel component label.	1.00	25.4	0.50	12.7	0.50	12.7	—	—	500	2000
<b>C200X100APT</b>	White, raised panel component label.	2.00	50.8	1.00	25.4	1.00	25.4	—	—	500	2000
<b>C200X100A8T</b>	Yellow, raised panel component label.	2.00	50.8	1.00	25.4	1.00	25.4	—	—	500	2000
<b>C200X100AST</b>	Green, raised panel component label.	2.00	50.8	1.00	25.4	1.00	25.4	—	—	500	2000
<b>C200X100AWT</b>	Red, raised panel component label.	2.00	50.8	1.00	25.4	1.00	25.4	—	—	500	2000
<b>C200X100A0T</b>	Black, raised panel component label.	2.00	50.8	1.00	25.4	1.00	25.4	—	—	500	2000
<b>C200X100AMT</b>	Silver, raised panel component label.	2.00	50.8	1.00	25.4	1.00	25.4	—	—	500	2000
<b>C200X100YK*</b>	Clear, raised panel component overlamine label.	2.00	50.8	1.00	25.4	—	—	—	—	500	2000
<b>C300X100APT</b>	White, raised panel component label.	3.00	76.2	1.00	25.4	1.00	25.4	—	—	500	2000
<b>C300X100A8T</b>	Yellow, raised panel component label.	3.00	76.2	1.00	25.4	1.00	25.4	—	—	500	2000
<b>C300X100A0T</b>	Black, raised panel component label.	3.00	76.2	1.00	25.4	1.00	25.4	—	—	500	2000
<b>C300X250APT</b>	White, raised panel component label.	3.00	76.2	2.50	63.5	2.50	63.5	—	—	500	2000
<b>C300X250A8T</b>	Yellow, raised panel component label.	3.00	76.2	2.50	63.5	2.50	63.5	—	—	500	2000
<b>C300X250AST</b>	Green, raised panel component label.	3.00	76.2	2.50	63.5	2.50	63.5	—	—	500	2000
<b>C300X250AWT</b>	Red, raised panel component label.	3.00	76.2	2.50	63.5	2.50	63.5	—	—	500	2000
<b>C300X250A0T</b>	Black, raised panel component label.	3.00	76.2	2.50	63.5	2.50	63.5	—	—	500	2000
<b>C300X250AMT</b>	Silver, raised panel component label.	3.00	76.2	2.50	63.5	2.50	63.5	—	—	500	2000
<b>C300X250YK*</b>	Clear, raised panel component overlamine label.	3.00	76.2	2.50	63.5	—	—	—	—	500	2000
<b>C400X100APT</b>	White, raised panel component label.	4.00	101.6	1.00	25.4	1.00	25.4	—	—	500	2000
<b>C400X100A8T</b>	Yellow, raised panel component label.	4.00	101.6	1.00	25.4	1.00	25.4	—	—	500	2000
<b>C400X100AST</b>	Green, raised panel component label.	4.00	101.6	1.00	25.4	1.00	25.4	—	—	500	2000
<b>C400X100AWT</b>	Red, raised panel component label.	4.00	101.6	1.00	25.4	1.00	25.4	—	—	500	2000
<b>C400X100A0T</b>	Black, raised panel component label.	4.00	101.6	1.00	25.4	1.00	25.4	—	—	500	2000
<b>C400X100AMT</b>	Silver, raised panel component label.	4.00	101.6	1.00	25.4	1.00	25.4	—	—	500	2000
<b>C400X100YK*</b>	Clear, raised panel component overlamine label.	4.00	101.6	1.00	25.4	—	—	—	—	500	2000

\*Cannot print on overlamine labels.  
Order number of labels required in multiples of Std. Pkg. Qty.

## Thermal Transfer Continuous Tapes

- Tapes offer crisp, clear legends with superior legibility
- Available in continuous color vinyl or clear polyester and supplied on rolls

- Panduit labeling software packages include all label formats for quick and easy label production



## Part Number System for Continuous Tapes

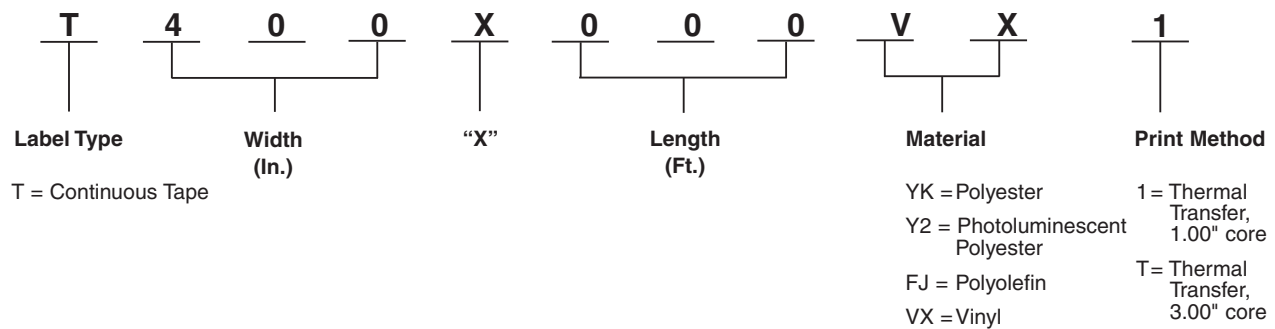

### Material/Print Method Selection Guide

Material	Print Method	Temperature Range	Features
Polyester, Clear (YK)	Thermal Transfer (T)	-51°F to 275°F (-46°C to 135°C)	Indoor/outdoor rated; provides durability, high temperature resistance, and dimensional stability; does not stretch or easily tear
Vinyl, Yellow (VX) Black (VY) Blue (VQ) Brown (VR) Gray (VT) Green (VS) Orange (VU) Purple (VV) Red (VW) White (VP)		-58°F to 176°F (-50°C to 80°C)	Indoor/outdoor rated; conformable material for flat applications and safety and facility identification; can be overlaminated to increase durability

Table continues on page E2.22

A.  
System  
Overview

## Thermal Transfer Continuous Tapes (continued)

B1.  
Cable Ties

B2.  
Cable Accessories

B3.  
Stainless  
Steel Ties

C1.  
Wiring  
Duct

C2.  
Surface Raceway

C3.  
Abrasion  
Protection

C4.  
Cable  
Management

D1.  
Terminals

D2.  
Power Connectors

D3.  
Grounding  
Connectors

E1.  
Labeling Systems

E2.  
Labels

E3.  
Pre-Printed  
& Write-On  
Markers

E4.  
Permanent  
Identification

E5.  
Lockout/  
Tagout  
& Safety  
Solutions

F.  
Index

Part Number	Part Description	Height		Length		Std. Pkg. Qty.	Std. Ctn. Qty.
		In.	mm	Ft.	m		
<b>T100X000VP1Y</b>	White, vinyl tape.	1.00	25.4	100.0	30.5	1	4
<b>T100X000VQ1Y</b>	Blue, vinyl tape.	1.00	25.4	100.00	30.5	1	4
<b>T100X000VS1Y</b>	Green, vinyl tape.	1.00	25.4	100.00	30.5	1	4
<b>T100X000VU1Y</b>	Orange, vinyl tape.	1.00	25.40	100.0	30.5	1	4
<b>T100X000VW1Y</b>	Red, vinyl tape.	1.00	25.4	100.00	30.5	1	4
<b>T100X000VX1Y</b>	Yellow, vinyl tape.	1.00	25.40	100.0	30.5	1	4
<b>T100X000VY1Y</b>	Black, vinyl tape.	1.00	25.4	100.00	30.5	1	4
<b>T100X000YK1</b>	Clear, polyester tape.	1.00	25.4	100.00	30.5	1	4
<b>T200X000VP1Y</b>	White, vinyl tape.	2.00	50.8	100.0	30.5	1	4
<b>T200X000VQ1Y</b>	Blue, vinyl tape.	2.00	50.80	100.0	30.5	1	4
<b>T200X000VS1Y</b>	Green, vinyl tape.	2.00	50.8	100.0	30.5	1	4
<b>T200X000VU1Y</b>	Orange, vinyl tape.	2.00	50.8	100.0	30.5	1	4
<b>T200X000VV1Y</b>	Purple, vinyl tape.	2.00	50.8	100.0	30.5	1	4
<b>T200X000VW1Y</b>	Red, vinyl tape.	2.00	50.8	100.0	30.5	1	4
<b>T200X000VX1Y</b>	Yellow, vinyl tape.	2.00	50.8	100.0	30.5	1	4
<b>T200X000VY1Y</b>	Black, vinyl tape.	2.00	50.8	100.0	30.5	1	4
<b>T200X000YK1</b>	Clear, polyester tape.	2.00	50.8	100.0	30.5	1	4
<b>T225X000YK1</b>	Clear, polyester tape.	2.25	57.2	100.0	30.5	1	4
<b>T400X000VP1Y</b>	White, vinyl tape.	4.00	101.6	100.0	30.5	1	4
<b>T400X000VQ1Y</b>	Blue, vinyl tape.	4.00	101.6	100.0	30.5	1	4
<b>T400X000VS1Y</b>	Green, vinyl tape.	4.00	101.6	100.0	30.5	1	4
<b>T400X000VU1Y</b>	Orange, vinyl tape.	4.00	101.6	100.0	30.5	1	4
<b>T400X000VV1Y</b>	Purple, vinyl tape.	4.00	101.6	100.0	30.5	1	4
<b>T400X000VW1Y</b>	Red, vinyl tape.	4.00	101.6	100.0	30.5	1	4
<b>T400X000VX1Y</b>	Yellow, vinyl tape.	4.00	101.6	100.0	30.5	1	4
<b>T400X000VY1Y</b>	Black, vinyl tape.	4.00	101.6	100.0	30.5	1	4
<b>T400X000YK1</b>	Clear, polyester tape.	4.00	101.6	100.0	30.5	1	4
<b>T425X000YK1</b>	Clear, polyester tape.	4.25	107.9	100.0	30.5	1	4

Order number of rolls required.

Use with Panduit thermal transfer ribbons.

Labels roll mounted on 3.00" cores; when using the TDP43MY printer and 3.00" cores, the roll stand (TDP43M-RS) is required.



## Size Illustrations of Self-Laminating Labels

The illustrations show the following label sizes and part numbers:

- S050X075\*
- S050X125\*
- S050X150\*
- S075X075\*
- S075X125\*
- S075X150\*
- S100X075\*
- S100X125\*
- S100X150\*
- S100X225\*
- S100X400\*
- S150X150\*
- S150X225\*
- S150X400\*

\*Represents material type and print method of part number.

A.  
System  
Overview

B1.  
Cable Ties

B2.  
Cable  
Accessories

B3.  
Stainless  
Steel Ties

C1.  
Wiring  
Duct

C2.  
Surface  
Raceway

C3.  
Abrasion  
Protection

C4.  
Cable  
Management

D1.  
Terminals

D2.  
Power  
Connectors

D3.  
Grounding  
Connectors

E1.  
Labeling  
Systems

E2.  
Labels

E3.  
Pre-Printed  
& Write-On  
Markers

E4.  
Permanent  
Identification

E5.  
Lockout/  
Tagout  
& Safety  
Solutions

F.  
Index

## Size Illustrations of Self-Laminating Labels (continued)

A.  
System  
Overview

B1.  
Cable Ties

B2.  
Cable  
Accessories

B3.  
Stainless  
Steel Ties

C1.  
Wiring  
Duct

C2.  
Surface  
Raceway

C3.  
Abrasion  
Protection

C4.  
Cable  
Management

D1.  
Terminals

D2.  
Power  
Connectors

D3.  
Grounding  
Connectors

E1.  
Labeling  
Systems

E2.  
Labels

E3.  
Pre-Printed  
& Write-On  
Markers

E4.  
Permanent  
Identification

E5.  
Lockout/  
Tagout  
& Safety  
Solutions

F.  
Index

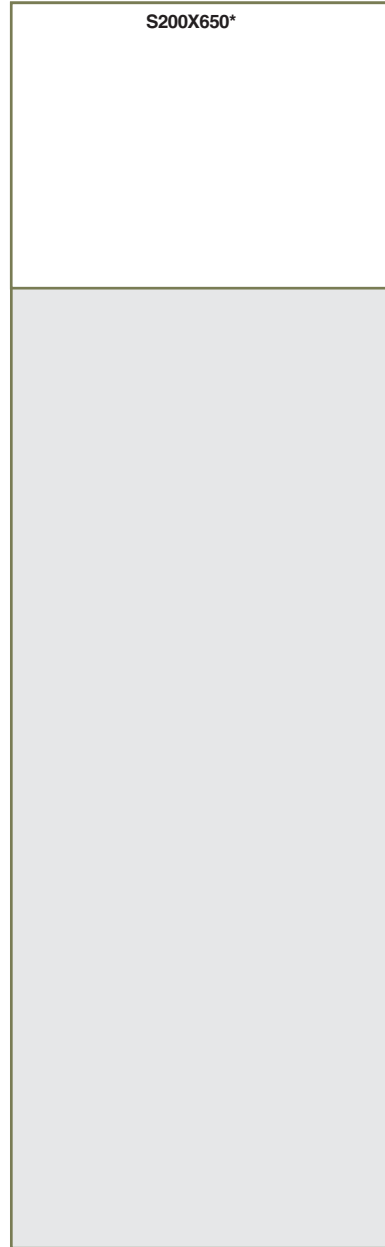
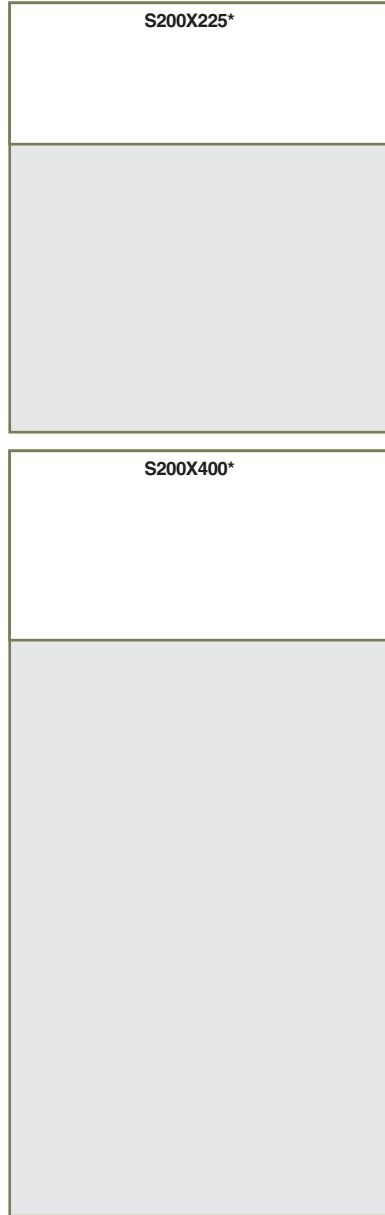
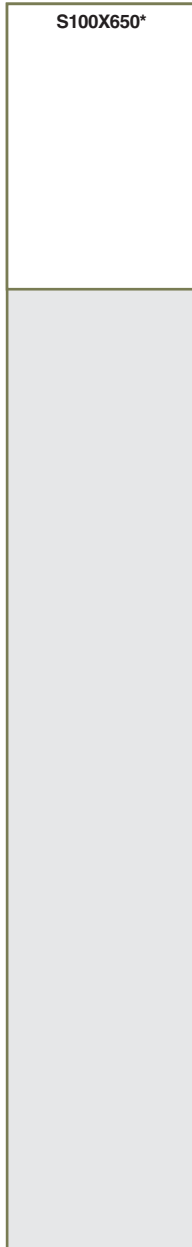

\*Represents material type and print method of part number.

## Size Illustrations of Non-Laminated and Flag Style Labels

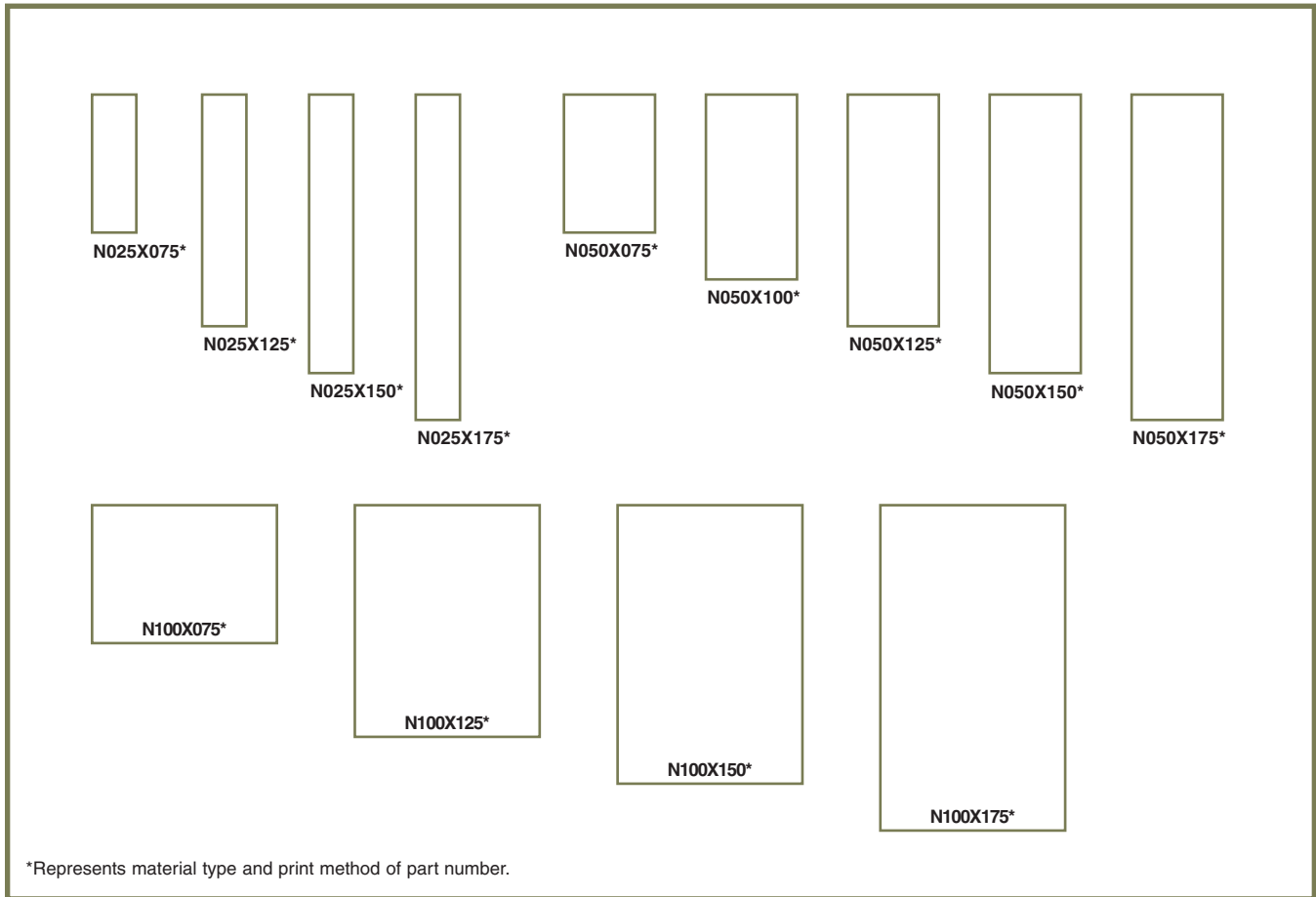

A.  
System  
Overview

B1.  
Cable  
Ties

B2.  
Cable  
Accessories

B3.  
Stainless  
Steel Ties

C1.  
Wiring  
Duct

C2.  
Surface  
Raceway

C3.  
Abrasion  
Protection

C4.  
Cable  
Management

D1.  
Terminals

D2.  
Power  
Connectors

D3.  
Grounding  
Connectors

E1.  
Labeling  
Systems

E2.  
Labels

E3.  
Pre-Printed  
& Write-On  
Markers

E4.  
Permanent  
Identification

E5.  
Lockout/  
Tagout  
& Safety  
Solutions

F.  
Index

## Size Illustrations of Flattened Heat Shrink Labels

A. System Overview

B1. Cable Ties

B2. Cable Accessories

B3. Stainless Steel Ties

C1. Wiring Duct

C2. Surface Raceway

C3. Abrasion Protection

C4. Cable Management

D1. Terminals

D2. Power Connectors

D3. Grounding Connectors

E1. Labeling Systems

E2. Labels

E3. Pre-Printed & Write-On Markers

E4. Permanent Identification

E5. Lockout/Tagout & Safety Solutions

F. Index



H050X025\*



H050X034\*



H050X044\*



H050X064\*



H075X025\*



H075X034\*



H075X044\*



H100X025\*



H100X034\*



H100X044\*

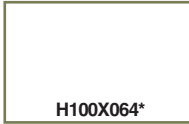

H100X064\*



H100X084\*

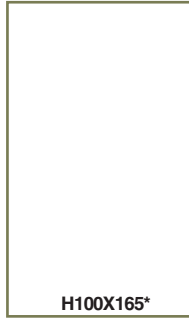

H100X165\*



H150X025\*



H150X034\*



H150X044\*



H200X025\*



H200X034\*



H200X044\*



H200X064\*



H200X084\*



H200X165\*

\*Represents material type and print method of part number.

## Size Illustrations for Component Labels

The following table lists the part numbers and their corresponding dimensions as shown in the illustrations:

Part Number	Dimensions (Approximate)
C025X025*	Small square
C038X038*	Small square
C050X044*	Small square
C060X020*	Small horizontal rectangle
C075X025*	Small horizontal rectangle
C080X020*	Small horizontal rectangle
C100X025*	Small horizontal rectangle
C100X050*	Medium horizontal rectangle
C150X075*	Medium horizontal rectangle
C160X020*	Small horizontal rectangle
C200X050*	Medium horizontal rectangle
C200X075*	Medium horizontal rectangle
C200X100*	Medium horizontal rectangle
C300X100*	Large horizontal rectangle
C400X100*	Large horizontal rectangle
C400X200*	Large horizontal rectangle
C225X450*	Very large vertical rectangle

\*Represents material type and print method of part number.

A.  
System  
Overview

B1.  
Cable Ties

B2.  
Cable  
Accessories

B3.  
Stainless  
Steel Ties

C1.  
Wiring  
Duct

C2.  
Surface  
Raceway

C3.  
Abrasion  
Protection

C4.  
Cable  
Management

D1.  
Terminals

D2.  
Power  
Connectors

D3.  
Grounding  
Connectors

E1.  
Labeling  
Systems

E2.  
Labels

E3.  
Pre-Printed  
& Write-On  
Markers

E4.  
Permanent  
Identification

E5.  
Lockout/  
Tagout  
& Safety  
Solutions

F.  
Index

## Size Illustrations for Component Labels (continued)

A.	System Overview
B1.	Cable Ties
B2.	Cable Accessories
B3.	Stainless Steel Ties
C1.	Wiring Duct
C2.	Surface Raceway
C3.	Abrasion Protection
C4.	Cable Management
D1.	Terminals
D2.	Power Connectors
D3.	Grounding Connectors
E1.	Labeling Systems
E2.	Labels
E3.	Pre-Printed & Write-On Markers
E4.	Permanent Identification
E5.	Lockout/Tagout & Safety Solutions
F.	Index

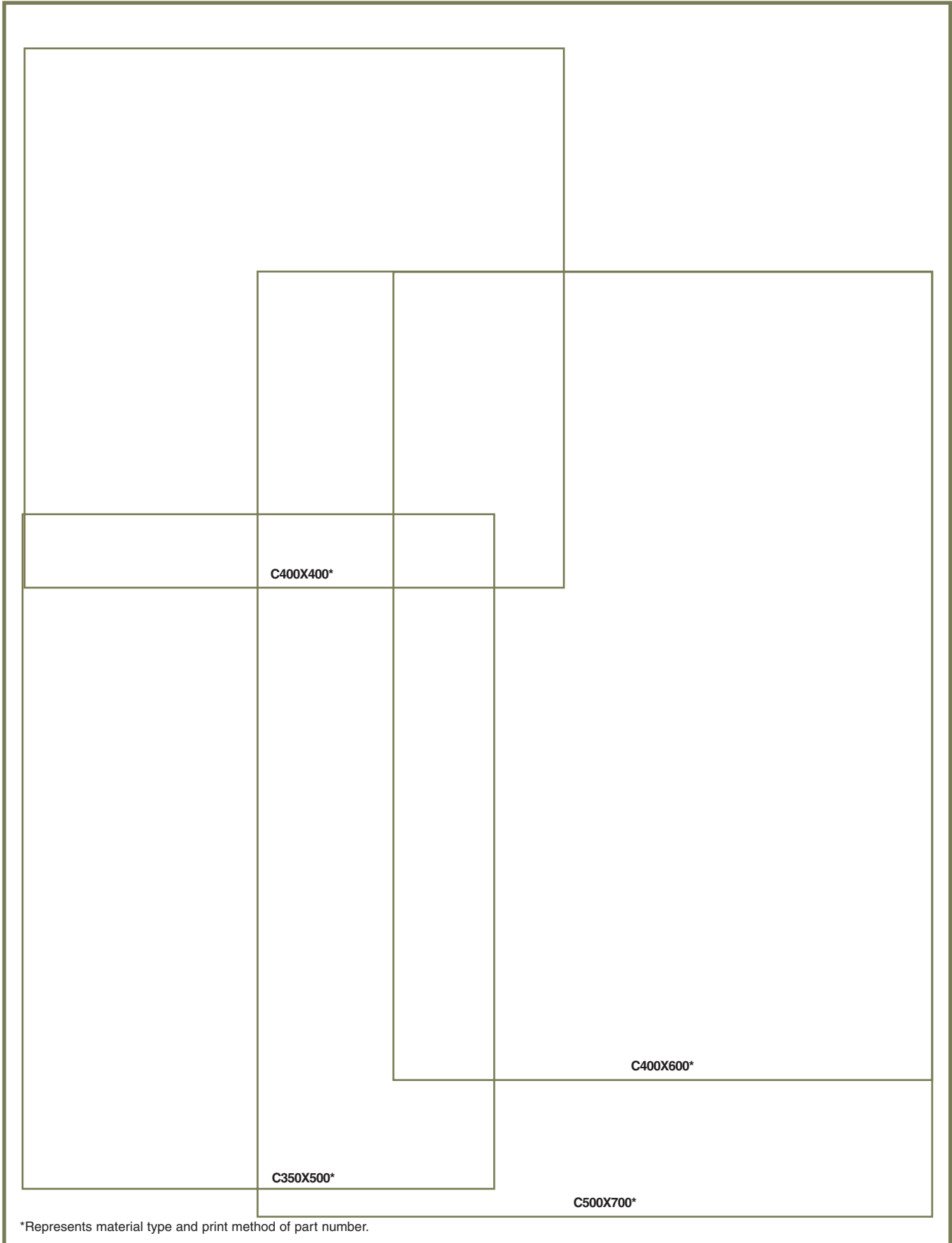

\*Represents material type and print method of part number.

## PRE-PRINTED AND WRITE-ON MARKERS

Panduit offers a variety of pre-printed and write-on marker solutions in multiple formats to meet your specific requirements.



- Marker books are a convenient pocket-sized method to identify many electrical and network components
- Marker cards are available in a variety of legends and combination packs
- Dispensers are available in both pre-printed and write-on formats for quick identification of wire/cable
- Clip-on markers provide a fast, convenient, non-adhesive method to identify wire/cable

Panduit offers a variety of innovative books, cards, clip-ons and dispensers to provide you with the wire/cable label that best fits your needs.

A.  
System  
Overview

B1.  
Cable Ties

B2.  
Cable  
Accessories

B3.  
Stainless  
Steel Ties

C1.  
Wiring  
Duct

C2.  
Surface  
Raceway

C3.  
Abrasion  
Protection

C4.  
Cable  
Management

D1.  
Terminals

D2.  
Power  
Connectors

D3.  
Grounding  
Connectors

E1.  
Labeling  
Systems

E2.  
Labels

E3.  
Pre-Printed  
& Write-On  
Markers

E4.  
Permanent  
Identification

E5.  
Lockout/  
Tagout/  
& Safety  
Solutions

F.  
Index

A. System Overview

## Pre-Printed Marker Books

B1. Cable Ties

- Convenient, pocket-sized book
- Markers are perforated and can be torn in half to mark both ends of conductors

- Terminal block markers are included to properly identify connectors
- Ten pages of markers per book

B2. Cable Accessories

B3. Stainless Steel Ties

### Material Chart

Material	Print Method	Temperature Range	Features
Vinyl Cloth, White	Pre-Printed	-50°F to 170°F (-46°C to 77°C)	Indoor/outdoor rated; conformable material with repositionable adhesive allows label to be removed and reused or used in temporary applications; provides durability, high temperature resistance, and dimensional stability for rough or textured surfaces; resists oil and abrasion.

C1. Wiring Duct

C2. Surface Raceway

C3. Abrasion Protection

### Perforation for half marker

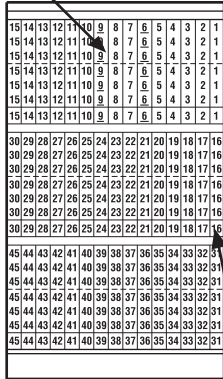

C4. Cable Management

D1. Terminals

D2. Power Connectors

D3. Grounding Connectors

### Terminal Block Marker

E1. Labeling Systems

E2. Labels

E3. Pre-Printed & Write-On Markers

E4. Permanent Identification

E5. Lockout/Tagout & Safety Solutions

F. Index

Part Number	Legend	Total Markers Each Legend	Std. Pkg. Book(s)	Std. Ctn. Book(s)
<b>PCMB-1</b>	0 thru 9	45	1	10
<b>PCMB-2</b>	A thru Z, 0 thru 15, +, -, /	10	1	10
<b>PCMB-3</b>	1 thru 45	10	1	10
<b>PCMB-4</b>	1, 2, 3	150	1	10
<b>PCMB-5</b>	A, B, C	150	1	10
<b>PCMB-6</b>	T1, T2, T3	150	1	10
<b>PCMB-7</b>	L1, L2, L3	150	1	10
<b>PCMB-8</b>	1 thru 15 16 thru 90 A thru Z, +, -, /, 0	6 4 2	1	10
<b>PCMB-9</b>	1, 2, 3, A, B, C L1, L2, L3, T1, T2, T3	45 30	1	10
<b>PCMB-10</b>	Solid NEMA colors red, yellow, white, light blue, light green, black, brown, orange, gray, dark green	45	1	10
<b>PCMB-11</b>	1 thru 30	15	1	10
<b>PCMB-12</b>	A thru Z + - Blank (write-on)	15 8 7 21	1	10
<b>PCMB-13</b>	+ , - , AC, DC POS, NEG, GND NEUT SPARE, Blank (write-on)	45 21 21 21	1	10
<b>PCMB-14</b>	46 thru 90	10	1	10
<b>PCMB-15</b>	0, +, - 1 thru 45	15 10	1	10
<b>PCMB-16</b>	0 thru 33, A, B, C, +, -, L1, L2, L3, T1, T2, T3	10	1	10
<b>PCMB-25</b>	0 thru 9 L1, L2, L3, T1, T2, T3	45 15	1	10

Legend: Black Background: White

Marker sizes:

Full size marker – .22" x 1.38" (5.60mm x 34.90mm). Maximum wire O.D., .38" (9.50mm).

Half size marker – .22" x .69" (5.60mm x 17.40mm). Maximum wire O.D., .19" (4.70mm).

Terminal block marker – .22" x .25" (5.60mm x 6.30mm).



## Blank Self-Laminating Write-On Cable Marker Books

- 10 pages of markers per book
- Clear section of marker over laminates and protects printed legend
- Markers have ink receptive area to allow handwritten legends



Part Number	Width		Length		Markers Per Book	Std. Pkg. Book(s)	Std. Ctn. Book(s)
	In.	mm	In.	mm			
PSCB-12Y	0.50	12.7	1.50	38.1	180	1	10
PSCB-13Y	1.50	38.1	3.00	76.2	40	1	10
PSCB-16Y	1.50	38.1	6.00	152.4	20	1	10
PSCB-3Y	1.00	25.4	3.00	76.2	60	1	10
PSCB-3YELY*	1.00	25.4	3.00	76.2	60	1	10
PSCB-5Y	1.00	25.4	5.00	127.0	30	1	10
PSCB-6Y	1.00	25.4	6.00	152.4	30	1	10

\*Yellow.

A.  
System  
Overview

B1.  
Cable Ties

B2.  
Cable  
Accessories

B3.  
Stainless  
Steel Ties

C1.  
Wiring  
Duct

C2.  
Surface  
Raceway

C3.  
Abrasion  
Protection

C4.  
Cable  
Management

D1.  
Terminals

D2.  
Power  
Connectors

D3.  
Grounding  
Connectors

E1.  
Labeling  
Systems

E2.  
Labels

E3.  
Pre-Printed  
& Write-On  
Markers

E4.  
Permanent  
Identification

E5.  
Lockout/  
Tagout  
& Safety  
Solutions

F.  
Index

A. System Overview

## Pre-Printed Marker Cards PCM Type

B1. Cable Ties

• Marker cards printed in a variety of legends allows “kitting” for project builds

• Plastic liner provides easy removal of markers while protecting unused markers

B2. Cable Accessories

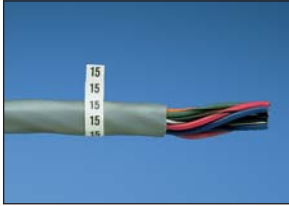

B3. Stainless Steel Ties

C1. Wiring Duct

C2. Surface Raceway



PCM-7

C3. Abrasion Protection

C4. Cable Management

D1. Terminals

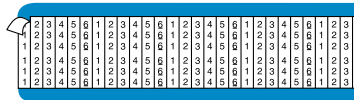

PCM-1-6

D2. Power Connectors

D3. Grounding Connectors

E1. Labeling Systems

E2. Labels

E3. Pre-Printed & Write-On Markers

E4. Permanent Identification

E5. Lockout/Tagout & Safety Solutions

F. Index

### Material Chart

Material	Print Method	Temperature Range	Features
Vinyl Cloth, White	Pre-Printed	-50°F to 170°F (-46°C to 77°C)	Indoor/outdoor rated; conformable material with repositionable adhesive allows label to be removed and reused or used in temporary applications; provides durability, high temperature resistance, and dimensional stability for rough or textured surfaces; resists oil and abrasion.

Part Number	Legend	Width		Length		Markers Per Card	Std. Pkg. Card(s)	Std. Ctn. Card(s)							
		In.	mm	In.	mm										
<b>PCM-0</b>	0	0.25	6.35	1.50	38.1	36	25	100							
thru	thru														
<b>PCM-99</b>	99														
<b>PCM-100</b>	100	0.36	9.14	1.50	38.1	25	25	100							
thru	thru														
<b>PCM-202</b>	202														
<b>PCMH-0</b>	0	0.25	6.35	1.50	38.1	72	25	100							
thru	thru														
<b>PCMH-25</b>	25														
<b>PCM-1-3</b>	1 thru 3	0.25	6.35	1.50	38.10	36	25	100							
<b>PCM-1-4</b>	1 thru 4														
<b>PCM-1-5</b>	1 thru 5														
<b>PCM-1-6</b>	1 thru 6														
<b>PCM-1-8</b>	1 thru 8														
<b>PCM-1-9</b>	1 thru 9														
<b>PCM-0-9</b>	0 thru 9														
<b>PCM-1-10</b>	1 thru 10														
<b>PCM-1-12</b>	1 thru 12														
<b>PCM-1-16</b>	1 thru 16														
<b>PCM-1-18</b>	1 thru 18														
<b>PCM-19-36</b>	19 thru 36														
<b>PCM-1-33</b>	1 thru 33								0.27	6.91	1.50	38.10	33	25	100
<b>PCM-34-66</b>	34 thru 66														
<b>PCM-67-99</b>	67 thru 99														
<b>PCM-100-124</b>	100 thru 124														
<b>PCM-125-149</b>	125 thru 149														
<b>PCM-150-174</b>	150 thru 174														
<b>PCM-175-199</b>	175 thru 199														
<b>PCM-200-224</b>	200 thru 224														
<b>PCM-225-249</b>	225 thru 249														
<b>PCM-250-274</b>	250 thru 274														
<b>PCM-275-299</b>	275 thru 299														
<b>PCM-300-324</b>	300 thru 324	0.36	9.14	1.50	38.10	25	25	100							
<b>PCM-325-349</b>	325 thru 349														
<b>PCM-350-374</b>	350 thru 374														
<b>PCM-375-399</b>	375 thru 399														
<b>PCM-400-424</b>	400 thru 424														
<b>PCM-425-449</b>	425 thru 449														
<b>PCM-450-474</b>	450 thru 474														
<b>PCM-475-499</b>	475 thru 499														
<b>PCM-500-524</b>	500 thru 524														

## Pre-Printed Marker Cards PCM Type (continued)



PCM-A1

Part Number	Legend	Width		Length		Markers Per Card	Std. Pkg. Card(s)	Std. Ctn. Card(s)
		In.	mm	In.	mm			
PCM-A thru PCM-Z	A thru Z	0.25	6.35	1.50	38.1	36	25	100
PCM-A-Z	A thru Z	0.25	6.35	1.50	38.1		25	100
PCM-A-Z-0-9	A thru Z 0 thru 9	0.25	6.35	1.50	38.1		25	100
PCM-A1 thru PCM-A4	A1 thru A4	0.25	6.35	1.50	38.1		25	100
PCM-B1 thru PCM-B5	B1 thru B5	0.25	6.35	1.50	38.1		25	100
PCM-C1 thru PCM-C4	C1 thru C4	0.25	6.35	1.50	38.1		25	100
PCM-E1 thru PCM-E3	E1 thru E3	0.25	6.35	1.50	38.1		25	100
PCM-F1 thru PCM-F4	F1 thru F4	0.25	6.35	1.50	38.1		25	100
PCM-H1 thru PCM-H5	H1 thru H5	0.25	6.35	1.50	38.1		25	100
PCM-L1 thru PCM-L5	L1 thru L5	0.25	6.35	1.50	38.1		25	100
PCM-M1 thru PCM-M2	M1 thru M2	0.25	6.35	1.50	38.1		25	100
PCM-P1 thru PCM-P3	P1 thru P3	0.25	6.35	1.50	38.1		25	100
PCM-R1 thru PCM-R5	R1 thru R5	0.25	6.35	1.50	38.1		25	100
PCM-S1 thru PCM-S5	S1 thru S5	0.25	6.35	1.50	38.1		25	100
PCM-T1 thru PCM-T9	T1 thru T9	0.25	6.35	1.50	38.1		25	100
PCM-X1 thru PCM-X4	X1 thru X4	0.25	6.35	1.50	38.1		25	100

Table continues on page E3.6

A.  
System  
Overview

B1.  
Cable Ties

B2.  
Cable  
Accessories

B3.  
Stainless  
Steel Ties

C1.  
Wiring  
Duct

C2.  
Surface  
Raceway

C3.  
Abrasion  
Protection

C4.  
Cable  
Management

D1.  
Terminals

D2.  
Power  
Connectors

D3.  
Grounding  
Connectors

E1.  
Labeling  
Systems

E2.  
Labels

E3.  
Pre-Printed  
& Write-On  
Markers

E4.  
Permanent  
Identification

E5.  
Lockout/  
Tagout  
& Safety  
Solutions

F.  
Index

A. System Overview

## Pre-Printed Marker Cards PCM Type (continued)

B1. Cable Ties

B2. Cable Accessories



PCM-1T1

B3. Stainless Steel Ties

C1. Wiring Duct

C2. Surface Raceway

C3. Abrasion Protection

C4. Cable Management

D1. Terminals

D2. Power Connectors

D3. Grounding Connectors

E1. Labeling Systems

E2. Labels

E3. Pre-Printed & Write-On Markers

E4. Permanent Identification

E5. Lockout/Tagout & Safety Solutions

F. Index

Part Number	Legend	Width		Length		Markers Per Card	Std. Pkg. Card(s)	Std. Ctn. Card(s)
		In.	mm	In.	mm			
PCM-1L1	1L1	0.36	9.14	1.50	38.10	25	25	100
thru	thru							
PCM-1L3	1L3	0.36	9.14	1.50	38.10		25	100
thru	thru							
PCM-2L1	2L1	0.36	9.14	1.50	38.10		25	100
thru	thru							
PCM-2L3	2L3	0.36	9.14	1.50	38.10		25	100
thru	thru							
PCMH-3L1	3L1	0.36	9.14	1.50	38.10		25	100
thru	thru							
PCMH-3L3	3L3	0.36	9.14	1.50	38.10	25	100	
thru	thru							
PCM-4L1	4L1	0.36	9.14	1.50	38.10	25	100	
thru	thru							
PCM-4L3	4L3	0.36	9.14	1.50	38.10	25	100	
thru	thru							
PCM-1T1	1T1	0.36	9.14	1.50	38.10	25	100	
thru	thru							
PCM-1T3	1T3	0.36	9.14	1.50	38.10	25	100	
thru	thru							
PCM-3T1	3T1	0.36	9.14	1.50	38.10	25	100	
thru	thru							
PCM-3T3	3T3							



Part Number	Color	Width		Length		Markers Per Card	Std. Pkg. Card(s)	Std. Ctn. Card(s)
		In.	mm	In.	mm			
PCM-BLK	Black	.25	6.35	1.50	38.10	36	25	100
PCM-BRN	Brown	.25	6.35	1.50	38.10		25	100
PCM-DBL	Dark Blue	.25	6.35	1.50	38.10		25	100
PCM-DGN	Dark Green	.25	6.35	1.50	38.10		25	100
PCM-GRY	Gray	.25	6.35	1.50	38.10		25	100
PCM-LBL	Light Blue	.25	6.35	1.50	38.10		25	100
PCM-LGN	Light Green	.25	6.35	1.50	38.10		25	100
PCM-ORN	Orange	.25	6.35	1.50	38.10		25	100
PCM-PNK	Pink	.25	6.35	1.50	38.10		25	100
PCM-PUR	Purple	.25	6.35	1.50	38.10		25	100
PCM-RED	Red	.25	6.35	1.50	38.10		25	100
PCM-TAN	Tan	.25	6.35	1.50	38.10		25	100
PCM-WHT	White	.25	6.35	1.50	38.10		25	100
PCM-YEL	Yellow	.25	6.35	1.50	38.10		25	100

Marker size:

Full size marker – 1.50" (38.10mm). Maximum wire O.D., .38" (9.50mm).

## Wire Marker Card Number Combination Packs



Numbers



Letters

Part Number	Legend	Cards Per Legend	Markers Per Card	Std. Pkg. Qty.	Std. Ctn. Qty.
PCMCP-1-25*	1 thru 25	1 each	36	1	4
PCMCP-26-50*	26 thru 50	1 each		1	4
PCMCP-51-75*	51 thru 75	1 each		1	4
PCMCP-76-100*	76 thru 99 100	1 each	36 25	1	4
PCMCP-101-125*	101 thru 125	1 each	25	1	4
PCMCP-126-150*	126 thru 150	1 each		1	4
PCMCP-A-Z**	A thru Z	1 each	36	1	4

Marker size:

Full size marker – 1.50" (38.10mm). Maximum wire O.D. .38" (9.50mm).

\*One card each number, 25 cards per package.

\*\*One card each letter, 26 cards per package.

## Pre-Printed Marker Cards

- Choose from the many legends available in general purpose vinyl cloth, or from special materials available to meet a variety of application environments

- All markers are offered in full size – 1.50" (38.1mm) long for wire outside diameter up to 0.38" (9.5mm); half size markers for wire outside diameter up to 0.19" (4.7mm) can be ordered
- Each marker on card has a different legend

### Material Chart



PSM-7

Material	Print Method	Temperature Range	Features
Self-Laminating Vinyl, White Print-On	Pre-Printed	-40°F to 150°F (-40°C to 66°C)	Indoor/outdoor rated; thin and conformable; preferred material for most general wire/cable labeling.



PSM-1-33



PSM-W

Part Number	Legend	Width		Length		Markers Per Card	Std. Pkg. Card(s)	Std. Ctn. Card(s)
		In.	mm	In.	mm			
PSM-0-Y thru PSM-52-Y	0 thru 52	0.25	6.35	0.75	19.1	36	25	100
PSM-0-9-Y	0 thru 9	0.27	6.86	0.75	19.1	33	25	100
PSM-1-33-Y	1 thru 33	0.27	6.86	0.75	19.1		25	100
PSM-34-66-Y	34 thru 66	0.27	6.86	0.75	19.1		25	100
PSM-67-99-Y	67 thru 99	0.27	6.86	0.75	19.1		25	100
PSM-A-Y thru PSM-Z-Y	A thru Z	0.25	6.35	0.75	19.1	36	25	100
PSM-A-Z-Y	A thru Z	0.25	6.35	0.75	19.1		25	100

Legend: Black Background: White

Marker sizes:

Full size marker – 1.50" (38.10mm). Maximum wire O.D., 0.38" (9.50mm).

Half size marker – 0.75" (19.10mm). Maximum wire O.D., 0.19" (4.70mm).

A. System Overview

## Pre-Printed Marker Cards PPM Type

B1. Cable Ties

B2. Cable Accessories

B3. Stainless Steel Ties

### Material Chart



PPM-7

Material	Print Method	Temperature Range	Features
High Temp, White	Pre-Printed	-40°F to 275°F (-40°C to 135°C)	Indoor/outdoor rated; self-extinguishing; ideal for component labeling in harsh environments

C1. Wiring Duct



PPM-1-33

C2. Surface Raceway

C3. Abrasion Protection



PPM-A

C4. Cable Management

D1. Terminals

D2. Power Connectors

D3. Grounding Connectors

E1. Labeling Systems

E2. Labels

E3. Pre-Printed & Write-On Markers

E4. Permanent Identification

E5. Lockout/Tagout & Safety Solutions

F. Index

Part Number	Legend	Width		Length		Markers Per Card	Std. Pkg. Card(s)	Std. Ctn. Card(s)
		In.	mm	In.	mm			
PPM-0 thru PPM-25	0 thru 25	0.25	6.35	1.50	38.10	36	25	100
PPM-1-33	1 thru 33	0.27	6.91	1.50	38.10	33	25	100
PPM-A thru PPM-C	A thru C	0.25	6.35	1.50	38.10	36	25	100

Legend: Black Background: White  
 Marker sizes:  
 Half size marker – 1.50" (38.10mm). Maximum wire O.D., .38" (9.50mm).

## Write-On Marker Cards – Self-Laminating

- Clear section of marker overlaminates and protects write-on legend
- Markers have ink receptive area to allow hand-written legends

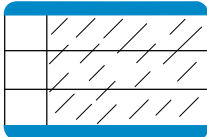

Type PSCC

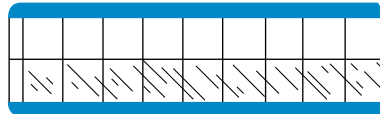

Type PSWM

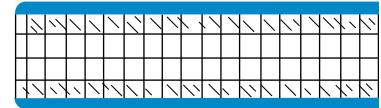

Type PSWMH

Part Number	Width		Length		Print-On Height		Min. Cable O.D.		Max. Cable O.D.		Markers Per Card	Std. Pkg. Card(s)	Std. Ctn. Card(s)
	In.	mm	In.	mm	In.	mm	In.	mm	In.	mm			
PSCC-3Y	1.00	25.40	3.00	76.20	0.75	19.05	0.240	6.1	0.72	18.2	3	25	100
PSCC-5Y	1.00	25.40	5.00	127.00	1.00	25.40	0.320	8.1	1.27	32.3	3	25	100
PSWM-375Y	0.38	9.53	1.50	38.05	0.75	19.05	0.240	6.1	0.24	6.1	25	25	100
PSWM-750Y	0.75	19.05	1.50	38.05	0.75	19.05	0.240	6.1	0.24	6.1	12	25	100
PSWM-1500Y	1.50	38.05	1.50	38.05	0.75	19.05	0.240	6.1	0.24	6.1	6	25	100
PSWMH-375Y	0.38	9.53	0.75	19.05	0.38	9.53	0.120	3.1	0.12	3.0	50	25	100
PSWMH-750Y	0.75	19.05	0.75	19.05	0.38	9.53	0.120	3.1	0.12	3.0	24	25	100

## Pre-Printed Marker Tape Dispenser

- Flexible polyester marker tape conforms tightly to wires/cables
- Dispenser allows marker tape to be cut to the exact length required for marking any size wire/cable
- Durable plastic dispenser can be attached to tool belt for industrial use



### Material Chart

Material	Print Method	Temperature Range	Features
Polyester, White	Pre-Printed	-40°F to 250°F (-40°C to 121°C)	Indoor/outdoor rated; laminated label material protects legend from abrasion and chemicals; resistant to UV light chemical atmosphere and abrasion; excellent life and adhesion properties.

Part Number	Part Description	Roll		Rolls Per Legend Per Pkg.	Std. Pkg. Qty.	Std. Ctn. Qty.
		Ft.	m			
PMD	Empty dispenser.	—	—	—	1	10
PMD-0-9	Dispenser filled with one roll each legend 0 thru 9.	8.0	2.4	1	1	10
PMD-NEMA	Dispenser filled with one roll each of solid NEMA colors: black, light blue, brown, gray, light green, orange, purple, red, white and yellow.	8.0	2.4	1	1	10

A. System Overview

## Pre-Printed Marker Tape Refills

B1. Cable Ties



B2. Cable Accessories

B3. Stainless Steel Ties



C1. Wiring Duct

C2. Surface Raceway

C3. Abrasion Protection

C4. Cable Management

D1. Terminals

D2. Power Connectors

D3. Grounding Connectors

E1. Labeling Systems

E2. Labels

E3. Pre-Printed & Write-On Markers

E4. Permanent Identification

E5. Lockout/Tagout & Safety Solutions

F. Index

Part Number	Legend	Roll Length		Rolls Per Legend Per Pkg.	Std. Pkg. Roll(s)	Std. Ctn. Roll(s)																
		Ft.	m																			
PMDR-0-9 thru PMDR-90-99	0 thru 9 thru 90 thru 99	8.0	2.4	10	1	10																
PMDR-0 thru PMDR-9	0 thru 9						10	100														
PMDR-A thru PMDR-Z	A thru Z								10	100												
PMDR-L1 thru PMDR-L3	L1 thru L3										10	100										
PMDR-T1 thru PMDR-T3	T1 thru T3												10	100								
PMDR-GRS	Ground symbol														10	100						
PMDR-MIN	Minus symbol																10	100				
PMDR-PLS	Plus symbol																		10	100		
PMDR-BLK	Black																				10	100
PMDR-BL	Light Blue																					
PMDR-BRN	Brown	10	100																			
PMDR-GRN	Light Green			10	100																	
PMDR-GRY	Gray					8.0	2.4	10	10													
PMDR-ORN	Orange									10	100											
PMDR-PUR	Purple											10	100									
PMDR-RED	Red													10	100							
PMDR-WHT	White															10	100					
PMDR-YEL	Yellow																	10	100			
PMDR-NEMA	One of each of the NEMA colors featured above																			1	1	10



## Self-Laminating Wire Marker Dispenser

- Self-laminating labels are provided in handy dispenser which protects markers when not in use
- Clear section of marker overlaminates and protects write-on legend
- Quick, easy to use for smaller installations and maintenance



### Material Chart

Material	Print Method	Temperature Range	Features
Self-Laminating Vinyl, White Print-On	Pre-Printed	-40°F to 150°F (-40°C to 66°C)	Indoor/outdoor rated; thin and conformable; preferred material for most general wire/cable labeling.

Part Number	Part Description	Width		Length		Print-On Height		Min. Cable O.D.		Max. Cable O.D.		Std. Pkg. Qty.	Std. Ctn. Qty.
		In.	mm	In.	mm	In.	mm	In.	mm	In.	mm		
<b>Dispenser Kit</b>													
<b>S100X125VARY</b>	(1) Dispenser. (1) Roll, white write-on, vinyl label, 200/roll. (1) PFX-0 pen.	1.00	25.40	1.25	31.75	0.38	9.65	0.12	3.07	0.28	7.03	1	10
<b>S100X225VARY</b>	(1) Dispenser. (1) Roll, white write-on, vinyl label, 100/roll. (1) PFX-0 pen.	1.00	25.40	2.25	57.15	0.75	19.05	0.24	6.06	0.48	12.13	1	10
<b>Refill Rolls</b>													
<b>S100X125VAFY</b>	Replacement roll. White write-on, vinyl label, 200/roll.	1.00	25.40	1.25	31.75	0.38	9.65	0.12	3.07	0.28	7.03	1	10
<b>S100X225VAFY</b>	Replacement roll. White write-on, vinyl label 100/roll.	1.00	25.40	2.25	57.15	0.75	19.05	0.24	6.06	0.48	12.13	1	10

Can be clearly identified with Panduit permanent marking pens shown on page E5.19.

## Pre-Printed Clip-On Wire Markers

- Non-adhesive markers grip tightly to wire/cable
- Markers supplied on application wand tool
- Chevron cut keeps multiple markers aligned
- Black legend is embossed into wire marker clip



### Material Chart

Material	Print Method	Temperature Range	Features
Non-Adhesive Acetal	Pre-Printed	-22°F to 194°F (-30°C to 90°C)	Indoor/outdoor rated; durable material that has excellent resiliency to oils and solvents.

Part Number	Legend	No. of Markers Per Wand	Markers Per Pkg.	Std. Pkg. Qty.	Std. Ctn. Qty.
-------------	--------	-------------------------	------------------	----------------	----------------

### Wire/Cable Diameter 0.08" – 0.10" (2.00mm – 2.50mm)

<b>PCA07-A</b> thru <b>PCA07-Z</b>	A thru Z	30	300	1	10
<b>PCA07-A-J</b>	A-J			1	10
<b>PCA07-K-T</b>	K-T			1	10
<b>PCA07-U-Z</b>	U-Z			1	10
<b>PCA07-0</b> thru <b>PCA07-9</b>	0 thru 9			1	10
<b>PCA07-0-9</b>	0-9			1	10
<b>PCA07-MIN</b>	—			1	10
<b>PCA07-PLS</b>	+			1	10

Table continues on page E3.12

## Pre-Printed Clip-On Wire Markers (continued)

A. System Overview
B1. Cable Ties
B2. Cable Accessories
B3. Stainless Steel Ties
C1. Wiring Duct
C2. Surface Raceway
C3. Abrasion Protection
C4. Cable Management
D1. Terminals
D2. Power Connectors
D3. Grounding Connectors
E1. Labeling Systems
E2. Labels
E3. Pre-Printed & Write-On Markers
E4. Permanent Identification
E5. Lockout/Tagout & Safety Solutions
F. Index

Part Number	Legend	No. of Markers Per Wand	Markers Per Pkg.	Std. Pkg. Qty.	Std. Ctn. Qty.		
<b>Wire/Cable Diameter 0.11" – 0.13" (2.80mm – 3.30mm)</b>							
PCA11-A thru PCA11-Z	A thru Z	30	300	1	10		
PCA11-A-J	A-J			1	10		
PCA11-K-T	K-T			1	10		
PCA11-U-Z	U-Z			1	10		
PCA11-0 thru PCA11-9	0 thru 9			1	10		
PCA11-0-9	0-9			1	10		
PCA11-MIN	—			1	10		
PCA11-PLS	+			1	10		
<b>Wire/Cable Diameter 0.13" – 0.15" (3.30mm – 3.80mm)</b>							
PCA13-A thru PCA13-Z	A thru Z			30	300	1	10
PCA13-A-J	A-J	1	10				
PCA13-K-T	K-T	1	10				
PCA13-U-Z	U-Z	1	10				
PCA13-0 thru PCA13-9	0 thru 9	1	10				
PCA13-0-9	0-9	1	10				
PCA13-MIN	—	1	10				
PCA13-PLS	+	1	10				
<b>Wire/Cable Diameter 0.19" – 0.23" (4.80mm – 5.80mm)</b>							
PCA18-A thru PCA18-Z	A thru Z	30	300			1	10
PCA18-A-J	A-J			1	10		
PCA18-K-T	K-T			1	10		
PCA18-U-Z	U-Z			1	10		
PCA18-0 thru PCA18-9	0 thru 9			1	10		
PCA18-0-9	0-9			1	10		
PCA18-MIN	—			1	10		
PCA18-PLS	+			1	10		
<b>Wire/Cable Diameter 0.23" – 0.37" (5.80mm – 9.40mm)</b>							
PCA23-A thru PCA23-Z	A thru Z			20	60	1	10
PCA23-A-D	A-D	80	1		10		
PCA23-E-H	E-H		1		10		
PCA23-I-L	I-L		1		10		
PCA23-M-P	M-P		1		10		
PCA23-Q-T	Q-T	60	1		10		
PCA23-U-X	U-X		1		10		
PCA23-Y-Z	Y-Z, +, -		1		10		
PCA23-0 thru PCA23-9	0 thru 9		80		1	10	
PCA23-0-3	0-3	1			10		
PCA23-4-7	4-7	1		10			
PCA23-8-9	8, 9, +, -	1		10			
PCA23-MIN	—	60	1	10			
PCA23-PLS	+		1	10			

## PERMANENT IDENTIFICATION

Panduit offers the widest range of permanent identification solutions in the industry to withstand the test of time and provide legibility in harsh environments. Safe, quick, and easy to install, Panduit permanent identification solutions include stainless steel and aluminum marker plates, tags, marking tools and ties to deliver improved productivity and workplace safety.



- **Factory Custom Marking Service** creates embossed or laser etched metal plates, tags, and ties to speed installation time and reduce labor costs
- **Portable on-site marking tools** for quick and easy identification on demand
- **Large identification selection** delivers maximum design flexibility to match your specific application requirements
- **Optimized for easy use** with Panduit self-locking stainless steel and aluminum ties; for details, refer to Pan-Steel® System Section B3

Panduit continues to design permanent identification products for harsh environments by addressing customer problems with innovative solutions and reliable tooling to achieve lowest installed cost.

A.  
System  
Overview

B1.  
Cable Ties

B2.  
Cable  
Accessories

B3.  
Stainless  
Steel Ties

C1.  
Wiring  
Duct

C2.  
Surface  
Raceway

C3.  
Abrasion  
Protection

C4.  
Cable  
Management

D1.  
Terminals

D2.  
Power  
Connectors

D3.  
Grounding  
Connectors

E1.  
Labeling  
Systems

E2.  
Labels

E3.  
Pre-Printed  
& Write-On  
Markers

E4.  
Permanent  
Identification

E5.  
Lockout/  
Tagout  
& Safety  
Solutions

F.  
Index

A. System Overview

## Panduit Factory Custom Marking Service

B1. Cable Ties

Panduit factory custom marking service simplifies identification with high quality, made-to-order custom embossed marker plates and tags or laser etched cable ties, marker plates, and tags. Panduit offers rapid direct shipment with fast turn around on custom marking orders worldwide. Work with Panduit to create an effectively identified workplace.

B2. Cable Accessories

### EMBOSSING SERVICE

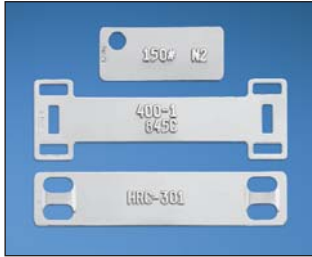

- Used on rectangular metal marker plates and tags which are a maximum of .020 inches (.5mm) thick and minimum .38 inches (10mm) width
- Excellent for applications that are exposed to dirt and paint
- Upper case “raised” character
- Alphanumeric and sequential numbering

### LASER MARKING SERVICE

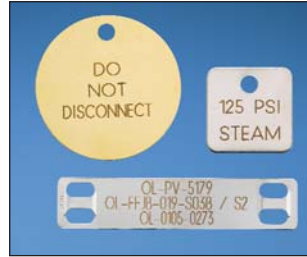

- Used on all metal marker plates, tags, and cable ties
- BOLD block letters
- Upper and lower case character capability
- Ability to create text and graphics
- Alphanumeric and sequential numbering

B3. Stainless Steel Ties

C1. Wiring Duct

C2. Surface Raceway

C3. Abrasion Protection

C4. Cable Management

D1. Terminals

D2. Power Connectors

D3. Grounding Connectors

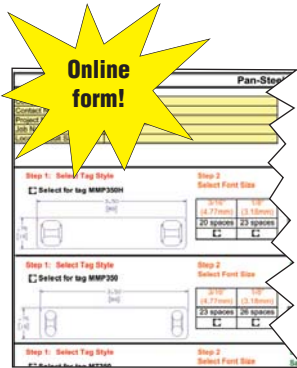

Online form!

To select and order custom laser and embossed marker plates and tags:

Use on-line order form (C2-0677) at [www.panduit.com/permanentID](http://www.panduit.com/permanentID) to select the proper marker plate or tag for your application. Email order form to your Authorized Panduit Distributor for order placement or contact Panduit Customer Service for assistance.

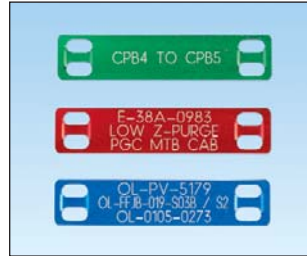

#### Character sizes available:

- 1/8 inches (3.18mm) – For high character volume tags
- 3/16 inches (4.77mm) – The most common size
- 1/4 inches (6.35mm) – Larger font for greater flexibility
- 5/16 inches (7.94mm) – Maximum visibility for tags requiring only a few characters.

E1. Labeling Systems

E2. Labels

E3. Pre-Printed & Write-On Markers

E4. Permanent Identification

E5. Lockout/Tagout & Safety Solutions

F. Index



Panduit offers a full line of labeling products, software and printers to assist you with your labeling requirements.

See pages E1.0 – E2.30.



Panduit permanent identification products are optimized for easy use with Panduit self-locking stainless steel and aluminum ties. For details, refer to Pan-Steel® System Section B3.

## Stainless Steel and Brass Marker Plates and Tags

- Provides permanent identification of pipes, conduit, valves, cables and equipment in harsh environments
- Designed for use with Panduit® Pan-Steel® Stainless Steel Cable Ties for fast installation at lowest installed cost
- All marker plates/tags can be embossed or laser etched with Panduit Factory Custom Marking Service
- For on-site custom marking see page E4.6
- Designated plates feature easy feed design with a raised slot to simplify cable tie installation and improve productivity



MMP350-C

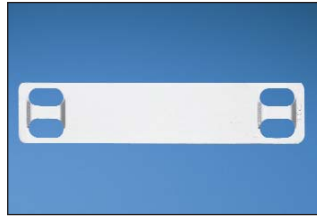

MMP350H-C

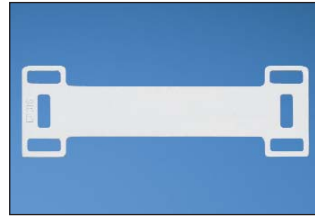

MMP350DB-C



MMP350W38-C



MMP172-C



MMP172W38-C



MMP350W17-Q

Part Number	Material	Color	Length/ Diameter		Width		Custom Marking Parameters*		Used with Pan-Steel® Cable Ties**	Thickness		Std. Pkg. Qty.	Std. Ctn. Qty.
			In.	mm	In.	mm	Max. 3/16" (4.77mm) Character Per Line	Max. Lines of Text		In.	mm		
<b>MMP350-C‡</b>	304 Stainless Steel	Natural	3.50	89.0	0.75	19.0	23	3	MLT-S	0.010	0.25	100	1000
<b>MMP350-C316‡</b>	316 Stainless Steel	Natural	3.50	89.0	0.75	19.0	23	3	MLT-S	0.010	0.25	100	1000
<b>MMP350H-C‡</b>	304 Stainless Steel	Natural	3.50	89.0	0.75	19.0	20	3	MLT-H	0.010	0.25	100	1000
<b>MMP350H-C316‡</b>	316 Stainless Steel	Natural	3.50	89.0	0.75	19.0	20	3	MLT-H	0.010	0.25	100	1000
<b>MMP350DB-C‡</b>	304 Stainless Steel	Natural	3.50	89.0	1.12	29.0	20	3	MLT-H	0.015	0.38	100	1000
<b>MMP350DB-C316‡</b>	316 Stainless Steel	Natural	3.50	89.0	1.12	29.0	20	3	MLT-H	0.015	0.38	100	1000
<b>MMP350W38-C‡</b>	304 Stainless Steel	Natural	3.50	89.0	0.38	10.0	23	1	MLT-S	0.010	0.25	100	1000
<b>MMP350W38-C316‡</b>	316 Stainless Steel	Natural	3.50	89.0	0.38	10.0	23	1	MLT-S	0.010	0.25	100	1000
<b>MMP172-C‡</b>	304 Stainless Steel	Natural	1.72	44.0	0.75	19.0	8	3	MLT-S	0.010	0.25	100	1000
<b>MMP172-C316‡</b>	316 Stainless Steel	Natural	1.72	44.0	0.75	19.0	8	3	MLT-S	0.010	0.25	100	1000
<b>MMP172W38-C‡</b>	304 Stainless Steel	Natural	1.72	44.0	0.38	10.0	8	1	MLT-S	0.010	0.25	100	1000
<b>MMP172W38-C316‡</b>	316 Stainless Steel	Natural	1.72	44.0	0.38	10.0	8	1	MLT-S	0.010	0.25	100	1000
<b>MMP350W17-Q</b>	304 Stainless Steel	Natural	3.50	89.0	1.73	44.0	23	6	MLT-S	0.015	0.38	25	250

\*See page E4.2 for Panduit Factory Custom Marking Service information.

\*\*See pages B3.5 – B3.7 for Pan-Steel® Stainless Steel Cable Ties.

‡Easy feed marker plate with raised cable tie slot.

Table continues on page E4.4

A. System Overview

## Stainless Steel and Brass Marker Plates and Tags (continued)

B1. Cable Ties

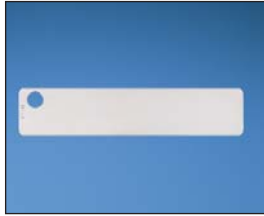

MT350-C



MT350W17-Q



MT172-C

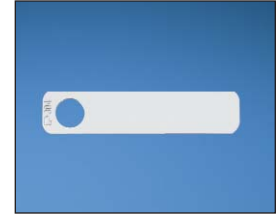

MT172W38-C

B2. Cable Accessories

B3. Stainless Steel Ties

C1. Wiring Duct

C2. Surface Raceway



MTB1D-Q



MTB150D-Q

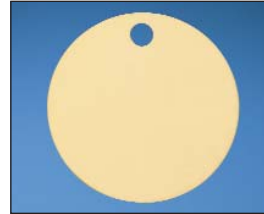

MTB213D-Q



MT125S-Q

C3. Abrasion Protection

C4. Cable Management

D1. Terminals

D2. Power Connectors

D3. Grounding Connectors

E1. Labeling Systems

E2. Labels

E3. Pre-Printed & Write-On Markers

E4. Permanent Identification

E5. Lockout/Tagout & Safety Solutions

F. Index

Part Number	Material	Color	Length/ Diameter		Width		Custom Marking Parameters*		Used with Pan-Steel® Cable Ties**	Thickness		Std. Pkg. Qty.	Std. Ctn. Qty.
			In.	mm	In.	mm	Max. 3/16" (4.77mm) Character Per Line	Max. Lines of Text		In.	mm		
<b>MT350-C</b>	304 Stainless Steel	Natural	3.50	89.0	0.75	19.0	26	3	MLT-S	0.010	0.25	100	1000
<b>MT350-C316</b>	316 Stainless Steel	Natural	3.50	89.0	0.75	19.0	26	3	MLT-S	0.010	0.25	100	1000
<b>MT350W17-Q</b>	304 Stainless Steel	Natural	3.50	89.0	1.73	44.0	26	6	MLT-S	0.015	0.38	25	250
<b>MT172-C</b>	304 Stainless Steel	Natural	1.72	44.0	0.75	19.0	10	3	MLT-S	0.010	0.25	100	1000
<b>MT172-C316</b>	316 Stainless Steel	Natural	1.72	44.0	0.75	19.0	10	3	MLT-S	0.010	0.25	100	1000
<b>MT172W38-C</b>	304 Stainless Steel	Natural	1.72	44.0	0.38	10.0	10	1	MLT-S	0.010	0.25	100	1000
<b>MT1D-Q</b>	304 Stainless Steel	Natural	—	—	1.00 circular	25.0	5	1	MLT-S	0.035	0.89	25	250
<b>MT1D-Q316</b>	316 Stainless Steel	Natural	—	—	1.00 circular	25.0	5	1	MLT-S	0.035	0.89	25	250
<b>MTB1D-Q</b>	Brass	Brass	—	—	1.00 circular	25.0	5	1	MLT-S	0.040	1.02	25	250
<b>MT150D-Q</b>	304 Stainless Steel	Natural	—	—	1.50 circular	38.0	5, 6, 5	3	MLT-S	0.035	0.89	25	250
<b>MT150D-Q316</b>	316 Stainless Steel	Natural	—	—	1.50 circular	38.0	5, 6, 5	3	MLT-S	0.035	0.89	25	250
<b>MTB150D-Q</b>	Brass	Brass	—	—	1.50 circular	38.0	5, 6, 5	3	MLT-S	0.040	1.02	25	250
<b>MT213D-Q</b>	304 Stainless Steel	Natural	—	—	2.13 circular	54.0	6, 12, 8	3	MLT-S	0.015	0.38	25	250
<b>MT213D-Q316</b>	316 Stainless Steel	Natural	—	—	2.13 circular	54.0	6, 12, 8	3	MLT-S	0.015	0.38	25	250
<b>MTB213D-Q</b>	Brass	Brass	—	—	2.13 circular	54.0	6, 12, 8	3	MLT-S	0.015	0.38	25	250
<b>MT125S-Q</b>	304 Stainless Steel	Natural	1.25 square	32.0 square	1.25 square	32.0	5	2	MLT-S	0.035	0.89	25	250

\*See page E4.2 for Panduit Factory Custom Marking Service information.

\*\*See pages B3.5 – B3.7 for Pan-Steel® Stainless Steel Cable Ties.

## Aluminum Marker Plates – Pan-Alum™ MMP Series

- Lightweight, aluminum construction for flexibility and ease of handling
- Five color options in addition to natural aluminum provide quick visual identification, ideal for applications requiring color-coding
- Easy feed marker plate design includes a raised slot to simplify cable tie installation and improve productivity

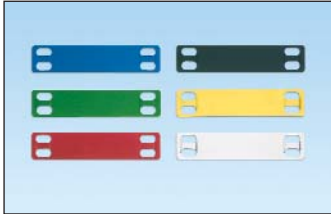

Part Number	Material	Color	Length		Width		Custom Marking Parameters**		Used with Pan-Alum™ Cable Ties	Std. Pkg. Qty.	Std. Ctn. Qty.
			In.	mm	In.	mm	Max. 3/16" (4.77mm) Characters per Line	Max. Lines			
			<b>MMP350H-CALBU</b>	Anodized Aluminum	Blue	3.50	89.0	0.75			
<b>MMP350H-CALGR</b>	Green	100	1000								
<b>MMP350H-CALRD</b>	Red	100	1000								
<b>MMP350H-CALBL</b>	Black	100	1000								
<b>MMP350H-CALYL</b>	Yellow	100	1000								
<b>MMP350H-CAL</b>	Aluminum	Natural								100	1000

\*See Pan-Alum™ Aluminum Ties on page B3.10 for matching natural finish and five colors.

\*\*See page, E4.2 for Panduit Factory Custom Marking Service.

## **NEW!** Metal Embossing Hand Tool and Tape System

- New multi-functional cutting die design creates embossed marker plates with raised cable tie slot in one step instead of three, for faster installation
- Lightweight, compact and portable, allows user to create custom length identification on demand at remote job sites
- Embosses 3/16" characters onto stainless steel or aluminum tape, to improve visibility in applications that are subjected to dirt or paint



Part Number	Part Description	Std. Pkg. Qty.
<b>Tool Kit</b>		
<b>MEHT187</b>	Includes tool, additional marking wheel, carrying case, one roll each META (aluminum) and METS (stainless steel) tape. Characters included: A B C D E F G H I J K L M N O P Q R S T U V W X Y Z 1 2 3 4 5 6 7 8 9 / ( )	1
<b>Tape</b>		
<b>META-X</b>	.50" x 16' (12.7mm x 4.9m) aluminum tape*.	10
<b>METS3-X</b>	.50" x 21' (12.7mm x 6.4m) 316 grade stainless steel tape.	10
<b>METS4-X</b>	.50" x 21' (12.7mm x 6.4m) 304 grade stainless steel tape.	10

\*Aluminum ties are recommended for use with aluminum tape to prevent galvanic reaction (corrosion that can occur between stainless steel and aluminum in certain environments).

A. System Overview

## Metal Indenting Machine

- Provides quick, easy, and permanent identification with Panduit® Pan-Alum™ Marker Plates and Cable Ties and Pan-Steel® Stainless Steel Marker Plates, Tags, Cable Ties and Straps
- Automatic table indexing advances material forward for convenience and improved productivity
- New, improved design features aluminum base and durable construction

B1. Cable Ties

B2. Cable Accessories



B3. Stainless Steel Ties

Part Number	Part Description	Std. Pkg. Qty.
<b>Indenting Machine</b>		
<b>MIM094</b>	Indenting machine with 3/32" (2.38mm) character wheel.	1
<b>MIM125</b>	Indenting machine with 1/8" (3.18mm) character wheel.	1
<b>MIM187</b>	Indenting machine with 3/16" (4.77mm) character wheel.	1

### Interchangeable Wheel Kits

<b>MIW094</b>	3/32" (2.38mm) character wheel kit (wheel and indexing gear).	1
<b>MIW125</b>	1/8" (3.18mm) character wheel kit (wheel and indexing gear).	1
<b>MIW187</b>	3/16" (4.77mm) character wheel kit (wheel and indexing gear).	1

C1. Wiring Duct



C2. Surface Raceway

C3. Abrasion Protection

## **NEW!** Portable Embossing System\*

C4. Cable Management

- Easily moved from jobsite to jobsite to deliver a permanent identification solution where it's needed, when it's needed
- Easy-Mark™ Software allows for a quick print legend and exact preview saving time and reducing print costs
- Creates raised characters on stainless steel and aluminum marker plates, to deliver maximum visibility for medium to high volume applications that are exposed to dirt and paint
- Easy loading hopper allows for easy stacking of up to 200 plates, saving time and money
- Improves productivity by providing a reliable connection from the embossing machine to your PC using Easy-Mark™ Software

D1. Terminals

D2. Power Connectors

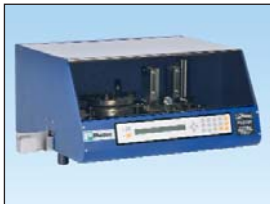

D3. Grounding Connectors

Part Number	Part Description	Std. Pkg. Qty.
<b>PES197*</b>	Portable embossing system 3/16" (4.77mm) character, 11.5" (292mm) x 21.0" (534mm) x 19.0" (483mm), 95 lbs. (43 kg), 115 volt, 60 Hz with Easy-Mark™ Software.	1

Characters include: ABCD...Z, 0123...9, ! @ # \$ % & \* ( ) - + = : " ' . / ?

\*For use with 1000 pack marker plates only.

**System Requirements:** Designed for Windows^ 98, Windows MS, Windows 2000, Windows NT 4.x, Windows XP, Windows Vista 64 MB hard drive space, and 64 MB RAM (256 MB RAM recommended). Female DB9 serial communication port.

^Windows is either a registered trademark or trademark of Microsoft Corporation in the United States and/or other countries.

E1. Labeling Systems

E2. Labels

E3. Pre-Printed & Write-On Markers

E4. Permanent Identification

E5. Lockout/Tagout & Safety Solutions

F. Index

Part Number	Material	Color	Length/Diameter		Width		Max. 3/16" (4.77mm) Character Per Line	Thickness		Std. Pkg. Qty.	Std. Ctn. Qty.	
			In.	mm	In.	mm		In.	mm			
<b>Pan-Steel® Marker Plates</b>												
<b>MMP350-M</b>	304 Stainless Steel	Natural	3.50	89	0.75	19	18	0.010	0.25	1000	4000	
<b>MMP350-M316</b>	316 Stainless Steel									1000	4000	
<b>MMP350H-M</b>	304 Stainless Steel									1000	4000	
<b>MMP350H-M316</b>	316 Stainless Steel	1000								4000		
<b>MMP350H-MALBU</b>	Anodized Aluminum	Blue								1000	4000	
<b>MMP350H-MALGR</b>		Green								1000	4000	
<b>MMP350H-MALRD</b>		Red			1000	4000						
<b>MMP350H-MALBL</b>		Black			1000	4000						
<b>MMP350H-MALYL</b>		Yellow			1000	4000						
<b>MMP350H-MAL</b>	Aluminum	Natural			0.54	13.7	0.012	0.30	1000	4000		
<b>MMP350HW54-MAL</b>											1000	4000
<b>MMP350W38-M</b>											304 Stainless Steel	1000
<b>MMP350W38-M316</b>	316 Stainless Steel		0.38	10	18	0.010	0.25	1000	4000			



## LOCKOUT/TAGOUT

The Occupational Safety and Health Administration (OSHA) mandates that all energy sources be isolated and locked out to protect employees from injuries caused by the accidental startup of equipment under repair or service. OSHA 1910.147 outlines the control of this hazardous energy with an effective lockout/tagout program. Panduit offers a complete line of lockout/tagout products to aid in compliance with OSHA 1910.147 including:



- Training manuals and videos to help train employees on the requirements of lockout/tagout
- Extensive line of universal, high quality devices to lockout a variety of energy sources
- Lockout/tagout kits and stations that offer a convenient method to store and contain lockout devices, tags, and padlocks
- High quality, durable, secure padlocks in a variety of styles, colors, and keying configurations that ensure safety and security
- Extensive line of safety identification products that include tags, signs, and warning labels

Panduit offers everything you need to establish and maintain an effective lockout/tagout program. Ensure employee safety while conducting lockout/tagout procedures by utilizing Panduit innovative products and high quality materials.

A.  
System  
Overview

B1.  
Cable  
Ties

B2.  
Cable  
Accessories

B3.  
Stainless  
Steel Ties

C1.  
Wiring  
Duct

C2.  
Surface  
Raceway

C3.  
Abrasion  
Protection

C4.  
Cable  
Management

D1.  
Terminals

D2.  
Power  
Connectors

D3.  
Grounding  
Connectors

E1.  
Labeling  
Systems

E2.  
Labels

E3.  
Pre-Printed  
& Write-On  
Markers

E4.  
Permanent  
Identification

E5.  
Lockout/  
Tagout  
& Safety  
Solutions

F.  
Index

A. System Overview

## OSHA Lockout/Tagout Compliance and Training Kit

B1. Cable Ties

• Takes you step-by-step through the process of bringing your company into compliance with OSHA Standard 1910.147; also provides training materials and devices for educating employees on the elements and applications of lockout/tagout

• This complete package includes:

**Training video:** DVD video “Life is on the Line” for training employees on the elements and application of lockout/tagout (LOTO)

**Compliance CD containing:**

**Training materials:** Training agenda, quiz, certificate, and key points for hands on device training

**Templates:** Step-by-step interactive presentation; facility and machine specific procedure templates; equipment, training, and inspection logs; lockout/tagout program template; periodic and lockout/tagout checklists

**Components:** Demonstration components for thorough “hands-on” training including circuit breakers, ball valves, etc., and the compatible lockout devices

B2. Cable Accessories

B3. Stainless Steel Ties



Part Number	Part Description	Std. Pkg. Qty.
PSL-LOTO-TRAIN	OSHA lockout/tagout compliance kit.	1

C1. Wiring Duct

C2. Surface Raceway

## Group Lockout/Tagout Training Video

C3. Abrasion Protection

• “Your Lock is Your Key to Life” Training Program provides thorough instruction on OSHA recommended safety practices and procedures for group lockout – multi-craft/multi-shift lockout operations

This complete package includes:

- Group lockout/tagout video
- Participant guides with quizzes
- Certificate of completion cards
- Leader’s guide complete with quiz key
- Training log
- Lockout/tagout samples
- Panduit lockout/tagout bulletin
- Lockout steps wallet cards

C4. Cable Management

D1. Terminals

D2. Power Connectors

D3. Grounding Connectors



Part Number	Part Description	Number of Guides and Cards Included	Std. Pkg. Qty.	Std. Ctn. Qty.
PSL-LTPGP	Group lockout/tagout video complete training program, English, VHS format.	10	1	5
PSL-LTMGP	Replacement group lockout/tagout participant guides and cards, English.	10	1	10

E1. Labeling Systems

## Lockout/Tagout Steps/Calendar Wallet Card

E2. Labels

• Provides those employees responsible for lockout/tagout with a constant reminder of the OSHA recommended steps for shutdown and startup

• Current calendar year is printed on back side

E3. Pre-Printed & Write-On Markers

E4. Permanent Identification

E5. Lockout/Tagout & Safety Solutions

F. Index

DANGER

A LIFE IS ON THE LINE!

OSHA LOCKOUT STEPS

SHUTDOWN

Inform operator and supervisor about work to be done

- 1) Prepare for shutdown
- 2) Shutdown/turn off equipment
- 3) Isolate from energy source
- 4) Apply lockout/tagout to energy isolating device
- 5) Release all potentially hazardous stored or residual energy
- 6) Verify the isolation

STARTUP

- 1) Assure equipment operationally intact, clear all personnel & tools
- 2) Notify all affected employees about startup and lockout/tagout device removal
- 3) Assure lockout/tagout is removed from each energy-isolating device  
(See section 6(e) and 6(f) of 29 CFR 1910.147 for specific requirements of the standard)

Part Number	Part Description	Width		Height		Number of Cards Included	Std. Pkg. Qty.	Std. Ctn. Qty.
		In.	mm	In.	mm			
PSL-STEPS	Lockout/tagout steps/calendar wallet card.	2.13	54.00	3.38	86.00	25	1	4

## “No Tool” Circuit Breaker Lockout Devices

- Individual circuit breaker can be locked in the off position quickly and easily without any tools
- Compact, universal design fits a wide range of single, double, and triple handle circuit breakers
- Accommodates breaker handle sizes ranging from .30 – .60 inches (7.62mm – 15.24mm) tall and .16 – .35 inches (4.06mm x 8.89mm) thick
- Easily attached with no modifications to panel or circuit breaker and does not require holes in circuit breaker handle
- Constructed of rugged nylon and stainless steel providing strength, durability, added security and corrosion resistance



Part Number	Part Description	Std. Pkg. Qty.	Std. Ctn. Qty.
PSL-CBNT	“No Tool” universal circuit breaker lockout.	1	10
PSL-CBILNT	“No Tool” circuit breaker lockout for use with Square D I-LINE <sup>^</sup> /Federal Pacific (FPE) circuit breakers.	1	10

<sup>^</sup>I-LINE is a registered trademark of Square D Company.

## Large Handle Circuit Breaker Lockout Device

- Individual circuit breakers can be locked in the off position quickly and easily without any tools
- Compact, universal design fits a wide range of large handle circuit breakers
- Accommodates breaker handle dimensions up to .80 inches thick x 3.00 inches wide (20.32mm x 76.20mm)
- Easily attached with no modifications to panel or circuit breaker
- Constructed of rugged nylon and stainless steel providing strength, durability, added security and corrosion resistance



Part Number	Part Description	Std. Pkg. Qty.	Std. Ctn. Qty.
PSL-CBL	Large handle circuit breaker lockout.	1	10

## Circuit Breaker Lockout Devices

- Individual circuit breakers can be locked in the off position quickly and easily
- Compact, universal design fits a wide range of single, double, and triple handle circuit breakers
- Accommodates breaker handles .30 – .60 inches (7.62mm – 15.24mm) tall and .25 – .44 inches (6.35mm – 11.18mm) thick
- Easily attached with no modifications to panel or circuit breaker and does not require hole in circuit breaker handle
- Constructed of rugged nylon and stainless steel, providing strength, durability, added security and corrosion resistance



Part Number	Part Description	Std. Pkg. Qty.	Std. Ctn. Qty.
PSL-CB	Universal circuit breaker lockout.	1	10
PSL-CBIL	Circuit breaker lockout device for use with Square D I-LINE <sup>^</sup> /Federal Pacific (FPE) circuit breakers.	1	10
PSL-CBKIT	Circuit breaker lockout kit (1 each PSL-CBL, CBNT, CBILNT).	1	10
PSL-CB-3PC	(3) PSL-CB universal circuit breaker lockout.	1	10

<sup>^</sup>I-LINE is a registered trademark of Square D Company.

A.  
System  
Overview

B1.  
Cable Ties

B2.  
Cable  
Accessories

B3.  
Stainless  
Steel Ties

C1.  
Wiring  
Duct

C2.  
Surface  
Raceway

C3.  
Abrasion  
Protection

C4.  
Cable  
Management

D1.  
Terminals

D2.  
Power  
Connectors

D3.  
Grounding  
Connectors

E1.  
Labeling  
Systems

E2.  
Labels

E3.  
Pre-Printed  
& Write-On  
Markers

E4.  
Permanent  
Identification

E5.  
Lockout/  
Tagout  
& Safety  
Solutions

F.  
Index

A. System Overview

## Plug Lockout Device

B1. Cable Ties

- Individual plugs in a wide range of sizes can be locked out to prevent energization
- Accommodates padlocks with shackle lengths of 1.50 inches (38.10mm) or greater and plugs with a hole in a blade

- Constructed of rugged polycarbonate providing strength, durability, added security and corrosion resistance

B2. Cable Accessories



B3. Stainless Steel Ties

Part Number	Part Description	Std. Pkg. Qty.	Std. Ctn. Qty.
<b>PSL-P</b>	Plug lockout.	1	10
<b>PSL-PI</b>	Global plug lockout for 220 - 240 Volt AC/Industrial Plugs.	1	10

C1. Wiring Duct

C2. Surface Raceway

## Cord Lockout Devices

C3. Abrasion Protection

- Individual corded plugs in a wide range of sizes can be locked out to prevent energization

- Constructed of rugged polypropylene providing strength, durability, and added security

C4. Cable Management



D1. Terminals

D2. Power Connectors

D3. Grounding Connectors

Part Number	Part Description	Std. Pkg. Qty.	Std. Ctn. Qty.
<b>PSL-CL110</b>	Lockout for 120 VAC corded plugs, 2.00" x 2.00" x 3.50" inside dimensions.	1	10
<b>PSL-CL480</b>	Lockout for 240 – 480 VAC corded plugs, 3.25" x 3.25" x 6.50" inside dimensions.	1	10

E1. Labeling Systems

## Receptacle Blockout Device

- Accommodates standard 120 V electrical receptacles
- Blockout receptacles to prevent equipment damage from overloading circuits or electrical interference

- Constructed of high density polyethylene providing strength, durability, and added security

E2. Labels



E3. Pre-Printed & Write-On Markers

E4. Permanent Identification

E5. Lockout/Tagout & Safety Solutions

Part Number	Part Description	Std. Pkg. Qty.	Std. Ctn. Qty.
<b>PSL-ERB</b>	Blockout for 120 V electrical receptacle.	1	25

F. Index

## Toggle Switch Lockout Device

- Compact secure design fits most toggle switches and some small circuit breakers
- Easily attached without removal of faceplate or screws
- Accommodates switches
  - .45 – .78 inches (11.43mm – 19.81mm) tall x
  - .25 – .38 inches (6.35mm – 9.65mm) wide x
  - .25 – .40 inches (6.35mm – 10.16mm) thick
- Constructed of rugged nylon and stainless steel providing strength, durability, added security and corrosion resistance



Part Number	Part Description	Std. Pkg. Qty.	Std. Ctn. Qty.
PSL-WS	Toggle switch lockout.	1	10

## Toggle/Rocker Switch Lockout Device

- Toggle/rocker switches controlling electrical supply can be locked out
- Accommodates standard wall switch faceplates
- Install using faceplate screws
- Constructed of rugged polypropylene providing strength, durability, and added security



Part Number	Part Description	Std. Pkg. Qty.	Std. Ctn. Qty.
PSL-WS1A	Toggle/rocker switch lockout.	1	10

## Gate Valve Lockout Devices

- Gate valves regulating hydraulic, pneumatic, and chemical energy can be locked out quickly and easily
- Accommodates valve handles ranging from 1.00 inch (25.40mm) to 13.00 inches (330.20mm) in diameter
- Constructed of rugged polypropylene providing strength, durability, and added security



Part Number	Part Description	Std. Pkg. Qty.	Std. Ctn. Qty.
PSL-V2A	Gate valve lockout, accommodates 1.00" – 2.50" diameter handle.	1	10
PSL-V6A	Gate valve lockout, accommodates 2.50" – 6.50" diameter handle.	1	10
PSL-V9	Gate valve lockout, accommodates 6.50" – 10.00" diameter handle.	1	10
PSL-V13	Gate valve lockout, accommodates 10.00" – 13.00" diameter handle.	1	—

A.  
System  
Overview

B1.  
Cable Ties

B2.  
Cable  
Accessories

B3.  
Stainless  
Steel Ties

C1.  
Wiring  
Duct

C2.  
Surface  
Raceway

C3.  
Abrasion  
Protection

C4.  
Cable  
Management

D1.  
Terminals

D2.  
Power  
Connectors

D3.  
Grounding  
Connectors

E1.  
Labeling  
Systems

E2.  
Labels

E3.  
Pre-Printed  
& Write-On  
Markers

E4.  
Permanent  
Identification

E5.  
Lockout/  
Tagout  
& Safety  
Solutions

F.  
Index

A. System Overview

## Ball Valve Lockout Devices

B1. Cable Ties

- Ball valves regulating hydraulic, pneumatic, and chemical energy can be locked out quickly and easily
- Accommodates valve diameters ranging from .25 inches (6.35mm) to 3.00 inches (76.20mm)

- Constructed of rugged polypropylene providing strength, durability, and added security

B2. Cable Accessories



B3. Stainless Steel Ties

C1. Wiring Duct

Part Number	Part Description	Std. Pkg. Qty.	Std. Ctn. Qty.
<b>PSL-BV1</b>	Ball valve lockout, accommodates .25" – 1.00" valve pipe diameter.	1	10
<b>PSL-BV2</b>	Ball valve lockout, accommodates 1.25" – 3.00" valve pipe diameter.	1	10
<b>PSL-BV3</b>	Ball valve lockout, accommodates 2.00" – 8.00" valve pipe diameter.	1	10
<b>PSL-BFV</b>	Butterfly valve lockout, accommodates most butterfly valve handles.	1	10

C2. Surface Raceway

## Multiple Lockout Device

- Device can be used alone as a lockout hasp or with provided 0.19 inches (4.8mm) diameter cable to lockout electrical disconnects, gate valves, or large cumbersome devices

- Compact and easy to install
- Constructed of rugged polycarbonate and stainless steel providing strength, durability, added security and corrosion resistance

C3. Abrasion Protection



C4. Cable Management

D1. Terminals

D2. Power Connectors

D3. Grounding Connectors

E1. Labeling Systems

E2. Labels

E3. Pre-Printed & Write-On Markers

E4. Permanent Identification

E5. Lockout/Tagout & Safety Solutions

F. Index

Part Number	Part Description	Std. Pkg. Qty.	Std. Ctn. Qty.
<b>PSL-MLD</b>	Multiple lockout device; includes lockout hasp and 6.0' (1.8m) vinyl coated galvanized steel cable with loop hole.	1	20
<b>PSL-MLDH-X</b>	Multiple lockout device (hasp only).	10	—
<b>PSL-MLDC</b>	6.0' (1.8m) vinyl coated galvanized steel cable with loop hole (cable only).	1	5
<b>PSL-MLDC200</b>	200.0' (61.0m) vinyl coated galvanized steel cable on roll without loop hole (cable only).	1	—
<b>PSL-MLDCT</b>	6.0' (1.8m) nylon coated high temperature rating galvanized steel cable with loop hole (cable only).	1	—
<b>PSL-MLD-CRIMP</b>	Additional crimps for creating cable loop holes.	10	20
<b>PSL-MLD-TOOL</b>	Tool for installing crimps on custom-length cables using the PSL-MDLC200.	1	6



Lockout single or multiple electrical disconnects



Lockout gate valves



Immobilize large or cumbersome devices, such as forklifts

## Pneumatic Energy Lockout Device

- Pneumatic energy devices can be locked out quickly and easily without costly tool modifications or inconvenient in-line valves
- When installed on the male pneumatic fitting, prevents the ability to engage into the female fitting

- Universal compact design makes the pneumatic lockout device easy to transport and install on almost any fitting, even in tight spaces
- Rugged stainless steel construction offers superior strength, durability, added security and corrosion resistance



Part Number	Part Description	Std. Pkg. Qty.	Std. Ctn. Qty.
<b>PSL-PEL</b>	Pneumatic energy lockout device, 3.50" (88.9mm) diameter x 0.10" (2.54mm) thick.	1	20

## Electrician Lockout Kit

- Kit contains a variety of lockout/tagout devices commonly used by an individual electrician



Part Number	Contents	Std. Pkg. Qty.	Std. Ctn. Qty.
PSL-PK-EA	(1) Screwdriver. (1) PSL-PK pouch. (1) PSL-8 red non-conductive lockout padlock. (1) PSL-MLD multiple lockout device. (1) PSL-WS wall switch lockout device. (1) PSL-CBNT "No Tool" circuit breaker lockout device. (1) PSL-P plug lockout device. (5) PVT-30 electrician's blocking tags.	1	5

## Contractor Lockout Kit

- Kit contains a variety of lockout/tagout devices commonly used by electrical contractors



Part Number	Contents	Std. Pkg. Qty.
PSL-KT-CONA	(1) Screwdriver. (1) PSL-KT carrying case – 5.0" x 3.5" x 11.0" (127mm x 89mm x 279mm). (6) PSL-8 red non-conductive lockout padlocks. (1) PSL-1A lockout hasp – 1.0" (25mm) jaw diameter. (1) PSL-MLD multiple lockout device. (3) PSL-WS wall switch lockouts. (3) PSL-CBNT "No Tool" circuit breaker lockout device. (3) PSL-P plug lockouts. (15 Tags) PVT-98 "EQUIPMENT LOCKED OUT BY..." safety tags.	1

## MRO Lockout Kit

- Kit contains a variety of lockout/tagout devices commonly used by maintenance and repair personnel



Part Number	Contents	Std. Pkg. Qty.
PSL-KT-MROA	(1) Screwdriver. (1) PSL-BX carrying case – 6.5" x 5.0" x 14.5" (32mm x 127mm x 368mm). (3) PSL-8 red non-conductive lockout padlocks. (1) PSL-MLD multiple lockout device. (2) PSL-WS wall switch lockouts. (2) PSL-CBNT "No Tool" circuit breaker lockout device. (2) PSL-P plug lockouts. (1) PSL-V6A gate valve lockout – 6.5" (165mm). (1) PSL-V2A gate valve lockout – 2.5" (64mm). (1) PSL-BV2 ball valve lockout – 3.0" (76mm). (1) PSL-CL110 110V plug lockout. (10) PVT-44 "DO NOT OPERATE" maintenance tags.	1

## Power and Panel Distribution Lockout Kit

- Kit contains a variety of lockout/tagout devices commonly used to isolate electrical distribution panels

- Durable steel case can be wall mounted or used as a portable case



Part Number	Contents	Std. Pkg. Qty.
PSL-KT-PWR	(1) Screwdriver. (1) PSL-STATION metal wall mount cabinet. (2) PSL-8 red non-conductive lockout padlocks. (1) PSL-MLD multiple lockout device. (2) PSL-CBNT "No Tool" circuit breaker lockout device. (2) PSL-CBILNT circuit breaker lockout device for Square D I-LINE^/Federal Pacific (FPE) circuit breakers. (2) PSL-CBL large handle circuit breaker lockout devices. (1) PSL-P plug lockout. (25) PVT-23-Q "DO NOT OPERATE ELECTRICIANS AT WORK" tags.	1

^ I-LINE is a registered trademark of Square D Company.

A. System Overview

B1. Cable Ties

B2. Cable Accessories

B3. Stainless Steel Ties

C1. Wiring Duct

C2. Surface Raceway

C3. Abrasion Protection

C4. Cable Management

D1. Terminals

D2. Power Connectors

D3. Grounding Connectors

E1. Labeling Systems

E2. Labels

E3. Pre-Printed & Write-On Markers

E4. Permanent Identification

E5. Lockout/Tagout & Safety Solutions

F. Index

A.  
System  
Overview

## Metal Wall Mount Cabinet

B1.  
Cable Ties

- Conveniently store lockout tools and accessories in one common area

- Durable steel case can be wall-mounted (nine mounting holes) or used as a portable case
- 14.75" x 10.25" x 4.63" (375.00mm x 260.00mm x 117.00mm)



B2.  
Cable  
Accessories

B3.  
Stainless  
Steel Ties

Part Number	Part Description	Std. Pkg. Qty.
<b>PSL-STATION</b>	Metal wall mount cabinet.	1
<b>PSL-PK</b>	Empty pouch for PSL-PK-EA.	1
<b>PSL-KT</b>	Empty plastic kit box for PSL-KT-CONA.	1
<b>PSL-BX</b>	Empty plastic kit Box for PSL-KT-MROA.	1

C1.  
Wiring  
Duct

## Lockout Stations

C2.  
Surface  
Raceway

- Conveniently store padlocks, tags, and lockout devices in one common area



PSL-10SWCA

C3.  
Abrasion  
Protection

C4.  
Cable  
Management

D1.  
Terminals

D2.  
Power  
Connectors

D3.  
Grounding  
Connectors

Part Number	Part Description	Width		Height		Std. Pkg. Qty.
		In.	mm	In.	mm	
<b>PSL-20SA</b>	Lockout station only, 20 person.	23.00	584.2	23.00	584.2	1
<b>PSL-20SWCA</b>	Lockout station with components, 20 person. Components include: (20) PSL-8 red non-conductive lockout padlocks (keyed differently) (6) PSL-1.5 lockout hasps (25 tags) PVT-98 safety tags (25 tags) PVT-41 safety tags	23.00	584.2	23.00	584.2	1
<b>PSL-10SA</b>	Lockout station only, 10 person.	11.50	292.1	23.00	584.2	1
<b>PSL-10SWCA</b>	Lockout station with components, 10 person. Components include: (10) PSL-8 red non-conductive lockout padlocks (keyed differently) (3) PSL-1.5 lockout hasps (15 tags) PVT-98 safety tags (10 tags) PVT-41 safety tags	11.50	292.1	23.00	584.2	1
<b>PSL-4SA</b>	Lockout station only, 4 person.	11.50	292.1	11.50	292.1	1
<b>PSL-4SWCA</b>	Lockout station with components, 4 person. Components include: (4) PSL-8 red non-conductive lockout padlocks (keyed differently) (3) PSL-1.5 lockout hasps (15 tags) PVT-98 safety tags	11.50	292.1	11.50	292.1	1

E1.  
Labeling  
Systems

E2.  
Labels

E3.  
Pre-Printed  
& Write-On  
Markers

## Group Lock Box

E4.  
Permanent  
Identification

- Manage multiple employees and energy sources involved in a group lockout procedure
- Accommodates up to thirteen padlocks (not included)

- Industrial powder coated steel construction
- Dimensions: 9.00"W x 6"H x 3.25"D (228.60mm x 152.40mm x 82.55mm)



E5.  
Lockout/  
Tagout  
& Safety  
Solutions

Part Number	Part Description	Std. Pkg. Qty.
<b>PSL-GLBN</b>	Group lock box.	1

F.  
Index



## Warning Label

- Warning label prohibits tampering with push buttons during repair or service
- Write-on area for adding your own warning message
- Made of vinyl cloth material that allows label to be removed easily after repairs are completed
- Features the international prohibition symbol for “Do Not Throw Switch”



### Material Chart

Material	Print Method	Temperature Range	Features
Vinyl Cloth, White	Pre-Printed	-50°F to 170°F (-46°C to 77°C)	Indoor/outdoor rated; thin conformable material with repositionable adhesive allows label to be removed and reused or used in temporary applications; provides durability, high temperature resistance, and dimensional stability for rough or textured surfaces.

Part Number	Part Description	Width		Height		Markers Per Book	Std. Pkg. Qty. (Book)	Std. Ctn. Qty. (Books)
		In.	mm	In.	mm			
PSL-CBWL	Warning label	4.84	123.00	.54	14.00	60	1	10

Can be clearly identified with Panduit permanent marking pens, page E5.18.

## Circuit Breaker Directory Sign

- Adhesive paper sign designed to provide clear identification of circuit breaker connections, list up to 40 circuits
- Eliminate the guesswork when identifying power sources – a must for lockout/tagout compliance



### Material Chart

Material	Print Method	Temperature Range	Features
Paper	Pre-Printed	-65°F to 200°F (-54°C to 93°C)	Indoor rated; general purpose material; excellent adhesion properties when applied to a clean, dry surface.

Part Number	Part Description	Color (Legend/Background)	Labels Per Pkg.	Width		Height		Std. Pkg. Qty.	Std. Ctn. Qty.
				In.	mm	In.	mm		
PES-S1	Circuit breaker directory sign.	Red and Black/White	5	13.00	330.00	5.50	140.00	1	20

A. System Overview

## Non-Conductive Lockout Padlocks

B1. Cable Ties

- Non-conductive lock body and shackle provide protection against electrical hazards
- Available in six assorted colors for quick visual color identification
- Padlocks can be ordered with various keying options (keyed-alike and master-keyed)
- Key-retention feature means that key cannot be removed from padlock when open
- Six-pin cylinder design allows for a large number of key options

B2. Cable Accessories



B3. Stainless Steel Ties

Part Number	Color	Std. Pkg. Qty.
PSL-8	Red	1
PSL-8BL	Black	1
PSL-8BU	Blue	1
PSL-8GR	Green	1
PSL-8OR	Orange	1
PSL-8YL	Yellow	1
PSL-8BR	Brown	1
PSL-8PU	Purple	1

C1. Wiring Duct

C2. Surface Raceway

C3. Abrasion Protection

C4. Cable Management

D1. Terminals

## High Security Padlocks

D2. Power Connectors

- Solid aluminum body with anodized aluminum finish provides improved durability and corrosion resistance
- Available in six assorted colors for quick visual color identification
- Padlocks can be ordered with various keying options (keyed-alike and master-keyed)
- Six-pin cylinder design allows for a large number of key change options

D3. Grounding Connectors



E1. Labeling Systems

E2. Labels

E3. Pre-Printed & Write-On Markers

E4. Permanent Identification

E5. Lockout/Tagout & Safety Solutions

F. Index

Part Number	Part Description	Std. Pkg. Qty.
PSL-8-LABEL	Package of 20 replacement labels for PSL-8 padlocks.	1

These locks can be master keyed or keyed alike. These locks can also be custom engraved. See Custom Lock Options on page E5.12 and Order Form on page E5.43.

Part Number	Color	Std. Pkg. Qty.
<b>Short shackle – 1.00" (25.4mm)</b>		
PSL-7	Red	1
PSL-7BL	Black	1
PSL-7BU	Blue	1
PSL-7GR	Green	1
PSL-7OR	Orange	1
PSL-7YL	Yellow	1
PSL-7BR	Brown	1
PSL-7PU	Purple	1

<b>Long shackle – 3.00" (76.2mm)</b>		
PSL-7-LS	Red	1
PSL-7BL-LS	Black	1
PSL-7BU-LS	Blue	1
PSL-7GR-LS	Green	1
PSL-7OR-LS	Orange	1
PSL-7YL-LS	Yellow	1
PSL-7BR-LS	Brown	1
PSL-7PU-LS	Purple	1

These locks can be ordered with various keying options (keyed-alike or master-keyed) and custom engraved. See Custom Lock Options on page E5.12 and Order Form on page E5.43.

## Laminated Steel Padlocks

- Standard locks are keyed differently – each padlock is supplied with two keys
- Hardened steel shackle with double-ball locking mechanism provides protection from cutting, prying, and rusting
- Available in six vinyl bumper colors for quick visual color identification
- Padlocks can be ordered with various keying options (keyed-alike and master-keyed)
- Galvanized layer design provides corrosion resistance in harsh environments



Part Number	Color	Std. Pkg. Qty.
<b>Short shackle – .75" (19.3mm)</b>		
PSL-6	Red	1
PSL-6BL	Black	1
PSL-6BU	Blue	1
PSL-6GR	Green	1
PSL-6WH	White	1
PSL-6YL	Yellow	1
<b>Long shackle – 2.00" (46.8mm)</b>		
PSL-6-LS	Red	1
PSL-6BL-LS	Black	1
PSL-6BU-LS	Blue	1
PSL-6GR-LS	Green	1
PSL-6WH-LS	White	1
PSL-6YL-LS	Yellow	1

These locks are not suitable for custom engraving.

See Custom Lock Options on page E5.12 and Order Form on page E5.43.

## Lockout Hasps

- Energy sources can be locked out quickly and easily by more than one worker for group lockout applications
- Heavy duty hasps with tamper-resistant designs to deter vandalism
- Variety of lockout hasp styles and sizes to accommodate a wide range of lockout applications

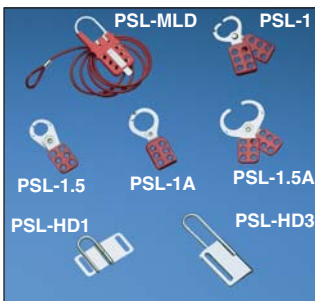

Part Number	Part Description	Max. No. Locks	Std. Pkg. Qty.	Std. Ctn. Qty.
PSL-MLD	Multiple lockout device; includes lockout hasp and 6.0' (1.8m) vinyl coated galvanized steel cable with loop-hole.	6	1	20
PSL-MLDH-X	Multiple lockout device (hasp only).	6	10	—
PSL-1	Hasp with 1.00" (25.40mm) diameter jaw and overlapping tabs.	6	12	144
PSL-1.5	Hasp with 1.50" (38.10mm) diameter jaw and overlapping tabs.	6	12	144
PSL-1A	Hasp with 1.00" (25.40mm) diameter jaw.	6	12	144
PSL-1.5A	Hasp with 1.50" (38.10mm) diameter jaw.	6	12	48
PSL-HD1	Heavy duty hasp with 1.00" x 1.00" (25.40mm x 25.40mm) clearance.	5	12	—
PSL-HD2.4	Heavy duty hasp with 1.00" x 2.40" (25.40mm x 60.00mm) clearance.	5	12	—
PSL-HD3	Heavy duty hasp with 1.00" x 3.00" (25.40mm x 76.00mm) clearance.	7	12	—

A.  
System  
Overview

B1.  
Cable Ties

B2.  
Cable  
Accessories

B3.  
Stainless  
Steel Ties

C1.  
Wiring  
Duct

C2.  
Surface  
Raceway

C3.  
Abrasion  
Protection

C4.  
Cable  
Management

D1.  
Terminals

D2.  
Power  
Connectors

D3.  
Grounding  
Connectors

E1.  
Labeling  
Systems

E2.  
Labels

E3.  
Pre-Printed  
& Write-On  
Markers

E4.  
Permanent  
Identification

E5.  
Lockout/  
Tagout  
& Safety  
Solutions

F.  
Index

A. System Overview

## Self-Laminating Padlock Labels

B1. Cable Ties

- Used to identify employees' locks; employees sign the label, attach it to the padlock, and overwrap with the clear vinyl to protect the legend
- Available in six colors for departmental coding
- One-piece design is easy to use

B2. Cable Accessories



B3. Stainless Steel Ties

C1. Wiring Duct

Part Number	Color	Width		Height		Std. Pkg. Qty.	Std. Ctn. Qty.
		In.	mm	In.	mm		
PSL-PL1BLKY	Black	10.00	254.00	.75	19.00	25	150
PSL-PL1BLUY	Blue	10.00	254.00	.75	19.00	25	150
PSL-PL1GRNY	Green	10.00	254.00	.75	19.00	25	150
PSL-PL1REDY	Red	10.00	254.00	.75	19.00	25	150
PSL-PL1WHTY	White	10.00	254.00	.75	19.00	25	150
PSL-PL1YELY	Yellow	10.00	254.00	.75	19.00	25	150

Labels are designed with blank write-on area for name and department designation and can be clearly identified with Panduit permanent marking pens.

C2. Surface Raceway

C3. Abrasion Protection

## Custom Lock Options

Padlocks are available with the following common lock options:

C4. Cable Management

- Master keyed
- Keyed-alike
- Variety of lock sizes and shackle lengths
- Engraving available on PSL-8 Safety Lockout and PSL-7 High Security Padlocks

D1. Terminals

D2. Power Connectors

D3. Grounding Connectors

E1. Labeling Systems

E2. Labels

E3. Pre-Printed & Write-On Markers

E4. Permanent Identification

E5. Lockout/Tagout & Safety Solutions

F. Index

Individually Keyed

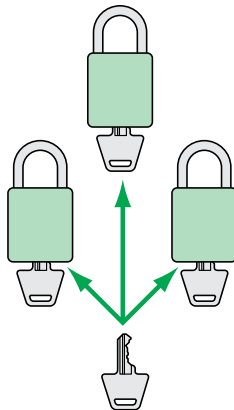

Master Key

Keyed-Alike Systems



## Metal I.D. Tags and Collars



Part Number	Part Description	Std. Pkg. Qty.	Std. Ctn. Qty.
PSL-TG1	Brass padlock identification tag.	12	48
PSL-SC	Padlock shackle collar and rivet.	12	48
MTB1D-Q	Marker tag, 1.00" circular, brass.	25	250
MT172W38-C	Marker tag, one hole, 304 Stainless Steel, rectangle, 1.72" x .38".	100	1000

## Padlock Eyes

- Padlock eyes assist with compliance to OSHA standards requiring that equipment be modified to accept locks and lockout devices
- Surface mounted eyes are made of .13 inches (3.00mm) hard wrought steel
- Tamper resistant inside mounting eyes – 2.50 inches W (64.00mm), accept shackle diameters up to .63 inches (16.00mm)



Part Number	Part Description	Std. Pkg. Qty.	Std. Ctn. Qty.
PSL-PE1	Padlock eyes, angled (metal mounting screws included).	1	10
PSL-PE2	Padlock eyes, straight (wood mounting screws included).	1	10

## Chain Attachment

- Optional 9.00 inches (229.00mm) chain for permanently attaching lockouts at pre-designed locations



Part Number	Part Description	Std. Pkg. Qty.	Std. Ctn. Qty.
PSL-PC	Heavy duty zinc plated steel chain with chain holder attached.	1	10

A.  
System  
Overview

B1.  
Cable Ties

B2.  
Cable  
Accessories

B3.  
Stainless  
Steel Ties

C1.  
Wiring  
Duct

C2.  
Surface  
Raceway

C3.  
Abrasion  
Protection

C4.  
Cable  
Management

D1.  
Terminals

D2.  
Power  
Connectors

D3.  
Grounding  
Connectors

E1.  
Labeling  
Systems

E2.  
Labels

E3.  
Pre-Printed  
& Write-On  
Markers

E4.  
Permanent  
Identification

E5.  
Lockout/  
Tagout  
& Safety  
Solutions

F.  
Index

A. System Overview

## Write-On Safety Tags

B1. Cable Ties

- Meet OSHA Standard 1910.147 requirements for tagout applications
- Semi-rigid plastic tags are 3.00" (76.00mm) W x 5.75" (146.00mm) H with a .38" (9.00mm) brass grommet for greater strength and increased durability
- Tags can be attached with a lockout device or with a Panduit PLT2S nylon tie (50 lb. loop tensile strength) supplied with each tag

- PVT-\* Package consists of five tags and five cable ties
- PVT-\*-Q Package consists of 25 tags and 25 cable ties
- Can be clearly identified with Panduit permanent marking pens

B2. Cable Accessories

B3. Stainless Steel Ties



C1. Wiring Duct

C2. Surface Raceway

C3. Abrasion Protection

C4. Cable Management

D1. Terminals

D2. Power Connectors

D3. Grounding Connectors

### Material Chart

Material	Print Method	Temperature Range	Features
Rigid Vinyl	Pre-Printed	-40°F to 150°F (-40°C to 66°C)	Indoor/outdoor rated; rigid material accepts ink; resistant to UV light, chemical atmosphere, and abrasion; excellent for applications where adhesives will not work.



Front PVT-9-Q Back



Front PVT-15 Back



Front PVT-23 Back PVT-23-Q



Front PVT-30 Back PVT-30-Q



Front PVT-41 Back



Front PVT-42-Q Back

E1. Labeling Systems

E2. Labels

E3. Pre-Printed & Write-On Markers

E4. Permanent Identification

E5. Lockout/Tagout & Safety Solutions

F. Index

## Write-On Safety Tags (continued)

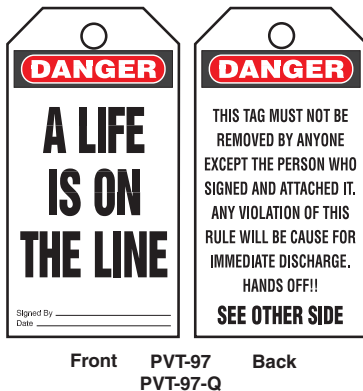
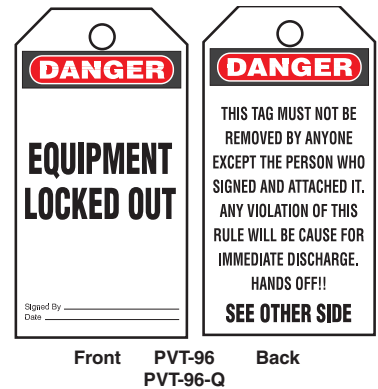
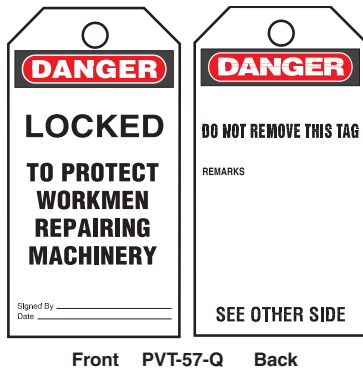

Tags continue on page E5.16.

A. System Overview

B1. Cable Ties

B2. Cable Accessories

B3. Stainless Steel Ties

C1. Wiring Duct

C2. Surface Raceway

C3. Abrasion Protection

C4. Cable Management

D1. Terminals

D2. Power Connectors

D3. Grounding Connectors

E1. Labeling Systems

E2. Labels

E3. Pre-Printed & Write-On Markers

E4. Permanent Identification

E5. Lockout/Tagout & Safety Solutions

F. Index

A. System Overview

## Write-On Safety Tags (continued)

B1. Cable Ties

B2. Cable Accessories

B3. Stainless Steel Ties

C1. Wiring Duct

C2. Surface Raceway

C3. Abrasion Protection

C4. Cable Management

D1. Terminals

D2. Power Connectors

D3. Grounding Connectors

E1. Labeling Systems

E2. Labels

E3. Pre-Printed & Write-On Markers

E4. Permanent Identification

E5. Lockout/Tagout & Safety Solutions

F. Index

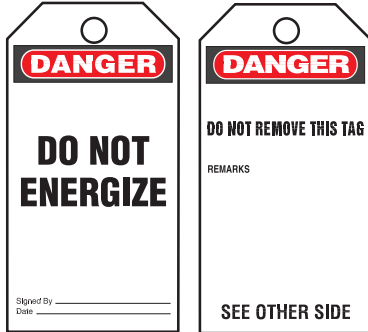

Front PVT-148-Q Back



Front PVT-150-Q Back



Front PVT-153-Q Back

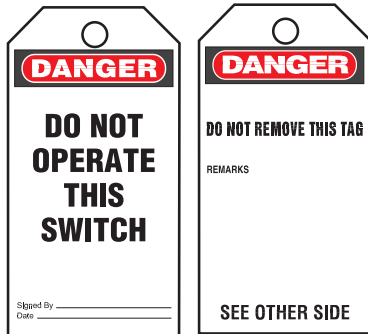

Front PVT-155-Q Back



Front PVT-156-Q Back



Front PVT-157-Q Back



Front PVT-158-Q Back



Front PVT-160-Q Back

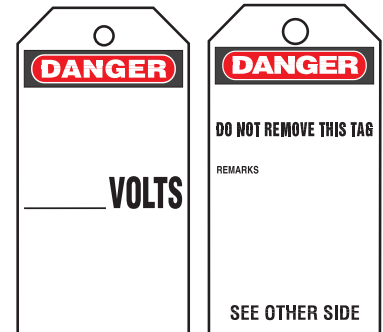

Front PVT-238-Q Back



## Bilingual Write-On Safety Tags

- Meet OSHA Standard 1910.147 requirements for tagout applications
- Semi-rigid plastic tags are 3.00"W x 5.75"H (76.00mm x 146.00mm) with a .38" (9.00mm) brass grommet for greater strength and increased durability

- Tags can be attached with a lockout device or with a Panduit PLT2S nylon tie (50 lb. loop tensile strength) supplied with each tag
- Package consists of 25 tags and 25 cable ties
- Can be clearly identified with Panduit permanent marking pens



Front PVT-97S-Q Back



Front PVT-161-Q Back



Front PVT-165-Q Back

## ISO Symbol Safety Tags

- Meets International Organization for Standardization (ISO) to communicate safety information
- Semi-rigid plastic tags are 3.00"W x 5.75"H (76.00mm x 146.00mm) with a .38" (9.00mm) brass grommet for greater strength and durability

- Tags have write-on surface and can be attached with a lockout device or with a Panduit PLT2S nylon tie (50 lb. loop tensile strength) supplied with each tag
- Package consists of five tags and five cable ties
- Can be clearly identified with Panduit permanent marking pens



Front PVT-110 Back  
(Do Not Throw Switch)



Front PVT-111 Back  
(Prohibition)



Front PVT-112 Back  
(Warning of Dangerous Electrical Voltage)

## Do It Yourself Tags



PVT-94-Q

PVT-95-Q

PVT-113-Q

PVT-199-Q

PVT-179-Q

PVT-200-Q

PVT-118-Q

A. System Overview

## Self-Laminating Photo Tags

B1. Cable Ties

- Semi-rigid plastic tags with polyester laminate to protect photos and other written data are 3.00"W x 5.75"H (76.00mm x 146.00mm) with a .38" (9.00mm) brass grommet for greater strength and durability

- Package consists of five tags and five cable ties
- Can be clearly identified with Panduit permanent marking pens

B2. Cable Accessories

- Tags have write-on surface and can be attached with a lockout device or with a Panduit PLT2S nylon tie (50 lb. loop tensile strength) supplied with each tag

B3. Stainless Steel Ties

C1. Wiring Duct

C2. Surface Raceway



Front PST-3 Back

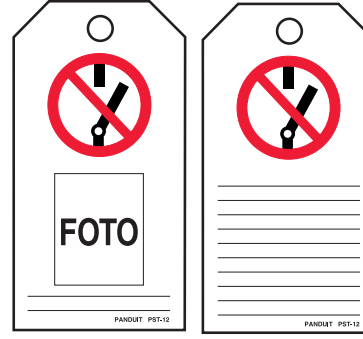

Front PST-12 Back

C3. Abrasion Protection

C4. Cable Management

D1. Terminals

D2. Power Connectors

## Permanent Marking Pens

- Fast drying, permanent ink – legible identification on nylon

- Used with marker ties, write-on labels and tags, where ordinary marking pens will not work

D3. Grounding Connectors



Part Number	Part Description	Ink Color	Std. Pkg. Qty.	Std. Ctn. Qty.
PFX-0	Permanent marking pen – fine tip.	Black	12	144
PFX-2	Permanent marking pen – fine tip.	Red	12	144

E1. Labeling Systems

E2. Labels

E3. Pre-Printed & Write-On Markers

E4. Permanent Identification

E5. Lockout/Tagout & Safety Solutions

F. Index

## Lockout/Tagout Safety Signs

### Indoor/Outdoor Sub-Surface Printed Adhesive Polyester (Type PPS)

- High quality signs for use indoors and outdoors
- Excellent resistance to UV light, chemical atmosphere, and abrasion
- Excellent life and adhesion properties
- Printed graphics are protected by clear polyester laminate

### Indoor/Outdoor Rigid Polyethylene (Type PRS)

- Rugged signs for indoors and outdoors
- Abrasion resistant
- Used where adhesives will not work

### Indoor Adhesive Vinyl (Type PVS)

- Economical general purpose signs for use in most environments
- Very good adhesive properties when applied to a clean, dry surface

### Material Chart



Material	Print Method	Temperature Range	Features
Polyester (PPS)	Pre-Printed	-40°F to 275°F (-40°C to 135°C)	Indoor/outdoor rated; laminated label material protects legend from abrasion and chemicals; resistant to UV light, chemical atmosphere, and abrasion; excellent life and adhesion properties.
Rigid Polyethylene (PRS)		-105°F to 250°F (-76°C to 121°C)	Indoor/outdoor rated; high quality, rugged material resistant to abrasion; use where adhesives will not work.
Vinyl (PVS)		-40°F to 200°F (-40°C to 93°C)	Indoor rated; economical general purpose material; excellent adhesion properties when applied to a clean, dry surface.

### Size Reference Chart

Part Number	Width		Height		Signs per Card
	In.	mm	In.	mm	
*0109*	9.00	228.60	1.50	38.10	1
*0204*	4.50	114.30	2.25	57.15	2
*0209*	9.00	228.60	2.25	57.15	1
*0305*	5.00	127.00	3.50	88.90	1
*0503*	3.00	76.20	5.00	127.00	2
*0507*	7.00	177.80	5.00	127	1
*0509*	9.00	228.60	5.00	127	1
*0710*	10.00	254.00	7.00	177.8	1
*1014*	14.00	355.60	10.00	254	1
*0202*	2.25	57.15	2.25	57.15	4
*0505*	5.00	127.00	5.00	127.00	1

\*Denotes the part numbers' prefix and suffix.



PVS0305W2102Y



PVS0305W2101Y^  
PVS0507W2101Y^



PRS1014B364  
PVS0509B364Y  
PVS0710B364Y  
PPS0710B364  
PRS0710B364



PPS0710D72  
PRS0710D72  
PRS1014D72  
PVS0109D72Y  
PVS0204D72Y  
PVS0710D72Y

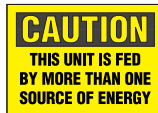

PVS0305C174Y  
PVS0505C174Y  
PPS0305C174



PVS0710C173Y



PVS0204D100Y



PVS0209D445Y



PVS0204C171Y



PVS0710C180Y



PVS0204C176Y



PVS0204C177Y

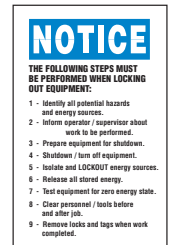

PVS0503N458Y



PVS0204C179Y



PVS0204W172Y



PVS0204C178Y



PPS0202B493

^Can be clearly identified with Panduit permanent marking pens.

A. System Overview

B1. Cable Ties

B2. Cable Accessories

B3. Stainless Steel Ties

C1. Wiring Duct

C2. Surface Raceway

C3. Abrasion Protection

C4. Cable Management

D1. Terminals

D2. Power Connectors

D3. Grounding Connectors

E1. Labeling Systems

E2. Labels

E3. Pre-Printed & Write-On Markers

E4. Permanent Identification

E5. Lockout/Tagout & Safety Solutions

F. Index

A.  
System  
Overview

## Jack Module Blockout Device

B1.  
Cable Ties

- Blocks unauthorized access to jacks and potentially harmful foreign objects, saving time and money associated with data security breaches, network downtime, repair and hardware replacement
- Compatible with most RJ45 jacks to accommodate a variety of applications and does not interfere with jack contacts

- Can be installed/removed without interfering with adjacent jacks or hardware
- May only be released with the special removal tool, ensuring the safety and security of your network infrastructure

B2.  
Cable  
Accessories

B3.  
Stainless  
Steel Ties



C1.  
Wiring  
Duct

C2.  
Surface  
Raceway



C3.  
Abrasion  
Protection

C4.  
Cable  
Management

D1.  
Terminals

D2.  
Power  
Connectors

D3.  
Grounding  
Connectors

E1.  
Labeling  
Systems

E2.  
Labels

E3.  
Pre-Printed  
& Write-On  
Markers

E4.  
Permanent  
Identification

E5.  
Lockout/  
Tagout  
& Safety  
Solutions

F.  
Index

Part Number*	Part Description	Color	Std. Pkg. Qty.	Std. Ctn. Qty.
<b>PSL-DCJB</b>	Package of ten RJ45 jack blockout devices and one removal tool.	Red	1	20
<b>PSL-DCJB-BL</b>	Package of ten RJ45 jack blockout devices and one removal tool.	Black	1	20
<b>PSL-DCJB-BU</b>	Package of ten RJ45 jack blockout devices and one removal tool.	Blue	1	20
<b>PSL-DCJB-YL</b>	Package of ten RJ45 jack blockout devices and one removal tool.	Yellow	1	20
<b>PSL-DCJB-IW</b>	Package of ten RJ45 jack blockout devices and one removal tool.	International White	1	20
<b>PSL-DCJB-GR</b>	Package of ten RJ45 jack blockout devices and one removal tool.	Green	1	20
<b>PSL-DCJB-IG</b>	Package of ten RJ45 jack blockout devices and one removal tool.	International Gray	1	20
<b>PSL-DCJB-OR</b>	Package of ten RJ45 jack blockout devices and one removal tool.	Orange	1	20

\*Available in bulk packages of 100 devices and five removal tools. To order bulk package add -C to the suffix of part number.

## RJ45 Plug Lock-In Device

- Tamper-resistant design blocks unauthorized removal of cable, IP phone, other networking equipment or critical connection
- Deters unauthorized users from moving or stealing VoIP phones helping to maintain E911 service
- Compact design does not interfere with adjacent jacks, even in high-density applications



Part Number*	Part Description	Color	Std. Pkg. Qty.	Std. Ctn. Qty.
PSL-DCPLX	Package of ten RJ45 plug lock-in devices and one installation/removal tool.	Red	1	20
PSL-DCPLX-BL	Package of ten RJ45 plug lock-in devices and one installation/removal tool.	Black	1	20
PSL-DCPLX-BU	Package of ten RJ45 plug lock-in devices and one installation/removal tool.	Blue	1	20
PSL-DCPLX-YL	Package of ten RJ45 plug lock-in devices and one installation/removal tool.	Yellow	1	20
PSL-DCPLX-IW	Package of ten RJ45 plug lock-in devices and one installation/removal tool.	International White	1	20
PSL-DCPLX-GR	Package of ten RJ45 plug lock-in devices and one installation/removal tool.	Green	1	20
PSL-DCPLX-OR	Package of ten RJ45 plug lock-in devices and one installation/removal tool.	Orange	1	20
PSL-DCPLX-IG	Package of ten RJ45 plug lock-in devices and one installation/removal tool.	International Gray	1	20
PSL-DCPLRX	Package of ten recessed RJ45 plug lock-in devices and one installation/removal tool.	Red	1	20
PSL-DCPLRX-BL	Package of ten recessed RJ45 plug lock-in devices and one installation/removal tool.	Black	1	20
PSL-DCPLRX-BU	Package of ten recessed RJ45 plug lock-in devices and one installation/removal tool.	Blue	1	20
PSL-DCPLRX-YL	Package of ten recessed RJ45 plug lock-in devices and one installation/removal tool.	Yellow	1	20
PSL-DCPLRX-IW	Package of ten recessed RJ45 plug lock-in devices and one installation/removal tool.	International White	1	20
PSL-DCPLRX-GR	Package of ten recessed RJ45 plug lock-in devices and one installation/removal tool.	Green	1	20
PSL-DCPLRX-OR	Package of ten recessed RJ45 plug lock-in devices and one installation/removal tool.	Orange	1	20
PSL-DCPLRX-IG	Package of ten recessed RJ45 plug lock-in devices and one installation/removal tool.	International Gray	1	20

\*Available in bulk packages of 100 devices and five installation/removal tools. To order bulk package add -C to the suffix of part number.

A.  
System  
Overview

B1.  
Cable Ties

B2.  
Cable  
Accessories

B3.  
Stainless  
Steel Ties

C1.  
Wiring  
Duct

C2.  
Surface  
Raceway

C3.  
Abrasion  
Protection

C4.  
Cable  
Management

D1.  
Terminals

D2.  
Power  
Connectors

D3.  
Grounding  
Connectors

E1.  
Labeling  
Systems

E2.  
Labels

E3.  
Pre-Printed  
& Write-On  
Markers

E4.  
Permanent  
Identification

E5.  
Lockout/  
Tagout  
& Safety  
Solutions

F.  
Index

A. System Overview

## LC Duplex Adapter Blockout Device

B1. Cable Ties

- TIA/EIA-604 FOCIS-10 compliant device fits all LC duplex adapters for a variety of applications and installations
- Tamper-resistant design blocks unauthorized access to LC duplex ports to reduce the risk of damage, saving time and money associated with downtime, repair and hardware replacement

- Also functions as dust plug to mechanically protect the LC adapter optics and render it "eye-safe"
- Removal tool allows only authorized personnel to release the device, ensuring safety and security of your network infrastructure
- Available in multiple colors to match or contrast adapter colors for easy identification of blocked out adapters

B2. Cable Accessories

- Compact, low profile design allows installation or removal without disturbing adjacent ports or installed patch cords in high-density applications

B3. Stainless Steel Ties

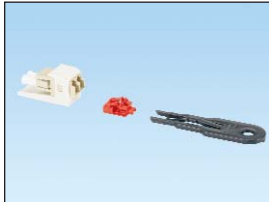

C1. Wiring Duct

C2. Surface Raceway



C3. Abrasion Protection

C4. Cable Management

Part Number*	Part Description	Color	Std. Pkg. Qty.	Std. Ctn. Qty.
<b>PSL-LCAB</b>	Package of ten LC duplex adapter blockout devices and one removal tool.	Red	1	20
<b>PSL-LCAB-AQ</b>	Package of ten LC duplex adapter blockout devices and one removal tool.	Aqua	1	20
<b>PSL-LCAB-BL</b>	Package of ten LC duplex adapter blockout devices and one removal tool.	Black	1	20
<b>PSL-LCAB-BU</b>	Package of ten LC duplex adapter blockout devices and one removal tool.	Blue	1	20
<b>PSL-LCAB-EI</b>	Package of ten LC duplex adapter blockout devices and one removal tool.	Electric Ivory	1	20

\*Also available in bulk packages of 100 devices and five removal tools. To order bulk package, add -C to the end of the part number.

D1. Terminals

## SC Adapter Blockout Device

D2. Power Connectors

- TIA/EIA-604 FOCIS-3 compliant device fits all SC adapters for a variety of applications and installations
- Tamper-resistant design blocks unauthorized access to SC switch and HBA/NIC ports, switch uplinks and user outlets, saving time and money associated with data security breaches, network downtime, repairs and hardware replacement
- Compact, low profile design allows installation or removal without disturbing adjacent ports or installed patch cords in high-density applications

- Also functions as dust plug to mechanically protect the SC adapters/receptacle optics and renders it "eye-safe" to prevent exposure to laser radiation and contamination on dust sensitive transceivers
- Removal tool allows only authorized personnel to release the device, ensuring safety and security of your network infrastructure
- Available in multiple colors for visual identification or aesthetics

D3. Grounding Connectors

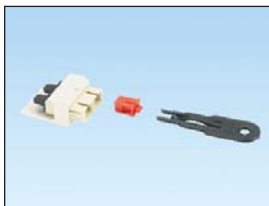

E1. Labeling Systems

E2. Labels

E3. Pre-Printed & Write-On Markers

E4. Permanent Identification

E5. Lockout/Tagout & Safety Solutions

F. Index

Part Number*	Part Description	Color	Std. Pkg. Qty.	Std. Ctn. Qty.
<b>PSL-SCBD</b>	Package of ten SC adapter blockout devices and one removal tool.	Red	1	20
<b>PSL-SCBD-AG</b>	Package of ten SC adapter blockout devices and one removal tool.	Green	1	20
<b>PSL-SCBD-AQ</b>	Package of ten SC adapter blockout devices and one removal tool.	Aqua	1	20
<b>PSL-SCBD-BL</b>	Package of ten SC adapter blockout devices and one removal tool.	Black	1	20
<b>PSL-SCBD-BU</b>	Package of ten SC adapter blockout devices and one removal tool.	Blue	1	20
<b>PSL-SCBD-EI</b>	Package of ten SC adapter blockout devices and one removal tool.	Electric Ivory	1	20

\*Also available in bulk packages of 100 devices and five removal tools. To order bulk package, add -C to the end of the part number.

## SAFETY AND FACILITY IDENTIFICATION

Panduit offers a full line of safety and facility identification products to ensure employee safety with an effectively identified workplace.



- Safety signs and labels offered in a variety of materials, colors, sizes and legends
- Voltage markers in adhesive and snap-on style
- Utility tapes in a variety of materials, colors, sizes and legends
- Letters and numbers in a variety of materials and sizes
- Tags in a variety of materials, colors, sizes and legends

Panduit safety and facility identification products are designed to assist you with creating a safe, compliant, and efficient workplace.

A.  
System  
Overview

B1.  
Cable Ties

B2.  
Cable  
Accessories

B3.  
Stainless  
Steel Ties

C1.  
Wiring  
Duct

C2.  
Surface  
Raceway

C3.  
Abrasion  
Protection

C4.  
Cable  
Management

D1.  
Terminals

D2.  
Power  
Connectors

D3.  
Grounding  
Connectors

E1.  
Labeling  
Systems

E2.  
Labels

E3.  
Pre-Printed  
& Write-On  
Markers

E4.  
Permanent  
Identification

E5.  
Lockout/  
Tagout/  
& Safety  
Solutions

F.  
Index

A. System Overview

## Electrical Hazard Safety Signs

B1. Cable Ties



B2. Cable Accessories

B3. Stainless Steel Ties

### Material Chart

Material	Print Method	Temperature Range	Features
Polyester (PPS)	Pre-Printed	-40°F to 275°F (-40°C to 135°C)	Indoor/outdoor rated; laminated label material protects legend from abrasion and chemicals; resistant to UV light, chemical atmosphere, and abrasion; excellent life and adhesion properties.
Rigid Polyethylene (PRS)		-105°F to 250°F (-76°C to 121°C)	Indoor/outdoor rated; high quality, rugged material resistant to abrasion; use where adhesives will not work.
Vinyl (PVS)		-40°F to 200°F (-40°C to 93°C)	Indoor rated; economical general purpose material; excellent adhesion properties when applied to a clean, dry surface.

C1. Wiring Duct

### Size Reference Chart

Part Number	Width		Height		Signs Per Card
	In.	mm	In.	mm	
*0109*	9.00	228.60	1.50	38.10	1
*0204*	4.50	114.30	2.25	57.15	2
*0305*	5.00	127.00	3.50	88.90	1
*0507*	7.00	177.80	5.00	127.00	1
*0509*	9.00	228.60	5.00	127.00	1
*0514*	14.00	355.60	5.00	127.00	1
*0710*	10.00	254.00	7.00	177.80	1
*1007*	10.00	254.00	7.00	177.80	1
*1014*	14.00	355.60	10.00	254.00	1
*1420*	20.00	508.00	14.00	355.60	1

\*Denotes the part numbers' prefix and suffix.

C2. Surface Raceway

C3. Abrasion Protection

C4. Cable Management

D1. Terminals

D2. Power Connectors

D3. Grounding Connectors

E1. Labeling Systems

E2. Labels

E3. Pre-Printed & Write-On Markers

E4. Permanent Identification

E5. Lockout/Tagout & Safety Solutions

F. Index



PVS0305W2102Y



PVS0305W2101Y^  
PVS0507W2101Y^

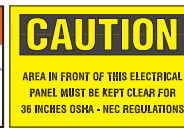

PPS0710C141



PPS0710D28^



PPS0710D66



PRS0710D68



PPS0710D70  
PRS1014D70



PRS1014D71



PPS0710D101



PPS0710D72  
PRS0710D72  
PRS1014D72  
PVS0109D72Y  
PVS0204D72Y  
PVS0710D72Y



PPS0305D73  
PPS0710D73  
PPS1014D73  
PRS1014D73



PPS0305D75  
PPS0710D75  
PRS1420D75



PPS0710D77



PVS0204D100Y

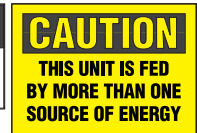

PPS0305C174  
PVS0305C174Y  
PVS0505C174Y



PPS1007D72SE



PPS0710D24



PPS0514B363

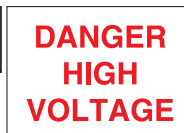

PPS0710B364  
PRS0710B364  
PRS1014B364  
PVS0509B364Y  
PVS0710B364Y



PRS1014D79



PRS0910D453



PPS0710N203

^Can be clearly identified with Panduit permanent marking pens.



## Short Circuit Warning Signs

- Aids in compliance with UL 508A requirement

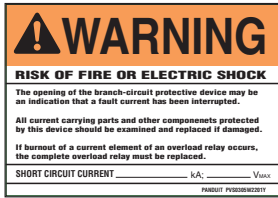

PPS0305W2201Y  
PPS0507W2201Y

### Material Chart

Material	Print Method	Temperature Range	Features
Polyester (PPS)	Pre-Printed	-40°F to 275°F (-40°C to 135°C)	Indoor/outdoor rated; laminated label material protects legend from abrasion and chemicals; resistant to resistant to UV light, chemical atmosphere, and abrasion; excellent life and adhesion properties.

### Size Reference Chart

Part Number	Width		Height		Signs Per Card
	In.	mm	In.	mm	
*0305*	5.00	127.00	3.00	76.20	5
*0507*	7.00	177.80	5.00	127.00	5
*0710*	10.00	254.00	7.00	177.80	1
*1014*	14.00	355.60	10.00	254.00	1
*1209*	9.00	228.60	12.00	304.80	1

\*Denotes the part numbers' prefix and suffix.

## Photoluminescent Safety Signs

- Used to mark egress routes, fire alarms, and fire equipment that is clearly visible for up to ten hours after power is lost
- Absorbs energy from ambient light and releases this energy in the form of a glow when power is lost
- Panduit Photoluminescent Signs meet or exceed the following safety standard specification for photoluminescent safety markings including: ASTM E 2072-00, ASTM E 2073-00, ASTM E 2030-99, DIN67510-1, IMO Resolution A.752.18, ISO/CD 15370, DIN 67510, UL 924, ASTM 162, ASTM 648, ASTM 662, MIL-L-3891 B, NFPA 101 Life Safety Code, OSHA 1910.37



PPS0710G001  
PPS1014G002



PPS0710G020



PPS1209G010



PPS1209G011



PPS1209G012

## Electrical Symbols on Cards

### Material Chart

Material	Print Method	Temperature Range	Features
Vinyl Cloth	Pre-Printed	-50°F to 170°F (-46°C to 77°C)	Indoor/outdoor rated; conformable material with repositionable adhesive allows label to be removed and reused or used in temporary applications; provides durability, high temperature resistance, and dimensional stability for rough or textured surfaces.

Part Number	Symbol	Description	Marker Size		Markers Per Card	Std. Pkg. Card(s)	Std. Ctn. Card(s)
			In.	mm			
PESC-H-AT		WARNING OF DANGEROUS ELECTRICAL VOLTAGE	0.51 x 0.51	13.00 x 13.00	68	10	100
PESC-J-AT			0.75 x 0.75	19.00 x 19.00	36	10	100
PESC-H-E		EARTH (GROUND)	0.51 x 0.51	13.00 x 13.00	68	10	200
PESC-J-E			0.75 x 0.75	19.00 x 19.00	36	10	100
PESC-H-EC		SAFETY FUNCTION	0.51 x 0.51	13.00 x 13.00	68	10	200
PESC-J-EC			0.75 x 0.75	19.00 x 19.00	36	10	100
PESC-H-HT		STATIC SENSITIVE DEVICE - HANDLING PRECAUTIONS REQUIRED	0.51 x 0.51	13.00 x 13.00	68	10	100
PESC-J-HT			0.75 x 0.75	19.00 x 19.00	36	10	100
PESC-H-PE		PROTECTIVE CONDUCTOR	0.51 x 0.51	13.00 x 13.00	68	10	100
PESC-J-PE			0.75 x 0.75	19.00 x 19.00	36	10	100

A. System Overview

## Conductor Identification Labels











B1. Cable Ties

### Material Chart

Material	Print Method	Temperature Range	Features
Polyester	Pre-Printed	-40°F to 250°F (-40°C to 121°C)	Indoor/outdoor rated; laminated label material protects legend from abrasion and chemicals; resistant to UV light, chemical atmosphere, and abrasion; excellent life and adhesion properties

B2. Cable Accessories

B3. Stainless Steel Ties

Part Number	Symbol	Legend	Marker Diameter		Labels Per Sheet	Std. Pkg. Sheet(s)	Std. Ctn. Sheet(s)
			In.	mm			
PESS-A-CE		CE SYMBOL	0.49	12.50	20	10	100
PESS-B-CE			0.63	16.00	20	10	100
PESS-C-CE			0.79	20.00	10	10	100
PESS-D-CE			0.98	25.00	10	10	100
PESS-E-CE			1.24	31.50	10	10	100
PESS-A-ES		EARTH (GROUND)	0.49	12.50	20	10	100
PESS-B-ES			0.63	16.00	20	10	100
PESS-C-ES			0.79	20.00	10	10	100
PESS-D-ES			0.98	25.00	10	10	100
PESS-E-ES			1.24	31.50	10	10	100
PESS-A-L1		OUTER CONDUCTOR – L1	0.49	12.50	20	10	100
PESS-B-L1			0.63	16.00	20	10	100
PESS-C-L1			0.79	20.00	10	10	100
PESS-D-L1			0.98	25.00	10	10	100
PESS-E-L1			1.24	31.50	10	10	100
PESS-A-L2		OUTER CONDUCTOR 2 – L2	0.49	12.50	20	10	100
PESS-B-L2			0.63	16.00	20	10	100
PESS-C-L2			0.79	20.00	10	10	100
PESS-D-L2			0.98	25.00	10	10	100
PESS-E-L2			1.24	31.50	10	10	100
PESS-A-L3		OUTER CONDUCTOR 3 – L3	0.49	12.50	20	10	100
PESS-B-L3			0.63	16.00	20	10	100
PESS-C-L3			0.79	20.00	10	10	100
PESS-D-L3			0.98	25.00	10	10	100
PESS-E-L3			1.24	31.50	10	10	100
PESS-A-LF		LEAD FREE SYMBOL	0.49	12.50	20	10	100
PESS-A-N		NEUTRAL CONDUCTOR – N	0.49	12.50	20	10	100
PESS-B-N			0.63	16.00	20	10	100
PESS-C-N			0.79	20.00	10	10	100
PESS-D-N			0.98	25.00	10	10	100
PESS-A-PE		PROTECTIVE CONDUCTOR – PE	0.49	12.50	20	10	100
PESS-A-ROHS		RoHS WHEELED BIN SYMBOL	0.49	12.50	20	10	100
PESS-A-SS		SAFETY FUNCTION	0.49	12.50	20	10	100
PESS-B-SS			0.63	16.00	20	10	100
PESS-C-SS			0.79	20.00	10	10	100
PESS-D-SS			0.98	25.00	10	10	100

C1. Wiring Duct

C2. Surface Raceway

C3. Abrasion Protection

C4. Cable Management

D1. Terminals

D2. Power Connectors

D3. Grounding Connectors

E1. Labeling Systems

E2. Labels

E3. Pre-Printed & Write-On Markers

E4. Permanent Identification

E5. Lockout/Tagout & Safety Solutions

F. Index

Order number of cards required.

## ISO Warning Symbols

### Material Chart

Material	Print Method	Temperature Range	Features
Paper (WL1, WL3)	Pre-Printed	-65°F to 200°F (-54°C to 80°C)	Indoor rated; general purpose and material; excellent adhesion properties when applied to a clean, dry surface.
Polyester (WL25)		-40°F to 250°F (-54°C to 93°C)	Indoor/outdoor rated; laminated label material protects legend from abrasion and chemicals; resistant to UV light, chemical atmosphere, and abrasion; excellent life and adhesion properties.
Vinyl (PESW, WL32Y, WL33Y, WL35Y, WL36Y)		-40°F to 176°F (-40°C to 80°C)	Indoor/outdoor rated; laminated label material protects legend from abrasion and chemicals; resistant to UV light, chemical atmosphere, and abrasion; excellent life and adhesion properties.

Part Number	Symbol	Description	Triangle Width		Markers Per Card/Pkg	Std. Pkg. Card(s)	Std. Ctn. Card(s)
			In.	mm			

### Cards

PESW-A-1Y		CAUTION - RISK OF ELECTRIC SHOCK	0.50	13.0	10	10	200
PESW-B-1Y			1.00	25.4	10	10	200
PESW-C-1Y			1.97	50.0	10	10	200
PESW-D-1Y			3.90	99.1	3	10	200
PESW-E-1Y			7.90	200.7	1	10	200
PESW-A-6Y		CAUTION - RISK OF IONIZING RADIATION	0.50	13.0	10	10	100
PESW-B-6Y			1.00	25.4	10	10	100
PESW-C-6Y			1.97	50.0	10	10	100
PESW-D-6Y			3.90	99.1	3	10	100
PESW-E-6Y			7.90	200.7	1	10	100
PESW-A-8Y		CAUTION - LASER BEAM	0.50	13.0	10	10	200
PESW-B-8Y			1.00	25.4	10	10	200
PESW-C-8Y			1.97	50.0	10	10	100
PESW-D-8Y			3.90	99.1	3	10	100
PESW-E-8Y			7.90	200.7	1	10	100
PESW-A-9Y		CAUTION - GENERAL WARNING, RISK OF DANGER	0.50	13.0	10	10	200
PESW-B-9Y			1.00	25.4	10	10	200
PESW-C-9Y			1.97	50.0	10	10	100
PESW-D-9Y			3.90	99.1	3	10	100
PESW-E-9Y			7.90	200.7	1	10	100
PESW-A-11Y		WARNING OF STATIC SENSITIVE DEVICE	0.50	13.0	10	10	100
PESW-B-11Y			1.00	25.4	10	10	100
PESW-C-11Y			1.97	50.0	10	10	100
PESW-D-11Y			3.90	99.1	3	10	100
PESW-E-11Y			7.90	200.7	1	10	100

### Rolls

WL1		STATIC AWARENESS WARNING	2.00	50.8	500	1	10
WL3			2.00	50.8	500	1	10
WL32Y		RISK OF ELECTRIC SHOCK symbol	1.50	38.10	50	1	10
WL33Y			4.50	114.30	50	1	10
WL35Y		CAUTION - HOT SURFACE WARNING	2.00	50.80	50	1	10
WL36Y		WARNING - HOT SURFACE WARNING	2.00	50.80	50	1	10

A. System Overview

## Electrical Labels in Dispenser

B1. Cable Ties



B2. Cable Accessories

B3. Stainless Steel Ties

### Material Chart

Material	Print Method	Temperature Range	Features
Polyester	Pre-Printed	-40°F to 250°F (-40° to 121°C)	Indoor/outdoor rated; laminated label material protects legend from abrasion and chemicals; resistant to UV light chemical atmosphere and abrasion; excellent life and adhesion properties.

C1. Wiring Duct

C2. Surface Raceway

C3. Abrasion Protection

C4. Cable Management

D1. Terminals

D2. Power Connectors

D3. Grounding Connectors

E1. Labeling Systems



















E2. Labels

E3. Pre-Printed & Write-On Markers

E4. Permanent Identification

E5. Lockout/Tagout & Safety Solutions

F. Index

Part Number	Symbol	Description	Width		Height		Labels Per Pkg.	Std. Pkg. Dispenser(s)	Std. Ctn. Dispenser(s)	
			In.	mm	In.	mm				
<b>Dispensers</b>										
PLD-12 <sup>^</sup>		CIRCUIT NO., LOCATION	1.50	38.10	1.00	25.40	200	1	10	
PLD-30 <sup>^</sup>		CAUTION	1.50	38.10	1.00	25.40	200	1	10	
PLD-36		CAUTION 120 V	1.50	38.10	1.00	25.40	200	1	10	
PLD-37		CAUTION 220 V	1.50	38.10	1.00	25.40	200	1	10	
PLD-38		CAUTION 240 V	1.50	38.10	1.00	25.40	200	1	10	
PLD-43 <sup>^</sup>		DANGER HIGH VOLTAGE	1.50	38.10	1.00	25.40	200	1	10	
PLD-45		CAUTION 230 V	1.50	38.10	1.00	25.40	200	1	10	
PLD-46		CAUTION 277 V	1.50	38.10	1.00	25.40	200	1	10	
PLD-47		CAUTION 277/480 V	1.50	38.10	1.00	25.40	200	1	10	
PLD-52		ATTENTION SYMBOL (ISO 3864)	1.50	38.10	1.00	25.40	200	1	10	
PLD-56		HIGH VOLTAGE SYMBOL (ISO 3864)	1.50	38.10	1.00	25.40	200	1	10	
PLD-57		GROUND SYMBOL (ISO 3864)	.75	19.10	.75	19.10	300	1	10	
PLD-58		STATIC AWARENESS WARNING	1.50	38.10	1.00	25.40	200	1	10	
PLD-60		STATIC AWARENESS WARNING	3.00	76.20	1.00	25.40	100	1	10	
PLD-67		DANGER HIGH VOLTAGE	1.50	38.10	1.00	25.40	200	1	10	
PLD-68 <sup>^</sup>		LOCKOUT BY _____ DATE _____	1.50	38.10	1.00	25.40	200	1	10	
PLD-71		WARNING - FOR CONTINUED PROTECTION ...	2.00	50.80	1.00	25.40	150	1	10	
PLD-72		CAUTION LOCK OUT FOR SAFETY BEFORE ...	1.50	38.10	1.00	25.40	200	1	10	
PLD-74		CAUTION HAZARD OF ELECTRIC SHOCK ...	1.50	38.10	1.00	25.40	200	1	10	
PLD-80		INTRINSICALLY SAFE WIRING	1.00	25.40	1.50	38.10	200	1	10	
PLD-81		SERVICE DISCONNECT	1.50	38.10	1.00	25.40	200	1	10	
PLD-91		CAUTION 480 V	1.50	38.10	1.00	25.40	200	1	10	

Order number of dispensers required in multiples of Std. Pkg.







<sup>^</sup>Can be clearly identified with Panduit permanent marking pens.

## Write-On Labels on Cards



### Material Chart

Material	Print Method	Temperature Range	Features
Vinyl Cloth	Pre-Printed	-50°F to 170°F (-46°C to 77°C)	Indoor/outdoor rated; conformable material with repositionable adhesive allows label to be removed and reused or used in temporary applications; provides durability, high temperature resistance, and dimensional stability for rough or textured surfaces.

Part Number	Symbol	Description	Width		Height		Markers Per Card	Std. Pkg. Card(s)	Std. Ctn. Card(s)
			In.	mm	In.	mm			
PCWL-BL		BLANK						25	100
PCWL-ACC		ACCEPTED						25	100
PCWL-CAL		CALIBRATION						25	100
PCWL-CALD		CALIBRATED	1.50	38.10	0.63	15.90	14	25	100
PCWL-ICAL		CALIBRATION						25	100
PCWL-REJ		REJECTED						25	100

Order number of cards required.  
Can be clearly identified with Panduit permanent marking pens.

A.  
System  
Overview

B1.  
Cable  
Ties

B2.  
Cable  
Accessories

B3.  
Stainless  
Steel Ties

C1.  
Wiring  
Duct

C2.  
Surface  
Raceway

C3.  
Abrasion  
Protection

C4.  
Cable  
Management

D1.  
Terminals

D2.  
Power  
Connectors

D3.  
Grounding  
Connectors

E1.  
Labeling  
Systems

E2.  
Labels

E3.  
Pre-Printed  
& Write-On  
Markers

E4.  
Permanent  
Identification

E5.  
Lockout/  
Tagout  
& Safety  
Solutions

F.  
Index

A. System Overview

## Write-On Quality Labels in Dispenser

B1. Cable Ties

B2. Cable Accessories

B3. Stainless Steel Ties



### Material Chart

Material	Print Method	Temperature Range	Features
Polyester	Pre-Printed	-40°F to 250°F (-40° to 121°C)	Indoor/outdoor rated; laminated label material protects legend from abrasion and chemicals; resistant to UV light, chemical atmosphere, and abrasion; excellent life and adhesion properties.

C1. Wiring Duct

C2. Surface Raceway

C3. Abrasion Protection

C4. Cable Management

D1. Terminals

D2. Power Connectors

D3. Grounding Connectors

E1. Labeling Systems

E2. Labels

E3. Pre-Printed & Write-On Markers

E4. Permanent Identification

E5. Lockout/Tagout & Safety Solutions

F. Index



Part Number^	Symbol	Legend	Width		Height		Labels Per Dispenser	Std. Pkg. Dispenser(s)	Std. Ctn. Dispenser(s)
			In.	mm	In.	mm			
PLD-17		BLANK	1.50	38.1	1.00	25.4	200	1	10
PLD-18		BLANK							
PLD-3		CALIBRATION, BY, DATE, DUE							
PLD-4		ACCEPTED, BY, DATE							
PLD-7		TESTED, DATE, BY							
PLD-11		DO NOT USE AFTER							
PLD-22		CALIBRATION, BY, DATE, DUE							
PLD-28		INSPECTED, BY, DATE							
PLD-29		MAINTENANCE, BY, DATE							
PLD-62		BLANK							
PLD-63		BLANK							
PLD-64		BLANK							
PLD-77		BLANK							
PLD-78		BLANK							

Order number of dispensers required in multiples of Std. Pkg.  
Can be clearly identified with Panduit permanent marking pens.

## Inspection Plates

### Material Chart

Material	Print Method	Temperature Range	Features
Destructible Vinyl	Pre-Printed	-50°F to 225°F (-46°C to 107°C)	Indoor/outdoor rated; label will destruct upon removal; for permanent and tamper resistant labeling applications.

Part Number	Symbol	Year	Marker Diameter		Markers Per Card	Std. Pkg. Card(s)	Std. Ctn. Card(s)
			In.	mm			
PEIP-A-12Y		12	0.59	15.0	10	10	100
PEIP-A-13Y		13	0.59	15.0	10	10	100
PEIP-A-14Y		14	0.59	15.0	10	10	100
PEIP-A-15Y		15	0.59	15.0	10	10	100
PEIP-D-12Y		2012	1.38	35.0	5	10	100
PEIP-D-13Y		2013	1.38	35.0	5	10	100
PEIP-D-14Y		2014	1.38	35.0	5	10	100
PEIP-D-15Y		2015	1.38	35.0	5	10	100

## Inspection Arrows

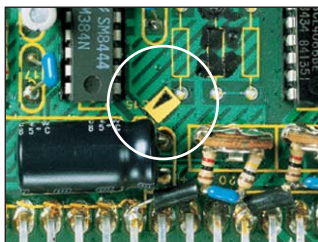

### Material Chart

Material	Print Method	Temperature Range	Features
Vinyl Cloth	Pre-Printed	-50°F to 170°F (-46°C to 77°C)	Indoor/outdoor rated; conformable material with repositionable adhesive allows label to be removed and reused or used in temporary applications; provides durability, high temperature resistance, and dimensional stability for rough or textured surfaces.

Part Number	Symbol	Width		Height		Markers Per Card	Std. Pkg. Card(s)	Std. Pkg. Card(s)
		In.	mm	In.	mm			
PARW125-RED		0.13	3.00	0.19	5.00	576	25	—
PARW125-YEL		0.13	3.00	0.19	5.00	576	25	100

A.  
System  
Overview

B1.  
Cable  
Ties

B2.  
Cable  
Accessories

B3.  
Stainless  
Steel Ties

C1.  
Wiring  
Duct

C2.  
Surface  
Raceway

C3.  
Abrasion  
Protection

C4.  
Cable  
Management

D1.  
Terminals

D2.  
Power  
Connectors

D3.  
Grounding  
Connectors

E1.  
Labeling  
Systems

E2.  
Labels

E3.  
Pre-Printed  
& Write-On  
Markers

E4.  
Permanent  
Identification

E5.  
Lockout/  
Tagout  
& Safety  
Solutions

F.  
Index

A. System Overview

## Voltage and Fiber Optic Markers

B1. Cable Ties



B2. Cable Accessories

B3. Stainless Steel Ties

C1. Wiring Duct

C2. Surface Raceway

C3. Abrasion Protection

C4. Cable Management

D1. Terminals

D2. Power Connectors

D3. Grounding Connectors

E1. Labeling Systems

E2. Labels

E3. Pre-Printed & Write-On Markers

E4. Permanent Identification

E5. Lockout/Tagout & Safety Solutions

F. Index

Style	Width		Length		Pipe/Conduit O.D. Range		Markers Per Card
	In.	mm	In.	mm	In.	mm	
<b>A</b>	9.00	228.00	2.25	57.10	3.00 and Over	76.20 and Over	1
<b>B</b>	4.50	114.30	1.13	28.60	1.25 – 3.00	31.70 – 76.20	4
<b>C</b>	2.20	57.10	0.50	12.70	1.25 – Under	31.70 and Under	18

### Material Chart

Material	Print Method	Temperature Range	Features
Polyester	Pre-Printed	-40°F to 275°F (-40°C to 135°C)	Indoor/outdoor rated; pre-coiled material protects legend from abrasion and chemicals; resistant to UV light, chemical atmosphere, and abrasion.

Part Number			Legend	Color (Legend/Background)	Std. Pkg. Qty.	Std. Ctn. Qty.
Style A	Style B	Style C				
PCV-110AY	PCV-110BY	PCV-110CY	110 Volts	Black/Orange	5	50
PCV-115AY	PCV-115BY	PCV-115CY	115 Volts		5	50
PCV-120/208AY	PCV-120/208BY	PCV-120/208CY	120/208 Volts		5	50
PCV-120AY	PCV-120BY	PCV-120CY	120 Volts		5	50
PCV-12470AY	PCV-12470BY	PCV-12470CY	12470 Volts		5	50
PCV-13200AY	PCV-13200BY	PCV-13200CY	13200 Volts		5	50
PCV-13800AY	PCV-13800BY	PCV-13800CY	13800 Volts		5	50
PCV-1PHAY	PCV-1PHBY	PCV-1PHCY	Single Phase		5	50
PCV-208AY	PCV-208BY	PCV-208CY	208 Volts		5	50
PCV-220AY	PCV-220BY	PCV-220CY	220 Volts		5	50
PCV-2300AY	PCV-2300BY	PCV-2300CY	2300 Volts		5	50
PCV-230AY	PCV-230BY	PCV-230CY	230 Volts		5	50
PCV-2400AY	PCV-2400BY	PCV-2400CY	2400 Volts		5	50
PCV-240AY	PCV-240BY	PCV-240CY	240 Volts		5	50
PCV-277/480AY	PCV-277/480BY	PCV-277/480CY	277/480 Volts		5	50
PCV-277AY	PCV-277BY	PCV-277CY	277 Volts		5	50
PCV-380AY	PCV-380BY	PCV-380CY	380 Volts		5	50
PCV-3PHAY	PCV-3PHBY	PCV-3PHCY	Three Phase		5	50
PCV-415AY	PCV-415BY	PCV-415CY	415 Volts		5	50
PCV-4160AY	PCV-4160BY	PCV-4160CY	4160 Volts		5	50
PCV-440AY	PCV-440BY	PCV-440CY	440 Volts		5	50
PCV-460AY	PCV-460BY	PCV-460CY	460 Volts		5	50
PCV-480AY	PCV-480BY	PCV-480CY	480 Volts		5	50
PCV-600AY	PCV-600BY	PCV-600CY	600 Volts		5	50
PCV-BLANKAY	PCV-BLANKBY	PCV-BLANKCY	Blank – No Legend		5	50
PCV-ESAY	PCV-ESBY	PCV-ESCY	Emergency Service		5	50
PCV-FAAY	PCV-FABY	PCV-FACY	Fire Alarm		5	50
PCV-FOAY	PCV-FOBY	PCV-FOCY	Fiber Optic		5	50
PCV-FOCAY	PCV-FOCBY	PCV-FOCCY	Fiber Optic Cable		5	50
PCV-MAINAY	PCV-MAINBY	PCV-MAINCY	Main		5	50
PCV-TELEAY	PCV-TELEBY	PCV-TELECY	Telephone		5	50

Style	Width		Length		Pipe/Conduit O.D. Range		Markers Per Card
	In.	mm	In.	mm	In.	mm	
<b>M</b>	14.00	355.60	23.00	584.20	2.25 – 6.00	57.20 – 152.40	1
<b>R</b>	8.00	230.20	8.00	230.20	0.75 – 2.25	19.10 – 57.20	1

Part Number		Legend	Color (Legend/Background)	Std. Pkg. Qty.	Std. Ctn. Qty.
Style M	Style R				
	PCV-120RY	120 Volts	Black/Orange	1	25
	PCV-480RY	480 Volts		1	25
PCV-FOMY	PCV-FORY	Fiber Optic		1	25



## Voltage and Safety Marker Books



### Material Chart

Material	Print Method	Temperature Range	Features
Vinyl	Pre-Printed	-40°F to 200°F (-40°C to 93°C)	Indoor rated; economical general purpose material; excellent adhesion properties when applied to a clean, dry surface.

Part Number	Legend	Markers Per Page	Markers Per Book	Std. Qty. Book(s)
-------------	--------	------------------	------------------	-------------------

### Voltage Markers 1.50" x 3.25" (38.00mm x 82.00mm)

Part Number	Legend	Markers Per Page	Markers Per Book	Std. Qty. Book(s)
PCVB-110Y	110 Volts	3	30	1
PCVB-220Y	220 Volts			
PCVB-277Y	277 Volts			
PCVB-277/480Y	277/480 Volts			
PCVB-440Y	440 Volts			
PCVB-480Y	480 Volts			
PCVB-4160Y	4160 Volts			

### Safety Markers 1.50" x 3.25" (38.00mm x 82.00mm)

Part Number	Legend	Markers Per Page	Markers Per Book	Std. Qty. Book(s)
PSSB-13	Danger High Voltage	3	30	1

## Hazard Tape



### Material Chart

Material	Print Method	Temperature Range	Features
Vinyl	Pre-Printed	-20°F to 175°F (-29°C to 79°C)	Indoor rated; color-coded for quick identification; can be used in place of paint; excellent adhesion properties when applied to a clean, dry surface.

Part Number	Part Description	Width		Length		Std. Pkg. Qty.	Std. Ctn. Qty.
		In.	mm	Ft.	m		
HT2S-BLK-YEL	Black/yellow stripe, adhesive continuous tape.	2.00	50.80	54.0	16.5	1	12
HT2S-RED-WHT	Red/white striped, adhesive continuous tape.	2.00	50.80	54.0	16.5	1	12
HT3S-BLK-YEL	Black/yellow striped, adhesive continuous tape.	3.00	76.20	54.0	16.5	1	10
HT3S-RED-WHT	Red/white striped, adhesive continuous tape.	3.00	76.20	54.0	16.5	1	10

## Solid Color Adhesive Warning Tape



### Material Chart

Material	Temperature Range	Features
Vinyl	-20°F to 175°F (-29°C to 79°C)	Indoor rated; color-coded for quick identification; can be used in place of paint; excellent adhesion properties when applied to a clean, dry surface.

Part Number	Color	Width		Length		Std. Pkg. Qty.	Std. Ctn. Qty.
		In.	mm	Ft.	m		
HT2-BLU	Blue	2.00	50.80	180.0	55.0	1	5
HT2-GRN	Green	2.00	50.80	180.0	55.0	1	5
HT2-ORN	Orange	2.00	50.80	180.0	55.0	1	5
HT2-RED	Red	2.00	50.80	180.0	55.0	1	5
HT2-WHT	White	2.00	50.80	180.0	55.0	1	5
HT2-YEL	Yellow	2.00	50.80	180.0	55.0	1	5

A. System Overview

## Reflective Tapes

- Reflective tapes can be used for illuminating or highlighting a range of objects
- Increases safety during power outages or other low light conditions
- Custom legends can be printed using a Panduit TDP43MY thermal printer
- Tapes are laminated for improved print quality and durability

B1. Cable Ties

B2. Cable Accessories

B3. Stainless Steel Ties

Part Number	Color	Width		Length		Std. Pkg. Qty.
		In.	mm	Ft.	m	
<b>T100X000RP1</b>	White	1.00	25.4	50.0	15.2	1
<b>T200X000RP1</b>	White	2.00	50.8	50.0	15.2	1
<b>T400X000RP1</b>	White	4.00	101.6	50.0	15.2	1
<b>T100X000RU1</b>	Orange	1.00	25.4	50.0	15.2	1
<b>T200X000RU1</b>	Orange	2.00	50.8	50.0	15.2	1
<b>T400X000RU1</b>	Orange	4.00	101.6	50.0	15.2	1
<b>T100X000RX1</b>	Yellow	1.00	25.4	50.0	15.2	1
<b>T200X000RX1</b>	Yellow	2.00	50.8	50.0	15.2	1
<b>T400X000RX1</b>	Yellow	4.00	101.6	50.0	15.2	1
<b>T400X000RW1</b>	Red	4.00	101.6	50.0	15.2	1
<b>T400X000RQ1</b>	Blue	4.00	101.6	50.0	15.2	1

C1. Wiring Duct

C2. Surface Raceway

C3. Abrasion Protection

C4. Cable Management

## Photoluminescent Tapes – Thermal Transfer Printable



Normal Lighting

- Used to mark egress routes, fire alarms, and fire equipment that is clearly visible for up to ten hours after power is lost
- Absorb energy from ambient light and releases this energy in the form of a glow when power is lost
- Can be used in the Panduit thermal transfer desktop printers to create direction arrow tape, striped tape, or safety signs on demand
- Panduit Photoluminescent Tapes meet or exceed the following safety standard specification for photoluminescent safety markings including: ASTM E 2072-00, ASTM E 2073-00, ASTM E 2030-99, DIN67510-1, IMO Resolution A.752.18, ISO/CD 15370, DIN 67510, UL 924, ASTM 162, ASTM 648, ASTM 662, MIL-L-3891 B, NFPA 101 Life Safety Code, OSHA 1910.37

D1. Terminals

D2. Power Connectors

D3. Grounding Connectors



Black Light

### Material Chart

Material	Print Method	Temperature Range	Features
Polyester, Photoluminescent (Y2)	Thermal Transfer (T)	-40°F to 230°F (-40°C to 110°C)	Indoor/outdoor rated; provides durability, high temperature resistance, and dimensional stability; does not stretch or easily tear; After power is lost, material emits glow that is clearly visible for up to ten hours.

E1. Labeling Systems

E2. Labels

E3. Pre-Printed & Write-On Markers

E4. Permanent Identification

E5. Lockout/Tagout & Safety Solutions

F. Index



PT2S-ARW



PT2S-BLK



PT2S-RED

Part Number	Part Description	Width		Length		Std. Pkg. Qty.	Std. Ctn. Qty.
		In.	mm	Ft.	m		

### Pre-Printed

<b>PT2S-ARW</b>	Photoluminescent, polyester tape, black arrow.	2.00	50.80	30.00	9.14	1	4
<b>PT2S-BLK</b>	Photoluminescent, polyester tape, black stripe.	2.00	50.80	30.00	9.14	1	4
<b>PT2S-RED</b>	Photoluminescent, polyester tape, red stripe.	2.00	50.80	30.00	9.14	1	4

### Blank

<b>T200X000Y2T</b>	Photoluminescent, polyester tape.	2.00	50.80	15.00	4.5	1	4
<b>T400X000Y2T</b>	Photoluminescent, polyester tape.	4.00	101.60	15.0	4.5	1	4

Order number of rolls required.

Labels roll mounted on 3.00" cores; when using the TDP43MY thermal transfer desktop printer and 3.00" cores, the roll stand (TDP43M-RS) is required.

## Underground Hazard Tape



Material Chart

Material	Print Method	Temperature Range	Features
Polyethylene (HTU, HTB)	Pre-Printed	-30°F to 200°F (-34°C to 93°C)	Indoor/outdoor rated; designed for direct burial; highly visible legend is protected from abrasion and chemicals; resistant to UV light, chemical atmosphere, and abrasion; will not biodegrade.
Detectible Laminated Aluminum (HTDU)	Pre-Printed	-30°F to 220°F (-34°C to 104°C)	Indoor/outdoor rated; aluminum embedded material is designed for direct burial; highly visible legend is protected from abrasion and chemicals; resistant to UV light, chemical atmosphere, and abrasion; will not biodegrade.

Part Number	Legend	Color (Legend/Background)	Height		Length		Std. Pkg. Qty.
			In.	mm	Ft.	m	
<b>Laminated Detectable Aluminum</b>							
HTDU2B-W	CAUTION WATER LINE BURIED BELOW	Black/Blue	2.00	50.80	1000.00	305.00	1
HTDU2O-FO	CAUTION FIBER OPTIC CABLE BURIED BELOW	Black/Orange					1
HTDU2O-T	CAUTION TELEPHONE LINE BURIED BELOW	Black/Orange					1
HTDU2R-E	CAUTION ELECTRIC LINE BURIED BELOW	Black/Red					1
HTDU3O-FO	CAUTION FIBER OPTIC CABLE BURIED BELOW	Black/Orange	3.00	76.00	1000.00	305.00	1
HTDU3O-T	CAUTION TELEPHONE LINE BURIED BELOW	Black/Orange					1
HTDU3R-E	CAUTION ELECTRIC LINE BURIED BELOW	Black/Red					1
HTDU6O-FO	CAUTION FIBER OPTIC CABLE BURIED BELOW	Black/Orange	6.00	152.00	1000.00	305.00	1
HTDU6O-T	CAUTION TELEPHONE LINE BURIED BELOW	Black/Orange					1
HTDU6R-E	CAUTION ELECTRIC LINE BURIED BELOW	Black/Red					1
<b>Polyethylene</b>							
HTU3G-T-M	CAUTION TELEPHONE LINE BURIED BELOW	Black/Green	3.00	76.00	1000.00	305.00	1
HTU3O-FO-M	CAUTION BURIED FIBER OPTIC CABLE	Black/Orange					1
HTU3O-T-M	CAUTION TELEPHONE LINE BURIED BELOW	Black/Orange					1
HTU3R-E-M	CAUTION ELECTRIC LINE BURIED BELOW	Black/Red					1
HTU3Y-E-M	CAUTION ELECTRIC LINE BURIED BELOW	Black/Yellow	6.00	152.00	1000.00	305.00	1
HTU6R-E	CAUTION ELECTRIC LINE BURIED BELOW	Black/Red					1
HTU6O-FO	CAUTION BURIED FIBER OPTIC CABLE	Black/Orange					1
HTU6O-T	CAUTION TELEPHONE LINE BURIED BELOW	Black/Orange					1
HTU6O-TV	CAUTION CABLE TV LINE BURIED BELOW	Black/Orange	6.00	152.00	1000.00	305.00	1
HTU6Y-E	CAUTION ELECTRIC LINE BURIED BELOW	Black/Yellow					1
HTU6Y-G	CAUTION GAS LINE BURIED BELOW	Black/Yellow					1

A. System Overview

## Barricade Tapes

B1. Cable Ties



B2. Cable Accessories

B3. Stainless Steel Ties

Part Number	Legend	Color (Legend/Background)	Height		Length		Std. Pkg. Qty.
			In.	mm	Ft.	m	
<b>HTB3-C-M</b>	CAUTION	Black/Yellow	3.00	76.20	1000.00	305.00	1
<b>HTB3-DNE-M</b>	CAUTION DO NOT ENTER	Black/Yellow	3.00	76.00	1000.00	305.00	1
<b>HTB3-HV-M</b>	CAUTION HIGH VOLTAGE	Black/Yellow	3.00	76.00	1000.00	305.00	1

C1. Wiring Duct

## Vinyl Letters and Numbers

### Material Chart

Material	Print Method	Temperature Range	Features
Vinyl (PVL)	Pre-Printed	-50°F to 225°F (-46°C to 107°)	Indoor/outdoor rated; heavy duty material for flat applications and safety and facility identification; resistant to UV light, chemical atmosphere, and abrasion.

C2. Surface Raceway



C3. Abrasion Protection

C4. Cable Management

D1. Terminals

D2. Power Connectors

D3. Grounding Connectors

E1. Labeling Systems

E2. Labels

E3. Pre-Printed & Write-On Markers

E4. Permanent Identification

E5. Lockout/Tagout & Safety Solutions

F. Index

Part Number	Legend	Legend Height		Height		Width		Color (Legend/Background)	Markers Per Card	Std. Pkg. Card(s)
		In.	mm	In.	mm	In.	mm			
<b>PVL100BY-0-Y</b>	0	1.00	25.40	1.50	38.10	0.88	22.35	Black/Yellow	10	25
<b>PVL100BY-1-Y thru PVL100BY-9-Y</b>	1 thru 9									25
<b>PVL100BY-A-Y thru PVL100BY-Z-Y</b>	A thru Z									25
<b>PVL100BY-DSH-Y</b>	—									25
<b>PVL200BY-0-Y</b>	0	2.00	50.80	2.25	57.15	0.88	22.35	Black/Yellow	10	25
<b>PVL200BY-1-Y thru PVL200BY-9-Y</b>	1 thru 9									25
<b>PVL200BY-A-Y thru PVL200BY-Z-Y</b>	A thru Z									25
<b>PVL200BY-DSH-Y</b>	—									25

## Vinyl Cloth Letters and Numbers



### Material Chart

Material	Print Method	Temperature Range	Features
Vinyl Cloth, (PCL,PCLCP)	Pre-Printed	-50°F to 170°F (-46°C to 77°C)	Indoor/outdoor rated; thin conformable material with repositionable adhesive allows label to be removed and reused or used in temporary applications; provides durability, high temperature resistance, and dimensional stability for rough or textured surfaces.

Part Number	Legend	Legend Height		Height		Width		Color (Legend/Background)	Markers Per Card	Std. Pkg. Card(s)	Std. Ctn. Card(s)								
		In.	mm	In.	mm	In.	mm												
PCL037-0	0	0.38	9.7	0.50	12.7	0.34	8.7	Black/Yellow	78	25	100								
PCL037-1 thru PCL037-9	1 thru 9									25	100								
PCL037-0-9	0 thru 9									25	100								
PCL037-A thru PCL037-Z	A thru Z									25	100								
PCL037-A-Z	A thru Z									25	100								
PCLCP037-A-Z	A thru Z									1	4								
PCLCP037-0-9	0 thru 9									1	4								
PCL037-DSH	-									25	100								
PCL062-0	0									0.63	16.0	0.75	19.1	0.56	14.2	Black/Yellow	32	25	100
PCL062-1 thru PCL062-9	1 thru 9																	25	100
PCL062-0-9	0 thru 9	1	4																
PCL062-A thru PCL062-Z	A thru Z	25	100																
PCL062-A-Z	A thru Z	25	100																
PCLCP062-0-9	1 thru 5 6 thru 0	1	4																
PCLCP062-A-Z	A thru Z	1	4																
PCL062-DSH	-	25	100																
PCL100-0	0	1.00	25.4	1.50	38.1	0.88	22.4	Black/Yellow	10									25	100
PCL100-1 thru PCL100-9	1 thru 9																	25	100
PCL100-0-9	0 thru 9									25	100								
PCL100-A thru PCL100-Z	A thru Z									25	100								
PCL100-A-J	A thru J									25	100								
PCL100-K-T	K thru T									25	100								
PCL100-U-Z	U thru Z									25	100								
PCLCP100-0-9	1 thru 5 6 thru 0									1	4								
PCLCP100-A-Z	A thru Z									1	4								
PCL100-DSH	-									25	100								
PCL200-0	0	2.00	50.8	2.25	57.2	0.88	22.4	Black/Yellow	10	25	100								
PCL200-1 thru PCL200-9	1 thru 9									25	100								
PCL200-0-9	0 thru 9									25	100								
PCL200-A thru PCL200-Z	A thru Z									25	100								
PCL200-A-J	A thru J									25	100								
PCL200-K-T	K thru T									25	100								
PCL200-U-Z	UK thru TZ									25	100								
PCLCP200-0-9	1 thru 5 6 thru 0									1	4								
PCLCP200-A-Z	A thru Z									1	4								
PCL200-DSH	-									25	100								

Table continues on page E5.38

A. System Overview

B1. Cable Ties

B2. Cable Accessories

B3. Stainless Steel Ties

C1. Wiring Duct

C2. Surface Raceway

C3. Abrasion Protection

C4. Cable Management

D1. Terminals

D2. Power Connectors

D3. Grounding Connectors

E1. Labeling Systems

E2. Labels

E3. Pre-Printed & Write-On Markers

E4. Permanent Identification

E5. Lockout/Tagout & Safety Solutions

F. Index

A. System Overview

## Vinyl Cloth Letters and Numbers (continued)

B1. Cable Ties

B2. Cable Accessories

B3. Stainless Steel Ties

C1. Wiring Duct

Part Number	Legend	Legend Height		Height		Width		Color (Legend/Background)	Markers Per Card	Std. Pkg. Card(s)	Std. Ctn. Card(s)
		In.	mm	In.	mm	In.	mm				
PCL300-0	0	3.00	76.2	3.50	88.9	1.50	38.1	Black/Yellow	6	25	100
PCL300-1 thru PCL300-9	1 thru 9									25	100
PCL300-A thru PCL300-Z	A thru Z									25	100
PCLCP300-0-9	1 thru 5 6 thru 0									1	4
PCLCP300-A-Z	A thru Z									1	4
PCL300-DSH	—									25	100

C2. Surface Raceway

## Reflective Letters and Numbers

C3. Abrasion Protection

C4. Cable Management



### Material Chart

Material	Print Method	Temperature Range	Features
Reflective Vinyl, (PRL)	Pre-Printed	-30°F to 200°F (-34°C to 93°C)	Indoor/outdoor rated; heavy duty reflective material for flat applications and safety and facility identification; resistant to UV light, chemical atmosphere, and abrasion.

D1. Terminals

D2. Power Connectors

D3. Grounding Connectors

E1. Labeling Systems

E2. Labels

E3. Pre-Printed & Write-On Markers

E4. Permanent Identification

E5. Lockout/Tagout & Safety Solutions

F. Index

Part Number	Legend	Legend Height		Height		Width		Color (Legend/Background)	Markers Per Pkg.	Std. Pkg. Qty.	Std. Ctn. Qty.			
		In.	mm	In.	mm	In.	mm							
PRL100BY-0 thru PRL100BY-9	0 thru 9	1.00	25.40	1.63	41.40	1.00	25.40	Black/Yellow	25	1	4			
PRL100BY-A thru PRL100BY-Z	A thru Z													
PRL100BY-DSH	—													
PRL100BY-18KIT	0 thru 9, A thru D, L, P, R, S											900	1	—
PRL100BY-36KIT	0 thru 9, A thru Z, —, Blank											950	1	—
PRL100BY-BLNK	BLANK								25	1	4			
PRL150YB-0 thru PRL150YB-9	0 thru 9	1.50	38.10	1.88	47.75	1.38	35.05	Yellow/Black	25	1	4			
PRL150YB-A thru PRL150YB-Z	A thru Z													
PRL150YB-DSH	—													
PRL250YB-0 thru PRL250YB-9	0 thru 9	2.50	63.50	2.88	73.15	1.75	44.45	Yellow/Black	25	1	4			
PRL250YB-A thru PRL250YB-Z	A thru Z													
PRL250YB-DSH	—													

## Sign Panels – Blank Space for Custom Messages

### Indoor/Outdoor Sub-Surface Printed Adhesive Polyester (Type PPS)

- High quality signs for use indoors and outdoors
- Excellent resistance to UV light, chemical atmosphere, and abrasion
- Excellent life and adhesion properties
- Printed graphics are protected by clear polyester laminate





### Indoor/Outdoor Rigid Polyethylene (Type PRS)

- Rugged signs for indoors and outdoors
- Abrasion resistant
- Used where adhesives will not work

- Can be used with Panduit Thermal Transfer Desktop Printers and Easy-Mark™ Labeling Software to create your own custom signs
- Print your own legend on clear polyester tape with the TDP43MY Thermal Transfer Desktop Printer and adhere label to adhesive or non-adhesive sign panel
- Can also be used with Panduit Die Cut Letter and Numbers

### Material Chart

Material	Print Method	Temperature Range	Features
Polyester (PPS)	Pre-Printed	-40°F to 275°F (-40°C to 135°C)	Indoor/outdoor rated; laminated label material protects legend from abrasion and chemicals; resistant to UV light, chemical atmosphere, and abrasion; excellent life and adhesion properties.
Rigid Polyethylene (PRS)		-105°F to 250°F (-76°C to 121°C)	Indoor/outdoor rated; high quality, rugged material resistant to abrasion; use where adhesives will not work.

Part Number	Symbol	Header	Width		Height		Std. Pkg. Qty	Std. Ctn. Qty.
			In.	mm	In.	mm		
PPS0710BWHT		BLANK	10.00	254.0	7.00	177.8	1	25
PPS1014BWHT			14.00	355.6	10.00	254.0	1	25
PPS1420BWHT			20.00	508.0	14.00	355.6	1	25
PRS0710BWHT			10.00	254.0	7.00	177.8	1	10
PRS1014BWHT			14.00	355.6	10.00	254.0	1	10
PRS1420BWHT			20.00	508.0	14.00	355.6	1	10
PPS0710BYEL		BLANK	10.00	254.0	7.00	177.8	1	25
PPS1014BYEL			14.00	355.6	10.00	254.0	1	25
PPS1420BYEL			20.00	508.0	14.00	355.6	1	25
PRS0710BYEL			10.00	254.0	7.00	177.8	1	10
PRS1014BYEL			14.00	355.6	10.00	254.0	1	10
PRS1420BYEL			20.00	508.0	14.00	355.6	1	10
PPS0710C442		CAUTION	10.00	254.0	7.00	177.8	1	25
PPS1014C442			14.00	355.6	10.00	254.0	1	25
PPS1420C442			20.00	508.0	14.00	355.6	1	25
PRS0710C442			10.00	254.0	7.00	177.8	1	10
PRS1014C442			14.00	355.6	10.00	254.0	1	10
PRS1420C442			20.00	508.0	14.00	355.6	1	10
PPS0710D440		DANGER	10.00	254.0	7.00	177.8	1	25
PPS1014D440			14.00	355.6	10.00	254.0	1	25
PPS1420D440			20.00	508.0	14.00	355.6	1	25
PRS0710D440			10.00	254.0	7.00	177.8	1	10
PRS1014D440			14.00	355.6	10.00	254.0	1	10
PRS1420D440			20.00	508.0	14.00	355.6	1	10
PPS0710N443		NOTICE	10.00	254.0	7.00	177.8	1	25
PPS1014N443			14.00	355.6	10.00	254.0	1	25
PPS1420N443			20.00	508.0	14.00	355.6	1	25
PRS0710N443			10.00	254.0	7.00	177.8	1	10
PRS1014N443			14.00	355.6	10.00	254.0	1	10
PRS1420N443			20.00	508.0	14.00	355.6	1	10

Order number of Standard Packages required

A. System Overview

## Thermal Transfer Printable Arc Flash Labels

B1. Cable Ties

- Provide employees with the highest degree of safety through proper identification and communication
- Labels are constructed of durable polyester designed to withstand UV exposure, outdoor use, water, abrasion
- Clearly visible and recognizable hazard information to communicate arc flash hazards present
- Custom Arc Flash Hazard Labels can be printed using Panduit labeling software and desktop thermal transfer printers

B2. Cable Accessories



C400X600YX1



C400X600YZ1

B3. Stainless Steel Ties



C400X400A11



C400X400A21

C1. Wiring Duct



C400X400A31



C400X600AX1

C2. Surface Raceway

C3. Abrasion Protection



C400X600AY1



C400X600Y81

C4. Cable Management



T400X000YX1

D1. Terminals

D2. Power Connectors

D3. Grounding Connectors

## Laser Printable Adhesive Signs

- Signs can be printed with a standard laser printer
- Signs are 8.50" x 11.00" (215.90mm x 279.40mm) in size
- Indoor polyolefin pressure sensitive signs with square corners on stay flat liner
- 25 signs per package

E1. Labeling Systems



SEZ-1CLL



SEZ-1DLL

E2. Labels



SEZ-1NLL



SEZ-1WLL

E3. Pre-Printed & Write-On Markers

E4. Permanent Identification



SEZ-1WHLL



SEZ-1YLL

E5. Lockout/Tagout & Safety Solutions

F. Index

Part Number	Part Description	Std. Pkg. Qty.	Std. Ctn. Qty.
-------------	------------------	----------------	----------------

### Custom – Die-Cut

C400X600YX1	4.00" x 6.00" (101.6mm x 152.4mm), polyester arc flash label, orange header, 100 labels per roll.	1	4
C400X600YZ1	4.00" x 6.00" (101.6mm x 152.4mm), polyester arc flash label, red/white danger header, 100 labels per roll.	1	4
C400X400A11	4.00" x 4.00" (101.6mm x 101.6mm), polyester safety label, orange header, green footer, 250 labels per roll.	1	4
C400X400A21	4.00" x 4.00" (101.6mm x 101.6mm), polyester safety label, orange header, yellow footer, 250 labels per roll.	1	4
C400X400A31	4.00" x 4.00" (101.6mm x 101.6mm), polyester safety label, orange header, red footer, 250 labels per roll.	1	4
C400X600AX1	4.00" x 6.00" (101.6mm x 152.4mm), polyester safety label, blue/white NOTICE header, 100 labels per roll.	1	4
C400X600AY1	4.00" x 6.00" (101.6mm x 152.4mm), polyester safety label, green/white SAFETY FIRST header, 100 labels per roll.	1	4
C400X600Y81	4.00" x 6.00" (101.6mm x 152.4mm), polyester safety label, yellow, 100 labels per roll.	1	4
C400X600AZ1	4.00" x 6.00" (101.6mm x 152.4mm), polyester arc flash label, yellow header, 100 labels per roll.	1	4

### Custom – Continuous Tape

T400X000YX1	4.00" x 50.0' (101.6mm x 15.24M), polyester arc flash tape, orange header.	1	4
-------------	--	---	---

Part Number	Legend	Color (Legend/Background)	Width		Height		Signs Per Pkg.	Std. Pkg. Qty.	Std. Ctn. Qty.
			In.	mm	In.	mm			
SEZ-1CLL	CAUTION	Black/Yellow	8.50	216.00	11.00	279.00	25	1	5
SEZ-1DLL	DANGER	Red and Black/White	8.50	216.00	11.00	279.00	25	1	5
SEZ-1NLL	NOTICE	Blue/White	8.50	216.00	11.00	279.00	25	1	5
SEZ-1WLL	WARNING	Black/Orange	8.50	216.00	11.00	279.00	25	1	5
SEZ-1WHLL	BLANK	White	8.50	216.00	11.00	279.00	25	1	5
SEZ-1YLL	BLANK	Yellow	8.50	216.00	11.00	279.00	25	1	5



## Self-Laminating Adhesive Sign Carriers



### Material Chart

Material	Print Method	Temperature Range	Features
Rigid Vinyl	Pre-Printed	-40°F to 150°F (-40°C to 66°C)	Indoor/outdoor rated; rigid material accepts ink; resistant to UV light, chemical atmosphere, and abrasion; excellent for applications where adhesives will not work.

Part Number	Height				Carriers Per Pkg.	Std. Pkg. Qty.	Std. Ctn. Qty.
	In.	mm	In.	mm			

### Adhesive

SEZ-SNC4	7.00	178.0	6.00	152.0	5	1	10
SEZ-SNC3	12.00	305.0	6.00	152.0	5	1	10
SEZ-SNC2	10.50	267.0	7.00	178.0	5	1	10
SEZ-SNC1	12.00	305.0	9.50	241.0	5	1	10

### Non-Adhesive

SEZ-RSC1	7.00	178.0	6.00	152.0	5	1	10
SEZ-RSC2	10.50	267.0	7.00	178.0	5	1	10
SEZ-RSC3	12.00	305.0	9.50	241.0	5	1	10
SEZ-RSC4	12.00	305.0	6.00	152.0	5	1	10

## Self-Laminating Cable Marker Holders for Large Cables or Cable Bundles



### Material Chart

Material	Print Method	Temperature Range	Features
Rigid Vinyl, Self-Laminating	Pre-Printed	0°F to 176°F (-18°C to 80°C)	Indoor/outdoor rated; high quality, rugged material resistant to abrasion; legend is protected by overlamine; use where adhesives will not work.

Part Number	Color	Width		Height		Tags Per Pkg.	Std. Pkg. Qty.	Std. Ctn. Qty.
		In.	mm	In.	mm			
SLCT-IG	Gray	3.00	76.2	1.31	33.3	25	1	4
SLCT-OR	Orange	3.00	76.2	1.31	33.3	25	1	4
SLCT-WH	White	3.00	76.2	1.31	33.3	25	1	4
SLCT-YL	Yellow	3.00	76.2	1.31	33.3	25	1	4
SLCT-3	White	4.00	101.6	0.50	12.7	25	1	4
SLCT-3OR	Orange	4.00	101.6	0.50	12.7	25	1	4
SLCT-3YL	Yellow	4.00	101.6	0.50	12.7	25	1	4

Attach with Panduit Intermediate or Standard Cross-Section Cable Ties.

### Component Labels for Laser/Ink Jet Printers Supplied on 8.5" x 11" Sheets

C200X100YJJ	White, polyester label.	2.00	50.8	1.00	25.4	—	1000	5000
-------------	-------------------------	------	------	------	------	---	------	------

### Component Labels for Thermal Transfer Desktop Printers Supplied on Rolls

C200X100YJT	White, polyester label.	2.00	50.8	1.00	25.4	—	2500	10000
-------------	-------------------------	------	------	------	------	---	------	-------

### Component Cassettes for Panther™ LS8 Hand-Held Thermal Transfer Printer

C200X100YJC	White, polyester label, 200/cassette.	2.00	50.8	1.00	25.4	—	1	10
-------------	---------------------------------------	------	------	------	------	---	---	----

A. System Overview

## Self-Laminating Fiber Optic Cable Marker Tags

B1. Cable Ties

B2. Cable Accessories

B3. Stainless Steel Ties

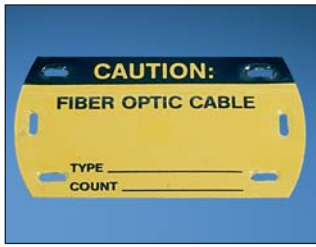

### Material Chart

Material	Print Method	Temperature Range	Features
Rigid Vinyl, Self-Laminating	Pre-Printed	0°F to 176°F (-18°C to 80°C)	Indoor/outdoor rated; high quality, rugged material resistant to abrasion; legend is protected by overlamine; use where adhesives will not work.

C1. Wiring Duct

C2. Surface Raceway

C3. Abrasion Protection

C4. Cable Management

D1. Terminals

D2. Power Connectors

D3. Grounding Connectors

E1. Labeling Systems

E2. Labels

E3. Pre-Printed & Write-On Markers

E4. Permanent Identification

E5. Lockout/Tagout & Safety Solutions

F. Index

Part Number	Legend	Color (Legend/Background)	Width		Height		Tags Per Pkg.	Std. Pkg. Qty.	Std. Ctn. Qty.
			In.	mm	In.	mm			
<b>PST-FO</b>	CAUTION FIBER OPTIC CABLE TYPE _____ COUNT _____	Black/Yellow	3.50	89.00	2.00	51.00	5	1	40
<b>PST-FOBLNK</b>	BLANK	Yellow	3.50	89.00	2.00	51.00	5	1	40

Order number of packages required in multiples of Std. Pkg. Qty.

## Ground Warning Tags



### Material Chart

Material	Print Method	Temperature Range	Features
Rigid Polyethylene	Pre-Printed	-30°F to 250°F (-34°C to 121°C)	Indoor/outdoor rated; high quality, rugged material resistant to abrasion; use where adhesives will not work.

Part Number	Legend	Color (Legend/Background)	Width		Height		Tags Per Pkg.	Std. Pkg. Qty.	Std. Ctn. Qty.
			In.	mm	In.	mm			
<b>PT-BGND</b>	NETWORK BUILDING GROUND	Green/Yellow	2.75	70.00	1.38	35.00	100	1	5
<b>PT-GND</b>	WARNING GROUND WIRE DO NOT REMOVE	Black/Yellow	2.75	70.00	1.38	35.00	100	1	5
<b>PT-TGND</b>	WARNING TELEPHONE CO. REPAIR SERVICE	Black/Yellow	2.75	70.00	1.38	35.00	100	1	5

Attach with Panduit Intermediate or Standard cross section cable ties.

## Panduit Corp. Generic Padlock Order Form

One Form per Generic Padlock Option  
**Fax orders to Panduit Corp., Attn: Customer Service (708) 570-3570**  
**Generic Locks are Non-Returnable**

Date: _____	Panduit Sales Rep: _____
From: _____	Distributor: _____
Telephone #: _____	_____
End User: _____	_____
_____	_____
_____	Distributor Contact: _____
Telephone#/Fax#: _____	Telephone#/Fax#: _____
Account #: _____	Account #: _____

### Generic Padlock Options

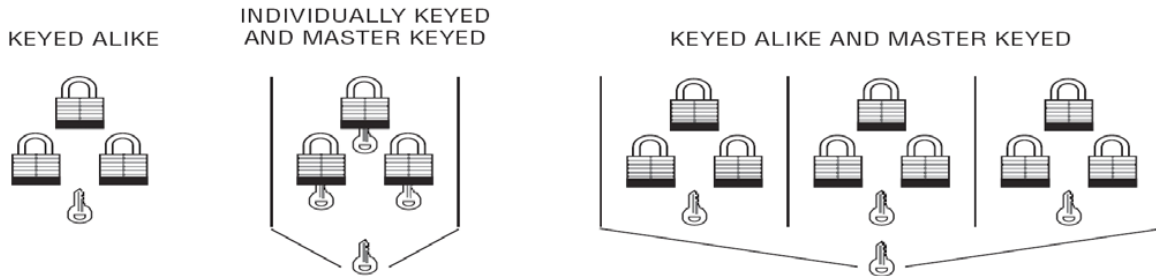

Generic Padlock Part Number	Description	Qty. Min. 12/ Padlock Series	Notes (Colors, Key Numbers, Set Description)
<b>PSL-6 Laminated Steel Padlocks: (Select from red, yellow, blue, black, green, or white bumper colors)</b>			
GPSL-6KA	Keyed Alike Padlock – ¾" Shackle		
GPSL-6LSKA	Keyed Alike Padlock – 2" Shackle		
GPSL-6MK	Master Keyed Padlock – ¾" Shackle		
GPSL-6LSMK	Master Keyed Padlock – 2" Shackle		
GPSL-6KAMK	Keyed Alike and Master Keyed Padlock – ¾" Shackle		
GPSL-6LSKAMK	Keyed Alike and Master Keyed Padlock – 2" Shackle		
GPSL-6MKEY	Master Key for a PSL -6 Master Keyed Padlock		
<b>PSL-7 Coated Aluminum Padlocks: (Select from red, yellow, blue, black, green, or orange body colors)</b>			
GPSL-7KA	Keyed Alike Padlock – 1" Shackle		
GPSL-7LSKA	Keyed Alike Padlock – 3" Shackle		
GPSL-7MK	Master Keyed Padlock – 1" Shackle		
GPSL-7LSMK	Master Keyed Padlock – 3" Shackle		
GPSL-7KAMK	Keyed Alike and Master Keyed Padlock – 1" Shackle		
GPSL-7LSKAMK	Keyed Alike and Master Keyed Padlock – 3" Shackle		
GPSL-7MKEY	Master Key for a PSL -7 Master Keyed Padlock		
<b>PSL-8 Safety Lockout Padlocks: (Select from red, yellow, blue, black, green, or orange body colors)</b>			
GPSL-8KA	Keyed Alike Padlock – 1.5" Shackle		
GPSL-8MK	Master Keyed Padlock – 1.5" Shackle		
GPSL-8KAMK	Keyed Alike and Master Keyed Padlock – 1.5" Shackle		
GPSL-8MKEY	Master Key for a PSL -8 Master Keyed Padlock		

For Pricing and Lead Time Information, Contact Panduit Customer Service at 800-777-3300

A. System Overview

B1. Cable Ties

B2. Cable Accessories

B3. Stainless Steel Ties

C1. Wiring Duct

C2. Surface Raceway

C3. Abrasion Protection

C4. Cable Management

D1. Terminals

D2. Power Connectors

D3. Grounding Connectors

E1. Labeling Systems

E2. Labels

E3. Pre-Printed & Write-On Markers

E4. Permanent Identification

E5. Lockout/Tagout & Safety Solutions

F. Index

## Panduit Corp. Generic PVT Vinyl Tag Order Form

One Form per Generic Tag Option

**Fax orders to Panduit Corp., Attn: Customer Service (708) 570-3570**

**Generic Tags are Non-Returnable**

Date: \_\_\_\_\_ Panduit Sales Rep: \_\_\_\_\_  
 From: \_\_\_\_\_ Distributor: \_\_\_\_\_  
 Telephone #: \_\_\_\_\_  
 End User: \_\_\_\_\_  
 \_\_\_\_\_  
 \_\_\_\_\_  
 Telephone#/Fax#: \_\_\_\_\_ Telephone#/Fax#: \_\_\_\_\_  
 Account #: \_\_\_\_\_ Account #: \_\_\_\_\_

### Select the Generic Vinyl Tag Part Number and Quantity:

Number of Sides Printed	<b>DANGER</b> Black on White	<b>CAUTION</b> Black on Yellow	<b>NOTICE</b> Black on White	"No Header" Black on White	"No Header" Black on Yellow	"No Header" Black on Red	"No Header" Black on Green
1	GPVT-RBW1	GPVT-BY1	GPVT-BBW1	GPVT-W1-1	GPVT-Y1-1	GPVT-R1-1	GPVT-G1-1
2	GPVT-RBW2	GPVT-BY2	GPVT-BBW2	GPVT-W1-2	GPVT-Y1-2	GPVT-R1-2	GPVT-G1-2

Quantity In Packs (min. of 4 packs, 25 tags and ties/pack): \_\_\_\_\_ Part Number: \_\_\_\_\_

Use this space to create a rough sketch of your tag.  
 Please indicate colors and legend. Please print.  
 Attach an additional page or customer sketch if needed.

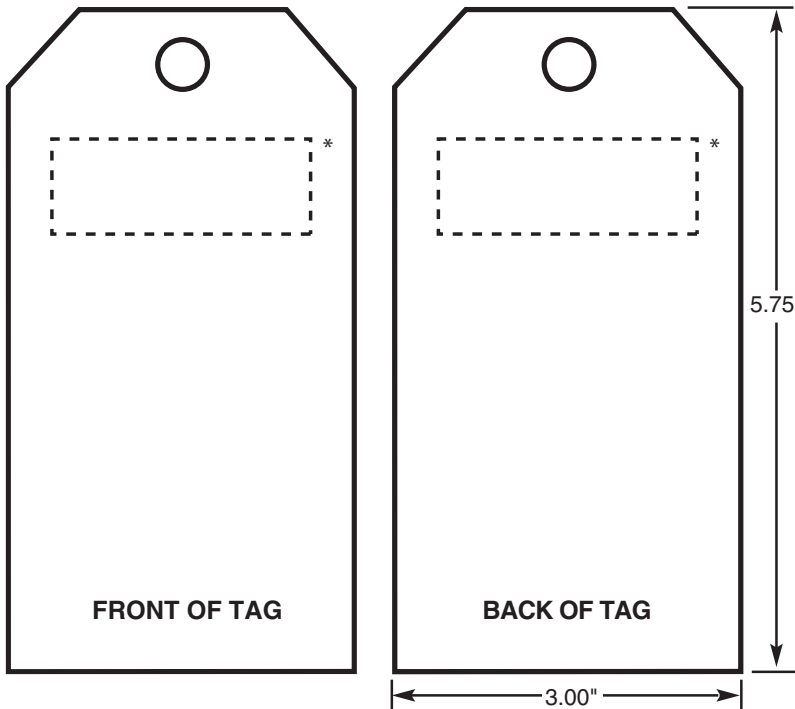

### Check Applicable Order Requirements:

**Pictogram** (type \_\_\_\_\_)  
**Logo Required** (camera ready artwork must accompany the order form)

**Character Height** (legend will be formatted to fit the size of the tag unless otherwise specified)

**Logo Required** \_\_\_\_\_  
 (Panduit reserves the right to assign artwork approval when necessary)

\*Normal position of header. Hole size = .375" with grommet.

One Panduit tie is included per tag.

For Pricing and Lead Time Information, Contact Panduit Customer Service at 800-777-3300





## Panduit Corp. Generic Adhesive PPS Safety Sign Order Form

One Form per Generic Sign Option  
**Fax orders to Panduit Corp., Attn: Customer Service (708) 570-3570**  
**Generic Signs are Non-Returnable**

Date: \_\_\_\_\_ Panduit Sales Rep: \_\_\_\_\_  
 From: \_\_\_\_\_ Distributor: \_\_\_\_\_  
 Telephone #: \_\_\_\_\_  
 End User: \_\_\_\_\_  
 \_\_\_\_\_  
 \_\_\_\_\_  
 Telephone#/Fax#: \_\_\_\_\_ Distributor Contact: \_\_\_\_\_  
 Account #: \_\_\_\_\_ Telephone#/Fax#: \_\_\_\_\_  
 Account #: \_\_\_\_\_

### Generic PPS Sign Options

Select the Generic Polyester Sign Part Number and Quantity

Size	 Black on White	 Black on Yellow	 Black on White	 Black on White	 Black on Orange	"No Header" Black on Orange	"No Header" Black on White	"No Header" Black on Yellow	"No Header" Red on White
3" x 5"	GPPS0305D	GPPS0305C	GPPS0305N	GPPS0305SF	GPPS0305W	GPPS0305B-BO	GPPS0305B-BW	GPPS0305B-BY	GPPS0305B-RW
7" x 10"	GPPS0710D	GPPS0710C	GPPS0710N	GPPS0710SF	GPPS0710W	GPPS0710B-BO	GPPS0710B-BW	GPPS0710B-BY	GPPS0710B-RW
10" x 14"	GPPS1014D	GPPS1014C	GPPS1014N	GPPS1014SF	GPPS1014W	GPPS1014B-BO	GPPS1014B-BW	GPPS1014B-BY	GPPS1014B-RW

Quantity Per Legend Per Size (Minimum of 10): \_\_\_\_\_ Part Number: \_\_\_\_\_

**Print Legend in the Format Required:**  
 Include Logos and/or Pictograms

Check Applicable Order Requirements

\_\_\_\_\_ Pictogram (type \_\_\_\_\_)  
 \_\_\_\_\_ Logo Required (camera ready artwork must accompany order form)  
 \_\_\_\_\_ Character Height (legend will be formatted to fit the size of the sign unless otherwise specified): \_\_\_\_\_

**ARTWORK APPROVAL** (Panduit reserves the right to assign artwork approval when necessary)

Notes: \_\_\_\_\_  
 \_\_\_\_\_  
 \_\_\_\_\_

**For Pricing and Lead Time Information, Contact Panduit Customer Service at 800-777-3300**

A. System Overview

B1. Cable Ties

B2. Cable Accessories

B3. Stainless Steel Ties

C1. Wiring Duct

C2. Surface Raceway

C3. Abrasion Protection

C4. Cable Management

D1. Terminals

D2. Power Connectors

D3. Grounding Connectors

E1. Labeling Systems

E2. Labels

E3. Pre-Printed & Write-On Markers

E4. Permanent Identification

E5. Lockout/Tagout & Safety Solutions

F. Index

A. System Overview

## Panduit Corp. Generic Semi-Rigid PRS Safety Sign Order Form

B1. Cable Ties

One Form per Generic Sign Option  
**Fax orders to Panduit Corp., Attn: Customer Service (708) 570-3570**  
**Generic Signs are Non-Returnable**

B2. Cable Accessories

Date: \_\_\_\_\_ Panduit Sales Rep: \_\_\_\_\_

From: \_\_\_\_\_ Distributor: \_\_\_\_\_

Telephone #: \_\_\_\_\_

B3. Stainless Steel Ties

End User: \_\_\_\_\_

\_\_\_\_\_

Distributor Contact: \_\_\_\_\_

C1. Wiring Duct

Telephone#/Fax#: \_\_\_\_\_ Telephone#/Fax#: \_\_\_\_\_





Account #: \_\_\_\_\_ Account #: \_\_\_\_\_

C2. Surface Raceway

### Generic PRS Sign Options

C3. Abrasion Protection

Select the Generic Semi-Rigid GMPE1 Polyethylene Sign Part Number and Quantity

Size	 Black on White	 Black on Yellow	 Black on White	 Black on White	 Black on Orange	"No Header" Black on Orange	"No Header" Black on White	"No Header" Black on Yellow	"No Header" Red on White
7" x 10"	GPRS0710D	GPRS0710C	GPRS0710N	GPRS0710SF	GPRS0710W	GPRS0710B-BO	GPRS0710B-BW	GPRS0710B-BY	GPRS0710B-RW
10" x 14"	GPRS1014D	GPRS1014C	GPRS1014N	GPRS1014SF	GPRS1014W	GPRS1014B-BO	GPRS1014B-BW	GPRS1014B-BY	GPRS1014B-RW
14" x 20"	GPRS1420D	GPRS1420C	GPRS1420N	GPRS1420SF	GPRS1420W	GPRS1420B-BO	GPRS1420B-BW	GPRS1420B-BY	GPRS1420B-RW

D1. Terminals

Quantity Per Legend Per Size (Minimum of 10): \_\_\_\_\_ Part Number: \_\_\_\_\_

D2. Power Connectors

### Print Legend in the Format Required:

Include Logos and/or Pictograms

D3. Grounding Connectors



Each sign will have (1) .1875" hole in each corner and .375" radius corners.

Check Applicable Order Requirements

E3. Pre-Printed & Write-On Markers

\_\_\_\_\_ Pictogram (type \_\_\_\_\_)

\_\_\_\_\_ Logo Required (camera ready artwork must accompany order form)

\_\_\_\_\_ Character Height (legend will be formatted to fit the size of the sign unless otherwise specified): \_\_\_\_\_

E4. Permanent Identification

**ARTWORK APPROVAL** (Panduit reserves the right to assign artwork approval when necessary)

**Notes:** \_\_\_\_\_

E5. Lockout/Tagout & Safety Solutions

\_\_\_\_\_

\_\_\_\_\_

F. Index

**For Pricing and Lead Time Information, Contact Panduit Customer Service at 800-777-3300**

## Panduit Corp. Generic Conduit and Voltage Marker Order Form

One Form per Generic Marker Option

**Fax orders to Panduit Corp., Attn: Customer Service (708) 570-3570**

**Generic Markers are Non-Returnable**

Date: \_\_\_\_\_

Panduit Sales Rep: \_\_\_\_\_

From: \_\_\_\_\_

Distributor: \_\_\_\_\_

Telephone #: \_\_\_\_\_

End User: \_\_\_\_\_

Distributor Contact: \_\_\_\_\_

Telephone#/Fax#: \_\_\_\_\_

Telephone#/Fax#: \_\_\_\_\_

Account #: \_\_\_\_\_

Account #: \_\_\_\_\_

### Generic Conduit and Voltage Marker Options

#### Pressure Sensitive Adhesive GMV1 Vinyl Conduit and Voltage Markers

#### LEGEND

LEGEND	LEGEND
LEGEND	LEGEND

##### STYLE A

Marker size: 2.25" x 9"  
1 marker per card  
Character height: 1.75"



##### STYLE B

Marker size: 1.125" x 4.5"  
1 marker per card  
Character height: .75"

##### STYLE C

Marker size: .50" x 2.25" – 18 marker per card  
Character height: .3125"

**Minimum Order Quantity:** 10 cards per legend per size and in multiples of 5 cards

Part Desired ✓	Quantity of Cards	Part Number	Legend Color	Backgrnd Color	Style	Markers/ Card
		GPCV-AOY	BLACK	ORANGE	A	1
		GPCV-BOY	BLACK	ORANGE	B	4
		GPCV-COY	BLACK	ORANGE	C	18
		GPCV-AYY	BLACK	YELLOW	A	1
		GPCV-BYY	BLACK	YELLOW	B	4
		GPCV-CYY	BLACK	YELLOW	C	18



Print Legend Required

Legend to fit on one line. Max. 17 characters including spaces.

\*Note: In Style B and C, if you want several different legends on a card, draw the lines to signify label division on the legend area. Write in the different legends needed.

#### Semi-Rigid Snap-On GMPET Polyester Conduit and Voltage Markers



- Protected graphics
- Six reversible legends per marker
- Character height: Size M – .50"  
Size R – .75"

**Minimum Order Quantity:** 10 markers per legend per size

Part Desired ✓	Quantity of Markers	Part Number	Legend Color	Backgrnd Color	Style	Length of Marker	Conduit O.D. Range (In.)
		GPCV-ROY	BLACK	ORANGE	R	8"	.75" - 2.25"
		GPCV-MOY	BLACK	ORANGE	M	14"	2.50" - 6.00"
		GPCV-RYY	BLACK	YELLOW	R	8"	.75" - 2.25"
		GPCV-MYY	BLACK	YELLOW	M	14"	2.50" - 6.00"



Print Legend Required

Legend to fit on one line. Max. 19 characters including spaces.

**For Pricing and Lead Time Information, Contact Panduit Customer Service at 800-777-3300**

A. System Overview

B1. Cable Ties

B2. Cable Accessories

B3. Stainless Steel Ties

C1. Wiring Duct

C2. Surface Raceway

C3. Abrasion Protection

C4. Cable Management

D1. Terminals

D2. Power Connectors

D3. Grounding Connectors

E1. Labeling Systems

E2. Labels

E3. Pre-Printed & Write-On Markers

E4. Permanent Identification

E5. Lockout/Tagout & Safety Solutions

F. Index

A. System Overview

B1. Cable Ties

B2. Cable Accessories

B3. Stainless Steel Ties

C1. Wiring Duct

C2. Surface Raceway

C3. Abrasion Protection

C4. Cable Management

D1. Terminals

D2. Power Connectors

D3. Grounding Connectors

E1. Labeling Systems

E2. Labels

E3. Pre-Printed & Write-On Markers

E4. Permanent Identification

E5. Lockout/Tagout & Safety Solutions

F. Index

## Panduit Corp. Generic Utility Tapes Order Form

One Form per Generic Utility Tape Option  
**Fax orders to Panduit Corp., Attn: Customer Service (708) 570-3570**  
Generic Utility Tapes are Non-Returnable

Date: \_\_\_\_\_ Panduit Sales Rep: \_\_\_\_\_  
 From: \_\_\_\_\_ Distributor: \_\_\_\_\_  
 Telephone #: \_\_\_\_\_  
 End User: \_\_\_\_\_  
 \_\_\_\_\_  
 \_\_\_\_\_  
 \_\_\_\_\_  
 Telephone#/Fax#: \_\_\_\_\_ Distributor Contact: \_\_\_\_\_  
 Account #: \_\_\_\_\_ Telephone#/Fax#: \_\_\_\_\_  
 Account #: \_\_\_\_\_

### Generic Utility Tape Options

Part Number	Material	Width	Length	Use	Min. Order Qty.	Order Increments
GHTB3	Polyethylene	3.0" (76mm)	1,000' (305m)	Barricade	64	16
GHTU3	Polyethylene	3.0" (76mm)	1,000' (305m)	Underground	64	16
GHTU6	Polyethylene	6.0" (152mm)	1,000' (305m)	Underground	32	8
GHTDU3	Polyethylene Encased Aluminum	3.0" (76mm)	1,000' (305m)	Underground Detectable	32	16
GHTDU6	Polyethylene Encased Aluminum	6.0" (152mm)	1,000' (305m)	Underground Detectable	16	8

**ALL LEGENDS ARE BLACK      MAXIMUM OF TWO LINES OF TEXT      ROLLS ARE ON 3 INCH CORE**

Part Number: \_\_\_\_\_ Quantity: \_\_\_\_\_

Color: \_\_\_\_\_ (select from Blue, Green, Orange, Red, or Yellow)

Sketch Legend and/or Artwork Below:

Comments: \_\_\_\_\_  
 \_\_\_\_\_  
 \_\_\_\_\_

**For Pricing and Lead Time Information, Contact Panduit Customer Service at 800-777-3300**



## Panduit Corp. Generic Custom Engraved Marker Plate Order Form

One Form per Custom Engraved Marker Plate Option  
**Fax orders to Panduit Corp., Attn: Customer Service (708) 570-3570**  
**Custom Engraved Marker Plates are Non-Returnable**

Date: \_\_\_\_\_ Panduit Sales Rep: \_\_\_\_\_  
 From: \_\_\_\_\_ Distributor: \_\_\_\_\_  
 Telephone #: \_\_\_\_\_  
 End-User: \_\_\_\_\_  
 \_\_\_\_\_  
 \_\_\_\_\_  
 Telephone #: \_\_\_\_\_ Distributor Contact: \_\_\_\_\_  
 Telephone # / Fax #: \_\_\_\_\_  
 Account #: \_\_\_\_\_ Account #: \_\_\_\_\_

### Generic Custom Engraved Marker Plate Options

**1 – Material:**

1/16" Thick Acrylic

**2 – Select Mounting Method (Check One):**

- With Adhesive
- Screw Mounting Holes
- No Mounting Method

**3 – Select Color (Check One):**

- Black Text on White Marker Plate
- Black Text on Yellow Marker Plate
- White Text on Black Marker Plate
- White Text on Blue Marker Plate
- White Text on Green Marker Plate
- White Text on Red Marker Plate

**4 – Select Size (Check One):**

- 2.0" Wide x 1.0" High
- 3.0" Wide x 1.0" High
- 3.0" Wide x 2.5" High
- 4.0" Wide x 1.0" High
- 6.0" Wide x 3.0" High
- 8.5" Wide x 11.0" High

**5 – Print Custom Legend Below (3 Lines x 30 Characters Maximum):**

**6 – Specify Part Number:** \_\_\_\_\_  
 (See Table Below)

**7 – Specify Order Quantity:** \_\_\_\_\_

Material	2.0" x 1.0"	3.0" x 1.0"	3.0" x 2.5"	4.0" x 1.0"	6.0" X 3.0"	8.5" X 11.0"
ACRYLIC WITH ADHESIVE	GAP2010-A	GAP3010-A	GAP3025-A	GAP4010-A	GAP6030-A	GAP85110-A
ACRYLIC WITHOUT ADHESIVE	GAP2010	GAP3010	GAP3025	GAP4010	GAP6030	GAP85110

**Comments:** \_\_\_\_\_

**For Pricing and Lead Time Information, Contact Customer Service at 800-777-3300**

A. System Overview

B1. Cable Ties

B2. Cable Accessories

B3. Stainless Steel Ties

C1. Wiring Duct

C2. Surface Raceway

C3. Abrasion Protection

C4. Cable Management

D1. Terminals

D2. Power Connectors

D3. Grounding Connectors

E1. Labeling Systems

E2. Labels

E3. Pre-Printed & Write-On Markers

E4. Permanent Identification

E5. Lockout/Tagout & Safety Solutions

F. Index

A. System Overview

## Wire Size Selection Guide

B1. Cable Ties

To use this guide place your wire or cable in the appropriate circle to determine wire, outside diameter.

The charts below indicate the approximate cable outside diameter or various electrical and communication cables.

B2. Cable Accessories

Diameter .10" (2.50mm)

Diameter .20" (5.10mm)

B3. Stainless Steel Ties

Diameter .28" (7.10mm)

C1. Wiring Duct

Diameter .54" (13.70mm)

C2. Surface Raceway

Diameter .94" (23.90mm)

C3. Abrasion Protection

C4. Cable Management

D1. Terminals

Diameter 1.40" (35.50mm)

D2. Power Connectors

D3. Grounding Connectors

E1. Labeling Systems

Diameter 1.90" (48.30mm)

E2. Labels

E3. Pre-Printed & Write-On Markers

E4. Permanent Identification

E5. Lockout/Tagout & Safety Solutions

F. Index

Diameter 2.40" (61.00mm)

### Electrical Cables

Size	Approximate Wire Outside Diameter In. (mm)			
	TF	THW	TW	TFN/THHN/THWN
18 AWG	.11 (2.80)	.11 (2.80)	.11 (2.80)	.09 (2.30)
16 AWG	.12 (3.00)	.12 (3.00)	.12 (3.00)	.10 (2.50)
14 AWG	.13 (3.30)	.16 (4.10)	.16 (4.10)	.10 (2.50)
12 AWG	.15 (3.80)	.18 (4.60)	.18 (4.60)	.12 (3.00)
10 AWG	.17 (4.30)	.20 (5.10)	.20 (5.10)	.15 (3.80)
8 AWG	.24 (6.10)	.28 (7.10)	.28 (7.10)	.22 (5.60)
6 AWG	.32 (8.10)	.32 (8.10)	.32 (8.10)	.26 (6.60)
4 AWG	.37 (9.40)	.37 (9.40)	.37 (9.40)	.33 (8.40)
3 AWG	.40 (10.20)	.40 (10.20)	.40 (10.20)	.36 (9.10)
2 AWG	.43 (10.90)	.43 (10.90)	.43 (10.90)	.39 (9.90)
1AWG	.51 (12.90)	.51 (12.90)	.51 (12.90)	.45 (11.40)
1/0	.55 (14.00)	.55 (14.00)	.55 (14.00)	.49 (12.40)
2/0	.59 (15.00)	.59 (15.00)	.59 (15.00)	.54 (13.70)
3/0	.65 (16.50)	.65 (16.50)	.65 (16.50)	.59 (15.00)
4/0	.70 (17.80)	.70 (17.80)	.70 (17.80)	.65 (16.50)
250 MCM	.79 (20.10)	.79 (20.10)	.79 (20.10)	.72 (18.30)
300 MCM	.84 (21.30)	.84 (21.30)	.84 (21.30)	.77 (19.60)
350 MCM	.89 (22.60)	.89 (22.60)	.89 (22.60)	.82 (20.80)
400 MCM	.94 (23.90)	.94 (23.90)	.94 (23.90)	.87 (22.10)
500 MCM	1.03 (26.20)	1.03 (26.20)	1.03 (26.20)	.95 (24.10)
600 MCM	1.14 (29.00)	1.14 (29.00)	1.14 (29.00)	1.06 (26.90)
700 MCM	1.21 (30.70)	1.21 (30.70)	1.21 (30.70)	1.13 (28.70)
750 MCM	1.25 (31.80)	1.25 (31.80)	1.25 (31.80)	1.16 (29.50)
800 MCM	1.28 (32.50)	1.28 (32.50)	1.28 (32.50)	1.20 (30.50)
900 MCM	1.34 (34.00)	1.34 (34.00)	1.34 (34.00)	1.26 (32.00)
1000 MCM	1.40 (35.60)	1.40 (35.60)	1.40 (35.60)	1.32 (33.50)
1250 MCM	1.58 (40.10)	1.58 (40.10)	1.58 (40.10)	
1500 MCM	1.70 (43.20)	1.70 (43.20)	1.70 (43.20)	
1750 MCM	1.82 (46.20)	1.82 (46.20)	1.82 (46.20)	
2000 MCM	1.92 (48.80)	1.92 (48.80)	1.92 (48.80)	

### Category 3, Category 5/5e/6 and 6a Cable

Size	Category 3		Category 5/5e/6		
	Voice Grade 24 AWG UTP	Data Grade 24 AWG UTP	Data Grade 24 AWG STP	Data Grade 22 AWG UTP	Data Grade 22 AWG STP
2-Pair	.12 (3.00)				
3-Pair	.15 (3.80)				
4-Pair	.19 (4.80)	.22 (5.60)	.25 (6.30)	.23 (5.80)	.29 (7.40)
25-Pair		.42 (10.70)	.51 (12.90)	.54 (13.70)	.63 (16.00)
50-Pair	.46 (11.70)	.66 (16.80)			
100-Pair	.63 (16.00)	.96 (24.40)			
300-Pair	1.07 (27.20)				





### Coaxial Cable

Size	Coax
RG58/u	.19 (4.80)
RG59/u	.24 (6.10)
RG62A/u	.24 (6.10)
RG6/u	.27 (6.80)
RG11/u	.40 (10.20)

### Fiber Optic Distribution (62.5/125)

Size	Non-Plenum	Plenum
6 Strand	.26 (6.60)	.18 (4.60)
8 Strand	.27 (6.90)	.18 (4.60)
12 Strand	.28 (7.10)	.21 (5.30)
18 Strand	.49 (12.4)	.47 (11.90)
24 Strand	.54 (13.70)	.52 (13.2)
36 Strand	.54 (13.70)	.52 (13.2)
48 Strand	.59 (15.00)	.56 (14.2)
72 Strand	.72 (18.30)	.71 (18.0)

## Selection Guide by Wire/Cable Size

Label Type	Width In.	Wire/Cable Size																						
		22 AWG	20 AWG	18 AWG	16 AWG	14 AWG	12 AWG	10 AWG	Cat. 5/5e/6	8 AWG	6 AWG	4 AWG	2 AWG	1 AWG	1/0 AWG	2/0 AWG	3/0 AWG	4/0 AWG	250 MCM	500 MCM				
	Self-Laminating	.50			S050X075*			S050X125*			S050X150*													
		1.00			S100X075*			S100X125*			S100X150*		S100X225*		S100X400*									
		2.00									S200X225*			S200X400*				S100X650*						
	Non-Laminated	.25			N025X075*			N025X125*			N025X150*		N025X175*											
		.50			N050X075*			N050X125*			N050X150*		N050X175*											
		1.00			N100X075*			N100X125*			N100X150*		N100X175*											
	Flag Style	.25			N025X150*			N025X175*																
		.50			N050X150*			N050X175*																
		1.00			N100X150*			N100X175*																
	Heat Shrink	.50			H050X025*			H050X034*			H050X044*		H050X064*		H050X084*									
		.75			H075X025*			H075X034*			H075X044*													
		1.00			H050X025*			H050X034*			H050X044*		H050X064*		H050X084*									
		1.50			H150X025*			H150X034*			H150X044*							H100X165*						
		1.75			H175X025*			H175X034*			H175X044*													
		2.00			H200X025*			H200X034*			H200X044*		H200X064*		H200X084*									

\*Represents material type, color, and print method.

A. System Overview

B1. Cable Ties

B2. Cable Accessories

B3. Stainless Steel Ties

C1. Wiring Duct

C2. Surface Raceway

C3. Abrasion Protection

C4. Cable Management

D1. Terminals

D2. Power Connectors

D3. Grounding Connectors

E1. Labeling Systems

E2. Labels

E3. Pre-Printed & Write-On Markers

E4. Permanent Identification

E5. Lockout/Tagout & Safety Solutions

F. Index

A.  
System  
Overview

B1.  
Cable Ties

B2.  
Cable  
Accessories

B3.  
Stainless  
Steel Ties

C1.  
Wiring  
Duct

C2.  
Surface  
Raceway

C3.  
Abrasion  
Protection

C4.  
Cable  
Management

D1.  
Terminals

D2.  
Power  
Connectors

D3.  
Grounding  
Connectors

E1.  
Labeling  
Systems

E2.  
Labels

E3.  
Pre-Printed  
& Write-On  
Markers

E4.  
Permanent  
Identification

E5.  
Lockout/  
Tagout  
& Safety  
Solutions

F.  
Index

## NOTES

Part Number	Page Number
<b>A</b>	
A1C12-A-C8	B2.32
A1C25-A-C8	B2.32
A1C38-A-C8	B2.32
A1C50-A-C8	B2.32
A2C12-A-C8	B2.33
A2C25-A-C8	B2.33
A2C38-A-C8	B2.33
A2C50-A-C8	B2.33
ABM100-A-C	B2.4
ABM100-A-C15	B2.4
ABM100-AT-C	B2.4
ABM100-AT-C0	B2.4
ABM100-S6-C	B2.5
ABM100-S6-C69	B2.5
ABM112-A-C	B2.4
ABM112-AT-C	B2.4
ABM112-AT-C0	B2.4
ABM112-S6-C	B2.5
ABM112-S6-C69	B2.5
ABM1M-A-C	B2.4
ABM1M-AT-C	B2.4
ABM2S-A-C	B2.4
ABM2S-A-C14	B2.4
ABM2S-A-C15	B2.4
ABM2S-AT-C	B2.4
ABM2S-AT-C0	B2.4
ABM2S-S6-D	B2.5
ABM3H-A-L	B2.4
ABM3H-AT-L	B2.4
ABM3H-S6-T	B2.5
ABM4H-A-L	B2.4
ABM4H-AT-L	B2.4
ABM4H-S6-T	B2.5
ABMM-A-C	B2.4
ABMM-AT-C	B2.4
ABMM-AT-C0	B2.4
ABMM-D	B2.5
ABMQS-A-Q	B2.6
ABMQS-A-Q20	B2.6
ABMQS-AT-Q	B2.6
ABMQS-AT-Q0	B2.6
ABMQS-S6-C	B2.6
ABMQS-S6-C0	B2.6
ABMT-A-C	B2.6, C4.13
ABMT-A-C20	B2.6, C4.13
ABMT-S6-C	B2.6, C4.13
ABMT-S6-C20	B2.6, C4.13
ABMT-S6-C60	B2.6, C4.13
ABMT-S6-C69	B2.6, C4.13
ACC19-A-C	B2.31
ACC19-A-C20	B2.31
ACC19-AT-C	B2.31
ACC19-AT-C0	B2.31
ACC19-AV-M300	B2.31
ACC38-A-C	B2.31
ACC38-A-C20	B2.31
ACC38-AT-C	B2.31
ACC38-AT-C0	B2.31
ACC38-AV-M300	B2.31
ACC62-A-C	B2.31
ACC62-A-C20	B2.31
ACC62-AT-C	B2.31
ACC62-AT-C0	B2.31
ACC62-AV-D300	B2.31
ADCC31-AT-C10	B2.36
AJC12-A-C	B2.32
AJC19-A-C	B2.32
AJC25-A-C	B2.32
AJC31-A-C	B2.32
AJC38-A-C	B2.32
AM2-C	B2.10
AMC25-AT-C10	B2.36
ARC.68-A-Q	B2.30
ARC.68-A-Q14	B2.30
ARC.68-S6-Q	B2.30

Part Number	Page Number
ARC.68-S6-Q14	B2.30
ASMS-A-X	B2.9
AST10-5-C100	B2.28
AST15-5-C100	B2.28
AST20-5-C100	B2.28
AST25-5-C100	B2.28
<b>ATMB</b>	<b>B2.52</b>
<b>ATMC</b>	<b>B2.52</b>
<b>ATMI-W187-X</b>	<b>B2.52</b>
<b>ATMI-W250-X</b>	<b>B2.52</b>
<b>ATMI-XMR-X</b>	<b>B2.52</b>
<b>ATM-W187-M</b>	<b>B2.52</b>
<b>ATMI-W250-X</b>	<b>B2.52</b>
<b>ATMI-XMR-X</b>	<b>B2.52</b>
<b>ATM-W187-M</b>	<b>B2.52</b>
<b>ATM-W187-M20</b>	<b>B2.52</b>
<b>ATM-W187-M30</b>	<b>B2.52</b>
<b>ATM-W250-M</b>	<b>B2.52</b>
<b>ATM-W250-M20</b>	<b>B2.52</b>
<b>ATM-W250-M30</b>	<b>B2.52</b>
<b>B</b>	
B2M2S-D	B1.52
B2M2S-D0	B1.52
B3M2S-TL	B1.52
B3M2S-TL0	B1.52
B4M2S-TL	B1.52
B4M2S-TL0	B1.52
BC1.5I-S8-M	B1.48
BC1.5I-S8-M0	B1.49
BC1M-S4-M	B1.48
BC1M-S4-M0	B1.49
BC2M-S4-M	B1.48
BC2M-S4-M0	B1.49
BC2S-S10-C	B1.48
BC2S-S10-C0	B1.49
BC3S-S10-D	B1.48
BC3S-S10-D0	B1.49
BC4LH-S25-L	B1.48
BC4LH-S25-L0	B1.49
BC4S-S10-C	B1.48
BC4S-S10-C0	B1.49
BC4S-S10-D30	B1.49
BEC38-A-L	B2.35
BEC38-A-L20	B2.35
BEC38-AT-L0	B2.35
BEC62-A-L	B2.35
BEC62-A-L20	B2.35
BEC62-AT-L0	B2.35
BEC75-A-L	B2.35
BEC75-A-L20	B2.35
BEC75-AT-L0	B2.35
BECP38H25-L	B2.35
BECP38H25-L20	B2.35
BECP75H25-L	B2.35
BECP75H25-L20	B2.35
BF1M-C	B1.52
BF1M-M0	B1.52
BF2M-C	B1.52
BF2M-M0	B1.52
BM1M-C	B1.52
BM1M-M0	B1.52
BM2M-C	B1.52
BM2M-M0	B1.52
BM2S-C	B1.52
BM2S-D0	B1.52
BM4S-C	B1.52
BM4S-D0	B1.52
BP2S-D0	B1.52
BPC1-X	D2.117
BPC1/0-X	D2.117
BPC2-L	D2.117
BPC2/0-X	D2.117
BPC250-X	D2.117
BPC3/0-X	D2.117
BPC300-X	D2.117

Part Number	Page Number
BPC350-X	D2.117
BPC4-L	D2.117
BPC4/0-X	D2.117
BPC400-X	D2.117
BPC500-X	D2.117
BPC6-L	D2.117
BPC600-6	D2.117
BPC750-6	D2.117
BR-.50	C4.9
BR-.50-10-24	C4.9
BR-.75	C4.9
BR-1.25	C4.9
BR-1.25-1/4-20	C4.9
BR-1.25-10-24	C4.9
BR-1.25-14WS	C4.9
BR-1.5-PAF	C4.9
BR-1.5-SN	C4.9
BR-1.5-TW	C4.9
BR-2.0	C4.9
BR-2.0-1/4-20	C4.9
BR-2.0-10-24	C4.9
BR-2.0-14WS	C4.9
BR-2.0-PAF	C4.9
BR-2.0-SN	C4.9
BR-2.0-TW	C4.9
BR-4.0-1/4-20	C4.9
BR.5-E6-C	B2.48
BR.75-E6-C	B2.48
BR2-1.3-A-X	B2.48
BR2-1.3-X	B2.48
BR2-1.5-X	B2.48
BR2-4-X	B2.48
BR2-6-X	B2.48
BR-MPCL	C4.9
<b>BS10-L</b>	<b>D1.66</b>
<b>BS100445</b>	<b>D3.30</b>
<b>BS100445U</b>	<b>D3.30</b>
<b>BS100645</b>	<b>D3.30</b>
<b>BS100645U</b>	<b>D3.30</b>
<b>BS100845</b>	<b>D3.30</b>
<b>BS100845U</b>	<b>D3.30</b>
<b>BS101245</b>	<b>D3.30</b>
<b>BS101245U</b>	<b>D3.30</b>
<b>BS14-C</b>	<b>D1.66</b>
BS18-C	D1.66
<b>BS201246EU</b>	<b>D3.30</b>
<b>BS201846EU</b>	<b>D3.30</b>
<b>BS202446EU</b>	<b>D3.30</b>
BS22-C	D1.66
BSH10-E	D1.68
BSH14-Q	D1.68
BSH18-Q	D1.68
BSM1-C	D1.69
BSM2-C	D1.69
BSM6-L	D1.69
BSMN1-3K	D1.139
BSMN2-3K	D1.139
BSMN6-2K	D1.139
BSMP1-3K	D1.139
BSMP2-3K	D1.139
BSMV1BX-LY	D1.68
BSMV2BX-L	D1.68
BSMV6X-Q	D1.68
BSN10-2K	D1.130
BSN10-L	D1.65
BSN14-3K	D1.130
BSN14-C	D1.65
BSN18-3K	D1.130
BSN18-C	D1.65
BSN22-C	D1.65
BSP14-3K	D1.130
BSP18-3K	D1.130
BSV10X-Q	D1.65
BSV14X-L	D1.65
BSV18X-LY	D1.65
BT1.5I-C	B1.45
BT1.5I-C0	B1.46

A. System Overview
B1. Cable Ties
B2. Cable Accessories
B3. Stainless Steel Ties
C1. Wiring Duct
C2. Surface Raceway
C3. Abrasion Protection
C4. Cable Management
D1. Terminals
D2. Power Connectors
D3. Grounding Connectors
E1. Labeling Systems
E2. Labels
E3. Pre-Printed & Write-On Markers
E4. Permanent Identification
E5. Lockout/Tagout & Safety Solutions
F. Index

A. System Overview	Part Number	Page Number	Part Number	Page Number	Part Number	Page Number
B1. Cable Ties	BT1.5I-M30	B1.47	C038X038KCT	E2.17	C120X190YK-22	E2.19
	BT1.5I-M39	B1.47	C038X038YJJ	E2.6	C125X025KBT	E2.17
	BT1.5M-C	B1.45	C038X038YJT	E2.17	C125X025KCT	E2.17
B2. Cable Accessories	BT1.5M-C0	B1.46	C038X038YLJ	E2.6	C125X038YJT	E2.18
	BT1.5M-M30	B1.47	C050X013KBT	E2.17	C150X025KBT	E2.18
	BT1.5M-XMR0	B1.116, B1.120	C050X013KCT	E2.17	C150X025KCT	E2.18
	BT1.5M-XMR30	B1.116, B1.120	C050X020KBT	E2.17	C150X050YJJ	E2.6
	BT1M-C	B1.45	C050X044CBT	E2.17	C150X050YJT	E2.18
B3. Stainless Steel Ties	BT1M-C0	B1.46	C050X044KBT	E2.17	C150X075CBT	E2.18
	BT1M-C30	B1.47	C050X044KCT	E2.17	C150X075YJC	E1.10
	BT1M-M39	B1.47	C050X044YJJ	E2.6	C150X075YJJ	E2.6
	BT1M-XMR	B1.55, B1.116, B1.120	C050X044YJT	E2.17	C150X075YJT	E2.18
	BT1M-XMR0	B1.116, B1.120	C060X020CBT	E2.17	C150X075YMT	E2.18
C1. Wiring Duct	BT1M-XMR30	B1.116, B1.120	C060X020KBT	E2.17	C160X020CBT	E2.18
	BT2HT	B3.26	C060X020KCT	E2.17	C160X020KBT	E2.18
	BT2I-C	B1.45	C060X020TJT	E2.16	C160X020KCT	E2.18
	BT2I-C0	B1.46	C060X020YJC	E1.10	C160X020YJJ	E2.6
	BT2I-M30	B1.47	C060X020YJJ	E2.6	C160X020YJT	E2.18
C2. Surface Raceway	BT2LH-L	B1.45	C060X020YJT	E2.17	C180X180AOT-30	E2.20
	BT2LH-L0	B1.46	C065X019KBT	E2.17	C180X180A8T-30	E2.20
	BT2M-C	B1.45	C065X019KCT	E2.17	C180X180APT-30	E2.20
	BT2M-C0	B1.46	C075X025AAT	E2.19	C180X180AST-30	E2.20
	BT2M-M30	B1.47	C075X025CBT	E2.17	C180X180AWT-30	E2.20
C3. Abrasion Protection	BT2S-C	B1.45	C075X025KBT	E2.17	C180X180YK-30	E2.20
	BT2S-C0	B1.46	C075X025KCT	E2.17	C1LG6	C1.13, C1.15, C1.17, C1.21
	BT2S-M30	B1.47	C075X025YJJ	E2.6	C2.5LG6	C1.13, C1.15, C1.17
	BT2S-M39	B1.47	C075X025YJT	E2.17	C200X025KBT	E2.18
	BT3I-C	B1.45	C075X025YLJ	E2.6	C200X025KCT	E2.18
C4. Cable Management	BT3I-C0	B1.46	C080X020KBT	E2.17	C200X025YJT	E2.18
	BT3I-M30	B1.47	C080X020KCT	E2.17	C200X038KBT	E2.18
	BT3LH-L	B1.45	C080X020YJJ	E2.6	C200X038YJT	E2.18
	BT3LH-L0	B1.46	C080X020YJT	E2.17	C200X050CBC	E1.10
	BT3S-C	B1.45	C090X025KBT	E2.17	C200X050CBT	E2.18
D1. Terminals	BT3S-C0	B1.46	C090X025KCT	E2.17	C200X050YJC	E1.10
	BT3S-M30	B1.47	C090X025YJT	E2.17	C200X050YJJ	E2.6
	BT3S-M39	B1.47	C1.5LG6	C1.13, C1.15, C1.17, C1.21	C200X050YJT	E2.18
	BT4I-C	B1.45	C100IG2	C1.19	C200X100AOT	E2.20
	BT4I-C0	B1.46	C100X019KBT	E2.17	C200X100A8T	E2.20
D2. Power Connectors	BT4LH-L	B1.45	C100X019KCT	E2.17	C200X100AAT	E2.19
	BT4LH-L0	B1.46	C100X025CBT	E2.17	C200X100AMT	E2.20
	BT4LH-TL30	B1.47	C100X025KBT	E2.17	C200X100APT	E2.20
	BT4LH-TL39	B1.47	C100X025KCT	E2.17	C200X100AST	E2.20
	BT4M-C	B1.45	C100X025YJC	E1.10	C200X100AWT	E2.20
D3. Grounding Connectors	BT4M-C0	B1.46	C100X025YJJ	E2.6	C200X100FJJ	E2.6
	BT4S-C	B1.45	C100X025YJT	E2.17	C200X100YJC	E1.10, E5.41
	BT4S-C0	B1.46	C100X038CBT	E2.17	C200X100YJJ	E2.6, E5.41
	BT4S-M30	B1.47	C100X038KBT	E2.17	C200X100YJT	E2.18, E5.41
	BT4S-M39	B1.47	C100X038KCT	E2.17	C200X100YK	E2.20
E1. Labeling Systems	BT5LH-L	B1.45	C100X038YJJ	E2.6	C200X100YKT	E2.18
	BT5LH-L0	B1.46	C100X038YJT	E2.17	C200X100YLJ	E2.5
	BT6LH-L	B1.45	C100X050AOT	E2.20	C200X100YMC	E1.10
	BT6LH-L0	B1.46	C100X050A8T	E2.20	C200X100YMT	E2.18
	<b>BT75SDT</b>	<b>B3.26</b>	C100X050AAT	E2.19	C200X100YPC	E1.10
E2. Labels	BT7LH-L	B1.45	C100X050AMT	E2.20	C225X450FJJ	E2.6
	BT7LH-L0	B1.46	C100X050APT	E2.20	C240X240AOT-30	E2.20
	BT8LH-L	B1.45	C100X050AST	E2.20	C240X240A8T-30	E2.20
	BT8LH-L0	B1.46	C100X050AWT	E2.20	C240X240APT-30	E2.20
	BT9LH-L	B1.45	C100X050CBC	E1.10	C240X240AST-30	E2.20
E3. Pre-Printed & Write-On Markers	BT9LH-L0	B1.46	C100X050CBT	E2.17	C240X240AWT-30	E2.20
	BW1.5I-D	B1.50	C100X050YJC	E1.10	C240X240YK-30	E2.20
	BW2S-D	B1.50	C100X050YJJ	E2.6	C25IG2	C1.19
	BW2S-D0	B1.50	C100X050YJT	E2.17	C275X125AAT	E2.19
	BW3S-D	B1.50	C100X050YLJ	E2.6	C275X125YJJ	E2.6
E4. Permanent Identification	BW3S-D0	B1.50	C100X050YMC	E1.10	C275X125YJT	E2.18
			C100X075YJJ	E2.6	C275X125YMT	E2.18
			C100X150YJJ	E2.6	C2LG6	C1.9, C1.13, C1.15, C1.17, C1.21
			C120X150AOT-22	E2.19	C2WH6	C1.9
			C120X150A8T-22	E2.19	C2YL6	C1.56
E5. Lockout/Tagout & Safety Solutions	C.5LG6	C1.13, C1.15, C1.21	C120X150APT-22	E2.19	C300X025KBT	E2.18
	C.75LG6	C1.13, C1.15, C1.21	C120X150AST-22	E2.19	C300X025KCT	E2.18
	C-2001	D3.51	C120X150AWT-22	E2.19	C300X025YJT	E2.18
	C-720	D1.87, D3.37	C120X150YK-22	E2.19	C300X038YJJ	E2.6
	C2YL6	C1.56	C120X190AOT-22	E2.19	C300X038YJT	E2.18
F. Index	C4YL6	C1.56	C120X190A8T-22	E2.19	C300X100AOT	E2.20
	C025X025KBT	E2.17	C120X190A8T-22	E2.19	C300X100A8T	E2.20
	C025X025KCT	E2.17	C120X190APT-22	E2.19	C300X100APT	E2.20
	C025X025YJT	E2.17	C120X190AST-22	E2.19	C300X100YJT	E2.20
	C038X038KBT	E2.17	C120X190AWT-22	E2.19		

# PANDUIT® ELECTRICAL SOLUTIONS

Part Number	Page Number
C300X100YJT	E2.18
C300X100YMT	E2.18
C300X200YJT	E2.18
C300X200YMT	E2.18
C300X250A0T	E2.20
C300X250A8T	E2.20
C300X250AMT	E2.20
C300X250APT	E2.20
C300X250AST	E2.20
C300X250AWT	E2.20
C300X250YK	E2.20
C350X100YJJ	E2.6
C350X500FJJ	E2.6
C37IG2	C1.19
C3LG6	C1.13, C1.15, C1.17, C1.21
C400X100A0T	E2.20
C400X100A8T	E2.20
C400X100AMT	E2.20
C400X100APT	E2.20
C400X100AST	E2.20
C400X100AWT	E2.20
C400X100CBT	E2.18
C400X100YJJ	E2.6
C400X100YJT	E2.18
C400X100YK	E2.20
C400X200YJJ	E2.6
C400X200YJT	E2.18
C400X200YMT	E2.18
C400X300YJT	E2.18
C400X400A11	E5.40
C400X400A21	E5.40
C400X400A31	E5.40
C400X400YJJ	E2.6
C400X400YJT	E2.18
C400X600AX1	E5.40
C400X600AY1	E5.40
C400X600AZ1	E5.40
C400X600PBT	E2.18
C400X600Y81	E5.40
C400X600YJT	E2.18
C400X600YX1	E5.40
C400X600YZ1	E5.40
C4LG6	C1.13, C1.15, C1.17, C1.21
C4YL6	C1.56
C500X700FJJ	E2.6
C50IG2	C1.19
C62IG2	C1.19
C6LG6	C1.13, C1.15, C1.21
C-720	D1.87, D3.37
C75IG2	C1.19
C788X050YJJ	E2.6
C850X1100YJJ	E2.6
C850X1100YLJ	E2.6
CA-800EZ	D1.143
CA10	D1.143
CA3IW-X	C2.82
CA5IW-X	C2.82
CA-800EZ	D1.143
CA9	D1.143
CAMT	B3.14
CB125-14-QY	D2.139
CB175-38-QY	D2.139
CB225-56-QY	D2.139
CB25-18-CY	D2.139
CB300-38-QY	D2.139
CB35-36-CY	D2.139
CB400-38-3Y	D2.139
CB650-12-3Y	D2.139
CB70-14-CY	D2.139
CBA70-14-CY	D2.139
CBLS18-C	B2.46
CBLS25-C	B2.46
CBLS37-C	B2.46
CBLS50-C	B2.46
CBLS62-C	B2.46
CBLS75-C	B2.46
<b>CBOT24K</b>	<b>B1.92</b>

Part Number	Page Number
CBP100-C	B2.46
CBP12-C	B2.46
CBP25-C	B2.46
CBP31-C	B2.46
CBP37-C	B2.46
CBP50-C	B2.46
CBP62-C	B2.46
CBP75-C	B2.46
CBP87-C	B2.46
CBR1M-M	B1.58
CBR1M-M0	B1.59
CBR1M-M30	B1.60
CBR1.5I-M	B1.58
CBR1.5I-M0	B1.59
CBR1.5I-M30	B1.60
CBR1.5M-M	B1.58
CBR1.5M-M0	B1.59
CBR2HS-D	B1.58
CBR2HS-D0	B1.59
CBR2M-M	B1.58
CBR2M-M0	B1.59
CBR2S-M	B1.58
CBR2S-M0	B1.59
CBR2S-M30	B1.60
CBR2S-M39	B1.60
CBR3I-M	B1.58
CBR3I-M0	B1.59
CBR3S-M	B1.58
CBR3S-M0	B1.59
<b>CBR3S-M30</b>	<b>B1.60</b>
CBR3S-M69	B1.60
CBR4I-M	B1.58
CBR4I-M0	B1.59
CBR4LH-TL	B1.58
CBR4LH-TL0	B1.59
CBR4LH-TL30	B1.60
CBR4S-M	B1.58
CBR4S-M0	B1.59
CBR4S-M30	B1.60
CBR6LH-C	B1.58
CBR6LH-C0	B1.59
CBR6LH-C30	B1.60
CC-720	D1.87, D3.37
CCH100-S10-C	B2.40
CCH112-S10-C	B2.40
CCH119-S10-C	B2.40
CCH125-S10-C	B2.40
CCH12-S10-C	B2.40
CCH138-S10-C	B2.40
CCH150-S10-C	B2.40
CCH19-S10-C	B2.40
CCH25-S10-C	B2.40
CCH31-S10-C	B2.40
CCH38-S10-C	B2.40
CCH44-S10-C	B2.40
CCH50-S10-C	B2.40
CCH56-S10-C	B2.40
CCH62-S10-C	B2.40
CCH69-S10-C	B2.40
CCH75-S10-C	B2.40
CCH81-S10-C	B2.40
CCH87-S10-C	B2.40
CCMKIT1	C4.14
CCMKIT2	C4.14
CCS12-S8-C	B2.40
CCS19-S8-C	B2.40
CCS25-S10-C	B2.40
CCS25-S8-C	B2.40
CCS31-S8-C	B2.40
CCS38-S8-C	B2.40
CCS44-S8-C	B2.40
CCS50-S8-C	B2.40
CCT-320	D3.39
CCT-500	D3.39
CD125-14-QY	D2.138
CD-2001-1	D3.42
CD-2001-1/0	D3.42

Part Number	Page Number
CD-2001-2	D3.42
CD-2001-2/0	D3.42
CD-2001-250	D3.42
CD-2001-3/0	D3.42
CD-2001-300	D3.42
CD-2001-350	D3.42
CD-2001-4	D3.42
CD-2001-4/0	D3.42
CD-2001-400	D3.42
CD-2001-500	D3.42
CD-2001-6	D3.42
CD-2001-8	D3.42
CD-2001-BG	D3.42
CD-2001-C	D3.42
CCS12-S8-C	B2.40
CCS19-S8-C	B2.40
CCS25-S10-C	B2.40
CCS25-S8-C	B2.40
CCS31-S8-C	B2.40
CCS38-S8-C	B2.40
CCS44-S8-C	B2.40
CCS50-S8-C	B2.40
CD10-1	D1.143, D1.146
CD10-2	D1.143, D1.146
CD10-3	D1.143, D1.146
CD225-56-QY	D2.138
CD125-14-QY	D2.138
CD35-36-QY	D2.138
CD70-14-QY	D2.138
CD300-38-3Y	D2.138
CD400-38-3Y	D2.138
CD650-12-3Y	D2.138
<b>CD-2600-P2</b>	<b>D1.89</b>
<b>CD-2600-P4</b>	<b>D1.89</b>
<b>CD-2600-P6</b>	<b>D1.89</b>
<b>CD-2600-P8</b>	<b>D1.89</b>
<b>CD-2600-PV2</b>	<b>D1.89</b>
<b>CD-2600-PV4</b>	<b>D1.89</b>
<b>CD-2600-PV6</b>	<b>D1.89</b>
<b>CD-2600-PV8</b>	<b>D1.89</b>
CD-525	D1.88
CD-550	D1.88
CD-570	D1.88
CD-720-1	D3.37
CD-720-2	D3.37
CD-720-3	D3.37
CD-720-4	D3.37
CD-720-5	D3.37
CD-720-6	D3.37
CD-720-7	D3.37
CD-720PV8-2	D3.37
CD-800-1	D1.145
CD-800-10	D1.145
CD-800-11	D1.145
CD-800-12	D1.145
CD-800-13	D1.145
CD-800-14	D1.145
CD-800-15	D1.145
CD-800-16	D1.145
CD-800-17	D1.145
CD-800-18	D1.145
CD-800-1D	D1.145
CD-800-2	D1.145
CD-800-2D	D1.145
CD-800-3	D1.145
CD-800-4	D1.145
CD-800-5	D1.145
CD-800-6	D1.145
CD-800-7	D1.145
CD-800-8	D1.145
CD-800-9	D1.145
CD-920-1	D3.50
CD-920-1/0	D3.50
CD-920-2	D3.50
CD-920-2/0	D3.50
CD-920-250	D3.50
CD-920-3/0	D3.50

A. System Overview
B1. Cable Ties
B2. Cable Accessories
B3. Stainless Steel Ties
C1. Wiring Duct
C2. Surface Raceway
C3. Abrasion Protection
C4. Cable Management
D1. Terminals
D2. Power Connectors
D3. Grounding Connectors
E1. Labeling Systems
E2. Labels
E3. Pre-Printed & Write-On Markers
E4. Permanent Identification
E5. Lockout/ Tagout & Safety Solutions
F. Index

# PANDUIT® ELECTRICAL SOLUTIONS

A. System Overview	Part Number	Page Number	Part Number	Page Number	Part Number	Page Number
B1. Cable Ties	CD-920-300	D3.50	CF5IW-E	C2.79	CLTS100N-C	C3.13
	CD-920-350	D3.50	CF752575F-Q	C3.14	CLTS125F-L	C3.12
	CD-920-4	D3.50	CF753875F-Q	C3.14	CLTS125F-L3	C3.12
	CD-920-4/0	D3.50	CFX10IW-X	C2.75, C2.80, C2.81	CLTS125N-L	C3.13
B2. Cable Accessories	CD-920-400	D3.50	CFX3IW-X	C2.80, C2.81	CLTS150F-D	C3.12
	CD-920-500	D3.50	CFX5IW-X	C2.80, C2.81	CLTS150F-D3	C3.12
	CD-920-500A	D3.50	CG-920	D3.55	CLTS25F-10M	C3.12
	CD-920-6	D3.50	CG-940	D3.55	CLTS25F-C	C3.12
	CD-920-600	D3.50	CG-980	D3.55	CLTS25F-C3	C3.12
	CD-920-750	D3.50	CH105-A-C14	B2.37	CLTS25N-10M	C3.13
	CD-920-8	D3.50	CH105-S6-C14	B2.37	CLTS25N-C	C3.13
	CD-920-BG	D3.50	CLRCVR1-1	D3.13	CLTS35F-C	C3.12
B3. Stainless Steel Ties	CD-920-C	D3.50	CLRCVR2-1	D3.13	CLTS35F-C3	C3.12
	CD-920-D3	D3.50	CLRCVR3-1	D3.13	CLTS35N-C	C3.13
	CD-920-O	D3.50	CLT100F-125M20	C3.12	CLTS38F-C	C3.12
	CD-930G-1/0	D3.50	CLT100F-C20	C3.12	CLTS38F-C3	C3.12
C1. Wiring Duct	CD-930G-250	D3.50	CLT100F-C3	C3.12	CLTS38N-C	C3.13
	CD-930G-500	D3.50	CLT100F-C4	C3.12	CLTS50F-C	C3.12
	CD-920H-2	D3.50	CLT100F-X4	C3.12	CLTS50F-C3	C3.12
	CD-920H-6	D3.50	CLT100N-125M630	C3.13	CLTS50N-C	C3.13
C2. Surface Raceway	CD-930H-250	D3.50	CLT100N-C630	C3.13	CLTS62F-C	C3.12
	CD-940-1000	D3.51	CLT125N-.75M630	C3.13	CLTS62F-C3	C3.12
	CD-940-1000A	D3.51	CLT125F-L20	C3.12	CLTS62N-C	C3.13
	CD-940-750	D3.51	CLT125F-L3	C3.12	CLTS75F-2M	C3.12
C3. Abrasion Protection	CD-940-750A	D3.51	CLT125F-L4	C3.12	CLTS75F-C	C3.12
	CD-940-750X	D3.51	CLT125F-.75M20	C3.12	CLTS75F-C3	C3.12
	CD-940-800	D3.51	CLT125N-L630	C3.13	CLTS75N-2M	C3.13
	CD-940-800A	D3.51	CLT150F-D20	C3.12	CLTS75N-C	C3.13
C4. Cable Management	CD-940-DA	D3.51	CLT150F-D3	C3.12	CM4S-L2	B1.80
	CD9-10A	D1.146	CLT150F-D4	C3.12	CM4S-L8	B1.80
	CD9-10B	D1.146	CLT150F-T20	C3.12	CMP-100-1	D2.118, D2.155, D3.24
	CD9-11A	D1.146	CLT150F-X20	C3.12	CMP-200-1	D2.118, D3.24
	CD9-11B	D1.146	CLT150F-X3	C3.12	CMP-300-1	D3.24
	CD9-12A	D1.146	CLT150F-X4	C3.12	CMP-300-4-1	D3.24
	CD9-13B	D1.146	CLT150N-D630	C3.13	CMVDR1	C4.13
	CD9-14A	D1.146	CLT188F-X20	C3.12	CMVDR1S	C4.13
	CD9-15A	D1.146	CLT188F-X3	C3.12	CMVDR2	C4.13
	CD9-16A	D1.146	CLT188F-X4	C3.12	CMVDR2S	C4.13
D1. Terminals	CD9-17B	D1.146	CLT188N-6C630	C3.13	CMVDRC	C4.13
	CD9-18B	D1.146	CLT25F-10M20	C3.11	CMW-KIT	C4.11
	CD9-1A	D1.146	CLT25F-C20	C3.11	CMW2B	C4.11
	CD9-1AD	D1.146	CLT25F-C3	C3.11	CMWB	C4.11
D2. Power Connectors	CD9-1B	D1.146	CLT25F-C4	C3.11	CMWW	C4.11
	CD9-2A	D1.146	CLT25N-10M630	C3.13	CO125-14-QY	D2.140
	CD9-2AD	D1.146	CLT25N-C630	C3.13	CO225-56-QY	D2.140
	CD9-2B	D1.146	CLT35F-7M20	C3.11	CO300-38-3Y	D2.140
D3. Grounding Connectors	CD9-3B	D1.146	CLT35F-C20	C3.11	CO35-36-QY	D2.140
	CD9-4A	D1.146	CLT35F-C3	C3.11	CO400-38-3Y	D2.140
	CD9-4B	D1.146	CLT35F-C4	C3.11	CO650-12-3Y	D2.140
	CD9-5A	D1.146	CLT35N-C630	C3.13	CO70-14-QY	D2.140
	CD9-5B	D1.146	CLT38F-5M20	C3.11	CP-871	D1.144
	CD9-6B	D1.146	CLT38F-C20	C3.11	CP106IW	C2.60
	CD9-7A	D1.146	CLT38F-C3	C3.11	CP106IW-2G	C2.60
	CD9-8B	D1.146	CLT38F-C4	C3.11	CPGIW	C2.60
E1. Labeling Systems	CD9-9C	D1.146	CLT38N-5M630	C3.13	CPGIW-2G	C2.60
	CDCLP3	C1.9	CLT38N-C630	C3.13	CPH.75-S8-X	B2.48
	CDCLP4	C1.9	CLT50F-4M20	C3.11	CPL.75-S8-X	B2.48
	CDLB3	C1.9	CLT50F-C20	C3.11	CPM122S-C	B2.23
E2. Labels	CDLB4	C1.9	CLT50F-C3	C3.11	CPM87S-C	B2.23
	CDM-2001-1	D3.42	CLT50F-C4	C3.11	CPNIW	C2.60
	CDM-2001-1/0	D3.42	CLT50N-4M630	C3.13	CPNIW-2G	C2.60
	CDM-2001-2	D3.42	CLT50N-C630	C3.13	CR2-M	B2.26
E3. Pre-Printed & Write-On Markers	CDM-2001-2/0	D3.42	CLT62F-2.5M20	C3.11	CR4H-M	B2.26
	CDM-2001-3/0	D3.42	CLT62F-C20	C3.11	CR4H-M0	B2.26
	CDM-920-1	D3.50	CLT62F-C3	C3.11	CRFC5IW-X	C2.79, C2.80
	CDM-920-1/0	D3.50	CLT62F-C4	C3.11	CRFX5IW-X	C2.81
E4. Permanent Identification	CDM-920-2	D3.50	CLT62N-2.5M630	C3.13	CROS-M	B2.26
	CDM-920-2/0	D3.50	CLT62N-C630	C3.13	CRS1-125-X	C4.12
	CDM-920-250	D3.50	CLT75F-2M20	C3.12	CRS1-X	C4.12
	CDM-920-3/0	D3.50	CLT75F-C20	C3.12	CRS4-125-X	C4.12
E5. Lockout/Tagout & Safety Solutions	CDM-920-4/0	D3.50	CLT75F-C3	C3.11	CRS6-X	C4.12
	CEFXIW-X	C2.81	CLT75F-C4	C3.12	CS125-14-QY	D2.137
	CF10IW-X	C2.79	CLT75N-2M630	C3.13	CS175-38-QY	D2.137
	CF382538F-Q	C3.14	CLT75N-C630	C3.13	CS1LG6	C1.30
F. Index	CF3IW-E	C2.79	CLTS100F-1.25M	C3.12	CS225-56-QY	D2.137
	CF502550F-Q	C3.14	CLTS100F-C	C3.12	CS25-18-CY	D2.137
	CF503850F-Q	C3.14	CLTS100F-C3	C3.12	CS300-38-QY	D2.137



Part Number	Page Number
CS35-36-CY	D2.137
CS400-38-3Y	D2.137
CS650-12-3Y	D2.137
CS70-14-CY	D2.137
CSA70-14-CY	D2.137
CSC1LG6	C1.29
CSCS-M	B2.27
CSH-D0	B2.26
CSH-D20	B2.26
CSM-1.25-C	C4.10
CST101	D3.38
CST114-157	D3.38
CST114-157B	D3.38
CST115	D1.83, D3.38
CT-1	D1.85
CT-100A	D1.83
CT-1000	D1.86, D1.142
CT-1002	D1.85
CT-1003	D1.85
CT-1004	D1.85
CT-1005	D1.85
CT-1006	D1.85
CT-1014	D1.84
CT-1015	D1.84
CT-1104	D1.85
CT-1123	D1.85
CT-1525	D1.84
CT-1550	D1.84
CT-1551	D1.84
CT-1570	D1.84
CT-160	D1.83
CT-1700	D1.84
CT-1701	D1.84
CT-200	D1.83
<b>CT-2002/L</b>	<b>D3.41</b>
CT-2500	D1.88
CT-2500/E	D1.88
CT-2500BC	D1.88, D1.89
CT-2500CASE	D1.88
CT-2500CHR	D1.88, D1.89
CT-2500CHR/E	D1.88, D1.89
CT-2525CH	D1.88
CT-2550CH	D1.88
CT-2570CH	D1.88
CT-260	D1.83
<b>CT-2600</b>	<b>D1.89</b>
<b>CT-2600/E</b>	<b>D1.89</b>
<b>CT-2930/L</b>	<b>D3.43</b>
<b>CT-2930/LE</b>	<b>D3.43</b>
<b>CT-2940/L</b>	<b>D3.44</b>
<b>CT-2940/LE</b>	<b>D3.44</b>
<b>CT-2980/L</b>	<b>D3.53</b>
<b>CT-2980/LE</b>	<b>D3.53</b>
CT-300-1	D1.85
<b>CT-3001</b>	<b>D3.40</b>
<b>CT-3001/E</b>	<b>D3.40</b>
CT-310	D1.85
CT-400	D1.86
CT-460	D1.86
CT-500CH	D1.86
CT-520CH	D1.86
CT-550CH	D1.86
CT-570CH	D1.86
CT-600-A	D1.86
CT-720	D1.87, D3.37
CT-720-3	D3.38
CT-720-3CC	D3.38
CT-720-7	D3.38
CT-720-7CC	D3.38
CT-8250HP	D3.49
CT-900HPH	D3.47
CT-900LPHPH	D3.49
CT-901HP	D3.47
CT-901RCH	D3.47
CT-901RFS	D3.49, D3.47
CT-930	D3.39
CT-930CH	D3.45

Part Number	Page Number
CT-930LPCH	D3.48
CT-940CH	D3.46
CT-980	D3.52
CT-980CH	D3.54
CT-980LPCH	D3.54
<b>CT-LIBCKIT</b>	<b>D3.55</b>
<b>CT-LIBCKIT/E</b>	<b>D3.55</b>
<b>CT-LIBA</b>	<b>D3.55</b>
CTAP2-2-X	D3.12
CTAP2-4-Q	D3.12
CTAP2/0-2-X	D3.12
CTAP2/0-2/0-X	D3.12
CTAP4-4-L	D3.12
CTAP4-6-L	D3.12
CTAP4-8-L	D3.12
CTAP4/0-2-X	D3.12
CTAP4/0-2/0-X	D3.12
CTAP4/0-4/0-X	D3.12
CTAPF1-12-C	D3.11
CTAPF1/0-12-L	D3.11
CTAPF10-16-C	D3.11
CTAPF2-12-C	D3.11
CTAPF2/0-12-Q	D3.11
CTAPF3-12-C	D3.11
CTAPF3/0-12-Q	D3.11
CTAPF4-12-C	D3.11
CTAPF6-12-C	D3.11
CTAPF8-12-C	D3.11
<b>CTH19U04-C30</b>	<b>B2.44</b>
<b>CTH35U8-C30</b>	<b>B2.44</b>
<b>CTH38U10-C30</b>	<b>B2.44</b>
<b>CTH50U13-C30</b>	<b>B2.44</b>
<b>CTH62U17-C30</b>	<b>B2.44</b>
<b>CTH87U22-C30</b>	<b>B2.44</b>
CVR1000-1	D3.13
CVR2-1	D3.13
CVR250-1	D3.13
CVR500-1	D3.13
CVR6-1	D3.13
CW-12-Q	D2.114, D2.155
CW-14-L	D2.114, D2.155
CW-38-L	D2.114, D2.155
CW-56-L	D2.114, D2.155
CW-58-Q	D2.114, D2.155
CWD3	C1.35
CWD3LG6	C1.9
CWD3WH6	C1.9
CWD4	C1.35
CWD4LG6	C1.9
CWD4WH6	C1.9
CWF400	C4.10
CX125-14-QY	D2.136
CX125-56T-QY	D2.136
CX225-38T-QY	D2.136
CX225-56-QY	D2.136
CX225-56T-QY	D2.136
CX35-36-CY	D2.136
CX35-36T-CY	D2.136
CX400-12T-3Y	D2.142
CX400-38-3Y	D2.142
CX70-14-CY	D2.136
CX70-14T-CY	D2.136

## D

D-250A-C	D1.51
D1.5X3LG6	C1.17
D1.5X4LG6	C1.17
D10-250-L	D1.49
D10-250M-L	D1.53
D14-145M-C	D1.55
D14-187-C	D1.49
D14-188-C	D1.49
D14-250-C	D1.49
D14-250MB-C	D1.53
D18-145M-C	D1.55
D18-187-C	D1.49

Part Number	Page Number
D18-188-C	D1.49
D18-250-C	D1.49
D18-250MB-C	D1.53
D1X2LG6	C1.17
D1X3LG6	C1.17
D1X4LG6	C1.17
D2.5X3LG6	C1.17
D2H6	C1.26
D2HWH6	C1.26
D2X2LG6	C1.17
D2X3LG6	C1.17
D2X4LG6	C1.17
D3H6	C1.26
D3HWH6	C1.26
D3X2LG6	C1.17
D3X3LG6	C1.17
D3X4LG6	C1.17
D4H6	C1.26
D4HWH6	C1.26
D4X2LG6	C1.17
D4X3LG6	C1.17
D4X4LG6	C1.17
DB-C	C1.26
DC450-38-3Y	D2.145
DC600-38-3Y	D2.145
DC800-12-3Y	D2.145
DCEF3IW-X	C2.80, C2.81
DCF10IW-X	C2.79
DCF3IW-X	C2.79
DCF5IW-X	C2.79
DCT	C1.34
DCT-BLD	C1.34
DCT-RI	C1.34
DFCT	C1.34
DHC1.12X1.75-D0	B1.78
DM1-488-C	D1.58
DM1-63-C	D1.58
DM1-63M-C	D1.60
DM2-488-C	D1.58
DM2-63-C	D1.58
DM2-63M-C	D1.60
DM6-63-L	D1.58
DM6-63M-L	D1.60
DMNF1-283FIB-3K	D1.133
DMNF1-285-C	D1.58
DMNF1-285FIB-3K	D1.133
DMNF1-285FIB-C	D1.57
DMNF1-288-C	D1.58
DMNF1-288FIB-3K	D1.133
DMNF1-288FIB-C	D1.57
DMNF1-485FIB-3K	D1.133
DMNF1-488-C	D1.58
DMNF1-488FIB-3K	D1.133
DMNF1-488FIB-C	D1.57
DMNF1-63-C	D1.58
DMNF1-63FIB-3K	D1.133
DMNF1-63FIB-C	D1.57
DMNF1-63FIBX-2K	D1.134
DMNF1-63FIM-2K	D1.136
DMNF1-63FIM-L	D1.59
DMNF1-63FIMB-K	D1.136
DMNF1-63FIMX-2K	D1.137
DMNF1-63M-3K	D1.137
DMNF1-63M-C	D1.59
DMNF1485FIBX-2K	D1.134
DMNF1488FIBX-2K	D1.134
DMNF2-288-C	D1.58
DMNF2-485FIB-3K	D1.133
DMNF2-488-C	D1.58
DMNF2-488FIB-3K	D1.133
DMNF2-488FIB-C	D1.57
DMNF2-63-C	D1.58
DMNF2-63FIB-3K	D1.133
DMNF2-63FIB-C	D1.57
DMNF2-63FIBX-2K	D1.134
DMNF2-63FIM-2K	D1.136
DMNF2-63FIM-L	D1.59

A.  
System  
Overview

B1.  
Cable Ties

B2.  
Cable  
Accessories

B3.  
Stainless  
Steel Ties

C1.  
Wiring  
Duct

C2.  
Surface  
Raceway

C3.  
Abrasion  
Protection

C4.  
Cable  
Management

D1.  
Terminals

D2.  
Power  
Connectors

D3.  
Grounding  
Connectors

E1.  
Labeling  
Systems

E2.  
Labels

E3.  
Pre-Printed  
& Write-On  
Markers

E4.  
Permanent  
Identification

E5.  
Lockout/  
Tagout  
& Safety  
Solutions

F.  
Index

A. System Overview	Part Number	Page Number	Part Number	Page Number	Part Number	Page Number
B1. Cable Ties	DMNF2-63FIMB-K	D1.136	DNF14-250FI-L	D1.45	DNG18-187FB-3K	D1.122
	DMNF2-63FIMX-2K	D1.137	DNF14-250FIB-3K	D1.123	DNG18-187FB-C	D1.43
	DMNF2-63M-3K	D1.137	DNF14-250FIB-C	D1.44, D1.45	DNG18-188FB-3K	D1.122
B2. Cable Accessories	DMNF2-63M-C	D1.59	DNF14-250FIM-2K	D1.128	DNG18-188FB-C	D1.43
	DMNF6-63FI-L	D1.57	DNF14-250FIM-L	D1.44	DNG18-250FB-3K	D1.122
	DMNF6-63M-L	D1.59	DNF14-250FIMB-K	D1.128	DNG18-250FB-L	D1.43
	DMNF2485FIBX-2K	D1.134	DNF14-250FIMB-Q	D1.44	DNG18-250FL-3K	D1.123
	DMNF2488FIBX-2K	D1.134	DNF14-250M-3K	D1.129	DNG18-250FL-L	D1.44
	DMNF6-63FI-L	D1.57	DNF14-250M-C	D1.52	DNH10-250FI-E	D1.47
B3. Stainless Steel Ties	DMNF6-63FIB-2K	D1.133	DNF14205FIBX-2K	D1.124	DNH14-250FIB-Q	D1.47
	DMNF6-63M-2K	D1.137	DNF14206FIBX-2K	D1.124	DNH14-250FIM-Q	D1.47
	DMNF6-63M-L	D1.59	DNF14206FIBX-L	D1.45	DNH18-250FIB-Q	D1.47
C1. Wiring Duct	DMNFR1485FIB-KD	D1.134	DNF14250FIBX-2K	D1.124	DNH18-250FIM-Q	D1.47
	DMNFR1488FIB-KD	D1.134	DNF14250FIBX-L	D1.45	DNT-100	C1.34
	DMNFR163FIB-KD	D1.134	DNF14250FIMX-2K	D1.128	DPF10-250FI-L	D1.46
C2. Surface Raceway	DMNFR2485FIB-KD	D1.134	DNF18-110-C	D1.47	DPF10-250FIB-2K	D1.126
	DMNFR2488FIB-KD	D1.134	DNF18-110FIB-3K	D1.123	DPF10-250FIB-L	D1.46
	DMNG1-485FB-3K	D1.132	DNF18-110FIB-C	D1.45	DPF14-187FIB-3K	D1.126
C3. Abrasion Protection	DMNG1-63FB-3K	D1.132	DNF18-111-C	D1.47	DPF14-205FIB-3K	D1.126
	DMNG1-63FL-3K	D1.133	DNF18-111FIB-3K	D1.123	DPF14-205FIB-C	D1.46
	DMNG2-485FB-3K	D1.132	DNF18-111FIB-C	D1.45	DPF14-206FIB-3K	D1.126
	DMNG2-488FB-3K	D1.132	DNF18-112FIB-3K	D1.123	DPF14-206FIB-C	D1.46
	DMNG2-63FB-3K	D1.132	DNF18-187-C	D1.47	DPF14-250FIB-3K	D1.126
	DMNG2-63FL-3K	D1.133	DNF18-187FIB-3K	D1.123	DPF14-250FIB-C	D1.46
C4. Cable Management	DMPF1-285FIB-3K	D1.135	DNF18-187FIB-C	D1.45	DPF14-250FIM-2K	D1.127
	DMPF1-288FIB-3K	D1.135	DNF18-188-C	D1.47	DPF14-250FIM-L	D1.46
	DMPF1-485FIB-3K	D1.135	DNF18-188FIB-3K	D1.123	DPF14-250FIMB-K	D1.127
	DMPF1-488FIB-3K	D1.135	DNF18-188FIB-C	D1.45	DPF14-250FIMB-Q	D1.46
	DMPF1-63FIB-3K	D1.135	DNF18-205-C	D1.47	DPF18-110FIB-3K	D1.126
	DMPF1-63FIM-2K	D1.136	DNF18-205FIB-3K	D1.123	DPF18-110FIB-C	D1.46
D1. Terminals	DMPF1-63FIMB-K	D1.136	DNF18-205FIB-L	D1.45	DPF18-111FIB-3K	D1.126
	DMPF2-485FIB-3K	D1.135	DNF18-206-C	D1.47	DPF18-111FIB-C	D1.46
	DMPF2-488FIB-3K	D1.135	DNF18-206FIB-3K	D1.123	DPF18-187FIB-3K	D1.126
	DMPF2-63FIB-3K	D1.135	DNF18-206FIB-L	D1.45	DPF18-188FIB-3K	D1.126
	DMPF2-63FIM-2K	D1.136	DNF18-250-C	D1.47	DPF18-205FIB-3K	D1.126
	DMPF2-63FIMB-K	D1.136	DNF18-250FI-L	D1.45	DPF18-205FIB-C	D1.46
D2. Power Connectors	DMPF2-63FIMX-2K	D1.136	DNF18-250FIB-3K	D1.123	DPF18-206FIB-3K	D1.126
	DMPF6-63FIB-2K	D1.135	DNF18-250FIB-C	D1.44, D1.45	DPF18-206FIB-C	D1.46
	DMV1-37MB-3K	D1.139	DNF18-250FIM-2K	D1.128	DPF18-250FIB-3K	D1.126
	DMV1-485B-3K	D1.135	DNF18-250FIM-L	D1.44	DPF18-250FIB-C	D1.46
	DMV1-488B-3K	D1.135	DNF18-250FIMB-K	D1.128	DPF18-250FIM-2K	D1.127
	DMV1-63B-3K	D1.135	DNF18-250FIMB-L	D1.44	DPF18-250FIM-L	D1.46
D3. Grounding Connectors	DMV1-63MB-3K	D1.138	DNF18-250M-3K	D1.129	DPF18-250FIMB-K	D1.127
	DMV1-63P-LY	D1.59	DNF18-250M-C	D1.52	DPF18-250FIMB-L	D1.46
	DMV2-37MB-3K	D1.139	DNF18205FIBX-2K	D1.124	DR10-250-L	D1.50
	DMV2-485B-3K	D1.135	DNF18205FIBX-L	D1.45	DR14-205-C	D1.50
	DMV2-488B-3K	D1.135	DNF18206FIBX-2K	D1.124	DR14-205B-C	D1.51
	DMV2-63B-3K	D1.135	DNF18206FIBX-L	D1.45	DR14-206-C	D1.50
E1. Labeling Systems	DMV2-63MB-3K	D1.138	DNF18250FIBX-2K	D1.124	DR14-206B-C	D1.51
	DMV2-63P-L	D1.59	DNF18250FIBX-L	D1.45	DR14-250-C	D1.50
	DMV6-63-2K	D1.135	DNF18250FIMX-2K	D1.128	DR14-250B-C	D1.51
	DMV6-63-L	D1.58	DNFR14-205B-L	D1.50	DR18-205-C	D1.50
	DMV6-63M-2K	D1.138	DNFR14-205FIB-L	D1.49	DR18-205B-C	D1.51
	DNF10-250FI-L	D1.44, D1.45	DNFR14-206B-L	D1.50	DR18-206-C	D1.50
E2. Labels	DNF10-250FIB-2K	D1.123	DNFR14-206FIB-L	D1.49	DR18-206B-C	D1.51
	DNF10-250FIB-L	D1.45	DNFR14-250B-L	D1.50	DR18-250-C	D1.50
	DNF10-250FIMB-K	D1.128	DNFR14-250FIB-L	D1.49	DR18-250B-C	D1.51
	DNF10-250FIMB-Q	D1.44	DNFR14205FIB-KD	D1.124	<b>DRD22LG6</b>	<b>C1.5</b>
	DNF10-250M-2K	D1.129	DNFR14206FIB-KD	D1.124	<b>DRD33LG6</b>	<b>C1.5</b>
	DNF10-250M-L	D1.52	DNFR14250FIB-KD	D1.124	<b>DRD44LG6</b>	<b>C1.5</b>
E3. Pre-Printed & Write-On Markers	DNF10250FIBC-2K	D1.123	DNFR18-205B-L	D1.50	<b>DRDC2LG6</b>	<b>C1.5</b>
	DNF14-110-C	D1.47	DNFR18-205FIB-L	D1.49	<b>DRDC3LG6</b>	<b>C1.5</b>
	DNF14-111-C	D1.47	DNFR18-206B-L	D1.50	<b>DRDC4LG6</b>	<b>C1.5</b>
	DNF14-187-C	D1.47	DNFR18-206FIB-L	D1.49	<b>DRDCS2-X</b>	<b>C1.5</b>
	DNF14-187FIB-3K	D1.123	DNFR18-250B-L	D1.50	<b>DRDCS3-X</b>	<b>C1.5</b>
	DNF14-187FIB-C	D1.45	DNFR18-250FIB-L	D1.49	<b>DRDCS4-X</b>	<b>C1.5</b>
E4. Permanent Identification	DNF14-188-C	D1.47	DNFR18205FIB-KD	D1.124	<b>DRDSF-C</b>	<b>C1.5</b>
	DNF14-188FIB-3K	D1.123	DNFR18206FIB-KD	D1.124	<b>DRDWR2-X</b>	<b>C1.5</b>
	DNF14-188FIB-C	D1.45	DNFR18250FIB-KD	D1.124	<b>DRDWR3-X</b>	<b>C1.5</b>
	DNF14-205-C	D1.47	DNG14-187FB-3K	D1.122	<b>DRDWR4-X</b>	<b>C1.5</b>
	DNF14-205FIB-3K	D1.123	DNG14-187FB-L	D1.43	DS1	C3.18
	DNF14-205FIB-C	D1.45	DNG14-188FB-3K	D1.122	DS5	C3.18
E5. Lockout/Tagout & Safety Solutions	DNF14-206-C	D1.47	DNG14-188FB-L	D1.43	DSF-NP	D1.144
	DNF14-206FIB-3K	D1.123	DNG14-250FB-3K	D1.122	DSF-RS	D1.144
	DNF14-206FIB-C	D1.45	DNG14-250FB-L	D1.43	DT14EH-L0	B1.53
	DNF14-206C	D1.47	DNG14-250FL-3K	D1.123	DT15EH-L0	B1.53
	DNF14-206FIB-3K	D1.123	DNG14-250FL-L	D1.44	DT28EH-C0	B1.53
	DNF14-206FIB-C	D1.45				

Part Number	Page Number
DT44EH-C0	B1.53
DT4EH-L0	B1.53
DT8EH-Q0	B1.53
DTHEH-Q0	B1.53
DTHH-Q0	B1.53
DTKEH-0	B1.53
DTKH-0	B1.53
DTREH-LR0	B1.53
DTRH-LR0	B1.53
DV10-250-2K	D1.125
DV10-250-L	D1.48
DV10-250C-2K	D1.125
DV10-250M-2K	D1.129
DV10-250M-L	D1.52
DV14-145M-C	D1.55
DV14-145MB-3K	D1.130
DV14-187B-3K	D1.125
DV14-187B-C	D1.48
DV14-188B-3K	D1.125
DV14-188B-C	D1.48
DV14-205B-3K	D1.125
DV14-205B-C	D1.48
DV14-206B-3K	D1.125
DV14-206B-C	D1.48
DV14-250B-3K	D1.125
DV14-250B-C	D1.48
DV14-250MB-3K	D1.129
DV14-250MB-C	D1.52
DV14-250P-L	D1.51
DV18-145M-CY	D1.55
DV18-145MB-3K	D1.130
DV18-187B-3K	D1.125
DV18-187B-CY	D1.48
DV18-188B-3K	D1.125
DV18-188B-CY	D1.48
DV18-205B-3K	D1.125
DV18-205B-CY	D1.48
DV18-206B-3K	D1.125
DV18-206B-CY	D1.48
DV18-250B-3K	D1.125
DV18-250B-CY	D1.48
DV18-250MB-3K	D1.129
DV18-250MB-CY	D1.52
DV18-250P-LY	D1.51
DVF14-187-C	D1.48
DVF14-188-C	D1.48
DVF14-205-C	D1.48
DVF14-206-C	D1.48
DVF14-250-C	D1.48
DVF18-187-CY	D1.48
DVF18-188-CY	D1.48
DVF18-205-CY	D1.48
DVF18-206-CY	D1.48
DVF18-250-CY	D1.48

## E

E2X2YL6	C1.56
E4X4YL6	C1.56
ECF10IW-X	C2.79
ECF3IW-E	C2.79
ECF5IW-E	C2.79
ECFX10IW-X	C2.75, C2.80, C2.81
ECFX3IW-X	C2.80, C2.81
ECFX5IW-X	C2.80, C2.81
EDU20IW-X	C2.61
EEFXIW	C2.75
EGU20IW-X	C2.61
EMA-X	B2.9
EMS-A-C	B2.9
EMS-A-C0	B2.9
EMSK12-4-12-X0	B2.9
EMSK3-1-3-0	B2.9
EMSK3-1-X0	B2.9
ER.5-E4-X	B2.47
ER1.25-E4-X	B2.47
<b>ERT2M-C20</b>	<b>B1.91</b>

Part Number	Page Number
<b>ERT3M-C20</b>	<b>B1.91</b>
<b>ERT4.5M-C20</b>	<b>B1.91</b>
ERU20IW-X	C2.61
ETU20IW-X	C2.61

## F

F.5X.5LG6	C1.15
F.5X.5LG6-A	C1.33
F.5X1LG6	C1.15
F.5X1LG6-A	C1.33
F.75X.75LG6	C1.15
F.75X.75LG6-A	C1.33
F.75X1.5LG6	C1.15
F.75X1.5LG6-A	C1.33
F1.5X1.5LG6	C1.11
F1.5X1.5LG6-A	C1.33
F1.5X1LG6	C1.15
F1.5X1LG6-A	C1.33
F1.5X2LG6	C1.15
F1.5X2LG6-A	C1.33
F1.5X3LG6	C1.15
F1.5X3LG6-A	C1.33
F1.5X3WH6-A	C1.33
F1.5X4LG6	C1.15
F1.5X4LG6-A	C1.33
F1.5X4WH6-A	C1.33
F100X150AJC	E1.7
F14PN-L	C1.59
F14PWN-L	C1.59
F1X1.5LG6	C1.15
F1X1.5LG6A	C1.33
F1X1LG6	C1.15
F1X1LG6-A	C1.33
F1X2LG6	C1.15
F1X2LG6-A	C1.33
F1X2WH6-A	C1.33
F1X3LG6	C1.15
F1X3LG6-A	C1.33
F1X3WH6-A	C1.33
F1X4LG6	C1.15
F1X4LG6-A	C1.33
F1X4WH6-A	C1.33
F2.5X3LG6	C1.15
F2PCLB12	C1.61
F2PCLB58	C1.61
F2X1.5LG6	C1.15
F2X1.5LG6-A	C1.33
F2X1LG6	C1.15
F2X1LG6-A	C1.33
F2X2LG6	C1.15
F2X2LG6-A	C1.33
F2X2WH6-A	C1.33
F2X3LG6	C1.15
F2X3LG6-A	C1.33
F2X3WH6-A	C1.33
F2X4LG6	C1.15
F2X4LG6-A	C1.33
F2X4WH6-A	C1.33
F2X5LG6	C1.15
F2X5LG6A	C1.33
F3X1LG6	C1.15
F3X1LG6A	C1.33
F3X2LG6	C1.15
F3X2LG6-A	C1.33
F3X3LG6	C1.15
F3X3LG6-A	C1.33
F3X3WH6-A	C1.33
F3X4LG6	C1.15
F3X4LG6-A	C1.33
F3X4WH6-A	C1.33
F3X5LG6	C1.15
F3X5LG6-A	C1.33
F4X2LG6	C1.15
F4X2LG6-A	C1.33
F4X3LG6	C1.15
F4X3LG6-A	C1.33

Part Number	Page Number
F4X3WH6-A	C1.33
F4X4LG6	C1.15
F4X4LG6-A	C1.33
F4X4WH6-A	C1.33
F4X5LG6	C1.15
F4X5LG6-A	C1.33
<b>F6X4LG6</b>	<b>C1.15</b>
F73-5-M	D1.76
F73-7-M	D1.76
F74-5-M	D1.76
F74-7-M	D1.76
F75-10-M	D1.76
F75-6-M	D1.76
F75-8-M	D1.76
F76-10-M	D1.76
F76-12-M	D1.76
F76-6-M	D1.76
F76-8-M	D1.76
F77-10-M	D1.76
F77-12-M	D1.76
F77-6-M	D1.76
F77-7-M	D1.76
F77-8-M	D1.76
F78-10-M	D1.76
F78-12-M	D1.76
F78-15-M	D1.76
F78-18-M	D1.76
F78-20-M	D1.76
F78-7-M	D1.76
F78-8-M	D1.76
F80-10-M	D1.77
F80-12-M	D1.77
F80-15-M	D1.77
F80-18-M	D1.77
F80-20-M	D1.77
F80-7-M	D1.77
F80-8-M	D1.77
F81-10-M	D1.77
F81-12-M	D1.77
F81-15-M	D1.77
F81-18-M	D1.77
F81-20-M	D1.77
F81-9-M	D1.77
F82-10-M	D1.77
F82-12-M	D1.77
F82-15-M	D1.77
F82-18-M	D1.77
F82-20-M	D1.77
F83-12-D	D1.77
F83-15-D	D1.77
F83-18-D	D1.77
F83-20-D	D1.77
F83-25-D	D1.77
F84-12-TL	D1.77
F84-15-TL	D1.77
F84-18-TL	D1.77
F84-20-TL	D1.77
F84-25-TL	D1.77
F84-32-TL	D1.77
F85-12-C	D1.77
F85-15-C	D1.77
F85-18-C	D1.77
F85-25-C	D1.77
F85-32-C	D1.77
F86-18-C	D1.77
F86-20-C	D1.77
F86-25-C	D1.77
F86-32-C	D1.77
F87-18-C	D1.77
F87-22-C	D1.77
F87-25-C	D1.77
F87-32-C	D1.77
FBA10IW-X	C2.79
FBA5IW-X	C2.79
FCBI1-A-C20	B2.25
FCBI1-S10-C20	B2.25
FCBI2-A-C20	B2.25

A.  
System  
Overview

B1.  
Cable Ties

B2.  
Cable  
Accessories

B3.  
Stainless  
Steel Ties

C1.  
Wiring  
Duct

C2.  
Surface  
Raceway

C3.  
Abrasion  
Protection

C4.  
Cable  
Management

D1.  
Terminals

D2.  
Power  
Connectors

D3.  
Grounding  
Connectors

E1.  
Labeling  
Systems

E2.  
Labels

E3.  
Pre-Printed  
& Write-On  
Markers

E4.  
Permanent  
Identification

E5.  
Lockout/  
Tagout  
& Safety  
Solutions

F.  
Index

# PANDUIT® ELECTRICAL SOLUTIONS

A. System Overview	Part Number	Page Number	Part Number	Page Number	Part Number	Page Number
B1. Cable Ties	FCBI2-S10-C20	B2.25	FS1X4LG6NM	C1.21	FSD86-16-L	D1.73
	FCBI3-A-C20	B2.25	FS2X1.5LG6NM	C1.21	FSD86-18-L	D1.73
	FCBI3-S10-C20	B2.25	FS2X1LG6NM	C1.21	FSD86-25-L	D1.73
B2. Cable Accessories	FCC-A-C8	B2.39	FS2X2LG6NM	C1.21	FSD87-20-L	D1.73
	FCC5-A-C8	B2.39	FS2X3LG6NM	C1.21	FSD87-25-Q	D1.73
	FCF2X2YL	C1.56	FS2X4LG6NM	C1.21	FSF72-6-D	D1.74
	FCF4X4YL	C1.56	FS3X1LG6NM	C1.21	FSF72-8-D	D1.74
	FCH2-A-C14	B2.38	FS3X2LG6NM	C1.21	FSF73-6-D	D1.74
	FCH2-S6-C14	B2.38	FS3X3LG6NM	C1.21	FSF73-8-D	D1.74
B3. Stainless Steel Ties	FCM1-A-C14	B2.38	FS3X4LG6NM	C1.21	FSF74-6-D	D1.74
	FCM1-S6-C14	B2.38	FS3X5LG6NM	C1.21	FSF74-8-D	D1.74
	FCM1.2-A-C14	B2.38	FS4X2LG6NM	C1.21	FSF75-10-D	D1.74
	FCM1.2-S6-C14	B2.38	FS4X3LG6NM	C1.21	FSF75-6-D	D1.74
	FCM2-A-C14	B2.38	FS4X4LG6NM	C1.21	FSF75-8-D	D1.74
	FCM2-S6-C14	B2.38	FS4X5LG6NM	C1.21	FSF76-10-D	D1.74
C1. Wiring Duct	FCM3.25-A-L14	B2.38	FS6X4LG6-A	C1.33	FSF76-12-D	D1.74
	FCM3.25-S6-L14	B2.38	FS6X4LG6NM	C1.21	FSF76-6-D	D1.74
	FCPI1-C20	B2.25	FS75-8-5K3	D1.142	FSF76-8-D	D1.74
C2. Surface Raceway	FCPI2-C20	B2.25	FS75-8-DSL3	D1.75, D1.141	FSF77-10-D	D1.74
	FCPI3-C20	B2.25	FS76-8-5K10	D1.142	FSF77-12-D	D1.74
	FEC2X2YL	C1.57	FS76-8-5K7	D1.142	FSF77-6-D	D1.74
	FEC4X4YL	C1.57	FS76-8-DSL10	D1.75, D1.141	FSF77-8-D	D1.74
	FEIAB58	C1.61	FS76-8-DSL7	D1.75, D1.141	FSF78-10-D	D1.74
	FFWC2X2YL	C1.57	FS77-8-5K4	D1.142	FSF78-12-D	D1.74
C3. Abrasion Protection	FFWC4X4YL	C1.57	FS77-8-DSL4	D1.75, D1.141	FSF78-18-D	D1.74
	FG1EI5.0-A	C2.83	FS78-8-5K2	D1.142	FSF78-6-D	D1.74
	FG1EI50.0-A	C2.83	FS78-8-DSL2	D1.75, D1.141	FSF78-8-D	D1.74
	FG3EI5.0-A	C2.83	FS80-8-3K8	D1.142	FSF79-8-D	D1.74
	FG3EI50.0-A	C2.83	FS80-8-DSL8	D1.75, D1.141	FSF80-12-D	D1.74
	FG5EI25.0-A	C2.83	FSD72-6-D	D1.73	FSF80-18-D	D1.74
C4. Cable Management	FG5EI5.0-A	C2.83	FSD72-8-D	D1.73	FSF80-8-D	D1.74
	FIDT2X2YL	C1.58	FSD73-6-D	D1.73	FSF81-10-D	D1.74
	FIDT4X4BL	C1.58	FSD73-8-D	D1.73	FSF81-12-C	D1.74
	FITF4X4B	C1.59	FSD74-6-D	D1.73	FSF81-18-C	D1.74
	FIV452X2YL	C1.57	FSD74-8-D	D1.73	FSF82-12-C	D1.74
	FIV454X4YL	C1.57	FSD75-10-D	D1.73	FSF82-18-C	D1.74
D1. Terminals	FIVRA2X2YL	C1.57	FSD75-6-D	D1.73	FSF83-12-C	D1.74
	FIVRA4X4YL	C1.57	FSD75-8-5K10	D1.142	FSF83-18-C	D1.74
	FL12X12LG-A	C1.26	FSD75-8-D	D1.73	FSF84-12-C	D1.74
D2. Power Connectors	FL25X25LG-A	C1.26	FSD75-8-DSL10	D1.75, D1.141	FSF84-18-C	D1.74
	FL50X50LG-A	C1.26	FSD76-10-D	D1.73	FSF85-16-L	D1.74
	FLB	C1.60	FSD76-12-D	D1.73	FSF85-18-L	D1.74
	FLB12X15	C1.60	FSD76-6-D	D1.73	FSF85-22-L	D1.74
	FLB12X20	C1.60	FSD76-8-5K8	D1.142	FSF86-16-L	D1.74
	FLB58X15	C1.60	FSD76-8-D	D1.73	FSF86-18-L	D1.74
D3. Grounding Connectors	FLB58X20	C1.60	FSD76-8-DSL8	D1.75, D1.141	FSF86-25-L	D1.74
	FLRB	C1.60	FSD77-10-D	D1.73	FSF87-20-L	D1.74
	FMWR-C	C1.29	FSD77-12-D	D1.73	FSF87-25-Q	D1.74
E1. Labeling Systems	FOV452X2YL	C1.57	FSD77-6-D	D1.73	FSH40-X	B2.50
	FOV454X4YL	C1.57	FSD77-8-5K2	D1.142	FSHH-X	B2.50
	FOVRA2X2YL	C1.57	FSD77-8-D	D1.73	FT2X2YL	C1.57
E2. Labels	FOVRA4X4YL	C1.57	FSD77-8-DSL2	D1.75, D1.141	FT4X4YL	C1.57
	FP2DCIW	C2.60	FSD78-10-D	D1.73	FTD75-8-D	D1.75
	FP2RCIW	C2.60	FSD78-12-D	D1.73	FTD76-10-D	D1.75
	FPC-600-A	D1.86	FSD78-18-D	D1.73	FTD76-8-D	D1.75
	FRA2X2YL	C1.56	FSD78-6-D	D1.73	FTD77-10-D	D1.75
	FRA4X4YL	C1.56	FSD78-6-D	D1.73	FTD77-8-D	D1.75
E3. Pre-Printed & Write-On Markers	FRAFC58	C1.61	FSD78-8-5K0	D1.142	FTD78-12-D	D1.75
	FRF42YL	C1.57	FSD78-8-D	D1.73	FTD78-8-D	D1.75
	FS.5X.5LG6NM	C1.21	FSD78-8-DSL0	D1.75, D1.141	FTD80-10-TL	D1.75
	FS.5X1LG6NM	C1.21	FSD79-8-D	D1.73	FTD80-13-TL	D1.75
	FS.75X.75LG6NM	C1.21	FSD80-12-D	D1.73	FTD81-12-C	D1.75
	FS1.5X1.5BL6-A	C1.33	FSD80-18-D	D1.73	FTD82-14-C	D1.75
E4. Permanent Identification	FS1.5X1.5LG6-A	C1.33	FSD80-8-3K6	D1.142	FTR2X2YL	C1.58
	FS1.5X1.5LG6NM	C1.21	FSD80-8-D	D1.73	FTR4X4YL	C1.58
	FS1.5X1.5WH6-A	C1.33	FSD80-8-DSL6	D1.75, D1.141	FTRBE12	C1.60
	FS1.5X1LG6NM	C1.21	FSD81-10-D	D1.73	FTRBE12M	C1.60
	FS1.5X2LG6NM	C1.21	FSD81-12-C	D1.73	FTRBE58	C1.60
	FS1.5X3LG6NM	C1.21	FSD81-18-C	D1.73	FTRBN12	C1.60
E5. Lockout/Tagout & Safety Solutions	FS156-C	B2.50	FSD82-12-C	D1.73	FTRBN12M	C1.60
	FS1X1.5LG6-A	C1.33	FSD82-18-C	D1.73	FTRBN58	C1.60
	FS1X1.5LG6NM	C1.21	FSD83-12-C	D1.73	FUSB	C1.60
	FS1X1LG6NM	C1.21	FSD83-18-C	D1.73	FVT4X4YL	C1.58
	FS1X1WH6-A	C1.33	FSD84-12-C	D1.73	FVTHD2X2YL	C1.58
	FS1X1WH6NM-A	C1.33	FSD84-18-C	D1.73	FWR-C	C1.29
F. Index	FS1X2LG6NM	C1.21	FSD85-16-L	D1.73	FZBA1.5X4	C1.60
	FS1X3LG6NM	C1.21	FSD85-18-L	D1.73	FZBLP	C1.60
			FSD85-22-L	D1.73		

# PANDUIT® ELECTRICAL SOLUTIONS

Part Number	Page Number
<b>G</b>	
G.5X.5LG6	C1.13
G.5X.5LG6-A	C1.33
G.5X.5WH6-A	C1.33
G.5X1LG6	C1.13
G.5X1LG6-A	C1.33
G.5X1WH6-A	C1.33
G.5X2LG6	C1.13
G.75X.75LG6	C1.13
G.75X.75LG6-A	C1.33
G.75X1.5LG6	C1.13
G.75X1.5LG6-A	C1.33
G.75X1.5WH6-A	C1.33
G.75X1LG6	C1.13
G.75X1LG6-A	C1.33
G.75X1WH6-A	C1.33
G.75X2LG6	C1.13
G.75X2LG6-A	C1.33
G.75X2WH6-A	C1.33
G1.5X1.5LG6	C1.13
G1.5X1.5LG6-A	C1.33
G1.5X1.5WH-A	C1.33
G1.5X1LG6	C1.13
G1.5X1LG6-A	C1.33
G1.5X1WH6-A	C1.33
G1.5X2LG6	C1.13
G1.5X2LG6-A	C1.33
G1.5X2WH6-A	C1.33
G1.5X3LG6	C1.13
G1.5X3LG6-A	C1.33
G1.5X3WH6-A	C1.33
G1.5X4LG6	C1.13
G1.5X4LG6-A	C1.33
G1.5X4WH6-A	C1.33
G1X1.5LG6	C1.13
G1X1.5LG6-A	C1.33
G1X1.5WH6-A	C1.33
G1X1LG6	C1.13
G1X1LG6-A	C1.33
G1X1WH6-A	C1.33
G1X2LG6	C1.13
G1X2LG6-A	C1.33
G1X2WH6-A	C1.33
G1X3BL6-A	C1.33
G1X3LG6	C1.13
G1X3LG6-A	C1.33
G1X3WH6-A	C1.33
G1X4LG6	C1.13
G1X4LG6-A	C1.33
G1X4WH6-A	C1.33
G2.5X3LG6	C1.13
G2.5X3LG6-A	C1.33
G2.5X3WH6-A	C1.33
G2X1.5LG6	C1.13
G2X1.5LG6-A	C1.33
G2X1WH6-A	C1.33
G2X2BL6-A	C1.33
G2X2LG6	C1.13
G2X2LG6-A	C1.33
G2X2WH6-A	C1.33
G2X3LG6	C1.13
G2X3LG6-A	C1.33
G2X3WH6-A	C1.33
G2X4BL6-A	C1.33
G2X4LG6	C1.13
G2X4LG6-A	C1.33
G2X4WH6-A	C1.33
G2X5LG6	C1.13
G2X5LG6-A	C1.33
G2X5WH6-A	C1.33
G3X1LG6	C1.13
G3X1LG6-A	C1.33
G3X1WH6-A	C1.33

Part Number	Page Number
G3X2LG6	C1.13
G3X2LG6-A	C1.33
G3X2WH6-A	C1.33
G3X3BL6-A	C1.33
G3X3LG6	C1.13
G3X3LG6-A	C1.33
G3X3WH6-A	C1.33
G3X4LG6	C1.13
G3X4LG6-A	C1.33
G3X4WH6-A	C1.33
G3X5LG6	C1.13
G3X5LG6-A	C1.33
G3X5WH6-A	C1.33
G4X1.5LG6	C1.13
G4X1.5LG6-A	C1.33
G4X1.5WH6-A	C1.33
G4X2LG6	C1.13
G4X2LG6-A	C1.33
G4X2WH6-A	C1.33
G4X3LG6	C1.13
G4X3LG6-A	C1.33
G4X3WH6-A	C1.33
G4X4BL6-A	C1.33
G4X4LG6	C1.13
G4X4LG6-A	C1.33
G4X4WH6-A	C1.33
G4X5LG6	C1.13
G4X5LG6-A	C1.33
G4X5WH6-A	C1.33
G6X4LG6	C1.13
GB2B0304TPI-1	D3.6
GB2B0306TPI-1	D3.6
GB2B0312TPI-1	D3.6
GB2B0514TPI-1	D3.6
<b>GB2D0008TPI-1</b>	<b>D3.7</b>
<b>GB2D0021TPI-1</b>	<b>D3.7</b>
<b>GB2D0033TPI-1</b>	<b>D3.7</b>
<b>GB2D0044TPI-1</b>	<b>D3.7</b>
<b>GB2D0056TPI-1</b>	<b>D3.7</b>
GB4B0612TPI-1	D3.6
GB4B0624TPI-1	D3.6
GB4B1028TPI-1	D3.6
<b>GB4N0007TPI-1</b>	<b>D3.7</b>
<b>GB4N0016TPI-1</b>	<b>D3.7</b>
<b>GB4N0024TPI-1</b>	<b>D3.7</b>
<b>GB4N0026TPI-1</b>	<b>D3.7</b>
<b>GB4N0034TPI-1</b>	<b>D3.7</b>
GC-15A-Q	D3.28
GC-18A-X	D3.28
GC-22A-4	D3.28
<b>GCE1/0-1/0</b>	<b>D3.8</b>
<b>GCE250-1/0</b>	<b>D3.8</b>
<b>GCE250-250</b>	<b>D3.8</b>
<b>GCE500-1/0</b>	<b>D3.8</b>
<b>GCE500-250</b>	<b>D3.8</b>
<b>GCC6X61/0-1/0</b>	<b>D3.9</b>
<b>GCC6X6250-1/0</b>	<b>D3.9</b>
<b>GCC6X6250-250</b>	<b>D3.9</b>
<b>GCC6X6500-1/0</b>	<b>D3.9</b>
<b>GCC6X6500-250</b>	<b>D3.9</b>
GE128-C	C3.10
GE128-C69	C3.10
GE192-L	C3.10
GE192-L69	C3.10
GE255-L	C3.10
GE318-L	C3.10
GE380-Q	C3.10
GE510-Q	C3.10
GE52-C	C3.10
GE52-C69	C3.10
GE85-C	C3.10
GE85-C69	C3.10
GEE134N-C	C3.10
GEE144F-A-C	C3.9
GEE144F-A-C0	C3.9
GEE144F-C	C3.8
GEE144F-C0	C3.8

Part Number	Page Number
GEE144FR-CY	C3.9
GEE36F-C	C3.8
GEE36F-C0	C3.8
GEE36FR-CY	C3.9
GEE47N-C	C3.10
GEE55N-C	C3.10
GEE62F-A-C	C3.9
GEE62F-A-C0	C3.9
GEE62F-C	C3.8
GEE62F-C0	C3.8
GEE62FR-CY	C3.9
GEE71N-C	C3.10
GEE98N-C	C3.10
GEE99F-A-C	C3.9
GEE99F-A-C0	C3.9
GEE99F-C	C3.8
GEE99F-C0	C3.8
GEE99FR-CY	C3.9
GES144F-A-C	C3.9
GES144F-A-C0	C3.9
GES144F-C	C3.9
GES144F-C0	C3.9
GES144FR-CY	C3.10
GES189F-C	C3.9
GES189F-C0	C3.9
GES36F-C	C3.9
GES36F-C0	C3.9
GES36FR-CY	C3.10
GES62F-A-C	C3.9
GES62F-A-C0	C3.9
GES62F-C	C3.9
GES62F-C0	C3.9
GES62FR-CY	C3.10
GES99F-A-C	C3.9
GES99F-A-C0	C3.9
GES99F-C	C3.9
GES99F-C0	C3.9
GES99FR-CY	C3.10
GHH	B1.114
<b>GLMHK</b>	<b>D3.7</b>
GM-2-Q	D3.29
GM-3-Q	D3.29
GMS-1-X	D3.29
GMS-2-Q	D3.29
GMS-3-Q	D3.29
<b>GPC4H250-2</b>	<b>D3.10</b>
GPL-10-Q	D3.25
GPL-14-X	D3.25
GPL-15-X	D3.25
GPL-16-X	D3.25
GPL-20-X	D3.25
GPL-21-X	D3.25
GPL-22-X	D3.25
GPL-26-X	D3.25
GPL-27-X	D3.25
GPL-28-X	D3.25
GPL-32-3	D3.25
GPL-33-3	D3.25
GPL-34-3	D3.25
GPL-39-3	D3.25
GPL-4-Q	D3.25
GPL-40-3	D3.25
GPL-44-1	D3.25
GPL-45-1	D3.25
GPL-46-1	D3.25
GPL-5-Q	D3.25
GPL-51-1	D3.25
GPL-52-1	D3.25
GPL-57-1	D3.25
GPL-58-1	D3.25
GPL-75-X	D3.25
GPL-6-Q	D3.25
GPL-8-Q	D3.25
GPL-9-Q	D3.25
<b>GPQC07-1/0</b>	<b>D3.5</b>
<b>GPQC10-1/0</b>	<b>D3.5</b>
<b>GPQC12-1/0</b>	<b>D3.5</b>

A. System Overview
B1. Cable Ties
B2. Cable Accessories
B3. Stainless Steel Ties
C1. Wiring Duct
C2. Surface Raceway
C3. Abrasion Protection
C4. Cable Management
D1. Terminals
D2. Power Connectors
D3. Grounding Connectors
E1. Labeling Systems
E2. Labels
E3. Pre-Printed & Write-On Markers
E4. Permanent Identification
E5. Lockout/Tagout & Safety Solutions
F. Index

# PANDUIT® ELECTRICAL SOLUTIONS

A. System Overview	Part Number	Page Number	Part Number	Page Number	Part Number	Page Number
	<b>GPQC15-1/0</b>	<b>D3.5</b>	H200X025H1T-B	E2.13	HL8-1-X	D2.130
	<b>GPQC17-1/0</b>	<b>D3.5</b>	H200X034H1T	E2.13	HL8-2-X	D2.132
B1. Cable Ties	<b>GPQC20-1/0</b>	<b>D3.5</b>	H200X034H1T-2	E2.15	HL8-2N-X	D2.133
	GS2B	B1.111	H200X034H1T-2-B	E2.15	HLA13-1-90-5	D2.131
	GS4EH	B1.111	H200X034H1T-B	E2.13	HLA21-1-90-5	D2.131
	GS4H	B1.111	H200X044H1T	E2.13	HLA4-1-90-X	D2.131
B2. Cable Accessories	GS4MT	B3.14	H200X044H1T-2	E2.15	HLA8-1-90-X	D2.131
	GTH	B1.111	H200X044H1T-2-B	E2.15	HLB2S-C0	B1.87
	GTS	B1.111	H200X044H1T-B	E2.13	HLB4-1-X	D2.130
	GTSL	B1.111	H200X064H1T	E2.13	HLM-15R0	B1.87
B3. Stainless Steel Ties	GU-13-3	D3.26	H200X064H1T-2	E2.15	HLS-15R0	B1.87
	GU-2-X	D3.26	H200X064H1T-2-B	E2.15	HLS-75R0	B1.87
	GU-4-X	D3.26	H200X064H1T-B	E2.13	HLS1.5S-X0	B1.87
	<b>GUBC500-6</b>	<b>D3.10</b>	H200X084H1T	E2.13	HLS-15R0	B1.87
			H200X084H1T-2	E2.15	HLS3S-X0	B1.87
			H200X084H1T-2-B	E2.15	HLS5S-X0	B1.87
			H200X084H2T	E2.13	HLS-75R0	B1.87
C1. Wiring Duct			H200X122H1T-2	E2.15	HLSP1.5S-X0	B1.88
	H000X025H1C	E1.8	H200X165H1T	E2.13	HLSP1.5S-X12	B1.88
	H000X025H2C	E1.8	H200X165H1T-2	E2.15	HLSP3S-X0	B1.88
	H000X034H1C	E1.8	H200X165H2T	E2.14	HLSP3S-X12	B1.88
C2. Surface Raceway	H000X034H2C	E1.8	H2L13-2N-2	D2.134	HLSP5S-X0	B1.88
	H000X044H1C	E1.8	H2L21-2N-2	D2.134	HLSP5S-X12	B1.88
	H000X044H2C	E1.8	H2L30-2N-1	D2.134	HLT2I-X0	B1.87
	H000X064H1C	E1.8	H2L4-2N-X	D2.134	HLT3I-X0	B1.87
	H000X064H2C	E1.8	H2L8-2N-2	D2.134	HLTP2I-X0	B1.88
C3. Abrasion Protection	H000X084H1C	E1.8	H2X2LG6	C1.11	HLTP2I-X12	B1.88
	H000X084H2C	E1.8	H2X3LG6	C1.11	HLTP3I-X0	B1.88
	H050X025H1T	E2.12	H2X4LG6	C1.11	HLTP3I-X12	B1.88
	H050X025H1T-B	E2.12	H3X3LG6	C1.11	<b>HLWM1.5S-X0</b>	<b>B1.91</b>
	H050X044H1T	E2.12	H3X4LG6	C1.11	<b>HLWM3S-X0</b>	<b>B1.91</b>
	H050X044H1T-B	E2.12	H4X4LG6	C1.11	HN1.5X2LG6	C1.11
C4. Cable Management	H050X064H1T	E2.12	HB2SP19-X	B2.51	HN1.5X3LG6	C1.11
	H050X064H1T-B	E2.12	HB2SP25-X	B2.51	HN2X2LG6	C1.11
	H075X025H1T	E2.12	HBN.75-T	B2.49	HN2X3LG6	C1.11
	H075X025H1T-B	E2.12	HBN1-T	B2.49	HN2X4LG6	C1.11
D1. Terminals	H075X034H1T	E2.12	HBN1.5-T	B2.49	HN3X3LG6	C1.11
	H075X044H1T	E2.12	HBN2-T	B2.49	HN3X4LG6	C1.11
	H1.5X2LG6	C1.11	HBN2.5-T	B2.49	HN4X4LG6	C1.11
	H1.5X3LG6	C1.11	HBN3-T	B2.49	HS1.5X2LG6NM	C1.11
	H100X025H1C	E1.9	HBN4-T	B2.49	HS1.5X3LG6NM	C1.11
D2. Power Connectors	H100X025H1T	E2.13	HBUA-X	B2.51	HS2X2LG6NM	C1.11
	H100X025H1T-2	E2.14	HC1.5LG6	C1.11	HS2X3LG6NM	C1.11
	H100X025H1T-2-B	E2.14	HC2LG6	C1.11	HS2X4LG6NM	C1.11
	H100X025H1T-B	E2.12	HC3LG6	C1.11	HS3X3LG6NM	C1.11
	H100X025H2C	E1.9	HC4LG6	C1.11	HS3X4LG6NM	C1.11
D3. Grounding Connectors	H100X034H1C	E1.9	HC13-3	D2.135	HS4X4LG6NM	C1.11
	H100X034H1T	E2.12	HC21-1	D2.135	HSC.25-L	B2.41
	H100X034H1T-2	E2.14	HC30-1	D2.135	HSC.25-L100	B2.41
	H100X034H1T-2-B	E2.14	HC4-3	D2.135	HSEC0.5-X	C3.39
	H100X034H1T-B	E2.14	HC5-1	D2.135	HSEC0.8-X	C3.39
E1. Labeling Systems	H100X034H2C	E1.9	HC8-3	D2.135	HSEC1.0-X	C3.39
	H100X044H1C	E1.9	HCME04Y09-C30	B2.45	HSEC1.5-5	C3.39
	H100X044H1T	E2.12	HCME06A12-C130	B2.45	HSEC2.0-5	C3.39
	H100X044H1T-2	E2.14	HCME06Y12-C30	B2.45	HSEC4.0-2	C3.39
	H100X044H1T-2-B	E2.14	HCMP06B12-C20	B2.44	HSECFR0.5-XY	C3.39
E2. Labels	H100X044H1T-B	E2.12	HCMP06C12-C20	B2.44	HSECFR0.8-XY	C3.39
	H100X044H2C	E1.9	HHL13-2N-5	D2.133	HSECFR1.0-XY	C3.39
	H100X064H1C	E1.9	HHL21-2N-5	D2.133	HSECFR1.5-5Y	C3.39
	H100X064H1T	E2.12	HHL30-22N-1	D2.133	HSECFR2.0-5Y	C3.39
	H100X064H1T-2	E2.14	HHL8-2N-X	D2.133	HSG-115V-650	C3.40
	H100X064H1T-2-B	E2.14	HKBS	C3.16	HSG-A1	C3.40, E2.15
	H100X064H1T-B	E2.12	HL1-2-25-X	D2.132	HSG-A2	C3.40, E2.15
	H100X064H2C	E1.9	HL1-25-X	D2.130	HSG-A4	C3.40, E2.15
	H100X084H1C	E1.9	HL13-1-5	D2.130	HSG-P1	C3.40, E2.15
	H100X084H1T	E2.13	HL13-2-5	D2.132	HSG-P2	C3.40, E2.15
	H100X084H1T-2	E2.14	HL13-2N-5	D2.133	HSG-P3	C3.40, E2.15
	H100X084H1T-2-B	E2.14	HL21-1-5	D2.130	HSG-P7	C3.40, E2.15
	H100X084H2C	E1.9	HL21-2-5	D2.132	HST0.4-3-Q2Y	C3.38
E3. Pre-Printed & Write-On Markers	H100X084H1T-B	E2.12	HL21-2N-5	D2.133	HST0.4-3-QY	C3.38
	H100X084H2C	E1.9	HL30-1-2	D2.130	HST0.4-48-5-2Y	C3.38
	H100X084H1T	E2.13	HL30-2-2	D2.132	HST0.4-48-5Y	C3.38
	H100X084H1T-2	E2.14	HL30-2N-2	D2.133	HST0.4-6-3Y	C3.38
	H100X084H1T-2-B	E2.14	HL4-1-X	D2.130	HST0.4-6-X2Y	C3.38
	H100X084H2C	E1.9	HL4-2-X	D2.132	HST0.4-6-XY	C3.38
E4. Permanent Identification	H100X084H1T	E2.13	HL50-1-2	D2.130	HST0.8-12-5-2Y	C3.38
	H100X084H1T-2	E2.14	HL50-2-2	D2.132	HST0.8-12-5Y	C3.38
	H100X084H1T-2-B	E2.14				
	H100X084H2C	E1.9				
	H100X122H1T-2	E2.14				
E5. Lockout/Tagout & Safety Solutions	H100X165H1T	E2.13				
	H100X165H1T-2	E2.14				
	H150X025H1T	E2.14				
	H150X034H1T	E2.13				
	H150X044H1T	E2.14				
	H200X025H1T	E2.13				
	H100X165H1T-2	E2.14				
	H200X025H1T-2-B	E2.15				
F. Index						

Part Number	Page Number	Part Number	Page Number	Part Number	Page Number
HST0.8-48-5-2Y	C3.38	HSTT25-48-Q	C3.24	HSTTN38-CY	C3.33
HST0.8-48-5Y	C3.38	HSTT25-48-TL	C3.24	HSTTN50-CY	C3.33
HST0.8-6-3Y	C3.38	HSTT25-C	C3.24	HSTTN63-CY	C3.33
HST0.8-6-X2Y	C3.38	HSTT25-D	C3.24	HSTTN75-CY	C3.33
HST0.8-6-XY	C3.38	HSTT25-Q	C3.25	HSTTN88-CY	C3.33
HST0.8-9-X2Y	C3.38	HSTT25-Y	C3.26	HSTTP05-CY	C3.32
HST0.8-9-XY	C3.38	HSTT25-YK1	C3.26	HSTTP05-MY	C3.32
HST1.1-12-5-2Y	C3.38	HSTT300-48-2	C3.25	HSTTP05-QY	C3.32
HST1.1-12-5Y	C3.38	HSTT300-L	C3.25	HSTTP06-CY	C3.32
HST1.1-48-5-2Y	C3.38	HSTT38-48-Q	C3.24	HSTTP06-MY	C3.32
HST1.1-48-5Y	C3.38	HSTT38-48-TL	C3.24	HSTTP06-QY	C3.32
HST1.1-6-3Y	C3.38	HSTT38-C	C3.24	HSTTP09-CY	C3.32
HST1.1-6-X2Y	C3.38	HSTT38-Q	C3.25	HSTTP09-MY	C3.32
HST1.1-6-XY	C3.38	HSTT38-T	C3.24	HSTTP09-QY	C3.32
HST1.1-9-2Y	C3.38	HSTT38-Y	C3.26	HSTTP100-CY	C3.32
HST1.1-9-X2Y	C3.38	HSTT38-YK1	C3.26	HSTTP100-QY	C3.32
HST1.1-9-XY	C3.38	HSTT4A125-48-5	C3.37	HSTTP12-CY	C3.32
HST1.5-12-1Y	C3.38	HSTT4A15-48-Q	C3.37	HSTTP12-MY	C3.32
HST1.5-12-5Y	C3.38	HSTT4A200-48-5	C3.37	HSTTP12-QY	C3.32
HST1.5-48-5-2Y	C3.38	HSTT4A31-48-Q	C3.37	HSTTP150-CY	C3.32
HST1.5-48-5Y	C3.38	HSTT4A47-48-Q	C3.37	HSTTP150-QY	C3.32
HST1.5-9-XY	C3.38	HSTT4A62-48-5	C3.37	HSTTP19-CY	C3.32
HST2.0-12-2Y	C3.38	HSTT4A94-48-5	C3.37	HSTTP19-MY	C3.32
HST2.0-48-2Y	C3.38	HSTT400-48-2	C3.25	HSTTP19-QY	C3.32
HST2.0-9-5Y	C3.38	HSTT400-L	C3.25	HSTTP200-QY	C3.32
HST2.7-12-2Y	C3.38	HSTT50-48-5	C3.25	HSTTP25-CY	C3.32
HST2.7-48-2Y	C3.38	HSTT50-48-Q	C3.25	HSTTP25-DY	C3.32
HST3.0-12-2	C3.38	HSTT50-48-T	C3.25	HSTTP25-QY	C3.32
HST3.0-48-2	C3.38	HSTT50-C	C3.25	HSTTP38-CY	C3.32
HST3.5-12-2Y	C3.38	HSTT50-Q	C3.25	HSTTP38-QY	C3.32
HST3.5-48-2Y	C3.38	HSTT50-T	C3.25	HSTTP38-TY	C3.32
HSTT-YK1	C3.27	HSTT50-Y	C3.26	HSTTP50-CY	C3.32
HSTT-YK1-45	C3.27	HSTT50-YK1	C3.26	HSTTP50-QY	C3.32
HSTT-YK2	C3.27	HSTT75-48-5	C3.25	HSTTP75-CY	C3.32
HSTT-YK2-45	C3.27	HSTT75-48-CQ	C3.25	HSTTP75-QY	C3.32
HSTT05-48-Q	C3.24	HSTT75-C	C3.25	HSTTPN100-775-Q	C3.33
HSTT05-48-TL	C3.24	HSTT75-Q	C3.25	HSTTPN100-CC	C3.33
HSTT05-C	C3.24	HSTT75-T	C3.25	HSTTPN150-925-X	C3.33
HSTT05-M	C3.24	HSTT75-Y	C3.26	HSTTPN150-CC	C3.33
HSTT05-Q	C3.25	HSTT75-YK1	C3.26	HSTTPN200-950-X	C3.33
HSTT06-48-Q	C3.24	HSTTA100-48-5	C3.36	HSTTPN200-CC	C3.33
HSTT06-48-TL	C3.24	HSTTA100-48-L	C3.36	HSTTPN50-438-L	C3.33
HSTT06-C	C3.24	HSTTA100-Y	C3.36	HSTTPN50-713-Q	C3.33
HSTT06-M	C3.24	HSTTA150-48-5	C3.36	HSTTPN50-CC	C3.33
HSTT06-Q	C3.25	HSTTA150-48-Q	C3.36	HSTTPN62-750-Q	C3.33
HSTT06-Y	C3.26	HSTTA150-Y	C3.36	HSTTPN62-CC	C3.33
HSTT06-YK1	C3.26	HSTTA19-48-Q	C3.36	HSTTPN75-775-Q	C3.33
HSTT09-48-Q	C3.24	HSTTA19-Y	C3.36	HSTTPN75-CC	C3.33
HSTT09-48-TL	C3.24	HSTTA25-48-Q	C3.36	HSTTRA100-48-5	C3.37
HSTT09-C	C3.24	HSTTA25-48-TL	C3.36	HSTTRA12-48-Q	C3.37
HSTT09-M	C3.24	HSTTA25-Y	C3.36	HSTTRA19-48-Q	C3.37
HSTT09-Q	C3.25	HSTTA38-48-Q	C3.36	HSTTRA25-48-Q	C3.37
HSTT09-Y	C3.26	HSTTA38-48-TL	C3.36	HSTTRA38-48-Q	C3.37
HSTT09-YK1	C3.26	HSTTA38-Y	C3.36	HSTTRA50-48-5	C3.37
HSTT100-48-5	C3.25	HSTTA50-48-5	C3.36	HSTTRA75-48-5	C3.37
HSTT100-48-LQ	C3.25	HSTTA50-48-T	C3.36	HSTTT03-48-Q	C3.34
HSTT100-C	C3.25	HSTTA50-Y	C3.36	HSTTT04-48-Q	C3.34
HSTT100-Y	C3.26	HSTTA75-48-5	C3.36	HSTTT046-48-Q	C3.34
HSTT100-YK1	C3.26	HSTTA75-48-C	C3.36	HSTTT05-48-Q	C3.34
HSTT12-48-Q	C3.24	HSTTA75-Y	C3.36	HSTTT055-48-Q	C3.34
HSTT12-48-TL	C3.24	HSTTK05-48-Q	C3.35	HSTTT06-48-Q	C3.34
HSTT12-C	C3.24	HSTTK06-48-Q	C3.35	HSTTT08-48-Q	C3.34
HSTT12-M	C3.24	HSTTK09-48-Q	C3.35	HSTTT09-48-Q	C3.34
HSTT12-Q	C3.25	HSTTK100-48-5	C3.35	HSTTT112-48-5	C3.34
HSTT12-Y	C3.26	HSTTK12-48-Q	C3.35	HSTTT12-48-Q	C3.34
HSTT12-YK1	C3.26	HSTTK19-48-Q	C3.35	HSTTT131-48-2	C3.34
HSTT150-48-5	C3.25	HSTTK25-48-Q	C3.35	HSTTT15-48-Q	C3.34
HSTT150-C	C3.25	HSTTK38-48-Q	C3.35	HSTTT150-48-2	C3.34
HSTT19-48-Q	C3.24	HSTTK50-48-5	C3.35	HSTTT19-48-Q	C3.34
HSTT19-48-TL	C3.24	HSTTK75-48-5	C3.35	HSTTT24-48-Q	C3.34
HSTT19-C	C3.24	HSTTN100-CY	C3.33	HSTTT30-48-Q	C3.34
HSTT19-M	C3.24	HSTTN125-CY	C3.33	HSTTT37-48-Q	C3.34
HSTT19-Q	C3.25	HSTTN150-CY	C3.33	HSTTT43-48-Q	C3.34
HSTT19-Y	C3.26	HSTTN175-CY	C3.33	HSTTT47-48-Q	C3.34
HSTT19-YK1	C3.26	HSTTN200-QY	C3.33	HSTTT56-48-5	C3.34
HSTT200-48-5	C3.25	HSTTN25-CY	C3.33	HSTTT66-48-5	C3.34
HSTT200-L	C3.25	HSTTN300-QY	C3.33	HSTTT75-48-5	C3.34

A.  
System  
Overview

B1.  
Cable Ties

B2.  
Cable  
Accessories

B3.  
Stainless  
Steel Ties

C1.  
Wiring  
Duct

C2.  
Surface  
Raceway

C3.  
Abrasion  
Protection

C4.  
Cable  
Management

D1.  
Terminals

D2.  
Power  
Connectors

D3.  
Grounding  
Connectors

E1.  
Labeling  
Systems

E2.  
Labels

E3.  
Pre-Printed  
& Write-On  
Markers

E4.  
Permanent  
Identification

E5.  
Lockout/  
Tagout  
& Safety  
Solutions

F.  
Index

# PANDUIT® ELECTRICAL SOLUTIONS

A. System Overview	Part Number	Page Number	Part Number	Page Number	Part Number	Page Number
B1. Cable Ties	HSTTV93-48-5	C3.34	HSTTV50-T	C3.30	HVMPM32-C0	B2.21, B1.62
	HSTTV05-48-Q	C3.28	HSTTV50-T2	C3.30	HVTM-06-C0	B2.11
B2. Cable Accessories	HSTTV05-48-TL	C3.28	HSTTV50-T4	C3.30	HVTM3S10-C0	B1.62
	HSTTV05-C	C3.29	HSTTV50-T6	C3.30	HWS2819-C	B2.43
	HSTTV05-M	C3.30	HSTTV50-Y	C3.31	<b>I</b>	
	HSTTV05-M2	C3.30	HSTTV75-48-5	C3.28	ICF10IW-X	C2.79
	HSTTV05-M4	C3.30	HSTTV75-48-CQ	C3.28	ICF3IW-E	C2.79
	HSTTV05-M6	C3.30	HSTTV75-C	C3.29	ICF5IW-E	C2.79
	HSTTV05-Q	C3.31	HSTTV75-Q	C3.31	ICFC10IW-X	C2.80
	HSTTV05-Y	C3.31	HSTTV75-T	C3.30	ICFC3IW-X	C2.80
	HSTTV06-48-Q	C3.28	HSTTV75-T2	C3.30	ICFC5IW-X	C2.80
	HSTTV06-48-TL	C3.28	HSTTV75-T4	C3.30	ICFX10IW-X	C2.75, C2.81
B3. Stainless Steel Ties	HSTTV06-C	C3.29	HSTTV75-T6	C3.30	ICFX3IW-X	C2.81
	HSTTV06-M	C3.30	HSTTV75-Y	C3.31	ICFX5IW-X	C2.81
C1. Wiring Duct	HSTTV06-M2	C3.30	HSTTV100-48-5	C3.35	ILT2S-C	B1.61
	HSTTV06-M4	C3.30	HSTTV100-Y	C3.36	ILT2S-C0	B1.61
	HSTTV06-M6	C3.30	HSTTV12-48-Q	C3.35	ILT3S-C	B1.61
	HSTTV06-Q	C3.31	HSTTV12-Y	C3.36	ILT3S-C0	B1.61
	HSTTV06-Y	C3.31	HSTTV150-48-5	C3.35	ILT4LH-TL	B1.61
	HSTTV09-48-Q	C3.28	HSTTV19-48-Q	C3.35	ILT4LH-TL0	B1.61
	HSTTV09-48-TL	C3.28	HSTTV19-Y	C3.36	ILT4S-C	B1.61
	HSTTV09-C	C3.29	HSTTV25-48-Q	C3.35	ILT4S-C0	B1.61
	HSTTV09-M	C3.30	HSTTV25-Y	C3.36	ILT6LH-C	B1.61
	HSTTV09-M2	C3.30	HSTTV38-48-Q	C3.35	ILT6LH-C0	B1.61
C2. Surface Raceway	HSTTV09-M4	C3.30	HSTTV38-Y	C3.36	IT9100-C0	B1.63
	HSTTV09-M6	C3.30	HSTTV50-48-5	C3.35	IT9100-CUV16B	B1.63
	HSTTV09-Q	C3.31	HSTTV50-Y	C3.36	IT9100-CUV2	B1.63
	HSTTV09-Y	C3.31	HSTTV75-48-5	C3.35	IT9100-CUV4Y	B1.63
	HSTTV100-48-5	C3.28	HSTTV75-Y	C3.36	IT9100-CUV6	B1.63
	HSTTV100-48-LQ	C3.28	HT2-BLU	E5.33	IT9100-CUV6A	B1.63
	HSTTV100-C	C3.29	HT2-GRN	E5.33	IT9100-CUV7A	B1.63
	HSTTV100-C5	C3.29	HT2-ORN	E5.33	IT9100-CUV8	B1.63
	HSTTV100-Q	C3.31	HT2-RED	E5.33	IT9115-C0	B1.63
	HSTTV100-T2	C3.30	HT2-WHT	E5.33	IT9115-CUV11	B1.63
C3. Abrasion Protection	HSTTV100-Y	C3.31	HT2-YEL	E5.33	IT9115-CUV16B	B1.63
	HSTTV12-48-Q	C3.28	HT2S-BLK-YEL	E5.33	IT9115-CUV18	B1.63
	HSTTV12-48-TL	C3.28	HT2S-RED-WHT	E5.33	IT9115-CUV2	B1.63
	HSTTV12-C	C3.29	HT3S-BLK-YEL	E5.33	IT9115-CUV2A	B1.63
	HSTTV12-M	C3.30	HT3S-RED-WHT	E5.33	IT9115-CUV4A	B1.63
	HSTTV12-M2	C3.30	HTB3-C-M	E5.36	IT9115-CUV4Y	B1.63
	HSTTV12-M4	C3.30	HTB3-DNE-M	E5.36	IT9115-CUV5A	B1.63
	HSTTV12-M6	C3.30	HTB3-HV-M	E5.36	IT9115-CUV5B	B1.63
	HSTTV12-Q	C3.31	HTCT2-2-1	D3.14	IT9115-CUV6	B1.63
	HSTTV12-Y	C3.31	HTCT250-2-1	D3.14	IT9115-CUV6A	B1.63
C4. Cable Management	HSTTV150-48-5	C3.28	HTCT250-250-1	D3.14	IT9115-CUV6B	B1.63
	HSTTV150-C	C3.29	HTCT6X-6X-1	D3.14	IT9115-CUV7A	B1.63
	HSTTV19-48-Q	C3.28	HTDU2B-W	E5.35	IT9115-CUV8	B1.63
	HSTTV19-48-TL	C3.28	HTDU20-FO	E5.35	IT940-C0	B1.63
	HSTTV19-C	C3.29	HTDU20-T	E5.35	IT965-C0	B1.63
	HSTTV19-M	C3.30	HTDU2R-E	E5.35	<b>J</b>	
	HSTTV19-M2	C3.30	HTDU30-FO	E5.35	J214-312-T	D1.68
	HSTTV19-M4	C3.30	HTDU30-T	E5.35	J216-410-L	D1.68
	HSTTV19-M6	C3.30	HTDU3R-E	E5.35	J318-412-T	D1.68
	HSTTV19-Q	C3.31	HTDU6O-FO	E5.35	JB1DIW-A	C2.57
D1. Terminals	HSTTV19-Y	C3.31	HTDU6O-T	E5.35	JB1FSIW-A	C2.52, C2.57
	HSTTV25-48-Q	C3.28	HTDU6R-E	E5.35	JB1IW-A	C2.57
	HSTTV25-48-TL	C3.28	HTMT	B3.15	JBA-X	C2.57
	HSTTV25-C	C3.29	HTU3G-TM	E5.35	JBD1	C2.59
	HSTTV25-D	C3.30	HTU30-FO-M	E5.35	JBD2	C2.59
	HSTTV25-D2	C3.30	HTU30-TM	E5.35	JBP1DIW	C2.58
	HSTTV25-D4	C3.30	HTU3R-E-M	E5.35	JBP1EIW	C2.58
	HSTTV25-D6	C3.30	HTU3Y-E-M	E5.35	JBP1FSIW	C2.52, C2.59
	HSTTV25-Q	C3.31	HTU6O-FO	E5.35	JBP1IIW	C2.58
	HSTTV25-Y	C3.31	HTU6O-T	E5.35	JBP1IW	C2.58
D2. Power Connectors	HSTTV38-48-Q	C3.28	HTU6O-TV	E5.35	JBP1MD20IW	C2.59, C2.61
	HSTTV38-48-TL	C3.28	HTU6R-E	E5.35	JBP1MR20IW	C2.59, C2.61
	HSTTV38-C	C3.29	HTU6Y-E	E5.35	JBP2DIW	C2.57, C2.58
	HSTTV38-Q	C3.31	HTU6Y-G	E5.35	JBP2FSIW	C2.52, C2.59
	HSTTV38-T	C3.30	HTWC2-2-1	D3.15	JBP2IW	C2.57, C2.58
	HSTTV38-T2	C3.30	HTWC250-2-1	D3.15	JBP2SIW	C2.59
	HSTTV38-T4	C3.30	HTWC250-250-1	D3.15	JBX3510IW-A	C2.57
	HSTTV38-T6	C3.30	HTWC6X-6X-1	D3.15	JMCB-X	C4.8
	HSTTV38-Y	C3.31	HV9100-C	B1.64	JMCMB25-1-X	C4.8
	HSTTV50-48-Q	C3.28	HV9100-C0	B1.62		
D3. Grounding Connectors	HSTTV50-48-T	C3.28	HV9150-C0	B1.62		
	HSTTV50-C	C3.29	HV9250-C0	B1.62		
	HSTTV50-Q	C3.31	HV965-C0	B1.62		
E1. Labeling Systems						
E2. Labels						
E3. Pre-Printed & Write-On Markers						
E4. Permanent Identification						
E5. Lockout/Tagout & Safety Solutions						
F. Index						



# PANDUIT® ELECTRICAL SOLUTIONS

Part Number	Page Number
JMCMB25-3-X	C4.8
JMDWB-1-X	C4.8
JMDWB-3-X	C4.8
JMJH2-X20	C4.8
JMJH2W-X20	C4.8
JMN2-C	D1.69
JMN6-C	D1.69
JMSBCB87-1-X	C4.8
JMSBCB87-3-X	C4.8
JMTRB38-1-X	C4.8
JMTRB38-3-X	C4.8
JN218-216-C	D1.67
JN224-318-C	D1.67
JN314-412-C	D1.67
JN418-212-C	D1.67
JP131CM-L20	C4.4
JP131CP-L20	C4.6
JP131DW-L20	C4.4
JP131HBC25R-L20	C4.5
JP131HBC50R-L20	C4.5
JP131HBC75R-L20	C4.5
JP131SBC50-L20	C4.5
JP131SBC50R-L20	C4.5
JP131SBC87-L20	C4.5
JP131SBC87R-L20	C4.5
JP131UF100-L20	C4.6
JP131W-L20	C4.4
JP131WP-L20	C4.4
JP131ZP-L20	C4.6
JP2CM-L20	C4.4
JP2CP-L20	C4.6
JP2DW-L20	C4.4
JP2HBC25R-L20	C4.5
JP2HBC50R-L20	C4.5
JP2HBC75R-L20	C4.5
JP2SBC50-L20	C4.5
JP2SBC50R-L20	C4.5
JP2SBC87-L20	C4.5
JP2SBC87R-L20	C4.5
JP2UF100-L20	C4.6
JP2W-L20	C4.4
JP2WP-L20	C4.4
JP2ZP-L20	C4.6
JP4CM-X20	C4.4
JP4CP-X20	C4.6
JP4HBC25R-X20	C4.5
JP4HBC50R-X20	C4.5
JP4HBC75R-X20	C4.5
JP4SBC50-X20	C4.5
JP4SBC50R-X20	C4.5
JP4SBC87-X20	C4.5
JP4SBC87R-X20	C4.5
JP4UF100-X20	C4.6
JP4W-X20	C4.4
JP4WP-X20	C4.4
JP4ZP-X20	C4.6
JP75CM-L20	C4.4
JP75CP-L20	C4.6
JP75DW-L20	C4.4
JP75HBC25R-L20	C4.5
JP75HBC50R-L20	C4.5
JP75HBC75R-L20	C4.5
JP75SBC50-L20	C4.5
JP75SBC50R-L20	C4.5
JP75SBC87-L20	C4.5
JP75SBC87R-L20	C4.5
JP75UF100-L20	C4.6
JP75W-L20	C4.4
JP75WP-L20	C4.4
JP75ZP-L20	C4.6
<b>K</b>	
K-1000	D1.37
K-1001	D1.37
K-1100	D1.37
K-1102Y	D1.37

Part Number	Page Number
K-1103Y	D1.37
K-1104	D1.37
K-205	B1.83, D1.38
K-504	B1.83
K1-PNKIT	D1.38
K2-BLD2	B1.114
K2-PVKITY	D1.37, D1.38
K4EH-BLD	B1.114
K4H-BLD	B1.114
K4M-BLD	B3.14
K4MTG	B3.14
K600-A	D1.86
K6-8R-T	D1.12
KB-550	B1.84
KB-551	B1.84
<b>KF-1005</b>	<b>D1.36</b>
KGTHBLD	B1.114
KGTHSLV	B1.114
KGHTL	B1.114
KGTSBLD	B1.114
KGTSLLV	B1.114
KGSTL	B1.114
KH-1-L	D3.27
KH-2-L	D3.27
KIMS-H366-C2	B2.14
KIMS-H430-C6	B2.14
KIMS-H500-C4	B2.14
KLM14-250Y	D2.147
KLM350-800Y	D2.147
KLM6-250Y	D2.147
KLM6-600Y	D2.147
KLM6-800Y	D2.147
KLS-0-Q	D3.27
KLS-1-Q	D3.27
KLS-1A-X	D3.27
KMTRTH	B3.20
KMTRTLS	B3.20
KP-1000	D1.36
KP-1075Y	D1.36
KP-1165Y	D1.36
KP-1166	D1.36
KP-506A	B1.84
KP-506A-0	B1.84
KP-509	B1.84
KP-F1	D1.78
KP-F2	D1.78
KP-FSD1	D1.78
KP-FSD2	D1.78
KP-FSD3	D1.78
KP-HSTT1	C3.40
KP-HSTT2	C3.40
KP-HSTTA	C3.40
KP1-C	D3.26
KP2-L	D3.26
KPPTMTB	B3.16
KPPTMTG	B3.16
KPTHBLD	B1.114
KPTSTL	B1.114
KRT2BLD	B3.26
KRT2HNDL	B3.26
<b>L</b>	
LAA1-14-X	D2.112
LAA1-38-X	D2.112
LAA1-56-X	D2.112
LAA1/0-12-X	D2.112
LAA1/0-38-X	D2.112
LAA1/0-56-X	D2.112
LAA1000-58-1	D2.112
LAA2-14-X	D2.112
LAA2-38-X	D2.112
LAA2-56-X	D2.112
LAA2/0-12-5	D2.112
LAA2/0-38-5	D2.112
LAA250-12-5	D2.112
LAA250-38-5	D2.112

Part Number	Page Number
LAA3/0-12-5	D2.112
LAA3/0-38-5	D2.112
LAA300-12-2	D2.112
LAA300-38-2	D2.112
LAA350-12-2	D2.112
LAA4-14-X	D2.112
LAA4-38-X	D2.112
LAA4-56-X	D2.112
LAA4/0-12-5	D2.112
LAA4/0-38-5	D2.112
LAA400-58-2	D2.112
LAA500-12-2	D2.112
LAA500-58-2	D2.112
LAA6-14-X	D2.112
LAA6-56-X	D2.112
LAA750-58-1	D2.112
LAB1/0-38-X	D2.113
LAB1000-12-1	D2.113
LAB2/0-12-5	D2.113
LAB250-12-5	D2.113
LAB3/0-12-5	D2.113
LAB300-12-2	D2.113
LAB350-12-2	D2.113
LAB4/0-12-5	D2.113
LAB400-12-2	D2.113
LAB500-12-2	D2.113
LAB600-12-2	D2.113
LAB750-12-1	D2.113
LAB800-12-1	D2.113
LAM2A1/0-14-6Y	D2.142
LAM2A1000-58-6Y	D2.142
LAM2A2/0-14-6Y	D2.142
LAM2A250-38-6Y	D2.142
LAM2A350-12-6Y	D2.142
LAM2A600-12-6Y	D2.142
LAM2B350-12-3Y	D2.143
LAM2B600-12-3	D2.143
LAM2LB1000-12-3	D2.143
LAM2LB600-12-3	D3.143
LAM2SA300-56-3	D2.143
LAM2SB600-38-1Y	D2.144
LAM2SB750-38-1Y	D2.144
LAM2SSB500-141Y	D2.144
LAM3B1/0-38-6Y	D2.144
LAM3B250-12-1Y	D2.144
LAM3B3/0-12-3Y	D2.144
LAM3B350-12-1Y	D2.144
LAM3D250-12-1Y	D2.145
LAM3D3/0-12-3Y	D2.145
LAM3D350-12-1Y	D2.145
LAM3LB600-12-1	D2.144
LAM3LB1000-121Y	D2.144
LAM3LD1000-121Y	D2.145
LAM3LD600-12-1	D2.145
LAM4LD1000-12-1	D2.146
LAM4D250-12-1Y	D2.146
LAM4D350-12-1Y	D2.146
LAM4LD600-12-1	D2.146
LAM4SB600-38-1Y	D2.146
LAM4SB750-38-1Y	D2.146
LAMA1/0-14-QY	D2.141
LAMA1/0-56-Q	D2.141
LAMA1000-58-6Y	D2.141
LAMA2-14-QY	D2.141
LAMA2/0-14-QY	D2.141
LAMA250-56-QY	D2.141
LAMA300-56-QY	D2.141
LAMA350-38-QY	D2.141
LAMA500-38-6Y	D2.141
LAMA6-14-QY	D2.141
LAMA600-38-6Y	D2.141
LAMA600S-38-6Y	D2.141
LAMB350-12-6Y	D2.142
LAMB600-12-3Y	D2.142
LAMLB1000-12-3	D2.142
LC10-A-L8	B2.37
LC3-A-C8	B2.37

A. System Overview
B1. Cable Ties
B2. Cable Accessories
B3. Stainless Steel Ties
C1. Wiring Duct
C2. Surface Raceway
C3. Abrasion Protection
C4. Cable Management
D1. Terminals
D2. Power Connectors
D3. Grounding Connectors
E1. Labeling Systems
E2. Labels
E3. Pre-Printed & Write-On Markers
E4. Permanent Identification
E5. Lockout/Tagout & Safety Solutions
F. Index

# PANDUIT® ELECTRICAL SOLUTIONS

A. System Overview	Part Number	Page Number	Part Number	Page Number	Part Number	Page Number
B1. Cable Ties	LC5-A-C8	B2.37	LCA3/0-14F-X	D2.18	LCA400-78H-6	D2.16
	LCA1-00-E	D2.21	LCA3/0-14H-X	D2.16	LCA500-00-6	D2.21
	LCA1-12-E	D2.13	LCA3/0-38-X	D2.14	LCA500-1-6	D2.14
	LCA1-12F-E	D2.18	LCA3/0-38F-X	D2.18	LCA500-12-6	D2.14
B2. Cable Accessories	LCA1-12H-E	D2.16	LCA3/0-38H-X	D2.16	LCA500-12F-6	D2.18
	LCA1-14-E	D2.13	LCA3/0-56-X	D2.14	LCA500-12H-6	D2.16
	LCA1-14F-E	D2.18	LCA3/0-56F-X	D2.18	LCA500-1F-6	D2.18
	LCA1-14H-E	D2.16	LCA3/0-56H-X	D2.16	LCA500-1H-6	D2.16
B3. Stainless Steel Ties	LCA1-38-E	D2.13	LCA300-00-X	D2.21	LCA500-34-6	D2.14
	LCA1-38F-E	D2.18	LCA300-12-X	D2.14	LCA500-34F-6	D2.18
	LCA1-38H-E	D2.16	LCA300-12F-X	D2.18	LCA500-34H-6	D2.16
	LCA1-56-E	D2.13	LCA300-12H-X	D2.16	LCA500-38-6	D2.14
C1. Wiring Duct	LCA1-56F-E	D2.18	LCA300-38-X	D2.14	LCA500-38F-6	D2.18
	LCA1-56H-E	D2.16	LCA300-38F-X	D2.18	LCA500-38H-6	D2.16
	LCA1/0-00-X	D2.21	LCA300-38H-X	D2.16	LCA500-58-6	D2.14
	LCA1/0-12-X	D2.14	LCA300-56-X	D2.14	LCA500-58F-6	D2.18
C2. Surface Raceway	LCA1/0-12F-X	D2.18	LCA300-56F-X	D2.18	LCA500-58H-6	D2.16
	LCA1/0-12H-X	D2.16	LCA300-56H-X	D2.16	LCA500-78-6	D2.14
	LCA1/0-14-X	D2.14	LCA300-58-X	D2.14	LCA500-78F-6	D2.18
	LCA1/0-14F-X	D2.17	LCA300-58F-X	D2.18	LCA500-78H-6	D2.16
C3. Abrasion Protection	LCA1/0-14H-X	D2.16	LCA300-58H-X	D2.16	LCA6-00-L	D2.21
	LCA1/0-38-X	D2.14	LCA300-78-X	D2.14	LCA6-10-L	D2.13
	LCA1/0-38F-X	D2.18	LCA300-78F-X	D2.18	LCA6-10F-L	D2.17
	LCA1/0-38H-X	D2.16	LCA300-78H-X	D2.16	LCA6-10H-L	D2.15
C4. Cable Management	LCA1/0-56-X	D2.14	LCA350-00-X	D2.21	LCA6-12-L	D2.13
	LCA1/0-56F-X	D2.18	LCA350-12-X	D2.14	LCA6-14-L	D2.13
	LCA1/0-56H-X	D2.16	LCA350-12F-X	D2.18	LCA6-14F-L	D2.17
	LCA10-10-L	D2.13	LCA350-12H-X	D2.16	LCA6-14H-L	D2.15
D1. Terminals	LCA10-14-L	D2.13	LCA350-38-X	D2.14	LCA6-38-L	D2.13
	LCA10-14F-L	D2.15	LCA350-38F-X	D2.18	LCA6-38F-L	D2.17
	LCA10-14H-L	D2.15	LCA350-38H-X	D2.16	LCA6-38H-L	D2.15
	LCA10-38-L	D2.13	LCA350-58-X	D2.14	LCA6-56-L	D2.13
D2. Power Connectors	LCA10-56-L	D2.13	LCA350-58F-X	D2.18	LCA6-56F-L	D2.17
	LCA2-00-Q	D2.21	LCA350-58H-X	D2.16	LCA6-56H-L	D2.15
	LCA2-12-Q	D2.13	LCA350-78-X	D2.14	LCA600-00-6	D2.21
	LCA2-12F-Q	D2.17	LCA350-78F-X	D2.18	LCA600-12-6	D2.14
D3. Grounding Connectors	LCA2-12H-Q	D2.15	LCA350-78H-X	D2.16	LCA600-12F-6	D2.18
	LCA2-14-Q	D2.13	LCA4-00-L	D2.21	LCA600-12H-6	D2.16
	LCA2-14F-Q	D2.17	LCA4-10-L	D2.13	LCA600-58-6	D2.14
	LCA2-14H-Q	D2.15	LCA4-10F-L	D2.17	LCA600-58F-6	D2.18
E1. Labeling Systems	LCA2-38-Q	D2.13	LCA4-10H-L	D2.15	LCA600-58H-6	D2.16
	LCA2-38F-Q	D2.17	LCA4-12-L	D2.13	LCA600-78-6	D2.14
	LCA2-38H-Q	D2.15	LCA4-12F-L	D2.17	LCA600-78F-6	D2.18
	LCA2-56-Q	D2.13	LCA4-14-L	D2.13	LCA600-78H-6	D2.16
E2. Labels	LCA2-56F-Q	D2.17	LCA4-14F-L	D2.17	LCA750-58-6	D2.14
	LCA2-56H-Q	D2.15	LCA4-14H-L	D2.15	LCA8-00-L	D2.21
	LCA2/0-00-X	D2.21	LCA4-38-L	D2.13	LCA8-10-L	D2.13
	LCA2/0-12-X	D2.14	LCA4-38F-L	D2.17	LCA8-10F-L	D2.17
E3. Pre-Printed & Write-On Markers	LCA2/0-12F-X	D2.18	LCA4-38H-L	D2.15	LCA8-10H-L	D2.15
	LCA2/0-12H-X	D2.16	LCA4-56-L	D2.13	LCA8-14-L	D2.13
	LCA2/0-14-X	D2.14	LCA4-56F-L	D2.17	LCA8-14F-L	D2.17
	LCA2/0-14F-X	D2.18	LCA4-56H-L	D2.15	LCA8-14H-L	D2.15
E4. Permanent Identification	LCA2/0-14H-X	D2.16	LCA4/0-00-X	D2.21	LCA8-38-L	D2.13
	LCA2/0-34H-X	D2.16	LCA4/0-12-X	D2.14	LCA8-38F-L	D2.17
	LCA2/0-38-X	D2.14	LCA4/0-12F-X	D2.18	LCA8-38H-L	D2.15
	LCA2/0-38F-X	D2.18	LCA4/0-12H-X	D2.16	LCA8-56-L	D2.13
E5. Lockout/Tagout & Safety Solutions	LCA2/0-38H-X	D2.16	LCA4/0-14-X	D2.14	LCA8-56F-L	D2.17
	LCA2/0-56-X	D2.14	LCA4/0-14F-X	D2.18	LCA8-56H-L	D2.15
	LCA2/0-56F-X	D2.18	LCA4/0-14H-X	D2.16	LCAF1-12-X	D2.73
	LCA2/0-56H-X	D2.16	LCA4/0-38-X	D2.14	LCAF1-12F-X	D2.77
F. Index	LCA250-12-X	D2.14	LCA4/0-38F-X	D2.18	LCAF1-12H-X	D2.75
	LCA250-12F-X	D2.18	LCA4/0-38H-X	D2.16	LCAF1-14-X	D2.73
	LCA250-12H-X	D2.16	LCA4/0-56-X	D2.14	LCAF1-14F-X	D2.77
	LCA250-14-X	D2.14	LCA4/0-56F-X	D2.18	LCAF1-14H-X	D2.75
F1.14	LCA250-14F-X	D2.18	LCA400-00-6	D2.21	LCAF1-38-X	D2.73
	LCA250-14H-X	D2.16	LCA400-12-6	D2.14	LCAF1-38F-X	D2.77
	LCA250-38-X	D2.14	LCA400-12F-6	D2.18	LCAF1-38H-X	D2.75
	LCA250-38F-X	D2.18	LCA400-12H-6	D2.16	LCAF1-56-X	D2.73
F1.14	LCA250-38H-X	D2.16	LCA400-38-6	D2.14	LCAF1-56F-X	D2.77
	LCA250-56-X	D2.14	LCA400-38F-6	D2.18	LCAF1-56H-X	D2.75
	LCA250-56F-X	D2.18	LCA400-38H-6	D2.16	LCAF1/0-12-X	D2.73
	LCA250-56H-X	D2.16	LCA400-58-6	D2.14	LCAF1/0-12F-X	D2.77
F1.14	LCA3/0-00-X	D2.21	LCA400-58F-6	D2.18	LCAF1/0-12H-X	D2.75
	LCA3/0-12-X	D2.14	LCA400-58H-6	D2.16	LCAF1/0-14-X	D2.73
	LCA3/0-12F-X	D2.18	LCA400-78-6	D2.14	LCAF1/0-14F-X	D2.77
	LCA3/0-12H-X	D2.16	LCA400-78F-6	D2.18	LCAF1/0-14H-X	D2.75
F1.14	LCA3/0-14-X	D2.14			LCAF1/0-38-X	D2.73

Part Number	Page Number
LCAF1/0-38F-X	D2.77
LCAF1/0-38H-X	D2.75
LCAF1/0-56-X	D2.73
LCAF1/0-56F-X	D2.77
LCAF1/0-56H-X	D2.75
LCAF2-12-E	D2.73
LCAF2-12F-E	D2.77
LCAF2-12H-E	D2.75
LCAF2-14-E	D2.73
LCAF2-14F-E	D2.77
LCAF2-14H-E	D2.75
LCAF2-38-E	D2.73
LCAF2-38F-E	D2.77
LCAF2-38H-E	D2.75
LCAF2-56-E	D2.73
LCAF2-56F-E	D2.77
LCAF2-56H-E	D2.75
LCAF2/0-12-X	D2.74
LCAF2/0-12F-X	D2.78
LCAF2/0-12H-X	D2.75
LCAF2/0-14-X	D2.74
LCAF2/0-14F-X	D2.78
LCAF2/0-14H-X	D2.75
LCAF2/0-38-X	D2.74
LCAF2/0-38F-X	D2.78
LCAF2/0-38H-X	D2.75
LCAF2/0-56-X	D2.74
LCAF2/0-56F-X	D2.78
LCAF2/0-56H-X	D2.75
LCAF250-12-X	D2.74
LCAF250-12F-X	D2.78
LCAF250-12H-X	D2.76
LCAF250-38-X	D2.74
LCAF250-38F-X	D2.78
LCAF250-38H-X	D2.76
LCAF250-58-X	D2.74
LCAF250-58F-X	D2.78
LCAF250-58H-X	D2.76
LCAF250-78-X	D2.74
LCAF250-78F-X	D2.78
LCAF250-78H-X	D2.76
LCAF3/0-12-X	D2.74
LCAF3/0-12F-X	D2.78
LCAF3/0-12H-X	D2.76
LCAF3/0-14-X	D2.74
LCAF3/0-14F-X	D2.78
LCAF3/0-14H-X	D2.76
LCAF3/0-38-X	D2.74
LCAF3/0-38F-X	D2.78
LCAF3/0-38H-X	D2.76
LCAF3/0-56-X	D2.74
LCAF3/0-56F-X	D2.78
LCAF3/0-56H-X	D2.76
LCAF300-12-6	D2.74
LCAF300-12F-6	D2.78
LCAF300-12H-6	D2.76
LCAF300-38-6	D2.74
LCAF300-38F-6	D2.78
LCAF300-38H-6	D2.76
LCAF300-58-6	D2.74
LCAF300-58F-6	D2.78
LCAF300-58H-6	D2.76
LCAF300-78-6	D2.74
LCAF300-78F-6	D2.78
LCAF300-78H-6	D2.76
LCAF350-1-6	D2.74
LCAF350-12-6	D2.74
LCAF350-12F-6	D2.78
LCAF350-12H-6	D2.76
LCAF350-1F-6	D2.78
LCAF350-1H-6	D2.76
LCAF350-34-6	D2.74
LCAF350-34F-6	D2.78
LCAF350-34H-6	D2.76
LCAF350-38-6	D2.74
LCAF350-38F-6	D2.78
LCAF350-38H-6	D2.76

Part Number	Page Number
LCAF350-58-6	D2.74
LCAF350-58F-6	D2.78
LCAF350-58H-6	D2.76
LCAF350-78-6	D2.74
LCAF350-78F-6	D2.78
LCAF350-78H-6	D2.76
LCAF4-10-L	D2.73
LCAF4-10F-L	D2.77
LCAF4-10H-L	D2.75
LCAF4-14-L	D2.73
LCAF4-14F-L	D2.77
LCAF4-14H-L	D2.75
LCAF4-38-L	D2.73
LCAF4-38F-L	D2.77
LCAF4-38H-L	D2.75
LCAF4-56-L	D2.73
LCAF4-56F-L	D2.77
LCAF4-56H-L	D2.75
LCAF4/0-12-X	D2.74
LCAF4/0-12F-X	D2.78
LCAF4/0-12H-X	D2.76
LCAF4/0-14-X	D2.74
LCAF4/0-14F-X	D2.78
LCAF4/0-14H-X	D2.76
LCAF4/0-38-X	D2.74
LCAF4/0-38F-X	D2.78
LCAF4/0-38H-X	D2.76
LCAF4/0-56-X	D2.74
LCAF4/0-56F-X	D2.78
LCAF4/0-56H-X	D2.76
LCAF400-12-6	D2.74
LCAF400-12F-6	D2.78
LCAF400-12H-6	D2.76
LCAF400-58-6	D2.74
LCAF400-58F-6	D2.78
LCAF400-58H-6	D2.76
LCAF400-78-6	D2.74
LCAF400-78F-6	D2.78
LCAF400-78H-6	D2.76
LCAF500-12-6	D2.74
LCAF500-58-6	D2.74
LCAF6-10-L	D2.73
LCAF6-10F-L	D2.77
LCAF6-10H-L	D2.75
LCAF6-14-L	D2.73
LCAF6-14F-L	D2.77
LCAF6-14H-L	D2.75
LCAF6-38-L	D2.73
LCAF6-38F-L	D2.77
LCAF6-38H-L	D2.75
LCAF6-56-L	D2.73
LCAF6-56F-L	D2.77
LCAF6-56H-L	D2.75
LCAF600-12-6	D2.74
LCAF600-58-6	D2.74
LCAF750-12-3	D2.74
LCAF750-58-3	D2.74
LCAF8-10-L	D2.73
LCAF8-10F-L	D2.77
LCAF8-10H-L	D2.75
LCAF8-14-L	D2.73
LCAF8-14F-L	D2.77
LCAF8-14H-L	D2.75
LCAF8-38-L	D2.73
LCAF8-38F-L	D2.77
LCAF8-38H-L	D2.75
LCAF8-56-L	D2.73
LCAF8-56F-L	D2.77
LCAF8-56H-L	D2.75
LCAN1-10-E	D2.19
LCAN1-14-E	D2.19
LCAN1/0-10-X	D2.19
LCAN1/0-14-X	D2.19
LCAN1/0-56-X	D2.19
LCAN2-10-Q	D2.19
LCAN2-14-Q	D2.19
LCAN2/0-10-X	D2.19

Part Number	Page Number
LCAN2/0-14-X	D2.19
LCAN2/0-38-X	D2.19
LCAN2/0-56-X	D2.19
LCAN250-14-X	D2.20
LCAN250-38-X	D2.20
LCAN3/0-14-X	D2.19
LCAN3/0-38-X	D2.19
LCAN3/0-56-X	D2.19
LCAN300-14-X	D2.20
LCAN300-38-X	D2.20
LCAN350-12-X	D2.20
LCAN350-38-X	D2.20
LCAN4-10-L	D2.19
LCAN4-14-L	D2.19
LCAN4/0-14-X	D2.19
LCAN4/0-38-X	D2.19
LCAN4/0-56-X	D2.19
LCAN400-12-6	D2.20
LCAN400-38-6	D2.20
LCAN500-12-6	D2.20
LCAN500-38-6	D2.20
LCAN6-6-L	D2.19
LCAN600-12-6	D2.20
LCAN600-38-6	D2.20
LCAN750-12-6	D2.20
LCAN750-38-6	D2.20
LCAN750-58-6	D2.20
LCAN8-6-L	D2.19
LCAS1-12-E	D2.7
LCAS1-12F-E	D2.11
LCAS1-12H-E	D2.9
LCAS1-14-E	D2.7
LCAS1-14F-E	D2.11
LCAS1-14H-E	D2.9
LCAS1-38-E	D2.7
LCAS1-38F-E	D2.11
LCAS1-38H-E	D2.9
LCAS1-56-E	D2.7
LCAS1-56F-E	D2.11
LCAS1-56H-E	D2.9
LCAS1/0-12-X	D2.7
LCAS1/0-12F-X	D2.11
LCAS1/0-12H-X	D2.9
LCAS1/0-14-X	D2.7
LCAS1/0-14F-X	D2.11
LCAS1/0-14H-X	D2.9
LCAS1/0-38-X	D2.7
LCAS1/0-38F-X	D2.11
LCAS1/0-38H-X	D2.9
LCAS1/0-56-X	D2.7
LCAS1/0-56F-X	D2.11
LCAS1/0-56H-X	D2.9
LCAS2-12-Q	D2.7
LCAS2-12F-Q	D2.11
LCAS2-12H-Q	D2.9
LCAS2-14-Q	D2.7
LCAS2-14F-Q	D2.11
LCAS2-14H-Q	D2.9
LCAS2-38-Q	D2.7
LCAS2-38F-Q	D2.11
LCAS2-38H-Q	D2.9
LCAS2-56-Q	D2.7
LCAS2-56F-Q	D2.11
LCAS2/0-12-X	D2.7
LCAS2/0-12F-X	D2.11
LCAS2/0-12H-X	D2.9
LCAS2/0-14-X	D2.7
LCAS2/0-14F-X	D2.11
LCAS2/0-14H-X	D2.9
LCAS2/0-38-X	D2.7
LCAS2/0-38F-X	D2.11
LCAS2/0-38H-X	D2.9
LCAS2/0-56-X	D2.7
LCAS2/0-56F-X	D2.11
LCAS2/0-56H-X	D2.9
LCAS250-12-X	D2.8

A. System Overview
B1. Cable Ties
B2. Cable Accessories
B3. Stainless Steel Ties
C1. Wiring Duct
C2. Surface Raceway
C3. Abrasion Protection
C4. Cable Management
D1. Terminals
D2. Power Connectors
D3. Grounding Connectors
E1. Labeling Systems
E2. Labels
E3. Pre-Printed & Write-On Markers
E4. Permanent Identification
E5. Lockout/Tagout & Safety Solutions
F. Index

# PANDUIT® ELECTRICAL SOLUTIONS

A. System Overview	Part Number	Page Number	Part Number	Page Number	Part Number	Page Number
B1. Cable Ties	LCAS250-12F-X	D2.12	LCAX1-14-X	D2.66	LCAX3/0-12F-X	D2.71
	LCAS250-12H-X	D2.10	LCAX1-14F-X	D2.70	LCAX3/0-12H-X	D2.69
	LCAS250-14-X	D2.8	LCAX1-14H-X	D2.68	LCAX3/0-14-X	D2.67
B2. Cable Accessories	LCAS250-14F-X	D2.12	LCAX1-38-X	D2.66	LCAX3/0-14F-X	D2.71
	LCAS250-14H-X	D2.10	LCAX1-38F-X	D2.70	LCAX3/0-14H-X	D2.69
	LCAS250-38-X	D2.8	LCAX1-38H-X	D2.68	LCAX3/0-38-X	D2.67
	LCAS250-38F-X	D2.12	LCAX1-56-X	D2.66	LCAX3/0-38F-X	D2.71
	LCAS250-38H-X	D2.10	LCAX1-56F-X	D2.70	LCAX3/0-38H-X	D2.69
	LCAS250-56-X	D2.8	LCAX1-56H-X	D2.68	LCAX3/0-56-X	D2.67
B3. Stainless Steel Ties	LCAS250-56F-X	D2.12	LCAX1/0-12-X	D2.67	LCAX3/0-56F-X	D2.71
	LCAS250-56H-X	D2.10	LCAX1/0-12F-X	D2.70	LCAX3/0-56H-X	D2.69
	LCAS3/0-12-X	D2.8	LCAX1/0-12H-X	D2.68	LCAX3/0-58-X	D2.67
	LCAS3/0-12F-X	D2.12	LCAX1/0-14-X	D2.67	LCAX300-12-6	D2.67
C1. Wiring Duct	LCAS3/0-12H-X	D2.10	LCAX1/0-14F-X	D2.70	LCAX300-12F-6	D2.71
	LCAS3/0-14-X	D2.8	LCAX1/0-14H-X	D2.68	LCAX300-12H-6	D2.69
	LCAS3/0-14F-X	D2.12	LCAX1/0-38-X	D2.67	LCAX300-38-6	D2.67
C2. Surface Raceway	LCAS3/0-14H-X	D2.10	LCAX1/0-38F-X	D2.70	LCAX300-38F-6	D2.71
	LCAS3/0-38-X	D2.8	LCAX1/0-38H-X	D2.68	LCAX300-38H-6	D2.69
	LCAS3/0-38F-X	D2.12	LCAX1/0-56-X	D2.67	LCAX300-58-6	D2.67
	LCAS3/0-38H-X	D2.10	LCAX1/0-56F-X	D2.70	LCAX300-58F-6	D2.71
C3. Abrasion Protection	LCAS3/0-56-X	D2.8	LCAX1/0-56H-X	D2.68	LCAX300-58H-6	D2.69
	LCAS3/0-56F-X	D2.12	LCAX1/0-58-X	D2.67	LCAX350-12-6	D2.67
	LCAS3/0-56H-X	D2.10	LCAX2-10-E	D2.66	LCAX350-12F-6	D2.71
	LCAS4-10-L	D2.7	LCAX2-10F-E	D2.70	LCAX350-12H-6	D2.69
	LCAS4-10F-L	D2.11	LCAX2-10H-E	D2.68	LCAX350-38-6	D2.67
	LCAS4-10H-L	D2.9	LCAX2-12-E	D2.66	LCAX350-38F-6	D2.71
C4. Cable Management	LCAS4-14-L	D2.7	LCAX2-12F-E	D2.70	LCAX350-38H-6	D2.69
	LCAS4-14F-L	D2.11	LCAX2-12H-E	D2.68	LCAX350-56-6	D2.67
	LCAS4-14H-L	D2.9	LCAX2-14-E	D2.66	LCAX350-56F-6	D2.71
	LCAS4-38-L	D2.7	LCAX2-14F-E	D2.70	LCAX350-56H-6	D2.69
D1. Terminals	LCAS4-38F-L	D2.11	LCAX2-14H-E	D2.68	LCAX350-58-6	D2.67
	LCAS4-38H-L	D2.9	LCAX2-38-E	D2.66	LCAX350-58F-6	D2.71
	LCAS4-56-L	D2.7	LCAX2-38F-E	D2.70	LCAX350-58H-6	D2.69
	LCAS4-56F-L	D2.11	LCAX2-56-E	D2.66	LCAX4-10-L	D2.66
	LCAS4-56H-L	D2.9	LCAX2-56F-E	D2.70	LCAX4-10F-L	D2.70
	LCAS4/0-12-X	D2.8	LCAX2-56H-E	D2.68	LCAX4-10H-L	D2.68
	LCAS4/0-12F-X	D2.12	LCAX2/0-10-X	D2.67	LCAX4-14-L	D2.66
	LCAS4/0-12H-X	D2.10	LCAX2/0-10F-X	D2.71	LCAX4-14H-L	D2.68
	LCAS4/0-14-X	D2.8	LCAX2/0-10H-X	D2.69	LCAX4-38-L	D2.66
	LCAS4/0-14F-X	D2.12	LCAX2/0-12-X	D2.67	LCAX4-38F-L	D2.70
	LCAS4/0-14H-X	D2.10	LCAX2/0-12F-X	D2.71	LCAX4-38H-L	D2.68
	LCAS4/0-38-X	D2.8	LCAX2/0-12H-X	D2.69	LCAX4-56-L	D2.66
D2. Power Connectors	LCAS4/0-38F-X	D2.12	LCAX2/0-14-X	D2.67	LCAX4-56F-L	D2.70
	LCAS4/0-38H-X	D2.10	LCAX2/0-14F-X	D2.71	LCAX4-56H-L	D2.68
	LCAS4/0-56-X	D2.8	LCAX2/0-14H-X	D2.69	LCAX4/0-12-X	D2.67
	LCAS4/0-56F-X	D2.12	LCAX2/0-38-X	D2.67	LCAX4/0-12F-X	D2.71
D3. Grounding Connectors	LCAS4/0-56H-X	D2.10	LCAX2/0-38F-X	D2.71	LCAX4/0-12H-X	D2.69
	LCAS6-10-L	D2.7	LCAX2/0-38H-X	D2.69	LCAX4/0-14-X	D2.67
	LCAS6-10F-L	D2.11	LCAX2/0-56-X	D2.67	LCAX4/0-14F-X	D2.71
	LCAS6-10H-L	D2.9	LCAX2/0-56F-X	D2.71	LCAX4/0-14H-X	D2.69
E1. Labeling Systems	LCAS6-14-L	D2.7	LCAX2/0-56H-X	D2.69	LCAX4/0-34-X	D2.67
	LCAS6-14F-L	D2.11	LCAX2/0-58-X	D2.67	LCAX4/0-34F-X	D2.71
	LCAS6-14H-L	D2.9	LCAX2/0-58F-X	D2.71	LCAX4/0-34H-X	D2.69
	LCAS6-38-L	D2.7	LCAX2/0-58H-X	D2.69	LCAX4/0-38-X	D2.67
E2. Labels	LCAS6-38F-L	D2.11	LCAX250-12-X	D2.67	LCAX4/0-38F-X	D2.71
	LCAS6-38H-L	D2.9	LCAX250-12F-X	D2.71	LCAX4/0-38H-X	D2.69
	LCAS6-56-L	D2.7	LCAX250-12H-X	D2.69	LCAX4/0-56-X	D2.67
	LCAS6-56F-L	D2.11	LCAX250-14-X	D2.67	LCAX4/0-56F-X	D2.71
E3. Pre-Printed & Write-On Markers	LCAS6-56H-L	D2.9	LCAX250-14F-X	D2.71	LCAX4/0-56H-X	D2.69
	LCAS8-10-L	D2.7	LCAX250-14H-X	D2.69	LCAX4/0-58-X	D2.67
	LCAS8-10F-L	D2.11	LCAX250-34-X	D2.67	LCAX4/0-58F-X	D2.71
	LCAS8-10H-L	D2.9	LCAX250-34F-X	D2.71	LCAX4/0-58H-X	D2.69
E4. Permanent Identification	LCAS8-14-L	D2.7	LCAX250-34H-X	D2.69	LCAX450-12-6	D2.67
	LCAS8-14F-L	D2.11	LCAX250-38-X	D2.67	LCAX450-12F-6	D2.71
	LCAS8-14H-L	D2.9	LCAX250-38F-X	D2.71	LCAX450-12H-6	D2.69
	LCAS8-38-L	D2.7	LCAX250-38H-X	D2.69	LCAX450-58-6	D2.67
E5. Lockout/Tagout & Safety Solutions	LCAS8-38F-L	D2.11	LCAX250-56-X	D2.67	LCAX450-58F-6	D2.71
	LCAS8-38H-L	D2.9	LCAX250-56F-X	D2.71	LCAX450-58H-6	D2.69
	LCAS8-56-L	D2.7	LCAX250-56H-X	D2.69	LCAX500-12-6	D2.67
	LCAS8-56F-L	D2.11	LCAX250-58-X	D2.67	LCAX500-12F-6	D2.71
F. Index	LCAS8-56H-L	D2.9	LCAX250-58F-X	D2.71	LCAX500-12H-6	D2.69
	LCAX1-10-X	D2.66	LCAX250-58H-X	D2.69	LCAX500-38-6	D2.67
	LCAX1-10F-X	D2.70	LCAX3/0-10-X	D2.67	LCAX500-38F-6	D2.71
	LCAX1-10H-X	D2.68	LCAX3/0-10F-X	D2.71	LCAX500-38H-6	D2.69
	LCAX1-12-X	D2.66	LCAX3/0-10H-X	D2.69	LCAX500-56-6	D2.67
	LCAX1-12F-X	D2.70	LCAX3/0-12-X	D2.67	LCAX500-56F-6	D2.71

# PANDUIT® ELECTRICAL SOLUTIONS

Part Number	Page Number	Part Number	Page Number	Part Number	Page Number
LCAX500-56H-6	D2.69	LCB2-12-Q	D2.22	LCB6-14H-L	D2.24
LCAX500-58-6	D2.67	LCB2-14-Q	D2.22	LCB6-38-L	D2.22
LCAX500-58F-6	D2.71	LCB2-38-Q	D2.22	LCB6-38F-L	D2.26
LCAX500-58H-6	D2.69	LCB2-56-Q	D2.22	LCB6-38H-L	D2.24
LCAX6-10-L	D2.66	LCB2-56F-Q	D2.26	LCB600-12-6	D2.23
LCAX6-10F-L	D2.70	LCB2-56H-Q	D2.24	LCB600-12F-6	D2.27
LCAX6-10H-L	D2.68	LCB2/0-12-X	D2.23	LCB600-12H-6	D2.25
LCAX6-14-L	D2.66	LCB2/0-12F-X	D2.26	LCB600-58-6	D2.23
LCAX6-14F-L	D2.70	LCB2/0-12H-X	D2.24	LCB600-58F-6	D2.27
LCAX6-14H-L	D2.68	LCB2/0-38-X	D2.23	LCB600-58H-6	D2.25
LCAX6-38-L	D2.66	LCB2/0-38F-X	D2.26	LCB750-12W-6	D2.28
LCAX6-38F-L	D2.70	LCB2/0-38H-X	D2.24	LCB750-38W-6	D2.28
LCAX6-38H-L	D2.68	LCB250-12-X	D2.23	LCB750-58-6	D2.23
LCAX6-56-L	D2.66	LCB250-12F-X	D2.27	LCB750-58W-6	D2.28
LCAX6-56F-L	D2.70	LCB250-12H-X	D2.25	LCB750-78-6	D2.23
LCAX6-56H-L	D2.68	LCB250-78-X	D2.23	LCB750-78W-6	D2.28
LCAX650-12-6	D2.67	LCB250-78F-X	D2.27	LCB8-10-L	D2.22
LCAX650-12F-6	D2.71	LCB250-78H-X	D2.25	LCB8-10F-L	D2.26
LCAX650-12H-6	D2.69	LCB3/0-12-X	D2.23	LCB8-10H-L	D2.24
LCAX650-38-6	D2.67	LCB3/0-12F-X	D2.26	LCB8-14-L	D2.22
LCAX650-38F-6	D2.71	LCB3/0-12H-X	D2.24	LCB8-14F-L	D2.26
LCAX650-38H-6	D2.69	LCB3/0-38-X	D2.23	LCB8-14H-L	D2.24
LCAX650-56-6	D2.67	LCB3/0-38F-X	D2.26	LCB8-38-L	D2.22
LCAX650-56F-6	D2.71	LCB3/0-38H-X	D2.24	LCB800-12W-6	D2.28
LCAX650-56H-6	D2.69	LCB300-12-X	D2.23	LCB800-58-6	D2.23
LCAX650-58-6	D2.67	LCB300-12F-X	D2.27	LCB800-58W-6	D2.28
LCAX650-58F-6	D2.71	LCB300-12H-X	D2.25	LCBH1-38-E	D2.30
LCAX650-58H-6	D2.69	LCB300-38-X	D2.23	LCBH1/0-38-X	D2.30
LCAX750-12-3	D2.67	LCB300-38F-X	D2.27	LCBH2-38-Q	D2.30
LCAX750-12F-3	D2.71	LCB300-38H-X	D2.25	LCBH2/0-12-X	D2.30
LCAX750-12H-3	D2.69	LCB300-56-X	D2.23	LCBH250-12-X	D2.30
LCAX750-58-3	D2.67	LCB300-56F-X	D2.27	LCBH3/0-12-X	D2.30
LCAX750-58F-3	D2.71	LCB300-56H-X	D2.25	LCBH4-38-L	D2.30
LCAX750-58H-3	D2.69	LCB350-12-X	D2.23	LCBH4/0-12-X	D2.30
LCAX8-10-L	D2.66	LCB350-12F-X	D2.27	LCBX1-14-X	D2.79
LCAX8-10F-L	D2.70	LCB350-12H-X	D2.25	LCBX1-14F-X	D2.81
LCAX8-10H-L	D2.68	LCB350-78-X	D2.23	LCBX1-14H-X	D2.80
LCAX8-14-L	D2.66	LCB350-78F-X	D2.27	LCBX1-38-X	D2.79
LCAX8-14F-L	D2.70	LCB350-78H-X	D2.25	LCBX1-38F-X	D2.81
LCAX8-14H-L	D2.68	LCB4-10-L	D2.22	LCBX1-38H-X	D2.80
LCAX8-38-L	D2.66	LCB4-10F-L	D2.26	LCBX1-56-X	D2.79
LCAX8-38F-L	D2.70	LCB4-10H-L	D2.24	LCBX1-56F-X	D2.81
LCAX8-38H-L	D2.68	LCB4-14-L	D2.22	LCBX1-56H-X	D2.80
LCAX8-56-L	D2.66	LCB4-14F-L	D2.26	LCBX1/0-12-X	D2.79
LCAX8-56F-L	D2.70	LCB4-14H-L	D2.24	LCBX1/0-12F-X	D2.81
LCAX8-56H-L	D2.68	LCB4-38-L	D2.22	LCBX1/0-12H-X	D2.80
LCAXN750-12-3	D2.72	LCB4-56-L	D2.22	LCBX1/0-14-X	D2.79
LCB1-10-E	D2.22	LCB4/0-12-X	D2.23	LCBX1/0-14F-X	D2.81
LCB1-10F-E	D2.26	LCB4/0-12F-X	D2.26	LCBX1/0-14H-X	D2.80
LCB1-10H-E	D2.24	LCB4/0-12H-X	D2.25	LCBX1/0-38-X	D2.79
LCB1-12-E	D2.22	LCB4/0-38-X	D2.23	LCBX1/0-38F-X	D2.81
LCB1-38-E	D2.22	LCB4/0-38F-X	D2.26	LCBX1/0-38H-X	D2.80
LCB1-56-E	D2.22	LCB4/0-38H-X	D2.25	LCBX2-12-E	D2.79
LCB1-56F-E	D2.26	LCB400-12-6	D2.23	LCBX2-12F-E	D2.81
LCB1-56H-E	D2.24	LCB400-12F-6	D2.27	LCBX2-12H-E	D2.80
LCB1/0-10-X	D2.22	LCB400-12H-6	D2.25	LCBX2-14-E	D2.79
LCB1/0-10F-X	D2.26	LCB400-38-6	D2.23	LCBX2-14F-E	D2.81
LCB1/0-10H-X	D2.24	LCB400-58-6	D2.23	LCBX2-14H-E	D2.80
LCB1/0-12-X	D2.22	LCB400-58F-6	D2.27	LCBX2-38-E	D2.79
LCB1/0-12F-X	D2.26	LCB400-58H-6	D2.25	LCBX2-38F-E	D2.81
LCB1/0-12H-X	D2.24	LCB400-78-6	D2.23	LCBX2-38H-E	D2.80
LCB1/0-38-X	D2.22	LCB400-78F-6	D2.27	LCBX2/0-12-X	D2.79
LCB1/0-38F-X	D2.26	LCB400-78H-6	D2.25	LCBX2/0-12F-X	D2.81
LCB1/0-38H-X	D2.24	LCB500-12-6	D2.23	LCBX2/0-12H-X	D2.80
LCB1/0-56-X	D2.22	LCB500-12F-6	D2.27	LCBX2/0-14-X	D2.79
LCB1/0-56F-X	D2.26	LCB500-12H-6	D2.25	LCBX2/0-14F-X	D2.81
LCB1/0-56H-X	D2.24	LCB500-58-6	D2.23	LCBX2/0-14H-X	D2.80
LCB10-14W-L	D2.28	LCB500-58F-6	D2.27	LCBX2/0-38-X	D2.79
LCB10-14WF-L	D2.29	LCB500-58H-6	D2.25	LCBX2/0-38F-X	D2.81
LCB10-14WH-L	D2.29	LCB500-78-6	D2.23	LCBX2/0-38H-X	D2.80
LCB1000-12W-3	D2.28	LCB500-78F-6	D2.27	LCBX250-12-X	D2.79
LCB1000-38W-3	D2.28	LCB500-78H-6	D2.25	LCBX250-38-X	D2.79
LCB1000-58-3	D2.23	LCB6-10-L	D2.22	LCBX250-38F-X	D2.81
LCB1000-58W-3	D2.28	LCB6-10F-L	D2.26	LCBX250-38H-X	D2.80
LCB2-10-Q	D2.22	LCB6-10H-L	D2.24	LCBX250-58-X	D2.79
LCB2-10F-Q	D2.26	LCB6-14-L	D2.22	LCBX3/0-38-X	D2.79
LCB2-10H-Q	D2.24	LCB6-14F-L	D2.26	LCBX3/0-38F-X	D2.81

A.  
System  
Overview

B1.  
Cable Ties

B2.  
Cable  
Accessories

B3.  
Stainless  
Steel Ties

C1.  
Wiring  
Duct

C2.  
Surface  
Raceway

C3.  
Abrasion  
Protection

C4.  
Cable  
Management

D1.  
Terminals

D2.  
Power  
Connectors

D3.  
Grounding  
Connectors

E1.  
Labeling  
Systems

E2.  
Labels

E3.  
Pre-Printed  
& Write-On  
Markers

E4.  
Permanent  
Identification

E5.  
Lockout/  
Tagout  
& Safety  
Solutions

F.  
Index

# PANDUIT® ELECTRICAL SOLUTIONS

A. System Overview	Part Number	Page Number	Part Number	Page Number	Part Number	Page Number
B1. Cable Ties	LCC1-00-E	D2.57	LCC1-0-56C-X	D2.42	LCC2-12H-Q	D2.43
	LCC1-12-E	D2.41	LCC1-0-56CF-X	D2.46	LCC2-12W-Q	D2.48
	LCC1-12F-E	D2.46	LCC1-0-56CH-E	D2.44	LCC2-12WF-Q	D2.54
B2. Cable Accessories	LCC1-12H-E	D2.44	LCC1-0-56CW-E	D2.48	LCC2-12WH-Q	D2.51
	LCC1-12W-E	D2.48	LCC1-0-56CWF-E	D2.54	LCC2-14A-Q	D2.41
	LCC1-12WF-E	D2.54	LCC1-0-56CWH-E	D2.51	LCC2-14AF-Q	D2.45
B3. Stainless Steel Ties	LCC1-14A-E	D2.41	LCC1/0-00-X	D2.57	LCC2-14AH-Q	D2.43
	LCC1-14AF-E	D2.46	LCC1/0-00W-X	D2.58	LCC2-14AW-Q	D2.48
	LCC1-14AH-E	D2.44	LCC1/0-12-X	D2.42	LCC2-14AWF-Q	D2.54
C1. Wiring Duct	LCC1-14AW-E	D2.48	LCC1/0-12D-X	D2.42	LCC2-14AWH-Q	D2.51
	LCC1-14AWF-E	D2.54	LCC1/0-12DH-X	D2.44	LCC2-14B-Q	D2.41
	LCC1-14AWH-E	D2.50	LCC1/0-12DF-X	D2.46	LCC2-14BF-Q	D2.45
C2. Surface Raceway	LCC1-14B-E	D2.41	LCC1/0-12DWH-X	D2.51	LCC2-14BH-Q	D2.43
	LCC1-14B-E	D2.41	LCC1/0-12DW-X	D2.48	LCC2-14BW-Q	D2.48
	LCC1-14B-E	D2.41	LCC1/0-12DWF-X	D2.54	LCC2-14BWF-Q	D2.54
C3. Abrasion Protection	LCC1-14B-E	D2.41	LCC1/0-12DWH-X	D2.51	LCC2-14BWH-Q	D2.51
	LCC1-14B-E	D2.41	LCC1/0-12F-X	D2.46	LCC2-14DW-Q	D2.48
	LCC1-14B-E	D2.41	LCC1/0-12H-X	D2.44	LCC2-14DWF-Q	D2.54
C4. Cable Management	LCC1-14B-E	D2.41	LCC1/0-12W-X	D2.48	LCC2-14DWH-Q	D2.51
	LCC1-14B-E	D2.41	LCC1/0-12WF-X	D2.54	LCC2-38-Q	D2.41
	LCC1-14B-E	D2.41	LCC1/0-12WH-X	D2.51	LCC2-38BW-Q	D2.48
D1. Terminals	LCC1-14B-E	D2.41	LCC1/0-14A-X	D2.42	LCC2-38BWF-Q	D2.54
	LCC1-14B-E	D2.41	LCC1/0-14AF-X	D2.46	LCC2-38BWH-Q	D2.51
	LCC1-14B-E	D2.41	LCC1/0-14AH-X	D2.44	LCC2-38CW-Q	D2.48
D2. Power Connectors	LCC1-14B-E	D2.41	LCC1/0-14AW-X	D2.48	LCC2-38CWF-Q	D2.54
	LCC1-14B-E	D2.41	LCC1/0-14AWF-X	D2.54	LCC2-38CWH-Q	D2.51
	LCC1-14B-E	D2.41	LCC1/0-14B-X	D2.42	LCC2-38D-Q	D2.41
D3. Grounding Connectors	LCC1-14B-E	D2.41	LCC1/0-14BF-X	D2.46	LCC2-38DF-Q	D2.45
	LCC1-14B-E	D2.41	LCC1/0-14BH-X	D2.44	LCC2-38DH-Q	D2.43
	LCC1-14B-E	D2.41	LCC1/0-14BW-X	D2.48	LCC2-38DW-Q	D2.48
E1. Labeling Systems	LCC1-14B-E	D2.41	LCC1/0-14BWF-X	D2.54	LCC2-38DWF-Q	D2.54
	LCC1-14B-E	D2.41	LCC1/0-14BWH-X	D2.51	LCC2-38DWH-Q	D2.51
	LCC1-14B-E	D2.41	LCC1/0-14DW-X	D2.48	LCC2-38F-Q	D2.43
E2. Labels	LCC1-14B-E	D2.41	LCC1/0-14DWF-X	D2.54	LCC2-38H-Q	D2.43
	LCC1-14B-E	D2.41	LCC1/0-14DWH-X	D2.51	LCC2-38W-Q	D2.48
	LCC1-14B-E	D2.41	LCC1/0-38D-X	D2.42	LCC2-38WF-Q	D2.54
E3. Pre-Printed & Write-On Markers	LCC1-14B-E	D2.41	LCC1/0-38DF-X	D2.46	LCC2-38WH-Q	D2.51
	LCC1-14B-E	D2.41	LCC1/0-38DH-X	D2.44	LCC2-56B-Q	D2.41
	LCC1-14B-E	D2.41	LCC1/0-38DW-X	D2.48	LCC2-56BF-Q	D2.45
E4. Permanent Identification	LCC1-14B-E	D2.41	LCC1/0-38DWF-X	D2.54	LCC2-56BH-Q	D2.43
	LCC1-14B-E	D2.41	LCC1/0-38DWH-X	D2.51	LCC2-56BW-Q	D2.48
	LCC1-14B-E	D2.41	LCC1/0-38W-X	D2.48	LCC2-56BWF-Q	D2.54
E5. Lockout/Tagout & Safety Solutions	LCC1-14B-E	D2.41	LCC1/0-38WF-X	D2.54	LCC2-56BWH-Q	D2.51
	LCC1-14B-E	D2.41	LCC1/0-38WH-X	D2.51	LCC2-56C-Q	D2.41
	LCC1-14B-E	D2.41	LCC1/0-38W-X	D2.48	LCC2-56CF-Q	D2.45
F. Index	LCC1-14B-E	D2.41	LCC1/0-38WF-X	D2.54	LCC2-56CH-Q	D2.43
	LCC1-14B-E	D2.41	LCC1/0-38WH-X	D2.51	LCC2-56CW-Q	D2.48
	LCC1-14B-E	D2.41	LCC1/0-56C-X	D2.42	LCC2-56CWF-Q	D2.54
	LCC1-14B-E	D2.41	LCC1/0-56CF-X	D2.46	LCC2-56CWH-Q	D2.51
	LCC1-14B-E	D2.41	LCC1/0-56CH-X	D2.44	LCC2/0-00-X	D2.57
	LCC1-14B-E	D2.41	LCC1/0-56D-X	D2.42	LCC2/0-00W-X	D2.58
	LCC1-14B-E	D2.41	LCC1/0-56DF-X	D2.46	LCC2/0-12-X	D2.42
	LCC1-14B-E	D2.41	LCC1/0-56DH-X	D2.44	LCC2/0-12D-X	D2.42
	LCC1-14B-E	D2.41	LCC10-14AW-L	D2.47	LCC2/0-12DF-X	D2.46
	LCC1-14B-E	D2.41	LCC10-14AWF-L	D2.53	LCC2/0-12DH-X	D2.44
	LCC1-14B-E	D2.41	LCC10-14AWH-L	D2.50	LCC2/0-12DW-X	D2.48
	LCC1-14B-E	D2.41	LCC10-14BW-L	D2.47	LCC2/0-12DWF-X	D2.54
	LCC1-14B-E	D2.41	LCC10-14BWF-L	D2.53	LCC2/0-12DWH-X	D2.51
	LCC1-14B-E	D2.41	LCC10-14BWH-L	D2.50	LCC2/0-12F-X	D2.46
	LCC1-14B-E	D2.41	LCC10-14JAW-L	D2.47	LCC2/0-12H-X	D2.44
	LCC1-14B-E	D2.41	LCC10-14JAWF-L	D2.53	LCC2/0-12W-X	D2.48
	LCC1-14B-E	D2.41	LCC10-14JAWH-L	D2.50	LCC2/0-12WF-X	D2.54
	LCC1-14B-E	D2.41	LCC1000-00-3	D2.57	LCC2/0-12WH-X	D2.51
	LCC1-14B-E	D2.41	LCC1000-12-3	D2.42	LCC2/0-14A-X	D2.42
	LCC1-14B-E	D2.41	LCC1000-12W-3	D2.49	LCC2/0-14AF-X	D2.46
	LCC1-14B-E	D2.41	LCC1000-38D-3	D2.42	LCC2/0-14AH-X	D2.44
	LCC1-14B-E	D2.41	LCC1000-38DW-3	D2.49	LCC2/0-14AW-X	D2.48
	LCC1-14B-E	D2.41	LCC2-00-Q	D2.57	LCC2/0-14AWF-X	D2.54
	LCC1-14B-E	D2.41	LCC2-00W-Q	D2.58	LCC2/0-14AWH-X	D2.51
	LCC1-14B-E	D2.41	LCC2-10AW-Q	D2.48	LCC2/0-14B-X	D2.42
	LCC1-14B-E	D2.41	LCC2-10AWF-Q	D2.54	LCC2/0-14BF-X	D2.46
	LCC1-14B-E	D2.41	LCC2-10AWH-Q	D2.51	LCC2/0-14BH-X	D2.44
	LCC1-14B-E	D2.41	LCC2-10BW-Q	D2.48	LCC2/0-14BW-X	D2.48
	LCC1-14B-E	D2.41	LCC2-10BWF-Q	D2.54	LCC2/0-14BWF-X	D2.54
	LCC1-14B-E	D2.41	LCC2-10BWH-Q	D2.51	LCC2/0-14BWH-X	D2.51
	LCC1-14B-E	D2.41	LCC2-12-Q	D2.41	LCC2/0-38D-X	D2.42
	LCC1-14B-E	D2.41	LCC2-12F-Q	D2.45	LCC2/0-38DF-X	D2.46

Part Number	Page Number
LCC2/0-38DH-X	D2.44
LCC2/0-38DW-X	D2.48
LCC2/0-38DWF-X	D2.54
LCC2/0-38DWH-X	D2.51
LCC2/0-56D-X	D2.42
LCC2/0-56DF-X	D2.46
LCC2/0-56DH-X	D2.44
LCC2/0-56DW-X	D2.48
LCC2/0-56DWF-X	D2.54
LCC2/0-56DWH-X	D2.51
LCC250-00-X	D2.57
LCC250-00W-X	D2.58
LCC250-12-X	D2.42
LCC250-12D-X	D2.42
LCC250-12DF-X	D2.46
LCC250-12DH-X	D2.44
LCC250-12DW-X	D2.49
LCC250-12DWF-X	D2.55
LCC250-12DWH-X	D2.52
LCC250-12F-X	D2.46
LCC250-12H-X	D2.44
LCC250-12W-X	D2.49
LCC250-12WF-X	D2.55
LCC250-12WH-X	D2.52
LCC250-38D-X	D2.42
LCC250-38DF-X	D2.46
LCC250-38DH-X	D2.44
LCC250-38DW-X	D2.49
LCC250-38DWF-X	D2.55
LCC250-38DWH-X	D2.52
LCC250-56DW-X	D2.49
LCC250-56DWF-X	D2.55
LCC250-56DWH-X	D2.52
LCC3/0-00-X	D2.57
LCC3/0-00W-X	D2.58
LCC3/0-12-X	D2.42
LCC3/0-12D-X	D2.42
LCC3/0-12DF-X	D2.46
LCC3/0-12DH-X	D2.44
LCC3/0-12DW-X	D2.49
LCC3/0-12DWF-X	D2.54
LCC3/0-12DWH-X	D2.51
LCC3/0-12F-X	D2.46
LCC3/0-12H-X	D2.44
LCC3/0-12W-X	D2.49
LCC3/0-12WF-X	D2.54
LCC3/0-12WH-X	D2.51
LCC3/0-14B-X	D2.42
LCC3/0-14BF-X	D2.46
LCC3/0-14BH-X	D2.44
LCC3/0-14BW-X	D2.49
LCC3/0-14BWF-X	D2.54
LCC3/0-14BWH-X	D2.51
LCC3/0-38D-X	D2.42
LCC3/0-38DF-X	D2.46
LCC3/0-38DH-X	D2.44
LCC3/0-38DW-X	D2.49
LCC3/0-38DWF-X	D2.54
LCC3/0-38DWH-X	D2.51
LCC3/0-56DW-X	D2.49
LCC3/0-56DWF-X	D2.54
LCC3/0-56DWH-X	D2.51
LCC300-00-X	D2.57
LCC300-00W-X	D2.58
LCC300-12-X	D2.42
LCC300-12F-X	D2.46
LCC300-12H-X	D2.44
LCC300-12W-X	D2.49
LCC300-12WF-X	D2.55
LCC300-12WH-X	D2.52
LCC300-38D-X	D2.42
LCC300-38DF-X	D2.46
LCC300-38DH-X	D2.44
LCC300-38DW-X	D2.49
LCC300-38DWF-X	D2.55
LCC300-38DWH-X	D2.52
LCC350-00-X	D2.57

Part Number	Page Number
LCC350-00W-X	D2.58
LCC350-12-X	D2.42
LCC350-12F-X	D2.46
LCC350-12H-X	D2.44
LCC350-12W-X	D2.49
LCC350-12WF-X	D2.55
LCC350-12WH-X	D2.52
LCC350-14B-X	D2.42
LCC350-14BF-X	D2.46
LCC350-14BH-X	D2.44
LCC350-14BW-X	D2.49
LCC350-14BWF-X	D2.55
LCC350-14BWH-X	D2.52
LCC350-38D-X	D2.42
LCC350-38DF-X	D2.46
LCC350-38DH-X	D2.44
LCC350-38DW-X	D2.49
LCC350-38DWF-X	D2.55
LCC350-38DWH-X	D2.52
LCC4-00-L	D2.57
LCC4-00W-L	D2.58
LCC4-10AW-L	D2.48
LCC4-10AWF-L	D2.54
LCC4-10AWH-L	D2.51
LCC4-10BW-L	D2.48
LCC4-10BWF-L	D2.54
LCC4-10BWH-L	D2.51
LCC4-12-L	D2.41
LCC4-12W-L	D2.48
LCC4-14A-L	D2.41
LCC4-14ADW-L	D2.48
LCC4-14AF-L	D2.45
LCC4-14AH-L	D2.43
LCC4-14AW-L	D2.48
LCC4-14AWF-L	D2.54
LCC4-14AWH-L	D2.51
LCC4-14B-L	D2.41
LCC4-14BF-L	D2.45
LCC4-14BH-L	D2.43
LCC4-14BW-L	D2.48
LCC4-14BWF-L	D2.54
LCC4-14BWH-L	D2.51
LCC4-14DW-L	D2.48
LCC4-38D-L	D2.41
LCC4-38DF-L	D2.45
LCC4-38DH-L	D2.43
LCC4-38DW-L	D2.48
LCC4-38DWF-L	D2.54
LCC4-38DWH-L	D2.51
LCC4/0-00-X	D2.57
LCC4/0-00W-X	D2.58
LCC4/0-12-X	D2.42
LCC4/0-12D-X	D2.42
LCC4/0-12DF-X	D2.46
LCC4/0-12DH-X	D2.44
LCC4/0-12DW-X	D2.49
LCC4/0-12DWF-X	D2.54
LCC4/0-12DWH-X	D2.51
LCC4/0-12F-X	D2.46
LCC4/0-12H-X	D2.44
LCC4/0-12W-X	D2.49
LCC4/0-12WF-X	D2.54
LCC4/0-12WH-X	D2.51
LCC4/0-14AW-X	D2.49
LCC4/0-14AWF-X	D2.54
LCC4/0-14AWH-X	D2.51
LCC4/0-14B-X	D2.42
LCC4/0-14BF-X	D2.46
LCC4/0-14BH-X	D2.44
LCC4/0-14BW-X	D2.49
LCC4/0-14BWF-X	D2.54
LCC4/0-14BWH-X	D2.51
LCC4/0-38-X	D2.42
LCC4/0-38D-X	D2.42
LCC4/0-38DF-X	D2.46
LCC4/0-38DH-X	D2.44
LCC4/0-38DW-X	D2.49

Part Number	Page Number
LCC4/0-38DWF-X	D2.54
LCC4/0-38DWH-X	D2.51
LCC4/0-38F-X	D2.46
LCC4/0-38H-X	D2.44
LCC4/0-38W-X	D2.49
LCC4/0-38WF-X	D2.54
LCC4/0-38WH-X	D2.51
LCC4/0-56D-X	D2.42
LCC4/0-56DF-X	D2.46
LCC4/0-56DH-X	D2.44
LCC4/0-56DW-X	D2.49
LCC4/0-56DWF-X	D2.54
LCC4/0-56DWH-X	D2.51
LCC400-00-6	D2.57
LCC400-00W-6	D2.58
LCC400-12-6	D2.42
LCC400-12F-6	D2.46
LCC400-12H-6	D2.44
LCC400-12W-6	D2.49
LCC400-12WF-6	D2.55
LCC400-12WH-6	D2.52
LCC400-14B-6	D2.42
LCC400-14BF-6	D2.46
LCC400-14BH-6	D2.44
LCC400-14BW-6	D2.49
LCC400-14BWF-6	D2.55
LCC400-14BWH-6	D2.52
LCC400-38D-6	D2.42
LCC400-38DF-6	D2.46
LCC400-38DH-6	D2.44
LCC400-38DW-6	D2.49
LCC400-38DWF-6	D2.55
LCC400-38DWH-6	D2.52
LCC500-00-6	D2.57
LCC500-00W-6	D2.58
LCC500-12-6	D2.42
LCC500-12F-6	D2.46
LCC500-12H-6	D2.44
LCC500-12W-6	D2.49
LCC500-12WF-6	D2.55
LCC500-12WH-6	D2.52
LCC500-14B-6	D2.42
LCC500-14BF-6	D2.46
LCC500-14BH-6	D2.44
LCC500-14BW-6	D2.49
LCC500-14BWF-6	D2.55
LCC500-14BWH-6	D2.52
LCC500-38D-6	D2.42
LCC500-38DF-6	D2.46
LCC500-38DH-6	D2.44
LCC500-38DW-6	D2.49
LCC500-38DWF-6	D2.55
LCC500-38DWH-6	D2.52
LCC6-00-L	D2.57
LCC6-00W-L	D2.58
LCC6-10A-L	D2.41
LCC6-10ABW-L	D2.47
LCC6-10AF-L	D2.45
LCC6-10AH-L	D2.43
LCC6-10AW-L	D2.47
LCC6-10AWF-L	D2.53
LCC6-10AWH-L	D2.50
LCC6-10BW-L	D2.47
LCC6-10BWF-L	D2.53
LCC6-10BWH-L	D2.50
LCC6-12-L	D2.41
LCC6-12W-L	D2.47
LCC6-14A-L	D2.41
LCC6-14AF-L	D2.45
LCC6-14AH-L	D2.43
LCC6-14AW-L	D2.47
LCC6-14AWF-L	D2.53
LCC6-14AWH-L	D2.50
LCC6-14B-L	D2.41
LCC6-14BDW-L	D2.47
LCC6-14BF-L	D2.45
LCC6-14BH-L	D2.43

A. System Overview
B1. Cable Ties
B2. Cable Accessories
B3. Stainless Steel Ties
C1. Wiring Duct
C2. Surface Raceway
C3. Abrasion Protection
C4. Cable Management
D1. Terminals
D2. Power Connectors
D3. Grounding Connectors
E1. Labeling Systems
E2. Labels
E3. Pre-Printed & Write-On Markers
E4. Permanent Identification
E5. Lockout/ Tagout & Safety Solutions
F. Index

A. System Overview	Part Number	Page Number	Part Number	Page Number	Part Number	Page Number
B1. Cable Ties	LCC6-14BW-L	D2.47	LCC8-14BWF-L	D2.53	LCCF250-12H-X	D2.99
	LCC6-14BWF-L	D2.53	LCC8-14BWH-L	D2.50	LCCF250-14B-X	D2.97
	LCC6-14BWH-L	D2.50	LCC8-14D-L	D2.41	LCCF250-14BF-X	D2.101
B2. Cable Accessories	LCC6-14D-L	D2.41	LCC8-14DF-L	D2.45	LCCF250-14BH-X	D2.99
	LCC6-14DF-L	D2.45	LCC8-14DH-L	D2.43	LCCF250-38D-X	D2.97
	LCC6-14DH-L	D2.43	LCC8-14DW-L	D2.47	LCCF250-38DF-X	D2.101
	LCC6-14DW-L	D2.47	LCC8-14DWF-L	D2.53	LCCF250-38DH-X	D2.99
	LCC6-14DWF-L	D2.53	LCC8-14DWH-L	D2.50	LCCF3/0-12-X	D2.97
B3. Stainless Steel Ties	LCC6-14DWH-L	D2.50	LCC8-38D-L	D2.41	LCCF3/0-12F-X	D2.100
	LCC6-14EW-L	D2.47	LCC8-38DF-L	D2.45	LCCF3/0-12H-X	D2.98
	LCC6-14EWF-L	D2.53	LCC8-38DH-L	D2.43	LCCF3/0-14B-X	D2.97
	LCC6-14EWH-L	D2.50	LCC8-38DW-L	D2.47	LCCF3/0-14BF-X	D2.100
C1. Wiring Duct	LCC6-14JAW-L	D2.47	LCC8-38DWF-L	D2.53	LCCF3/0-14BH-X	D2.98
	LCC6-14JAWF-L	D2.53	LCC8-38DWH-L	D2.50	LCCF3/0-38D-X	D2.97
	LCC6-14JAWH-L	D2.50	LCC800-12-6	D2.42	LCCF3/0-38DF-X	D2.100
C2. Surface Raceway	LCC6-14JW-L	D2.47	LCC800-12W-6	D2.49	LCCF3/0-38DH-X	D2.98
	LCC6-14JWF-L	D2.53	LCCF1-12-X	D2.96	LCCF300-12-6	D2.97
	LCC6-14JWH-L	D2.50	LCCF1-12F-X	D2.100	LCCF300-12F-6	D2.101
	LCC6-14W-L	D2.47	LCCF1-12H-X	D2.98	LCCF300-12H-6	D2.99
	LCC6-38BDW-L	D2.47	LCCF1-14A-X	D2.96	LCCF300-14B-6	D2.97
C3. Abrasion Protection	LCC6-38BW-L	D2.47	LCCF1-14AF-X	D2.100	LCCF300-14BF-6	D2.101
	LCC6-38BWF-L	D2.53	LCCF1-14AH-X	D2.98	LCCF300-14BH-6	D2.99
	LCC6-38BWH-L	D2.50	LCCF1-14B-X	D2.96	LCCF300-14BH-6	D2.97
	LCC6-38CW-L	D2.47	LCCF1-14BF-X	D2.100	LCCF300-38DF-6	D2.101
	LCC6-38CWF-L	D2.53	LCCF1-14BH-X	D2.98	LCCF300-38DH-6	D2.99
C4. Cable Management	LCC6-38CWH-L	D2.50	LCCF1-38D-X	D2.96	LCCF350-12-6	D2.97
	LCC6-38D-L	D2.41	LCCF1-38DF-X	D2.100	LCCF350-12E-6	D2.97
	LCC6-38DF-L	D2.45	LCCF1-38DH-X	D2.98	LCCF350-12EF-6	D2.101
	LCC6-38DH-L	D2.43	LCCF1-56C-X	D2.96	LCCF350-12EH-6	D2.99
	LCC6-38DW-L	D2.47	LCCF1-56CF-X	D2.100	LCCF350-12F-6	D2.101
D1. Terminals	LCC6-38DWF-L	D2.53	LCCF1-56CH-X	D2.98	LCCF350-12H-6	D2.99
	LCC6-38DWH-L	D2.50	LCCF1/0-12-X	D2.97	LCCF350-14B-6	D2.97
	LCC6-56BW-L	D2.47	LCCF1/0-12F-X	D2.100	LCCF350-14BF-6	D2.101
	LCC6-56BWF-L	D2.53	LCCF1/0-12H-X	D2.98	LCCF350-14BH-6	D2.99
	LCC6-56BWH-L	D2.50	LCCF1/0-14A-X	D2.97	LCCF350-38D-6	D2.97
	LCC600-00-6	D2.57	LCCF1/0-14AF-X	D2.100	LCCF350-38DF-6	D2.101
	LCC600-00W-6	D2.58	LCCF1/0-14AH-X	D2.98	LCCF350-38DH-6	D2.99
	LCC600-12-6	D2.42	LCCF1/0-14B-X	D2.97	LCCF4-14A-L	D2.96
	LCC600-12F-6	D2.46	LCCF1/0-14BF-X	D2.100	LCCF4-14AF-L	D2.100
	LCC600-12H-6	D2.44	LCCF1/0-14BH-X	D2.98	LCCF4-14AH-L	D2.98
D2. Power Connectors	LCC600-12W-6	D2.49	LCCF1/0-38D-X	D2.97	LCCF4-14B-L	D2.96
	LCC600-12WF-6	D2.55	LCCF1/0-38DF-X	D2.100	LCCF4-14BF-L	D2.100
	LCC600-12WH-6	D2.52	LCCF1/0-38DH-X	D2.98	LCCF4-14BH-L	D2.98
	LCC600-38D-6	D2.42	LCCF1/0-56C-X	D2.97	LCCF4-38D-L	D2.96
	LCC600-38DF-6	D2.46	LCCF1/0-56CF-X	D2.100	LCCF4-38DH-L	D2.98
D3. Grounding Connectors	LCC600-38DH-6	D2.44	LCCF1/0-56CH-X	D2.98	LCCF4/0-12-X	D2.97
	LCC600-38DW-6	D2.49	LCCF2-12-E	D2.96	LCCF4/0-12F-X	D2.101
	LCC600-38DWF-6	D2.55	LCCF2-12F-E	D2.100	LCCF4/0-12H-X	D2.99
	LCC600-38DWH-6	D2.52	LCCF2-12H-E	D2.98	LCCF4/0-14B-X	D2.97
	LCC750-00-6	D2.57	LCCF2-14A-E	D2.96	LCCF4/0-14BF-X	D2.101
E1. Labeling Systems	LCC750-12-6	D2.42	LCCF2-14AH-E	D2.98	LCCF4/0-14BH-X	D2.99
	LCC750-12W-6	D2.49	LCCF2-14B-E	D2.96	LCCF4/0-38-X	D2.97
	LCC750-38D-6	D2.42	LCCF2-14BF-E	D2.100	LCCF4/0-38D-X	D2.97
E2. Labels	LCC750-38DW-6	D2.49	LCCF2-14BH-E	D2.98	LCCF4/0-38DF-X	D2.101
	LCC8-00-L	D2.57	LCCF2-38D-E	D2.96	LCCF4/0-38DH-X	D2.99
	LCC8-00W-L	D2.58	LCCF2-38DF-E	D2.100	LCCF4/0-38F-X	D2.101
	LCC8-10A-L	D2.41	LCCF2-38DH-E	D2.98	LCCF4/0-38H-X	D2.99
	LCC8-10ABW-L	D2.47	LCCF2-56B-E	D2.96	LCCF400-12-6	D2.97
E3. Pre-Printed & Write-On Markers	LCC8-10AF-L	D2.45	LCCF2-56BF-E	D2.100	LCCF400-12F-6	D2.101
	LCC8-10AH-L	D2.43	LCCF2-56BH-E	D2.98	LCCF400-12H-6	D2.99
	LCC8-10AW-L	D2.47	LCCF2/0-12-X	D2.97	LCCF400-38D-6	D2.97
	LCC8-10AWF-L	D2.53	LCCF2/0-12F-X	D2.100	LCCF400-38DF-6	D2.101
	LCC8-10AWH-L	D2.50	LCCF2/0-12H-X	D2.98	LCCF400-38DH-6	D2.99
E4. Permanent Identification	LCC8-10BW-L	D2.47	LCCF2/0-14A-X	D2.97	LCCF500-12-6	D2.97
	LCC8-10BWF-L	D2.53	LCCF2/0-14AF-X	D2.100	LCCF500-12F-6	D2.101
	LCC8-10BWH-L	D2.50	LCCF2/0-14AH-X	D2.98	LCCF500-12H-6	D2.99
	LCC8-14A-L	D2.41	LCCF2/0-14B-X	D2.97	LCCF6-14A-L	D2.96
	LCC8-14ABW-L	D2.47	LCCF2/0-14BF-X	D2.100	LCCF6-14AF-L	D2.100
E5. Lockout/Tagout & Safety Solutions	LCC8-14AF-L	D2.45	LCCF2/0-14BH-X	D2.98	LCCF6-14AH-L	D2.98
	LCC8-14AH-L	D2.43	LCCF2/0-38D-X	D2.97	LCCF6-14B-L	D2.96
	LCC8-14AW-L	D2.47	LCCF2/0-38DF-X	D2.100	LCCF6-14BF-L	D2.100
	LCC8-14AWF-L	D2.53	LCCF2/0-38DH-X	D2.98	LCCF6-14BH-L	D2.98
	LCC8-14AWH-L	D2.50	LCCF250-12-X	D2.97	LCCF6-38D-L	D2.96
F. Index	LCC8-14B-L	D2.41	LCCF250-12E-X	D2.97	LCCF6-38DF-L	D2.100
	LCC8-14BF-L	D2.45	LCCF250-12EF-X	D2.101	LCCF6-38DH-L	D2.98
	LCC8-14BH-L	D2.43	LCCF250-12EH-X	D2.99	LCCF600-12-6	D2.97
	LCC8-14BW-L	D2.47	LCCF250-12F-X	D2.101	LCCF600-12F-6	D2.101



# PANDUIT® ELECTRICAL SOLUTIONS

Part Number	Page Number
LCCF600-12H-6	D2.99
LCCF750-12-3	D2.97
LCCF750-12F-3	D2.101
LCCF750-12H-3	D2.99
LCCF750-38D-3	D2.97
LCCF750-38DF-3	D2.101
LCCF750-38DH-3	D2.99
LCCF8-14A-L	D2.96
LCCF8-14AF-L	D2.100
LCCF8-14AH-L	D2.98
LCCF8-14B-L	D2.96
LCCF8-14BF-L	D2.100
LCCF8-14BH-L	D2.98
LCCF8-38D-L	D2.96
LCCF8-38DF-L	D2.100
LCCF8-38DH-L	D2.98
LCCH1/0-12-X	D2.56
LCCH1000-12-3	D2.56
LCCH2/0-12-X	D2.56
LCCH250-12-X	D2.56
LCCH3/0-12-X	D2.56
LCCH300-12-X	D2.56
LCCH350-12-X	D2.56
LCCH4/0-12-X	D2.56
LCCH400-12-6	D2.56
LCCH500-12-6	D2.56
LCCH600-12-6	D2.56
LCCH750-12-6	D2.56
LCCN750-12W-6	D2.55
LCCN750-38DW-6	D2.55
LCCX1-14A-X	D2.91
LCCX1-14AF-X	D2.94
LCCX1-14AH-X	D2.92
LCCX1-14B-X	D2.91
LCCX1-14BF-X	D2.94
LCCX1-14BH-X	D2.92
LCCX1-14D-X	D2.91
LCCX1-14DF-X	D2.94
LCCX1-14DH-X	D2.92
LCCX1-38D-X	D2.91
LCCX1-38DF-X	D2.94
LCCX1-38DH-X	D2.92
LCCX1-56C-X	D2.91
LCCX1-56CF-X	D2.94
LCCX1-56CH-X	D2.92
LCCX1-56D-X	D2.91
LCCX1-56DF-X	D2.94
LCCX1-56DH-X	D2.92
LCCX1/0-12-X	D2.91
LCCX1/0-12F-X	D2.94
LCCX1/0-12H-X	D2.93
LCCX1/0-14A-X	D2.91
LCCX1/0-14AF-X	D2.94
LCCX1/0-14AH-X	D2.93
LCCX1/0-14B-X	D2.91
LCCX1/0-14BF-X	D2.94
LCCX1/0-14BH-X	D2.93
LCCX1/0-38D-X	D2.91
LCCX1/0-38DF-X	D2.94
LCCX1/0-38DH-X	D2.93
LCCX2-12-E	D2.91
LCCX2-12F-E	D2.94
LCCX2-12H-E	D2.92
LCCX2-14A-E	D2.91
LCCX2-14AF-E	D2.94
LCCX2-14AH-E	D2.92
LCCX2-14B-E	D2.91
LCCX2-14BF-E	D2.94
LCCX2-14BH-E	D2.92
LCCX2-38D-E	D2.91
LCCX2-38DF-E	D2.94
LCCX2-38DH-E	D2.92
LCCX2/0-12-X	D2.91
LCCX2/0-12F-X	D2.95
LCCX2/0-12H-X	D2.93
LCCX2/0-14A-X	D2.91
LCCX2/0-14AF-X	D2.95

Part Number	Page Number
LCCX2/0-14AH-X	D2.93
LCCX2/0-14B-X	D2.91
LCCX2/0-14BF-X	D2.95
LCCX2/0-14BH-X	D2.93
LCCX2/0-38D-X	D2.91
LCCX2/0-38DF-X	D2.95
LCCX2/0-38DH-X	D2.93
LCCX250-12-X	D2.91
LCCX250-14B-X	D2.91
LCCX250-14BF-X	D2.95
LCCX250-14BH-X	D2.93
LCCX250-38D-X	D2.91
LCCX250-38DF-X	D2.95
LCCX250-38DH-X	D2.93
LCCX3/0-14B-X	D2.91
LCCX3/0-14BF-X	D2.95
LCCX3/0-14BH-X	D2.93
LCCX3/0-38D-X	D2.91
LCCX3/0-38DF-X	D2.95
LCCX3/0-38DH-X	D2.93
LCCX300-38D-6	D2.91
LCCX300-38DF-6	D2.95
LCCX300-38DH-6	D2.93
LCCX350-12-6	D2.91
LCCX350-12F-6	D2.95
LCCX350-12H-6	D2.93
LCCX350-14B-6	D2.91
LCCX350-14BF-6	D2.95
LCCX350-14BH-6	D2.93
LCCX350-38D-6	D2.91
LCCX350-38DF-6	D2.95
LCCX350-38DH-6	D2.93
LCCX4-14A-L	D2.90
LCCX4-14AB-L	D2.90
LCCX4-14AF-L	D2.94
LCCX4-14AH-L	D2.92
LCCX4-14B-L	D2.90
LCCX4-14BF-L	D2.94
LCCX4-14BH-L	D2.92
LCCX4-14CE-L	D2.90
LCCX4-38B-L	D2.90
LCCX4-38BD-L	D2.90
LCCX4-38BF-L	D2.94
LCCX4-38BH-L	D2.92
LCCX4-38D-L	D2.90
LCCX4-38DF-L	D2.94
LCCX4-38DH-L	D2.92
LCCX4/0-12-X	D2.91
LCCX4/0-12F-X	D2.95
LCCX4/0-12H-X	D2.93
LCCX4/0-14B-X	D2.91
LCCX4/0-14BF-X	D2.95
LCCX4/0-14BH-X	D2.93
LCCX4/0-38D-X	D2.91
LCCX4/0-38DF-X	D2.95
LCCX4/0-38DH-X	D2.93
LCCX450-12-6	D2.91
LCCX500-12-6	D2.91
LCCX500-38D-6	D2.91
LCCX6-10B-L	D2.90
LCCX6-10BF-L	D2.94
LCCX6-10BH-L	D2.92
LCCX6-14A-L	D2.90
LCCX6-14AB-L	D2.90
LCCX6-14AF-L	D2.94
LCCX6-14AH-L	D2.92
LCCX6-14B-L	D2.90
LCCX6-14BF-L	D2.94
LCCX6-14BH-L	D2.92
LCCX6-14D-L	D2.90
LCCX6-14DF-L	D2.94
LCCX6-14DH-L	D2.92
LCCX6-38A-L	D2.90
LCCX6-38AC-L	D2.90
LCCX6-38AF-L	D2.94
LCCX6-38AH-L	D2.92
LCCX6-38C-L	D2.90

Part Number	Page Number
LCCX6-38CF-L	D2.94
LCCX6-38CH-L	D2.92
LCCX6-38D-L	D2.90
LCCX6-38DF-L	D2.94
LCCX6-38DH-L	D2.92
LCCX650-12-6	D2.91
LCCX8-10A-L	D2.90
LCCX8-10AB-L	D2.90
LCCX8-10AF-L	D2.94
LCCX8-10AH-L	D2.92
LCCX8-10B-L	D2.90
LCCX8-10BF-L	D2.94
LCCX8-10BH-L	D2.92
LCCX8-14A-L	D2.90
LCCX8-14AB-L	D2.90
LCCX8-14AF-L	D2.94
LCCX8-14AH-L	D2.92
LCCX8-14B-L	D2.90
LCCX8-14BF-L	D2.94
LCCX8-14BH-L	D2.92
LCCX8-14D-L	D2.90
LCCX8-14DF-L	D2.94
LCCX8-14DH-L	D2.92
LCCX8-38D-L	D2.90
LCCX8-38DF-L	D2.94
LCCX8-38DH-L	D2.92
<b>LCCXN450-12-6</b>	<b>D2.95</b>
<b>LCCXN500-12-6</b>	<b>D2.95</b>
<b>LCCXN650-12-6</b>	<b>D2.95</b>
LCD1-12-E	D2.32
LCD1-12F-E	D2.36
LCD1-12H-E	D2.34
LCD1-14A-E	D2.32
LCD1-14AF-E	D2.36
LCD1-14AH-E	D2.34
LCD1-14B-E	D2.32
LCD1-14BF-E	D2.36
LCD1-14BH-E	D2.34
LCD1-38D-E	D2.32
LCD1-38DF-E	D2.36
LCD1-38DH-E	D2.34
LCD1-56C-E	D2.32
LCD1-56CF-E	D2.36
LCD1-56CH-E	D2.34
LCD1/0-00-X	D2.40
LCD1/0-12-X	D2.32
LCD1/0-12F-X	D2.36
LCD1/0-12H-X	D2.34
LCD1/0-14A-X	D2.32
LCD1/0-14AF-X	D2.36
LCD1/0-14AH-X	D2.34
LCD1/0-14B-X	D2.32
LCD1/0-14BF-X	D2.36
LCD1/0-14BH-X	D2.34
LCD1/0-38D-X	D2.32
LCD1/0-38DF-X	D2.36
LCD1/0-38DH-X	D2.34
LCD1/0-56C-X	D2.32
LCD1/0-56CF-X	D2.36
LCD1/0-56CH-X	D2.34
LCD10-10A-L	D2.31
LCD10-10AF-L	D2.35
LCD10-10AH-L	D2.33
LCD10-14A-L	D2.31
LCD10-14AF-L	D2.35
LCD10-14AH-L	D2.33
LCD10-14B-L	D2.31
LCD10-14D-L	D2.31
LCD10-38D-L	D2.31
LCD10-38DF-L	D2.35
LCD10-38DH-L	D2.33
LCD1000-00-3	D2.40
LCD1000-12-3	D2.32
LCD1000-12E-3	D2.32
LCD2-12-Q	D2.31
LCD2-12F-Q	D2.36
LCD2-12H-Q	D2.34

A. System Overview
B1. Cable Ties
B2. Cable Accessories
B3. Stainless Steel Ties
C1. Wiring Duct
C2. Surface Raceway
C3. Abrasion Protection
C4. Cable Management
D1. Terminals
D2. Power Connectors
D3. Grounding Connectors
E1. Labeling Systems
E2. Labels
E3. Pre-Printed & Write-On Markers
E4. Permanent Identification
E5. Lockout/ Tagout & Safety Solutions
F. Index

# PANDUIT® ELECTRICAL SOLUTIONS

A. System Overview	Part Number	Page Number	Part Number	Page Number	Part Number	Page Number
B1. Cable Ties	LCD2-14A-Q	D2.31	LCD4-14A-L	D2.31	LCD8-10A-L	D2.31
	LCD2-14AF-Q	D2.36	LCD4-14AF-L	D2.35	LCD8-10AF-L	D2.35
	LCD2-14AH-Q	D2.34	LCD4-14AH-L	D2.33	LCD8-10AH-L	D2.33
B2. Cable Accessories	LCD2-14B-Q	D2.31	LCD4-14B-L	D2.31	LCD8-14A-L	D2.31
	LCD2-14BF-Q	D2.36	LCD4-14BF-L	D2.35	LCD8-14AF-L	D2.35
	LCD2-14BH-Q	D2.34	LCD4-14BH-L	D2.33	LCD8-14AH-L	D2.33
	LCD2-14D-Q	D2.31	LCD4-14D-L	D2.31	LCD8-14B-L	D2.31
	LCD2-14DF-Q	D2.36	LCD4-14DF-L	D2.35	LCD8-14BF-L	D2.35
	LCD2-14DH-Q	D2.34	LCD4-14DH-L	D2.33	LCD8-14BH-L	D2.33
B3. Stainless Steel Ties	LCD2-38D-Q	D2.31	LCD4-38D-L	D2.31	LCD8-14D-L	D2.31
	LCD2-38DF-Q	D2.36	LCD4-38DF-L	D2.35	LCD8-14DF-L	D2.35
	LCD2-38DH-Q	D2.34	LCD4-38DH-L	D2.33	LCD8-14DH-L	D2.33
	LCD2-56B-Q	D2.31	LCD4/0-00-X	D2.40	LCD8-38D-L	D2.31
C1. Wiring Duct	LCD2-56BF-Q	D2.36	LCD4/0-12-X	D2.32	LCD8-38DF-L	D2.35
	LCD2-56BH-Q	D2.34	LCD4/0-12F-X	D2.36	LCD8-38DH-L	D2.33
	LCD2/0-00-X	D2.40	LCD4/0-12H-X	D2.34	LCDN1-14B-E	D2.37
	LCD2/0-12-X	D2.32	LCD4/0-14B-X	D2.32	LCDN1/0-14D-X	D2.37
	LCD2/0-12F-X	D2.36	LCD4/0-14BF-X	D2.36	LCDN1/0-14DF-X	D2.39
	LCD2/0-12H-X	D2.34	LCD4/0-14BH-X	D2.34	LCDN1/0-14DH-X	D2.38
	LCD2/0-14A-X	D2.32	LCD4/0-38D-X	D2.32	LCDN1/0-56D-X	D2.37
	LCD2/0-14AF-X	D2.36	LCD4/0-38DF-X	D2.36	LCDN1/0-56DF-X	D2.39
	LCD2/0-14AH-X	D2.34	LCD4/0-38DH-X	D2.34	LCDN1/0-56DH-X	D2.38
	LCD2/0-14B-X	D2.32	LCD400-00-6	D2.40	LCDN2-10B-Q	D2.37
C2. Surface Raceway	LCD2/0-14BF-X	D2.36	LCD400-12-6	D2.32	LCDN2-14A-Q	D2.37
	LCD2/0-14BH-X	D2.34	LCD400-12F-6	D2.36	LCDN2-14AF-Q	D2.39
	LCD2/0-38D-X	D2.32	LCD400-12H-6	D2.34	LCDN2-14AH-Q	D2.38
	LCD2/0-38DF-X	D2.36	LCD400-38D-6	D2.32	LCDN2-14B-Q	D2.37
C3. Abrasion Protection	LCD2/0-38DH-X	D2.34	LCD400-38DF-6	D2.36	LCDN2-14B-L	D2.37
	LCD2/0-56C-X	D2.32	LCD400-38DH-6	D2.34	LCDN2-14D-Q	D2.37
	LCD2/0-56CF-X	D2.36	LCD500-00-6	D2.40	LCDN2-14DF-Q	D2.39
	LCD2/0-56CH-X	D2.34	LCD500-00-6	D2.40	LCDN2-14DH-Q	D2.38
C4. Cable Management	LCD250-00-X	D2.40	LCD500-12-6	D2.32	LCDN2/0-14A-X	D2.37
	LCD250-12-X	D2.32	LCD500-12E-6	D2.32	LCDN2/0-14D-X	D2.37
	LCD250-12F-X	D2.36	LCD500-12EF-6	D2.36	LCDN2/0-56A-X	D2.37
	LCD250-12H-X	D2.34	LCD500-12EH-6	D2.34	LCDN2/0-56D-X	D2.37
	LCD250-38D-X	D2.32	LCD500-12F-6	D2.36	LCDN350-38D-X	D2.37
	LCD250-38DF-X	D2.36	LCD500-12H-6	D2.34	LCDN500-12D-6	D2.37
D1. Terminals	LCD250-38DH-X	D2.34	LCD500-14B-6	D2.32	LCDN500-38D-6	D2.37
	LCD3/0-00-X	D2.40	LCD500-14BF-6	D2.36	LCDN750-12D-6	D2.37
	LCD3/0-12-X	D2.32	LCD500-14BH-6	D2.34	LCDN750-12DF-6	D2.39
	LCD3/0-12F-X	D2.36	LCD500-38D-6	D2.32	LCDN750-12DH-6	D2.38
	LCD3/0-12H-X	D2.34	LCD500-38DF-6	D2.36	LCDN750-38D-6	D2.37
	LCD3/0-14B-X	D2.32	LCD500-38DH-6	D2.34	LCDN750-38DF-6	D2.39
D2. Power Connectors	LCD3/0-14BF-X	D2.36	LCD6-10A-L	D2.31	LCDN750-38DH-6	D2.38
	LCD3/0-14BH-X	D2.34	LCD6-10AF-L	D2.35	LCDX1-12-X	D2.82
	LCD3/0-38D-X	D2.32	LCD6-10AH-L	D2.33	LCDX1-12F-X	D2.86
	LCD3/0-38DF-X	D2.36	LCD6-10B-L	D2.31	LCDX1-12H-X	D2.84
	LCD3/0-38DH-X	D2.34	LCD6-10BF-L	D2.35	LCDX1-14A-X	D2.82
	LCD3/0-56D-X	D2.32	LCD6-10BH-L	D2.33	LCDX1-14AF-X	D2.86
D3. Grounding Connectors	LCD3/0-56DF-X	D2.36	LCD6-10B-L	D2.31	LCDX1-14AH-X	D2.84
	LCD3/0-56DH-X	D2.34	LCD6-10DF-L	D2.35	LCDX1-14B-X	D2.82
	LCD300-00-X	D2.40	LCD6-10DH-L	D2.33	LCDX1-14BF-X	D2.86
	LCD300-12-X	D2.32	LCD6-14A-L	D2.31	LCDX1-14BH-X	D2.84
	LCD300-12F-X	D2.36	LCD6-14AF-L	D2.35	LCDX1-14D-X	D2.82
	LCD300-12H-X	D2.34	LCD6-14AH-L	D2.33	LCDX1-14DF-X	D2.86
E1. Labeling Systems	LCD300-38D-X	D2.32	LCD6-14B-L	D2.31	LCDX1-14DH-X	D2.84
	LCD300-38DF-X	D2.36	LCD6-14BF-L	D2.35	LCDX1-38D-X	D2.82
	LCD300-38DH-X	D2.34	LCD6-14BH-L	D2.33	LCDX1-38DF-X	D2.86
	LCD350-00-X	D2.40	LCD6-14D-L	D2.31	LCDX1-38DH-X	D2.84
	LCD350-12-X	D2.32	LCD6-14DF-L	D2.35	LCDX1-56D-X	D2.82
	LCD350-12E-X	D2.32	LCD6-14DH-L	D2.33	LCDX1-56DF-X	D2.86
E2. Labels	LCD350-12F-X	D2.36	LCD6-38D-L	D2.31	LCDX1-56DH-X	D2.84
	LCD350-12H-X	D2.34	LCD6-38DF-L	D2.35	LCDX1/0-12-X	D2.83
	LCD350-38D-X	D2.32	LCD6-38DH-L	D2.33	LCDX1/0-12D-X	D2.83
	LCD350-38DF-X	D2.36	LCD6-56D-L	D2.31	LCDX1/0-12DF-X	D2.87
E3. Pre-Printed & Write-On Markers	LCD350-38DH-X	D2.34	LCD6-56DF-L	D2.35	LCDX1/0-12DH-X	D2.85
	LCD350-56D-X	D2.40	LCD6-56DH-L	D2.33	LCDX1/0-12H-X	D2.87
	LCD350-56DF-X	D2.36	LCD600-00-6	D2.40	LCDX1/0-12H-X	D2.85
	LCD350-56DH-X	D2.34	LCD600-12-6	D2.32	LCDX1/0-14A-X	D2.83
E4. Permanent Identification	LCD350-14B-X	D2.32	LCD600-12F-6	D2.36	LCDX1/0-14AF-X	D2.87
	LCD350-14BF-X	D2.36	LCD600-12H-6	D2.34	LCDX1/0-14AH-X	D2.85
	LCD350-14BH-X	D2.34	LCD600-38D-6	D2.32	LCDX1/0-14B-X	D2.83
	LCD350-14DH-X	D2.34	LCD600-38DF-6	D2.36	LCDX1/0-14BF-X	D2.87
E5. Lockout/Tagout & Safety Solutions	LCD350-38D-X	D2.32	LCD600-38DH-6	D2.34	LCDX1/0-14BH-X	D2.85
	LCD350-38DF-X	D2.36	LCD750-00-6	D2.40	LCDX1/0-38D-X	D2.83
	LCD350-38DH-X	D2.34	LCD750-12-6	D2.32	LCDX1/0-38DF-X	D2.87
	LCD4-10A-L	D2.31	LCD750-38D-6	D2.32	LCDX1/0-38DH-X	D2.85
F. Index	LCD4-10AF-L	D2.35	LCD750-58G-6	D2.32	LCDX1/0-56B-X	D2.83
	LCD4-10AH-L	D2.33				
	LCD4-10B-L	D2.31				
	LCD4-10BF-L	D2.35				

Part Number	Page Number
LCDX1/0-56BF-X	D2.87
LCDX1/0-56BH-X	D2.85
LCDX1/0-56D-X	D2.83
LCDX1/0-56DF-X	D2.87
LCDX1/0-56DH-X	D2.85
LCDX2-12-E	D2.82
LCDX2-12F-E	D2.86
LCDX2-12H-E	D2.84
LCDX2-14A-E	D2.82
LCDX2-14AF-E	D2.86
LCDX2-14AH-E	D2.84
LCDX2-14B-E	D2.82
LCDX2-14BF-E	D2.86
LCDX2-14BH-E	D2.84
LCDX2-14D-E	D2.82
LCDX2-14DF-E	D2.86
LCDX2-14DH-E	D2.84
LCDX2-38D-E	D2.82
LCDX2-38DF-E	D2.86
LCDX2-38DH-E	D2.84
LCDX2-56D-E	D2.82
LCDX2-56DF-E	D2.86
LCDX2-56DH-E	D2.84
LCDX2/0-12-X	D2.83
LCDX2/0-12D-X	D2.83
LCDX2/0-12DF-X	D2.87
LCDX2/0-12DH-X	D2.85
LCDX2/0-12F-X	D2.87
LCDX2/0-12H-X	D2.85
LCDX2/0-14A-X	D2.83
LCDX2/0-14AF-X	D2.87
LCDX2/0-14AH-X	D2.85
LCDX2/0-14B-X	D2.83
LCDX2/0-14BF-X	D2.87
LCDX2/0-14BH-X	D2.85
LCDX2/0-38D-X	D2.83
LCDX2/0-38DF-X	D2.87
LCDX2/0-38DH-X	D2.85
LCDX2/0-56D-X	D2.83
LCDX2/0-56DF-X	D2.87
LCDX2/0-56DH-X	D2.85
LCDX250-12-X	D2.83
LCDX250-12E-X	D2.83
LCDX250-12EF-X	D2.87
LCDX250-12EH-X	D2.85
LCDX250-12F-X	D2.87
LCDX250-12H-X	D2.85
LCDX250-38-X	D2.83
LCDX250-38D-X	D2.83
LCDX250-38DF-X	D2.87
LCDX250-38DH-X	D2.85
LCDX250-38F-X	D2.87
LCDX250-38H-X	D2.85
LCDX3/0-12-X	D2.83
LCDX3/0-12F-X	D2.87
LCDX3/0-12H-X	D2.85
LCDX3/0-14A-X	D2.83
LCDX3/0-14AF-X	D2.87
LCDX3/0-14AH-X	D2.85
LCDX3/0-38D-X	D2.83
LCDX3/0-38DF-X	D2.87
LCDX3/0-38DH-X	D2.85
LCDX3/0-56D-X	D2.83
LCDX3/0-56DF-X	D2.87
LCDX3/0-56DH-X	D2.85
LCDX300-12-6	D2.83
LCDX300-12F-6	D2.87
LCDX300-12H-6	D2.85
LCDX300-38D-6	D2.83
LCDX300-38DF-6	D2.87
LCDX300-38DH-6	D2.85
LCDX350-12-6	D2.83
LCDX350-12E-6	D2.83
LCDX350-12EF-6	D2.87
LCDX350-12EH-6	D2.85
LCDX350-12F-6	D2.87
LCDX350-12H-6	D2.85

Part Number	Page Number
LCDX350-38-6	D2.83
LCDX350-38D-6	D2.83
LCDX350-38DF-6	D2.87
LCDX350-38DH-6	D2.85
LCDX350-38F-6	D2.87
LCDX350-38H-6	D2.85
LCDX350-56D-6	D2.83
LCDX350-56DF-6	D2.87
LCDX350-56DH-6	D2.85
LCDX4-14A-L	D2.82
LCDX4-14AF-L	D2.86
LCDX4-14AH-L	D2.84
LCDX4-14B-L	D2.82
LCDX4-14BF-L	D2.86
LCDX4-14BH-L	D2.84
LCDX4-14D-L	D2.82
LCDX4-14DF-L	D2.86
LCDX4-14DH-L	D2.84
LCDX4-38D-L	D2.82
LCDX4-38DF-L	D2.86
LCDX4-38DH-L	D2.84
LCDX4-56D-L	D2.82
LCDX4-56DF-L	D2.86
LCDX4-56DH-L	D2.84
LCDX4/0-12-X	D2.83
LCDX4/0-12D-X	D2.83
LCDX4/0-12DF-X	D2.87
LCDX4/0-12DH-X	D2.85
LCDX4/0-12F-X	D2.83
LCDX4/0-12EH-X	D2.87
LCDX4/0-12H-X	D2.85
LCDX4/0-14A-X	D2.83
LCDX4/0-14AF-X	D2.87
LCDX4/0-14AH-X	D2.85
LCDX4/0-14B-X	D2.83
LCDX4/0-14BF-X	D2.87
LCDX4/0-14BH-X	D2.85
LCDX4/0-38D-X	D2.83
LCDX4/0-38DF-X	D2.87
LCDX4/0-38DH-X	D2.85
LCDX4/0-56D-X	D2.83
LCDX4/0-56DF-X	D2.87
LCDX4/0-56DH-X	D2.85
LCDX450-12-6	D2.83
LCDX450-12F-6	D2.87
LCDX450-12H-6	D2.85
LCDX450-38D-6	D2.83
LCDX450-38DF-6	D2.87
LCDX450-38DH-6	D2.85
LCDX500-12-6	D2.83
LCDX500-12E-6	D2.83
LCDX500-12EF-6	D2.87
LCDX500-12EH-6	D2.85
LCDX500-12F-6	D2.87
LCDX500-12H-6	D2.85
LCDX500-38D-6	D2.83
LCDX500-38DF-6	D2.87
LCDX500-38DH-6	D2.85
LCDX500-56D-6	D2.83
LCDX500-56DF-6	D2.87
LCDX500-56DH-6	D2.85
LCDX6-10A-L	D2.82
LCDX6-10AF-L	D2.86
LCDX6-10AH-L	D2.84
LCDX6-10B-L	D2.82
LCDX6-10BF-L	D2.86
LCDX6-10BH-L	D2.84
LCDX6-10G-L	D2.82
LCDX6-10GF-L	D2.86
LCDX6-10GH-L	D2.84
LCDX6-10H-L	D2.82
LCDX6-10PF-L	D2.86
LCDX6-10PH-L	D2.84
LCDX6-14A-L	D2.82
LCDX6-14AF-L	D2.86

Part Number	Page Number
LCDX6-14AH-L	D2.84
LCDX6-14B-L	D2.82
LCDX6-14BF-L	D2.86
LCDX6-14BH-L	D2.84
LCDX6-14D-L	D2.82
LCDX6-14DF-L	D2.86
LCDX6-14DH-L	D2.84
LCDX6-38D-L	D2.82
LCDX6-38DF-L	D2.86
LCDX6-38DH-L	D2.84
LCDX6-56D-L	D2.82
LCDX6-56DF-L	D2.86
LCDX6-56DH-L	D2.84
LCDX600-12-6	D2.83
LCDX600-12F-6	D2.87
LCDX600-12H-6	D2.85
LCDX650-12-6	D2.83
LCDX650-12F-6	D2.87
LCDX650-12H-6	D2.85
LCDX650-38D-6	D2.83
LCDX650-38DF-6	D2.87
LCDX650-38DH-6	D2.85
LCDX750-12-3	D2.83
LCDX750-12E-3	D2.83
LCDX750-12EF-3	D2.87
LCDX750-12EH-3	D2.85
LCDX750-12F-3	D2.87
LCDX750-12G-3	D2.83
LCDX750-12GF-3	D2.87
LCDX750-12GH-3	D2.85
LCDX750-12H-3	D2.85
LCDX750-38D-3	D2.83
LCDX750-38DF-3	D2.87
LCDX750-38DH-3	D2.85
LCDX750-58G-3	D2.83
LCDX750-58GF-3	D2.87
LCDX750-58GH-3	D2.85
LCDX8-10A-L	D2.82
LCDX8-10AF-L	D2.86
LCDX8-10AH-L	D2.84
LCDX8-14A-L	D2.82
LCDX8-14AF-L	D2.86
LCDX8-14AH-L	D2.84
LCDX8-14B-L	D2.82
LCDX8-14BF-L	D2.86
LCDX8-14BH-L	D2.84
LCDX8-14D-L	D2.82
LCDX8-14DF-L	D2.86
LCDX8-14DH-L	D2.84
LCDX8-38D-L	D2.82
LCDX8-38DF-L	D2.86
LCDX8-38DH-L	D2.84
LCDXN2-14A-E	D2.88
LCDXN2-14AF-E	D2.89
LCDXN2-14AH-E	D2.89
LCDXN350-38D-6	D2.88
LCDXN4/0-38D-X	D2.88
LCDXN500-38D-6	D2.88
LCDXN750-38D-3	D2.88
LCDXN750-38DF-3	D2.89
LCDXN750-38DH-3	D2.89
LCMA10-10-C	D2.108
LCMA10-5-C	D2.108
LCMA10-6-C	D2.108
LCMA10-8-C	D2.108
LCMA120-10-L	D2.108
LCMA120-12-L	D2.108
LCMA120-16-L	D2.108
LCMA120-8-L	D2.108
LCMA150-10-X	D2.108
LCMA150-12-X	D2.108
LCMA150-16-X	D2.108
LCMA150-20-X	D2.108
LCMA150-8-X	D2.108
LCMA16-10-C	D2.108
LCMA16-5-C	D2.108

A. System Overview
B1. Cable Ties
B2. Cable Accessories
B3. Stainless Steel Ties
C1. Wiring Duct
C2. Surface Raceway
C3. Abrasion Protection
C4. Cable Management
D1. Terminals
D2. Power Connectors
D3. Grounding Connectors
E1. Labeling Systems
E2. Labels
E3. Pre-Printed & Write-On Markers
E4. Permanent Identification
E5. Lockout/ Tagout & Safety Solutions
F. Index

# PANDUIT® ELECTRICAL SOLUTIONS

A. System Overview	Part Number	Page Number	Part Number	Page Number	Part Number	Page Number
B1. Cable Ties	LCMA16-6-C	D2.108	LCMD35-10-Q	D2.109	LS9-IB	E1.2
	LCMA16-8-C	D2.108	LCMD35-12-Q	D2.109	LS9-WS	E1.2
	LCMA185-10-X	D2.108	LCMD35-8CD-Q	D2.109	<b>LS9Q</b>	<b>E1.2</b>
B2. Cable Accessories	LCMA185-12-X	D2.108	LCMD400-00-5	D2.110	LTYK	D3.6
	LCMA185-16-X	D2.108	LCMD400-12-5	D2.110	LV-S-1G	C4.9
	LCMA185-20-X	D2.108	LCMD400-14-5	D2.110	LV-S-2G	C4.9
B3. Stainless Steel Ties	LCMA240-10-X	D2.108	LCMD400-16-5	D2.110	LV-W-1G	C4.9
	LCMA240-12-X	D2.108	LCMD50-00-X	D2.109	LV-W-2G	C4.9
	LCMA240-16-X	D2.108	LCMD50-10-X	D2.109	LWC100-A-L	B2.34
C1. Wiring Duct	LCMA240-20-X	D2.108	LCMD50-10CD-X	D2.109	LWC100-A-L14	B2.34
	LCMA25-10-C	D2.108	LCMD50-12-X	D2.109	LWC100-A-L20	B2.34
	LCMA25-6-C	D2.108	LCMD500-00-1	D2.110	LWC100-H25-L	B2.34
C2. Surface Raceway	LCMA25-8-C	D2.108	LCMD500-12-1	D2.110	LWC100-H25-L14	B2.34
	LCMA300-10-5	D2.108	LCMD500-14-1	D2.110	LWC100-H25-L20	B2.34
	LCMA300-12-5	D2.108	LCMD500-16-1	D2.110	LWC19-A-C	B2.34
C3. Abrasion Protection	LCMA300-16-5	D2.108	LCMD6-5CD-Q	D2.109	LWC19-A-C14	B2.34
	LCMA300-20-5	D2.108	LCMD630-00-1	D2.110	LWC19-A-C20	B2.34
	LCMA35-10-C	D2.108	LCMD630-12-1	D2.110	LWC19-H25-C	B2.34
C4. Cable Management	LCMA35-12-C	D2.108	LCMD630-14-1	D2.110	LWC19-H25-C14	B2.34
	LCMA35-6-C	D2.108	LCMD630-16-1	D2.110	LWC25-A-C	B2.34
	LCMA35-8-C	D2.108	LCMD70-00-X	D2.109	LWC25-A-C14	B2.34
D1. Terminals	LCMA400-12-5	D2.108	LCMD70-10-X	D2.109	LWC25-A-C20	B2.34
	LCMA400-16-5	D2.108	LCMD70-10CD-X	D2.109	LWC25-H25-C	B2.34
	LCMA400-20-5	D2.108	LCMD70-12-X	D2.109	LWC25-H25-C14	B2.34
D2. Power Connectors	LCMA50-10-L	D2.108	LCMD95-00-X	D2.109	LWC25-H25-C20	B2.34
	LCMA50-12-L	D2.108	LCMD95-10CD-X	D2.109	LWC38-A-C	B2.34
	LCMA50-6-L	D2.108	LCMD95-12-X	D2.109	LWC38-A-C14	B2.34
D3. Grounding Connectors	LCMA50-8-L	D2.108	LCMD95-14-X	D2.109	LWC38-A-C20	B2.34
	LCMA500-00-1	D2.108	LD10IW10-A	C2.76	LWC38-H25-C	B2.34
	LCMA500-12-1	D2.108	LD10IW6-A	C2.76	LWC38-H25-C14	B2.34
E1. Labeling Systems	LCMA500-16-1	D2.108	LD10IW8-A	C2.76	LWC38-H25-C20	B2.34
	LCMA500-20-1	D2.108	LD2P10IW10-A	C2.75	LWC50-A-L	B2.34
	LCMA6-5-C	D2.107	LD2P10IW8-A	C2.75	LWC50-A-L14	B2.34
E2. Labels	LCMA6-6-C	D2.107	LD3IW10-A	C2.76	LWC50-A-L20	B2.34
	LCMA6-8-C	D2.107	LD3IW6-A	C2.76	LWC50-H25-L	B2.34
	LCMA630-00-1	D2.108	LD3IW8-A	C2.76	LWC50-H25-L14	B2.34
E3. Pre-Printed & Write-On Markers	LCMA630-16-1	D2.108	LD5IW10-A	C2.76	LWC50-H25-L20	B2.34
	LCMA630-20-1	D2.108	LD5IW6-A	C2.76	LWC75-A-L	B2.34
	LCMA70-10-L	D2.108	LD5IW8-A	C2.76	LWC75-A-L14	B2.34
E4. Permanent Identification	LCMA70-12-L	D2.108	LDPH10IW10-A	C2.77	LWC75-A-L20	B2.34
	LCMA70-6-L	D2.108	LDPH10IW8-A	C2.77	LWC75-H25-L	B2.34
	LCMA70-8-L	D2.108	LDPH3IW10-A	C2.77	LWC75-H25-L14	B2.34
E5. Lockout/Tagout & Safety Solutions	LCMA95-10-L	D2.108	LDPH3IW8-A	C2.77	LWC75-H25-L20	B2.34
	LCMA95-12-L	D2.108	LDPH5IW10-A	C2.77		
	LCMA95-16-L	D2.108	LDPH5IW8-A	C2.77		
F. Index	LCMA95-8-L	D2.108	LDS3IW10-A	C2.78		
	LCMD10-00-Q	D2.109	LDS5IW10-A	C2.78		
	LCMD10-6CD-Q	D2.109	LHMS-S10-D	B2.17		
	LCMD10-8-Q	D2.109	LHMS-S5-D	B2.17		
	LCMD120-00-X	D2.110	LHMS-S6-D	B2.17		
	LCMD120-10CD-X	D2.110	<b>LI-112S-L</b>	<b>D3.24</b>		
	LCMD120-12-X	D2.110	<b>LI-252S-Q</b>	<b>D3.24</b>		
	LCMD120-14-X	D2.110	<b>LI-50S-C</b>	<b>D3.24</b>		
	LCMD150-00-X	D2.110	LMD3IW-Q	C2.78		
	LCMD150-10CD-X	D2.110	LMD5IW-Q	C2.78		
	LCMD150-12-X	D2.110	LPFCM14-A-C14	B2.37		
	LCMD150-14-X	D2.110	LPFCM22-A-C14	B2.37		
	LCMD16-00-Q	D2.109	LPFCM34-A-C14	B2.37		
	LCMD16-6CD-Q	D2.109	LPMM-S2-C	B2.14		
	LCMD16-8-Q	D2.109	LPMM-S5-C	B2.14		
	LCMD185-00-X	D2.110	LPMS-S8-C	B2.14		
	LCMD185-10CD-X	D2.110	LS8-CASE	E1.2		
	LCMD185-12-X	D2.110	LS8-CLN	E1.2		
	LCMD185-14-X	D2.110	LS8-IB	E1.2		
	LCMD240-00-5	D2.110	LS8-PCKIT	E1.2		
	LCMD240-10CD-5	D2.110	LS8-WS	E1.2		
	LCMD240-12-5	D2.110	LS8E	E1.2		
	LCMD240-14-5	D2.110	LS8E-ACS	E1.2		
	LCMD25-00-Q	D2.109	LS8E-KIT	E1.2		
	LCMD25-10-Q	D2.109	<b>LS8E-KIT-ACS</b>	<b>E1.2</b>		
	LCMD25-12-Q	D2.109	<b>LS8EQ</b>	<b>E1.2</b>		
	LCMD25-8-Q	D2.109	<b>LS8EQ-KIT</b>	<b>E1.2</b>		
	LCMD25-8CD-Q	D2.109	<b>LS8EQ-KIT-ACS</b>	<b>E1.2</b>		
	LCMD300-00-5	D2.110	LS9	E1.2		
	LCMD300-12-5	D2.110	LS9-ACS	E1.2		
	LCMD300-14-5	D2.110	LS9-CASE	E1.2		
	LCMD35-00-Q	D2.109	LS9-CLN	E1.2		
					<b>M</b>	
					M200X050Y6T	E2.10
					M200X050Y7T	E2.10
					M200X100Y6T	E2.10
					M200X100Y7T	E2.10
					M300X050Y6C	E1.7
					M300X050Y6T	E2.10
					M300X050Y7C	E1.7
					M300X050Y7T	E2.10
					M300X100Y6T	E2.10
					M300X100Y7T	E2.10
					MACC25-A-C	B2.33
					MACC25-AV-D	B2.33
					MACC62-A-C	B2.33
					MACC62-AV-C	B2.33
					MBCEH-QR316	B3.13
					MBCH-QR316	B3.13
					MBCSH-QR316	B3.13
					MBEH-TLR	B3.12
					MBEH-TLR316	B3.12
					MBH-TLR316	B3.12
					MBH-MR	B3.12
					MBH-MR316	B3.12
					MBH-TLR	B3.12
					MBH-TLR316	B3.12
					MBM-H25-Q	B3.28
					MBMS-S10-CY	B2.19
					MBS-MR	B3.12
					MBS-MR316	B3.12
					MBS-TLR	B3.12
					MBS-TLR316	B3.12
					MBSH-TR	B3.12

# PANDUIT® ELECTRICAL SOLUTIONS

Part Number	Page Number
MBSH-TR316	B3.12
MC100X100IG2	C1.19
MC100X50IG2	C1.19
MC100X75IG2	C1.19
MC25X25IG2	C1.19
MC25X37IG2	C1.19
MC25X50IG2	C1.19
MC25X62IG2	C1.19
MC25X75IG2	C1.19
MC37X37IG2	C1.19
MC37X50IG2	C1.19
MC37X62IG2	C1.19
MC37X75IG2	C1.19
MC50X100IG2	C1.19
MC50X50IG2	C1.19
MC50X75IG2	C1.19
MC62X62IG2	C1.19
MC75X100IG2	C1.19
MC75X50IG2	C1.19
MC75X62IG2	C1.19
MC75X75IG2	C1.19
MCEH-S25-C0	B1.11, B1.24
MCMS12-P-C	B2.18
MCMS25-P-C	B2.18
MCMS30-P-C	B2.18
<b>MEHT187</b>	<b>E4.5</b>
META-X	E4.5
METS3-X	E4.5
METS4-X	E4.5
MIM094	E4.6
MIM125	E4.6
MIM187	E4.6
MIW094	E4.6
MIW125	E4.6
MIW187	E4.6
ML1/0-LY	D2.128
ML1/0T-LY	D2.129
ML250-QY	D2.128
ML250T-QY	D2.129
ML4-CY	D2.128
ML4T-CY	D2.129
ML8-CY	D2.128
ML8T-CY	D2.129
MLT10EH-LP	B3.6
MLT10EH15-LP	B3.6
MLT10H-LP	B3.6
MLT10H-LP316	B3.7
MLT10S-CP	B3.5
MLT10S-CP316	B3.6
MLT10SH-LP	B3.6
MLT12EH-Q	B3.6
MLT12EH15-Q	B3.6
MLT12H-Q	B3.6
MLT12S-Q	B3.5
MLT12SH-Q	B3.6
MLT14H-Q	B3.6
MLT14S-Q	B3.5
MLT15S-Q	B3.5
MLT1H-LPAL	B3.10
MLT1H-LPALBL	B3.10
MLT1H-LPALBU	B3.10
MLT1H-LPALGR	B3.10
MLT1H-LPALRD	B3.10
MLT1H-LPALYL	B3.10
MLT1S-CP	B3.5
MLT1S-CP316	B3.6
MLT2.7H-LP	B3.6
MLT2.7H-LP316	B3.7
MLT2.7S-CP	B3.5
MLT2.7S-CP316	B3.6
MLT2DH-L	B3.11
MLT2H-LP	B3.6
MLT2H-LP316	B3.7
MLT2H-LPAL	B3.10
MLT2H-LPALBL	B3.10
MLT2H-LPALBU	B3.10
MLT2H-LPALGR	B3.10

Part Number	Page Number
MLT2H-LPALRD	B3.10
MLT2H-LPALYL	B3.10
MLT2LH-LP	B3.6
MLT2LH-LP316	B3.6
MLT2S-CP	B3.5
MLT2S-CP316	B3.6
MLT2S-L	B3.5
MLT4DEH-Q	B3.11
MLT4DEH-Q316	B3.11
MLT4DEH15-Q	B3.11
MLT4DEH15-Q316	B3.11
MLT4DH-L	B3.11
MLT4DSH-Q	B3.11
MLT4DSH-Q316	B3.11
MLT4EH-LP	B3.6
MLT4EH-LP316	B3.7
MLT4EH15-LP	B3.6
MLT4EH15-LP316	B3.7
MLT4H-LP	B3.6
MLT4H-LP316	B3.7
MLT4H-LPAL	B3.10
MLT4H-LPALBL	B3.10
MLT4H-LPALBU	B3.10
MLT4H-LPALGR	B3.10
MLT4H-LPALRD	B3.10
MLT4H-LPALYL	B3.10
MLT4LH-LP	B3.6
MLT4LH-LP316	B3.6
MLT4S-CP	B3.5
MLT4S-CP316	B3.6
MLT4S-L	B3.5
MLT4SH-LP	B3.6
MLT4SH-LP316	B3.7
MLT5DH-L	B3.11
MLT6DEH-Q	B3.11
MLT6DEH-Q316	B3.11
MLT6DEH15-Q	B3.11
MLT6DEH15-Q316	B3.11
MLT6DH-Q	B3.11
MLT6DSH-Q	B3.11
MLT6DSH-Q316	B3.11
MLT6EH-LP	B3.6
MLT6EH-LP316	B3.7
MLT6EH15-LP	B3.6
MLT6EH15-LP316	B3.7
MLT6H-LP	B3.6
MLT6H-LP316	B3.7
MLT6LH-LP	B3.6
MLT6LH-LP316	B3.6
MLT6S-CP	B3.5
MLT6S-CP316	B3.6
MLT6SH-LP	B3.6
MLT6SH-LP316	B3.7
MLT8DEH-Q	B3.11
MLT8DEH-Q316	B3.11
MLT8DEH15-Q	B3.11
MLT8DEH15-Q316	B3.11
MLT8DSH-Q	B3.11
MLT8DSH-Q316	B3.11
MLT8EH-LP	B3.6
MLT8EH-LP316	B3.7
MLT8EH15-LP	B3.6
MLT8EH15-LP316	B3.7
MLT8H-LP	B3.6
MLT8H-LP316	B3.7
MLT8LH-LP	B3.6
MLT8LH-LP316	B3.6
MLT8S-CP	B3.5
MLT8S-CP316	B3.6
MLT8SH-LP	B3.6
MLT8SH-LP316	B3.7
MLTC10H-LP316	B3.9
MLTC2H-LP316	B3.9
MLTC4H-LP316	B3.9
MLTC6H-LP316	B3.9
MLTC8H-LP316	B3.9
MLTFC2H-LP316	B3.8

Part Number	Page Number
<b>MLTFC2H-LP316BU</b>	<b>B3.8</b>
<b>MLTFC2H-LP316GR</b>	<b>B3.8</b>
<b>MLTFC2H-LP316RD</b>	<b>B3.8</b>
<b>MLTFC2H-LP316WH</b>	<b>B3.8</b>
<b>MLTFC2H-LP316YL</b>	<b>B3.8</b>
MLTFC2S-CP316	B3.8
MLTFC4EH-LP316	B3.8
MLTFC4H-LP316	B3.8
<b>MLTFC4H-LP316BU</b>	<b>B3.8</b>
<b>MLTFC4H-LP316GR</b>	<b>B3.8</b>
<b>MLTFC4H-LP316RD</b>	<b>B3.8</b>
<b>MLTFC4H-LP316WH</b>	<b>B3.8</b>
<b>MLTFC4H-LP316YL</b>	<b>B3.8</b>
MLTFC4S-CP316	B3.8
MLTFC4SH-LP316	B3.8
MLTFC6EH-LP316	B3.8
MLTFC6H-LP316	B3.8
<b>MLTFC6H-LP316BU</b>	<b>B3.8</b>
<b>MLTFC6H-LP316GR</b>	<b>B3.8</b>
<b>MLTFC6H-LP316RD</b>	<b>B3.8</b>
<b>MLTFC6H-LP316WH</b>	<b>B3.8</b>
<b>MLTFC6H-LP316YL</b>	<b>B3.8</b>
MLTFC6S-CP316	B3.8
MLTFC6SH-LP316	B3.8
MLTFC8EH-LP316	B3.8
MLTFC8H-LP316	B3.8
MLTFC8S-CP316	B3.8
MLTFC8SH-LP316	B3.8
MMP172-C	E4.3
MMP172-C316	E4.3
MMP172W38-C	E4.3
MMP172W38-C316	E4.3
MMP350-C	E4.3
MMP350-C316	E4.3
MMP350DB-C	E4.3
MMP350DB-C316	E4.3
MMP350H-C	E4.3
MMP350H-C316	E4.3
MMP350H-CAL	E4.5
MMP350H-CALBL	E4.5
MMP350H-CALBU	E4.5
MMP350H-CALGR	E4.5
MMP350H-CALRD	E4.5
MMP350H-CALYL	E4.5
MMP350H-M	E4.6
MMP350H-M316	E4.6
MMP350H-MAL	E4.6
MMP350H-MALBL	E4.6
MMP350H-MALBU	E4.6
MMP350H-MALGR	E4.6
MMP350H-MALRD	E4.6
MMP350H-MALYL	E4.6
MMP350HW54-MAL	E4.6
MMP350-M	E4.6
MMP350-M316	E4.6
MMP350W17-Q	E4.3
MMP350W38-C	E4.3
MMP350W38-C316	E4.3
MMP350W38-M	E4.6
MMP350W38-M316	E4.6
MP150-C	B2.29
MP150-C0	B2.29
MP150-R	B2.29
MP175-C	B2.29
MP175-C0	B2.29
MP175-R	B2.29
MP1G106WH	C2.17
MP1GBWH	C2.17
MP1GRWH	C2.17
MP1TSWH	C2.17
MP200-C	B2.29
MP200-C0	B2.29
MP200-R	B2.29
MP250-C	B2.29
MP250-C0	B2.29
MP250-R	B2.29
MP250W175-C	B2.29

A. System Overview
B1. Cable Ties
B2. Cable Accessories
B3. Stainless Steel Ties
C1. Wiring Duct
C2. Surface Raceway
C3. Abrasion Protection
C4. Cable Management
D1. Terminals
D2. Power Connectors
D3. Grounding Connectors
E1. Labeling Systems
E2. Labels
E3. Pre-Printed & Write-On Markers
E4. Permanent Identification
E5. Lockout/ Tagout & Safety Solutions
F. Index

A. System Overview	Page Number		Part Number	Page Number		Part Number	Page Number	
	Part Number	Page Number		Part Number	Page Number		Part Number	Page Number
B1. Cable Ties	MP2G106BWH	C2.17	MS8W63T15-L6	B3.23	MTP3S-E10-C	B2.16		
	MP2G106RWH	C2.17	<b>MS8W75T30-Q2</b>	<b>B3.23</b>	MTP3S-E6-C	B2.16		
	MP2G106TSWH	C2.17	MSBW38-C4	B3.25	MTP4H-E10-C	B2.16		
	MP2G106WH	C2.17	MSBW38-C6	B3.25	MTP4H-E6-C	B2.16		
	MP2GBWH	C2.17	MSBW50-C4	B3.25	MTP4S-E10-C	B2.16		
B2. Cable Accessories	MP2GRBWH	C2.17	MSBW50-C6	B3.25	MTP4S-E6-C	B2.16		
	MP2GRTSWH	C2.17	MSBW63-C4	B3.25	MTP5H-E10-C	B2.16		
	MP2GRWH	C2.17	MSBW63-C6	B3.25	MTP5H-E6-C	B2.16		
	MP2TSWH	C2.17	<b>MSBW75-C2</b>	<b>B3.25</b>	MTP5S-E10-C	B2.16		
	MP350-C	B2.29	MSC10W38T15-L6	B3.24	MTP5S-E6-C	B2.16		
B3. Stainless Steel Ties	MP350-C0	B2.29	MSC10W50T15-L6	B3.24	MTP6H-E10-C	B2.16		
	MP3G1062TSWH	C2.17	MSC10W63T15-L6	B3.24	MTP6H-E6-C	B2.16		
	MP3G106WH	C2.17	MSC2W38T15-L6	B3.24	MTPC1H-E10-C39	B2.16		
	MP3GRWH	C2.17	MSC4W38T15-L6	B3.24	MTPC2H-E10-C39	B2.16		
	MP3TSWH	C2.17	MSC4W50T15-L6	B3.24	MTPC3H-E10-C39	B2.16		
C1. Wiring Duct	MPMH38-L0	B2.21	MSC4W63T15-L6	B3.24	MTPC4H-E10-C39	B2.16		
	MPMS19-C0	B2.21	MSC6W38T15-L6	B3.24	MTPC5H-E10-C39	B2.16		
	MPMS25-C0	B2.21	MSC6W50T15-L6	B3.24	MTPC6H-E10-C39	B2.16		
	MPMWH32-L0	B2.21	MSC6W63T15-L6	B3.24	MTRTH	B3.20		
	MPWM-H56-Q	B3.27	MSC8W38T15-L6	B3.24	MTRTLS	B3.20		
C2. Surface Raceway	<b>MRS1.5H-L4</b>	<b>B3.19</b>	MSC8W50T15-L6	B3.24				
	<b>MRS1.5LH-L4</b>	<b>B3.19</b>	MSC8W63T15-L6	B3.24	<b>N</b>			
	<b>MRS1S-C4</b>	<b>B3.19</b>	MSCNW38T15-QR6	B3.25	N025X075CBT	E2.11		
	<b>MRS2H-L4</b>	<b>B3.19</b>	MSCNW50T15-QR6	B3.25	N025X075FJJ	E2.4		
	<b>MRS2LH-L4</b>	<b>B3.19</b>	MSCNW63T15-QR6	B3.25	N025X125CBT	E2.11		
C3. Abrasion Protection	<b>MRS2S-C4</b>	<b>B3.19</b>	MSG-1.3-C	C4.10	N025X125FJJ	E2.4		
	<b>MRS4H-L4</b>	<b>B3.19</b>	MSGV-1.3-C	C4.10	N025X150CBT	E2.11		
	<b>MRS4LH-L4</b>	<b>B3.19</b>	MSPT-1.3	C4.10	N025X150FJJ	E2.4		
	<b>MRS4S-C4</b>	<b>B3.19</b>	MSW38T15-CR4	B3.25	N025X175CBT	E2.11		
	<b>MRS6H-L4</b>	<b>B3.19</b>	MSW38T15-CR6	B3.25	N050X075CBC	E1.6		
C4. Cable Management	<b>MRS6LH-L4</b>	<b>B3.19</b>	MSW50T15-CR4	B3.25	N050X075CBB	E2.11		
	<b>MRS6S-C4</b>	<b>B3.19</b>	MSW50T15-CR6	B3.25	N050X075CCT	E2.4		
	MRT1.5DS-C4	B3.18	MSW63T15-CR4	B3.25	N050X100CBT	E2.11		
	<b>MRT1.5H-L4</b>	<b>B3.18</b>	MSW63T15-CR6	B3.25	N050X125CBT	E2.11		
	<b>MRT1.5LH-L4</b>	<b>B3.18</b>	<b>MSW75T30-CR2</b>	<b>B3.25</b>	N050X125FJJ	E2.4		
D1. Terminals	<b>MRT1S-C4</b>	<b>B3.18</b>	MT125S-Q	E4.4	N050X150CBC	E1.6		
	MRT2.5DLH-L4	B3.18	MT150D-Q	E4.4	N050X150CBB	E2.11		
	MRT2.5DS-C4	B3.18	MT150D-Q316	E4.4	N050X150CCT	E2.4, E2.5		
	MRT2DH-L4	B3.18	MT172-C	E4.4	N050X150FJJ	E2.11		
	<b>MRT2H-L4</b>	<b>B3.18</b>	MT172-C316	E4.4	N100X075CBT	E2.4		
D2. Power Connectors	<b>MRT2LH-L4</b>	<b>B3.18</b>	MT172W38-C	E4.4	N100X075CCT	E2.11		
	<b>MRT2S-C4</b>	<b>B3.18</b>	MT1D-Q	E4.4	N100X075FJJ	E2.4		
	MRT4DH-L4	B3.18	MT1D-Q316	E4.4	N100X125CBC	E1.6		
	<b>MRT4H-L4</b>	<b>B3.18</b>	MT213D-Q	E4.4	N100X125CCT	E2.11		
	<b>MRT4LH-L4</b>	<b>B3.18</b>	MT213D-Q316	E4.4	N100X125FJJ	E2.4		
D3. Grounding Connectors	<b>MRT4S-C4</b>	<b>B3.18</b>	MT350-C	E4.4	N100X150CBC	E1.6		
	<b>MRT6H-L4</b>	<b>B3.18</b>	MT350-C316	E4.4	N100X150CCT	E2.11		
	<b>MRT6LH-L4</b>	<b>B3.18</b>	MT350W17-Q	E4.4	N100X150FJJ	E2.4, E2.5		
	<b>MRT6S-C4</b>	<b>B3.18</b>	MTB150D-Q	E4.4	N100X175CBC	E1.6		
	MS10W38T15-L4	B3.23	MTB1D-Q	E4.4	N100X175CCT	E2.11		
E1. Labeling Systems	MS10W38T15-L6	B3.23	MTB213D-Q	E4.4	NC.5WH6	C1.24		
	MS10W50T15-L4	B3.23	MTHCEH-C316	B3.13	NC1.5WH6	C1.24		
	MS10W50T15-L6	B3.23	MTHCH-C316	B3.13	NC100LG2	C1.23		
	MS10W63T15-L4	B3.23	MTHCSH-C316	B3.13	NC1WH6	C1.24		
	MS10W63T15-L6	B3.23	MTHEH-C	B3.13	NC25LG2	C1.23		
E2. Labels	<b>MS10W75T30-Q2</b>	<b>B3.23</b>	MTHEH-C316	B3.13	NC2WH6	C1.24		
	MS2W38T15-L4	B3.23	MTHH-C	B3.13	NC37LG2	C1.23		
	MS2W38T15-L6	B3.23	MTHH-C316	B3.13	NC3WH6	C1.24		
	MS4W38T15-L4	B3.23	MTHS-C	B3.13	NC4WH6	C1.24		
	MS4W38T15-L6	B3.23	MTHS-C316	B3.13	NC50LG2	C1.23		
E3. Pre-Printed & Write-On Markers	MS4W50T15-L4	B3.23	MTHSH-C	B3.13	NC75LG2	C1.23		
	MS4W50T15-L6	B3.23	MTHSH-C316	B3.13	NE.5X.5WH6	C1.24		
	MS4W63T15-L4	B3.23	MTM1H10-C	B3.27	NE.5X1WH6	C1.24		
	MS4W63T15-L6	B3.23	MTM1H25-C	B3.27	NE1.5X1.5WH6	C1.24		
	<b>MS4W75T30-Q2</b>	<b>B3.23</b>	MTM1H-C	B3.27	NE1.5X2WH6	C1.24		
E4. Permanent Identification	MS6W38T15-L4	B3.23	MTM2H-Q	B3.28	NE1.5X2WH6-A	C1.33		
	MS6W38T15-L6	B3.23	MTMBH-Q	B3.29	NE1.5X3WH6	C1.24		
	MS6W50T15-L4	B3.23	MTP1H-E10-C	B2.15	NE1.5X4WH6	C1.24		
	MS6W50T15-L6	B3.23	MTP1H-E6-C	B2.15	NE1X1.5WH6	C1.24		
	MS6W63T15-L4	B3.23	MTP1S-E10-C	B2.15	NE1X1WH6	C1.24		
E5. Lockout/Tagout & Safety Solutions	MS6W63T15-L6	B3.23	MTP1S-E6-C	B2.15	NE1X2WH6	C1.24		
	<b>MS6W75T30-Q2</b>	<b>B3.23</b>	MTP2H-E10-C	B2.15	NE1X3WH6	C1.24		
	MS8W38T15-L4	B3.23	MTP2H-E6-C	B2.15	NE1X4WH6	C1.24		
	MS8W38T15-L6	B3.23	MTP2S-E10-C	B2.15	NE2X1WH6	C1.24		
	MS8W50T15-L4	B3.23	MTP2S-E6-C	B2.15	NE2X2WH6	C1.24		
F. Index	MS8W50T15-L6	B3.23	MTP3H-E10-C	B2.16	NE2X2WH6-A	C1.33		
	MS8W63T15-L4	B3.23	MTP3H-E6-C	B2.16	NE2X3WH6	C1.24		

Part Number	Page Number
NE2X4WH6	C1.24
NE3X1WH6	C1.24
NE3X2WH6	C1.24
NE3X3WH6	C1.24
NE3X4WH6	C1.24
NE3X5WH6	C1.24
NE4X2WH6	C1.24
NE4X2WH6-A	C1.33
NE4X3WH6	C1.24
NE4X3WH6-A	C1.33
NE4X4WH6	C1.24
NE4X4WH6-A	C1.33
NE4X5WH6	C1.24
NK2HSRFIW	C2.54
NK4HSRFIW	C2.54
NK4VSRFIW	C2.54
NNC100X100LG2	C1.23
NNC100X50LG2	C1.23
NNC100X75LG2	C1.23
NNC25X25LG2	C1.23
NNC25X37LG2	C1.23
NNC25X50LG2	C1.23
NNC25X75LG2	C1.23
NNC37X37LG2	C1.23
NNC37X50LG2	C1.23
NNC37X75LG2	C1.23
NNC50DWH2	C1.23, C1.27
NNC50X100LG2	C1.23
NNC50X50LG2	C1.23
NNC50X75LG2	C1.23
NNC75DWH2	C1.23, C1.27
NNC75X75LG2	C1.23
NR1-C	C1.34
NR1-M	C1.34
NR2WH-L	C1.59
NR4BL-L	C1.59

## O

OCF10IW-X	C2.79
OCF3IW-E	C2.79
OCF5IW-E	C2.79
OCF10IW-X	C2.81
OCFC3IW-X	C2.81
OCFC5IW-X	C2.81
OCFX10IW-X	C2.75, C2.80
OCFX3IW-X	C2.80
OCFX5IW-X	C2.80
OF70FH2OB	C2.101
OF70FH4OB	C2.101
OF70FV2OB	C2.101
OF70FV4OB	C2.101
OF70FCOB	C2.100
OF70FCOB6	C2.98
OF70FCOB6	C2.98
OFR20CCOB-X	C2.101
OFR20CPOB8	C2.99
OFR20CROB	C2.100
OFR20DMBOB	C2.100
OFR20DSOBB	C2.100
OFR20ECOB	C2.101
OFR20ICOB	C2.101
OFR20LCOB	C2.101
OFR20MPTOB	C2.100
OFR20OB6	C2.98
OFR20OB8	C2.98
OFR20OCOB	C2.101
OFR20OFCR70OB1	C2.99
OFR20OFCR70OB1P	C2.99
OFR20OFCR70OB2	C2.99
OFR20OFCR70OB2P	C2.99
OFR20OFCR70OB4	C2.99
OFR20OFCR70OB4P	C2.99
OFR20RAOB	C2.100
OFR20SOOB	C2.100
OFR20TOB	C2.100
OFR20WEOB	C2.100

Part Number	Page Number
OFVR5OB6	C2.98
<b>P</b>	
P10-10F-L	D1.29
P10-10FF-L	D1.30
P10-10LF-L	D1.30
P10-10R-L	D1.17
P10-10RHT6-L	D1.19
P10-10SLF-L	D1.31
P10-12R-L	D1.17
P10-14F-L	D1.29
P10-14LF-L	D1.30
P10-14R-L	D1.17
P10-14RHT6-L	D1.19
P10-14SLF-L	D1.31
P10-38R-L	D1.17
P10-56R-L	D1.17
P10-5SLF-L	D1.31
P10-610R-L	D1.18
P10-6F-L	D1.29
P10-6LF-L	D1.30
P10-6R-L	D1.17
P10-6RHT6-L	D1.19
P10-8F-L	D1.29
P10-8LF-L	D1.30
P10-8R-L	D1.17
P10-8RHT6-L	D1.19
P10-8SLF-L	D1.31
P10-P55-L	D1.54
P12-10HDR-L	D1.20
P12-14HDR-L	D1.20
P12-38HDR-L	D1.20
P12-56HDR-L	D1.20
P12-6HDR-L	D1.20
P12-8HDR-L	D1.20
P14-10F-C	D1.29
P14-10FN-C	D1.29
P14-10LF-C	D1.30
P14-10LFN-C	D1.30
P14-10R-C	D1.17
P14-10RHT6-C	D1.19
P14-10SLF-C	D1.31
P14-12R-L	D1.17
P14-14F-C	D1.29
P14-14R-C	D1.17
P14-14SLF-C	D1.31
P14-38R-C	D1.17
P14-4R-C	D1.17
P14-56R-C	D1.17
P14-610R-C	D1.18
P14-6F-C	D1.29
P14-6FF-C	D1.30
P14-6FN-C	D1.29
P14-6LF-C	D1.30
P14-6LFW-C	D1.30
P14-6R-C	D1.17
P14-6RHT6-C	D1.19
P14-6SLF-C	D1.31
P14-8F-C	D1.29
P14-8FF-C	D1.30
P14-8LF-C	D1.30
P14-8R-C	D1.17
P14-8RHT6-C	D1.19
P14-8SLF-C	D1.31
P14-P47-C	D1.54
P18-10F-C	D1.29
P18-10FN-C	D1.29
P18-10LF-C	D1.30
P18-10LFN-C	D1.30
P18-10R-C	D1.17
P18-10RHT6-C	D1.19
P18-10SLF-C	D1.31
P18-12R-C	D1.17
P18-14F-C	D1.29
P18-14R-C	D1.17
P18-38R-C	D1.17

Part Number	Page Number
P18-4R-C	D1.17
P18-56R-C	D1.17
P18-610R-C	D1.18
P18-6F-C	D1.29
P18-6FN-C	D1.29
P18-6LF-C	D1.30
P18-6LFW-C	D1.30
P18-6R-C	D1.17
P18-6RHT6-C	D1.19
P18-6RN-C	D1.17
P18-6SLF-C	D1.31
P18-8F-C	D1.29
P18-8FF-C	D1.30
P18-8LF-C	D1.30
P18-8R-C	D1.17
P18-8RHT6-C	D1.19
P18-8SLF-C	D1.31
P18-P47-C	D1.54
P2-10R-X	D1.20
P2-12R-X	D1.20
<b>P2-12RHT6-X</b>	<b>D1.19</b>
P2-14R-X	D1.20
<b>P2-14RHT6-X</b>	<b>D1.19</b>
P2-38R-X	D1.20
<b>P2-38RHT6-X</b>	<b>D1.19</b>
P2-56R-X	D1.20
<b>P2-56RHT6-X</b>	<b>D1.19</b>
P22-10R-C	D1.17
P22-2F-C	D1.29
P22-2R-C	D1.17
P22-4F-C	D1.29
P22-4R-C	D1.17
P22-6F-C	D1.29
P22-6R-C	D1.17
P22-8R-C	D1.17
P2NLT-500-3	D2.134
P32W2A2-100-7	C2.84
P32W2A2-100-72	C2.84
P32W2A2-50-7	C1.32, C2.84
P32W2A2-50-72	C1.32, C2.84
P32W2A2-75-7	C1.32, C2.84
P32W2A2-75-72	C1.32, C2.84
P32W2R1-100-7	C2.84
P32W2R1-100-72	C2.84
P32W2R1-150-72	C2.84
P32W2R1-50-7	C2.84
P32W2R1-50-72	C2.84
P32W2R1-75-7	C2.84
P32W2R1-75-72	C2.84
P4-10R-E	D1.20
<b>P4-10RHT6-E</b>	<b>D1.19</b>
P4-12R-E	D1.20
<b>P4-12RHT6-E</b>	<b>D1.19</b>
P4-14R-E	D1.20
<b>P4-14RHT6-E</b>	<b>D1.19</b>
P4-38R-E	D1.20
<b>P4-38RHT6-E</b>	<b>D1.19</b>
P4-56R-E	D1.20
<b>P4-56RHT6-E</b>	<b>D1.19</b>
P6-10R-E	D1.20
<b>P6-10RHT6-E</b>	<b>D1.19</b>
P6-12R-E	D1.20
<b>P6-12RHT6-E</b>	<b>D1.19</b>
P6-14R-E	D1.20
<b>P6-14RHT6-E</b>	<b>D1.19</b>
P6-38R-E	D1.20
<b>P6-38RHT6-E</b>	<b>D1.19</b>
P6-56R-E	D1.20
<b>P6-56RHT6-E</b>	<b>D1.19</b>
P6-8R-E	D1.20
<b>P6-8RHT6-E</b>	<b>D1.19</b>
P8-10R-Q	D1.20
<b>P8-10RHT6-Q</b>	<b>D1.19</b>
P8-12R-Q	D1.20
<b>P8-12RHT6-Q</b>	<b>D1.19</b>
P8-14R-Q	D1.20

## A. System Overview

### B1. Cable Ties

### B2. Cable Accessories

### B3. Stainless Steel Ties

### C1. Wiring Duct

### C2. Surface Raceway

### C3. Abrasion Protection

### C4. Cable Management

### D1. Terminals

### D2. Power Connectors

### D3. Grounding Connectors

### E1. Labeling Systems

### E2. Labels

### E3. Pre-Printed & Write-On Markers

### E4. Permanent Identification

### E5. Lockout/ Tagout & Safety Solutions

### F. Index

# PANDUIT® ELECTRICAL SOLUTIONS

A. System Overview	Part Number	Page Number	Part Number	Page Number	Part Number	Page Number
B1. Cable Ties	<b>P8-14RHT6-Q</b>	<b>D1.19</b>	PCA23-A-D	E3.12	PCM-175-199	E3.4
	P8-38R-Q	D1.20	PCA23-E-H	E3.12	PCM-19-36	E3.4
B2. Cable Accessories	<b>P8-38RHT6-Q</b>	<b>D1.19</b>	PCA23-L-L	E3.12	PCM-1L1 thru PCM-1L3	E3.6
	P8-56R-Q	D1.20	PCA23-M-P	E3.12	PCM-1T1 thru PCM-1T3	E3.6
B3. Stainless Steel Ties	<b>P8-56RHT6-Q</b>	<b>D1.19</b>	PCA23-MIN	E3.12	PCM-200-224	E3.4
	P8-8R-Q	D1.20	PCA23-PLS	E3.12	PCM-225-249	E3.4
C1. Wiring Duct	<b>P8-8RHT6-Q</b>	<b>D1.19</b>	PCA23-Q-T	E3.12	PCM-250-274	E3.4
	PARW125-RED	E5.31	PCA23-U-X	E3.12	PCM-275-299	E3.4
C2. Surface Raceway	PARW125-YEL	E5.31	PCA23-Y-Z	E3.12	PCM-2L1 thru PCM-2L3	E3.6
	PAT	B1.117	PCL037-0	E5.37	PCM-300-324	E3.4
C3. Abrasion Protection	PAT1.5M	B1.117	PCL037-0-9	E5.37	PCM-325-349	E3.4
	<b>PAT1.5M-ATM</b>	<b>B1.117</b>	PCL037-1	E5.37	PCM-34-66	E3.4
C4. Cable Management	PAT1M	B1.117	PCL037-9	E5.37	PCM-350-374	E3.4
	PAT2S	B1.117	PCL037-A	E5.37	PCM-375-399	E3.4
D1. Terminals	<b>PAT3S</b>	<b>B1.117</b>	PCL037-A-Z	E5.37	PCM-3T1 thru PCM-3T3	E3.6
	PATMBM	B1.118	PCL037-DSH	E5.37	PCM-400-424	E3.4
D2. Power Connectors	<b>PATM-RK</b>	<b>B1.119</b>	PCL062-0	E5.37	PCM-425-449	E3.4
	<b>PATM-RKS</b>	<b>B1.119</b>	PCL062-0-9	E5.37	PCM-450-474	E3.4
D3. Grounding Connectors	<b>PATM-TT</b>	<b>B1.119</b>	PCL062-1	E5.37	PCM-475-499	E3.4
	PATSBM	B1.118	PCL062-9	E5.37	PCM-4L1 thru PCM-4L3	E3.6
E1. Labeling Systems	PBDCT	C1.34	PCL062-A	E5.37	PCM-500-524	E3.4
	PBMS-H25-C	B2.20	PCL062-A-Z	E5.37	PCM-67-99	E3.4
E2. Labels	PBMS-H25-C14	B2.20	PCL062-DSH	E5.37	PCM-A thru PCM-Z	E3.5
	PBMS-H25-M0	B2.20	PCL062-Z	E5.37	PCM-A1 thru PCM-A4	E3.5
E3. Pre-Printed & Write-On Markers	PBMS-H25-M30	B2.20	PCL100-0	E5.37	PCM-A-Z	E3.5
	PBMSL-H25-C30	B2.20	PCL100-0-9	E5.37	PCM-A-Z-0-9	E3.5
E4. Permanent Identification	PBMSL-H25-M30	B2.20	PCL100-1	E5.37	PCM-BLK	E3.6
	PBSC1-X	B2.50	PCL100-9	E5.37	PCM-BRN	E3.6
E5. Lockout/Tagout & Safety Solutions	PBSC12-X	B2.50	PCL100-A	E5.37	PCM-DBL	E3.6
	PBSC3-X	B2.50	PCL100-A-J	E5.37	PCM-DGN	E3.6
F. Index	PBSC6-X	B2.50	PCL100-DSH	E5.37	PCM-GRY	E3.6
	<b>PBMT</b>	<b>B3.16</b>	PCL100-K-T	E5.37	PCM-LBL	E3.6
	PC038-H25D-C0	B2.39	PCL100-U-Z	E5.37	PCM-LGN	E3.6
	PC050-H25D-C0	B2.39	PCL100-Z	E5.37	PCM-ORN	E3.6
	PC062-H25D-C0	B2.39	PCL200-0	E5.37	PCM-PNK	E3.6
	PC075-H25D-C0	B2.39	PCL200-0-9	E5.37	PCM-PUR	E3.6
	PC087-H25D-C0	B2.39	PCL200-1	E5.37	PCM-RED	E3.6
	PC100-H25D-C0	B2.39	PCL200-9	E5.37	PCM-TAN	E3.6
	PC112-H25D-C0	B2.39	PCL200-A	E5.37	PCM-WHT	E3.6
	PC125-H25D-C0	B2.39	PCL200-A-J	E5.37	PCM-YEL	E3.6
	PCA07-0 thru PCA07-9	E3.11	PCL200-DSH	E5.37	PCMB-1	E3.2
	PCA07-0-9	E3.11	PCL200-K-T	E5.37	PCM-B1 thru PCM-B5	E3.5
	PCA07-A thru PCA07-Z	E3.11	PCL200-U-Z	E5.37	PCMB-10	E3.2
	PCA07-A-J	E3.11	PCL200-Z	E5.37	PCMB-11	E3.2
	PCA07-K-T	E3.11	PCL300-0	E5.38	PCMB-12	E3.2
	PCA07-MIN	E3.11	PCL300-1	E5.38	PCMB-13	E3.2
	PCA07-PLS	E3.11	PCL300-9	E5.38	PCMB-14	E3.2
	PCA07-U-Z	E3.11	PCL300-A	E5.38	PCMB-15	E3.2
	PCA11-0 thru PCA11-9	E3.12	PCL300-DSH	E5.38	PCMB-16	E3.2
	PCA11-0-9	E3.12	PCL300-Z	E5.38	PCMB-2	E3.2
	PCA11-A thru PCA11-Z	E3.12	PCLCP037-0-9	E5.37	PCMB-25	E3.2
	PCA11-A-J	E3.12	PCLCP037-A-Z	E5.37	PCMB-3	E3.2
	PCA11-K-T	E3.12	PCLCP062-0-9	E5.37	PCMB-4	E3.2
	PCA11-MIN	E3.12	PCLCP062-A-Z	E5.37	PCMB-5	E3.2
	PCA11-PLS	E3.12	PCLCP100-0-9	E5.37	PCMB-6	E3.2
	PCA11-U-Z	E3.12	PCLCP100-A-Z	E5.37	PCMB-7	E3.2
	PCA13-0 thru PCA13-9	E3.12	PCLCP200-0-9	E5.37	PCMB-8	E3.2
	PCA13-0-9	E3.12	PCLCP200-A-Z	E5.37	PCMB-9	E3.2
	PCA13-A thru PCA13-Z	E3.12	PCLCP300-0-9	E5.38	PCM-C1 thru PCM-C4	E3.5
	PCA13-A-J	E3.12	PCLCP300-A-Z	E5.38	PCMCP-1-25	E3.7
	PCA13-K-T	E3.12	PCM-0 thru PCM-99	E3.4	PCMCP-101-125	E3.7
	PCA13-MIN	E3.12	PCM-0-9	E3.4	PCMCP-126-150	E3.7
	PCA13-PLS	E3.12	PCM-1-10	E3.4	PCMCP-26-50	E3.7
	PCA13-U-Z	E3.12	PCM-1-12	E3.4	PCMCP-51-75	E3.7
	PCA18-0 thru PCA18-9	E3.12	PCM-1-16	E3.4	PCMCP-76-100	E3.7
	PCA18-0-9	E3.12	PCM-1-18	E3.4	PCMCP-A-Z	E3.7
	PCA18-A thru PCA18-Z	E3.12	PCM-1-3	E3.4	PCM-E1 thru PCM-E3	E3.5
	PCA18-A-J	E3.12	PCM-1-33	E3.4	PCM-F1 thru PCM-F4	E3.5
	PCA18-K-T	E3.12	PCM-1-4	E3.4	PCMH-0 thru PCMH-25	E3.4
	PCA18-MIN	E3.12	PCM-1-5	E3.4	PCM-H1 thru PCM-H5	E3.5
	PCA18-PLS	E3.12	PCM-1-6	E3.4	PCMH-3L1 thru PCMH-3L3	E3.6
	PCA18-U-Z	E3.12	PCM-1-8	E3.4	PCM-L1 thru PCM-L5	E3.5
	PCA23-0 thru PCA23-9	E3.12	PCM-1-9	E3.4	PCM-M1 thru PCM-M2	E3.5
	PCA23-0-3	E3.12	PCM-100 thru PCM-202	E3.4	PCM-P1 thru PCM-P3	E3.5
	PCA23-4-7	E3.12	PCM-100-124	E3.4	PCM-R1 thru PCM-R5	E3.5
	PCA23-8-9	E3.12	PCM-125-149	E3.4	PCM-S1 thru PCM-S5	E3.5
	PCA23-A thru PCA23-Z	E3.12	PCM-150-174	E3.4	PCM-T1 thru PCM-T9	E3.5



# PANDUIT® ELECTRICAL SOLUTIONS

Part Number	Page Number	Part Number	Page Number	Part Number	Page Number
PCM-X1 thru PCM-X4	E3.5	PCSB4-3S-12Y	D2.149	PCSSH-B-CR	B3.26
PCPA11IW	C2.107	PCSB4-4-6Y	D2.150	PCV-110AY	E5.32
PCPA11R20IW	C2.104	PCSB4-4S-6Y	D2.149	PCV-110BY	E5.32
PCPA13IW	C2.107	PCSB4-5-6Y	D2.150	PCV-110CY	E5.32
PCPA13R20IW	C2.104	PCSB4-5S-6Y	D2.149	PCV-115AY	E5.32
PCPAK16IW	C2.110	PCSB4-6-6Y	D2.150	PCV-115BY	E5.32
PCPAK22IW	C2.110	PCSB4-6S-6Y	D2.149	PCV-115CY	E5.32
PCPAKR20IW	C2.110	PCSB4-8-4Y	D2.150	PCV-120/208AY	E5.32
PCPAKRIW	C2.110	PCSB600-10-1Y	D2.151	PCV-120/208BY	E5.32
PCPBRC	C2.111	PCSB600-10S-1Y	D2.149	PCV-120/208CY	E5.32
PCPECIW	C2.111	PCSB600-12-1Y	D2.151	PCV-120AY	E5.32
PCPKITIW	C2.111	PCSB600-12S-1Y	D2.149	PCV-120BY	E5.32
PCPTPIW	C2.111	PCSB600-14-1Y	D2.151	PCV-120CY	E5.32
PCSB2/0-10-2Y	D2.150	PCSB600-14S-1Y	D2.149	PCV-120RY	E5.32
PCSB2/0-10S-2Y	D2.149	PCSB600-2-4Y	D2.151	PCV-12470AY	E5.32
PCSB2/0-12-2Y	D2.150	PCSB600-2S-4Y	D2.149	PCV-12470BY	E5.32
PCSB2/0-12S-1Y	D2.149	PCSB600-3-3Y	D2.151	PCV-12470CY	E5.32
PCSB2/0-14-1Y	D2.150	PCSB600-3S-3Y	D2.149	PCV-13200AY	E5.32
PCSB2/0-14S-1Y	D2.149	PCSB600-4-2Y	D2.151	PCV-13200BY	E5.32
PCSB2/0-2-12	D2.150	PCSB600-4S-2Y	D2.149	PCV-13200CY	E5.32
PCSB2/0-2S-6	D2.149	PCSB600-5-2	D2.151	PCV-13800AY	E5.32
PCSB2/0-3-6	D2.150	PCSB600-5S-2Y	D2.149	PCV-13800BY	E5.32
PCSB2/0-3S-6Y	D2.149	PCSB600-6-2Y	D2.151	PCV-13800CY	E5.32
PCSB2/0-4-6	D2.150	PCSB600-6S-2Y	D2.149	PCV-1PHAY	E5.32
PCSB2/0-4S-6Y	D2.149	PCSB600-8-2Y	D2.151	PCV-1PHBY	E5.32
PCSB2/0-5-6	D2.150	PCSB600-8S-2Y	D2.149	PCV-1PHCY	E5.32
PCSB2/0-5S-4Y	D2.149	PCSB750-10-1Y	D2.151	PCV-208AY	E5.32
PCSB2/0-6-6	D2.150	PCSB750-2-2Y	D2.151	PCV-208BY	E5.32
PCSB2/0-6S-4Y	D2.149	PCSB750-2S-1	D2.149	PCV-208CY	E5.32
PCSB2/0-7-4	D2.156	PCSB750-3-2Y	D2.151	PCV-220AY	E5.32
PCSB2/0-8-4	D2.150	PCSB750-4-2Y	D2.151	PCV-220BY	E5.32
PCSB2/0-8S-3Y	D2.149	PCSB750-5-1Y	D2.151	PCV-220CY	E5.32
PCSB250-10-2Y	D2.150	PCSB750-6-1Y	D2.151	PCV-2300AY	E5.32
PCSB250-10S-2Y	D2.149	PCSB750-8-1Y	D2.151	PCV-2300BY	E5.32
PCSB250-12-2Y	D2.150	PCSB750-10-1Y	D2.157	PCV-2300CY	E5.32
PCSB250-12S-2Y	D2.149	PCSBMT2/0-10-2Y	D2.154	PCV-230AY	E5.32
PCSB250-14-1Y	D2.150	PCSBMT2/0-10S2Y	D2.153	PCV-230BY	E5.32
PCSB250-14S-1Y	D2.149	PCSBMT2/0-12-1Y	D2.154	PCV-230CY	E5.32
PCSB250-2-6Y	D2.150	PCSBMT2/0-12S1Y	D2.153	PCV-2400AY	E5.32
PCSB250-2S-6Y	D2.149	PCSBMT2/0-4-3Y	D2.154	PCV-2400BY	E5.32
PCSB250-3-6Y	D2.150	PCSBMT2/0-4S-3Y	D2.153	PCV-2400CY	E5.32
PCSB250-3S-6Y	D2.149	PCSBMT2/0-6-2Y	D2.154	PCV-240AY	E5.32
PCSB250-4-6Y	D2.150	PCSBMT2/0-6S-2Y	D2.153	PCV-240BY	E5.32
PCSB250-4S-6Y	D2.149	PCSBMT2/0-8-2Y	D2.154	PCV-240CY	E5.32
PCSB250-5-4Y	D2.150	PCSBMT2/0-8S-2Y	D2.153	PCV-277/480AY	E5.32
PCSB250-5S-4Y	D2.149	PCSBMT250-10-2Y	D2.154	PCV-277/480BY	E5.32
PCSB250-6-4Y	D2.150	PCSBMT250-10S2Y	D2.153	PCV-277/480CY	E5.32
PCSB250-6S-4Y	D2.149	PCSBMT250-12-1Y	D2.154	PCV-277AY	E5.32
PCSB250-8-3Y	D2.150	PCSBMT250-12S1Y	D2.153	PCV-277BY	E5.32
PCSB250-8S-3Y	D2.149	PCSBMT250-4-2Y	D2.154	PCV-277CY	E5.32
PCSB350-10-2Y	D2.151	PCSBMT250-4S-2Y	D2.153	PCV-380AY	E5.32
PCSB350-10S-2Y	D2.149	PCSBMT250-6-2Y	D2.154	PCV-380BY	E5.32
PCSB350-12-1Y	D2.151	PCSBMT250-6S-2Y	D2.153	PCV-380CY	E5.32
PCSB350-12S-1Y	D2.149	PCSBMT250-8-2Y	D2.154	PCV-3PHAY	E5.32
PCSB350-14-1Y	D2.151	PCSBMT250-8S-2Y	D2.153	PCV-3PHBY	E5.32
PCSB350-14S-1Y	D2.149	PCSBMT350-10-1Y	D2.154	PCV-3PHCY	E5.32
PCSB350-2-4	D2.151	PCSBMT350-10S1Y	D2.153	PCV-415AY	E5.32
PCSB350-2S-4Y	D2.149	PCSBMT350-12-1Y	D2.154	PCV-415BY	E5.32
PCSB350-3-4	D2.151	PCSBMT350-12S1Y	D2.153	PCV-415CY	E5.32
PCSB350-3S-4Y	D2.149	PCSBMT350-4-2Y	D2.154	PCV-4160AY	E5.32
PCSB350-4-3	D2.151	PCSBMT350-4S-2Y	D2.153	PCV-4160BY	E5.32
PCSB350-4S-3Y	D2.149	PCSBMT350-6-2Y	D2.154	PCV-4160CY	E5.32
PCSB350-5-3	D2.151	PCSBMT350-6S-2Y	D2.153	PCV-440AY	E5.32
PCSB350-5S-3Y	D2.149	PCSBMT350-8-2Y	D2.154	PCV-440BY	E5.32
PCSB350-6-2	D2.151	PCSBMT350-8S-2Y	D2.153	PCV-440CY	E5.32
PCSB350-6S-2Y	D2.149	PCSBMT600-10-1Y	D2.154	PCV-460AY	E5.32
PCSB350-8-2	D2.151	PCSBMT600-10S1Y	D2.153	PCV-460BY	E5.32
PCSB350-8S-2Y	D2.149	PCSBMT600-12-1Y	D2.154	PCV-460CY	E5.32
PCSB4-10-4Y	D2.150	PCSBMT600-12S1Y	D2.153	PCV-480AY	E5.32
PCSB4-10S-4Y	D2.149	PCSBMT600-4-2Y	D2.154	PCV-480BY	E5.32
PCSB4-12-3Y	D2.150	PCSBMT600-4S-2Y	D2.153	PCV-480CY	E5.32
PCSB4-12S-3Y	D2.149	PCSBMT600-6-2Y	D2.154	PCV-600AY	E5.32
PCSB4-14-2Y	D2.150	PCSBMT600-6S-2Y	D2.153	PCV-600BY	E5.32
PCSB4-14S-2Y	D2.149	PCSBMT600-8-2Y	D2.154	PCV-600CY	E5.32
PCSB4-2-12Y	D2.150	PCSBMT600-8S-2Y	D2.153	PCV-BLANKAY	E5.32
PCSB4-2S-12Y	D2.149	PCSH-B-CR	B3.26	PCV-BLANKBY	E5.32
PCSB4-3-12Y	D2.150	PCSSH-B-CR	B3.26	PCV-BLANKCY	E5.32

A. System Overview
B1. Cable Ties
B2. Cable Accessories
B3. Stainless Steel Ties
C1. Wiring Duct
C2. Surface Raceway
C3. Abrasion Protection
C4. Cable Management
D1. Terminals
D2. Power Connectors
D3. Grounding Connectors
E1. Labeling Systems
E2. Labels
E3. Pre-Printed & Write-On Markers
E4. Permanent Identification
E5. Lockout/Tagout & Safety Solutions
F. Index

# PANDUIT® ELECTRICAL SOLUTIONS

A. System Overview	Part Number	Page Number	Part Number	Page Number	Part Number	Page Number
B1. Cable Ties	PCV-ESAY	E5.32	PESS-B-L2	E5.26	PHM1	B1.118
	PCV-ESBY	E5.32	PESS-B-L3	E5.26	PHM2	B1.118
	PCV-ESCY	E5.32	PESS-B-N	E5.26	PHM3	B1.118
B2. Cable Accessories	PCV-FAAY	E5.32	PESS-B-SS	E5.26	PHM4	B1.118
	PCV-FABY	E5.32	PESS-C-CE	E5.26	PHS2	B1.118
	PCV-FACY	E5.32	PESS-C-ES	E5.26	PHS3	B1.118
B3. Stainless Steel Ties	PCV-FOAY	E5.32	PESS-C-L1	E5.26	PISR1/0-1	D2.152
	PCV-FOBY	E5.32	PESS-C-L2	E5.26	PISR2-1	D2.152
	PCV-FOCAY	E5.32	PESS-C-L3	E5.26	PISR250-1	D2.152
C1. Wiring Duct	PCV-FOCBY	E5.32	PESS-C-N	E5.26	PISR350-1	D2.152
	PCV-FOCCY	E5.32	PESS-C-SS	E5.26	PISR500-1	D2.152
	PCV-FOCY	E5.32	PESS-D-CE	E5.26	PK10-10R-L	D1.12
C2. Surface Raceway	PCV-FOMY	E5.32	PESS-D-ES	E5.26	PK10-14R-L	D1.12
	PCV-FORY	E5.32	PESS-D-L1	E5.26	<b>PK10-38R-Q</b>	<b>D1.12</b>
	PCV-MAINAY	E5.32	PESS-D-L2	E5.26	PK10-6R-L	D1.12
C3. Abrasion Protection	PCV-MAINBY	E5.32	PESS-D-L3	E5.26	PK10-8R-L	D1.12
	PCV-MAINCY	E5.32	PESS-D-N	E5.26	PK14-10R-C	D1.12
	PCV-TELEAY	E5.32	PESS-D-SS	E5.26	PK14-14R-C	D1.12
C4. Cable Management	PCV-TELEBY	E5.32	PESS-E-CE	E5.26	<b>PK14-38R-C</b>	<b>D1.12</b>
	PCV-TELECY	E5.32	PESS-E-ES	E5.26	PK14-4R-C	D1.12
	PCVB-110Y	E5.33	PESS-E-L1	E5.26	PK14-6R-C	D1.12
D1. Terminals	PCVB-220Y	E5.33	PESS-E-L2	E5.26	PK14-8R-C	D1.12
	PCVB-277Y	E5.33	PESS-E-L3	E5.26	<b>PK14-56R-C</b>	<b>D1.12</b>
	PCVB-277/480Y	E5.33	PESW-A-1Y	E5.27	PK18-10R-C	D1.12
D2. Power Connectors	PCVB-4160Y	E5.33	PESW-A-11Y	E5.27	<b>PK18-14R-C</b>	<b>D1.12</b>
	PCVB-440Y	E5.33	PESW-A-6Y	E5.27	<b>PK18-38R-C</b>	<b>D1.12</b>
	PCVB-480Y	E5.33	PESW-A-8Y	E5.27	PK18-4R-C	D1.12
D3. Grounding Connectors	PCWL-ACC	E5.29	PESW-A-9Y	E5.27	PK18-6R-C	D1.12
	PCWL-BL	E5.29	PESW-B-1Y	E5.27	PK18-8R-C	D1.12
	PCWL-CAL	E5.29	PESW-B-11Y	E5.27	<b>PK18-56R-C</b>	<b>D1.12</b>
E1. Labeling Systems	PCWL-CALD	E5.29	PESW-B-6Y	E5.27	<b>PK2-10R-T</b>	<b>D1.12</b>
	PCWL-ICAL	E5.29	PESW-B-8Y	E5.27	<b>PK2-12R-T</b>	<b>D1.12</b>
	PCWL-REJ	E5.29	PESW-B-9Y	E5.27	<b>PK2-14R-T</b>	<b>D1.12</b>
E2. Labels	PD3S	B1.117	PESW-C-1Y	E5.27	<b>PK2-38R-T</b>	<b>D1.12</b>
	<b>PD3SF</b>	<b>B1.118</b>	PESW-C-11Y	E5.27	<b>PK2-56R-T</b>	<b>D1.12</b>
	PD-DIA	B1.119	PESW-C-6Y	E5.27	<b>PK4-10R-T</b>	<b>D1.12</b>
E3. Pre-Printed & Write-On Markers	PD-600-A	D1.86	PESW-C-8Y	E5.27	<b>PK4-12R-T</b>	<b>D1.12</b>
	PDH10-37	B1.118	PESW-C-9Y	E5.27	<b>PK4-14R-T</b>	<b>D1.12</b>
	PDM	B1.117, B1.119	PESW-D-1Y	E5.27	<b>PK4-38R-T</b>	<b>D1.12</b>
E4. Permanent Identification	PDM-DI	B1.119	PESW-D-11Y	E5.27	<b>PK4-56R-T</b>	<b>D1.12</b>
	PDS	B1.117, B1.119	PESW-D-6Y	E5.27	<b>PK6-10R-T</b>	<b>D1.12</b>
	PDS-DI	B1.119	PESW-D-8Y	E5.27	<b>PK6-12R-T</b>	<b>D1.12</b>
E5. Lockout/Tagout & Safety Solutions	PDS-DIA	B1.116	PESW-D-9Y	E5.27	<b>PK6-14R-T</b>	<b>D1.12</b>
	PDSF	B1.118	PESW-E-1Y	E5.27	<b>PK6-38R-T</b>	<b>D1.12</b>
	PEIP-A-12Y	E5.31	PESW-E-11Y	E5.27	<b>PK6-56R-T</b>	<b>D1.12</b>
F. Index	PEIP-A-13Y	E5.31	PESW-E-6Y	E5.27	<b>PK6-8R-T</b>	<b>D1.12</b>
	PEIP-A-14Y	E5.31	PESW-E-8Y	E5.27	<b>PK8-10R-T</b>	<b>D1.12</b>
	PEIP-A-15Y	E5.31	PESW-E-9Y	E5.27	<b>PK8-12R-T</b>	<b>D1.12</b>
	PEIP-D-12Y	E5.31	PFX-0	B1.51, B2.28, E5.18	<b>PK8-14R-T</b>	<b>D1.12</b>
	PEIP-D-13Y	E5.31	PFX-2	B1.51, B2.28, E5.18	<b>PK8-38R-T</b>	<b>D1.12</b>
	PEIP-D-14Y	E5.31	PG-1	D3.55	<b>PK8-56R-T</b>	<b>D1.12</b>
	PEIP-D-15Y	E5.31	PG-1SC	D3.55	<b>PK8-8R-T</b>	<b>D1.12</b>
	<b>PES197</b>	<b>E4.6</b>	PH10-10F-E	D1.31	PL283N1	B1.118
	PESC-H-AT	E5.25	PH10-10R-E	D1.13	PL289N1	B1.113, B3.16
	PESC-H-E	E5.25	PH10-12R-E	D1.13	PL2M2S-L	B1.34
	PESC-H-EC	E5.25	PH10-14R-E	D1.13	PL2M2S-L0	B1.34
	PESC-H-HT	E5.25	PH10-38R-E	D1.13	PL3B5EH-C0	B1.78
	PESC-H-PE	E5.25	PH10-8F-E	D1.31	PL3M2S-D0	B1.34
	PESC-J-AT	E5.25	PH10-8R-E	D1.13	PL3M2S-L	B1.34
	PESC-J-E	E5.25	PH14-10F-Q	D1.31	PLA2S-A-Q	B2.8
	PESC-J-EC	E5.25	PH14-10R-Q	D1.13	PLB2S-C	B1.76
	PESC-J-HT	E5.25	PH14-14R-Q	D1.13	PLB2S-C0	B1.76
	PESC-J-PE	E5.25	PH14-38R-Q	D1.13	PLB2S-M30	B1.76
	PES-S1	E5.9	PH14-56R-Q	D1.13	PLB3S-C	B1.76
	PESS-A-CE	E5.26	PH14-6F-Q	D1.31	PLB3S-C0	B1.76
	PESS-A-ES	E5.26	PH14-6R-Q	D1.13	PLB3S-M30	B1.76
	PESS-A-L1	E5.26	PH14-8F-Q	D1.31	PLB4H-TL	B1.76
	PESS-A-L2	E5.26	PH14-8R-Q	D1.13	PLB4H-TL0	B1.76
	PESS-A-L3	E5.26	PH18-10F-Q	D1.31	PLB4H-TL30	B1.76
	PESS-A-LF	E5.26	PH18-10R-Q	D1.13	PLB4S-C	B1.76
	PESS-A-N	E5.26	PH18-14R-Q	D1.13	PLB4S-M0	B1.76
	PESS-A-PE	E5.26	PH18-6F-Q	D1.31	PLB4S-M30	B1.76
	PESS-A-ROHS	E5.26	PH18-6R-Q	D1.13	PLC1.5I-S8-C	B1.26
	PESS-A-SS	E5.26	PH18-8F-Q	D1.31	PLC1.5I-S8-C0	B1.27
	PESS-B-CE	E5.26	PH18-8R-Q	D1.13	PLC1.5I-S8-M30	B1.27
	PESS-B-ES	E5.26	PHCAQ	B1.113	PLC1M-S4-C	B1.26
	PESS-B-L1	E5.26	PHCAT	B1.113	PLC1M-S4-C0	B1.27

Part Number	Page Number
PLC1M-S4-M30	B1.27
PLC2H-S25-L	B1.26
PLC2H-S25-TL0	B1.27
PLC2H-S25-TL30	B1.27
PLC2S-S10-C	B1.26
PLC2S-S10-C0	B1.27
PLC2S-S10-M30	B1.27
PLC2S-S6-C	B1.26
PLC2S-S6-C0	B1.27
PLC3S-S10-C	B1.26
PLC3S-S10-C0	B1.27
PLC4H-S25-L	B1.26
PLC4H-S25-L0	B1.27
PLC4H-S25-TL30	B1.27
PLC4S-S10-C	B1.26
PLC4S-S10-C0	B1.27
PLC4S-S10-M30	B1.27
PLD-11	E5.30
PLD-12	E5.28
PLD-17	E5.30
PLD-18	E5.30
PLD-22	E5.30
PLD-28	E5.30
PLD-29	E5.30
PLD-3	E5.30
PLD-30	E5.28
PLD-36	E5.28
PLD-37	E5.28
PLD-38	E5.28
PLD-4	E5.30
PLD-43	E5.28
PLD-45	E5.28
PLD-46	E5.28
PLD-47	E5.28
PLD-52	E5.28
PLD-56	E5.28
PLD-57	E5.28
PLD-58	E5.28
PLD-60	E5.28
PLD-67	E5.28
PLD-68	E5.28
PLD-7	E5.30
PLD-71	E5.28
PLD-72	E5.28
PLD-74	E5.28
PLD-77	E5.30
PLD-78	E5.30
PLD-80	E5.28
PLD-81	E5.28
PLD-91	E5.28
PLF1M-C	B1.34
PLF1M-C0	B1.34
PLF1M-M69	B1.34
PLF1MA-C	B1.34
PLF1MA-M0	B1.34
PLF1MB-C	B1.34
PLF1MC-M	B1.34
PLF1M-M69	B1.34
PLM1M-C	B1.34
PLM1M-C0	B1.34
PLM1M-M69	B1.34
PLM2M-C	B1.34
PLM2M-M0	B1.34
PLM2S-C	B1.34
PLM2S-C0	B1.34
PLM4S-C	B1.34
PLM4S-D0	B1.34
PLMA14Y	E3.3
PLMA1Y	E3.3
PLMA2Y	E3.3
PLMA3Y	E3.3
PLP1.5I-C	B1.33
PLP1.5I-M0	B1.33
PLP1.5I-M30	B1.33
PLP1.5S-M	B1.33
PLP1S-M	B1.33
PLP1S-M0	B1.33

Part Number	Page Number
PLP1S-M30	B1.33
PLP2S-C	B1.33
PLP2S-M0	B1.33
PLP2S-M30	B1.33
PLST30SC-D	B1.81
PLST30SC-D30	B1.74
PLST4HS25-TL	B1.81
PLST4HS25-TL300	B1.74
PLST50SC-D	B1.81
PLST50SC-D30	B1.74
PLT.6SM-C	B1.8
PLT.6SM-C0	B1.10
PLT.6SM-M30	B1.12
PLT.7M-C	B1.8
PLT.7M-M0	B1.10
PLT.7M-M30	B1.12
PLT1.5I-C	B1.8
PLT1.5I-C0	B1.10
PLT1.5I-C30	B1.12
PLT1.5I-M100	B1.17
PLT1.5I-M109	B1.16
PLT1.5I-M120	B1.15
PLT1.5I-M300	B1.13
PLT1.5I-M69	B1.14
PLT1.5M-C	B1.8
PLT1.5M-C0	B1.10
PLT1.5M-C71	B1.20
PLT1.5M-M30	B1.12
PLT1.5M-XMR	B1.121
PLT1.5M-XMR0	B1.121
PLT1.5M-XMR00	B1.121
PLT1.5M-XMR30	B1.121
PLT1.5S-C	B1.8
PLT1.5S-C0	B1.10
PLT1.5S-M30	B1.12
PLT10EH-C	B1.9
PLT10EH-Q0	B1.11
PLT10HL-L	B1.8
PLT12EH-C	B1.9
PLT12EH-Q0	B1.11
PLT13H-Q	B1.8
PLT13H-Q0	B1.10
PLT1M-C	B1.8
PLT1M-C0	B1.10
<b>PLT1M-C186</b>	<b>B1.21</b>
PLT1M-C30	B1.12
PLT1M-C702Y	B1.18
PLT1M-C71	B1.20
PLT1M-C76	B1.19
PLT1M-C86	B1.21
PLT1M-L0	B1.82
PLT1M-L1	B1.82
PLT1M-L1-0	B1.82
PLT1M-L1-10	B1.82
PLT1M-L1-2	B1.82
PLT1M-L1-4	B1.82
PLT1M-L1-7	B1.82
PLT1M-L2	B1.82
PLT1M-L3	B1.82
PLT1M-L3-0	B1.82
PLT1M-L3-10	B1.82
PLT1M-L3-2	B1.82
PLT1M-L3-4	B1.82
PLT1M-L3-7	B1.82
PLT1M-L4Y	B1.82
PLT1M-L5	B1.82
PLT1M-L5-0	B1.82
PLT1M-L5-10	B1.82
PLT1M-L5-2	B1.82
PLT1M-L5-4	B1.82
PLT1M-L5-7	B1.82
PLT1M-L6	B1.82
PLT1M-L6-0	B1.82
PLT1M-L6-10	B1.82
PLT1M-L6-2	B1.82
PLT1M-L6-4	B1.82
PLT1M-L6-7	B1.82

Part Number	Page Number
PLT1M-L8	B1.82
PLT1M-L8-0	B1.82
PLT1M-L8-10	B1.82
PLT1M-L8-2	B1.82
PLT1M-L8-4	B1.82
PLT1M-L8-7	B1.82
PLT1M-M100	B1.17
PLT1M-M109	B1.16
PLT1M-M300	B1.13
PLT1M-M60	B1.14
PLT1M-M69	B1.14
PLT1M-XMR	B1.121
PLT1M-XMR0	B1.121
PLT1M-XMR00	B1.121
PLT1M-XMR1	B1.121
PLT1M-XMR10	B1.121
PLT1M-XMR2	B1.121
PLT1M-XMR3	B1.121
PLT1M-XMR30	B1.121
PLT1M-XMR4Y	B1.121
PLT1M-XMR5	B1.121
PLT1M-XMR6	B1.121
PLT1M-XMR7	B1.121
PLT1M-XMR8	B1.121
PLT1S-C	B1.8
PLT1S-C0	B1.10
PLT1S-M30	B1.12
PLT1S-M300	B1.13
PLT2.5H-L	B1.8
PLT2.5H-L0	B1.10
PLT2.5I-C	B1.8
PLT2.5I-C0	B1.10
PLT2.5S-C	B1.8
PLT2.5S-C0	B1.10
PLT2.5S-M30	B1.12
PLT2EH-C	B1.9
PLT2EH-Q0	B1.11
PLT2H-L	B1.8
PLT2H-L0	B1.10
PLT2H-TL100	B1.17
PLT2H-TL109	B1.16
PLT2H-TL30	B1.12
PLT2H-TL300	B1.13
PLT2I-C	B1.8
PLT2I-C0	B1.10
<b>PLT2I-C186</b>	<b>B1.21</b>
PLT2I-C30	B1.12
PLT2I-C76	B1.19
PLT2I-C86	B1.21
PLT2I-M300	B1.13
PLT2I-M69	B1.14
PLT2M-C	B1.8
PLT2M-C0	B1.10
PLT2M-M30	B1.12
PLT2M-M69	B1.14
PLT2S-C	B1.8
PLT2S-C0	B1.10
<b>PLT2S-C186</b>	<b>B1.21</b>
PLT2S-C30	B1.12
PLT2S-C702Y	B1.18
PLT2S-C71	B1.20
PLT2S-C76	B1.19
PLT2S-C86	B1.21
PLT2S-M100	B1.17
PLT2S-M109	B1.16
PLT2S-M120	B1.15
PLT2S-M300	B1.13
PLT2S-M39	B1.12
PLT2S-M60	B1.14
PLT2S-M69	B1.14
PLT2S-VMR	B1.122
PLT2S-VMR0	B1.122
PLT2S-VMR30	B1.122
PLT3EH-NB-C0	B1.11
PLT3H-L	B1.8
PLT3H-L0	B1.10
<b>PLT3H-L186</b>	<b>B1.21</b>

A. System Overview
B1. Cable Ties
B2. Cable Accessories
B3. Stainless Steel Ties
C1. Wiring Duct
C2. Surface Raceway
C3. Abrasion Protection
C4. Cable Management
D1. Terminals
D2. Power Connectors
D3. Grounding Connectors
E1. Labeling Systems
E2. Labels
E3. Pre-Printed & Write-On Markers
E4. Permanent Identification
E5. Lockout/ Tagout & Safety Solutions
F. Index

# PANDUIT® ELECTRICAL SOLUTIONS

A. System Overview	Part Number	Page Number	Part Number	Page Number	Part Number	Page Number
B1. Cable Ties	PLT3H-L76	B1.19	PLUP40S-D30	B1.32	PMDR-T1 thru PMDR-T3	E3.10
	PLT3H-L86	B1.21	PLUP40SE-D	B1.32	PMDR-WHT	E3.10
	PLT3H-TL100	B1.17	PLUP40SE-D30	B1.32	PMDR-YEL	E3.10
B2. Cable Accessories	PLT3H-TL109	B1.16	PLWP1.5I-C	B1.28	PMN1-35R-3K	D1.116
	PLT3H-TL30	B1.12	PLWP1.5I-D30	B1.29	PMN1-3F-3K	D1.119
	PLT3I-C	B1.8	PLWP1.5S-D	B1.28	PMN1-3R-3K	D1.116
	PLT3I-C0	B1.10	PLWP1.5S-D30	B1.29	PMN1-4F-3K	D1.119
	PLT3I-M30	B1.12	PLWP1.5SA-D	B1.28	PMN1-4R-3K	D1.116
B3. Stainless Steel Ties	PLT3S-C	B1.8	PLWP1M-C	B1.28	PMN1-5F-3K	D1.119
	PLT3S-C0	B1.10	PLWP1M-D0	B1.29	PMN1-5R-3K	D1.116
	<b>PLT3S-C186</b>	<b>B1.21</b>	PLWP1M-D30	B1.29	PMN1-6F-3K	D1.119
	PLT3S-C30	B1.12	PLWP1S-C	B1.28	PMN1-6R-3K	D1.116
	PLT3S-C702Y	B1.18	PLWP1S-C0	B1.29	PMN2-35R-3K	D1.116
C1. Wiring Duct	PLT3S-C76	B1.19	PLWP1S-D30	B1.29	PMN2-3F-3K	D1.119
	PLT3S-C86	B1.21	PLWP1SA-D	B1.28	PMN2-3R-3K	D1.116
	PLT3S-M100	B1.17	PLWP1SB-D	B1.28	PMN2-4F-3K	D1.119
	PLT3S-M109	B1.16	PLWP2H-TL	B1.28	PMN2-4R-3K	D1.116
	<b>PLT3S-VMR</b>	<b>B1.122</b>	PLWP2H-TL0	B1.29	PMN2-5F-3K	D1.119
C2. Surface Raceway	<b>PLT3S-VMR30</b>	<b>B1.22</b>	PLWP2H-TL30	B1.29	PMN2-5R-3K	D1.116
	PLT4.5S-C	B1.8	PLWP2S-C	B1.28	PMN2-6F-3K	D1.119
	PLT4.5S-C0	B1.10	PLWP2S-C0	B1.29	PMN2-6R-3K	D1.116
	PLT4H-L	B1.8	PLWP2S-D30	B1.29	PMN6-35R-2K	D1.116
	PLT4H-L0	B1.10	PLWP2SA-D	B1.28	PMN6-3R-2K	D1.116
C3. Abrasion Protection	<b>PLT4H-L186</b>	<b>B1.21</b>	PLWP2SB-D	B1.28	PMN6-4F-2K	D1.119
	PLT4H-L76	B1.19	PLWP30SC-D30	B1.31	PMN6-4R-2K	D1.116
	PLT4H-L86	B1.21	PLWP3H-TL	B1.28	PMN6-5F-2K	D1.119
	PLT4H-TL100	B1.17	PLWP3H-TL0	B1.29	PMN6-5R-2K	D1.116
	PLT4H-TL109	B1.16	PLWP40SC-D30	B1.31	PMN6-6F-2K	D1.119
C4. Cable Management	PLT4H-TL120	B1.15	PLWP40SD-D30	B1.31	PMN6-6R-2K	D1.116
	PLT4H-TL30	B1.12	PLWP50SC-D30	B1.31	PMN6-8R-2K	D1.116
	PLT4H-TL300	B1.13	PLWP50SE-D30	B1.31	PMNMF1-35R-3K	D1.117
	PLT4H-TL69	B1.14	PM1-3F-C	D1.36	PMNMF1-3F-3K	D1.119
	PLT4I-C	B1.8	PM1-3R-C	D1.34	PMNMF1-3F-C	D1.35
D1. Terminals	PLT4I-C0	B1.10	PM1-4F-C	D1.36	PMNMF1-3R-3K	D1.117
	PLT4I-M30	B1.12	PM1-4R-C	D1.34	PMNMF1-3R-C	D1.33
	PLT4S-C	B1.8	PM1-5F-C	D1.36	PMNMF1-4F-3K	D1.119
	PLT4S-C0	B1.10	PM1-5R-C	D1.34	PMNMF1-4F-C	D1.35
	<b>PLT4S-C186</b>	<b>B1.21</b>	PM1-P10-C	D1.60	PMNMF1-4R-3K	D1.117
D2. Power Connectors	PLT4S-C30	B1.12	PM2-3F-C	D1.36	PMNMF1-4R-C	D1.33
	PLT4S-C76	B1.19	PM2-3R-C	D1.34	PMNMF1-5F-3K	D1.119
	PLT4S-C86	B1.21	PM2-4F-C	D1.36	PMNMF1-5F-C	D1.35
	PLT4S-M100	B1.17	PM2-4R-C	D1.34	PMNMF1-5R-3K	D1.117
	PLT4S-M109	B1.16	PM2-5F-C	D1.36	PMNMF1-5R-C	D1.33
D3. Grounding Connectors	PLT4S-M120	B1.15	PM2-5R-C	D1.34	PMNMF1-6F-3K	D1.119
	PLT4S-M300	B1.13	PM2-P10-C	D1.60	PMNMF1-6F-C	D1.35
	PLT4S-M69	B1.14	PM2H25-C	B2.20	PMNMF1-6R-3K	D1.117
	PLT5EH-NB-C0	B1.11	PM2H25-M0	B2.20	PMNMF1-6R-C	D1.33
	PLT5EH-Q	B1.9	PM2H25-M30	B2.20	PMNMF2-35R-3K	D1.117
E1. Labeling Systems	PLT5EH-Q0	B1.11	PM6-3R-L	D1.34	PMNMF2-3F-3K	D1.119
	PLT5H-C30	B1.12	PM6-4R-L	D1.34	PMNMF2-3F-C	D1.35
	PLT5H-L	B1.8	PM6-5F-L	D1.36	PMNMF2-3R-3K	D1.117
	PLT5H-L0	B1.10	PM6-5R-L	D1.34	PMNMF2-3R-C	D1.33
	PLT5S-C	B1.8	PM6-6F-L	D1.36	PMNMF2-4F-3K	D1.119
E2. Labels	PLT5S-C0	B1.10	PM6-6R-L	D1.34	PMNMF2-4F-C	D1.35
	PLT5S-M30	B1.12	PM6-8R-L	D1.34	PMNMF2-4R-3K	D1.117
	PLT6EH-NB-C0	B1.11	PM6-P10-L	D1.60	PMNMF2-4R-C	D1.33
	PLT6EH-Q	B1.11	PMCC38H25-C	B2.31	PMNMF2-5F-3K	D1.119
	PLT6H-C30	B1.12	PMCC38H25-M0	B2.31	PMNMF2-5F-C	D1.35
E3. Pre-Printed & Write-On Markers	PLT6H-L	B1.8	PMD	E3.9	PMNMF2-5R-3K	D1.117
	PLT6H-L0	B1.10	PMD-0-9	E3.9	PMNMF2-5R-C	D1.33
	PLT6LH-L	B1.8	PMD-NEMA	E3.9	PMNMF2-6F-3K	D1.119
	PLT6LH-L0	B1.10	PMDR-0 thru PMDR-9	E3.10	PMNMF2-6F-C	D1.35
	PLT7LH-C30	B1.12	PMDR-90 thru PMDR-99	E3.10	PMNMF2-6R-3K	D1.117
E4. Permanent Identification	PLT7LH-L	B1.8	PMDR-A thru PMDR-Z	E3.10	PMNMF2-6R-L	D1.33
	PLT7LH-L0	B1.10	PMDR-BL	E3.10	PMNMF6-35R-2K	D1.117
	PLT8EH-C	B1.9	PMDR-BLK	E3.10	PMNMF6-3R-2K	D1.117
	PLT8EH-Q0	B1.11	PMDR-BRN	E3.10	PMNMF6-3R-L	D1.33
	PLT8H-C30	B1.12	PMDR-GRN	E3.10	PMNMF6-4F-2K	D1.119
E5. Lockout/Tagout & Safety Solutions	PLT8H-L	B1.8	PMDR-GRS	E3.10	PMNMF6-4F-L	D1.35
	PLT8H-L0	B1.10	PMDR-GRY	E3.10	PMNMF6-4R-2K	D1.117
	PLT8LH-C120	B1.15	PMDR-L1 thru PMDR-L3	E3.10	PMNMF6-4R-L	D1.33
	PLT8LH-L	B1.8	PMDR-MIN	E3.10	PMNMF6-5F-2K	D1.119
	PLT8LH-L0	B1.10	PMDR-NEMA	E3.10	PMNMF6-5F-L	D1.35
F. Index	PLT9LH-C30	B1.12	PMDR-ORN	E3.10	PMNMF6-5R-2K	D1.117
	PLT9LH-L	B1.8	PMDR-PLS	E3.10	PMNMF6-5R-L	D1.33
	PLT9LH-L0	B1.10	PMDR-PUR	E3.10	PMNMF6-6F-2K	D1.119
			PMDR-RED	E3.10	PMNMF6-6F-L	D1.35

Part Number	Page Number
PMNF6-6R-2K	D1.117
PMNF6-6R-L	D1.33
PMNF6-8R-2K	D1.117
PMNF6-8R-L	D1.33
PMR40BC	C2.5
PMR40BFWH	C2.6
PMR40BWH10	C2.5
PMR40CWH13.75	C2.5
PMR40CWH19.75	C2.5
PMR40CWH31.75	C2.5
PMR40CWH5	C2.5
PMR40CWH7.75	C2.5
PMR40DB50	C2.6
PMR40DC-X	C2.5
PMR40DP50WH	C2.6
PMR40DW5	C2.5
PMR40E45EWH	C2.6
PMR40ECWH	C2.6
PMR40EEWH	C2.6
PMR40FH2WH	C2.6
PMR40FH4WH	C2.6
PMR40I45EWH	C2.6
PMR40ICC	C2.6
PMR40ICWH	C2.6
PMR40KH2WH	C2.6
PMR40KH4WH	C2.6
PMR40OCWH	C2.6
PMR40PCWH	C2.6
PMR40RAWH	C2.5
PMR40SCWH-X	C2.5
PMR40SIC	C2.5
PMR40SOCWH	C2.6
PMR40TD50	C2.6
PMR40TRWH	C2.6
PMR40TWH	C2.6
PMR40WR-X	C2.6
PMR5736WH	C2.16
PMR5737AWH	C2.16
PMR5737WH	C2.16
PMR5738AWH	C2.16
PMR5738WH	C2.16
PMR5739AWH	C2.16
PMR5739WH	C2.16
PMR5744-2WH	C2.16
PMR5744-3WH	C2.16
PMR5744S-2WH	C2.15
PMR5744S-3WH	C2.16
PMR5744SWH	C2.15
PMR5744WH	C2.16
PMR5747-2WH	C2.15
PMR5747-3WH	C2.15
PMR5747WH	C2.15
PMR5748-2WH	C2.15
PMR5748-3WH	C2.15
PMR5748WH	C2.15
PMR5751-2WH	C2.15
PMR5751-3WH	C2.15
PMR5751WH	C2.15
PMR5752RD	C2.16
PMR5753RD	C2.16
PMR5760WH	C2.15
PMR57AOCWH	C2.12
PMR57CBWH	C2.12
PMR57CC50-X	C2.12
PMR57CC75-X	C2.12
PMR57EBCWH	C2.12
PMR57ECCWH	C2.12
PMR57EEWH	C2.12
PMR57GC-X	C2.11
PMR57JBC50-X	C2.12
PMR57JBC75-X	C2.12
PMR57JC-X	C2.11
PMR57LTEWH	C2.12
PMR57MRT	C2.13
PMR57RTEWH	C2.12
PMR57SC-X	C2.11
PMR57TWH	C2.12

Part Number	Page Number
PMR5CCWH-X	C2.12
PMR5DAWH	C2.12
PMR5ICWH	C2.12
PMR5MSWH-X	C2.11
PMR5OCWH	C2.12
PMR5RAWH	C2.12
PMR5TRWH	C2.12
PMR5WH10	C2.11
PMR5WH5	C2.11
PMR5WPB-X	C2.11
PMR7CCWH-X	C2.12
PMR7DAWH	C2.12
PMR7ICWH	C2.12
PMR7MSWH-X	C2.11
PMR7OCWH	C2.12
PMR7RAWH	C2.12
PMR7TRWH	C2.12
PMR7WH10	C2.11
PMR7WH5	C2.11
PMR7WPB-X	C2.11
PMRTUPAL	C2.13
PMRTUPWH	C2.13
PMV1-35RB-3K	D1.118
PMV1-3FB-3K	D1.120
PMV1-3FB-CY	D1.35
PMV1-3RB-3K	D1.118
PMV1-3RB-CY	D1.34
PMV1-4FB-3K	D1.120
PMV1-4FB-CY	D1.35
PMV1-4RB-3K	D1.118
PMV1-4RB-CY	D1.34
PMV1-5FB-3K	D1.120
PMV1-5FB-CY	D1.35
PMV1-5RB-3K	D1.118
PMV1-5RB-CY	D1.34
PMV1-6FB-3K	D1.120
PMV1-6FB-CY	D1.35
PMV1-6RB-3K	D1.118
PMV1-6RB-CY	D1.34
PMV1-P10-CY	D1.60
PMV1-P12B-3K	D1.138
PMV2-35RB-3K	D1.118
PMV2-3FB-3K	D1.120
PMV2-3FB-C	D1.35
PMV2-3RB-3K	D1.118
PMV2-3RB-C	D1.34
PMV2-4FB-3K	D1.120
PMV2-4FB-C	D1.35
PMV2-4RB-3K	D1.118
PMV2-4RB-C	D1.34
PMV2-5FB-3K	D1.120
PMV2-5FB-C	D1.35
PMV2-5RB-3K	D1.118
PMV2-5RB-C	D1.34
PMV2-6FB-3K	D1.120
PMV2-6FB-C	D1.35
PMV2-6RB-3K	D1.118
PMV2-6RB-C	D1.34
PMV2-P10-C	D1.60
PMV2-P12B-3K	D1.138
PMV6-35RB-2K	D1.118
PMV6-3R-L	D1.34
PMV6-3RB-2K	D1.118
PMV6-4F-L	D1.35
PMV6-4FB-2K	D1.120
PMV6-4R-L	D1.34
PMV6-4RB-2K	D1.118
PMV6-5F-L	D1.35
PMV6-5FB-2K	D1.120
PMV6-5R-L	D1.34
PMV6-5RB-2K	D1.118
PMV6-6F-L	D1.35
PMV6-6FB-2K	D1.120
PMV6-6R-L	D1.34
PMV6-6RB-2K	D1.118
PMV6-8R-L	D1.34
PMV6-8RB-2K	D1.118

Part Number	Page Number
PMV6-P10-L	D1.60
PN10-10F-2K	D1.107
PN10-10F-L	D1.22
PN10-10FF-2K	D1.113
PN10-10FF-L	D1.28
PN10-10LF-2K	D1.110
PN10-10LF-L	D1.24
PN10-10R-2K	D1.103
PN10-10R-L	D1.6
PN10-10RX-L	D1.8
PN10-10SLF-2K	D1.112
PN10-10SLF-L	D1.26
PN10-12R-Q	D1.6
PN10-14F-2K	D1.107
PN10-14F-L	D1.22
PN10-14LF-L	D1.24
PN10-14R-2K	D1.103
PN10-14R-L	D1.6
PN10-14RX-L	D1.8
PN10-14SLF-L	D1.26
PN10-38R-2K	D1.103
PN10-38R-L	D1.6
PN10-38RX-L	D1.8
PN10-56R-2K	D1.103
PN10-56R-L	D1.6
PN10-56RX-L	D1.8
PN10-5SLF-L	D1.26
PN10-610R-L	D1.8
PN10-6F-2K	D1.107
PN10-6F-L	D1.22
PN10-6LF-2K	D1.110
PN10-6LF-L	D1.24
PN10-6R-2K	D1.103
PN10-6R-L	D1.6
PN10-6RX-L	D1.8
PN10-6SLF-L	D1.26
PN10-8F-2K	D1.107
PN10-8F-L	D1.22
PN10-8FF-2K	D1.113
PN10-8FF-L	D1.28
PN10-8LF-2K	D1.110
PN10-8LF-L	D1.24
PN10-8R-2K	D1.103
PN10-8R-L	D1.6
PN10-8RX-L	D1.8
PN10-8SLF-2K	D1.112
PN10-8SLF-L	D1.26
PN12-10HDR-2K	D1.106
PN12-10HDR-L	D1.13
PN12-14HDR-2K	D1.106
PN12-14HDR-L	D1.13
PN12-38HDR-2K	D1.106
PN12-38HDR-L	D1.13
PN12-56HDR-2K	D1.106
PN12-56HDR-L	D1.13
PN12-6HDR-2K	D1.106
PN12-8HDR-2K	D1.106
PN12-8HDR-L	D1.13
PN14-10F-3K	D1.107
PN14-10F-C	D1.22
PN14-10FF-3K	D1.113
PN14-10FF-C	D1.28
PN14-10FN-3K	D1.107
PN14-10FN-C	D1.22
PN14-10LF-3K	D1.110
PN14-10LF-C	D1.24
PN14-10LFN-C	D1.24
PN14-10R-3K	D1.103
PN14-10R-C	D1.6
PN14-10RX-C	D1.8
PN14-10SLF-3K	D1.112
PN14-10SLF-C	D1.26
PN14-12R-Q	D1.6
PN14-14F-3K	D1.107
PN14-14F-C	D1.22
PN14-14R-3K	D1.103
PN14-14R-C	D1.6

A. System Overview
B1. Cable Ties
B2. Cable Accessories
B3. Stainless Steel Ties
C1. Wiring Duct
C2. Surface Raceway
C3. Abrasion Protection
C4. Cable Management
D1. Terminals
D2. Power Connectors
D3. Grounding Connectors
E1. Labeling Systems
E2. Labels
E3. Pre-Printed & Write-On Markers
E4. Permanent Identification
E5. Lockout/Tagout & Safety Solutions
F. Index

A. System Overview	Part Number	Page Number	Part Number	Page Number	Part Number	Page Number
B1. Cable Ties	PN14-14RX-L	D1.8	PN18-8F-3K	D1.107	PNF14-6FF-3K	D1.114
	PN14-14SLF-C	D1.26	PN18-8F-C	D1.22	PNF14-6FN-3K	D1.108
	PN14-38R-L	D1.6	PN18-8FF-3K	D1.113	PNF14-6LF-3K	D1.110
B2. Cable Accessories	PN14-4R-3K	D1.103	PN18-8FF-C	D1.28	PNF14-6LF-C	D1.25
	PN14-4R-C	D1.6	PN18-8LF-3K	D1.110	PNF14-6LFW-C	D1.25
	PN14-56R-C	D1.6	PN18-8LF-C	D1.24	PNF14-6R-3K	D1.104
	PN14-5SLF-3K	D1.112	PN18-8R-3K	D1.103	PNF14-6R-C	D1.7
	PN14-5SLF-C	D1.26	PN18-8R-C	D1.6	PNF14-6RN-3K	D1.104
B3. Stainless Steel Ties	PN14-610R-C	D1.8	PN18-8SLF-3K	D1.112	PNF14-6RN-C	D1.7
	PN14-6F-3K	D1.107	PN18-8SLF-C	D1.26	PNF14-6SLF-3K	D1.112
	PN14-6F-C	D1.22	PN22-10R-C	D1.6	PNF14-6SLF-C	D1.27
	PN14-6FF-3K	D1.113	PN22-2F-C	D1.22	PNF14-8F-3K	D1.108
	PN14-6FF-C	D1.28	PN22-2R-C	D1.6	PNF14-8F-C	D1.22
C1. Wiring Duct	PN14-6FN-3K	D1.107	PN22-4F-C	D1.22	PNF14-8FF-3K	D1.114
	PN14-6FN-C	D1.22	PN22-4R-C	D1.6	PNF14-8LF-3K	D1.110
	PN14-6LF-3K	D1.110	PN22-6F-C	D1.22	PNF14-8LF-C	D1.25
C2. Surface Raceway	PN14-6LF-C	D1.24	PN22-6R-C	D1.6	PNF14-8R-3K	D1.104
	PN14-6LFW-C	D1.24	PN22-8R-C	D1.6	PNF14-8R-C	D1.7
	PN14-6R-3K	D1.103	PNF10-10F-L	D1.22	PNF14-8SLF-C	D1.27
	PN14-6R-C	D1.6	PNF10-10FF-2K	D1.114	PNF18-10F-3K	D1.108
	PN14-6RN-3K	D1.103	PNF10-10LF-2K	D1.110	PNF18-10F-C	D1.22
C3. Abrasion Protection	PN14-6RN-C	D1.6	PNF10-10LF-L	D1.25	PNF18-10FF-3K	D1.114
	PN14-6RX-C	D1.8	PNF10-10R-2K	D1.104	PNF18-10LF-3K	D1.110
	PN14-6SLF-3K	D1.112	PNF10-10R-L	D1.7	PNF18-10LF-C	D1.25
	PN14-6SLF-C	D1.26	PNF10-10SLF-2K	D1.112	PNF18-10R-3K	D1.104
	PN14-8F-3K	D1.107	PNF10-10SLF-L	D1.27	PNF18-10R-C	D1.7
C4. Cable Management	PN14-8F-C	D1.22	PNF10-14F-2K	D1.108	PNF18-10SLF-3K	D1.112
	PN14-8FF-3K	D1.113	PNF10-14F-L	D1.22	PNF18-10SLF-C	D1.27
	PN14-8FF-C	D1.28	PNF10-14LF-2K	D1.110	PNF18-14F-3K	D1.108
	PN14-8LF-3K	D1.110	PNF10-14LF-L	D1.25	PNF18-14F-C	D1.22
	PN14-8LF-C	D1.24	PNF10-14R-2K	D1.104	PNF18-14R-3K	D1.104
D1. Terminals	PN14-8R-3K	D1.103	PNF10-14R-L	D1.7	PNF18-14R-C	D1.7
	PN14-8R-C	D1.6	PNF10-14SLF-L	D1.27	PNF18-38R-C	D1.7
	PN14-8RX-C	D1.8	PNF10-38R-2K	D1.104	PNF18-4R-3K	D1.104
	PN14-8SLF-3K	D1.112	PNF10-38R-L	D1.7	PNF18-4R-C	D1.7
	PN14-8SLF-C	D1.26	PNF10-56R-2K	D1.104	PNF18-4RN-3K	D1.104
D2. Power Connectors	PN18-10F-3K	D1.107	PNF10-56R-L	D1.7	PNF18-56R-C	D1.7
	PN18-10F-C	D1.22	PNF10-6F-2K	D1.108	PNF18-5SLF-3K	D1.112
	PN18-10FF-3K	D1.113	PNF10-6F-L	D1.22	PNF18-5SLF-C	D1.27
	PN18-10FF-C	D1.28	PNF10-6LF-2K	D1.110	PNF18-6F-3K	D1.108
	PN18-10FN-3K	D1.107	PNF10-6LF-L	D1.25	PNF18-6F-C	D1.22
D3. Grounding Connectors	PN18-10FN-C	D1.22	PNF10-6R-2K	D1.104	PNF18-6FF-3K	D1.114
	PN18-10LF-3K	D1.110	PNF10-6R-L	D1.7	PNF18-6FN-3K	D1.108
	PN18-10LF-C	D1.24	PNF10-6SLF-2K	D1.112	PNF18-6LF-3K	D1.110
	PN18-10LFN-C	D1.24	PNF10-6SLF-L	D1.27	PNF18-6LF-C	D1.25
	PN18-10R-3K	D1.103	PNF10-8F-2K	D1.108	PNF18-6LFW-3K	D1.110
E1. Labeling Systems	PN18-10R-C	D1.6	PNF10-8F-L	D1.22	PNF18-6LFW-C	D1.25
	PN18-10SLF-3K	D1.112	PNF10-8FF-2K	D1.114	PNF18-6R-3K	D1.104
	PN18-10SLF-C	D1.26	PNF10-8LF-2K	D1.110	PNF18-6R-C	D1.7
	PN18-12R-L	D1.6	PNF10-8LF-L	D1.25	PNF18-6RN-3K	D1.104
	PN18-14F-3K	D1.107	PNF10-8R-2K	D1.104	PNF18-6RN-C	D1.7
E2. Labels	PN18-14F-C	D1.22	PNF10-8R-L	D1.7	PNF18-6SLF-3K	D1.112
	PN18-14R-3K	D1.103	PNF10-8SLF-2K	D1.112	PNF18-6SLF-C	D1.27
	PN18-14R-C	D1.6	PNF10-8SLF-L	D1.27	PNF18-8F-3K	D1.108
	PN18-38R-C	D1.6	PNF14-10F-3K	D1.108	PNF18-8F-C	D1.22
	PN18-4R-3K	D1.103	PNF14-10F-C	D1.22	PNF18-8FF-3K	D1.114
E3. Pre-Printed & Write-On Markers	PN18-4R-C	D1.6	PNF14-10FF-3K	D1.114	PNF18-8LF-3K	D1.110
	PN18-4RN-C	D1.6	PNF14-10LF-3K	D1.110	PNF18-8LF-C	D1.25
	PN18-56R-C	D1.6	PNF14-10LF-C	D1.25	PNF18-8R-3K	D1.104
	PN18-5SLF-3K	D1.112	PNF14-10LFN-3K	D1.110	PNF18-8R-C	D1.7
	PN18-5SLF-C	D1.26	PNF14-10R-3K	D1.104	PNF18-8SLF-3K	D1.112
E4. Permanent Identification	PN18-610R-C	D1.8	PNF14-10R-C	D1.7	PNF18-8SLF-C	D1.27
	PN18-6F-3K	D1.107	PNF14-10R-3K	D1.104	PNL-1000-2-3	D2.131
	PN18-6F-C	D1.22	PNF14-10SLF-3K	D1.112	PNL-1000-3	D2.129
	PN18-6FF-3K	D1.113	PNF14-10SLF-C	D1.27	PNL-1/0-L	D2.129
	PN18-6FF-C	D1.28	PNF14-14F-3K	D1.108	PNL-1/0-2-L	D2.131
E5. Lockout/Tagout & Safety Solutions	PN18-6FN-3K	D1.107	PNF14-14F-C	D1.22	PNL-250-2-Q	D2.131
	PN18-6FN-C	D1.22	PNF14-14R-3K	D1.104	PNL-250-Q	D2.129
	PN18-6LF-3K	D1.110	PNF14-14R-C	D1.7	PNL-4-C	D2.129
	PN18-6LF-C	D1.24	PNF14-14SLF-C	D1.27	PNL-500-2-3	D2.131
	PN18-6LFW-C	D1.24	PNF14-38R-L	D1.7	PNL-500-3	D2.129
F. Index	PN18-6R-3K	D1.103	PNF14-4R-3K	D1.104	PNLC-1/0-3	D2.135
	PN18-6R-C	D1.6	PNF14-4R-C	D1.7	PNLC-250-1	D2.135
	PN18-6RN-3K	D1.103	PNF14-56R-C	D1.7	PNLC-500-1	D2.135
	PN18-6RN-C	D1.6	PNF14-5SLF-C	D1.27	PP1S-S10-X	B2.23
	PN18-6SLF-3K	D1.112	PNF14-6F-3K	D1.108	PP1S-S12-X	B2.23
	PN18-6SLF-C	D1.26	PNF14-6F-C	D1.22	PP2S-S10-X	B2.23

Part Number	Page Number
PP2S-S12-X	B2.23
PP5X50F	B1.83
PPC25X50	B1.83
PPC25X50F	B1.83
PPF2S-S25-V	B2.24, C4.14
PPF2S-S25-V69	B2.24, C4.14
PPF2SV-S25-V	B2.24, C4.14
PPF2SV-S25-V69	B2.24, C4.14
PPH10	B1.113, B3.16
PPM-0 thru PPM-25	E3.8
PPM-1-33	E3.8
PPM-A thru PPM-C	E3.8
PPMV1-4RB-3K	D1.118
PPS0202B493	E5.19
PPS0305C174	E5.19, E5.24
PPS0305D73	E5.24
PPS0305D75	E5.24
<b>PPS0305W2200</b>	<b>E5.23</b>
<b>PPS0507W2200</b>	<b>E5.23</b>
PPS0514B363	E5.24
PPS0710B364	E5.19, E5.24
PPS0710BWHT	E5.39
PPS0710BYEL	E5.39
PPS0710C141	E5.24
PPS0710C442	E5.39
PPS0710D101	E5.24
PPS0710D24	E5.24
PPS0710D28	E5.24
PPS0710D440	E5.19
PPS0710D66	E5.24
PPS0710D70	E5.24
PPS0710D72	E5.19, E5.24
PPS0710D73	E5.24
PPS0710D75	E5.24
PPS0710D77	E5.24
<b>PPS0710G001</b>	<b>E5.25</b>
<b>PPS0710G020</b>	<b>E5.25</b>
PPS0710N203	E5.24
PPS0710N443	E5.39
PPS1007D72SE	E5.24
PPS1014BWHT	E5.39
PPS1014BYEL	E5.39
PPS1014C442	E5.39
PPS1014D440	E5.39
PPS1014D73	E5.34
<b>PPS1014G002</b>	<b>E5.23, E5.25</b>
PPS1014N443	E5.39
<b>PPS1209G010</b>	<b>E5.23, E5.25</b>
<b>PPS1209G011</b>	<b>E5.23, E5.25</b>
<b>PPS1209G012</b>	<b>E5.23, E5.25</b>
PPS1420BWHT	E5.39
PPS1420BYEL	E5.39
PPS1420C442	E5.39
PPS1420D440	E5.39
PPS1420N443	E5.39
PPTMT	B3.16
PRA2S-A-Q	B2.8
PRL100BY-0 thru PRL100BY-9	E5.38
PRL100BY-18KIT	E5.38
PRL100BY-36KIT	E5.38
PRL100BY-A thru PRL100BY-Z	E5.38
PRL100BY-BLNK	E5.38
PRL100BY-DSH	E5.38
PRL150YB-0 thru PRL150YB-9	E5.38
PRL150YB-A thru PRL150YB-Z	E5.38
PRL150YB-DSH	E5.38
PRL250YB-0 thru PRL250YB-9	E5.38
PRL250YB-A thru PRL250YB-Z	E5.38
PRL250YB-DSH	E5.38
PRLWLP30S-D30	B1.32
PRLWLP50S-D30	B1.32
PROG-CCCD	E1.16
PROG-EM2GO	E1.16
PROG-EMCD3	E1.16
PRS0710B364	E5.19, E5.24
PRS0710BWHT	E5.39
PRS0710BYEL	E5.39

Part Number	Page Number
PRS0710C442	E5.39
PRS0710D440	E5.39
PRS0710D68	E5.24
PRS0710D72	E5.19, E5.24
PRS0710N443	E5.39
PRS0910D453	E5.24
PRS1014B364	E5.19, E5.24
PRS1014BWHT	E5.39
PRS1014BYEL	E5.39
PRS1014C442	E5.39
PRS1014D440	E5.39
PRS1014D70	E5.24
PRS1014D71	E5.24
PRS1014D72	E5.19, E5.24
PRS1014D73	E5.24
PRS1014D79	E5.24
PRS1014N443	E5.39
PRS1420BWHT	E5.39
PRS1420BYEL	E5.39
PRS1420C442	E5.39
PRS1420D440	E5.39
PRS1420D75	E5.24
PRS1420N443	E5.39
PRST30S-S14-M30	B1.75
PRST40SC-D30	B1.74
PRT1.5S-C	B1.22
PRT1.5S-C0	B1.23
PRT1.5S-M30	B1.23
PRT10EH-C	B1.22
PRT10EH-Q0	B1.24
PRT12EH-C	B1.22
PRT12EH-Q0	B1.24
PRT1S-C	B1.22
PRT1S-C0	B1.23
PRT2EH-C	B1.22
PRT2EH-C100	B1.25
PRT2EH-Q0	B1.24
PRT2H-L	B1.22
PRT2H-L0	B1.23
PRT2S-C	B1.22
PRT2S-C0	B1.23
PRT3H-L	B1.22
PRT3H-L0	B1.23
PRT3S-C	B1.22
PRT3S-C0	B1.23
PRT4H-L	B1.22
PRT4H-L0	B1.23
PRT4S-C	B1.22
PRT4S-C0	B1.23
PRT5EH-C100	B1.25
PRT5EH-C30	B1.24
PRT5EH-Q	B1.22
PRT5EH-Q0	B1.24
PRT6EH-C100	B1.25
PRT6EH-Q	B1.22
PRT6EH-Q0	B1.24
PRT8EH-C	B1.22
PRT8EH-C100	B1.25
PRT8EH-Q0	B1.24
PRWP1.5S-D	B1.30
PRWP1.5S-D0	B1.30
PRWP1.5S-D30	B1.30
PRWP1S-C	B1.30
PRWP1S-D0	B1.30
PRWP1SA-D	B1.30
PRWP1SB-D	B1.30
PRWP2H-TL	B1.30
PRWP2S-D	B1.30
PRWP2S-D0	B1.30
PS12-L	D1.67
PS16-C	D1.67
PS18-C	D1.67
PSCBLK-Q	D2.64
PSCBLU-L	D2.64
PSCBRN-L	D2.64
PSCB-12Y	E3.3
PSCB-13Y	E3.3

Part Number	Page Number
PSCB-16Y	E3.3
PSCB-3Y	E3.3
PSCB-3YEY	E3.3
PSCB-5Y	E3.3
PSCB-6Y	E3.3
PSCC-3Y	E3.9
PSCC-5Y	E3.9
PSCGRN-L	D2.64
PSCGRY-L	D2.64
PSCORG-Q	D2.64
PSCPKN-L	D2.64
PSCPUR-Q	D2.64
PSCRED-L	D2.64
PSCYEL-Q	D2.64
PSJBXIW	C2.58
PSL-1	E5.11
PSL-1.5	E5.11
PSL-1.5A	E5.11
PSL-10SA	E5.8
PSL-10SWCA	E5.8
PSL-1A	E5.11
PSL-20SA	E5.8
PSL-20SWCA	E5.8
PSL-4SA	E5.8
PSL-4SWCA	E5.8
PSL-6	E5.11
PSL-6BL	E5.11
PSL-6BL-LS	E5.11
PSL-6BU	E5.11
PSL-6BU-LS	E5.11
PSL-6GR	E5.11
PSL-6GR-LS	E5.11
PSL-6-L	E5.11
PSL-6WH	E5.11
PSL-6WH-LS	E5.11
PSL-6YL	E5.11
PSL-6YL-LS	E5.11
PSL-7	E5.10
PSL-7BL	E5.10
PSL-7BL-LS	E5.10
PSL-7BR	E5.10
PSL-7BR-LS	E5.10
PSL-7BU	E5.10
PSL-7BU-LS	E5.10
PSL-7GR	E5.10
PSL-7GR-LS	E5.10
PSL-7-L	E5.10
PSL-7OR	E5.10
PSL-7OR-LS	E5.10
PSL-7PU	E5.10
PSL-7PU-LS	E5.10
PSL-7YL	E5.10
PSL-7YL-LS	E5.10
PSL-8	E5.10
PSL-8BL	E5.10
PSL-8BR	E5.10
PSL-8BU	E5.10
PSL-8GR	E5.10
PSL-8-LABEL	E5.10
PSL-8OR	E5.10
PSL-8PU	E5.10
PSL-8YL	E5.10
PSL-BFV	E5.6
PSL-BV1	E5.6
PSL-BV2	E5.6
PSL-BV3	E5.6
PSL-BX	E5.8
PSL-CB	E5.3
PSL-CB-3PC	E5.3
PSL-CBIL	E5.3
PSL-CBILNT	E5.3
PSL-CBKIT	E5.3
PSL-CBL	E5.3
PSL-CBNT	E5.3
PSL-CBWL	E5.9
PSL-CL110	E5.4
PSL-CL480	E5.4

A. System Overview
B1. Cable Ties
B2. Cable Accessories
B3. Stainless Steel Ties
C1. Wiring Duct
C2. Surface Raceway
C3. Abrasion Protection
C4. Cable Management
D1. Terminals
D2. Power Connectors
D3. Grounding Connectors
E1. Labeling Systems
E2. Labels
E3. Pre-Printed & Write-On Markers
E4. Permanent Identification
E5. Lockout/Tagout & Safety Solutions
F. Index

# PANDUIT® ELECTRICAL SOLUTIONS

A. System Overview	Part Number	Page Number	Part Number	Page Number	Part Number	Page Number
B1. Cable Ties	PSL-DCJB	E5.20	PSL-TG1	E5.13	PV10-14LF-L	D1.25
	PSL-DCJB-BL	E5.20	PSL-V13	E5.5	PV10-14LFB-2K	D1.111
	PSL-DCJB-BU	E5.20	PSL-V2A	E5.5	PV10-14LFX-L	D1.26
	PSL-DCJB-GR	E5.20	PSL-V6A	E5.5	PV10-14R-L	D1.9
	PSL-DCJB-IG	E5.20	PSL-V9	E5.5	PV10-14RB-2K	D1.105
B2. Cable Accessories	PSL-DCJB-IW	E5.20	PSL-WS	E5.5	PV10-14RX-L	D1.10
	PSL-DCJB-OR	E5.20	PSL-WS1A	E5.5	PV10-14SLF-L	D1.27
	PSL-DCJB-YL	E5.20	PSM-0-9-Y	E3.7	PV10-38R-L	D1.9
	PSL-DCPLRX	E5.21	PSM-0-Y thru PSM-52Y	E3.7	PV10-38RB-2K	D1.105
	PSL-DCPLRX-BL	E5.21	PSM-1-33-Y	E3.7	PV10-38RX-L	D1.10
B3. Stainless Steel Ties	PSL-DCPLRX-BU	E5.21	PSM-34-66-Y	E3.7	PV10-56R-L	D1.9
	PSL-DCPLRX-GR	E5.21	PSM-67-99-Y	E3.7	PV10-56RB-2K	D1.105
	PSL-DCPLRX-IG	E5.21	PSM-A-Y thru PSM-Z-Y	E3.7	PV10-56RX-L	D1.10
	PSL-DCPLRX-IW	E5.21	PSM-A-Z-Y	E3.7	PV10-5SLF-L	D1.27
	PSL-DCPLRX-OR	E5.21	PSN12-L	D1.66	PV10-610R-L	D1.11
C1. Wiring Duct	PSL-DCPLRX-YL	E5.21	PSN16-C	D1.66	PV10-610RB-2K	D1.105
	PSL-DCPLRX	E5.21	PSN18-C	D1.66	PV10-6F-L	D1.23
	PSL-DCPLX-BL	E5.21	PSSB-13	E5.33	PV10-6FB-2K	D1.109
	PSL-DCPLX-BU	E5.21	PST-12	E5.18	PV10-6LF-L	D1.25
	PSL-DCPLX-GR	E5.21	PST-3	E5.18	PV10-6LFB-2K	D1.111
C2. Surface Raceway	PSL-DCPLX-IG	E5.21	PST-FO	E5.42	PV10-6LFX-L	D1.26
	PSL-DCPLX-IW	E5.21	PST-FOBLNK	E5.42	PV10-6R-L	D1.9
	PSL-DCPLX-OR	E5.21	PSWM-1500Y	E3.9	PV10-6RB-2K	D1.105
	PSL-DCPLX-YL	E5.21	PSWM-375Y	E3.9	PV10-6RX-L	D1.10
	PSL-ERB	E5.4	PSWM-750Y	E3.9	PV10-6SLF-L	D1.27
C3. Abrasion Protection	PSL-GLBN	E5.8	PSWMH-375Y	E3.9	PV10-6SLFB-2K	D1.113
	PSL-HD1	E5.11	PSWMH-750Y	E3.9	PV10-8F-L	D1.23
	PSL-HD2.4	E5.11	PT10-10R-L	D1.12	PV10-8FB-2K	D1.109
	PSL-HD3	E5.11	PT10-14R-L	D1.12	PV10-8FF-L	D1.28
	PSL-KT	E5.8	PT10-6R-L	D1.12	PV10-8FFB-2K	D1.114
C4. Cable Management	PSL-KT-CONA	E5.7	PT10-8R-L	D1.12	PV10-8FX-L	D1.24
	PSL-KT-MROA	E5.7	PT14-10R-C	D1.12	PV10-8LF-L	D1.25
	PSL-KT-PWR	E5.7	PT14-14R-C	D1.12	PV10-8LFB-2K	D1.111
	PSL-LCAB	E5.22	PT14-4R-C	D1.12	PV10-8LFX-L	D1.26
	PSL-LCAB-AQ	E5.22	PT14-6R-C	D1.12	PV10-8R-L	D1.9
D1. Terminals	PSL-LCAB-BL	E5.22	PT14-8R-C	D1.12	PV10-8RB-2K	D1.105
	PSL-LCAB-BU	E5.22	PT18-10R-C	D1.12	PV10-8RX-L	D1.10
	PSL-LCAB-EI	E5.22	PT18-4R-C	D1.12	PV10-8SLF-L	D1.27
	PSL-LCM	E5.2	PT18-6R-C	D1.12	PV10-8SLFB-2K	D1.113
	PSL-LOTO-TRAIN	E5.2	PT18-8R-C	D1.12	PV10-P55-L	D1.54
D2. Power Connectors	PSL-LTM	E5.2	PT2S-ARW	E5.34	PV12-10HDR-L	D1.14
	PSL-LTMGP	E5.2	PT2S-BLK	E5.34	PV12-10HDRB-2K	D1.106
	PSL-LTMS	E5.2	PT2S-RED	E5.34	PV12-10HDRX-L	D1.14
	PSL-LTP	E5.2	PT-BGND	E5.42	PV12-14HDR-L	D1.14
	PSL-LTPGP	E5.2	PT-GND	E5.42	PV12-14HDRB-2K	D1.106
D3. Grounding Connectors	PSL-LTPS	E5.2	PT-TGND	E5.42	PV12-14HDRX-L	D1.14
	PSL-LTV	E5.2	<b>PTB-GP</b>	<b>D3.55</b>	PV12-38HDR-L	D1.14
	PSL-LTV-DVD	E5.2	<b>PTB-HO</b>	<b>D3.40</b>	PV12-38HDRB-2K	D1.106
	PSL-MLD	E5.6, E5.11	PTH	B1.113	PV12-38HDRX-L	D1.14
	PSL-MLDC	E5.6	PTR-CLN	E1.13	PV12-56HDR-L	D1.14
E1. Labeling Systems	PSL-MLDC200	E5.6	PTS	B1.113	PV12-56HDRB-2K	D1.106
	PSL-MLD-CRIMP	E5.6	PT-TGND	E5.42	PV12-56HDRX-L	D1.14
	PSL-MLDCT	E5.6	PUM-049-2S-D30	B2.22	PV12-6HDR-L	D1.14
	PSL-MLDH-X	E5.6, E5.11	PUM-049-M30	B2.22	PV12-6HDRB-2K	D1.106
	PSL-MLD-TOOL	E5.6	PUM-071-2S-D30	B2.22	PV12-6HDRX-L	D1.14
E2. Labels	PSL-P	E5.4	PUM-071-M30	B2.22	PV12-8HDR-L	D1.14
	PSL-PC	E5.13	PUM-100-2S-D30	B2.22	PV12-8HDRB-2K	D1.106
	PSL-PE1	E5.13	PUM-100-M30	B2.22	PV12-8HDRX-L	D1.14
	PSL-PE2	E5.13	PUM-925-3H-T30	B2.22	PV14-10F-C	D1.23
	PSL-PEL	E5.6	PUM-925-M30	B2.22	PV14-10FB-3K	D1.109
E3. Pre-Printed & Write-On Markers	PSL-PI	E5.4	PV10-10F-L	D1.23	PV14-10FF-C	D1.28
	PSL-PK	E5.8	PV10-10FB-2K	D1.109	PV14-10FFB-3K	D1.114
	PSL-PK-EA	E5.7	PV10-10FF-L	D1.28	PV14-10FN-C	D1.23
	PSL-PL1BLKY	E5.12	PV10-10FFB-2K	D1.114	PV14-10FNB-3K	D1.109
	PSL-PL1BLUY	E5.12	PV10-10FX-L	D1.24	PV14-10FX-C	D1.24
E4. Permanent Identification	PSL-PL1GRNY	E5.12	PV10-10LF-L	D1.25	PV14-10LF-C	D1.25
	PSL-PL1REDY	E5.12	PV10-10LFB-2K	D1.111	PV14-10LFB-3K	D1.111
	PSL-PL1WHY	E5.12	PV10-10LFX-L	D1.26	PV14-10LFN-C	D1.25
	PSL-PL1YELY	E5.12	PV10-10R-L	D1.9	PV14-10LFX-C	D1.26
	PSL-SC	E5.13	PV10-10RB-2K	D1.105	PV14-10R-C	D1.9
E5. Lockout/Tagout & Safety Solutions	PSL-SCBD-AG	E5.22	PV10-10RX-L	D1.10	PV14-10RB-3K	D1.105
	PSL-SCBD-AQ	E5.22	PV10-10SLF-L	D1.27	PV14-10RX-C	D1.10
	PSL-SCBD-BL	E5.22	PV10-10SLFB-2K	D1.113	PV14-10SLF-C	D1.27
	PSL-SCBD-BU	E5.22	PV10-12R-Q	D1.9	PV14-10SLFB-3K	D1.113
	PSL-SCBD-EI	E5.22	PV10-14F-L	D1.23	PV14-12R-L	D1.9
F. Index	PSL-STATION	E5.8	PV10-14FB-2K	D1.109	PV14-14F-C	D1.23
	PSL-STEPS	E5.2	PV10-14FX-L	D1.24	PV14-14FB-3K	D1.109



# PANDUIT® ELECTRICAL SOLUTIONS

Part Number	Page Number
PV14-14R-C	D1.9
PV14-14RB-3K	D1.105
PV14-14RX-L	D1.10
PV14-14SLF-C	D1.27
PV14-14SLFB-3K	D1.113
PV14-38R-L	D1.9
PV14-38RB-2K	D1.105
PV14-38RX-L	D1.10
PV14-4R-C	D1.9
PV14-4RB-3K	D1.105
PV14-4RX-C	D1.10
PV14-56R-C	D1.9
PV14-56RB-2K	D1.105
PV14-56RX-L	D1.10
PV14-5SLF-C	D1.27
PV14-610R-C	D1.11
PV14-610RB-3K	D1.105
PV14-6F-C	D1.23
PV14-6FB-3K	D1.109
PV14-6FF-C	D1.28
PV14-6FFB-3K	D1.114
PV14-6FN-C	D1.23
PV14-6FNB-3K	D1.109
PV14-6FX-C	D1.24
PV14-6LF-C	D1.25
PV14-6LFB-3K	D1.111
PV14-6LFW-C	D1.25
PV14-6LFWB-3K	D1.111
PV14-6LFX-C	D1.26
PV14-6R-C	D1.9
PV14-6RB-3K	D1.105
PV14-6RN-C	D1.9
PV14-6RNB-3K	D1.105
PV14-6RX-C	D1.10
PV14-6SLF-C	D1.27
PV14-6SLFB-3K	D1.113
PV14-8F-C	D1.23
PV14-8FB-3K	D1.109
PV14-8FF-C	D1.28
PV14-8FFB-3K	D1.114
PV14-8FX-C	D1.24
PV14-8LF-C	D1.25
PV14-8LFB-3K	D1.111
PV14-8LFX-C	D1.26
PV14-8R-C	D1.9
PV14-8RB-3K	D1.105
PV14-8RX-C	D1.10
PV14-8SLF-C	D1.27
PV14-8SLFB-3K	D1.113
PV14-P47-C	D1.54
PV14-P47B-3K	D1.130
PV18-10F-CY	D1.23
PV18-10FB-3K	D1.109
PV18-10FF-CY	D1.28
PV18-10FFB-3K	D1.114
PV18-10FN-CY	D1.23
PV18-10FX-CY	D1.24
PV18-10LF-CY	D1.25
PV18-10LFB-3K	D1.111
PV18-10LFN-CY	D1.25
PV18-10LFB-3K	D1.111
PV18-10LFX-CY	D1.26
PV18-10R-CY	D1.9
PV18-10RB-3K	D1.105
PV18-10RX-CY	D1.10
PV18-10SLF-CY	D1.27
PV18-10SLFB-3K	D1.113
PV18-12R-LY	D1.9
PV18-14FB-3K	D1.109
PV18-14R-CY	D1.9
PV18-14RB-3K	D1.105
PV18-14RX-CY	D1.10
PV18-38R-LY	D1.9
PV18-38RB-2K	D1.105
PV18-38RX-LY	D1.10
PV18-4R-CY	D1.9
PV18-4RB-3K	D1.105

Part Number	Page Number
PV18-4RNB-3K	D1.105
PV18-4RX-CY	D1.10
PV18-56R-CY	D1.9
PV18-56RB-2K	D1.105
PV18-56RX-LY	D1.10
PV18-5SLF-CY	D1.27
PV18-5SLFB-3K	D1.113
PV18-610R-CY	D1.11
PV18-610RB-3K	D1.105
PV18-6F-CY	D1.23
PV18-6FB-3K	D1.109
PV18-6FF-CY	D1.28
PV18-6FFB-3K	D1.114
PV18-6FN-CY	D1.23
PV18-6FNB-3K	D1.109
PV18-6FX-CY	D1.24
PV18-6LF-CY	D1.25
PV18-6LFB-3K	D1.111
PV18-6LFW-CY	D1.25
PV18-6LFWB-3K	D1.111
PV18-6LFX-CY	D1.26
PV18-6R-CY	D1.9
PV18-6RB-3K	D1.105
PV18-6RNB-3K	D1.105
PV18-6RX-CY	D1.10
PV18-6SLF-CY	D1.27
PV18-6SLFB-3K	D1.113
PV18-8F-CY	D1.23
PV18-8FB-3K	D1.109
PV18-8FF-CY	D1.28
PV18-8FFB-3K	D1.114
PV18-8FX-CY	D1.24
PV18-8LF-CY	D1.25
PV18-8LFB-3K	D1.111
PV18-8LFX-CY	D1.26
PV18-8R-CY	D1.9
PV18-8RB-3K	D1.105
PV18-8RX-CY	D1.10
PV18-8SLF-CY	D1.27
PV18-8SLFB-3K	D1.113
PV18-P47-CY	D1.54
PV18-P47B-3K	D1.130
PV2-10R-XY	D1.15
PV2-10RX-XY	D1.16
PV2-12R-XY	D1.15
PV2-12RX-XY	D1.16
PV2-14R-XY	D1.15
PV2-14RX-XY	D1.16
PV22-10R-CY	D1.9
PV22-2F-CY	D1.23
PV22-2R-CY	D1.9
PV22-4F-CY	D1.23
PV22-4R-CY	D1.9
PV22-6F-CY	D1.23
PV22-6R-CY	D1.9
PV22-8R-CY	D1.9
PV2-38R-XY	D1.15
PV2-38RX-XY	D1.16
PV2-56R-XY	D1.15
PV2-56RX-XY	D1.16
PV4-10R-E	D1.15
PV4-10RX-E	D1.16
PV4-12R-E	D1.15
PV4-12RX-E	D1.16
PV4-14R-E	D1.15
PV4-14RX-E	D1.16
PV4-38R-E	D1.15
PV4-38RX-E	D1.16
PV4-56R-E	D1.15
PV4-56RX-E	D1.16
PV6-10R-X	D1.15
PV6-10RX-X	D1.16
PV6-12R-X	D1.15
PV6-14R-X	D1.15
PV6-14RX-X	D1.16
PV6-38R-X	D1.15
PV6-38RX-X	D1.16

Part Number	Page Number
PV6-56R-X	D1.15
PV6-56RX-X	D1.16
PV6-8R-E	D1.15
PV6-8RX-E	D1.16
PV8-10R-QY	D1.15
PV8-10RX-QY	D1.16
PV8-12R-XY	D1.15
PV8-12RX-XY	D1.16
PV8-14R-QY	D1.15
PV8-14RX-QY	D1.16
PV8-38R-QY	D1.15
PV8-38RX-QY	D1.16
PV8-56R-QY	D1.15
PV8-56RX-QY	D1.16
PV8-8R-QY	D1.15
PV8-8RX-QY	D1.16
PVL100BY-0-Y	E5.36
PVL100BY-1-Y thru PVL100BY-9-Y	E5.36
PVL100BY-A-Y thru PVL100BY-Z-Y	E5.36
PVL100BY-DSH-Y	E5.36
PVL200BY-0-Y	E5.36
PVL200BY-1-Y thru PVL200BY-9-Y	E5.36
PVL200BY-A-Y thru PVL200BY-Z-Y	E5.36
PVL200BY-DSH-Y	E5.36
PVL200BY-Z-Y	E5.34
PVS0109D72Y	E5.19, E5.24
PVS0204C171Y	E5.19
PVS0204C176Y	E5.19
PVS0204C177Y	E5.19
PVS0204C178Y	E5.19
PVS0204C179Y	E5.19
PVS0204D100Y	E5.19, E5.24
PVS0204D72Y	E5.19, E5.24
PVS0204W172Y	E5.19
PVS0209D445Y	E5.19
PVS0305C174Y	E5.19
PVS0305C174Y	E5.24
PVS0305W2101Y	E5.19, E5.24
PVS0305W2102Y	E5.19, E5.24
PVS0503N458Y	E5.19
PVS0505C174Y	E5.19, E5.24
PVS0507W2101Y	E5.19, E5.24
PVS0509B364Y	E5.19, E5.24
PVS0710B364Y	E5.19, E5.24
PVS0710C173Y	E5.19
PVS0710C180Y	E5.19
PVS0710D72Y	E5.19, E5.24
PVT-110	E5.17
PVT-111	E5.17
PVT-112	E5.17
PVT-113-Q	E5.17
PVT-118-Q	E5.17
PVT-148-Q	E5.16
PVT-15	E5.14
PVT-150-Q	E5.16
PVT-153-Q	E5.16
PVT-155-Q	E5.16
PVT-156-Q	E5.16
PVT-157-Q	E5.16
PVT-158-Q	E5.16
PVT-160-Q	E5.16
PVT-161-Q	E5.17
PVT-165-Q	E5.17
PVT-179-Q	E5.17
PVT-199-Q	E5.17
PVT-200-Q	E5.17
PVT-23	E5.14
PVT-23-Q	E5.14
PVT-238-Q	E5.16
PVT-30	E5.14
PVT-30-Q	E5.14
PVT-41	E5.14
PVT-42-Q	E5.14
PVT-43	E5.15
PVT-44	E5.15
PVT-44-Q	E5.15
PVT-56-Q	E5.15

A. System Overview
B1. Cable Ties
B2. Cable Accessories
B3. Stainless Steel Ties
C1. Wiring Duct
C2. Surface Raceway
C3. Abrasion Protection
C4. Cable Management
D1. Terminals
D2. Power Connectors
D3. Grounding Connectors
E1. Labeling Systems
E2. Labels
E3. Pre-Printed & Write-On Markers
E4. Permanent Identification
E5. Lockout/ Tagout & Safety Solutions
F. Index

# PANDUIT® ELECTRICAL SOLUTIONS

A. System Overview	Part Number	Page Number	Part Number	Page Number	Part Number	Page Number
B1. Cable Ties	PVT-57-Q	E5.15	RAF10IW-X	C2.79	RSCK2-6-1	D2.103
	PVT-62-Q	E5.15	RAF3IW-E	C2.79	RSCK2/0-4-1	D2.103
B2. Cable Accessories	PVT-94-Q	E5.17	RAF5IW-E	C2.79	RSCK2/0-6-1	D2.103
	PVT-95-Q	E5.17	RAF10IW-X	C2.80	RSCK4-6-1	D2.103
B3. Stainless Steel Ties	PVT-96	E5.15	RAF3IW-X	C2.80	RSCK4/0-1/0-1	D2.104
	PVT-96-Q	E5.15	RAF5IW-X	C2.80	RSCK4/0-2/0-1	D2.104
C1. Wiring Duct	PVT-97	E5.15	RAF5IW-X	C2.80	RSCK4/0-4-1	D2.103
	PVT-97-Q	E5.15	RAF5IW-X	C2.80	RSCK4/0-6-1	D2.103
C2. Surface Raceway	PVT-97S-Q	E5.17	RAF5IW-X	C2.80	RSCK4/0-6-1	D2.103
	PVT-98	E5.15	RAF5IW-X	C2.80	RSCK500-X350-1	D2.104
C3. Abrasion Protection	PVT-98-Q	E5.15	RAF5IW-X	C2.80	RSCK500-X4/0-1	D2.104
	PVT-99	E5.15	RAF5IW-X	C2.80	RSCK750-4/0-1	D2.104
C4. Cable Management	PVT-99-Q	E5.14	RAF5IW-X	C2.81	RSCK750-500-1	D2.104
	PX-0	B1.51	RAMH-S10-D	B2.17	RSCK750-750-1	D2.104
D1. Terminals	PX-10	B1.51	RAMH-S6-D	B2.17	RSCK750-X350-1	D2.104
	PX-2	B1.51	RAMS-S3-M	B2.17	RSCK750-X4/0-1	D2.104
D2. Power Connectors	PW100F-C	C3.2	RBF1WH	C2.6	RSCK750-X500-1	D2.104
	PW100F-C20	C3.2	<b>RER.5E-X</b>	<b>B2.47</b>	RSCKX750-4/0-1	D2.104
D3. Grounding Connectors	PW100F-C3	C3.2	<b>RER.5-S6-X</b>	<b>B2.47</b>	RSCKX750-750-1	D2.104
	PW100F-C4	C3.2	<b>RER.75E-X</b>	<b>B2.47</b>	RSCX750-4/0-3	D2.106
E1. Labeling Systems	PW100FR-CY	C3.2	<b>RER.75-S6-X</b>	<b>B2.47</b>	RSCX750-750-3	D2.106
	PW100FR-C20Y	C3.2	<b>RER1.25E-X</b>	<b>B2.47</b>	RT2HT	B3.15
E2. Labels	PW150F-L	C3.2	<b>RER1.25-S6-X</b>	<b>B2.47</b>	RT2HTN	B3.15
	PW150F-L20	C3.2	<b>RER2.0E-X</b>	<b>B2.47</b>		
E3. Pre-Printed & Write-On Markers	PW150F-L3	C3.2	<b>RER2.0-S6-X</b>	<b>B2.47</b>		
	PW150F-L4	C3.2	RF10X3IW-X	C2.79		
E4. Permanent Identification	PW150FR-LY	C3.2	RF10X5IW-X	C2.79	S050X075VA1Y	E2.7
	PW150FR-L20	C3.2	RF5X3IW-E	C2.79	S050X075VAC	E1.4
E5. Lockout/Tagout & Safety Solutions	PW38FR-TL20Y	C3.2	RFG10X8Y	C4.2	S050X075VATY	E2.7
	PW38FR-TLY	C3.2	RFG10X8SMY	C4.2	S050X075YAJ	E2.3
F. Index	PW38F-TL	C3.2	RFG12X4Y	C4.3	S050X125VA1Y	E2.7
	PW38F-TL20	C3.2	RFG12X4SMY	C4.2	S050X125VAC	E1.4
	PW50F-T	C3.2	RFG12X8Y	C4.3	S050X125VATY	E2.7
	PW50F-T20	C3.2	RFG12X8SMY	C4.2	S050X125YAJ	E2.3
	PW50F-T3	C3.2	RFG3DY	C4.3	S050X150VA1Y	E2.7
	PW50F-T4	C3.2	RFG3DSMY	C4.2	S050X150VAC	E1.4
	PW50FR-T20Y	C3.2	RFG5DSMY	C4.2	S050X150VATY	E2.7
	PW50FR-TY	C3.2	RFG6X8Y	C4.3	S050X150YAJ	E2.3
	PW75F-C	C3.2	RFG6X8SMY	C4.2	S050X250VATY	E2.7
	PW75F-C20	C3.2	RFG8X8Y	C4.3	S075X075VAC	E1.4
	PW75F-C3	C3.2	RFX103IW-X	C2.80, C2.81	S075X075VATY	E2.8
	PW75F-C4	C3.2	RFX105IW-X	C2.80, C2.81	S075X075YAJ	E2.3
	PW75FR-CY	C3.2	RFX53IW-X	C2.80, C2.81	S075X100VAC	E1.4
	PW75FR-C20Y	C3.2	RHH4BL-S	E1.14	S075X125VAC	E1.4
	PWMS-H25-C	B2.19	RHR4BL-S	E1.14	S075X125VATY	E2.8
	PWMS-H25-M0	B2.19	RHW4BL-S	E1.14	S075X125YAJ	E2.3
	PWT100	C3.3	RJBX3510IW	C2.57, C2.59	S075X150VAC	E1.4
	PWT150	C3.3	RMH2BL	E1.13	S075X150VATY	E2.8
	PWT38	C3.3	RMH4BL	E1.13	S075X150YAJ	E2.3
	PWT50	C3.3	RMR2BL	E1.13	S1.5F-C	C1.31
	PWT75	C3.3	RMR2WH	E1.13	S1/0-12R-X	D1.21
	PX-0	B1.51, B2.28	RMR4BL	E1.13	S1/0-14R-X	D1.21
	PX-10	B1.51, B2.28	RMR4BL-A	E1.13	S1/0-38R-X	D1.21
	PX-2	B1.51, B2.28	RMW2BL	E1.13	S1/0-56R-X	D1.21
			RMW4BL	E1.13	S100X075VA1Y	E2.8
			RSC1/0-4-X	D2.105	S100X075VAC	E1.4
			RSC1/0-6-X	D2.105	S100X075VATY	E2.8
			RSC2-4-Q	D2.105	S100X075YAJ	E2.3
			RSC2-6-Q	D2.105	S100X125VA1	E2.7
			RSC2/0-4-X	D2.105	S100X125VA1Y	E2.8
			RSC2/0-6-X	D2.105	S100X125VAC	E1.4
			RSC4-6-L	D2.105	S100X125VAFY	E3.11
			RSC4/0-1/0-X	D2.105	S100X125VARY	E3.11
			RSC4/0-2/0-X	D2.105	S100X125VATY	E2.8
			RSC4/0-4-X	D2.105	S100X125YAJ	E2.3
			RSC4/0-6-X	D2.105	S100X150V0TY	E2.8
			RSC500-X350-6	D2.105	S100X150V9TY	E2.8
			RSC500-X4/0-6	D2.105	S100X150VA1Y	E2.8
			RSC750-4/0-6	D2.106	S100X150VAC	E1.4
			RSC750-500-6	D2.106	S100X150VATY	E2.8
			RSC750-750-6	D2.106	S100X150VBC	E1.4
			RSC750-X350-6	D2.106	S100X150VBTY	E2.8
			RSC750-X4/0-6	D2.106	S100X150VCTY	E2.8
			RSC750-X500-6	D2.106	S100X150VDC	E1.4
			RSCK1/0-4-1	D2.103	S100X150VDTY	E2.8
			RSCK1/0-6-1	D2.103	S100X150VETY	E2.8
			RSCK2-4-1	D2.103	S100X150VFTY	E2.8
					S100X150VGTY	E2.8

## S

Part Number	Page Number
S100X150VHC	E1.4
S100X150VHTY	E2.8
S100X150VIC	E1.4
S100X150VITY	E2.8
S100X150YAJ	E2.3
S100X225V0TY	E2.9
S100X225V9TY	E2.9
S100X225VA1Y	E2.8
S100X225VAC	E1.4
S100X225VAFY	E3.11
S100X225VARY	E3.11
S100X225VATY	E2.8
S100X225VBC	E1.4
S100X225VBTY	E2.8
S100X225VCTY	E2.8
S100X225VDC	E1.4
S100X225VDTY	E2.9
S100X225VETY	E2.9
S100X225VFTY	E2.9
S100X225VGTY	E2.9
S100X225VHC	E1.4
S100X225VHTY	E2.9
S100X225VIC	E1.4
S100X225VITY	E2.9
S100X225YAJ	E2.3
S100X225YHJ	E2.2
S100X250VATY	E2.9
S100X400VA1Y	E2.9
S100X400VAC	E1.4
S100X400VATY	E2.3
S100X400YAJ	E2.2
S100X650VA1Y	E2.9
S100X650VAC	E1.4
S100X650VATY	E2.9
S100X650YAJ	E2.3
S150X150VATY	E2.9
S150X225VATY	E2.9
S150X400VATY	E2.9
S1F-C	C1.31
S2-10R-X	D1.21
S2-12R-X	D1.21
S2-14R-X	D1.21
S2-38R-X	D1.21
S2-56R-X	D1.21
S2/0-12R-X	D1.21
S2/0-14R-X	D1.21
S2/0-38R-X	D1.21
S2/0-56R-X	D1.21
S2/0-76R-X	D1.21
S200X150YAJ	E2.3
S200X225VA1Y	E2.9
S200X225VATY	E2.9
S200X225YAJ	E2.3
S200X250VATY	E2.9
S200X400TAT	E2.8
S200X400VA1Y	E2.9
S200X400VATY	E2.9
S200X400YAJ	E2.3
S200X650VA1Y	E2.9
S200X650VATY	E2.9
S200X650YAJ	E2.3
S2-10R-X	D1.21
S2-12R-X	D1.21
S2-14R-X	D1.21
S2-38R-X	D1.21
S250-12R-5	D1.21
S250-38R-5	D1.21
S250-56R-5	D1.21
S250-76R-5	D1.21
S2-56R-X	D1.21
S2F-C	C1.31
S2X2YL6NM	C1.56
S3/0-12R-5	D1.21
S3/0-14R-5	D1.21
S3/0-38R-5	D1.21
S3/0-56R-5	D1.21
S3/0-76R-5	D1.21

Part Number	Page Number
S3F-C	C1.31
S4/0-12R-5	D1.21
S4/0-38R-5	D1.21
S4/0-56R-5	D1.21
S4/0-76R-5	D1.21
S4-10R-E	D1.21
S4-14R-E	D1.21
S4-38R-E	D1.21
S4-56R-E	D1.21
S4F-C	C1.31
S4X4YL6NM	C1.56
S6-10R-E	D1.21
S6-14R-E	D1.21
S6-38R-E	D1.21
S6-56R-E	D1.21
S8-10R-Q	D1.21
S8-14R-Q	D1.21
S8-38R-Q	D1.21
S8-56R-Q	D1.21
SA1-X	D2.115
SA1/0-X	D2.115
SA1000-1	D2.115
SA2-X	D2.115
SA2/0-5	D2.115
SA250-5	D2.115
SA3/0-5	D2.115
SA300-2	D2.115
SA350-2	D2.115
SA4-X	D2.115
SA4/0-5	D2.115
SA400-2	D2.115
SA500-2	D2.115
SA6-X	D2.115
SA600-2	D2.115
SA750-1	D2.115
SA800-1	D2.115
SACS50-T100	B1.54, B2.27
SAR1/0-2-X	D2.116
SAR2-4-X	D2.116
SAR3/0-1/0-5	D2.116
SAR350-4/0-2	D2.116
SAR4/0-2/0-5	D2.116
SAR500-350-2	D2.116
SAR600-500-2	D2.116
SAR750-600-2	D2.116
SBA1/0-Q	D2.127
SBA2-C	D2.127
SBA2/0-Q	D2.127
SBA350-1	D2.127
SBA4-C	D2.127
SBA4/0-Q	D2.127
SBA500-1	D2.127
SBA6-C	D2.127
SBC1/0-L	D2.125
SBC1000-1	D2.125
SBC2-C	D2.125
SBC2L-C	D2.125
SBC2/0-Q	D2.125
SBC250-Q	D2.125
SBC3-C	D2.125
SBC3/0-Q	D2.125
SBC350-1	D2.125
SBC4S-C	D2.125
SBC4SL-C	D2.125
SBC500-1	D2.125
SBC6S-C	D2.125
SBC6SL-C	D2.125
SBC750-1	D2.125
SBC8-C	D2.125
SBC8L-C	D2.125
SBCT10-C	D2.126
SBCT1/0-L	D2.126
SBCT1000-1	D2.126
SBCT2-C	D2.126
SBCT2/0-Q	D2.126
SBCT250-Q	D2.126
SBCT3-C	D2.126

Part Number	Page Number
SBCT3/0-Q	D2.126
SBCT350-1	D2.126
SBCT500-1	D2.126
SBCT6-C	D2.126
SBCT750-1	D2.126
SBCT8-C	D2.126
SCH1-E	D2.62
SCH1/0-X	D2.62
SCH1000-3	D2.62
SCH2-Q	D2.62
SCH2/0-X	D2.62
SCH250-X	D2.62
SCH3/0-X	D2.62
SCH300-X	D2.62
SCH350-X	D2.62
SCH4-L	D2.62
SCH4/0-X	D2.62
SCH500-6	D2.62
SCH6-L	D2.62
SCH750-6	D2.62
SCL1-E	D2.61
SCL1/0-X	D2.61
SCL1000-3	D2.61
SCL2-Q	D2.61
SCL2/0-X	D2.61
SCL250-X	D2.61
SCL3/0-X	D2.61
SCL300-X	D2.61
SCL350-X	D2.61
SCL4-L	D2.61
SCL4/0-X	D2.61
SCL400-6	D2.61
SCL500-6	D2.61
SCL6-L	D2.61
SCL600-6	D2.61
SCL750-6	D2.61
SCL8-L	D2.61
SCMS10-C	D2.111
SCMS120-Q	D2.111
SCMS150-X	D2.111
SCMS16-C	D2.111
SCMS185-X	D2.111
SCMS240-X	D2.111
SCMS25-L	D2.111
SCMS300-5	D2.111
SCMS35-L	D2.111
SCMS400-5	D2.111
SCMS50-L	D2.111
SCMS500-6	D2.111
SCMS630-6	D2.111
SCMS70-L	D2.111
SCMS95-Q	D2.111
SCS1-E	D2.60
SCS1/0-X	D2.60
SCS1000-3	D2.60
SCS2-Q	D2.60
SCS2/0-X	D2.60
SCS250-X	D2.60
SCS3/0-X	D2.60
SCS300-X	D2.60
SCS350-X	D2.60
SCS4-L	D2.60
SCS4/0-X	D2.60
SCS400-6	D2.60
SCS500-6	D2.60
SCS6-L	D2.60
SCS600-6	D2.60
SCS750-6	D2.60
SCS8-L	D2.60
SCSF1-X	D2.102
SCSF1/0-X	D2.102
SCSF2-E	D2.102
SCSF2/0-X	D2.102
SCSF250-X	D2.102
SCSF3/0-X	D2.102
SCSF300-6	D2.102
SCSF350-6	D2.102

A. System Overview
B1. Cable Ties
B2. Cable Accessories
B3. Stainless Steel Ties
C1. Wiring Duct
C2. Surface Raceway
C3. Abrasion Protection
C4. Cable Management
D1. Terminals
D2. Power Connectors
D3. Grounding Connectors
E1. Labeling Systems
E2. Labels
E3. Pre-Printed & Write-On Markers
E4. Permanent Identification
E5. Lockout/ Tagout & Safety Solutions
F. Index

# PANDUIT® ELECTRICAL SOLUTIONS

A. System Overview	Part Number	Page Number	Part Number	Page Number	Part Number	Page Number
B1. Cable Ties	SCSF4-L	D2.102	SE25PFR-TR8	C3.16	SGABM30-AV-C300	B2.7
	SCSF4/0-X	D2.102	SE25PSC-TR0	C3.17	SGABM40-A-L	B2.7
	SCSF6-L	D2.102	SE38P-MR0	C3.15	SGABM40-AT-L0	B2.7
B2. Cable Accessories	SCSF8-L	D2.102	SE38P-MR10	C3.15	SGABM50-A-L	B2.7
	SCSS1-Q	D2.59	SE38P-MR8	C3.15	SGABM50-AT-L0	B2.7
	SCSS1/0-X	D2.59	SE38P-TR0	C3.15	SGMPMH38-L0	B2.21
	SCSS2-Q	D2.59	SE38P-TR8	C3.15	SGMPMS19-C0	B2.21
	SCSS2/0-X	D2.59	SE38PFR-MR0	C3.16	SGMPMS25-C0	B2.21
	SCSS250-X	D2.59	SE38PFR-MR10	C3.16	SGMPMWH32-L0	B2.21
B3. Stainless Steel Ties	SCSS3/0-X	D2.59	SE38PFR-MR8	C3.16	SGTA1S8-C	B2.13
	SCSS4-L	D2.59	SE38PFR-TR0	C3.16	SGTM1S6-C	B2.11
	SCSS4/0-X	D2.59	SE38PFR-TR8	C3.16	SGTM1S6-C0	B2.11
C1. Wiring Duct	SCSS6-L	D2.59	SE38PSC-TR0	C3.17	SGTM2S8-C	B2.11
	SCSS8-L	D2.59	SE50P-CR0	C3.15	SGTM2S8-C0	B2.11
	SCT1/0-1/0	D2.63	SE50P-CR8	C3.15	SGTM3S10-C	B2.11
C2. Surface Raceway	SCT2-2	D2.63	SE50P-DR0	C3.15	SGTM3S10-C0	B2.11
	SCT2/0-2/0	D2.63	SE50P-DR10	C3.15	SHH1-S8-X	B2.50
	SCT250-250	D2.63	SE50P-DR8	C3.15	SHH3-S8-X	B2.50
C3. Abrasion Protection	SCT300-300	D2.63	SE50PFR-CR0	C3.16	SICH100-C	B2.43
	SCT350-350	D2.63	SE50PFR-CR8	C3.16	SICH150-C	B2.43
	SCT4/0-1/0	D2.63	SE50PFR-DR0	C3.16	SICH25-C	B2.43
C4. Cable Management	SCT4/0-4/0	D2.63	SE50PFR-DR10	C3.16	SICH38-C	B2.43
	SCT500-4/0	D2.63	SE50PFR-DR8	C3.16	SICH50-C	B2.43
	SCT500-500	D2.63	SE50PSC-CR0	C3.17	SICH75-C	B2.43
D1. Terminals	<b>SD2EMI</b>	<b>C1.7</b>	SE75P-CR0	C3.15	SLCT-3	E5.41
	SD2H6	C1.26	SE75P-CR8	C3.15	SLCT-IG	E5.41
	SD2HWH6	C1.26	SE75P-DR0	C3.15	SLCT-3OR	E5.41
D2. Power Connectors	<b>SD3EMI</b>	<b>C1.7</b>	SE75P-DR10	C3.15	SLCT-3YL	E5.41
	SD3H6	C1.26	SE75P-DR8	C3.15	SLCT-3IG	E5.41
	SD3HWH6	C1.26	SE75PFR-CR0	C3.16	SLCT-OR	E5.41
D3. Grounding Connectors	<b>SD4EMI</b>	<b>C1.7</b>	SE75PFR-CR8	C3.16	SLCT-WH	E5.41
	SD4H6	C1.26	SE75PFR-DR0	C3.16	SLCT-YL	E5.41
	SD4HWH6	C1.26	SE75PFR-DR10	C3.16	SMS-A-C	B2.8
E1. Labeling Systems	SE125P-LR0	C3.15	SE75PFR-DR8	C3.16	SMS-A-C14	B2.8
	SE125P-LR8	C3.15	SE75PSC-CR0	C3.17	SMS-A-C15	B2.8
	SE125P-TR0	C3.15	SEZ-1CLL	E5.40	SMS-S6-D	B2.8
E2. Labels	SE125P-TR8	C3.15	SEZ-1DLL	E5.40	SNS-5-C	C1.31
	SE125PFR-LR0	C3.16	SEZ-1NLL	E5.40	SNS.75-C	C1.31
	SE125PFR-LR8	C3.16	SEZ-1WHLL	E5.40	SNS1-C	C1.31
E3. Pre-Printed & Write-On Markers	SE125PFR-TR0	C3.16	SEZ-1WLL	E5.40	SNS1.5-C	C1.31
	SE125PFR-TR8	C3.16	SEZ-1YLL	E5.40	SNS2-C	C1.31
	SE125PSC-LR0	C3.17	SEZ-RSC1	E5.41	SNS25F-C	C1.31
E4. Permanent Identification	SE12P-MR0	C3.15	SEZ-RSC2	E5.41	SNS3-C	C1.31
	SE12P-MR10	C3.15	SEZ-RSC3	E5.41	SNS37F-C	C1.31
	SE12P-MR8	C3.15	SEZ-RSC4	E5.41	SNS50F-C	C1.31
E5. Lockout/Tagout & Safety Solutions	SE12P-TR0	C3.15	SEZ-SNC1	E5.41	SNS62F-C	C1.31
	SE12P-TR8	C3.15	SEZ-SNC2	E5.41	SNS75F-C	C1.31
	SE12PFR-MR0	C3.16	SEZ-SNC3	E5.41	SP1-1/0-L	D3.20
F. Index	SE12PFR-MR8	C3.16	SEZ-SNC4	E5.41	SP1-1/0L-L	D3.20
	SE12PFR-TR0	C3.16	SG100M-C	B1.40	SP1-2-C	D3.20
	SE12PFR-TR8	C3.16	SG100M-C0	B1.41	SP1-2/0-Q	D3.20
	SE12PSC-TR0	C3.17	SG150I-C	B1.40	SP1-2/0L-Q	D3.20
	SE150P-LR0	C3.15	SG150I-C0	B1.41	SP1-2L-C	D3.20
	SE150P-LR8	C3.15	SG200S-C	B1.40	SP1-3-C	D3.20
	SE150P-TR0	C3.15	SG200S-C0	B1.41	SP1-350-12	D3.20
	SE150P-TR8	C3.15	SG200S-M30	B1.41	SP1-350L-12	D3.20
	SE150PFR-LR0	C3.16	SG250S-C	B1.40	SP1-3L-C	D3.20
	SE150PFR-LR8	C3.16	SG250S-C0	B1.41	SP1-4-C	D3.20
	SE150PFR-TR0	C3.16	SG300S-C	B1.40	SP1-4/0-Q	D3.20
	SE150PFR-TR10	C3.16	SG300S-C0	B1.41	SP1-4/0L-Q	D3.20
	SE150PFR-TR8	C3.16	SG300S-M30	B1.41	SP1-4L-C	D3.20
	SE150PSC-LR0	C3.17	SG350LH-L	B1.40	SP1-500-12	D3.20
	SE175P-TR0	C3.15	SG350LH-L0	B1.41	SP1-500L-12	D3.20
	SE175PFR-TR0	C3.16	SG350LH-TL30	B1.41	SP1-7-C	D3.20
	SE25P-MR0	C3.15	SG370S-C	B1.40	SP1-7L-C	D3.20
	SE25P-MR10	C3.15	SG370S-C0	B1.41	SP1-8-C	D3.20
	SE25P-MR8	C3.15	SG450H-L	B1.40	SP1-8L-C	D3.20
	SE25P-TR0	C3.15	SG450H-L0	B1.41	SP2-1/0-L	D3.21
	SE25P-TR8	C3.15	SGABM20-A-C	B2.7	SP2-1/0L-L	D3.21
	SE25PFR-MR0	C3.16	SGABM20-AT-C0	B2.7	SP2-2-C	D3.21
	SE25PFR-MR10	C3.16	SGABM20-AV-C300	B2.7	SP2-2/0-Q	D3.21
	SE25PFR-MR8	C3.16	SGABM25-A-C	B2.7	SP2-2/0L-Q	D3.21
	SE25PFR-TR0	C3.16	SGABM25-AT-C0	B2.7	SP2-2L-C	D3.21
			SGABM25-S6-C	B2.7	SP2-3-C	D3.21
			SGABM25-S6-C0	B2.7	SP2-350-12	D3.21
			SGABM30-A-C	B2.7	SP2-350L-12	D3.21
			SGABM30-AT-C0	B2.7	SP2-3L-C	D3.21

Part Number	Page Number
SP2-4-C	D3.21
SP2-4/0-Q	D3.21
SP2-4/0L-Q	D3.21
SP2-4L-C	D3.21
SP2-500-12	D3.21
SP2-500L-12	D3.21
SP2-7-C	D3.21
SP2-7L-C	D3.21
SP2-8-C	D3.21
SP2-8L-C	D3.21
SPF1-1/0-L	D3.22
SPF1-2-C	D3.22
SPF1-2/0-Q	D3.22
SPF1-3-C	D3.22
SPF1-350-12	D3.22
SPF1-4-C	D3.22
SPF1-4/0-Q	D3.22
SPF1-500-12	D3.22
SPF1-7-C	D3.22
SPF1-8-C	D3.22
SPF2-1/0-L	D3.23
SPF2-2-C	D3.23
SPF2-2/0-Q	D3.23
SPF2-3-C	D3.23
SPF2-350-12	D3.23
SPF2-4-C	D3.23
SPF2-4/0-Q	D3.23
SPF2-500-12	D3.23
SPF2-7-C	D3.23
SPF2-8-C	D3.23
SR-0-XY	D2.148
SR-1000-1Y	D2.148
SR-2-XY	D2.148
SR-250-XY	D2.148
SR-350-XY	D2.148
SR-4/0-XY	D2.148
SR-500-3Y	D2.148
SR-750-1Y	D2.148
SR2	B1.83, D1.37
SR4	D1.37
SR6	D1.37
SRT	C2.83
SS-1	D3.49
SS-1GAGE	D3.49
SSB2S-C	B1.77
SSB2S-M0	B1.77
SSB2S-M30	B1.77
SSC2S-S10-C	B1.70
SSC2S-S10-M0	B1.70
SSC2S-S10-M30	B1.70
SSC2S-S6-C	B1.70
SSC2S-S6-M0	B1.70
SSC4H-S25-D0	B1.70
SSC4H-S25-D30	B1.70
SSC4H-S25-L	B1.70
SSC4S-S10-C	B1.70
SSC4S-S10-M0	B1.70
<b>SSCW14-C</b>	D3.7
<b>SSCW38-C</b>	D3.7
<b>SSFW14-C</b>	D3.7
<b>SSFW38-C</b>	D3.7
SSM2S-C	B1.71
SSM2S-D0	B1.71
SSM4S-D	B1.71
<b>SSN1420-C</b>	D3.7
<b>SSN3816-C</b>	D3.7
<b>SSNTS1420-C</b>	D3.7
<b>SSNTS3816-C</b>	D3.7
SSPM2.5H-L300	B1.79
SSPM2.5HP-L300	B1.79
SSPM4H-L300	B1.79
SSPM4HLP-TL300	B1.79
SSPM4HP-L300	B1.79
SST1.5I-C	B1.67
SST1.5I-M0	B1.68
SST1.5M-C	B1.67
SST1.5M-M0	B1.68

Part Number	Page Number
SST1.5M-M30	B1.69
SST1.5S-M	B1.67
SST1.5S-M0	B1.68
SST1M-C	B1.67
SST1M-C0	B1.68
SST1M-M30	B1.69
SST2H-D	B1.67
SST2H-D0	B1.68
SST2HH-D30	B1.69
SST2I-C	B1.67
SST2I-M0	B1.68
SST2S-C	B1.67
SST2S-C0	B1.68
SST2S-M30	B1.69
SST3I-C	B1.67
SST3I-C0	B1.68
SST3S-C	B1.67
SST3S-C0	B1.68
SST3S-M30	B1.69
SST4H-D30	B1.69
SST4H-L	B1.67
SST4H-L0	B1.68
SST4HH-D30	B1.69
SST4I-C	B1.67
SST4I-M0	B1.68
SST4S-C	B1.67
SST4S-C0	B1.68
SST4S-M30	B1.69
SST8H-D30	B1.69
SST8H-L	B1.67
SST8H-L0	B1.68
ST2MT	B3.15
ST3EH	B1.112
STH2	B1.112
STHV	B1.112
STK12	E4.6
STS2	B1.112

## T

T019X000FJC-BK	E1.11
T024X000FJC-BK	E1.11
T031X000FJC-BK	E1.11
T038X000C1C-BK	E1.5
T038X000C2C-BK	E1.5
T038X000FJC-BK	E1.11
T038X000VPC-BK	E1.12
T038X000VYC-WH	E1.12
T038X000YKC-BK	E1.12
T050X000C1C-BK	E1.5
T050X000C2C-BK	E1.5
T050X000CBC-BK	E1.5
T050X000VPC-BK	E1.12
T050X000VQC-BK	E1.12
T050X000VQC-WH	E1.12
T050X000VSC-BK	E1.12
T050X000VSC-WH	E1.12
T050X000VUC-BK	E1.12
T050X000VVC-BK	E1.12
T050X000VVC-WH	E1.12
T050X000VXC-BK	E1.12
T050X000VYC-WH	E1.12
T050X000YKC-BK	E1.12
T050X000YKC-WH	E1.12
T075X000C1C-BK	E1.5
T075X000C2C-BK	E1.5
T075X000VPC-BK	E1.12
T075X000YKC-BK	E1.12
T100X000C1C-BK	E1.5
T100X000C2C-BK	E1.5
T100F-C	C3.5
T100F-C0	C3.5
T100FR-C20Y	C3.6
T100FR-CY	C3.6
T100N-C	C3.7
T100N-C0	C3.7
T100R-CY	C3.6

Part Number	Page Number
T100T-X	C3.7
T100X000CBC-BK	E1.5
T100X000RP1	E5.34
T100X000RPC-BK	E1.12
T100X000RU1	E5.34
T100X000RUC-BK	E1.12
T100X000RX1	E5.34
T100X000RXC-BK	E1.12
T100X000VP1Y	E2.22
T100X000VPC-BK	E1.12
T100X000VQ1Y	E2.22
T100X000VQC-BK	E1.12
T100X000VQC-WH	E1.12
T100X000VS1Y	E2.22
T100X000VSC-BK	E1.12
T100X000VSC-WH	E1.12
T100X000VU1Y	E2.22
T100X000VUC-BK	E1.12
T100X000VUC-WH	E1.12
T100X000VV1Y	E2.22
T100X000VVC-BK	E1.12
T100X000VVC-WH	E1.12
T100X000VX1Y	E2.12
T100X000VXC-BK	E1.12
T100X000VXC-WH	E1.12
T100X000VY1Y	E2.22
T100X000YKC-BK	E1.12
T100X000YKC-WH	E1.12
T12F-C	C3.4
T12F-C0	C3.5
T12F-D	C3.4
T12F-D0	C3.5
T12FR-CY	C3.6
T12FR-C20Y	C3.6
T12N-C	C3.7
T12N-C0	C3.7
T12R-CY	C3.5
T12T-C	C3.7
T19F-C	C3.4
T19F-C0	C3.5
T19F-M	C3.4
T19FR-CY	C3.6
T19FR-C20Y	C3.6
T19N-C	C3.7
T19N-C0	C3.7
T19R-CY	C3.5
T19T-C	C3.7
<b>T100P-C0</b>	<b>C3.7</b>
T200X000RP1	E1.34
T200X000RU1	E1.34
T200X000RX1	E1.34
T200X000VP1Y	E2.22
T200X000VQ1Y	E2.22
T200X000VS1Y	E2.22
T200X000VU1Y	E2.22
T200X000VV1Y	E2.22
T200X000VW1Y	E2.22
T200X000VX1Y	E2.22
T200X000VY1Y	E2.22
T200X000Y2T	E5.34
T200X000YK1	E2.22
T225X000YK1	E2.22
T25F-C	C3.4
T25F-C0	C3.5
T25F-C1	C3.4
T25F-C10	C3.4
T25F-C16	C3.4
T25F-C2	C3.4
T25F-C3Y	C3.4
T25F-C4Y	C3.4
T25F-C5	C3.4
T25F-C6	C3.4
T25F-C7	C3.4
T25F-C8	C3.4

A.  
System  
Overview

B1.  
Cable Ties

B2.  
Cable  
Accessories

B3.  
Stainless  
Steel Ties

C1.  
Wiring  
Duct

C2.  
Surface  
Raceway

C3.  
Abrasion  
Protection

C4.  
Cable  
Management

D1.  
Terminals

D2.  
Power  
Connectors

D3.  
Grounding  
Connectors

E1.  
Labeling  
Systems

E2.  
Labels

E3.  
Pre-Printed  
& Write-On  
Markers

E4.  
Permanent  
Identification

E5.  
Lockout/  
Tagout  
& Safety  
Solutions

F.  
Index

# PANDUIT® ELECTRICAL SOLUTIONS

A. System Overview	Part Number	Page Number	Part Number	Page Number	Part Number	Page Number
B1. Cable Ties	T25F-M	C3.4	T50F-C5	C3.4	T70PGIW	C2.53
	T25F-M0	C3.5	T50F-C6	C3.4	T70PGSIW	C2.53
	T25F-X0	C3.5	T50F-C7	C3.4	T70PIW	C2.53
B2. Cable Accessories	T25FR-CY	C3.6	T50F-C8	C3.4	T70PNIW	C2.53
	T25FR-C20Y	C3.6	T50F-TL	C3.5	T70PSIW	C2.53
	T25FR-M20Y	C3.6	T50F-TL0	C3.5	T70RAIW	C2.36
	T25FR-MY	C3.6	T50F-TL4Y	C3.5	T70S-X	C2.40
	T25N-C	C3.7	T50F-X	C3.4	T70SDB-X	C2.26, C2.40, C2.101, C2.110
	T25N-C0	C3.7	T50F-X0	C3.5	T70TD	C2.37
	T25R-C20Y	C3.5	T50FR-CY	C3.6	T70TIW	C2.37
	T25R-CY	C3.5	T50FR-C20Y	C3.6	T70TRCIW	C2.37
	T25R-M20Y	C3.6	T50FR-TLY	C3.6	T70TRI	C2.37
	T25R-MY	C3.6	T50N-C	C3.7	T70TRIW	C2.37
B3. Stainless Steel Ties	T25T-L	C3.7	T50N-C0	C3.7	T70WC2IW	C2.37
	T25T-L0	C3.7	<b>T50P-C0</b>	<b>C3.7</b>	T70WCIW	C2.37
	T38F-C	C3.4	T50R-CY	C3.6	T70WM40TRIW	C2.37
C1. Wiring Duct	T38F-C0	C3.5	T50R-TLY	C3.6	T70WR-X	C2.40
	T38FR-C20Y	C3.6	T50T-Q	C3.7	T75F-C	C3.5
	T38FR-CY	C3.6	T62F-C	C3.5	T75F-C0	C3.5
C2. Surface Raceway	T38FR-TLY	C3.6	T62F-C0	C3.5	T75F-T	C3.5
	T38F-TL	C3.4	T62F-TL	C3.5	T75F-T0	C3.5
	T38F-TL0	C3.5	T62F-TL0	C3.5	T75FR-CY	C3.6
C3. Abrasion Protection	T38N-C	C3.7	T62FR-CY	C3.6	T75FR-C20Y	C3.6
	T38N-C0	C3.7	T62FR-C20Y	C3.6	T75FR-TY	C3.6
	<b>T38P-C0</b>	<b>C3.7</b>	T62N-C	C3.7	T75N-C	C3.7
	T38R-CY	C3.6	T62N-C0	C3.7	T75N-C0	C3.7
	T38R-TLY	C3.6	T62R-CY	C3.6	T75R-CY	C3.6
	T38T-L	C3.7	T62T-Q	C3.7	T75T-X	C3.7
	T400X000RP1	E5.34	T702BCIW-X	C2.39	TA1S10-C	B2.13
	T400X000RQ1	E5.34	T702BIW10	C2.38	TA1S10-M0	B2.13
	T400X000RU1	E5.34	T702BIW8	C2.38	TA1S8-C	B2.13
	T400X000RW1	E5.34	T702ECIW	C2.39	TA1S8-M0	B2.13
T400X000RX1	E5.34	T702EEIW	C2.39	TA1S8-M30	B2.13	
D1. Terminals	T400X000VP1Y	E2.22	T702ICIW	C2.39	TA1S8-M69	B2.13
	T400X000VQ1Y	E2.22	T702OCIW	C2.39	TA2-C	B2.13
	T400X000VS1Y	E2.22	T702RAIW	C2.39	TA2-M	B2.13
	T400X000VT1Y	E2.22	T702RIW	C2.39	TAPC2-2/0-X	D2.123, D3.8
	T400X000VU1Y	E2.22	T702TRI	C2.39	TAPC3/0-4/0-5	D2.123, D3.8
	T400X000VV1Y	E2.22	T702TRIW	C2.39	TAPC500-2	D2.123, D3.8
	T400X000VW1Y	E2.22	T702TRLIW	C2.39	TC10-14-C100	B2.41
	T400X000VX1Y	E2.22	T702TIW	C2.39	TC14-20-C100	B2.41
	T400X000VY1Y	E2.22	T702TIV	C2.39	TC3-5-C100	B2.41
	T400X000Y2T	E5.34	T702TRI	C2.39	TC5-7-C100	B2.41
D2. Power Connectors	T425X000YK1	E2.22	T702TRIW	C2.39	TC5X8-C100	B2.41
	<b>T400X000YX1</b>	<b>E5.40</b>	T702TRI	C2.39	TC6X10-C100	B2.41
	T45BIW10	C2.48	T702TRIW	C2.39	TC7-10-C100	B2.41
	T45BIW10-A	C2.48	T702TRLIW	C2.39	TC7X14-C100	B2.41
	T45BIW8	C2.48	T702TIW	C2.39	TC9X18-C100	B2.41
	T45BIW8-A	C2.48	T70B1IW	C2.53	TDP42HY	E1.14
	T45CCIW-X	C2.49	T70B2IW	C2.53	TDP43HY	E1.14
	T45CIW10	C2.48	T70BCIW-X	C2.36	TDP43M-AC	E1.11
	T45CIW8	C2.48	T70BFI	C2.37	TDP43M-ACY	E1.13
	T45DW10	C2.48	T70BFIW	C2.37	TDP43M-CASE	E1.13
E1. Labeling Systems	T45DW8	C2.48	T70BH1IW	C2.53	TDP43M-RS	E1.13
	T45ECIW	C2.49	T70BH2IW	C2.53	TDP43ME-RS	E1.13
	T45EEIW	C2.49	T70BIW10	C2.36	TDP43MY	E1.13
	T45HDBIW	C2.49	T70BIW8	C2.36	TDP46HY	E1.14
	T45HEBIW	C2.49	T70CCIW-X	C2.25, C2.36, C2.39	TF10IW-X	C2.79
	T45HEGBIW	C2.49	T70CIW10	C2.24, C2.36, C2.38	TF3IW-E	C2.79
	T45ICIW	C2.49	T70CIW8	C2.24, C2.36, C2.38	TF5IW-E	C2.79
	T45OCIW	C2.49	T70DB-X	C2.26, C2.40	TFC10IW-X	C2.80
	T45RAIW	C2.49	T70DW10	C2.36, C2.38	TFC3IW-X	C2.80
	T45RLDIW	C2.49	T70DW8	C2.36, C2.38	TFC5IW-X	C2.80
E2. Labels	T45TD	C2.49	T70ECIW	C2.37	TFX10IW-X	C2.81
	T45TIW	C2.49	T70EEIW	C2.37	TFX3IW-X	C2.81
	T45TRI	C2.49	T70FH2IW	C2.52	TFX5IW-X	C2.81
	T45WC2IW	C2.49	T70FH4IW	C2.52	TFXD10IW-X	C2.75
	T45WCIW	C2.49	T70FSB	C2.40	TG70BCIW-X	C2.25
	T45WR-X	C2.49	T70FV2IW	C2.52	TG70HB3-X	C2.26
	T50F-C	C3.4	T70FV4IW	C2.52	TG70HB3GFCI-X	C2.26
	T50F-C0	C3.5	T70HB-X	C2.40	TG70IW10	C2.24
	T50F-C1	C3.4	T70HB3-X	C2.40	TG70IW8	C2.24
	T50F-C10	C3.4	T70HB3GFCI-X	C2.40	TG70WR-X	C2.26
E3. Pre-Printed & Write-On Markers	T50F-C16	C3.4	T70ICIW	C2.36	TGBFI	C2.25
	T50F-C2	C3.4	T70KW2IW	C2.54	TGBFIW	C2.25
	T50F-C2Y	C3.4	T70KV4IW	C2.54	TGDW10	C2.24
	T50F-C3Y	C3.4	T70L2IW	C2.55		
	T50F-C4Y	C3.4	T70L4IW	C2.55		
			T70L2IW	C2.55		
			T70L4IW	C2.55		
			T70LV2IW	C2.55		
			T70LV4IW	C2.55		
			T70N2IW	C2.56		
E4. Permanent Identification			T70N4IW	C2.56		
			T70N2IW	C2.56		
			T70N4IW	C2.56		
			T70NV2IW	C2.56		
			T70NV4IW	C2.56		
			T70OCIW	C2.37		
E5. Lockout/Tagout & Safety Solutions						
F. Index						

Part Number	Page Number
TGDW8	C2.24
TGECIW	C2.25
TGEEIW	C2.25
TGF5B	C2.26
TGICIW	C2.25
TGOCIW	C2.25
TGRAIW	C2.25
TGSICIW	C2.25
TGSOCIW	C2.25
TGTD	C2.25
TGTIW	C2.25
TGTRIW	C2.25
THM1SC-C	B1.120
THM1SC-C30	B1.120
THMSP20-C	B2.51
THMSP20-C30	B2.51
THMSP20F-C	B2.51
THMSP20F-C30	B2.51
THMSP25-C	B2.51
THMSP25-C30	B2.51
THMSP25F-C	B2.51
THMSP25F-C30	B2.51
TJF-X	B2.48
TM1A-C	B2.10
TM1S4-C	B2.9
TM1S4-M30	B2.11
TM1S4-M69	B2.11, B1.14
TM1S6-M0	B2.11
TM1S6-M30	B2.11
TM1S6-M69	B2.11, B1.14
TM2A-C	B2.10
TM2PWH25-C	B2.19
TM2R6-M0	B2.11
TM2R6-M30	B2.11
TM2S6-C	B2.9
TM2S6-M0	B2.11
TM2S6-M30	B2.11
TM2S6-M69	B2.11, B1.14
<b>TM2S8-C186</b>	<b>B2.11, B1.14</b>
TM2S8-C71	B2.11, B1.14
TM2S8-C76	B2.11, B1.14
<b>TM2S8-C86</b>	<b>B2.11, B1.14</b>
TM3S8-C100	B2.11
TM2S8-M0	B2.11
TM2S8-M30	B2.11
TM2S8-M69	B1.14
TM3-X2-C0Y	B2.12
TM3A-C	B2.10
TM3S8-C	B2.11, B2.9
TM3S8-C69	B2.11, B1.14
TM3S8-C76	B1.19
<b>TM3S8-C86</b>	<b>B1.21</b>
TM3S8-C100	B2.11
<b>TM3S8-C186</b>	<b>B2.11, B1.21</b>
TM3R6-M0	B2.11
TM3S8-M30	B2.11
TM3S8-M100	B2.11
TM3S10-M0	B2.11
<b>TM3S10-86</b>	<b>B2.11, B1.21</b>
TM3S10-C76	B1.19
<b>TM3S10-C186</b>	<b>B2.11, B1.21</b>
TM3S10-M30	B2.11
TM3S10-M69	B2.11, B1.14
TM3S25-M0	B2.11
TM3S25-M30	B2.11
TMEH-S10-C100	B2.12
TMEH-S10-C109	B2.12
TMEH-S10-Q0	B2.12
TMEH-S25-Q0	B2.12
TMEH-S8-Q0	B2.12
TMEH-X2-LOY	B2.12
TMSTHS10-D0	B2.18
TMSTHS11-D0	B2.18
TMSTHS12-D0	B2.18
TMSTHS13-D0	B2.18
TMSTHS16-D0	B2.18
TMSTHS19-D0	B2.18

Part Number	Page Number
TMSTLHS6-M0	B2.18
TMSTLHS8-M0	B2.18
TNR	C1.34
TP2-C	B2.15
TP4H-C	B2.15
TRC18FR-X20Y	C4.12
TRC18FR-X8Y	C4.12
TRC2BL	C1.59
TRC4BL	C1.59
TTLK3	B1.114
TTS-20R	B1.90
TTS-20R0	B1.88
TTS-35R3	B1.90
TTS-35R3-0	B1.88
TTS-35RX	B1.90
TTS-35RX0	B1.88
TV105-.38D20Y	C3.18
TV105-.38DY	C3.18
TV105-.50D20Y	C3.18
TV105-.50DY	C3.18
TV105-.75TL20Y	C3.18
TV105-.75TLY	C3.18
TV105-1.0C20Y	C3.18
TV105-1.0CY	C3.18
TV105-12M20Y	C3.18
TV105-12MY	C3.18
TV105-1M20Y	C3.18
TV105-1MY	C3.18
TV105-3M20Y	C3.18
TV105-3MY	C3.18
TV105-6M20Y	C3.18
TV105-6MY	C3.18
TWR-C	B2.41
TWR-C0	B2.41

## U

UCT3S-X0	B1.89
UCT5S-X0	B1.89
UCTGS1224-X	B1.89
UCTGSM5-X	B1.89
UCTGSM6-X	B1.89
UGCTC3S-X0	B1.89
UGCTC5S-X0	B1.89
UGCTE3S-X0	B1.89
UGCTE5S-X0	B1.89

## V

VCC25-A-C	B2.36
VCC50-A-C	B2.36
VSC.25-L	B2.41
VSC.25-L100	B2.41
VT-0-Q	D2.127
VT-1-Q	D2.127
VT2-Q	D2.127
VT3-12	D2.127
VT4-12	D2.127
VT5-6	D2.127
VT6-6	D2.127
VTA-0-Q	D2.128
VTA-1-Q	D2.128
VTA-2-Q	D2.128
VTA-3-12	D2.128
VTA-4-12	D2.128
VTA-5-6	D2.128
VTA-6-6	D2.128
VWS106-C	B2.45
VWS106-C20	B2.45
VWS42105-C	B2.43
VWS4218-C	B2.43
VWS4238-C	B2.43
VWS4274-C	B2.43
VWSDC-C	B2.45
VWSDC-C20	B2.45

Part Number	Page Number
<b>W</b>	
WB12-L	D3.28
WB34-X	D3.28
WB58-Q	D3.28
WBS6-Q	B2.45
WCM35BFIW	C2.91
WCM35BIW8	C2.90
WCM35CCIW-X	C2.91
WCM35CIW8	C2.90
WCM35DBFIW	C2.91
WCM35DW8	C2.90
WCM35ECIW	C2.91
WCM35ICIW	C2.91
WCM35OCIW	C2.91
WCM35TI	C2.91
WCM35TIW	C2.91
WCM35TR10IW	C2.91
WCM35TR5IW	C2.91
WCM35TR70IW	C2.91
WCM35TRIW	C2.91
WCM35WR-X	C2.91
WEH-E8-C	B2.49
WL1	E5.27
WL3	E5.27
WL32Y	E5.27
WL33Y	E5.27
WL35Y	E5.27
WL36Y	E5.27
WPMH-C	B2.21
WPS-20	C2.61
WPS-202	C2.61
WR2-C	C1.28
WR2H-C	C1.28
WR3-C	C1.28
WR4-C	C1.28
WR5-C	C1.28
WRS-A-C10	C1.28
WS25-25-C	B2.42
WS25-50-C	B2.42
WS25-75-C	B2.42
WS35-25-C	B2.42
WS35-50-C	B2.42
WS35-75-C	B2.42
WS50-25-C	B2.42
WS50-50-C	B2.42
WS50-75-C	B2.42
WS75-25-C	B2.42
WS75-50-C	B2.42
WS75-75-C	B2.42

## A. System Overview

### B1. Cable Ties

### B2. Cable Accessories

### B3. Stainless Steel Ties

### C1. Wiring Duct

### C2. Surface Raceway

### C3. Abrasion Protection

### C4. Cable Management

### D1. Terminals

### D2. Power Connectors

### D3. Grounding Connectors

### E1. Labeling Systems

### E2. Labels

### E3. Pre-Printed & Write-On Markers

### E4. Permanent Identification

### E5. Lockout/Tagout & Safety Solutions

### F. Index

**Panduit is a global leader in cabling and communication products, delivering end-to-end solutions in support of demanding electrical and networking requirements.**

## **Panduit Catalogs**

### **Network Connectivity**

**SA-NCCB51**

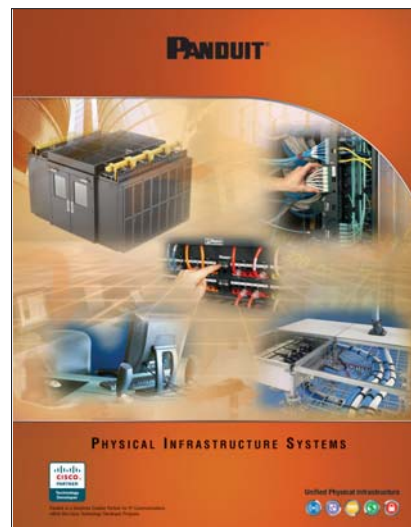

- Copper Systems
- Fiber Optic Systems
- Power over Ethernet
- Zone Cabling
- Wireless
- Outlets
- Media Distribution
- Physical Infrastructure Management
- Overhead and Underfloor Routing
- Surface Raceway
- Cabinets, Racks, and Cable Management
- Grounding and Bonding
- Industrial
- Labeling and Identification
- Cable Management Accessories





Компания «ЭлектроПласт» предлагает заключение долгосрочных отношений при поставках импортных электронных компонентов на взаимовыгодных условиях!

Наши преимущества:

- Оперативные поставки широкого спектра электронных компонентов отечественного и импортного производства напрямую от производителей и с крупнейших мировых складов;
- Поставка более 17-ти миллионов наименований электронных компонентов;
- Поставка сложных, дефицитных, либо снятых с производства позиций;
- Оперативные сроки поставки под заказ (от 5 рабочих дней);
- Экспресс доставка в любую точку России;
- Техническая поддержка проекта, помощь в подборе аналогов, поставка прототипов;
- Система менеджмента качества сертифицирована по Международному стандарту ISO 9001;
- Лицензия ФСБ на осуществление работ с использованием сведений, составляющих государственную тайну;
- Поставка специализированных компонентов (Xilinx, Altera, Analog Devices, Intersil, Interpoint, Microsemi, Aeroflex, Peregrine, Syfer, Eurofarad, Texas Instrument, Miteq, Cobham, E2V, MA-COM, Hittite, Mini-Circuits, General Dynamics и др.);

Помимо этого, одним из направлений компании «ЭлектроПласт» является направление «Источники питания». Мы предлагаем Вам помощь Конструкторского отдела:

- Подбор оптимального решения, техническое обоснование при выборе компонента;
- Подбор аналогов;
- Консультации по применению компонента;
- Поставка образцов и прототипов;
- Техническая поддержка проекта;
- Защита от снятия компонента с производства.



#### Как с нами связаться

**Телефон:** 8 (812) 309 58 32 (многоканальный)

**Факс:** 8 (812) 320-02-42

**Электронная почта:** [org@eplast1.ru](mailto:org@eplast1.ru)

**Адрес:** 198099, г. Санкт-Петербург, ул. Калинина, дом 2, корпус 4, литера А.