

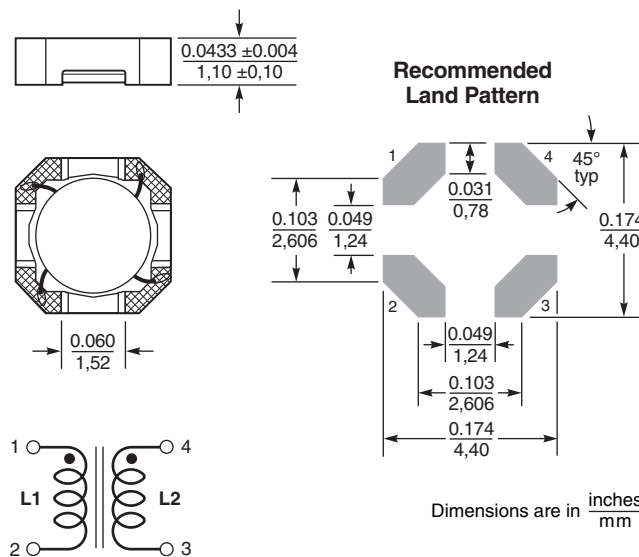

# Coupled Inductors – LPD4012 For Flyback, SEPIC and other Applications

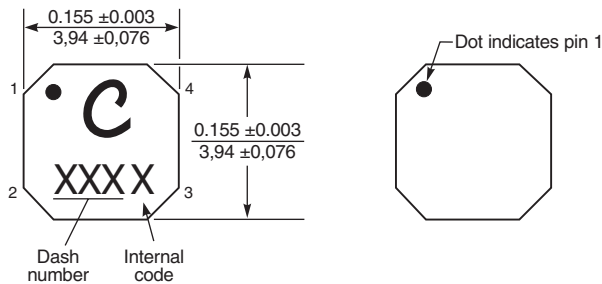

- Only 1.1 mm high and 4 mm square
- Ideal for use in flyback, multi-output buck and SEPIC applications.
- High inductance, high efficiency and excellent current handling
- Can also be used as two single inductors connected in series or parallel or as a common mode choke.

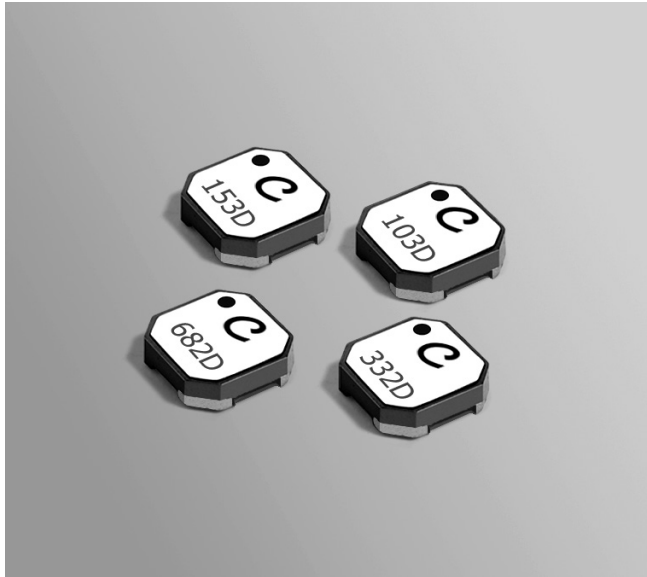
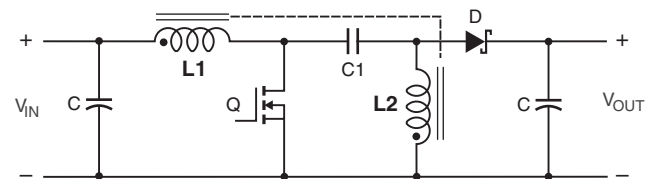
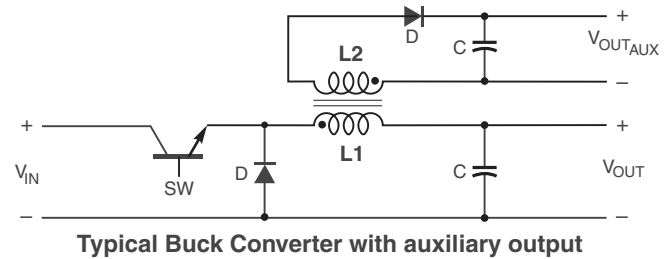
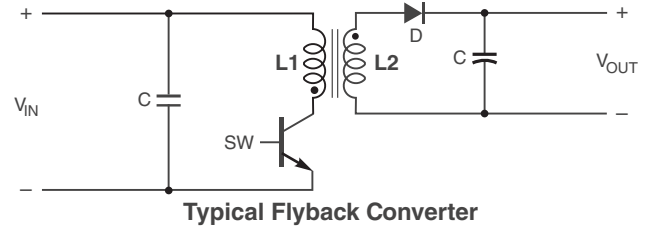

**Core material** Ferrite  
**Core and winding loss** [Go to online calculator](#)  
**Weight** 54 – 64 mg  
**Environmental** RoHS compliant, halogen free  
**Terminations** RoHS compliant matte tin over nickel over silver. Other terminations available at additional cost.  
**Ambient temperature** –40°C to +85°C with I<sub>rms</sub> current, +85°C to +125°C with derated current  
**Storage temperature** Component: –40°C to +125°C. Tape and reel packaging: –40°C to +80°C  
**Winding to winding isolation** 100 V  
**Resistance to soldering heat** Max three 40 second reflows at +260°C, parts cooled to room temperature between cycles  
**Moisture Sensitivity Level (MSL)** 1 (unlimited floor life at <30°C / 85% relative humidity)  
**Failures in Time (FIT) / Mean Time Between Failures (MTBF)** 38 per billion hours / 26,315,789 hours, calculated per Telcordia SR-332  
**Packaging** 1000/7" reel; 3500/13" reel Plastic tape: 12 mm wide, 0.25 mm thick, 8 mm pocket spacing, 1.32 mm pocket depth  
**Recommended pick and place nozzle** OD: 4 mm; ID: ≤2 mm  
**PCB washing** Tested with pure water or alcohol only. For other solvents, see Doc787\_PCB\_Washing.pdf.



**US** +1-847-639-6400 sales@coilcraft.com  
**UK** +44-1236-730595 sales@coilcraft-europe.com  
**Taiwan** +886-2-2264 3646 sales@coilcraft.com.tw  
**China** +86-21-6218 8074 sales@coilcraft.com.cn  
**Singapore** + 65-6484 8412 sales@coilcraft.com.sg

Document 580-1 Revised 07/10/13  
 © Coilcraft Inc. 2014  
 This product may not be used in medical or high risk applications without prior Coilcraft approval. Specification subject to change without notice. Please check web site for latest information.



# Coupled Inductors for SEPIC Applications – LPD4012 Series

Part number <sup>1</sup>	Inductance <sup>2</sup> ( $\mu$ H)	DCR max <sup>3</sup> (Ohms)	SRF typ <sup>4</sup> (MHz)	Coupling coefficient typ	Leakage L typ <sup>5</sup> ( $\mu$ H)	Isat (A) <sup>6</sup>			Irms (A)	
						10% drop	20% drop	30% drop	both windings <sup>7</sup>	one winding <sup>8</sup>
LPD4012-331NR_	0.33 $\pm$ 30%	0.042	255	0.94	0.06	5.2	5.4	5.6	1.87	2.65
LPD4012-561NR_	0.56 $\pm$ 30%	0.087	185	0.95	0.08	3.7	3.8	3.9	1.30	1.84
LPD4012-821NR_	0.82 $\pm$ 30%	0.100	130	0.97	0.09	3.2	3.3	3.4	1.21	1.72
LPD4012-152NR_	1.5 $\pm$ 30%	0.185	86	0.97	0.11	2.50	2.81	2.91	1.15	1.62
LPD4012-222NR_	2.2 $\pm$ 30%	0.235	70	0.98	0.14	2.30	2.40	2.50	0.95	1.35
LPD4012-332NR_	3.3 $\pm$ 30%	0.320	48	0.98	0.16	1.80	1.90	2.00	0.75	1.06
LPD4012-472MR_	4.7 $\pm$ 20%	0.500	39	0.98	0.18	1.60	1.70	1.80	0.65	0.92
LPD4012-562MR_	5.6 $\pm$ 20%	0.620	32	0.99	0.20	1.50	1.60	1.60	0.55	0.78
LPD4012-682MR_	6.8 $\pm$ 20%	0.530	31	0.99	0.22	1.20	1.52	1.63	0.60	0.86
LPD4012-822MR_	8.2 $\pm$ 20%	0.600	29	0.99	0.24	1.10	1.20	1.30	0.55	0.78
LPD4012-103MR_	10 $\pm$ 20%	0.750	25	0.99	0.26	0.98	1.00	1.10	0.50	0.71
LPD4012-153MR_	15 $\pm$ 20%	1.13	21	0.99	0.30	0.90	0.92	0.94	0.43	0.60
LPD4012-223MR_	22 $\pm$ 20%	1.63	15	0.99	0.34	0.70	0.82	0.84	0.34	0.48
LPD4012-333MR_	33 $\pm$ 20%	1.83	12	>0.99	0.41	0.37	0.57	0.58	0.31	0.44
LPD4012-473MR_	47 $\pm$ 20%	2.52	8.8	>0.99	0.51	0.33	0.39	0.40	0.28	0.39
LPD4012-683MR_	68 $\pm$ 20%	3.23	7.8	>0.99	0.66	0.27	0.36	0.37	0.25	0.36
LPD4012-823MR_	82 $\pm$ 20%	3.66	7.3	>0.99	0.75	0.27	0.27	0.29	0.23	0.31
LPD4012-104MR_	100 $\pm$ 20%	4.76	6.1	>0.99	0.86	0.22	0.28	0.29	0.20	0.27
LPD4012-124MR_	120 $\pm$ 20%	5.54	5.3	>0.99	0.98	0.21	0.26	0.27	0.19	0.27
LPD4012-154MR_	150 $\pm$ 20%	6.90	4.6	>0.99	1.19	0.18	0.26	0.27	0.17	0.23
LPD4012-184MR_	180 $\pm$ 20%	8.75	4.1	>0.99	1.40	0.16	0.21	0.23	0.14	0.18
LPD4012-224MR_	220 $\pm$ 20%	11.24	3.3	>0.99	1.66	0.15	0.16	0.17	0.12	0.17
LPD4012-334MR_	330 $\pm$ 20%	17.00	2.8	>0.99	2.45	0.13	0.16	0.16	0.10	0.14

1. Please specify **termination** and **packaging** codes:

#### LPD4012-334MRC

**Termination: R** = RoHS compliant, matte tin over nickel over silver.

Special order:

**Q** = RoHS tin-silver-copper (95.5/4/0.5) or

**P** = non-RoHS tin-lead (63/37).

**Packaging: C** = 7" machine-ready reel. EIA-481 embossed plastic tape (1000 parts per full reel).

**B** = Less than full reel. In tape, but not machine ready.  
To have a leader and trailer added (\$25 charge), use code letter D instead.

**D** = 13" machine-ready reel. EIA-481 embossed plastic tape. Factory order only, not stocked (3500 parts per full reel).

- Inductance shown for each winding, measured at 100 kHz, 0.1 Vrms, 0 Adc on an Agilent/HP 4284A LCR meter or equivalent. When leads are connected in parallel, inductance is the same value. When leads are connected in series, inductance is four times the value.
- DCR is for each winding. When leads are connected in parallel, DCR is half the value. When leads are connected in series, DCR is twice the value.
- SRF measured using an Agilent/HP 4191A or equivalent. When leads are connected in parallel, SRF is the same value.
- Leakage Inductance is for L1 and is measured with L2 shorted.
- DC current, at which the inductance drops the specified amount from its value without current. It is the sum of the current flowing in both windings.
- Equal current when applied to each winding simultaneously that causes a 40°C temperature rise from 25°C ambient. See temperature rise calculation.
- Maximum current when applied to one winding that causes a 40°C temperature rise from 25°C ambient. See temperature rise calculation.
- Electrical specifications at 25°C.

Refer to Doc 639 "Selecting Coupled Inductors for SEPIC Applications."

Refer to Doc 362 "Soldering Surface Mount Components" before soldering.

#### Coupled Inductor Core and Winding Loss Calculator

This web-based utility allows you to enter frequency, peak-to-peak (ripple) current, and Irms current to predict temperature rise and overall losses, including core loss. [Go to online calculator.](#)



# Coupled Inductors for SEPIC Applications – LPD4012 Series

## Typical L vs Current

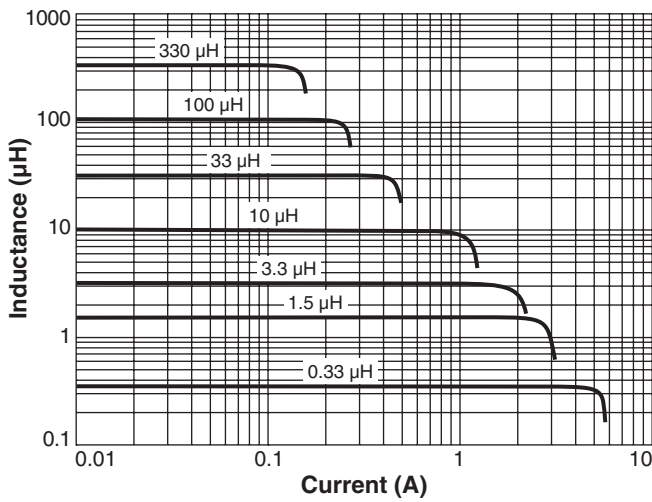

## Typical L vs Frequency

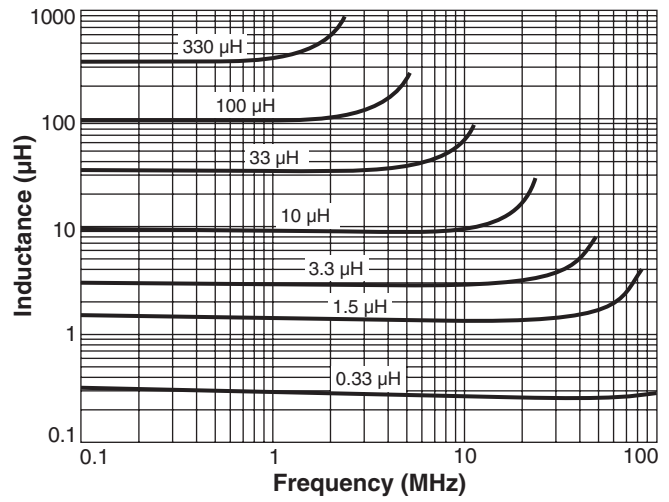

## Typical Current Derating

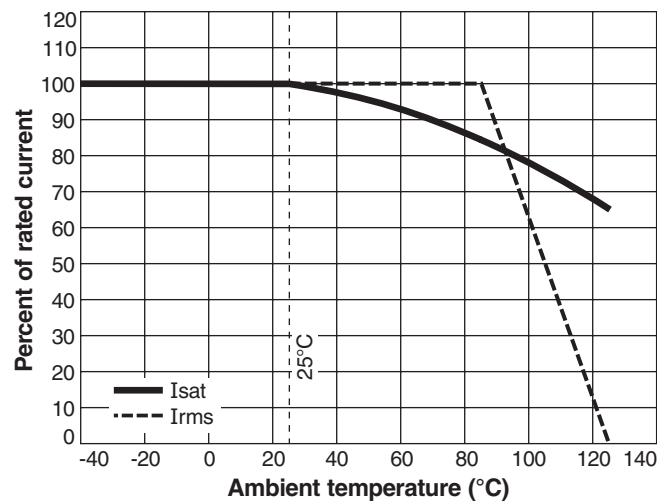



Компания «ЭлектроПласт» предлагает заключение долгосрочных отношений при поставках импортных электронных компонентов на взаимовыгодных условиях!

Наши преимущества:

- Оперативные поставки широкого спектра электронных компонентов отечественного и импортного производства напрямую от производителей и с крупнейших мировых складов;
- Поставка более 17-ти миллионов наименований электронных компонентов;
- Поставка сложных, дефицитных, либо снятых с производства позиций;
- Оперативные сроки поставки под заказ (от 5 рабочих дней);
- Экспресс доставка в любую точку России;
- Техническая поддержка проекта, помощь в подборе аналогов, поставка прототипов;
- Система менеджмента качества сертифицирована по Международному стандарту ISO 9001;
- Лицензия ФСБ на осуществление работ с использованием сведений, составляющих государственную тайну;
- Поставка специализированных компонентов (Xilinx, Altera, Analog Devices, Intersil, Interpoint, Microsemi, Aeroflex, Peregrine, Syfer, Eurofarad, Texas Instrument, Miteq, Cobham, E2V, MA-COM, Hittite, Mini-Circuits, General Dynamics и др.);

Помимо этого, одним из направлений компании «ЭлектроПласт» является направление «Источники питания». Мы предлагаем Вам помощь Конструкторского отдела:

- Подбор оптимального решения, техническое обоснование при выборе компонента;
- Подбор аналогов;
- Консультации по применению компонента;
- Поставка образцов и прототипов;
- Техническая поддержка проекта;
- Защита от снятия компонента с производства.



#### Как с нами связаться

**Телефон:** 8 (812) 309 58 32 (многоканальный)

**Факс:** 8 (812) 320-02-42

**Электронная почта:** [org@eplast1.ru](mailto:org@eplast1.ru)

**Адрес:** 198099, г. Санкт-Петербург, ул. Калинина, дом 2, корпус 4, литера А.