

Generation 2

Sensus™ LED Series

Pure White Targeted COB Arrays Below the Black Body Locus (BBL) Preliminary Data Sheet



Table of Contents

- Technology Overview2
- Test Specifications2
- Chromaticity Bins3
- Product Ordering & Shipping
Part Numbers4
- Product Typical Flux Range 5
- Operating Characteristics ..6
- Optical and Electrical Character-
istics.....9
- Spectra 13
- Mechanical Dimensions .. 14
- Packaging Information ... 14
- Handling Notes 21

Features:

- Matching the human perception of “Pure white” light
- Designed to provide the look and feel of ceramic metal halide lights
- Wide product range from 300lm to over 5,000lm
- 3000K and 3500K, 80 and 90CRI standard
- 3 SDCM color binning accuracy
- Excellent optical emission uniformity and color over angle consistency
- Exceptional long term color stability
- Package thermal conductivity more than the industry average
- Environmentally friendly: RoHS and REACH compliant
- UL Recognized, File # E465703



Applications

- Retail Shop Lighting
- Halogen replacement LED lamps
- Spotlights/Track Lights
- Hospitality Lighting
- CMH replacement LED lamps
- Architectural and Specialty

Technology Overview

Luminus Chip-on-Board (COB) LED series offers a complete lighting class solution designed for high performance illumination applications. The Sensus LED series has been specially design for retail shop lighting where enhanced red coloring is a preferred lighting standard. The selection covers a wide lumen range from less than 500lm to over 5,000lm, and is focused on the major market color and CRI of 3000K and both 80 and 90 CRI. These breakthroughs allow illumination engineers and designers to develop beautifully lit spaces without sacrificing efficacy, brightness and overall quality.

Reliability

Designed from the ground up, the Luminus COB LED is one of the most reliable light sources in the world today. Having passed a rigorous suite of environmental and mechanical stress tests, including mechanical shock, vibration, temperature cycling and humidity. Only then are the devices qualified for use in a wide range of lighting application including some of the most demanding commercial applications. Delivered with fully qualified LM-80 test data and TM-21 lifetime results that certify lumen maintenance at 35,000 hours or more, Luminus COB LEDs are ready for the toughest challenges.

UL Recognized Compliance

Luminus COB arrays are tested in accordance with ANSI/UL 8750 to ensure safe operation for their intended applications.

REACH & RoHS Compliance

All LED products manufactured by Luminus are REACH and RoHS compliant and free of hazardous materials, including lead and mercury.

Understanding Luminus COB LED Test Specifications

Every Luminus LED is fully tested to ensure it meets the high quality standards customers have come to expect from Luminus' products.

Traceability

Each Luminus COB LED is marked with a 2D bar code that contains a unique serial number. With this serial number, Luminus has the ability to provide customers with actual test data measurements for a specific LED. In addition, the 2D bar code is linked to manufacturing date codes that enables traceability of production processes and materials.

Chromaticity Bin Range

Chromaticity binning delivers color consistency for every order. Standard products are delivered with a 3-step MacAdam ellipse. This ensures color performance matching in the application. These tightly controlled, small distribution bins provide customers predictable, repeatable colors.

Testing Temperature

Luminus COB products are measured at temperatures typical for the LED operating in the fixture. Each device is tested at 85°C junction temperature eliminating the need to scale data sheet specifications to real world situations.

Chromaticity Bin Structure

Chromaticity Bins: 1931 CIE Curve

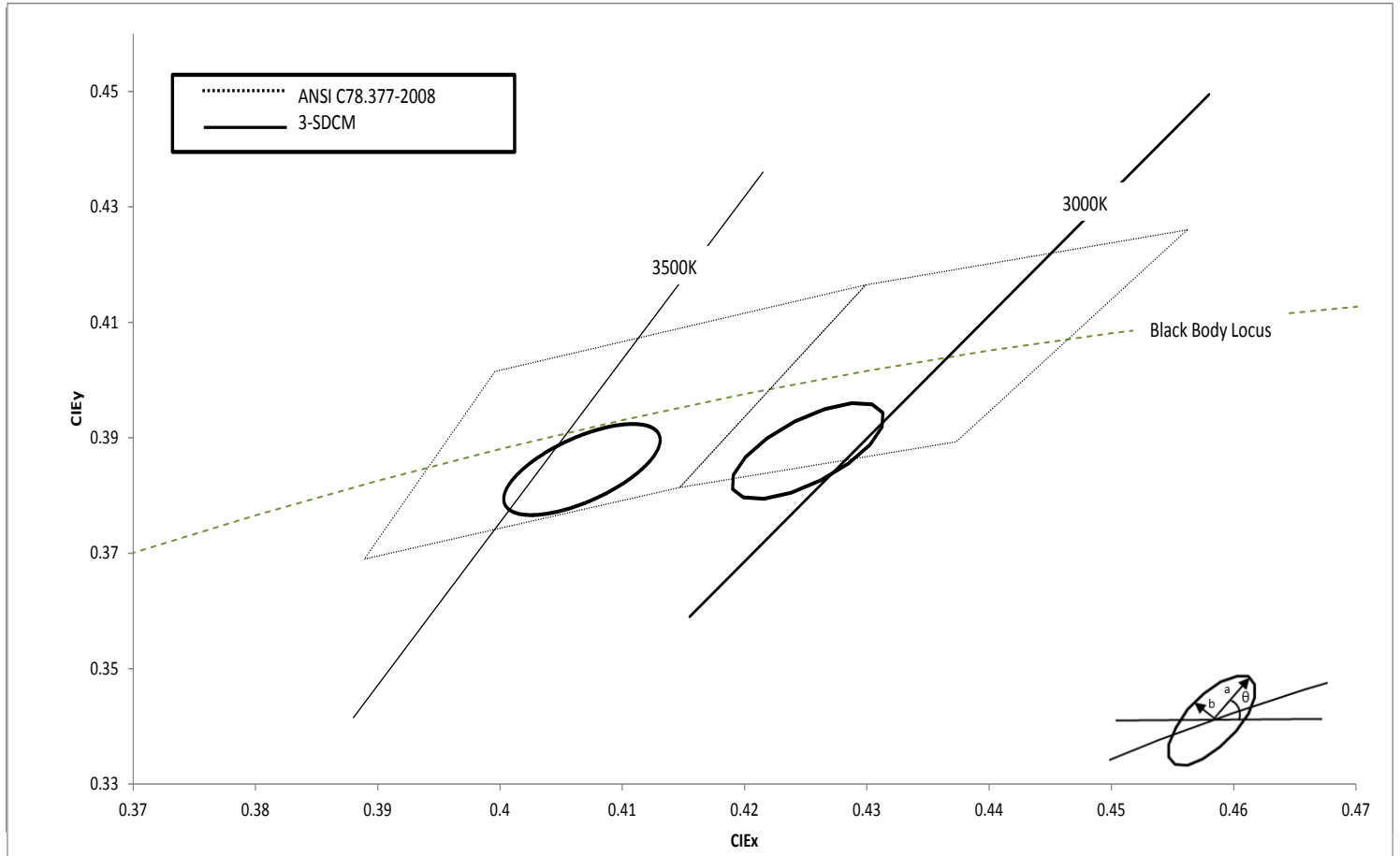

Sensus™ LED White Chromaticity Bins

The following tables describe the ANSI bin center points, the orientation angle for the MacAdam ellipse (θ°), and the maximum radii for the ellipses. The ANSI Bin is provided for reference.

| CCT | Center Point | | 3-step Bin | | |
|-------|------------------|------------------|----------------|---------|---------|
| | CIE _x | CIE _y | θ° | a | b |
| 3000K | 0.4252 | 0.3877 | 53.6 | 0.00834 | 0.00408 |
| 3500K | 0.4067 | 0.3845 | 54 | 0.00927 | 0.00414 |

*Note: Luminus maintains a +/- 0.005 tolerance on chromaticity (CIE_x and CIE_y) measurements.

Product Ordering and Shipping Part Number Nomenclature

All Sensus LED products are packaged and labeled with part numbers as outlined in the table on page 5. Luminus will include any smaller chromaticity bin that is contained in the larger bin as part of the ordered part. When shipped, each package will contain only a single flux and chromaticity bin. The part number designation is as follows:

| Sensus™ LED Series | | | | | | | | | | | | | | |
|--------------------|--|--------------------------------|--|-------------------|----------------------|----------|---------------------|----|---|------|---|----|---|---|
| CXM | — | XX | — | 30 | — | 80 | — | 36 | — | QQPP | — | FG | — | W |
| Product Family | Light Emitting Surface Diameter ¹ | Color Temperature ² | Color Rendering Index (CRI) ³ | Voltage (typical) | Package Configurator | Flux Bin | Chromaticity Bin | | | | | | | |
| CHM: Chip on Board | XX: LES Diameter (mm) Approximate | CT | XX | Volts | AA12 (Basic package) | Lumens | See page 3 for bins | | | | | | | |

Note 1: XX nomenclature corresponds to the following:

- 9 = 9mm
- 14 = 13.5mm
- 18 = 17.5mm
- 22 = 22mm

Note 2: CT Nomenclature corresponds to the following

- 30 is 3000K
- 35 is 3500K

Note 3: XX Color Rendering nomenclature corresponds to the following

- 80 = 80 CRI
- 90 = 90 CRI
- 95 = 95 CRI

Note 4: AA12 is a standard package configurator

AC12 is an alternative substrate size

Color Temperature, CRI and R9 Values

| Color Temperatures | XX Value | CRI | R9 |
|--------------------|----------|-----|-----|
| 3000K, 3500K | 80 | >80 | >0 |
| | 90 | >90 | >50 |

Note: Luminus part numbers may be accompanied by prefixes or suffixes. The most common is the “Rev01” suffix indicating a part is fully released and carries a full warranty. These additional characters may appear on shipping labels, packing slips and invoices. In all cases the basic part number described above will always be included.

Sensus™ LED Series Part Numbers (Typical)

The following tables describe products with typical flux and minimum flux measured at typical currents and specified at 85°C. The values at 25°C are calculated and shown for reference only. All product is measured and specified at 85°C junction temperature.

| Output Flux (lm) | | | CRI | Typ. Current (mA) | Ordering Part Number |
|------------------|-------------|--------------------------|-----|-------------------|---------------------------|
| Typ. (85°C) | Min. (85°C) | Typ. (calculated) (25°C) | | | 3 SDCM |
| 1,025 | 975 | 1,130 | 80 | 240 | CXM-9-30-80-36-AC12-F3-3 |
| | | | | | CXM-9-30-80-36-AA12-F3-3 |
| 1,055 | 1,000 | 1,175 | | | CXM-9-35-80-36-AC12-F3-3 |
| | | | | | CXM-9-35-80-36-AA12-F3-3 |
| 870 | 825 | 965 | 90 | 240 | CXM-9-30-90-36-AC12-F3-3 |
| | | | | | CXM-9-30-90-36-AA12-F3-3 |
| 910 | 865 | 1,000 | | | CXM-9-35-90-36-AC12-F3-3 |
| | | | | | CXM-9-35-90-36-AA12-F3-3 |
| 2,125 | 1,980 | 2,825 | 80 | 480 | CXM-14-30-80-36-AC12-F3-3 |
| | | | | | CXM-14-30-80-36-AA12-F3-3 |
| 2,185 | 2,040 | 2,425 | | | CXM-14-35-80-36-AC12-F3-3 |
| | | | | | CXM-14-35-80-36-AA12-F3-3 |
| 1,795 | 1,675 | 1,995 | 90 | 480 | CXM-14-30-90-36-AC12-F3-3 |
| | | | | | CXM-14-30-90-36-AA12-F3-3 |
| 1,725 | 1,755 | 1,910 | | | CXM-14-35-90-36-AC12-F3-3 |
| | | | | | CXM-14-35-90-36-AA12-F3-3 |
| 3,535 | 3,355 | 3,920 | 80 | 800 | CXM-18-30-80-36-AA12-F3-3 |
| 3,010 | 2,855 | 3,335 | 90 | | CXM-18-30-90-36-AA12-F3-3 |
| 5,645 | 5,360 | 6,210 | 80 | 1,280 | CXM-22-30-80-36-AC12-F3-3 |
| 4,800 | 4,555 | 5,280 | 90 | | CXM-22-30-90-36-AC12-F3-3 |
| 5,020 | 4,670 | 5,520 | 90 | | CXM-22-35-90-36-AC12-F3-3 |

*Note: Luminus maintains a +/- 6% tolerance on flux measurements.

Luminus maintains a +/- 2% tolerance on CRI measurements.

Sensus™ LED Series Part Numbers (Typical)

The following tables describe products with typical flux and minimum flux measured at typical currents and specified at 85°C. The values at 25°C are calculated and shown for reference only. All product is measured and specified at 85°C junction temperature.

| Output Flux (lm) | | | CRI | Typ. Current (mA) | Ordering Part Number |
|------------------|-------------|--------------------------|-----|-------------------|---------------------------|
| Typ. (85°C) | Min. (85°C) | Typ. (calculated) (25°C) | | | 3 SDCM |
| 1,530 | 1,420 | 1,680 | 80 | 360 | CHM-9-30-80-36-AC12-F3-3 |
| | | | | | CHM-9-30-80-36-AA12-F3-3 |
| 1,200 | 1,115 | 1,320 | | | CHM-9-35-80-36-AC12-F3-3 |
| | | | | | CHM-9-35-80-36-AA12-F3-3 |
| 1,290 | 1,200 | 1,420 | 90 | 360 | CHM-9-30-90-36-AC12-F3-3 |
| | | | | | CHM-9-30-90-36-AA12-F3-3 |
| 1,590 | 1,480 | 1,750 | | | CHM-9-35-90-36-AC12-F3-3 |
| | | | | | CHM-9-35-90-36-AA12-F3-3 |
| 3,080 | 2,860 | 3,380 | 80 | 720 | CHM-14-30-80-36-AC12-F3-3 |
| | | | | | CHM-14-30-80-36-AA12-F3-3 |
| 2,430 | 2,260 | 2,670 | | | CHM-14-35-80-36-AC12-F3-3 |
| | | | | | CHM-14-35-80-36-AA12-F3-3 |
| 2,610 | 2,430 | 2,870 | 90 | 720 | CHM-14-30-90-36-AC12-F3-3 |
| | | | | | CHM-14-30-90-36-AA12-F3-3 |
| 3,210 | 2,980 | 2,530 | | | CHM-14-35-90-36-AC12-F3-3 |
| | | | | | CHM-14-35-90-36-AA12-F3-3 |

*Note: Luminus maintains a +/- 6% tolerance on flux measurements.

Luminus maintains a +/- 2% tolerance on CRI measurements.

CXM-9 Operating Characteristics¹
Optical and Electrical Characteristics

| Parameter | Symbol | Minimum | Typical | Maximum | Unit |
|---|---------------|---------|---------|---------|--------|
| Forward Current ² | I_f | | 240 | 550 | mA |
| Forward Voltage ³ | V_f | 32 | 35 | 37.5 | V |
| Power | | | 8.6 | 21 | W |
| Operating Case Temperature ⁴ | T_c | | | 100 | °C |
| Light Emitting Surface Diameter | LES | | 9 | | mm |
| Thermal Resisitance (junction-to-case) | Θ_{jc} | | 1.51 | | °C/W |
| Junction Temperature | T_j | | | 140 | °C |
| Viewing Angle | | | 120 | | Degree |

CXM-14 Operating Characteristics¹
Optical and Electrical Characteristics

| Parameter | Symbol | Minimum | Typical | Maximum | Unit |
|--|---------------|---------|---------|---------|--------|
| Forward Current ² | I_f | | 480 | 1,090 | mA |
| Forward Voltage ³ | V_f | 32 | 35 | 37.5 | V |
| Power | | | 17.3 | 41 | W |
| Operating Case Temperature | T_c | | | 105 | °C |
| Light Emitting Surface Diameter | LES | | 13.5 | | mm |
| Thermal Resisitance (junction-to-case) | Θ_{jc} | | 0.87 | | °C/W |
| Junction Temperature | T_j | | | 140 | °C |
| Viewing Angle | | | 120 | | Degree |

CXM-18 Operating Characteristics¹
Optical and Electrical Characteristics

| Parameter | Symbol | Minimum | Typical | Maximum | Unit |
|---|---------------|---------|---------|---------|--------|
| Forward Current ² | I_f | | 800 | 1,800 | mA |
| Forward Voltage ³ | V_f | 32 | 35 | 37.5 | V |
| Power | | | 29 | 67.5 | W |
| Operating Case Temperature ⁴ | T_c | | | 105 | °C |
| Light Emitting Surface Diameter | LES | | 17.5 | | mm |
| Thermal Resisitance (junction-to-case) | Θ_{jc} | | 0.56 | | °C/W |
| Junction Temperature | T_j | | | 140 | °C |
| Viewing Angle | | | 120 | | Degree |

CXM-22 Operating Characteristics¹
Optical and Electrical Characteristics

| Parameter | Symbol | Minimum | Typical | Maximum | Unit |
|---|---------------|---------|---------|---------|--------|
| Forward Current ² | I_f | | 1,280 | 2,900 | mA |
| Forward Voltage ³ | V_f | 32 | 35 | 37.5 | V |
| Power | | | 45 | 109 | W |
| Operating Case Temperature ⁴ | T_c | | | 105 | °C |
| Light Emitting Surface Diameter | LES | | 22 | | mm |
| Thermal Resisitance (junction-to-case) | Θ_{jc} | | N/A | | °C/W |
| Junction Temperature | T_j | | | 140 | °C |
| Viewing Angle | | | 120 | | Degree |

CHM-9 Operating Characteristics¹
Optical and Electrical Characteristics

| Parameter | Symbol | Minimum | Typical | Maximum | Unit |
|---|---------------|---------|---------|---------|--------|
| Forward Current ² | I_f | | 360 | 550 | mA |
| Forward Voltage ³ | V_f | 32 | 34.5 | 37.5 | V |
| Power | | | 12.5 | 21 | W |
| Operating Case Temperature ⁴ | T_c | | | 105 | °C |
| Light Emitting Surface Diameter | LES | | 9 | | mm |
| Thermal Resisitance (junction-to-case) | Θ_{jc} | | 0.85 | | °C/W |
| Junction Temperature | T_j | | | 140 | °C |
| Viewing Angle | | | 120 | | Degree |

CHM-14 Operating Characteristics¹
Optical and Electrical Characteristics

| Parameter | Symbol | Minimum | Typical | Maximum | Unit |
|---|---------------|---------|---------|---------|--------|
| Forward Current ² | I_f | | 720 | 1,090 | mA |
| Forward Voltage ³ | V_f | 32 | 34.5 | 37.5 | V |
| Power | | | 24.8 | 41 | W |
| Operating Case Temperature ⁴ | T_c | | | 105 | °C |
| Light Emitting Surface Diameter | LES | | 13.5 | | mm |
| Thermal Resisitance (junction-to-case) | Θ_{jc} | | 0.45 | | °C/W |
| Junction Temperature | T_j | | | 140 | °C |
| Viewing Angle | | | 120 | | Degree |

Operating Characteristics Notes

- Note 1: *Ratings are based on operation at a constant junction temperature $T_j = 85^\circ\text{C}$.*
- Note 2: *To prevent damage refer to operating conditions and derating curves for appropriate maximum operating conditions*
- Note 3: *Forward voltage is rated at typical forward current. For voltage at different forward currents, refer to the voltage versus current performance graphs.*
- Note 4: *COB LEDs are designed for operation to a minimum of 20% of the typical forward current value. Operation at currents lower than this value will not harm the device but may result in uneven light emission across the LES surface.*
- Note 5: *Luminus may change any specifications without prior notice. Please refer to the company web site for the latest data sheet revision*
- Note 6: *Caution must be taken not to stare at the light emitted from these LEDs. Under special circumstances, the high intensity could damage the eye.*

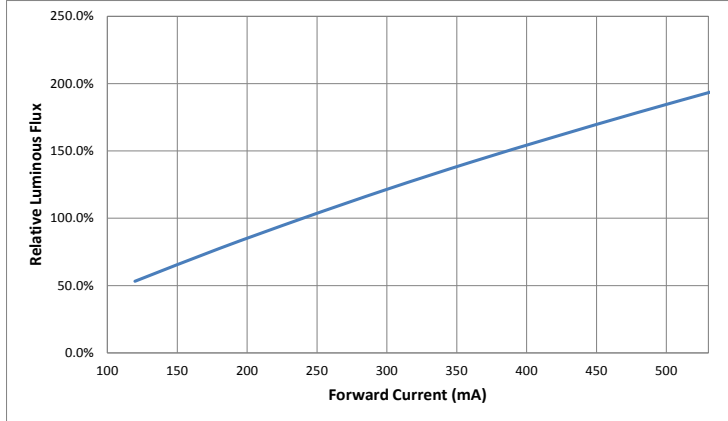
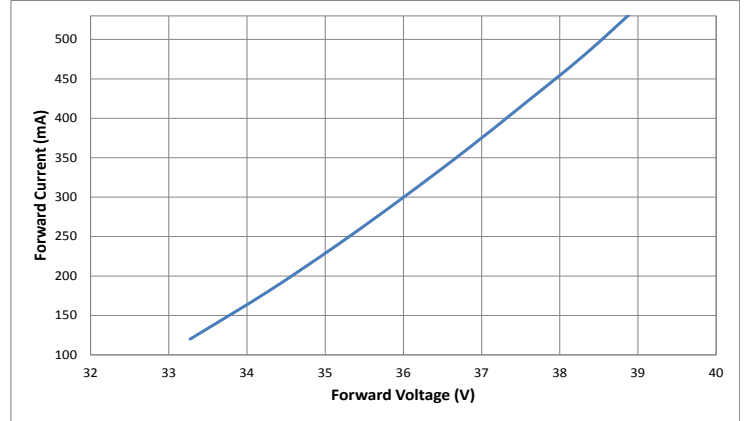
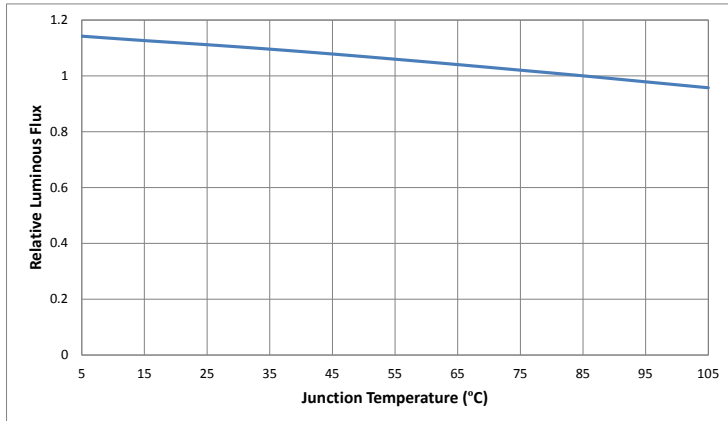
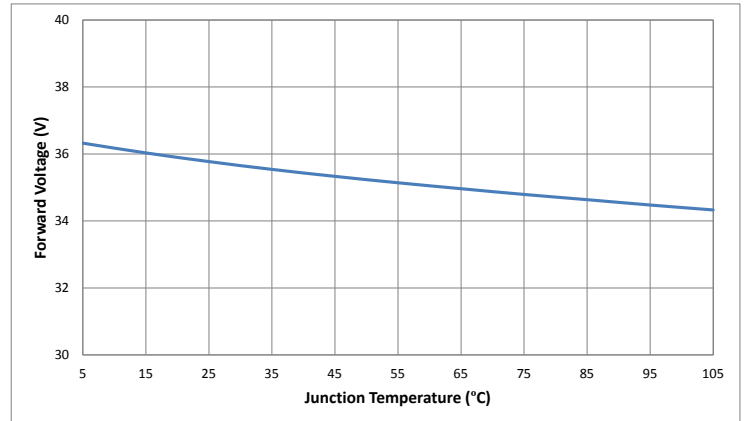
CXM-9 Optical & Electrical Characteristics
Relative Output Flux vs. Forward Current @ 85°C

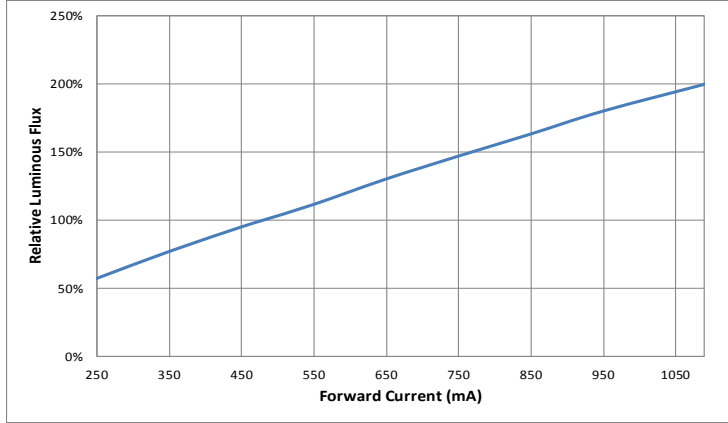
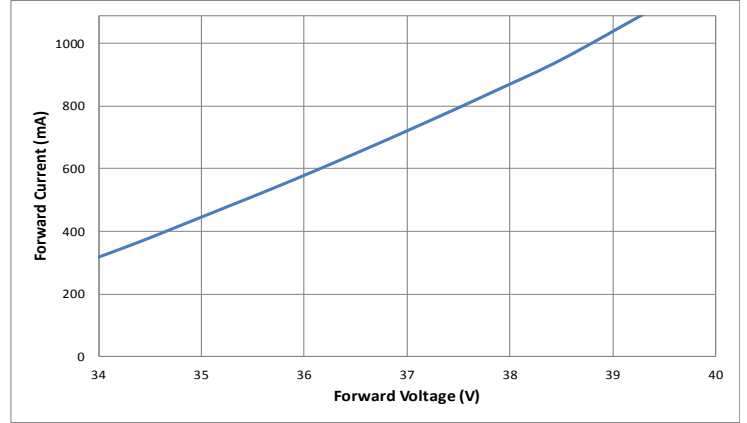
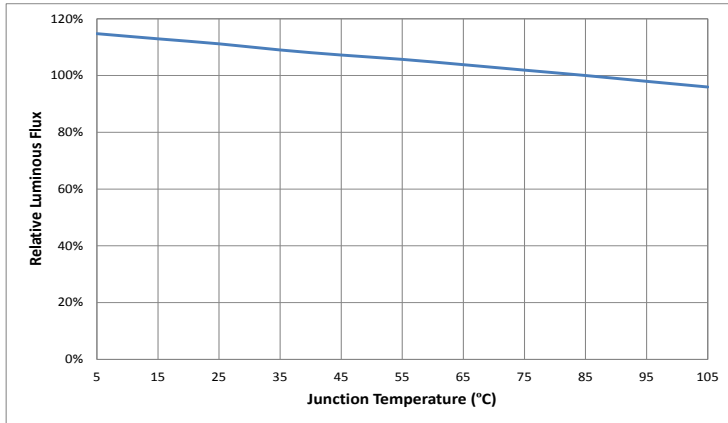
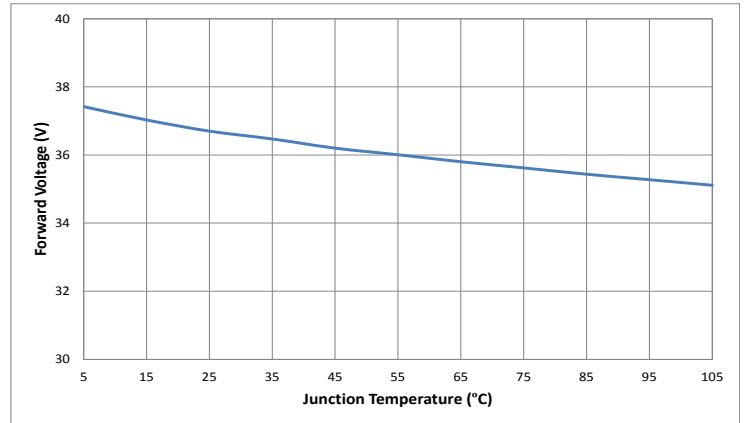
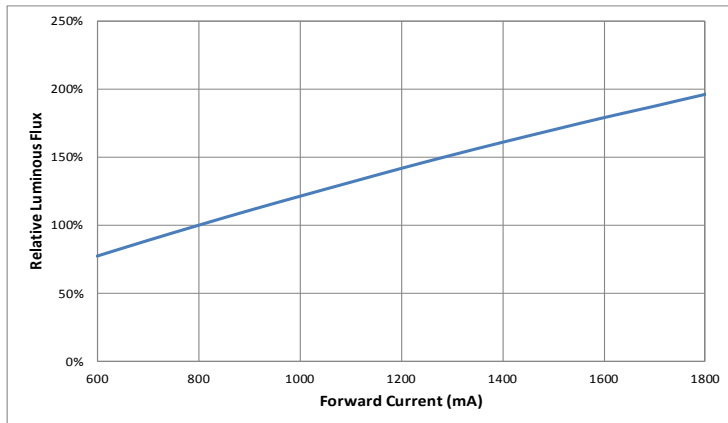
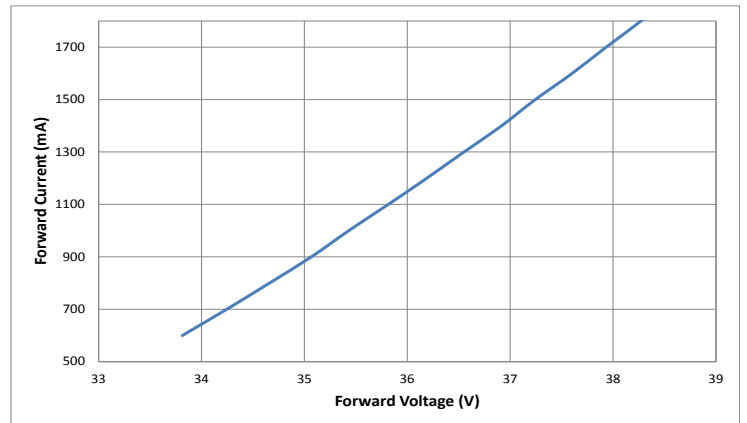
Forward Current vs. Forward Voltage @ 85°C

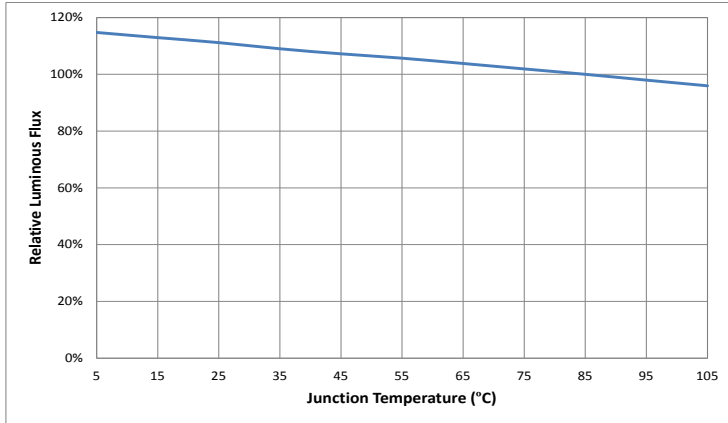
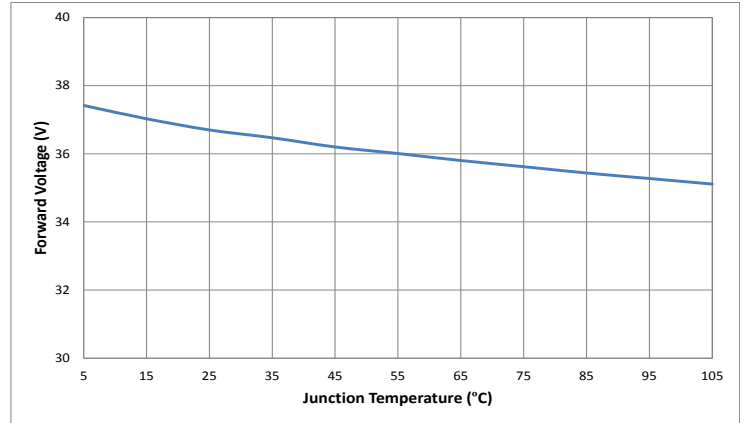
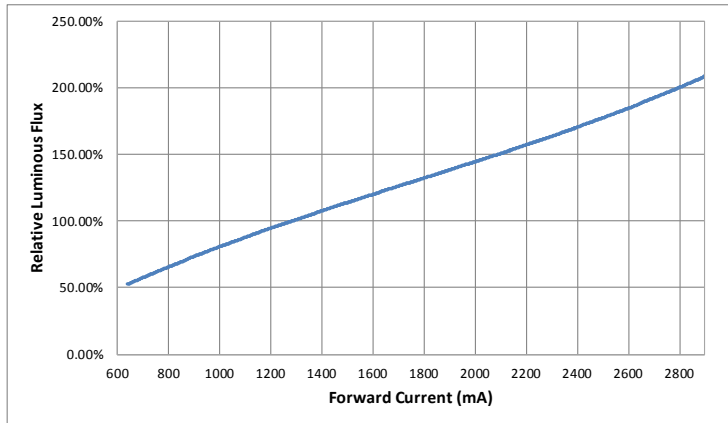
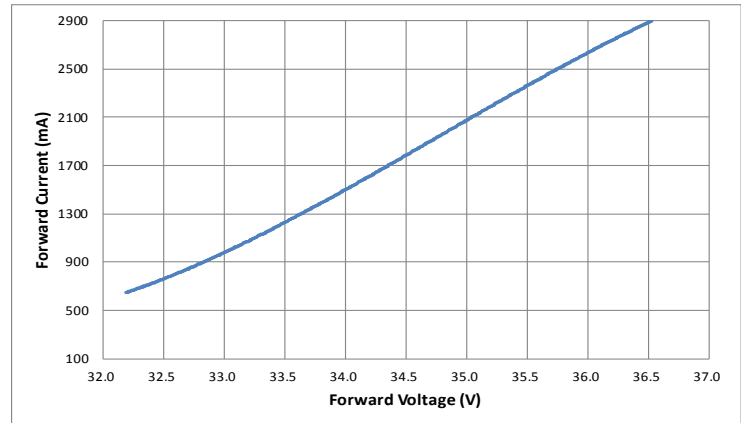
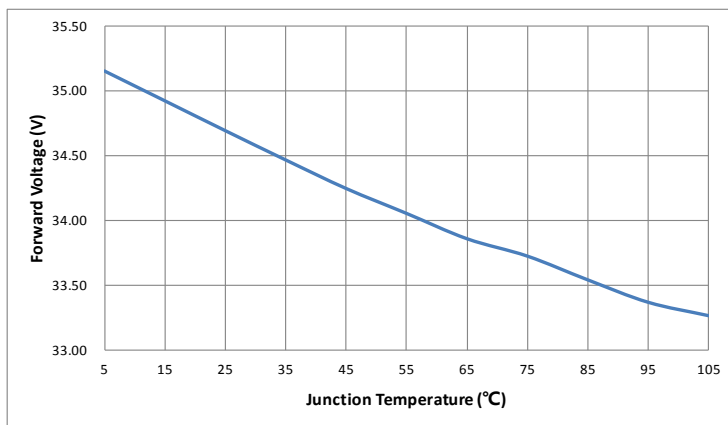
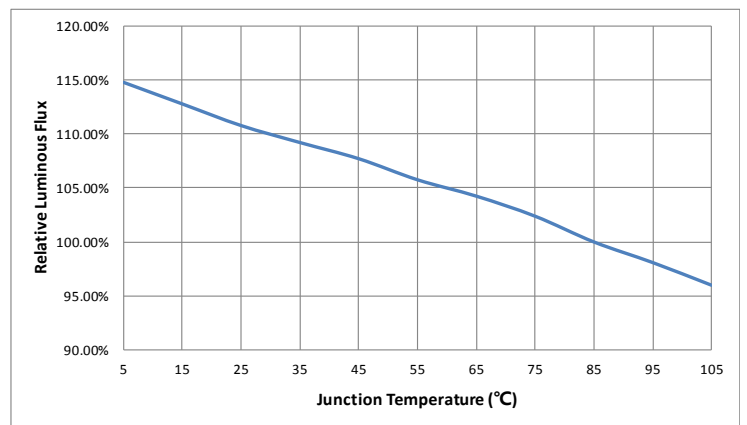
Relative Output Flux vs. Junction Temperature

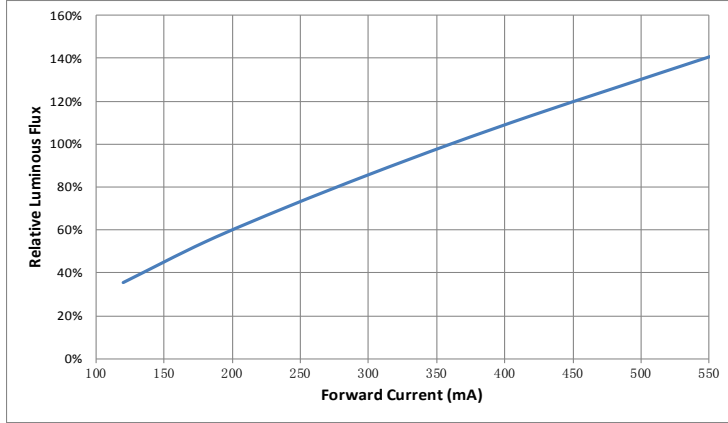
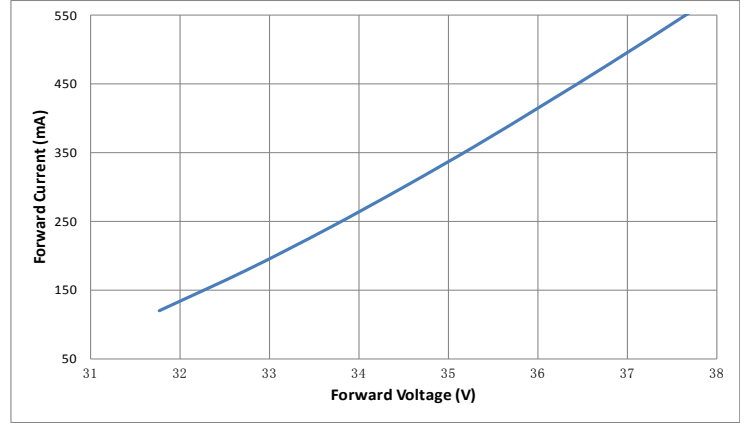
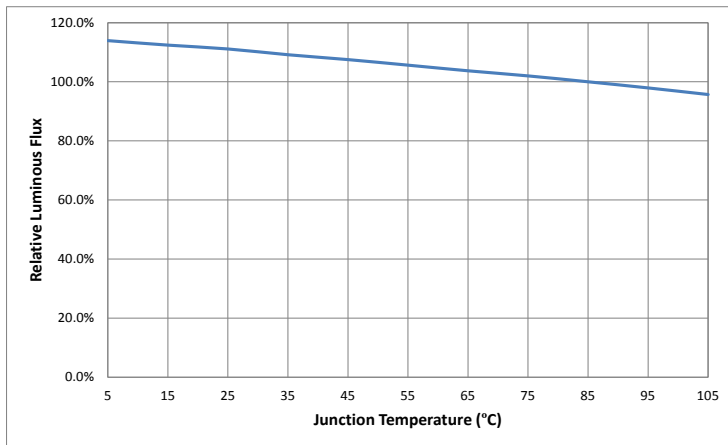
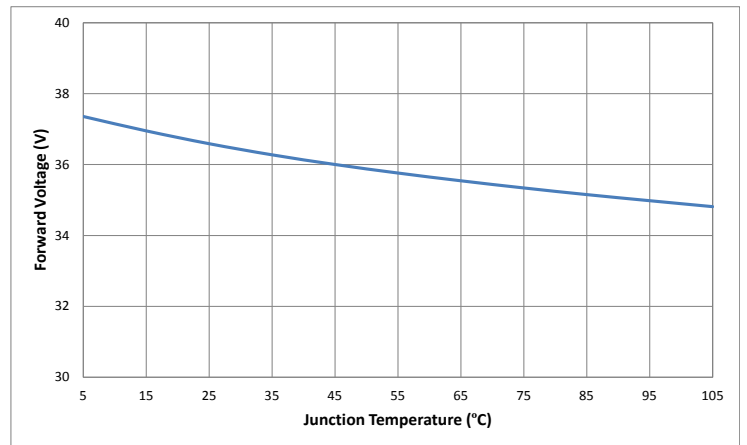
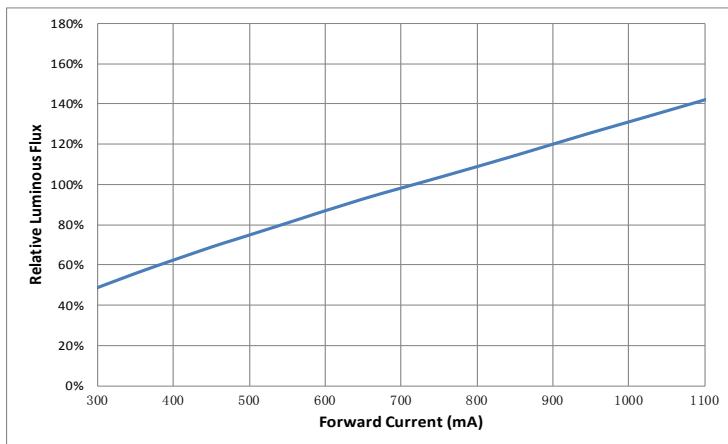
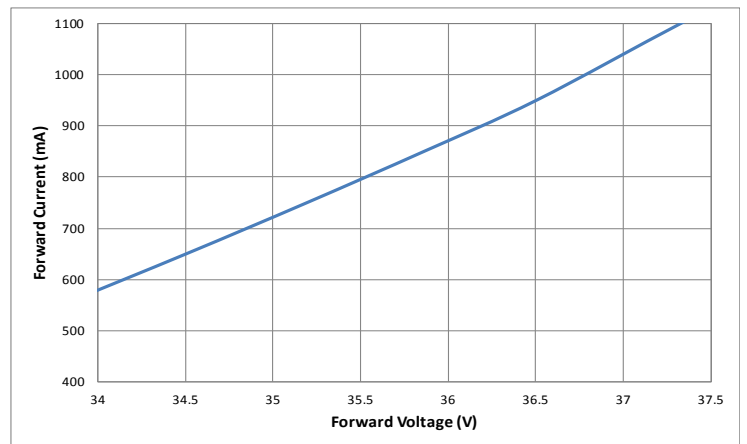
Change in Voltage vs. Junction Temperature

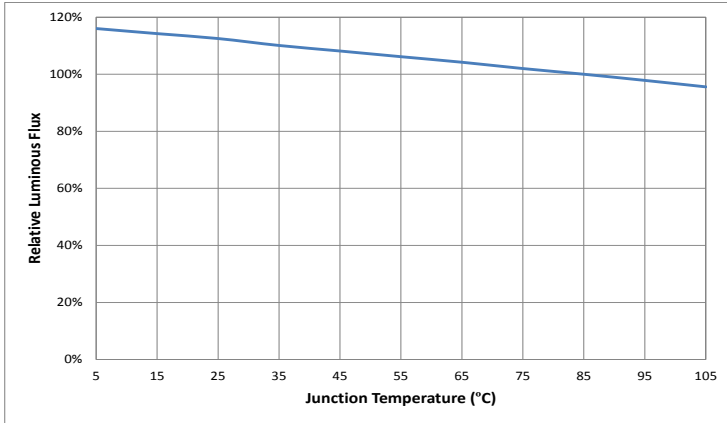
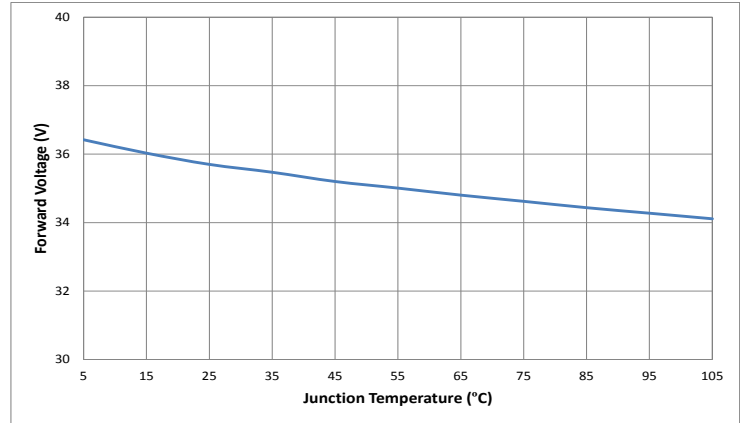
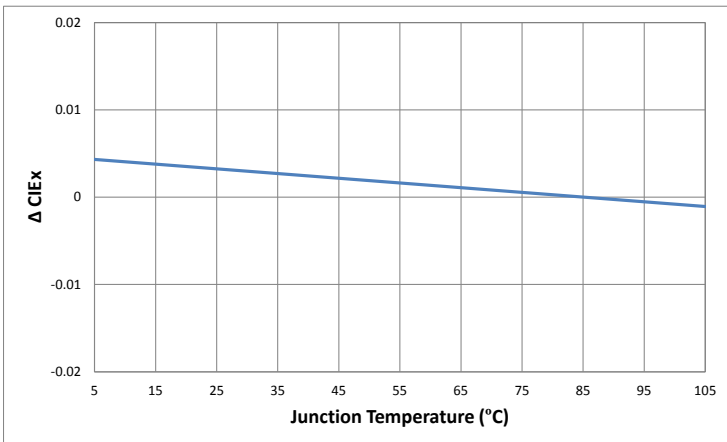
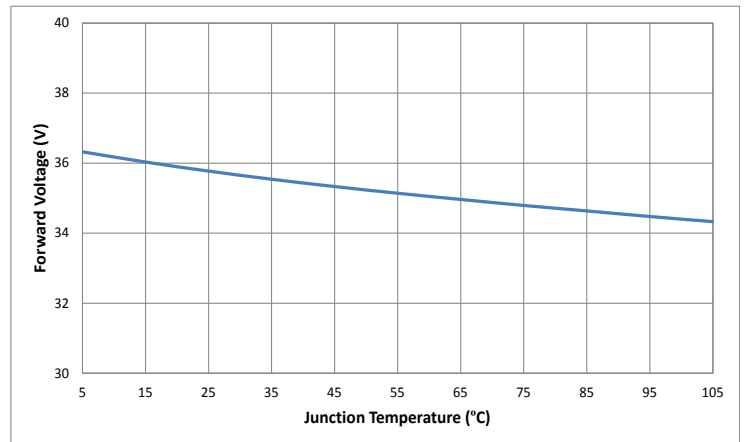
CXM-14 Optical & Electrical Characteristics
Relative Output Flux vs. Forward Current @ 85°C

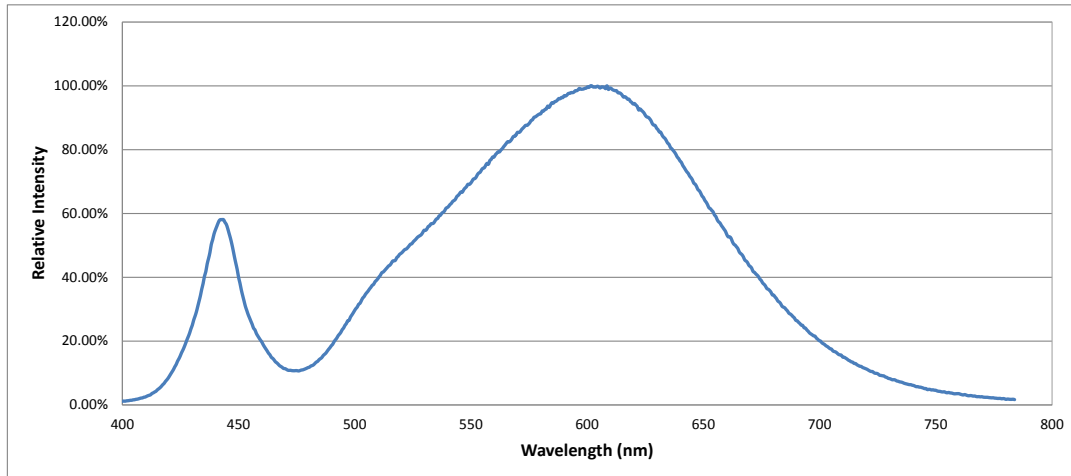
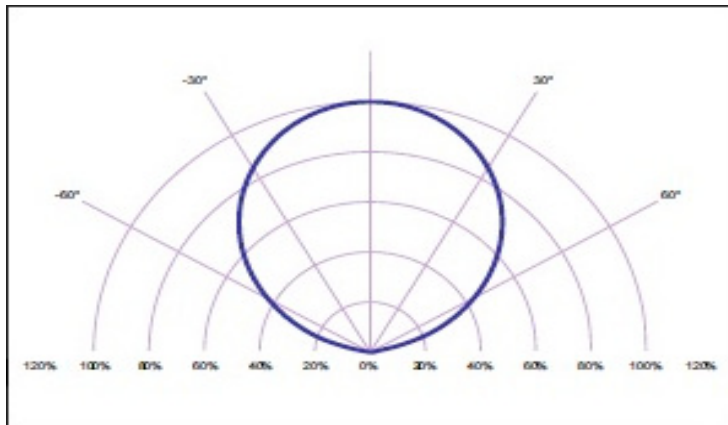
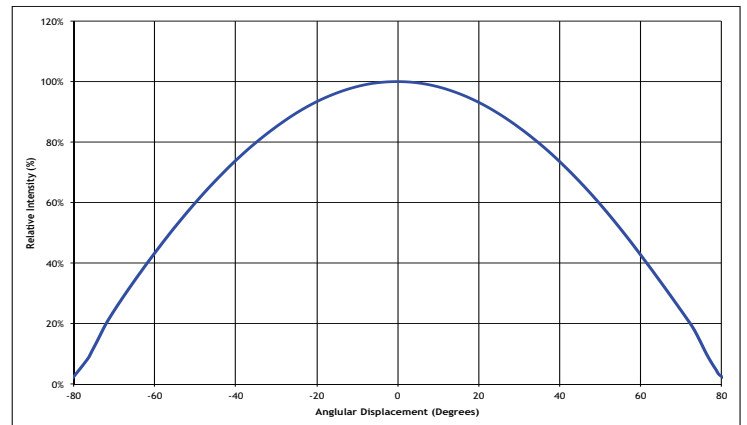
Forward Current vs. Forward Voltage @ 85°C

Relative Output Flux vs. Junction Temperature

Change in Voltage vs. Junction Temperature

CXM-18 Optical & Electrical Characteristics
Relative Output Flux vs. Forward Current @ 85°C

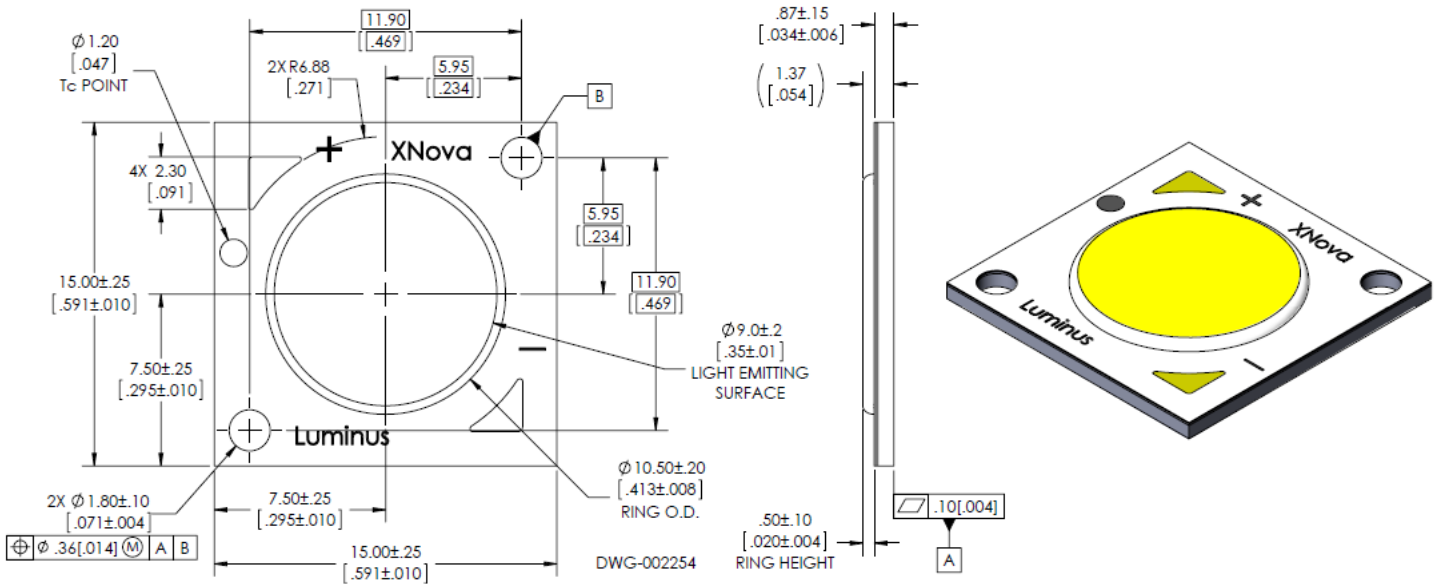
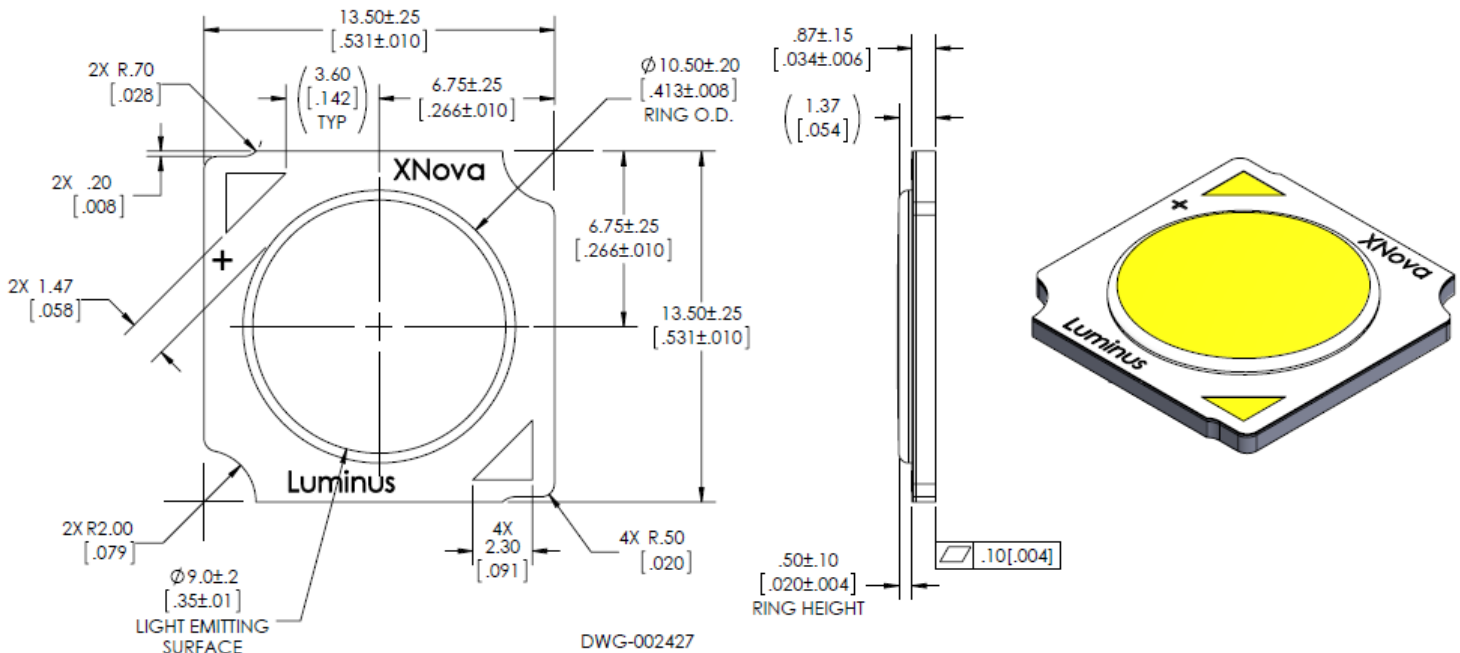
Forward Current vs. Forward Voltage @ 85°C

CXM-18 Optical & Electrical Characteristics
Relative Output Flux vs. Junction Temperature

Change in Voltage vs. Junction Temperature

CXM-22 Optical & Electrical Characteristics
Relative Output Flux vs. Forward Current @ 85°C

Forward Current vs. Forward Voltage @ 85°C

Relative Output Flux vs. Junction Temperature

Change in Voltage vs. Junction Temperature

CHM-9 Optical & Electrical Characteristics
Relative Output Flux vs. Forward Current @ 85°C

Forward Current vs. Forward Voltage @ 85°C

Relative Output Flux vs. Junction Temperature

Change in Voltage vs. Junction Temperature

CHM-14 Optical & Electrical Characteristics
Relative Output Flux vs. Forward Current @ 85°C

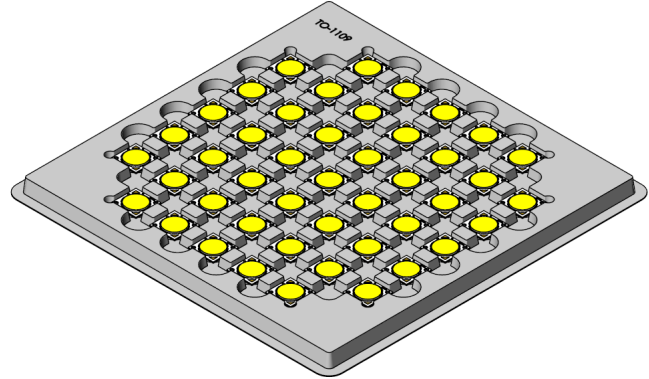
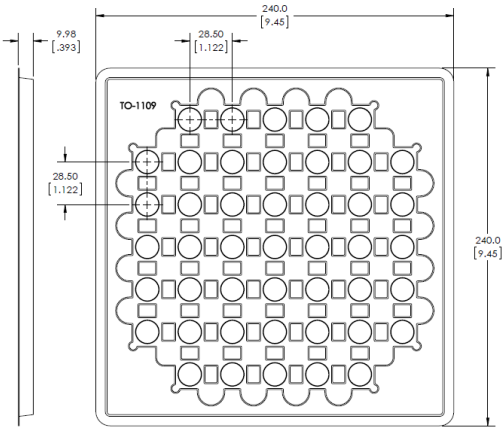
Forward Current vs. Forward Voltage @ 85°C

CHM-14 Optical & Electrical Characteristics
Relative Output Flux vs. Junction Temperature

Change in Voltage vs. Junction Temperature

Chromaticity Shift Characteristics
Change CIE_x vs. Junction Temperature (3000K, 80CRI)

Change CIE_y vs. Junction Temperature (3000K, 80CRI)

Optical Characteristics
Typical Spectrum

Typical Polar Radiation Pattern

Typical Angular Radiation Pattern

Mechanical Dimensions, CHM/CXM-9 (AA10)

Mechanical Dimensions, CHM/CXM-9 (AC10)

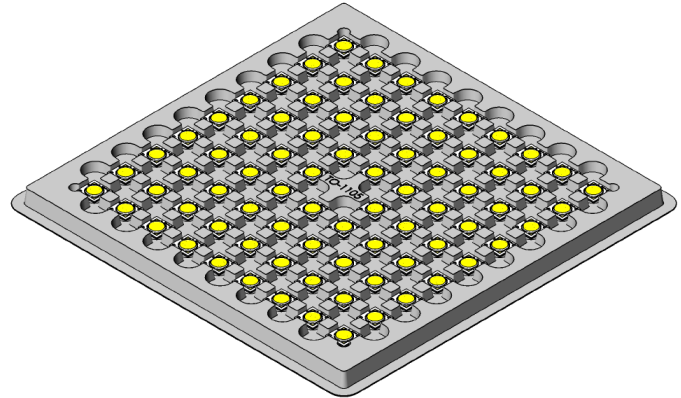
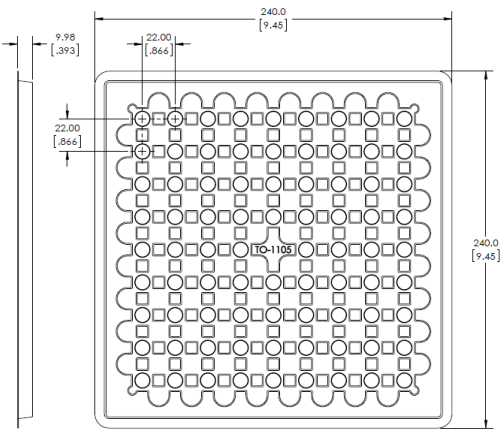
Shipping Container, CHM/CXM-9 (AA00)



Shipping Container, CHM/CXM-9 (AC00)



Each bag is boxed for easier storage/stacking

Trays are sealed in an anti-static bag

5 trays are stacked together with one tray as a cover

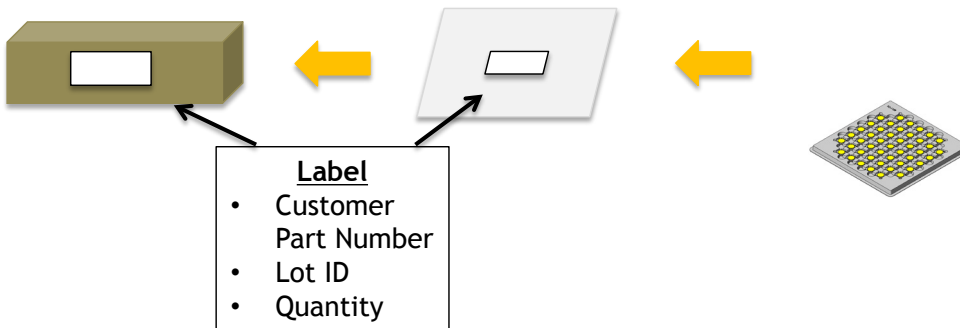

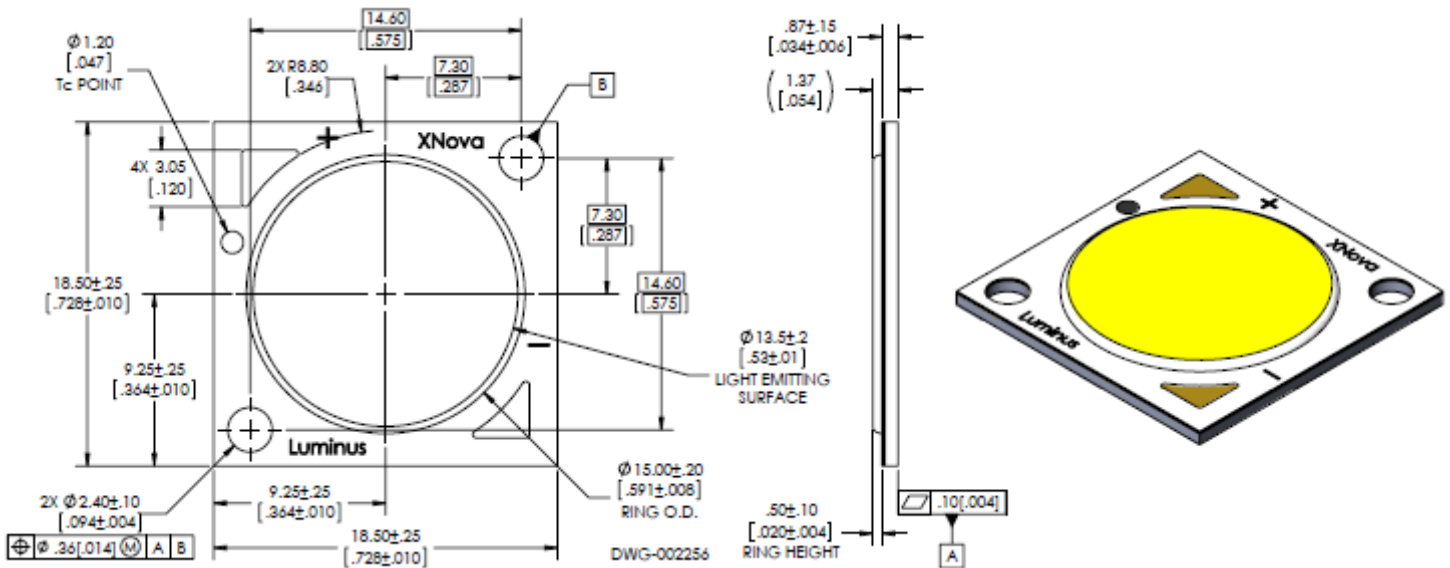
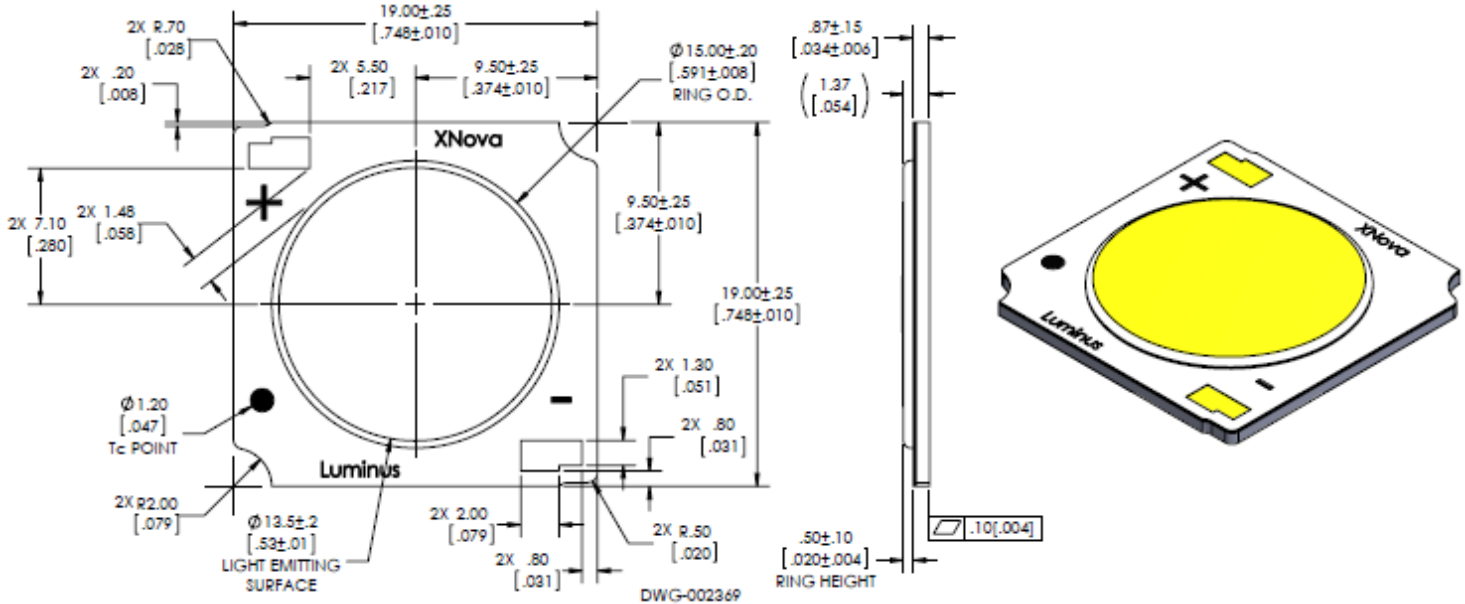
Mechanical Dimensions, CHM/CXM-14 (AA10)

Mechanical Dimensions, CHM/CXM-14 (AC10)

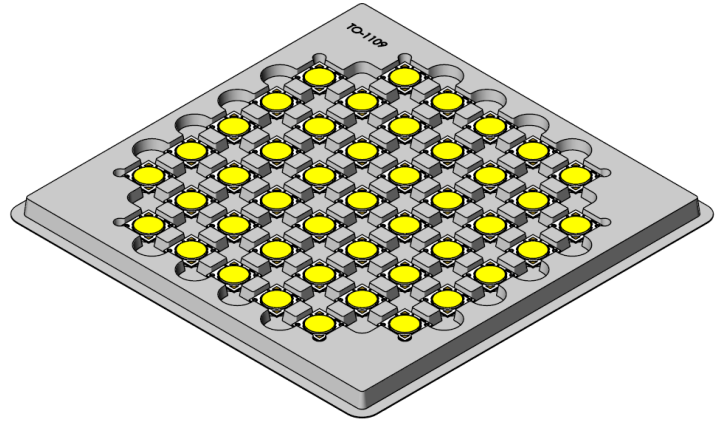
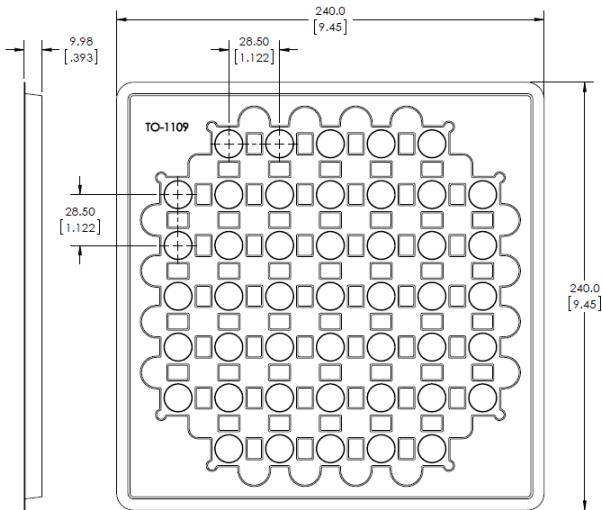
Shipping Container



Each bag is boxed for easier storage/stacking

Trays are sealed in an anti-static bag

5 trays are stacked together with one tray as a cover

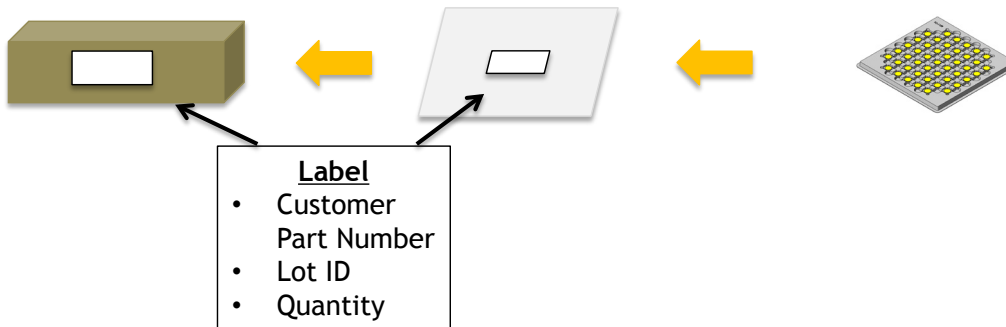

Mechanical Dimensions, CXM-18

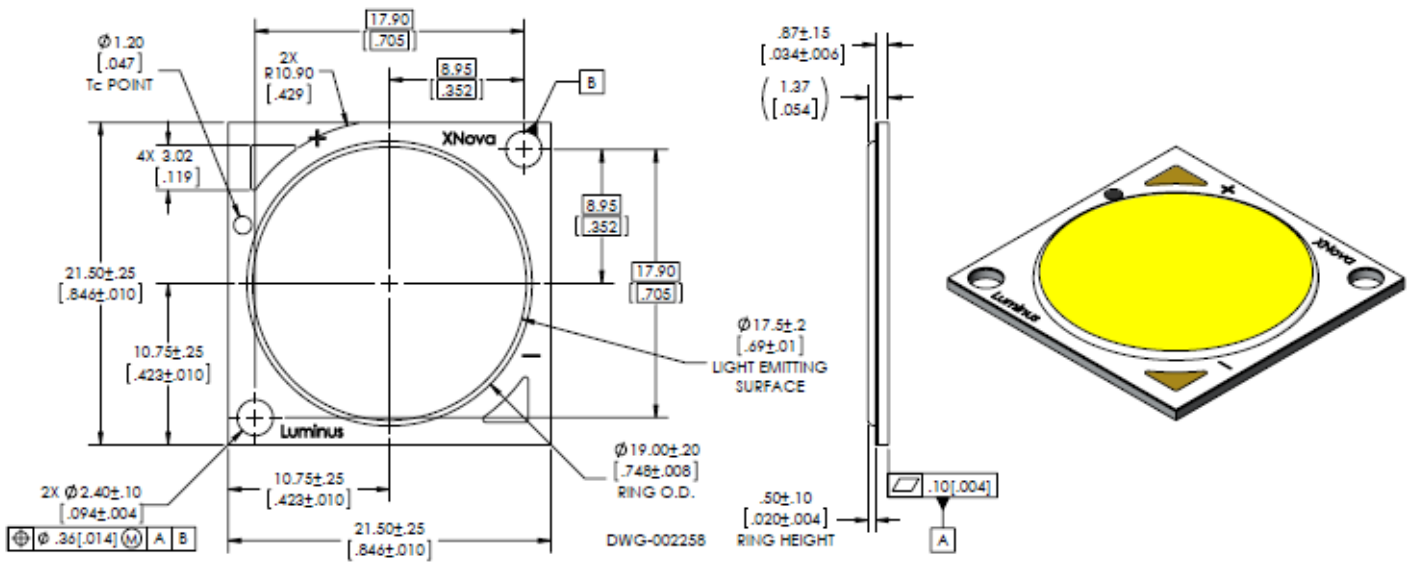

Shipping Container, CXM-18

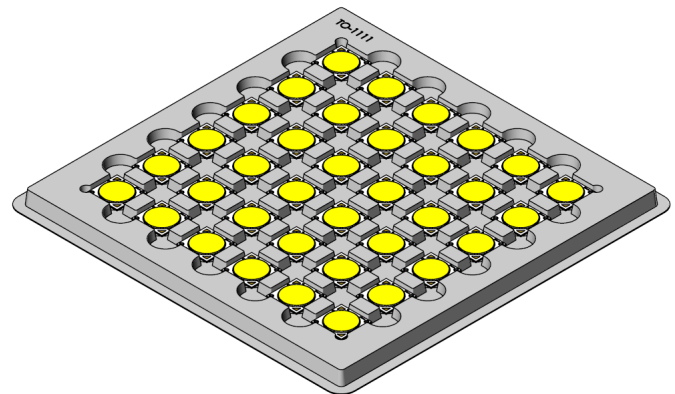
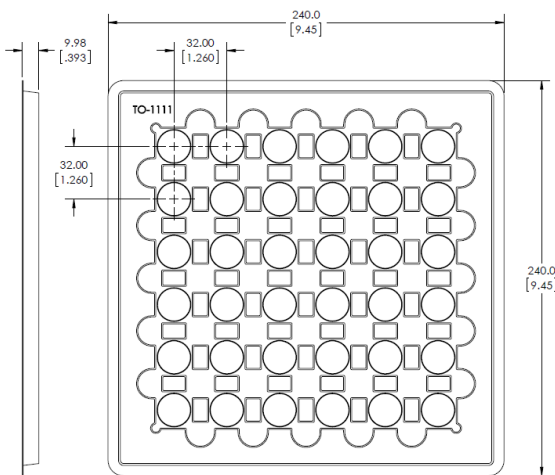

Each bag is boxed for easier storage/stacking

Trays are sealed in an anti-static bag

5 trays are stacked together with one tray as a cover

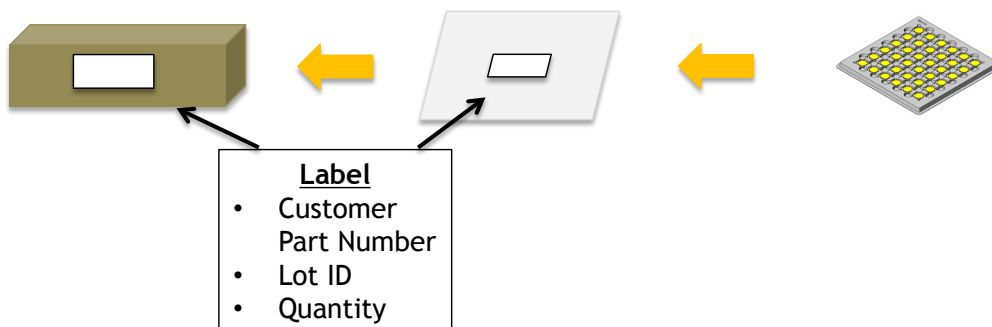

Mechanical Dimensions, CXM-22

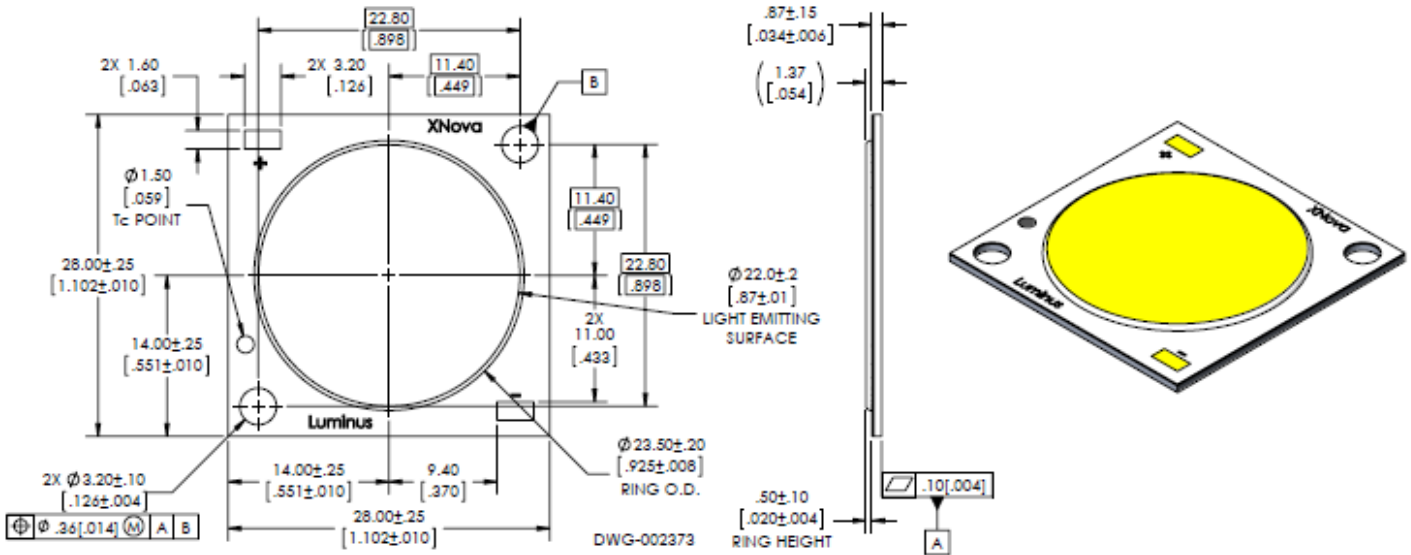

Shipping Container, CXM-22

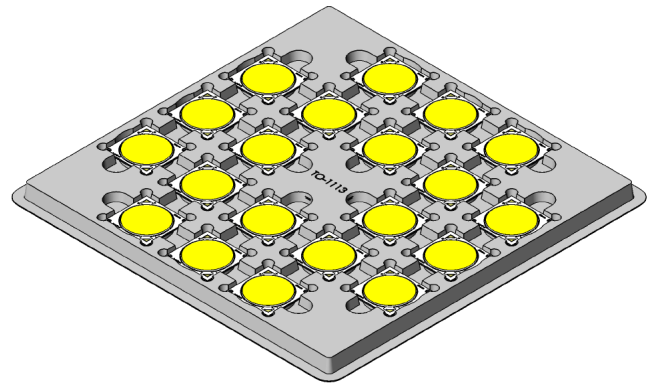
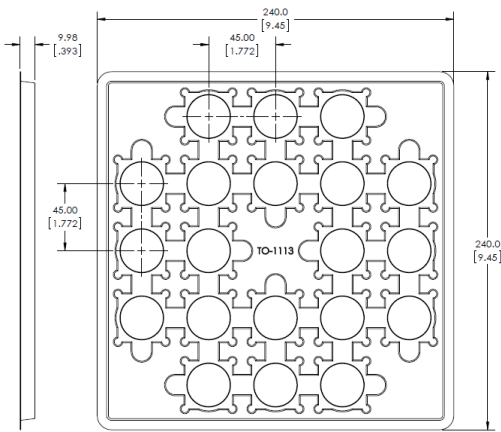

Each bag is boxed for easier storage/stacking

Trays are sealed in an anti-static bag

5 trays are stacked together with one tray as a cover

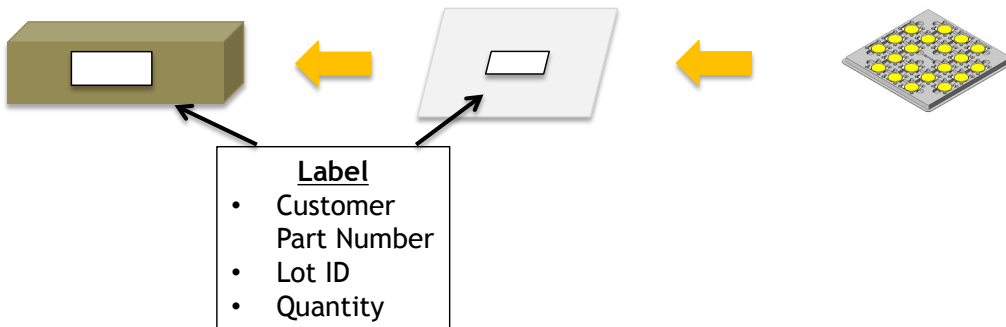

Handling Notes for Luminus COBs

Luminus products are designed for robust performance in general lighting application. However, care must be taken when handling and assembling the LEDs into their fixtures. To avoid damaging Luminus COBs please follow these guide lines.

The following is an overview of the application notes detailing some of the practices to follow when working with these devices. More detailed information is available on the Luminus web site at www.luminus.com.

General Handling

Devices are made to be lifted or carried with tweezers on two adjacent corners opposite the contact pads. At no time should the devices be handled by or should anything come in contact with the light emitting surface (LES) area. This area includes the yellow colored circular area and the ring surrounding it. There are electrical connections under the LES which if damaged will cause the device to fail.

In addition, the ring frame itself should not be used for moving, lifting or carrying the device. Also do not attach any optics or mechanical holders to the ring as it is not capable to handle the mechanical stress.

Static Electricity

Luminus COBs are electronic devices which can be damaged by electrostatic discharge (ESD). Please use appropriate measures to assure the devices do not experience ESD during their handling and or storage. ESD protection guidelines should be used at all times when working with Luminus COBs.

Storage: Luminus products are delivered in ESD shielded bags and should be stored in these bags until used.

Assembly: Individuals handling Luminus COBs during assembly should be trained in ESD protection practices. Assemblers should maintain constant conductive contact with a path to ground by means of a wrist strap, ankle straps, mat or other ESD protection system.

Transporting: When transporting the devices from one assembly area to another, ESD shielded carts and carriers should be used.

Electrical Contact

Luminus COBs are designed with contact pads on their top surface. These pads are clearly marked with + and – polarity. Wires can be soldered to the contact pads for electrical connections or other solderless connector products are available.

If wires are being soldered to the COB product, we recommend attaching these wires prior to mounting the devices to a heat sink. Please contact Luminus for specific recommendations on how to solder wires if not familiar with the standard practice. Luminus can also offer design recommendations for jigs to allow easily soldering multiple products in rapid succession.

Chemical Compatibility

The resin material used to form the LES can get hydrocarbons from the surrounding environment. As a result, certain chemical compounds are not recommended for use with the Luminus products. Use of these compounds can cause damage to the light output of the device and may permanently damage the device. Please refer to www.luminus.com for a list of the compounds not recommended for use with the Luminus COB products.

Thermal Interface Material (TIM)

Proper thermal management is critical for successful operation of any LED system. Excess operating temperature can reduce the light output of the device. And excessive heating can cause permanent damage to the device. Proper TIM material is a crucial component for effective heat transfer away from the LED during normal operation. Please refer to www.luminus.com for specific recommendations for TIM solutions.



Компания «ЭлектроПласт» предлагает заключение долгосрочных отношений при поставках импортных электронных компонентов на взаимовыгодных условиях!

Наши преимущества:

- Оперативные поставки широкого спектра электронных компонентов отечественного и импортного производства напрямую от производителей и с крупнейших мировых складов;
- Поставка более 17-ти миллионов наименований электронных компонентов;
- Поставка сложных, дефицитных, либо снятых с производства позиций;
- Оперативные сроки поставки под заказ (от 5 рабочих дней);
- Экспресс доставка в любую точку России;
- Техническая поддержка проекта, помощь в подборе аналогов, поставка прототипов;
- Система менеджмента качества сертифицирована по Международному стандарту ISO 9001;
- Лицензия ФСБ на осуществление работ с использованием сведений, составляющих государственную тайну;
- Поставка специализированных компонентов (Xilinx, Altera, Analog Devices, Intersil, Interpoint, Microsemi, Aeroflex, Peregrine, Syfer, Eurofarad, Texas Instrument, Miteq, Cobham, E2V, MA-COM, Hittite, Mini-Circuits, General Dynamics и др.);

Помимо этого, одним из направлений компании «ЭлектроПласт» является направление «Источники питания». Мы предлагаем Вам помощь Конструкторского отдела:

- Подбор оптимального решения, техническое обоснование при выборе компонента;
- Подбор аналогов;
- Консультации по применению компонента;
- Поставка образцов и прототипов;
- Техническая поддержка проекта;
- Защита от снятия компонента с производства.



Как с нами связаться

Телефон: 8 (812) 309 58 32 (многоканальный)

Факс: 8 (812) 320-02-42

Электронная почта: org@eplast1.ru

Адрес: 198099, г. Санкт-Петербург, ул. Калинина, дом 2, корпус 4, литера А.