

DESCRIPTION

The MP1518 is a step-up converter designed for driving up to 6 series white LEDs from a single cell Lithium Ion battery. The MP1518 uses current mode, fixed frequency architecture to regulate the LED current, which is measured through an external current sense resistor. Its low 104mV feedback voltage reduces power loss and improves efficiency. The OV pin monitors the output voltage and turns off the converter if an over-voltage condition is present due to an open circuit condition.

The MP1518 includes under-voltage lockout, current limiting and thermal overload protection preventing damage in the event of an output overload.

The MP1518 is available in small 6-pin TSOT23 or 8-pin QFN (2mm x 2mm) packages.

Also available is the MP1518DJE, which has slightly slower switching slew rate, thus is ideal for applications where low EMI is critical.

EVALUATION BOARD REFERENCES

Board Number	Dimensions
EV0056	1.9"X x 1.8"Y x 0.4"Z
EV1518DG-00A	2.0"X x 1.8"Y x 0.4"Z

FEATURES

- On Board Power MOSFET
- Drives up to 6 Series White LEDs
- Up to 87% Efficiency
- Over 1MHz Fixed Switching Frequency
- Open Load Shutdown
- Low 104mV Feedback Voltage
- Soft-Start/PWM Dimming
- UVLO, Thermal Shutdown
- Internal Current Limit
- Available in TSOT23-6 and QFN8 Packages

APPLICATIONS

- Cell Phones
- Handheld Computers and PDAs
- Digital Still Cameras
- Small LCD Displays

All MPS parts are lead-free and adhere to the RoHS directive. For MPS green status, please visit MPS website under Quality Assurance. "MPS" and "The Future of Analog IC Technology" are Trademarks of Monolithic Power Systems, Inc.

TYPICAL APPLICATION



ORDERING INFORMATION

Part Number	Package	Top Marking
MP1518DJ*	TSOT23-6	A8
MP1518DJE		F6
MP1518DG**	QFN8 (2x2mm)	A8

* For Tape & Reel, add suffix -Z (e.g. MP1518DJ-Z);
 For RoHS, compliant packaging, add suffix -LF (e.g. MP1518DJ-LF-Z).
 ** For Tape & Reel, add suffix -Z (e.g. MP1518DG-Z);
 For RoHS, compliant packaging, add suffix -LF (e.g. MP1518DG-LF-Z).

PACKAGE REFERENCE

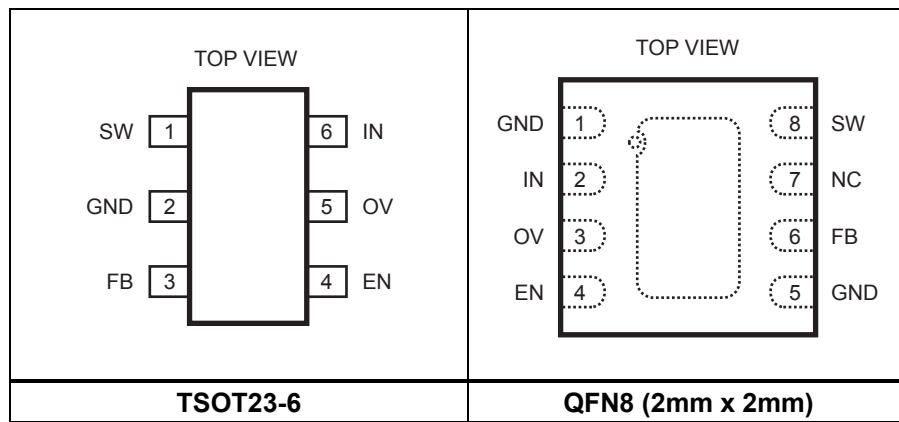

ABSOLUTE MAXIMUM RATINGS ⁽¹⁾

SW, OV Pins -0.5V to +28V
 All Other Pins -0.3V to +6.5V
 Continuous Power Dissipation ($T_A = +25^\circ\text{C}$) ⁽²⁾
 TSOT23-6 0.57W
 QFN8 (2x2mm) 1.6W
 Storage Temperature -55°C to $+150^\circ\text{C}$

Recommended Operating Conditions ⁽³⁾

IN Supply Voltage 2.5V to 6V
 Output Voltage V_{IN} to 25V
 Operating Junction Temp. (T_J) -40°C to $+125^\circ\text{C}$

Thermal Resistance ⁽⁴⁾ θ_{JA} θ_{JC}

TSOT23-6 220 110 .. $^\circ\text{C}/\text{W}$
 QFN8 (2mm x 2mm) 80 16 .. $^\circ\text{C}/\text{W}$

Notes:

- 1) Exceeding these ratings may damage the device.
- 2) The maximum allowable power dissipation is a function of the maximum junction temperature T_J (MAX), the junction-to-ambient thermal resistance θ_{JA} , and the ambient temperature T_A . The maximum allowable continuous power dissipation at any ambient temperature is calculated by P_D (MAX) = $(T_J$ (MAX) - T_A) / θ_{JA} . Exceeding the maximum allowable power dissipation will cause excessive die temperature, and the regulator will go into thermal shutdown. Internal thermal shutdown circuitry protects the device from permanent damage.
- 3) The device is not guaranteed to function outside of its operating conditions.
- 4) Measured on JESD51-7, 4-layer PCB.

ELECTRICAL CHARACTERISTICS

$V_{IN} = V_{EN} = 5V$, $T_A = +25^\circ C$, unless otherwise noted.

Parameters	Symbol	Condition	Min	Typ	Max	Units
Operating Input Voltage	V_{IN}		2.5		6	V
Supply Current (Shutdown)		$V_{EN} = 0V$		0.1	1	μA
Supply Current (Quiescent)		$V_{FB} = 0.15V$		690	750	μA
Switching Frequency	f_{SW}		1.0	1.3	1.5	MHz
Maximum Duty Cycle		$V_{FB} = 0V$	85	92		%
Under Voltage Lockout						
IN Under Voltage Lockout	UVLO	V_{IN} Rising		2.25	2.45	V
Under Voltage Lockout Hysteresis				92		mV
Open Lamp Shutdown Threshold	V_{OV}	V_{OV} Rising		28		V
Enable						
EN Threshold		V_{EN} Rising	1.0	1.35	1.6	V
EN Threshold		V_{EN} Rising, $V_{IN} = 2.5V$	0.8			V
EN Hysteresis				90		mV
EN Input Bias Current		$V_{EN} = 0V, 5V$			1	μA
Feedback						
FB Voltage			94	104	114	mV
FB Input Bias Current		$V_{FB} = 0.1V$	-600	-300		nA
Output Switch						
SW On-Resistance ⁽⁵⁾	R_{ON}			0.5		Ω
SW Current Limit ⁽⁵⁾		Duty Cycle = 60%		350		mA
Thermal Shutdown ⁽⁵⁾				160		$^\circ C$

Notes:

5) Guaranteed by design.

PIN FUNCTIONS

TSOT23-6 Pin #	QFN8 Pin #	Name	Pin Function
1	8	SW	Power Switch Output. SW is the drain of the internal MOSFET switch. Connect the power inductor and output rectifier to SW. SW can swing between GND and 25V.
2	1, 5	GND	Ground.
3	6	FB	Feedback Input. The MP1518 regulates the voltage across the current sense resistor between FB and GND. Connect a current sense resistor from the bottom of the LED string to GND. Connect the bottom of the LED string to FB. The regulation voltage is 104mV.
4	4	EN	Regulator On/Off Control Input. A high input at EN turns on the converter, and a low input turns it off. When not used, connect EN to the input source for automatic startup. The EN pin cannot be left floating.
5	3	OV	Over Voltage Input. OV measures the output voltage for open circuit protection. Connect OV to the output at the top of the LED string.
6	2	IN	Input Supply Pin. Must be locally bypassed.

OPERATION

The MP1518 uses a constant frequency, peak current mode boost regulator architecture to regulate the series string of white LEDs. The operation of the MP1518 can be understood by referring to the block diagram of Figure 1.

At the start of each oscillator cycle the FET is turned on through the control circuitry. To prevent sub-harmonic oscillations at duty cycles greater than 50 percent, a stabilizing ramp is added to the output of the current sense amplifier and the result is fed into the positive input of the PWM comparator. When this voltage equals the output voltage of the error amplifier the power FET is turned off.

The voltage at the output of the error amplifier is an amplified version of the difference between the 104mV reference voltage and the feedback voltage. In this way the peak current level keeps the output in regulation.

If the feedback voltage starts to drop, the output of the error amplifier increases. This results in more current flowing through the power FET, thus increasing the power delivered to the output.



Figure 1—Functional Block Diagram

APPLICATION INFORMATION



Figure 2—Circuit for Driving 3 WLEDs

A typical application circuit can be seen in Figure 2. The 3 white LEDs can be driven from a voltage supply range of 2.5V to 6V at an output current of 20mA. A 0.22µF output capacitor is sufficient for most applications but an output capacitor up to 1µF may be used. A 22µH inductor with low DCR (Inductor resistance) is recommended to improve efficiency. A 1µF ceramic capacitor is recommended for the input capacitance in the real system. Schottky diodes have fast recovery and a low forward voltage and are recommended. Schottky diodes rated with 100mA to 200mA are sufficient for the MP1518. The switching characteristics during normal operation can be seen in Figure 3. The MP1518 has internal soft-start to limit the amount of current through VIN at startup and to also limit the amount of overshoot on the output. The current limit is increased by a fourth every 40µs giving a total soft-start time of 120µs.

Steady State Operation

V_{IN} = 3.6V, 3 LEDs, 20mA

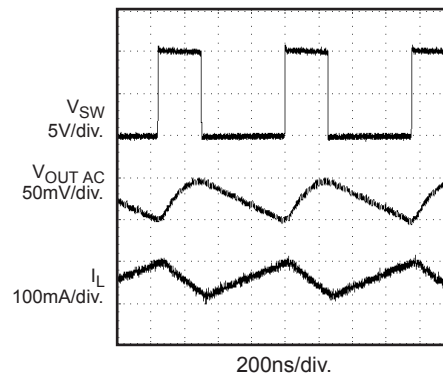

Figure 3—Steady State Operation

Figure 4 shows the startup behavior of the MP1518. The ramped voltage that is added to the current sense amplifier reduces the current output as the duty cycle increases. As more LEDs are added, the output voltage rises but the current that can be delivered to the load is reduced as well.



Figure 4—Startup Waveforms

Figure 5 shows the dependence on current limit versus duty cycle.

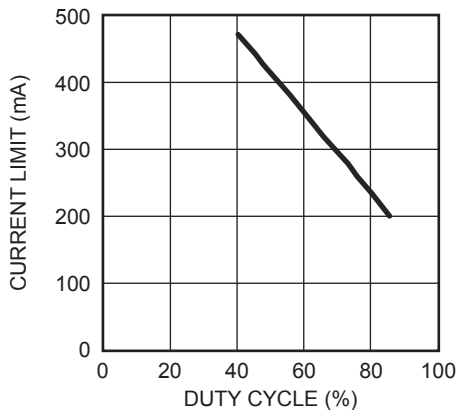

Figure 5—Current Limit vs. Duty Cycle

Setting the LED Current

The LED current is controlled by the feedback resistor, R1, in Figure 6. The current through the LEDs is given by the equation $104mV/R1$. Table 2 shows the selection of resistors for a given LED current.

Table 2— I_{LED} vs. R1

I_{LED} (mA)	R1 (Ω)
1	104
5	20.8
10	10.4
15	6.93
20	5.2

Analog and Digital Dimming

There are three different ways to control dimming for the MP1518 during normal operation. The first way uses a DC voltage to control the feedback voltage. This can be seen in Figure 6. As the DC voltage increases, current starts flowing down R1, R2 and R3. The loop will continue to regulate the feedback voltage to 104mV. Thus the current has to decrease through the LEDs by the same amount of current as is being injected from the DC voltage source. With a V_{DC} from 0V to 2V, the resistor values shown for R2 and R3 can control the LED current from 0mA to 20mA.



Figure 6—Dimming Control Using a DC Voltage

Other applications need to use a logic signal to do the dimming. This can be seen in Figure 7. The PWM signal is applied to the EN pin of the MP1518. The LEDs will switch between full load to completely shut off. The average current through the LEDs will increase proportionally to the duty cycle of the PWM signal. The PWM signal used in Figure 7 should be 1KHz or below due to the soft-start function.



Figure 7—PWM Dimming Control Using a Logic Signal

If the PWM signal is above 1kHz, dimming can be achieved by using the circuit shown in Figure 8.



Figure 8— Dimming Control Using a Filtered PWM Signal

Open Load Protection

Open Load protection will shut off the MP1518 if the output voltage goes too high when the OV pin is tied to the output. In some cases an LED may fail, this will result in the feedback voltage always being zero.

The part will run at maximum duty cycle boosting the output voltage higher and higher. By tying the OV pin to the top of the LED string the MP1518 checks this condition and if the output ever exceeds 28V the MP1518 will shut down. The part will not switch again until the power is recycled. Figure 9 shows the behavior of the MP1518 into an open load.

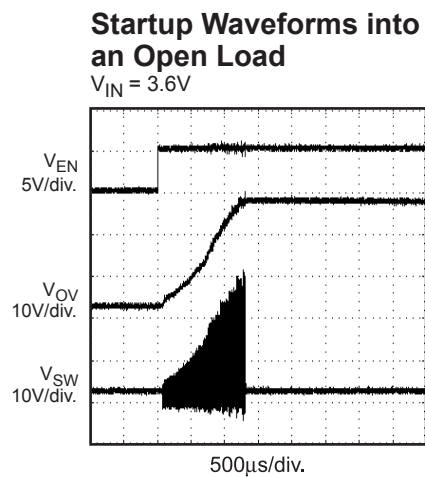

Figure 9—Startup Waveforms into an Open Load

Layout Considerations

Careful attention must be paid to the PCB board layout and component placement. Proper layout of the high frequency switching path is critical to prevent noise and electromagnetic interference problems. Due to the high frequency switching the length and area of all the traces connected to the switch node should be minimized. Refer to the evaluation board EV0056 for a sample layout of the MP1518.

PACKAGE INFORMATION

TSOT23-6



TOP VIEW



RECOMMENDED LAND PATTERN

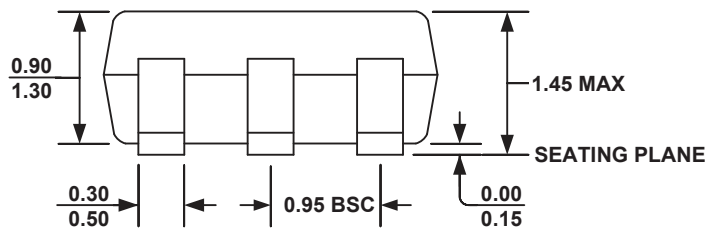

FRONT VIEW



SIDE VIEW

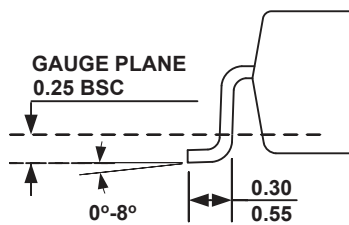

DETAIL A

NOTE:

- 1) ALL DIMENSIONS ARE IN MILLIMETERS.
- 2) PACKAGE LENGTH DOES NOT INCLUDE MOLD FLASH, PROTRUSION OR GATE BURR.
- 3) PACKAGE WIDTH DOES NOT INCLUDE INTERLEAD FLASH OR PROTRUSION.
- 4) LEAD COPLANARITY (BOTTOM OF LEADS AFTER FORMING) SHALL BE 0.10 MILLIMETERS MAX.
- 5) DRAWING CONFORMS TO JEDEC MO-193, VARIATION AB.
- 6) DRAWING IS NOT TO SCALE.
- 7) PIN 1 IS LOWER LEFT PIN WHEN READING TOP MARK FROM LEFT TO RIGHT, (SEE EXAMPLE TOP MARK)

PACKAGE INFORMATION

QFN8 (2mm x 2mm)



TOP VIEW



BOTTOM VIEW



SIDE VIEW

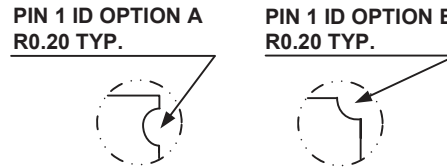

DETAIL A



RECOMMENDED LAND PATTERN

NOTE:

- 1) ALL DIMENSIONS ARE IN MILLIMETERS.
- 2) EXPOSED PADDLE SIZE DOES NOT INCLUDE MOLD FLASH.
- 3) LEAD COPLANARITY SHALL BE 0.10 MILLIMETER MAX.
- 4) DRAWING CONFORMS TO JEDEC MO-229, VARIATION VCCD-3.
- 5) DRAWING IS NOT TO SCALE.

NOTICE: The information in this document is subject to change without notice. Users should warrant and guarantee that third party Intellectual Property rights are not infringed upon when integrating MPS products into any application. MPS will not assume any legal responsibility for any said applications.



Компания «ЭлектроПласт» предлагает заключение долгосрочных отношений при поставках импортных электронных компонентов на взаимовыгодных условиях!

Наши преимущества:

- Оперативные поставки широкого спектра электронных компонентов отечественного и импортного производства напрямую от производителей и с крупнейших мировых складов;
- Поставка более 17-ти миллионов наименований электронных компонентов;
- Поставка сложных, дефицитных, либо снятых с производства позиций;
- Оперативные сроки поставки под заказ (от 5 рабочих дней);
- Экспресс доставка в любую точку России;
- Техническая поддержка проекта, помощь в подборе аналогов, поставка прототипов;
- Система менеджмента качества сертифицирована по Международному стандарту ISO 9001;
- Лицензия ФСБ на осуществление работ с использованием сведений, составляющих государственную тайну;
- Поставка специализированных компонентов (Xilinx, Altera, Analog Devices, Intersil, Interpoint, Microsemi, Aeroflex, Peregrine, Syfer, Eurofarad, Texas Instrument, Miteq, Cobham, E2V, MA-COM, Hittite, Mini-Circuits, General Dynamics и др.);

Помимо этого, одним из направлений компании «ЭлектроПласт» является направление «Источники питания». Мы предлагаем Вам помощь Конструкторского отдела:

- Подбор оптимального решения, техническое обоснование при выборе компонента;
- Подбор аналогов;
- Консультации по применению компонента;
- Поставка образцов и прототипов;
- Техническая поддержка проекта;
- Защита от снятия компонента с производства.



Как с нами связаться

Телефон: 8 (812) 309 58 32 (многоканальный)

Факс: 8 (812) 320-02-42

Электронная почта: org@eplast1.ru

Адрес: 198099, г. Санкт-Петербург, ул. Калинина, дом 2, корпус 4, литера А.