

Distinctive Characteristics

Unique, off-center actuator allows high density setup and easy actuation while avoiding accidental operation in compact environments.

Side-by-side, block mounting can be achieved by use of bracket AT546 on straight PC mounting types.

Off-Momentary On Circuit.

Black, white, and red snap-on caps available.

Extremely thin size allows high density PCB mounting and makes these switches ideal for handheld equipment.

Award-winning STC contact mechanism with benefits unavailable in conventional mechanisms: smoother, positive detent actuation, increased contact stability and unparalleled logic-level reliability. (Additional STC details in Terms & Acronyms; see Supplement section.)

Molded-in, epoxy sealed terminals lock out flux and other contaminants.

.100" x .100" (2.54mm x 2.54mm) terminal spacing conforms to standard PC board grid spacing for straight and angle mounting.

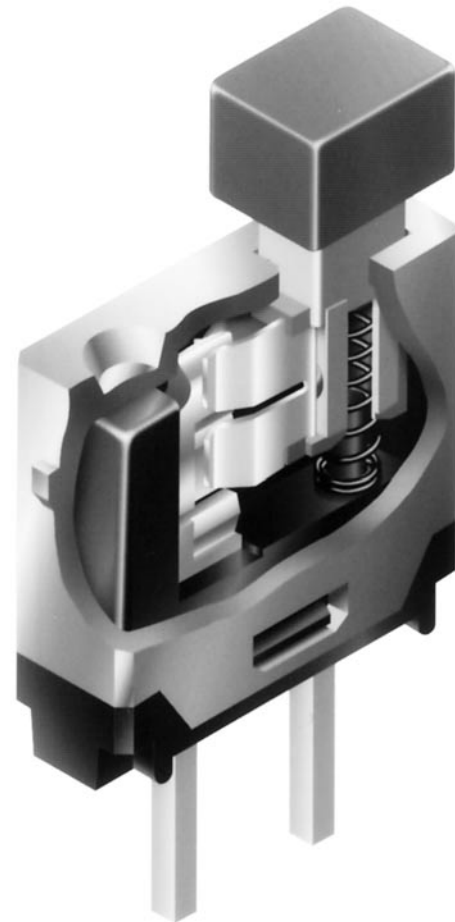

Actual Size

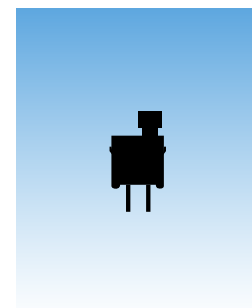

General Specifications

Electrical Capacity (Resistive Load)

Logic Level: 0.4VA maximum @ 28V AC/DC maximum
 (Applicable Range 0.1mA ~ 0.1A @ 20mV ~ 28V)
 Note: Find additional explanation of operating range in Supplement section.

Other Ratings

Contact Resistance: 80 milliohms maximum
Insulation Resistance: 500 megohms minimum @ 500V DC
Dielectric Strength: 500V AC minimum for 1 minute minimum
Mechanical Life: 50,000 operations minimum
Electrical Life: 50,000 operations minimum
Nominal Operating Force: 1.0N
Travel: Pretravel .020" (0.5mm); Overtravel .023 (0.6mm); Total Travel .043" (1.1mm)

Materials & Finishes

Actuator: Glass fiber reinforced polyamide (UL94V-0)
Case: Glass fiber reinforced polyamide (UL94V-0)
Movable Contacts: Phosphor bronze with gold plating
Stationary Contacts: Brass with gold plating
Base: Glass fiber reinforced polyamide (UL94V-0)
Mounting Bracket: Phosphor bronze with tin plating
Terminals: Brass with gold plating

Environmental Data

Operating Temperature Range: -25°C through +70°C (-13°F through +158°F)
Humidity: 90 ~ 95% humidity for 240 hours @ 40°C (104°F)
Vibration: 10 ~ 55Hz with peak-to-peak amplitude of 1.5mm traversing the frequency range & returning in 1 minute; 3 right angled directions for 2 hours
Shock: 50G (490m/s²) acceleration (tested in 6 right angled directions, with 5 shocks in each direction)

PCB Processing

Soldering: Wave Soldering recommended. See Profile B in Supplement section.
 Manual Soldering: 4 seconds maximum @ 390°C maximum.
Cleaning: These devices are not process sealed. Hand clean locally using alcohol based solution. See Cleaning Specifications in Supplement section.

Standards & Certifications

Flammability Standards: UL94V-0 actuator, case, & base
UL Recognition or CSA Certification: The GB2 Series pushbuttons have not been tested for UL recognition or CSA certification. These switches are designed for use in a low-voltage, low-current, logic-level circuit. When used as intended in a logic-level circuit, the results do not produce hazardous energy.

TYPICAL SWITCH ORDERING EXAMPLE

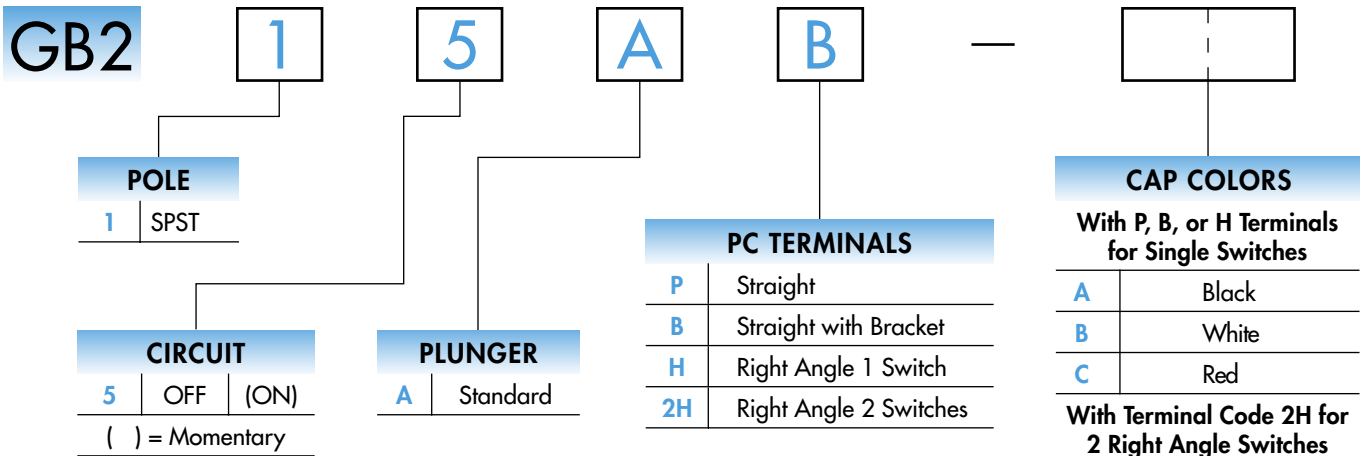

DESCRIPTION FOR TYPICAL ORDERING EXAMPLE

GB215AB



POLE & CIRCUIT

Pole	Model	Plunger Position () = Momentary		Connected Terminals		Throw & Schematics
		Normal	Down	Normal	Down	
SP	GB215	OFF	(ON)	OPEN	1-2 1-2 3-4	<p>Note: Terminal numbers are not actually on the switch.</p>

TYPICAL SWITCH DIMENSIONS

Straight PC



GB215AP

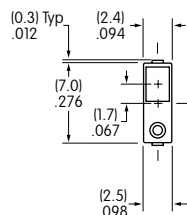

Single Pole

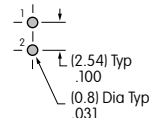
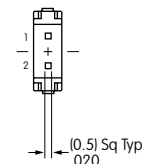
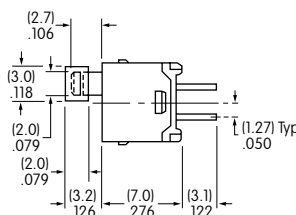

TYPICAL SWITCH DIMENSIONS

Straight PC with Bracket

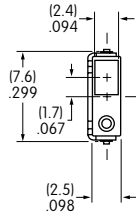

Single Pole

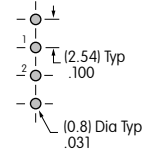
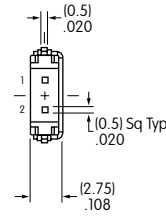
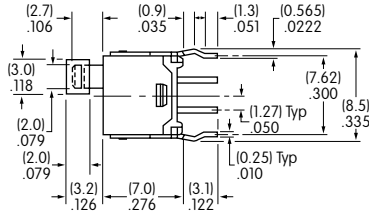

GB215AB

Right Angle PC

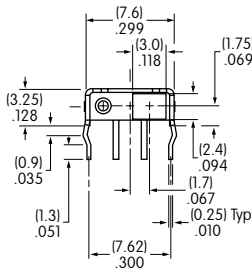

Single Pole with 1 Switch

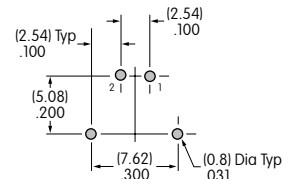
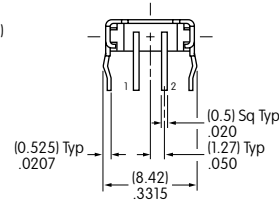
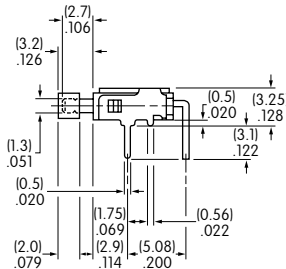

GB215AH

Right Angle PC

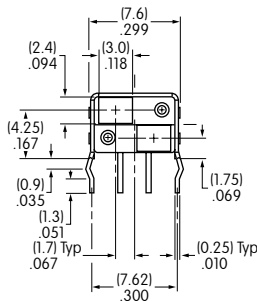

Single Pole with 2 Switches

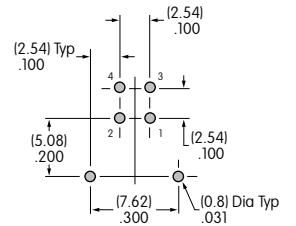
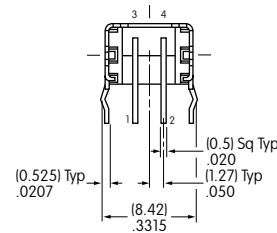
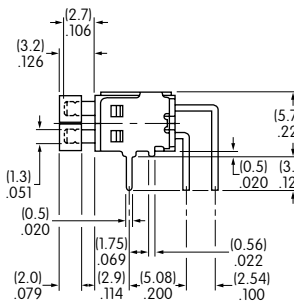

GB215A2H

SNAP-ON CAP & MOUNTING BRACKET

A AT4137 Rectangular Snap-on Cap
Black

B AT4137 Rectangular Snap-on Cap
White

C AT4137 Rectangular Snap-on Cap
Red

Material: PBT
Finish: Glossy



Actual Size

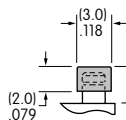

AT546
Mounting Bracket
for Block Mounting

Material:
Phosphor Bronze
with Tin Plating

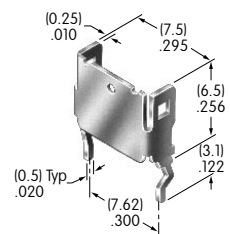



Компания «ЭлектроПласт» предлагает заключение долгосрочных отношений при поставках импортных электронных компонентов на взаимовыгодных условиях!

Наши преимущества:

- Оперативные поставки широкого спектра электронных компонентов отечественного и импортного производства напрямую от производителей и с крупнейших мировых складов;
- Поставка более 17-ти миллионов наименований электронных компонентов;
- Поставка сложных, дефицитных, либо снятых с производства позиций;
- Оперативные сроки поставки под заказ (от 5 рабочих дней);
- Экспресс доставка в любую точку России;
- Техническая поддержка проекта, помощь в подборе аналогов, поставка прототипов;
- Система менеджмента качества сертифицирована по Международному стандарту ISO 9001;
- Лицензия ФСБ на осуществление работ с использованием сведений, составляющих государственную тайну;
- Поставка специализированных компонентов (Xilinx, Altera, Analog Devices, Intersil, Interpoint, Microsemi, Aeroflex, Peregrine, Syfer, Eurofarad, Texas Instrument, Miteq, Cobham, E2V, MA-COM, Hittite, Mini-Circuits, General Dynamics и др.);

Помимо этого, одним из направлений компании «ЭлектроПласт» является направление «Источники питания». Мы предлагаем Вам помощь Конструкторского отдела:

- Подбор оптимального решения, техническое обоснование при выборе компонента;
- Подбор аналогов;
- Консультации по применению компонента;
- Поставка образцов и прототипов;
- Техническая поддержка проекта;
- Защита от снятия компонента с производства.



Как с нами связаться

Телефон: 8 (812) 309 58 32 (многоканальный)

Факс: 8 (812) 320-02-42

Электронная почта: org@eplast1.ru

Адрес: 198099, г. Санкт-Петербург, ул. Калинина, дом 2, корпус 4, литера А.