

# Cree® XLamp® ML-E LEDs



## PRODUCT DESCRIPTION

The Cree XLamp ML-E LED brings lighting-class reliability and performance to ½-watt LEDs. The XLamp ML-E expands Cree’s lighting-class leadership to LED bulbs and linear and distributed lighting applications. With XLamp lighting-class reliability, a wide viewing angle, uniform light output, and industry-leading chromaticity binning in a 3.5-mm X 3.5-mm package, the XLamp ML-E LED continues Cree’s history of segment-focused product innovation in LEDs for lighting applications.

The XLamp ML-E LED brings high performance and a smooth look to a wide range of lighting applications, including linear lighting, LED light bulbs, fluorescent retrofits and retail-display lighting.

## FEATURES

- Available in white (2600 K to 8300 K CCT), 80-, 85- and 90-CRI minimum
- Available in royal blue, blue, green, amber and red
- Available in parallel and series Vf configurations for white
- ANSI-compatible sub-bins
- Maximum drive current: 500 mA for parallel white, 167 mA for series white, 350 mA for blue, green and red, 250 mA for amber
- 120° viewing angle for white, 125° viewing angle for color
- Uniform chromaticity profile
- Electrically neutral thermal path
- RoHS- and REACH-compliant
- UL-recognized component (E349212)

## TABLE OF CONTENTS

Characteristics .....	2
Flux Characteristics.....	3
Relative Spectral Power Distribution.....	6
Relative Luminous Flux vs. Junction Temperature .....	7
Relative Radiant Flux vs. Junction Temperature .....	8
Electrical Characteristics .....	8
Relative Luminous Flux vs. Current .....	10
Relative Radiant Flux vs. Current ..	11
Thermal Design .....	12
Typical Spatial Distribution.....	15
Reflow Soldering Characteristics ...	17
Notes.....	18
Mechanical Dimensions.....	20
Tape and Reel .....	21
Packaging.....	22



**CHARACTERISTICS (T<sub>j</sub> = 25 °C)**

Characteristics	Unit	Minimum	Typical	Maximum
Thermal resistance, junction to solder point - white, royal blue, blue	°C/W		11	
Thermal resistance, junction to solder point - green, red	°C/W		15	
Thermal resistance, junction to solder point - amber	°C/W		24	
Viewing angle (FWHM) - white	degrees		120	
Viewing angle (FWHM) - royal blue, blue, green, amber, red	degrees		125	
Temperature coefficient of voltage - parallel - white	mV/°C		-3.3	
Temperature coefficient of voltage - series - white	mV/°C		-10	
Temperature coefficient of voltage - royal blue, blue	mV/°C		-3.3	
Temperature coefficient of voltage - green	mV/°C		-4	
Temperature coefficient of voltage - red	mV/°C		-1.8	
Temperature coefficient of voltage - amber	mV/°C		-1	
ESD classification (HBM per Mil-Std-883D)			Class 2	
DC forward current - parallel - white	mA			500
DC forward current - series - white	mA			167
DC forward current - royal blue, blue, green, red	mA			350
DC forward current - amber	mA			250
Reverse voltage	V			-5
Forward voltage (@ 150 mA) - parallel - white	V		3.2	3.4
Forward voltage (@ 50 mA) - series - white	V		9.6	10.2
Forward voltage (@ 150 mA) - royal blue, blue	V		3.2	
Forward voltage (@ 150 mA) - green	V		3.45	
Forward voltage (@ 150 mA) - red	V		2.2	
Forward voltage (@ 150 mA) - amber	V		2.4	
LED junction temperature	°C			150

**FLUX CHARACTERISTICS - ML-E PARALLEL WHITE ( $T_j = 25\text{ }^\circ\text{C}$ )**

The following table provides several base order codes for XLamp ML-E LEDs. It is important to note that the base order codes listed here are a subset of the total available order codes for the product family. For more order codes, as well as a complete description of the order-code nomenclature, please consult the XLamp ML-E LED Binning and Labeling document.

Color	CCT Range		Base Order Codes Minimum Luminous Flux (lm) @ 150 mA		Calculated Minimum Luminous Flux (lm)*		Order Code
	Min.	Max.	Group	Flux (lm)	350 mA	500 mA	
Cool White	5000 K	8300 K	N2	51.7	104.8	132.9	MLEAWT-A1-0000-000451
			M3	45.7	92.6	117.4	MLEAWT-A1-0000-000351
80-CRI Cool White	6000 K	7000 K	M3	45.7	92.6	117.4	MLEAWT-H1-0000-0003E1
	4750 K	5250 K	M3	45.7	92.6	117.4	MLEAWT-H1-0000-0003E3
Warm White	3700 K	4300 K	M3	45.7	92.6	117.4	MLEAWT-A1-0000-0003E5
			M2	39.8	80.7	102.3	MLEAWT-A1-0000-0002E5
	2800 K	3200 K	M2	39.8	80.7	102.3	MLEAWT-A1-0000-0002E7
			K3	35.2	71.4	90.5	MLEAWT-A1-0000-0001E7
80-CRI Warm White	3700 K	4300 K	M2	39.8	80.7	102.3	MLEAWT-H1-0000-0002E5
	2800 K	3200 K	K3	35.2	71.4	90.5	MLEAWT-H1-0000-0001E7
85-CRI Warm White	2800 K	3200 K	K3	35.2	71.4	90.5	MLEAWT-P1-0000-0001E7
90-CRI Warm White	2800 K	3200 K	K2	30.6	62	78.6	MLEAWT-U1-0000-0000E7

**Notes:**

- Cree maintains a tolerance of  $\pm 7\%$  on flux and power measurements,  $\pm 0.005$  on chromaticity (CCx, CCy) measurements and  $\pm 2$  on CRI measurements.
- Typical CRI for Cool White (4300 K – 8300 K CCT) is 75.
- Typical CRI for Warm White (2600 K – 4300 K CCT) is 80.
- Minimum CRI for 80-CRI White is 80.
- Minimum CRI for 85-CRI White is 85.
- Minimum CRI for 90-CRI White is 90
- \* Calculated flux values are for reference only.

## FLUX CHARACTERISTICS - ML-E SERIES WHITE ( $T_j = 25\text{ }^\circ\text{C}$ )

The following table provides several base order codes for XLamp ML-E LEDs. It is important to note that the base order codes listed here are a subset of the total available order codes for the product family. For more order codes, as well as a complete description of the order-code nomenclature, please consult the XLamp ML-E LED Binning and Labeling document.

Color	CCT Range		Base Order Codes Minimum Luminous Flux (lm) @ 50 mA		Calculated Minimum Luminous Flux (lm)*		Order Code
	Min.	Max.	Group	Flux (lm)	117 mA	166 mA	
Cool White	5000 K	8300 K	N2	51.7	104.8	132.9	MLESWT-A1-0000-000451
			M3	45.7	92.6	117.4	MLESWT-A1-0000-000351
80-CRI Cool White	6000 K	7000 K	M3	45.7	92.6	117.4	MLESWT-H1-0000-0003E1
	4750 K	5250 K	M3	45.7	92.6	117.4	MLESWT-H1-0000-0003E3
Warm White	3700 K	4300 K	M3	45.7	92.6	117.4	MLESWT-A1-0000-0003E5
			M2	39.8	80.7	102.3	MLESWT-A1-0000-0002E5
	2800 K	3200 K	M2	39.8	80.7	102.3	MLESWT-A1-0000-0002E7
			K3	35.2	71.4	90.5	MLESWT-A1-0000-0001E7
80-CRI Warm White	3700 K	4300 K	M2	39.8	80.7	102.3	MLESWT-H1-0000-0002E5
	2800 K	3200 K	K3	35.2	71.4	90.5	MLESWT-H1-0000-0001E7
85-CRI Warm White	2800 K	3200 K	K3	35.2	71.4	90.5	MLESWT-P1-0000-0001E7
90-CRI Warm White	2800 K	3200 K	K2	30.6	62	78.6	MLESWT-U1-0000-0000E7

### Notes:

- Cree maintains a tolerance of  $\pm 7\%$  on flux and power measurements,  $\pm 0.005$  on chromaticity (CCx, CCy) measurements and  $\pm 2$  on CRI measurements.
- Typical CRI for Cool White (4300 K – 8300 K CCT) is 75.
- Typical CRI for Warm White (2600 K – 4300 K CCT) is 80.
- Minimum CRI for 80-CRI White is 80.
- Minimum CRI for 85-CRI White is 85.
- Minimum CRI for 90-CRI White is 90.
- \* Calculated flux values are for reference only.

**FLUX CHARACTERISTICS - COLOR ( $T_j = 25\text{ }^\circ\text{C}$ )**

The following table provides several base order codes for XLamp ML-E color LEDs. It is important to note that the base order codes listed here are a subset of the total available order codes for the product family. For more order codes, as well as a complete description of the order-code nomenclature, please consult the XLamp ML Family Binning and Labeling document.

Color	Dominant Wavelength Range				Base Order Codes Minimum Radiant Flux (mW) @ 150 mA		Order Code
	Min.		Max.		Group	Flux (mW)	
	Group	DWL (nm)	Group	DWL (nm)			
Royal Blue	D3	450	D5	465	10	175	MLEROY-A1-0000-000501

Color	Dominant Wavelength Range				Base Order Codes Minimum Luminous Flux (lm) @ 150 mA		Order Code
	Min.		Max.		Group	Flux (lm)	
	Group	DWL (nm)	Group	DWL (nm)			
Blue	B3	465	B6	485	G0	13.9	MLEBLU-A1-0000-000U01
					F0	10.7	MLEBLU-A1-0000-000T01

Color	Dominant Wavelength Range				Base Order Codes Minimum Luminous Flux (lm) @ 150 mA		Order Code
	Min.		Max.		Group	Flux (lm)	
	Group	DWL (nm)	Group	DWL (nm)			
Green	G2	520	G4	535	K3	35.2	MLEGRN-A1-0000-000101
					K2	30.6	MLEGRN-A1-0000-000001
					J3	26.8	MLEGRN-A1-0000-000X01

Color	Dominant Wavelength Range				Base Order Codes Minimum Luminous Flux (lm) @ 150 mA		Order Code
	Min.		Max.		Group	Flux (lm)	
	Group	DWL (nm)	Group	DWL (nm)			
Amber	A2	585	A3	595	K2	30.6	MLEAMB-A1-0000-000001
					J3	26.8	MLEAMB-A1-0000-000X01

Color	Dominant Wavelength Range				Base Order Codes Minimum Luminous Flux (lm) @ 150 mA		Order Code
	Min.		Max.		Group	Flux (lm)	
	Group	DWL (nm)	Group	DWL (nm)			
Red	R2	620	R3	630	J2	23.5	MLERED-A1-0000-000W01
					H0	18.1	MLERED-A1-0000-000V01

- Note:
- Cree maintains a tolerance of  $\pm 7\%$  on flux and power measurements,  $\pm 0.005$  on chromaticity (CCx, CCy) measurements,  $\pm 2$  on CRI measurements and  $\pm 1$  nm on dominant wavelength measurements.

**RELATIVE SPECTRAL POWER DISTRIBUTION - WHITE**



**RELATIVE SPECTRAL POWER DISTRIBUTION - COLOR**



**RELATIVE LUMINOUS FLUX VS. JUNCTION TEMPERATURE - WHITE (ML-E PARALLEL:  
I<sub>F</sub> = 150 mA, ML-E SERIES: I<sub>F</sub> = 50 mA)**



**RELATIVE LUMINOUS FLUX VS. JUNCTION TEMPERATURE - BLUE, GREEN, AMBER, RED  
(I<sub>F</sub> = 350 mA)**

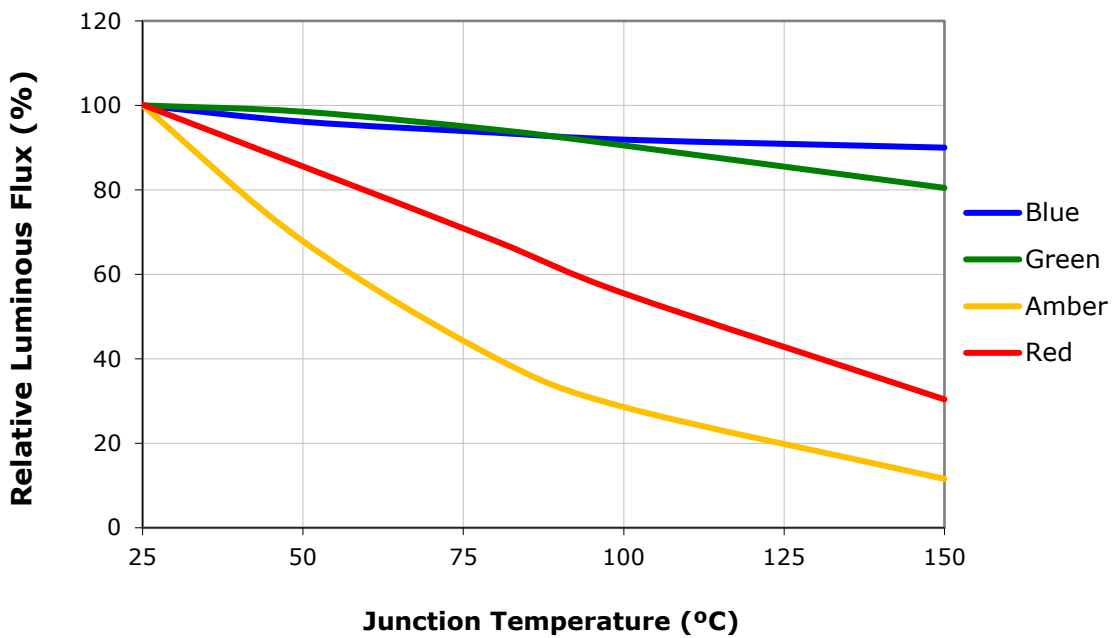

**RELATIVE RADIANT FLUX VS. JUNCTION TEMPERATURE - ROYAL BLUE ( $I_f = 350 \text{ mA}$ )**



**ELECTRICAL CHARACTERISTICS - ML-E PARALLEL WHITE ( $T_j = 25 \text{ °C}$ )**





**ELECTRICAL CHARACTERISTICS - ML-E SERIES WHITE ( $T_j = 25\text{ }^\circ\text{C}$ )**



**ELECTRICAL CHARACTERISTICS - COLOR ( $T_j = 25\text{ }^\circ\text{C}$ )**



**RELATIVE LUMINOUS FLUX VS. CURRENT - ML-E PARALLEL WHITE ( $T_j = 25\text{ }^\circ\text{C}$ )**



**RELATIVE LUMINOUS FLUX VS. CURRENT - ML-E SERIES WHITE ( $T_j = 25\text{ }^\circ\text{C}$ )**



**RELATIVE LUMINOUS FLUX VS. CURRENT - BLUE, GREEN, AMBER, RED ( $T_j = 25\text{ }^\circ\text{C}$ )**



**RELATIVE RADIANT FLUX VS. CURRENT - ROYAL BLUE ( $T_j = 25\text{ }^\circ\text{C}$ )**



**THERMAL DESIGN - ML-E PARALLEL WHITE**

The maximum forward current is determined by the thermal resistance between the LED junction and ambient. It is crucial for the end product to be designed in a manner that minimizes the thermal resistance from the solder point to ambient in order to optimize lamp life and optical characteristics.



**THERMAL DESIGN - ML-E SERIES WHITE**



**THERMAL DESIGN - ROYAL BLUE, BLUE**



**THERMAL DESIGN - GREEN**

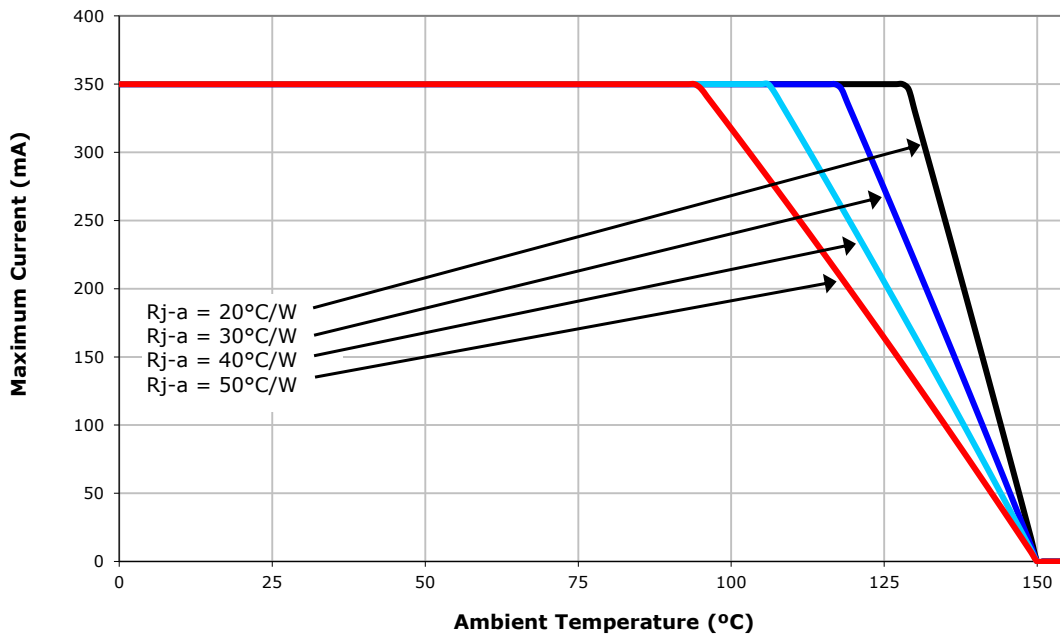

**THERMAL DESIGN - AMBER**



**THERMAL DESIGN - RED**



**TYPICAL SPATIAL DISTRIBUTION - WHITE**

---

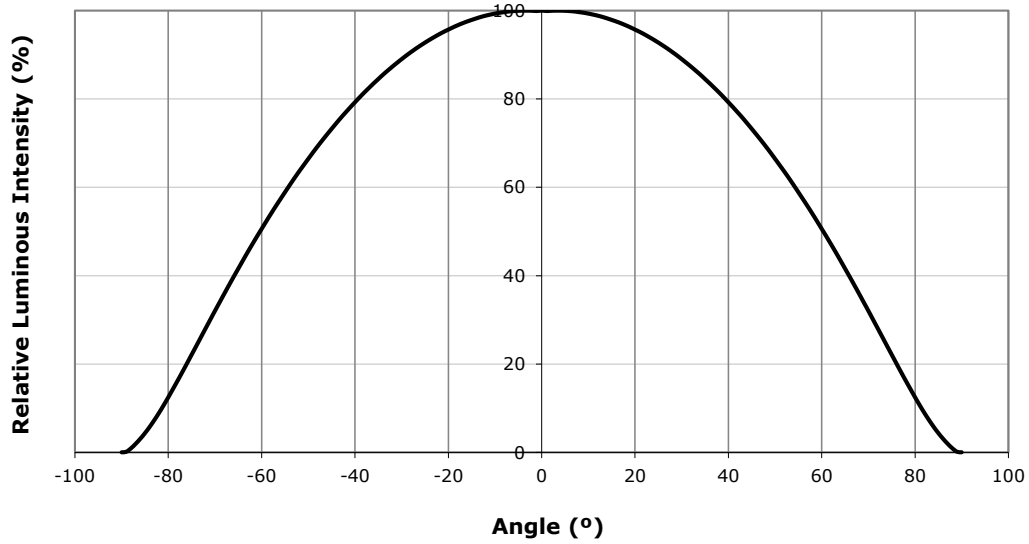

**TYPICAL SPATIAL DISTRIBUTION - ROYAL BLUE, BLUE, GREEN**

---



**TYPICAL SPATIAL DISTRIBUTION - AMBER, RED**

---





## REFLOW SOLDERING CHARACTERISTICS

In testing, Cree has found XLamp ML-E LEDs to be compatible with JEDEC J-STD-020C, using the parameters listed below. As a general guideline, Cree recommends that users follow the recommended soldering profile provided by the manufacturer of the solder paste used.

Note that this general guideline may not apply to all PCB designs and configurations of reflow soldering equipment.



IPC/JEDEC J-STD-020C

Profile Feature	Lead-Based Solder	Lead-Free Solder
Average Ramp-Up Rate (Ts <sub>max</sub> to Tp)	3 °C/second max.	3 °C/second max.
Preheat: Temperature Min (Ts <sub>min</sub> )	100 °C	150 °C
Preheat: Temperature Max (Ts <sub>max</sub> )	150 °C	200 °C
Preheat: Time (ts <sub>min</sub> to ts <sub>max</sub> )	60-120 seconds	60-180 seconds
Time Maintained Above: Temperature (T <sub>l</sub> )	183 °C	217 °C
Time Maintained Above: Time (t <sub>l</sub> )	60-150 seconds	60-150 seconds
Peak/Classification Temperature (Tp)	215 °C	260 °C
Time Within 5 °C of Actual Peak Temperature (tp)	10-30 seconds	20-40 seconds
Ramp-Down Rate	6 °C/second max.	6 °C/second max.
Time 25 °C to Peak Temperature	6 minutes max.	8 minutes max.

Note: All temperatures refer to topside of the package, measured on the package body surface.

Note: While the high reflow temperatures (above) have been approved, Cree’s best practice guideline for reflow is to use as low a temperature as possible during the reflow soldering process for these LEDs.

**NOTES**

**Lumen Maintenance Projections**

Cree now uses standardized IES LM-80-08 and TM-21-11 methods for collecting long-term data and extrapolating LED lumen maintenance. For information on the specific LM-80 data sets available for this LED, refer to the public LM-80 results document at [www.cree.com/xlamp\\_app\\_notes/LM80\\_results](http://www.cree.com/xlamp_app_notes/LM80_results).

Please read the XLamp Long-Term Lumen Maintenance application note at [www.cree.com/xlamp\\_app\\_notes/lumen\\_maintenance](http://www.cree.com/xlamp_app_notes/lumen_maintenance) for more details on Cree’s lumen maintenance testing and forecasting. Please read the XLamp Thermal Management application note at [www.cree.com/xlamp\\_app\\_notes/thermal\\_management](http://www.cree.com/xlamp_app_notes/thermal_management) for details on how thermal design, ambient temperature, and drive current affect the LED junction temperature.

**Moisture Sensitivity**

XLamp ML-E LEDs are shipped in sealed, moisture-barrier bags (MBB) designed for long shelf life. If XLamp ML-E LEDs are exposed to moist environments after opening the MBB packaging but before soldering, damage to the LED may occur during the soldering operation. The derating table at right defines the maximum exposure time (in days) for an XLamp ML-E LED in the listed humidity and temperature conditions.

Temp.	Maximum Percent Relative Humidity						
	30%	40%	50%	60%	70%	80%	90%
35 °C	-	-	-	17	1	.5	.5
30 °C	-	-	-	28	1	1	1
25 °C	-	-	-	-	2	1	1
20 °C	-	-	-	-	2	1	1

LEDs with exposure time longer than the time specified below must be baked according to the baking conditions listed below.

Cree recommends keeping XLamp LEDs in their sealed moisture-barrier packaging until immediately prior to use. Cree also recommends returning any unused LEDs to the resealable moisture-barrier bag and closing the bag immediately after use.

**Baking Conditions**

It is not necessary to bake all XLamp ML-E LEDs. Only the LEDs that meet all of the following criteria must be baked:

1. LEDs that have been removed from the original MBB packaging.
2. LEDs that have been exposed to a humid environment longer than listed in the Moisture Sensitivity section above.
3. LEDs that have not been soldered.

LEDs should be baked at 70 °C for 24 hours. LEDs may be baked on the original reels. Remove LEDs from MBB packaging before baking. Do not bake parts at temperatures higher than 70 °C. This baking operation resets the exposure time as defined in the Moisture Sensitivity section above.

## Storage Conditions

XLamp ML-E LEDs that have been removed from the original MBB packaging but not soldered should be stored in one of the following ways:

- Store the parts in a rigid metal container with a tight-fitting lid. Verify that the storage temperature is  $<30\text{ }^{\circ}\text{C}$ , and place fresh desiccant and an RH indicator in the container to verify that the RH is no greater than 60%.
- Store the parts in a dry, nitrogen-purged cabinet or container that actively maintains the temperature at  $<30^{\circ}$  and the RH at no greater than 60%.
- For short-term store only: LEDs can be resealed in the original MBB bag soon after opening. Fresh desiccant may be needed. Use the included humidity indicator card to verify  $<60\%$  RH.

If an environment of  $<60\%$  RH is not available for storage, XLamp ML-E LEDs should be baked (described above) before reflow soldering.

## RoHS Compliance

The levels of RoHS restricted materials in this product are below the maximum concentration values (also referred to as the threshold limits) permitted for such substances, or are used in an exempted application, in accordance with EU Directive 2011/65/EC (RoHS2), as amended through June 8, 2011. RoHS Declarations for this product can be obtained from your Cree representative or obtained from the Product Ecology section of [www.cree.com](http://www.cree.com).

## REACH Compliance

REACH substances of high concern (SVHCs) information is available for this product. Since the European Chemical Agency (ECHA) has published notices of their intent to frequently revise the SVHC listing for the foreseeable future, please contact a Cree representative to insure you get the most up-to-date REACH Declaration. Historical REACH banned substance information (substances restricted or banned in the EU prior to 2010) is also available upon request.

## UL Recognized Component

Level 4 enclosure consideration. The LED package or a portion thereof has been investigated as a fire and electrical enclosure per ANSI/UL 8750.

## Vision Advisory Claim

**WARNING:** Do not look at an exposed lamp in operation. Eye injury can result. See LED Eye Safety at [www.cree.com/xlamp\\_app\\_notes/led\\_eye\\_safety](http://www.cree.com/xlamp_app_notes/led_eye_safety).

**MECHANICAL DIMENSIONS (T<sub>A</sub> = 25 °C)**

All measurements are ±.13 mm unless otherwise indicated.

**Top View**



**Bottom View**



**Side View**

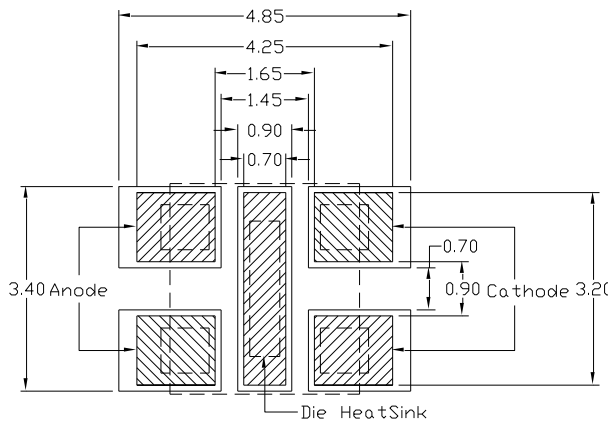

**Recommended PCB Solder Pad**

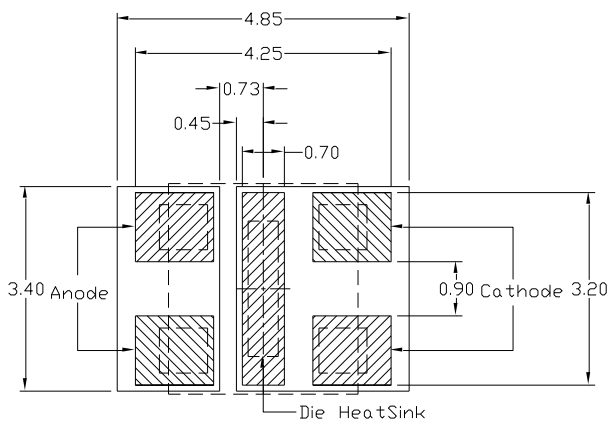

**Alternative Solder Pad**



**Recommended FR4 Solder Pad w/Thermal Vias**

**TAPE AND REEL**

All Cree carrier tapes conform to EIA-481D, Automated Component Handling Systems Standard.

All dimensions in mm.



**PACKAGING**

**Unpackaged Reel**



Label with Cree Bin Code, Qty, Reel ID

**Packaged Reel**



Desiccant (inside bag)

Humidity Indicator Card (inside bag)

Label with Cree Order Code, Qty, Reel ID, PO #

Label with Cree Bin Code, Qty, Reel ID

**Boxed Reel**



Label with Cree Order Code, Qty, Reel ID, PO #

Label with Cree Bin Code, Qty, Reel ID

Patent Label (on bottom of box)



Компания «ЭлектроПласт» предлагает заключение долгосрочных отношений при поставках импортных электронных компонентов на взаимовыгодных условиях!

Наши преимущества:

- Оперативные поставки широкого спектра электронных компонентов отечественного и импортного производства напрямую от производителей и с крупнейших мировых складов;
- Поставка более 17-ти миллионов наименований электронных компонентов;
- Поставка сложных, дефицитных, либо снятых с производства позиций;
- Оперативные сроки поставки под заказ (от 5 рабочих дней);
- Экспресс доставка в любую точку России;
- Техническая поддержка проекта, помощь в подборе аналогов, поставка прототипов;
- Система менеджмента качества сертифицирована по Международному стандарту ISO 9001;
- Лицензия ФСБ на осуществление работ с использованием сведений, составляющих государственную тайну;
- Поставка специализированных компонентов (Xilinx, Altera, Analog Devices, Intersil, Interpoint, Microsemi, Aeroflex, Peregrine, Syfer, Eurofarad, Texas Instrument, Miteq, Cobham, E2V, MA-COM, Hittite, Mini-Circuits, General Dynamics и др.);

Помимо этого, одним из направлений компании «ЭлектроПласт» является направление «Источники питания». Мы предлагаем Вам помощь Конструкторского отдела:

- Подбор оптимального решения, техническое обоснование при выборе компонента;
- Подбор аналогов;
- Консультации по применению компонента;
- Поставка образцов и прототипов;
- Техническая поддержка проекта;
- Защита от снятия компонента с производства.



#### Как с нами связаться

**Телефон:** 8 (812) 309 58 32 (многоканальный)

**Факс:** 8 (812) 320-02-42

**Электронная почта:** [org@eplast1.ru](mailto:org@eplast1.ru)

**Адрес:** 198099, г. Санкт-Петербург, ул. Калинина, дом 2, корпус 4, литера А.