

Applications

- Automotive
- Instrumentation
- White goods
- Telecommunications

Benefits

- RoHS Compliant
- Halogen and Lead Free
- Sharp detection feeling
- Compact Size

JJ Series – Detector Switches



TE Connectivity is pleased to introduce its JJ Series of Detector Switches, suitable for a wide variety of applications given their several presentations ranging from horizontal or vertical actuated options as well as Gull-winged, J-leaded and Through-Hole mounting possibilities.

The Detector Switches will be offered in a wide range of sizes giving the possibility for countless applications going from automotive to telecommunications.

JJ Series – Family Classification

Series	Body Size
JJA	3.5x2.8 mm
JJB	3.5x2.98 mm
JJC	3.5x3.3 mm
JJD	4.2x3.6 mm
JJE	4.7x3.5 mm
JJF	4.7x3.8 mm
JJG	5.7x4.0 mm (High-Rating)
JJH	5.7x4.0 mm (Standard-Rating)
JJI	5.0x4.4 mm
JJJ	6.0x4.85 mm / 5.5x4.7 mm
JJK	6.3x3.0 mm
JJL	6.5x3.9 mm
JJM	5.7x4.0 mm
JJN	5.7x4.0 mm (Wedge)
JJO	10.0x3.8 mm
JJP	10.6x10.0 mm

JJG Family – 5.7x4.0 mm (High-Rating)

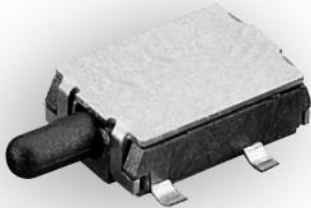
	Contact Rating	100mA, 12VDC Max.
	Contact Resistance	1Ω Max.
	Insulation Resistance	100MΩ Min. 100VDC
	Dielectric Strength	100VAC/1 minute
	Operating Force	100±50gF Max.
	Operating Life	100,000 cycles
	Operating Temperature	-40°C to 85°C

Features	Applications
<ul style="list-style-type: none"> Guiding post for easy orientation NO and NC circuit options Gull-winged and J-Bend terminations 	<ul style="list-style-type: none"> DSC Instrumentation Telecommunications

Circuit

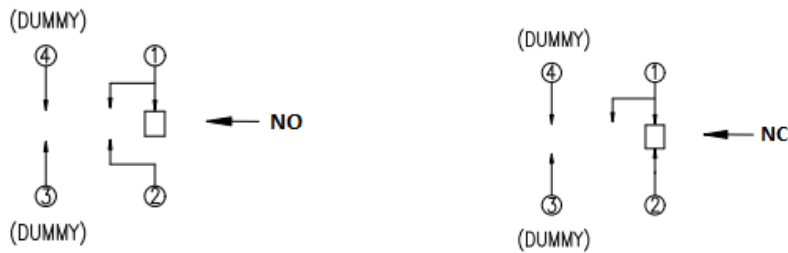

How To Order

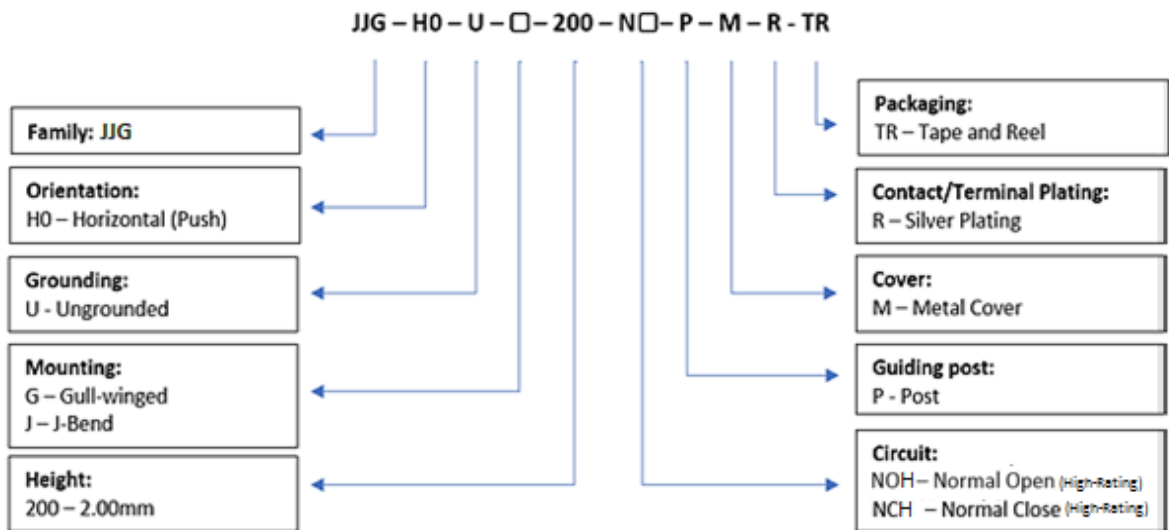

Diagrams

-Gull-winged

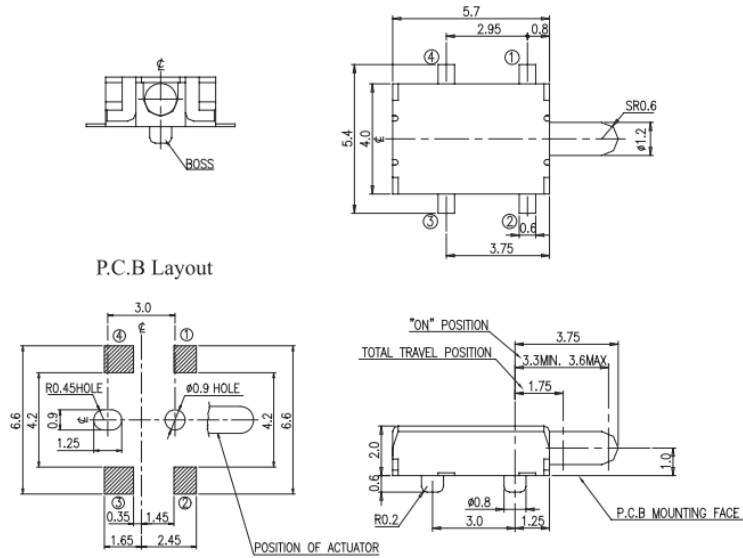

-J-Bend

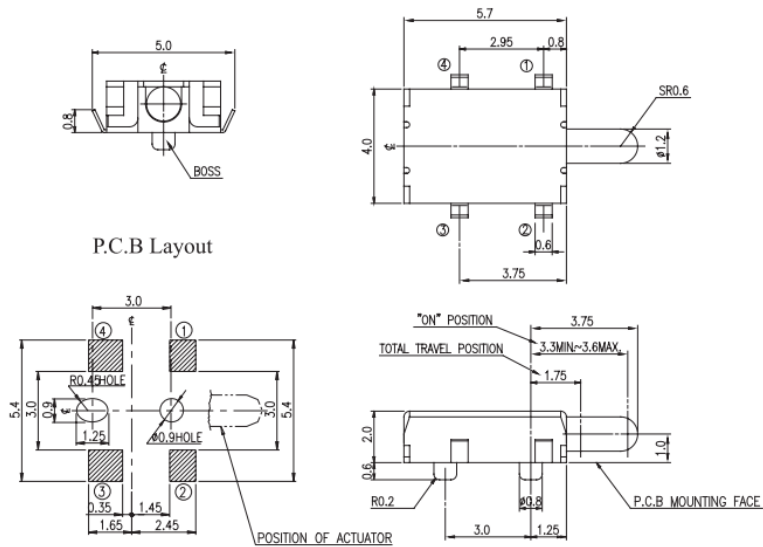

PN List

Smart PN	Orientation	Grounding	Mounting	Height	Circuit	Guide Post	Cover	Plating	Packaging	MOQ	TE PN
JJGH0UG200NOHPMRTR	Horizontal (Push)	Ungrounded	Gull-winged	2.00mm	NOH	Post	Metal	Silver	Tape and Reel	3,000	2331356-1
JJGH0UG200NCHPMRTR	Horizontal (Push)	Ungrounded	Gull-winged	2.00mm	NCH	Post	Metal	Silver	Tape and Reel	3,000	2331381-1
JJGH0UJ200NOHPMRTR	Horizontal (Push)	Ungrounded	J-Bend	2.00mm	NOH	Post	Metal	Silver	Tape and Reel	3,000	2331402-1
JJGH0UJ200NCHPMRTR	Horizontal (Push)	Ungrounded	J-Bend	2.00mm	NCH	Post	Metal	Silver	Tape and Reel	3,000	2331403-1



1. Test Conditions

Standard test conditions shall be 5°C to 35°C in temperature, 45% to 85% in humidity and 86 to 106kPa in atmospheric pressure. Should any doubt arise in judgment, tests shall be conducted at 20±2°C in temperature, 60% to 70% in humidity and 86 to 106kPa in atmospheric pressure.

2. Operating Temperature Range: -40°C to 85°C.

3. Construction:

- Shape and dimension are subject to attached drawing regulation.
- Appearance: whole should be a good completion, no rust, no crack and good plating.

4. Current Range: 100mA, 12VDC

5. Type of Actuation: Tactile feedback

6. Test Sequence:

	Item	Description	Test Conditions	Requirements
Appearance	1	Visual Examination	Physical inspection without applying any external forces.	There shall be no defects that affect the serviceability of the product.
Electric Performance	2	Contact Resistance	Actuate the switch and measure contact resistance using a micro-Ohmmeter.	1Ω Max.
	3	Insulation Resistance	Measurements shall be made at 100 VDC potential between terminals and cover.	100MΩ Min.
	4	Dielectric Withstanding Voltage	100V AC (50Hz or 60Hz) between terminals and cover for 1 minute.	There shall be no breakdown or flashover

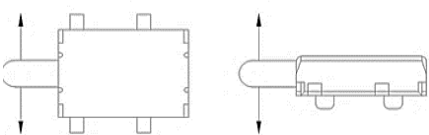
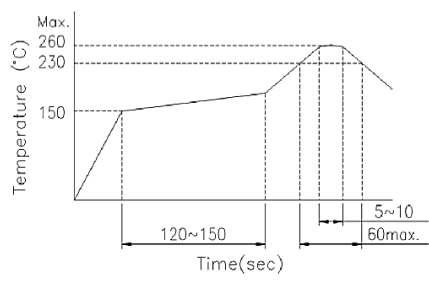
Mechanical Performance	5	Operating Force	-----	100±50gF Max.
	6	Terminal Strength	The static load of 300gF shall be applied on top of the terminal in every direction for 1 minute, in optional direction on condition of once for one terminal.	No dielectric breakdown shall be occurred
	7	Control Strength	1) A static load of 1KgF shall be applied to the actuator for 15 sec. in direction parallel to operation. 2) A static load of 0.3KgF shall be applied to the actuator in pulling direction as parallel to operation for 15 sec. 3) A static load of 0.2KgF shall be applied to the actuator for 15 sec. in direction perpendicular to operation.	Without damage of actuator every part should not defect in appearance and mechanical performance.
	8	Control Wobble	A static load of 0.1KgF shall be applied to the top of the actuator and then displacement shall be measured to the direction of the arrow in the figure below. 	1.0mm p-p MAX.
	9	Solderability	1) Solder temperature: 260°C to 10°C 2) Immersion time: 3±0.5 Sec.	More than 75% of the dipping part shall be covered by solder— Excluding the cutting Surface.
	10	Solder Heat Resistance	1) Manual soldering -Terminal: 300°C ± 5°C -Time: 5 Sec. Max. 2) Reflow Soldering:  Above mentioned time-temperature chart is based on the temperature on the parts-mounting surface of PCB.	1) Shall be from pronounced deforming in appearance. 2) The electrical performance requirements specified in item 2 to 4 shall be satisfied 3) Operating force: Within ±30% of initial value.
Durability	11	Life test (Without Load)	Test per method: 100,000 cycles of operating shall be performed continuously at the rate of 15 to 20 cycles/minute.	1) Contact resistance: Less than 3Ω. 2) Insulation resistance: More than 10MΩ. 3) operating force: Within ±30% of initial value. 4) Every part should not defect in appearance and mechanical performance.



Weather-proof	12	Humidity Resistance	Following the test set forth below the sample shall be left in normal temperature and humidity conditions for 1 hour before and after the measurements are made: 1) Temperature: 40±2°C 2) Relative Humidity: 90 to 95% 3) Time: 96 hours (Drops of water being taken away)	1) Contact resistance: Less than 3Ω. 2) Insulation resistance: More than 10MΩ. 3) operating force: Within ±30% of initial value. 4) Every part should not defect in appearance and mechanical performance.													
	13	Heat Resistance	Following the test set forth below the sample shall be left in normal temperature and humidity conditions for 1 hour before and after the measurements are made: 1) Temperature: 85±2°C 2) Time: 96 hours														
	14	Low Temperature Resistance	Following the test set forth below the sample shall be left in normal temperature and humidity conditions for 1 hour before the measurements are made: 1) Temperature: -20±2°C 2) Time: 96 hours (Drops of water being taken away)														
	15	Temperature Cycle Test	After repeating the following test cycles 5 times, and in the normal ambient condition 1 Hour, then to be measured within 1 Hour. <table border="1" style="width: 100%; border-collapse: collapse;"> <thead> <tr> <th></th> <th style="text-align: center;">Temperature</th> <th style="text-align: center;">Time</th> </tr> </thead> <tbody> <tr> <td style="text-align: center;">1</td> <td style="text-align: center;">-20 ± 3°C</td> <td style="text-align: center;">30 Minutes</td> </tr> <tr> <td style="text-align: center;">2</td> <td style="text-align: center;">20 ± 2°C</td> <td style="text-align: center;">15 Minutes</td> </tr> <tr> <td style="text-align: center;">3</td> <td style="text-align: center;">70 ± 20°C</td> <td style="text-align: center;">30 Minutes</td> </tr> <tr> <td style="text-align: center;">4</td> <td style="text-align: center;">20 ± 2°C</td> <td style="text-align: center;">15 Minutes</td> </tr> </tbody> </table> (Drops of water being taken away)			Temperature	Time	1	-20 ± 3°C	30 Minutes	2	20 ± 2°C	15 Minutes	3	70 ± 20°C	30 Minutes	4
	Temperature	Time															
1	-20 ± 3°C	30 Minutes															
2	20 ± 2°C	15 Minutes															
3	70 ± 20°C	30 Minutes															
4	20 ± 2°C	15 Minutes															

■ Precautions in Handling

1. Care must be taken to ensure excess flux on the top surface of the printed circuit board does not adhere to the switch.
2. Do not wash the switch.

■ Recommended storage conditions:

Store the products in the original packaging material. After opening the package, the remaining products must be stored in the appropriate moisture-proof & airtight environment.

Do not store the switch in the following environment or it may affect performance and solderability:

1. temperatures below -10° C to 40°C & humidity at 85% (min)
2. environment with corrosive gas
3. storage over 6 months
4. place in direct sunlight



Компания «ЭлектроПласт» предлагает заключение долгосрочных отношений при поставках импортных электронных компонентов на взаимовыгодных условиях!

Наши преимущества:

- Оперативные поставки широкого спектра электронных компонентов отечественного и импортного производства напрямую от производителей и с крупнейших мировых складов;
- Поставка более 17-ти миллионов наименований электронных компонентов;
- Поставка сложных, дефицитных, либо снятых с производства позиций;
- Оперативные сроки поставки под заказ (от 5 рабочих дней);
- Экспресс доставка в любую точку России;
- Техническая поддержка проекта, помощь в подборе аналогов, поставка прототипов;
- Система менеджмента качества сертифицирована по Международному стандарту ISO 9001;
- Лицензия ФСБ на осуществление работ с использованием сведений, составляющих государственную тайну;
- Поставка специализированных компонентов (Xilinx, Altera, Analog Devices, Intersil, Interpoint, Microsemi, Aeroflex, Peregrine, Syfer, Eurofarad, Texas Instrument, Miteq, Cobham, E2V, MA-COM, Hittite, Mini-Circuits, General Dynamics и др.);

Помимо этого, одним из направлений компании «ЭлектроПласт» является направление «Источники питания». Мы предлагаем Вам помощь Конструкторского отдела:

- Подбор оптимального решения, техническое обоснование при выборе компонента;
- Подбор аналогов;
- Консультации по применению компонента;
- Поставка образцов и прототипов;
- Техническая поддержка проекта;
- Защита от снятия компонента с производства.



Как с нами связаться

Телефон: 8 (812) 309 58 32 (многоканальный)

Факс: 8 (812) 320-02-42

Электронная почта: org@eplast1.ru

Адрес: 198099, г. Санкт-Петербург, ул. Калинина, дом 2, корпус 4, литера А.