

## Optocoupler, Photodarlington Output, High Gain (Dual, Quad Channel)

### Features

- Isolation Test Voltage, 5300 V<sub>RMS</sub>
- High Isolation Resistance, 10<sup>11</sup> Ω Typical
- Low Coupling Capacitance
- Standard Plastic DIP Package
- Lead-free component
- Component in accordance to RoHS 2002/95/EC and WEEE 2002/96/EC

### Agency Approvals

- UL1577, File No. E52744 System Code H or J, Double Protection
- DIN EN 60747-5-2 (VDE0884)  
DIN EN 60747-5-5 pending  
Available with Option 1

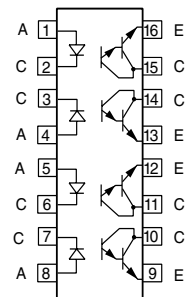
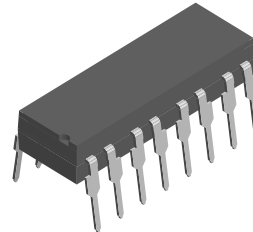
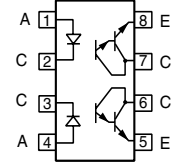
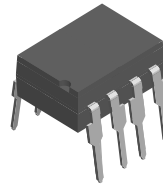

1179017



### Description

The ILD32/ ILQ32 are optically coupled isolators with a gallium arsenide infrared LED and a silicon photodarlington sensor. Switching can be achieved while maintaining a high degree of isolation between driving and load circuits.

These optocouplers can be used to replace reed and mercury relays with advantages of long life, high speed switching and elimination of magnetic fields.

### Order Information

Part	Remarks
ILD32	CTR > 500 %, DIP-8
ILQ32	CTR > 500 %, DIP-16
ILD32-X006	CTR > 500 %, DIP-8 400 mil (option 6)
ILD32-X007	CTR > 500 %, SMD-8 (option 7)
ILD32-X009	CTR > 500 %, SMD-8 (option 9)
ILQ32-X007	CTR > 500 %, SMD-8 (option 7)
ILQ32-X009	CTR > 500 %, SMD-8 (option 9)

For additional information on the available options refer to Option Information.

### Absolute Maximum Ratings

T<sub>amb</sub> = 25 °C, unless otherwise specified

Stresses in excess of the absolute Maximum Ratings can cause permanent damage to the device. Functional operation of the device is not implied at these or any other conditions in excess of those given in the operational sections of this document. Exposure to absolute Maximum Rating for extended periods of the time can adversely affect reliability.

### Input

Parameter	Test condition	Symbol	Value	Unit
Peak reverse voltage		V <sub>R</sub>	3.0	V
Forward continuous current		I <sub>F</sub>	60	mA
Power dissipation		P <sub>diss</sub>	100	mW
Derate linearly from 25°C			1.33	mW/°C

### Output

Parameter	Test condition	Symbol	Value	Unit
Collector-emitter breakdown voltage		$BV_{CEO}$	30	V
Collector (load) current		$I_C$	125	mA
Power dissipation		$P_{diss}$	150	mW
Derate linearly from 25°C			2.0	mW/°C

### Coupler

Parameter	Test condition	Part	Symbol	Value	Unit
Isolation test voltage <sup>1)</sup>	$t = 1.0 \text{ sec.}$		$V_{ISO}$	5300	$V_{RMS}$
Creepage				$\geq 7$	mm
Clearance				$\geq 7$	mm
Comparative tracking index per DIN IEC 112/VDE303, part 1				$\geq 175$	
Isolation resistance	$V_{IO} = 500 \text{ V}, T_{amb} = 25 \text{ °C}$		$R_{IO}$	$10^{12}$	$\Omega$
	$V_{IO} = 500 \text{ V}, T_{amb} = 100 \text{ °C}$		$R_{IO}$	$10^{11}$	$\Omega$
Total dissipation		ILD32	$P_{tot}$	400	mW
		ILQ32	$P_{tot}$	500	mW
Derate linearly from 25 °C		ILD32		5.33	mW/°C
		ILQ32		6.67	mW/°C
Storage temperature			$T_{stg}$	- 55 to + 150	°C
Operating temperature			$T_{amb}$	- 55 to + 100	°C
Lead soldering time at 260 °C				10	sec.

<sup>1)</sup> between emitter and detector refer to standard climate 23 °C/50 %RH; DIN 50014

### Electrical Characteristics

$T_{amb} = 25 \text{ °C}$ , unless otherwise specified

Minimum and maximum values are testing requirements. Typical values are characteristics of the device and are the result of engineering evaluation. Typical values are for information only and are not part of the testing requirements.

### Input

Parameter	Test condition	Symbol	Min	Typ.	Max	Unit
Forward voltage	$I_F = 10 \text{ mA}$	$V_F$		1.25	1.5	V
Reverse current	$V_R = 3.0 \text{ V}$	$I_R$		0.1	100	pF
Capacitance	$V_R = 0 \text{ V}$	$C_O$		25		pF

### Output

Parameter	Test condition	Symbol	Min	Typ.	Max	Unit
Collector-emitter breakdown voltage	$I_C = 100 \text{ }\mu\text{A}, I_F = 0$	$BV_{CEO}$	30			V
Breakdown voltage emitter-collector	$I_E = 100 \text{ }\mu\text{A}$	$BC_{ECO}$	5.0	10		nA
Collector-emitter leakage current	$V_{CE} = 10 \text{ V}, I_F = 0$	$I_{CEO}$		1.0	100	nA

## Coupler

Parameter	Test condition	Symbol	Min	Typ.	Max	Unit
Collector emitter	$I_C = 2.0 \text{ mA}$ , $I_F = 8.0 \text{ mA}$	$V_{CEsat}$			1.0	V
Capacitance (input-output)		$C_{IO}$		0.5		pF

## Current Transfer Ratio

Parameter	Test condition	Symbol	Min	Typ.	Max	Unit
Current Transfer Ratio	$I_F = 10 \text{ mA}$ , $V_{CE} = 10 \text{ V}$	CTR	500			%

## Switching Characteristics

Parameter	Test condition	Symbol	Min	Typ.	Max	Unit
Turn-on time	$V_{CC} = 10 \text{ V}$ , $I_F = 5.0 \text{ mA}$ , $R_L = 100 \ \Omega$	$t_{on}$		15		$\mu\text{s}$
Turn-off time	$V_{CC} = 10 \text{ V}$ , $I_F = 5.0 \text{ mA}$ , $R_L = 100 \ \Omega$	$t_{off}$		30		$\mu\text{s}$

## Typical Characteristics ( $T_{amb} = 25 \text{ }^\circ\text{C}$ unless otherwise specified)

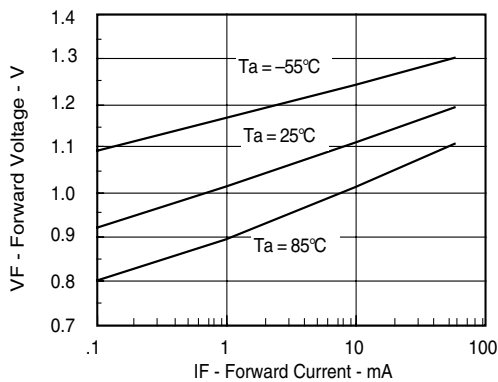

ild32\_01

Figure 1. Forward Voltage vs. Forward Current

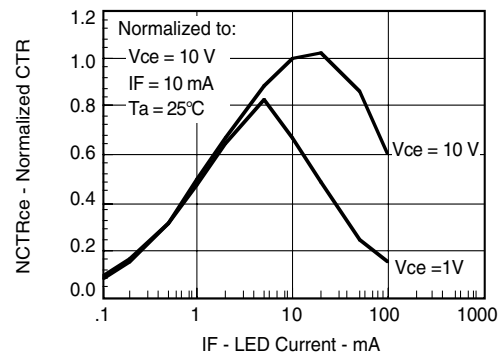

ild32\_02

Figure 2. Normalized Non-saturated and Saturated  $CTR_{CE}$  vs. LED Current

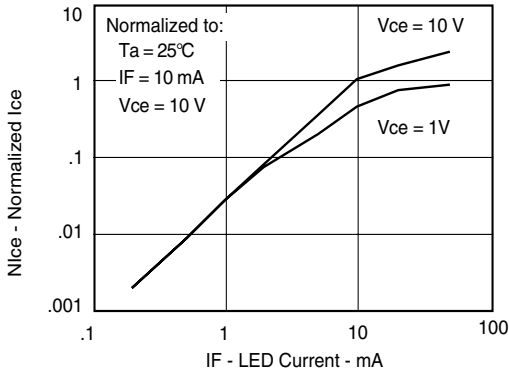

Figure 3. Normalized Non-Saturated and Saturated Collector-Emitter Current vs. LED Current

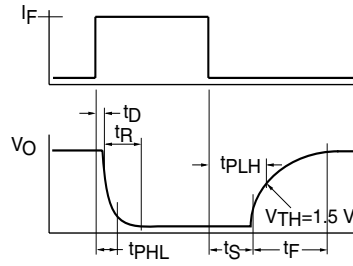

Figure 6. Switching Timing

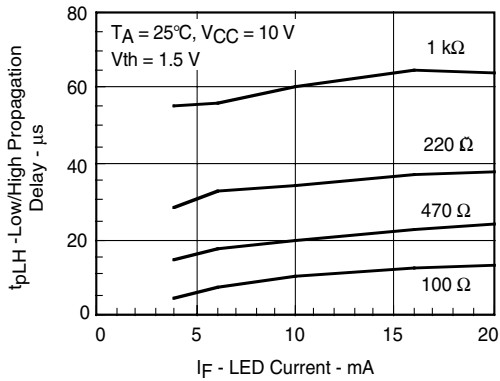

Figure 4. Low to High Propagation Delay vs. Collector Load Resistance and LED Current

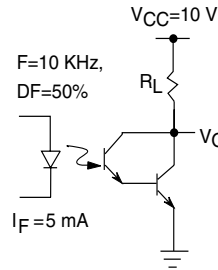

Figure 7. Switching Schematic

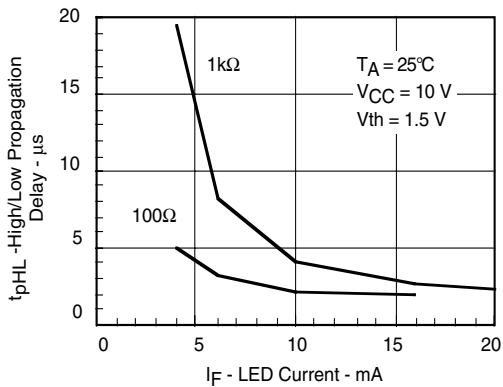
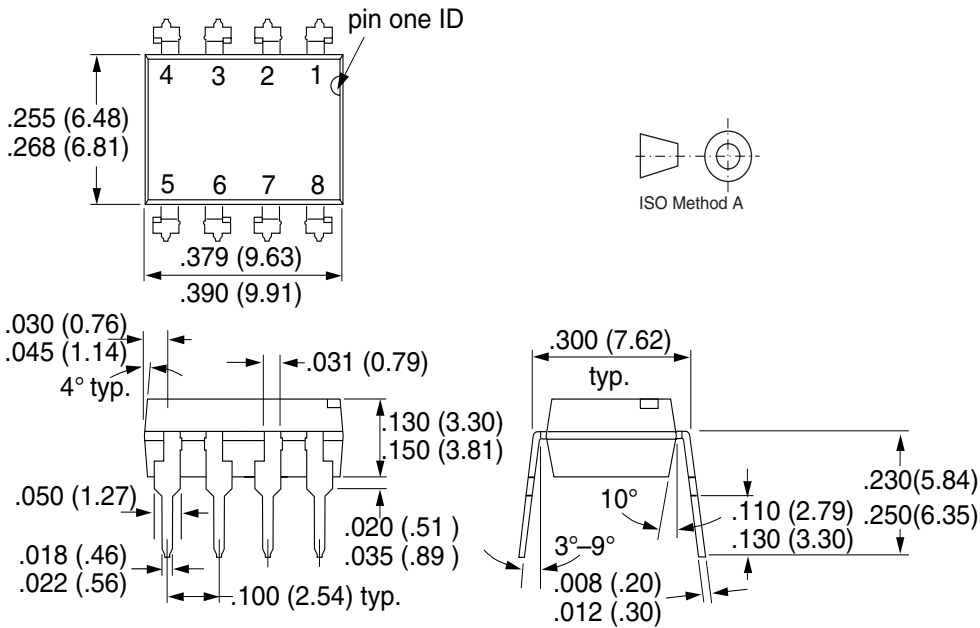
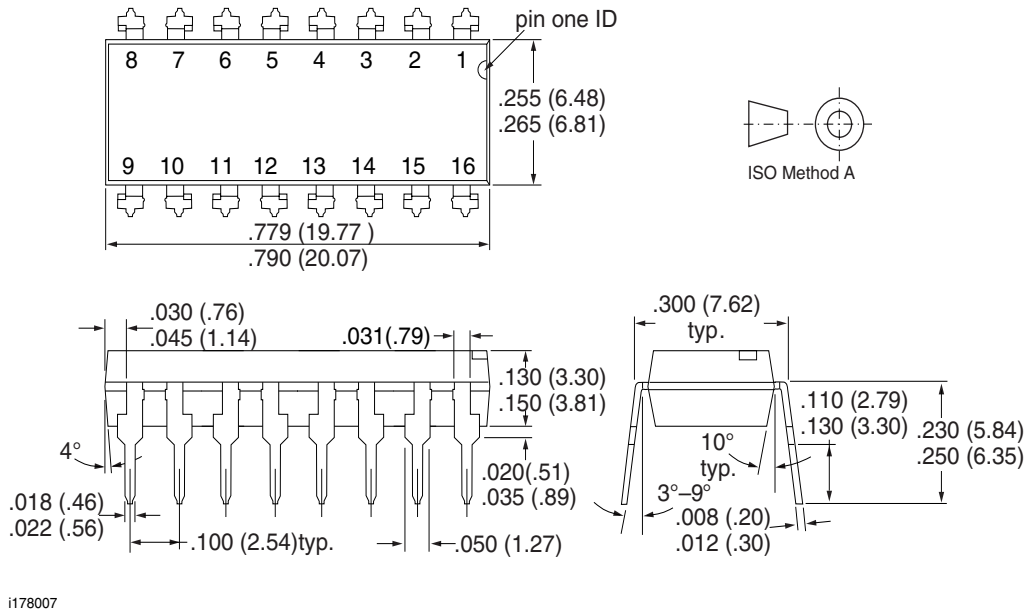

Figure 5. High to low Propagation Delay vs. Collector Load Resistance and LED Current

## Package Dimensions in Inches (mm)



## Package Dimensions in Inches (mm)



Option 6

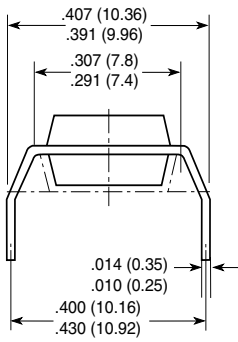

Option 7

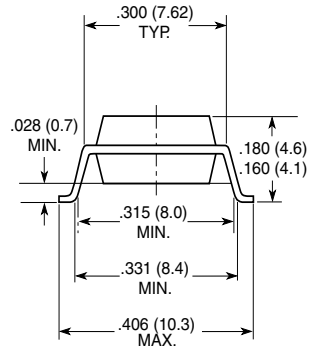

Option 9

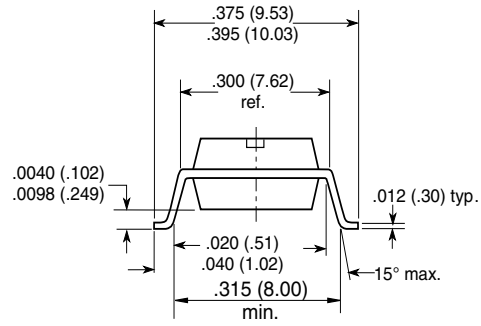

18450



## Ozone Depleting Substances Policy Statement

It is the policy of Vishay Semiconductor GmbH to

1. Meet all present and future national and international statutory requirements.
2. Regularly and continuously improve the performance of our products, processes, distribution and operating systems with respect to their impact on the health and safety of our employees and the public, as well as their impact on the environment.

It is particular concern to control or eliminate releases of those substances into the atmosphere which are known as ozone depleting substances (ODSs).

The Montreal Protocol (1987) and its London Amendments (1990) intend to severely restrict the use of ODSs and forbid their use within the next ten years. Various national and international initiatives are pressing for an earlier ban on these substances.

Vishay Semiconductor GmbH has been able to use its policy of continuous improvements to eliminate the use of ODSs listed in the following documents.

1. Annex A, B and list of transitional substances of the Montreal Protocol and the London Amendments respectively
2. Class I and II ozone depleting substances in the Clean Air Act Amendments of 1990 by the Environmental Protection Agency (EPA) in the USA
3. Council Decision 88/540/EEC and 91/690/EEC Annex A, B and C (transitional substances) respectively.

Vishay Semiconductor GmbH can certify that our semiconductors are not manufactured with ozone depleting substances and do not contain such substances.

We reserve the right to make changes to improve technical design and may do so without further notice.

Parameters can vary in different applications. All operating parameters must be validated for each customer application by the customer. Should the buyer use Vishay Semiconductors products for any unintended or unauthorized application, the buyer shall indemnify Vishay Semiconductors against all claims, costs, damages, and expenses, arising out of, directly or indirectly, any claim of personal damage, injury or death associated with such unintended or unauthorized use.

Vishay Semiconductor GmbH, P.O.B. 3535, D-74025 Heilbronn, Germany  
Telephone: 49 (0)7131 67 2831, Fax number: 49 (0)7131 67 2423



### Notice

Specifications of the products displayed herein are subject to change without notice. Vishay Intertechnology, Inc., or anyone on its behalf, assumes no responsibility or liability for any errors or inaccuracies.

Information contained herein is intended to provide a product description only. No license, express or implied, by estoppel or otherwise, to any intellectual property rights is granted by this document. Except as provided in Vishay's terms and conditions of sale for such products, Vishay assumes no liability whatsoever, and disclaims any express or implied warranty, relating to sale and/or use of Vishay products including liability or warranties relating to fitness for a particular purpose, merchantability, or infringement of any patent, copyright, or other intellectual property right.

The products shown herein are not designed for use in medical, life-saving, or life-sustaining applications. Customers using or selling these products for use in such applications do so at their own risk and agree to fully indemnify Vishay for any damages resulting from such improper use or sale.





Компания «ЭлектроПласт» предлагает заключение долгосрочных отношений при поставках импортных электронных компонентов на взаимовыгодных условиях!

Наши преимущества:

- Оперативные поставки широкого спектра электронных компонентов отечественного и импортного производства напрямую от производителей и с крупнейших мировых складов;
- Поставка более 17-ти миллионов наименований электронных компонентов;
- Поставка сложных, дефицитных, либо снятых с производства позиций;
- Оперативные сроки поставки под заказ (от 5 рабочих дней);
- Экспресс доставка в любую точку России;
- Техническая поддержка проекта, помощь в подборе аналогов, поставка прототипов;
- Система менеджмента качества сертифицирована по Международному стандарту ISO 9001;
- Лицензия ФСБ на осуществление работ с использованием сведений, составляющих государственную тайну;
- Поставка специализированных компонентов (Xilinx, Altera, Analog Devices, Intersil, Interpoint, Microsemi, Aeroflex, Peregrine, Syfer, Eurofarad, Texas Instrument, Miteq, Cobham, E2V, MA-COM, Hittite, Mini-Circuits, General Dynamics и др.);

Помимо этого, одним из направлений компании «ЭлектроПласт» является направление «Источники питания». Мы предлагаем Вам помощь Конструкторского отдела:

- Подбор оптимального решения, техническое обоснование при выборе компонента;
- Подбор аналогов;
- Консультации по применению компонента;
- Поставка образцов и прототипов;
- Техническая поддержка проекта;
- Защита от снятия компонента с производства.



#### Как с нами связаться

**Телефон:** 8 (812) 309 58 32 (многоканальный)

**Факс:** 8 (812) 320-02-42

**Электронная почта:** [org@eplast1.ru](mailto:org@eplast1.ru)

**Адрес:** 198099, г. Санкт-Петербург, ул. Калинина, дом 2, корпус 4, литера А.