



The Future of Analog IC Technology®

# MP4050A

## Non-Isolated, High-Brightness LED Driver with Enhanced Thermal Feature

### DESCRIPTION

The MP4050A is a constant current LED driver with an integrated 500V MOSFET. It is designed specifically for energy efficient and low-cost LED bulb replacement applications.

The MP4050A is designed to drive high-brightness LEDs from a universal AC grid input or DC input. The accurate output LED current is achieved by an averaging internal current feedback loop. Constant LED current is delivered quietly by switching the internal MOSFET at a frequency regulated above 22kHz.

The MP4050A can be powered directly by the high input voltage. An internal high-voltage current source regulates supply voltage without external circuitry.

Full protections features include integrated thermal current foldback, VCC under-voltage lockout (UVLO), open LED protection (OLP), short-circuit protection (SCP), and over-temperature protection (OTP). These features make the MP4050A an ideal solution for simple, off-line, and non-isolated LED applications.

### FEATURES

- Constant Current LED Driver
- Integrated 500V/8Ω MOSFET
- Low VCC Operating Current
- Maximum Frequency Limit
- Audible Noise Restrain
- Internal High-Voltage Current Source
- Internal 200ns Leading Edge Blanking
- Integrated Thermal Current Foldback
- Thermal Shutdown (Auto Re-Start with Hysteresis)
- VCC Under-Voltage Lockout with Hysteresis
- Open LED Protection
- Short-Circuit Protection
- Auto-Restart Function
- Available in TSOT23-5/SOIC-8 Packages

### APPLICATIONS

- AC/DC or DC/DC LED Driver Application
- General Illumination
- Industrial Lighting
- Automotive/Decorative LED Lighting

All MPS parts are lead-free, halogen-free, and adhere to the RoHS directive. For MPS green status, please visit the MPS website under Quality Assurance.

“MPS” and “The Future of Analog IC Technology” are registered trademarks of Monolithic Power Systems, Inc.

### TYPICAL APPLICATION

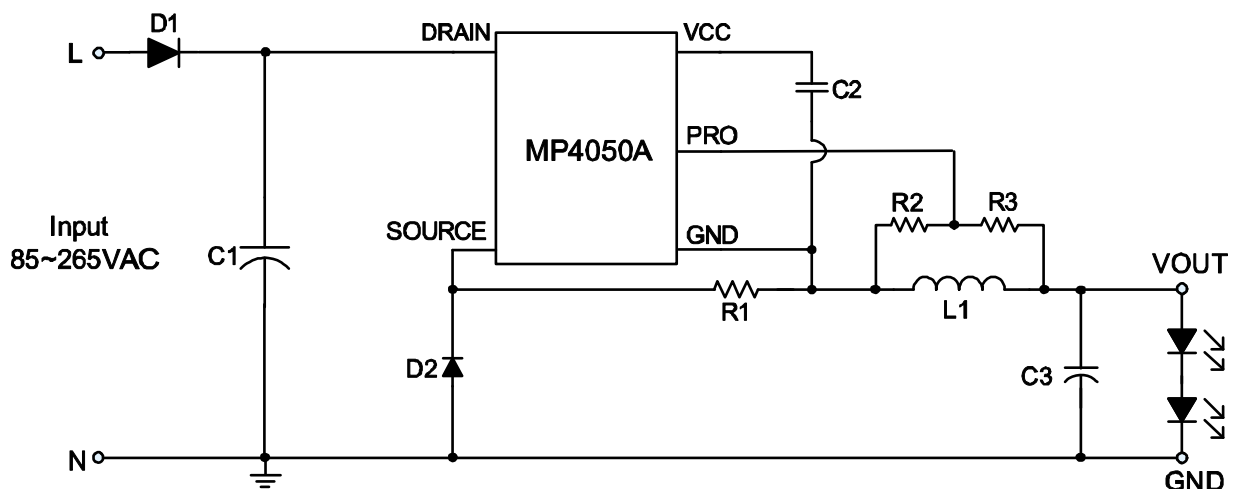

## ORDERING INFORMATION

Part Number	Package	Top Marking
MP4050AGJ*	TSOT23-5	See Below
MP4050AGS**	SOIC-8	

\* For Tape & Reel, add suffix -Z (e.g. MP4050AGJ-Z);

\*\* For Tape & Reel, add suffix -Z (e.g. MP4050AGS-Z).

## TOP MARKING (TSOT23-5)

| ANVY

ANV: Product Code of MP4050AGJ;

Y: Year Code.

## TOP MARKING (SOIC-8)

MP4050A  
 LLLLLLLL  
 MPSYWW

MP4050A: Product Code of MP4050AGS;

LLLLLLLL: Lot Number;

MPS: MPS Prefix;

Y: Year Code;

WW: Week Code.

**PACKAGE REFERENCE**

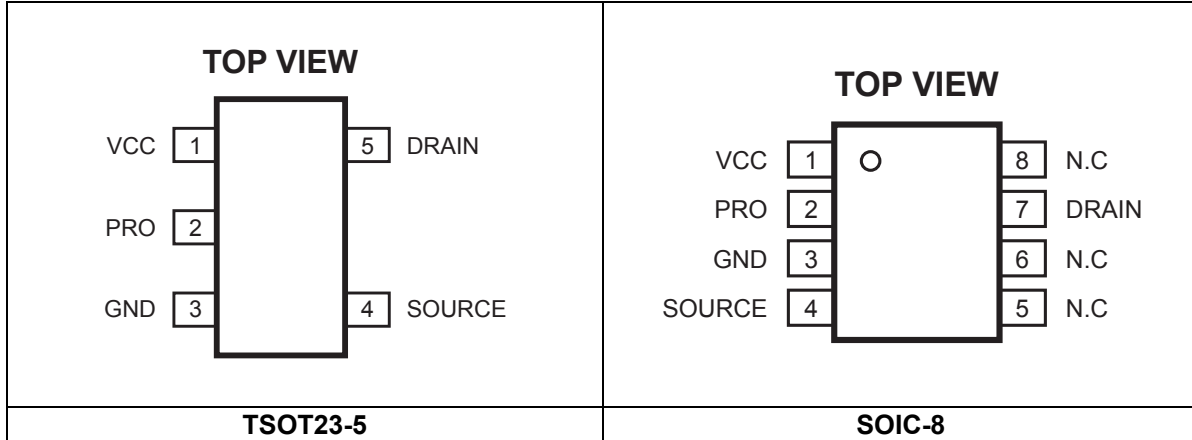

**ABSOLUTE MAXIMUM RATINGS** <sup>(1)</sup>

DRAIN to SOURCE .....	-0.3V to 500V
VCC, SOURCE to GND .....	-0.3V to 6.5V
PRO to GND .....	-0.7V to 6.5V
Source Current on PRO .....	4mA
Continuous Power Dissipation (T <sub>A</sub> = +25°C) <sup>(2)</sup>	
TSOT23-5 .....	1.25W
SOIC-8 .....	1.3W
Lead Temperature .....	260°C
Storage Temperature.....	-60°C to +150°C
ESD Capability Human Body Mode .....	2.0kV
CDM ESD Capability.....	2.0kV

**Recommended Operating Conditions** <sup>(3)</sup>

Supply Voltage VCC Range.....	4.1V to 5.0V
-------------------------------	--------------

**Thermal Resistance** <sup>(4)</sup>

	$\theta_{JA}$	$\theta_{JC}$
TSOT23-5.....	100	55... °C/W
SOIC-8.....	96	45... °C/W

**Notes:**

- 1) Exceeding these ratings may damage the device.
- 2) The maximum allowable power dissipation is a function of the maximum junction temperature T<sub>J</sub> (MAX), the junction-to-ambient thermal resistance  $\theta_{JA}$ , and the ambient temperature T<sub>A</sub>. The maximum allowable continuous power dissipation at any ambient temperature is calculated by P<sub>D</sub> (MAX) = (T<sub>J</sub> (MAX)-T<sub>A</sub>)/ $\theta_{JA}$ . Exceeding the maximum allowable power dissipation produces an excessive die temperature, causing the regulator to go into thermal shutdown. Internal thermal shutdown circuitry protects the device from permanent damage.
- 3) The device is not guaranteed to function outside of its operating conditions.
- 4) Measured on JESD51-7, 4-layer PCB.

## ELECTRICAL CHARACTERISTICS

Typical values are VCC = 5V, T<sub>J</sub> = 25°C, unless otherwise noted.

Minimum and maximum values are at VCC = 5V, T<sub>J</sub> = -40°C to +125°C, unless otherwise noted, guaranteed by characterization.

Parameter	Symbol	Condition	Min	Typ	Max	Units
<b>Start-Up Current Source (DRAIN)</b>						
Internal Regulator Supply Current	I <sub>REGULATOR</sub>	VCC=0V, V <sub>DRAIN</sub> =100V	3.8	5	6.1	mA
Leakage Current from DRAIN	I <sub>D_LKG</sub>	VCC=6V, V <sub>DRAIN</sub> =500V		14	22	μA
<b>Supply Voltage Management (VCC)</b>						
VCC Increasing Level: Internal Regulator Stops & IC Starts Working	VCC <sub>OFF</sub>	VCC Rising Edge	4.00	4.35	4.70	V
VCC Normal Level	VCC <sub>NOR</sub>	Normal Operation		4.25		V
VCC Decreasing Level: Internal Regulator Turn-On	VCC <sub>ON</sub>	VCC Falling Edge	3.85	4.15	4.50	V
VCC Hysteresis: Regulator On/Off	VCC <sub>OFF-ON</sub>		0.11	0.20	0.28	V
VCC Decreasing Level: IC Stops	VCC <sub>STOP</sub>	VCC Falling Edge	3	3.4	3.8	V
VCC Hysteresis: Regulator Off & IC Stops Working	VCC <sub>OFF-STOP</sub>		0.93	1.25	1.6	V
VCC Decreasing Level: Protection Phase Ends	VCC <sub>PRO</sub>	VCC Falling Edge	1.9	2.35	2.8	V
Internal IC Consumption	I <sub>CC</sub>	VCC=4.3V, f <sub>SW</sub> =33kHz, Duty=84%		350	425	μA
Internal IC Consumption at Latch-Off Phase	I <sub>CC_LATCH</sub>			18	32	μA
<b>Internal MOSFET (DRAIN to SOURCE)</b>						
Breakdown Voltage	V <sub>BRDSS</sub>	I <sub>D</sub> =80μA	500			V
DRAIN SOURCE On-State Resistance	R <sub>DS(ON)</sub>	I <sub>D</sub> =10mA, T <sub>J</sub> =25°C		8	12	Ω
		VCC=VCC <sub>STOP</sub> + 50mV, I <sub>D</sub> =10mA, T <sub>J</sub> =25°C		8	12	Ω
<b>Current Sampling Management (SOURCE)</b>						
Peak Current Limit at Normal Operation	V <sub>LIMIT</sub>		0.4	0.46	0.52	V
Leading Edge Blanking	t <sub>LEB</sub>		130	200	310	ns
Feedback Threshold: Turn-On High-Side MOSFET	V <sub>REF</sub>	Regulate the Average Current	0.187	0.196	0.205	V
Minimum Off-Time Limitation	t <sub>OFF_MIN</sub>	Normal Operation	3.4	4.7	6.2	μs
	t <sub>OFF_MIN_ST</sub>	The 1 <sup>st</sup> 32 Switching Cycles at Start-Up		t <sub>OFF_MIN</sub> × 3.5		μs
		The 2 <sup>nd</sup> 32 Switching Cycles at Start-Up		t <sub>OFF_MIN</sub> × 2		μs
		The 3 <sup>rd</sup> 32 Switching Cycles at Start-Up		t <sub>OFF_MIN</sub> × 1.2		μs
Maximum On-Time Limitation	t <sub>ON_MAX</sub>		16	25	37	μs

**ELECTRICAL CHARACTERISTICS** *(continued)*

Typical values are VCC =5V, T<sub>J</sub> = 25°C, unless otherwise noted.

Minimum and maximum values are at VCC =5V, T<sub>J</sub> = -40°C to +125°C, unless otherwise noted, guaranteed by characterization.

Parameter	Symbol	Condition	Min	Typ	Max	Units
<b>Over-Voltage Protection (PRO)</b>						
Over-Voltage Threshold	V <sub>OVP</sub>		1.85	2	2.15	V
Time Constraint on OVP Comparator	t <sub>OVP</sub>			21	32	μs
<b>Thermal Protection</b>						
Thermal Foldback Threshold <sup>(5)</sup>	T <sub>START</sub>			145		°C
Thermal Shutdown Threshold <sup>(5)</sup>	T <sub>SD</sub>			160		°C
Thermal Shutdown Recovery Hysteresis <sup>(5)</sup>	T <sub>HYS</sub>			50		°C

**Notes:**

5) Guaranteed by characterization.

## TYPICAL CHARACTERISTICS

**Internal Regulation Current vs. Junction Temperature**

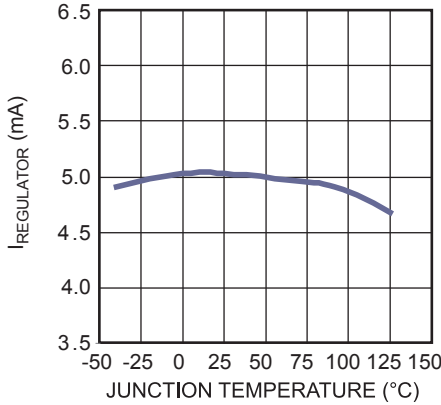

**Leakage Current vs. Junction Temperature**

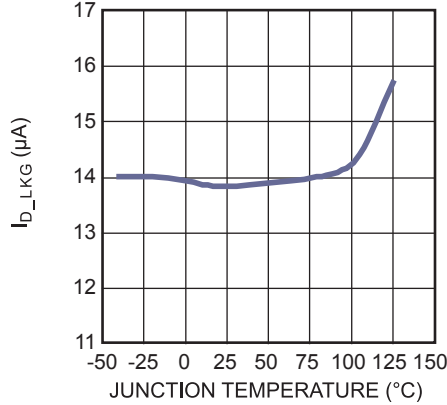

**Breakdown Voltage vs. Junction Temperature**

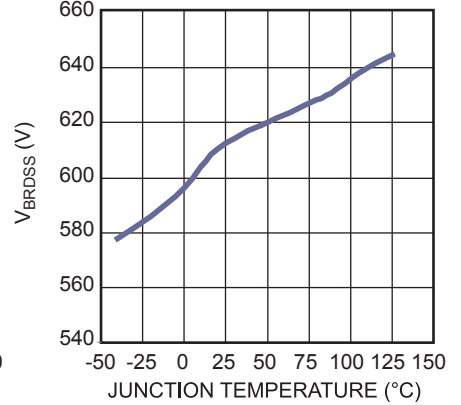

**VCC Current In Latch Phase vs. Junction Temperature**

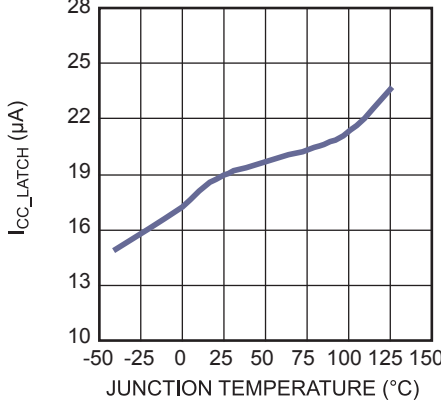

**VCC Regulator Off Threshold vs. Junction Temperature**

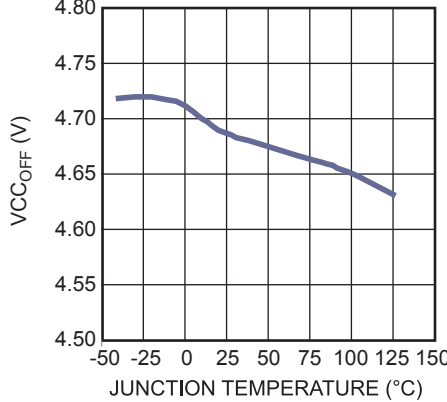

**VCC Regulator On Threshold vs. Junction Temperature**

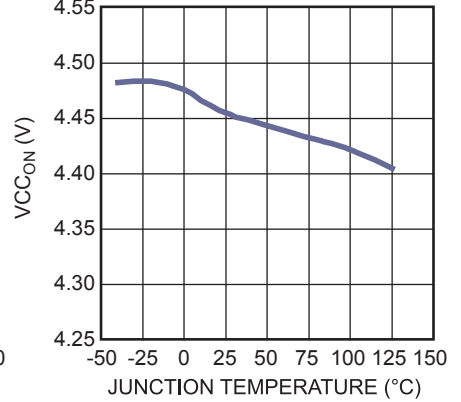

**VCC Stop Threshold vs. Junction Temperature**

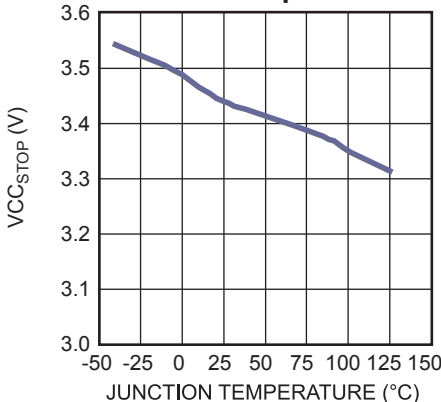

**VCC Protection Threshold vs. Junction Temperature**

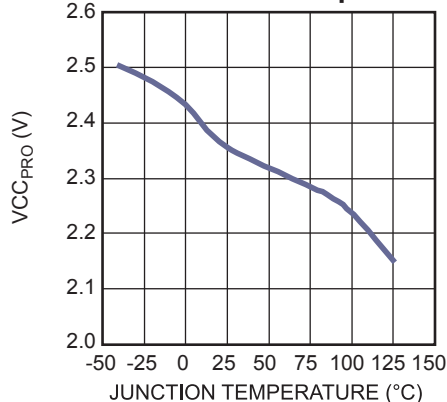

**Feedback Reference vs. Junction Temperature**

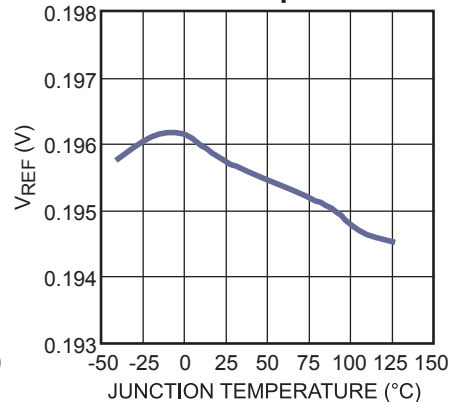

**TYPICAL CHARACTERISTICS** (continued)

**Over-Voltage Protection Reference vs. Junction Temperature**

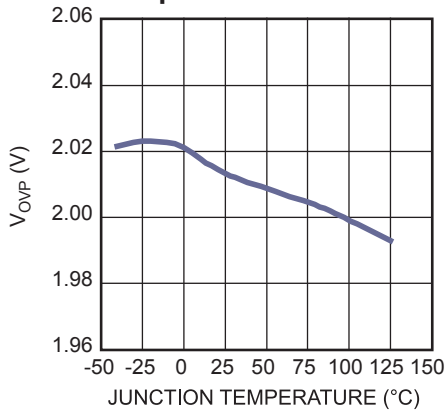

**Minimum Off Time vs. Junction Temperature**

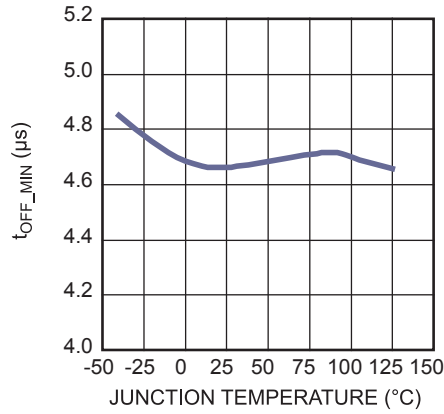

**Maximum On Time vs. Junction Temperature**

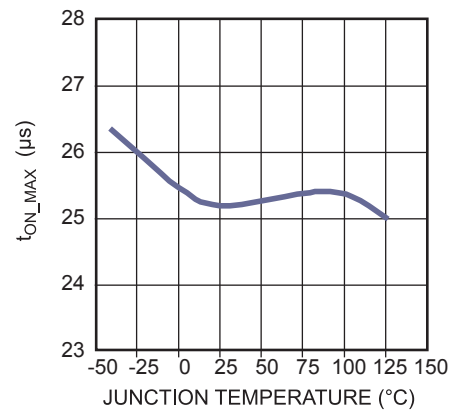

**On-State Resistance vs. Junction Temperature**

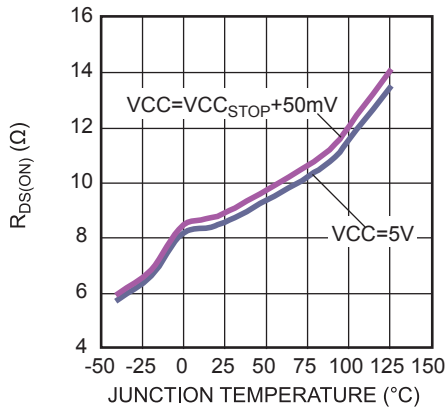

**Peak Current Limit vs. Junction Temperature**

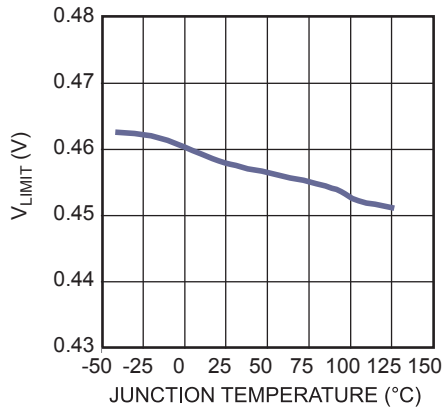

## TYPICAL PERFORMANCE CHARACTERISTICS

$V_{IN} = 230VAC$ , 13 LEDs in series,  $V_{OUT} = 40V$ ,  $I_{LED} = 115mA$ ,  $L = 4.7mH$ ,  $C_{OUT} = 47\mu F$ ,  $T_A = 25^\circ C$ , unless otherwise noted.

**Steady State**

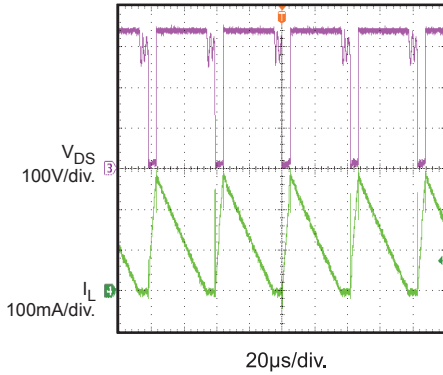

**Turn-On Delay**

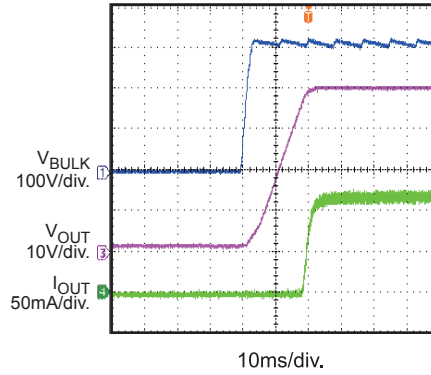

**Input Power Start-Up**

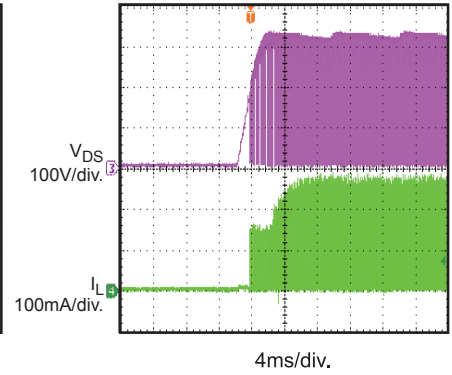

**Input Power Shutdown**

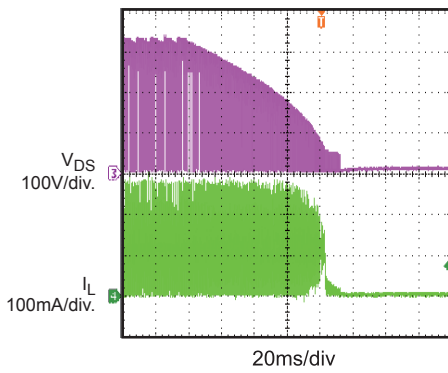

**SCP**

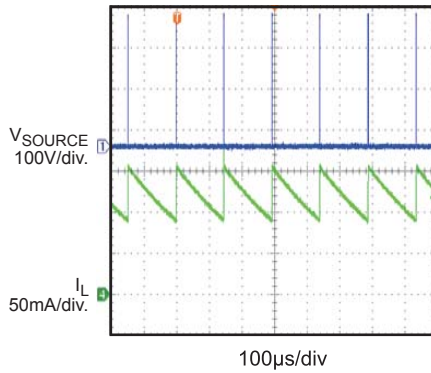

**SCP Entry & Recovery**

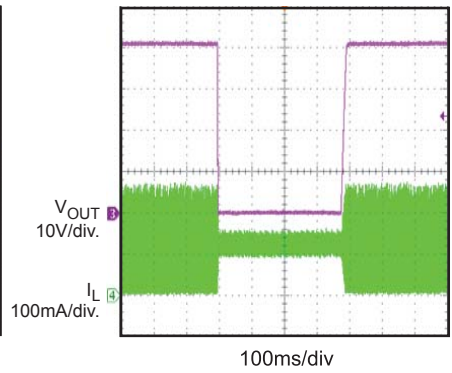

**OVP Entry**

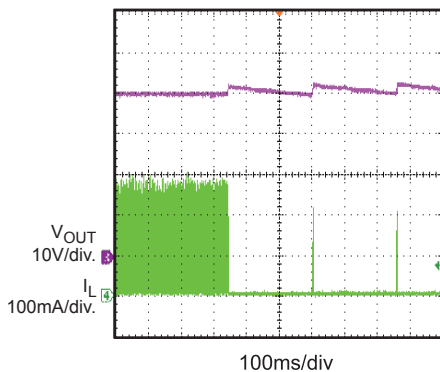

**OVP Recovery**

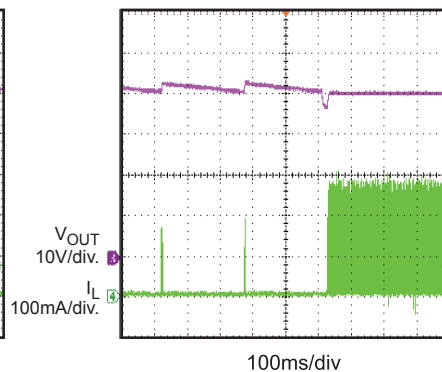

**Output-Current Ripple**

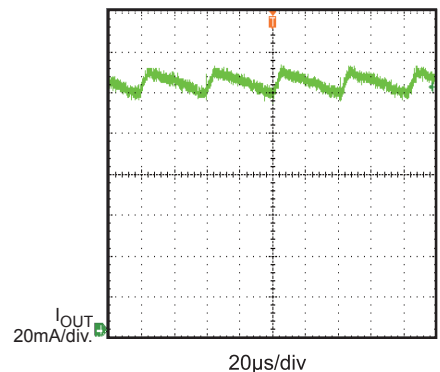



**TYPICAL PERFORMANCE CHARACTERISTICS** (continued)

$V_{IN} = 230VAC$ , 13 LEDs in series,  $V_{OUT} = 40V$ ,  $I_{LED} = 115mA$ ,  $L = 4.7mH$ ,  $C_{OUT} = 47\mu F$ ,  $T_A = 25^\circ C$ , unless otherwise noted.

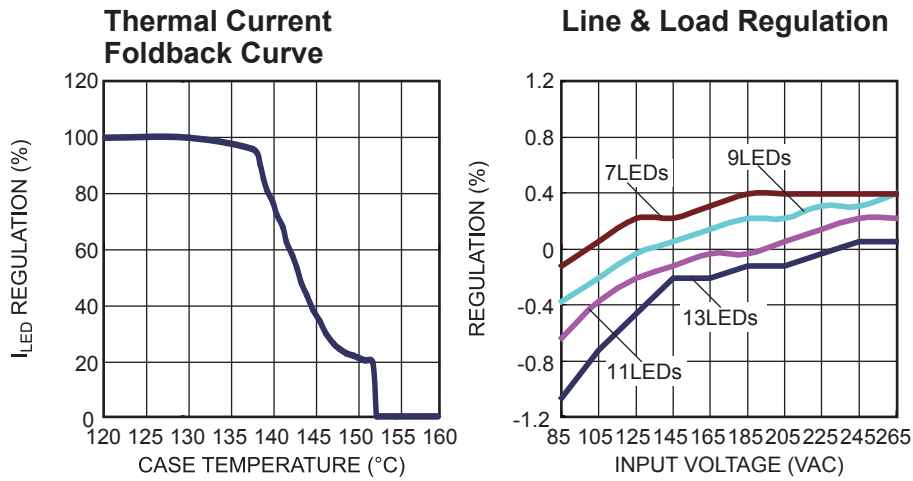

## PIN FUNCTIONS

Pin #		Name	Description
TSOT23-5	SOIC-8		
1	1	VCC	<b>Power Supply.</b> Supply power for the control signals and the high-current MOSFET. Bypass to ground with an external bulk capacitor.
2	2	PRO	<b>Open LED Detection Input.</b> During the turn-off interval, if PRO voltage is higher than $V_{OVP}$ , the over-voltage protection is triggered.
3	3	GND	<b>Ground.</b> The reference ground for the control signal and the gate drive signal.
4	4	SOURCE	<b>Source of Internal Power MOSFET &amp; Feedback Input.</b> Connect current-sensing resistor from SOURCE to GND to set the LED current.
5	7	DRAIN	<b>Drain of Internal Power MOSFET &amp; Integrated HV Current Source Input.</b>
--	5, 6, 8	NC	<b>No Connection.</b> Do Not Connect.

## FUNCTION BLOCK DIAGRAM

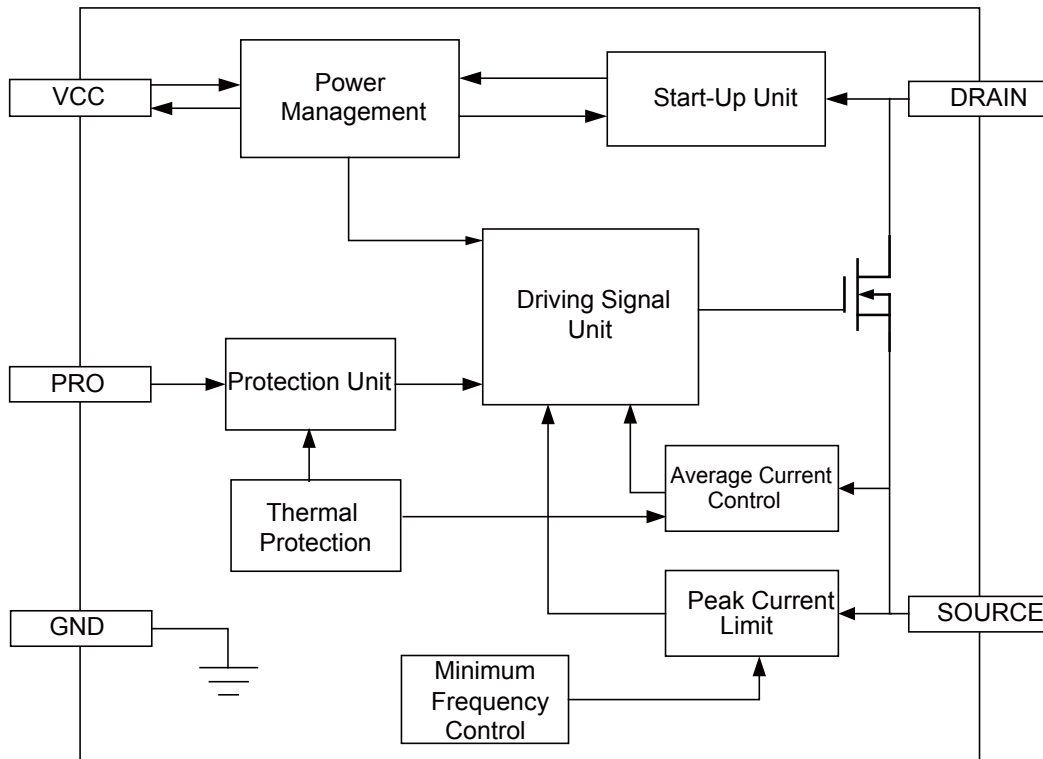

**FIGURE 1. Functional Block Diagram**

## OPERATION

The MP4050A is a non-isolated, cost-effective, high-efficiency converter designed to drive high-brightness LEDs from a universal AC grid input or DC input. As shown in the typical application diagram (see Fig. 1), the regulator is designed to operate with a minimum number of external components.

### Start-Up and Under-Voltage Lockout (UVLO)

Initially, the chip is self-supplied by the internal high-voltage VCC regulator (which is drawn from DRAIN). The IC starts switching and the internal high-voltage regulator turns off as soon as the VCC reaches  $V_{CCOFF}$ . When VCC drops below  $V_{CCON}$ , the internal high-voltage regulator turns on again to charge the external VCC capacitor. Finally, VCC is regulated at  $V_{CCNOR}$  for normal operation.

A small capacitor with several  $\mu F$  capacitances is enough to hold on to the VCC supply voltage. Also, a smaller capacitor reduces component cost. When VCC drops below  $V_{CCSTOP}$ , the IC stops working and the internal high-voltage regulator re-charges the VCC capacitor.

When fault conditions occur (such as open LED protection or over-temperature protection), the MP4050A stops working, and an  $18\mu A$  internal sink current source discharges the VCC capacitor. After VCC drops below  $V_{CCPRO}$ , the internal high-voltage regulator recharges the VCC capacitor again. The re-start time can be calculated by the following equation,

$$t_{RESTART} = C_{VCC} \times \frac{V_{CCNOR} - V_{CCPRO}}{18\mu A} + C_{VCC} \times \frac{V_{CCOFF} - V_{CCPRO}}{5mA}$$

Fig. 2 shows the typical waveforms with VCC under-voltage lockout.

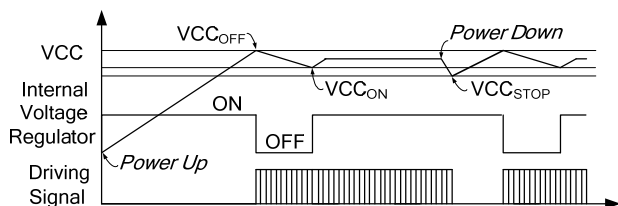

**FIGURE 2. VCC Under-Voltage Lockout (UVLO)**

### Constant-Current Operation

The MP4050A is a fully integrated regulator. The internal feedback logic responds to the internal sample and hold circuit to achieve constant output-current regulation. The voltage of the internal sampling capacitor ( $V_{FB}$ ) is compared to the internal reference ( $V_{REF}$ ) when the sampling capacitor voltage ( $V_{FB}$ ) falls below the reference voltage (which indicates an insufficient output current). Then the integrated MOSFET is turned on. The on period is determined by the peak current limit. After the on period elapses, the integrated MOSFET is turned off (see Fig. 3).

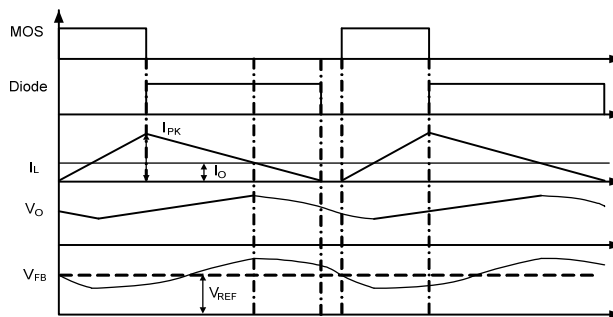

**FIGURE 3.  $V_{FB}$  vs.  $I_{OUT}$**

Thus, by monitoring the internal sampling capacitor voltage, the output current can be regulated. The output current is determined by the following equation:

$$I_{OUT} = \frac{V_{REF}}{R_S}$$

The peak inductor current at normal operation can be obtained with the following equation:

$$I_{PK} = \frac{V_{LIMIT}}{R_S}$$

Where  $R_S$  is the sensing resistance connected from SOURCE to GND.

### Minimum Operating Frequency Limit

The MP4050A incorporates a minimum operating frequency (22kHz) to eliminate audible noise.

When the operating frequency is less than 22kHz, the internal peak-current regulator decreases the peak-current value to keep the operating frequency constant at about 22kHz.

If the inductance is too large to make the operating frequency drop to the minimum operating frequency, the converter enters CCM operation. Generally, the converter works in DCM when the operating frequency is larger than 22kHz for normal operation.

### Minimum Off-Time Limit

A minimum off-time limit is implemented. During normal operation, the minimum off-time limit is 4.7μs. During the start-up period, the minimum off-time limit is shortened gradually from 16.45μs to 4.7μs (see Fig. 4). Each minimum off-time limit maintains 32 switching cycles. This soft-start function enables a safe start-up.

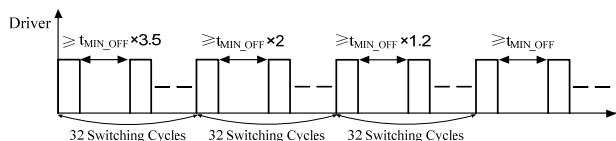

**FIGURE 4. Minimum Off-Time Limit at**

**Start-up**

### Thermal Shutdown (TSD)

To prevent thermal damage to the system and IC, the chip reduces the reference to decrease the output power if the junction temperature exceeds 145°C. This limits the rising temperature speed of the IC. Typically, the reference voltage drops to around 20% when the junction temperature rises to 160°C. If the temperature exceeds 160°C, the MP4050A stops switching, and the IC is latched off. Once the junction temperature drops below 110°C, the chip resumes operation.

### Open LED Protection (OLP)

If PRO voltage ( $V_{PRO}$ ) is higher than  $V_{OVP}$  when the MOSFET turns off, the MP4050A stops working, and a re-start cycle begins. Open LED protection operates in hiccup mode. The MP4050A monitors the PRO voltage continuously, and the VCC cap is discharged and charged repeatedly. The MP4050A resumes work once the fault disappears.

### Short-Circuit Protection (SCP)

When an LED short circuit occurs, the switching off time is extended. Due to the minimum operating frequency limit, the IC can reduce automatically the switching frequency and achieve close loop control. Then the output power at this condition is limited within a safe range. The MP4050A resumes work in normal operation once the device recovers from the short circuit.

### Leading Edge Blanking (LEB)

Internal leading edge blanking (LEB) is employed to prevent a switching pulse from terminating prematurely due to parasitic capacitance discharging when the MOSFET turns on. During the blanking time, the path from SOURCE to the current comparator input is blocked (see Fig. 5)

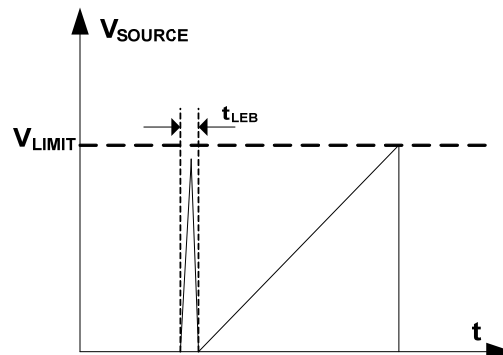

**FIGURE 5. Leading Edge Blanking (LEB)**

## APPLICATION INFORMATION

### Component Selection

#### Input Capacitor

The input capacitor is used to supply DC input voltage to the converter. Fig. 6 shows the typical DC bus voltage waveform of a full-bridge rectifier.

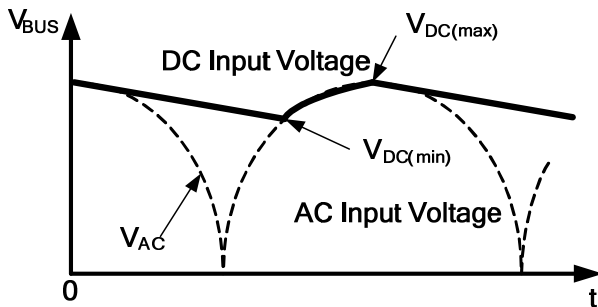

**FIGURE 6. Input Voltage Waveform**

When a full-bridge rectifier is used, the input capacitor is set usually as  $2\mu\text{F}/\text{W}$  for the universal input range. With a low-power output, the half-bridge rectifier can be used with a bigger capacitor.

Very low DC input voltage causes thermal problems in LED applications with buck topology. The minimum DC voltage is limited by the maximum duty cycle of the MP4050A as follows:

$$V_{\text{DC(MIN)}} > \frac{V_{\text{O}} \cdot (t_{\text{ON\_MAX}} + t_{\text{OFF\_MIN}})}{t_{\text{ON\_MAX}}}$$

#### Inductor

The MP4050A has a minimum off-time limit and maximum on-time limit. Both time limits affect the inductance. The maximum and minimum inductance values can be obtained as follows:

$$L_{\text{m}} < L_{\text{MAX}} = \frac{(V_{\text{DC(MIN)}} - V_{\text{O}}) \cdot t_{\text{ON\_MAX}}}{I_{\text{PK}}}$$

$$L_{\text{m}} > L_{\text{MIN}} = \frac{V_{\text{O}} \cdot t_{\text{OFF\_MIN}}}{I_{\text{PK}}}$$

If the inductance is too large, the converter enters CCM, and the frequency drops to the minimum operating frequency. If this occurs, the reverse recovery of the freewheeling diode results in more power loss. Normally, it's better to have the converter operate in DCM. The following expression calculates the limit of the minimum operating frequency:

$$L_{\text{m}} < \frac{2 \cdot I_{\text{O}}}{f_{\text{SW\_MIN}} \cdot \left( \frac{1}{V_{\text{DC(MIN)}} - V_{\text{O}}} + \frac{1}{V_{\text{O}}} \right) \cdot I_{\text{PK}}^2}$$

#### Freewheeling Diode

The diode's maximum reverse-voltage rating is higher than the maximum input voltage. The current rating of the diode is determined by the output current (which is larger than 1.5 to 2 times the output current).

Slow recovery diodes cause excessive leading edge current spikes during start-up. The long reverse-recovery time of the freewheeling diode affects efficiency and the operation of the system. An ultrafast diode ( $t_{\text{rr}} < 75\text{ns}$ ), such as WUGC10JH or EGC10GH, is recommended.

#### Output Capacitor

An output capacitor is required to filter the inductance current and maintain the DC output voltage.

The output-current ripple is reduced by using a bigger output capacitor. A low ESR capacitor is necessary in low-temperature applications.

If the output-voltage ripple is limited, ceramic, tantalum, or low ESR electrolytic capacitors are recommended. The output-voltage ripple can be estimated by the following equations:

$$V_{\text{CCM\_Ripple}} = \frac{\Delta i}{8f_{\text{SW}}C_{\text{O}}} + \Delta i \cdot R_{\text{ESR}} \quad \text{in CCM}$$

$$V_{\text{DCM\_Ripple}} = \frac{I_{\text{O}}}{f_{\text{SW}}C_{\text{O}}} \cdot \left( \frac{I_{\text{PK}} - I_{\text{O}}}{I_{\text{PK}}} \right)^2 + I_{\text{PK}} \cdot R_{\text{ESR}} \quad \text{in DCM}$$

### Sensing Resistor

Choose an appropriate sensing resistor for good output-current regulation. The right resistor guarantees stable output-current regulation in high/low temperature conditions. The sensing resistor should have 1% tolerance. Placing two 1% tolerance sensing resistors in parallel further improves the resistance error. A resistor with a  $\pm 400\text{PPM}/^\circ\text{C}$  temperature coefficient can be used for better output-current regulation in high/low temperature conditions.

### PRO Feedback Resistor Divider

The PRO feedback resistor divider is used to detect an over-voltage fault condition. Fig. 7 shows the PRO feedback resistor divider's connection.

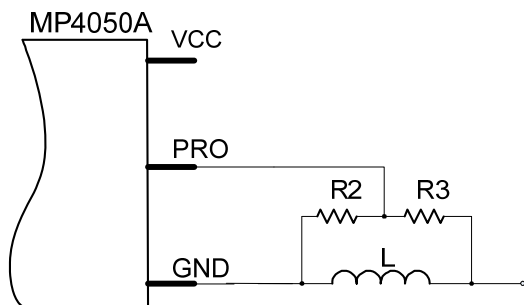

**FIGURE 7. PRO Feedback Resistor Divider**

The over-voltage protection threshold can be calculated with the following equation:

$$V_{\text{OUT\_OVP}} = V_{\text{OVP}} \cdot \frac{R2 + R3}{R2} - V_D$$

Where  $V_D$  is the freewheeling diode forward voltage drop.

The upper feedback resistor (R3) should be larger than 100kΩ to avoid an efficiency reduction in the application. A 1% tolerance type is recommended to achieve accurate protection when open LED occurs.

R2 has a small 0603 package. Taking the voltage rating of the dielectric into consideration, R3 is recommended to have a minimum 1206 package.

### Dummy Load

The dummy load is used to consume the power transferred to the output capacitor in OVP hiccup mode without any power consumption.

Normally, a dummy load less than 1mA is recommended. A dummy load less than 1mA does not deteriorate system efficiency and also guarantees normal, open LED protection.

### PRO Decoupling Capacitor

The floating GND is sensitive to the voltage noise spike in a high-side buck solution. Generally, the time constraint on the OVP comparator mechanism is sufficient to shield the noise against an open LED fault mistrigger. Sometimes, a decoupling cap is also applied between PRO and GND.

A ceramic capacitor around 30 pF is used in SOIC-8 package applications. For the smaller TSOT23-5 package, no less than a 100pF ceramic capacitor is recommended. Fig. 8 shows the PRO decoupling capacitor connection.

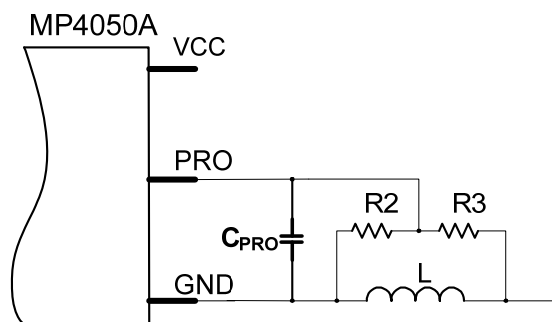

**FIGURE 8. Decoupling Capacitor**

### PRO Time Constant

The MP4050A detects the PRO voltage to judge the open LED condition when internal the MOSEFET turns off. If the PRO decoupling capacitor is connected, the PRO time constant ( $\tau$ ) should satisfy the following expression to guarantee normal open LED protection:

$$\tau = C_{\text{PRO}} \cdot \frac{R2 \cdot R3}{R2 + R3} < 1\mu\text{s}$$

**Power Factor (PF)**

The MP4050A is designed mainly for non-isolated, space constrained, and cost sensitive LED driver solutions. The MP4050A is the best option for the PF>0.5 under 120VAC input requirement. The input capacitance is reduced to achieve the highest possible power factor as PF>0.7 @ 120VAC and PF>0.5 @ 230VAC (if the output-current regulation is not limited).

**Surge**

Select the appropriate input capacitance to obtain good surge performance. With the input capacitor C2 (4.7µF) and C3 (4.7µF) in Fig. 11, the board can pass a 1kV differential input line 1.2/50µs surge test (IEC61000-4-5). It is recommended to increase the input capacitor value to suppress a surge test above 1kV. As for the high PF required, applications with lower input capacitor values give a greater voltage rise. Typically, a metal oxide varistor (MOV) is required to pass a surge test above 1kV.

Table 1 shows the input capacitor values required to pass the differential surge test.

**TABLE 1. Recommended Input Capacitance**

Surge Voltage	500V	1kV	1.5kV	2kV
C2	3.3µF	4.7µF	4.7µF	Shown in Fig. 9
C3	3.3µF	4.7µF	10µF	

The board can pass the 2kV differential surge test by adopting the circuit setup below (see Fig. 9):

1. Add a MOV RV1 (TVR14431).
2. Add a fuse F1 (SS-5-2A).

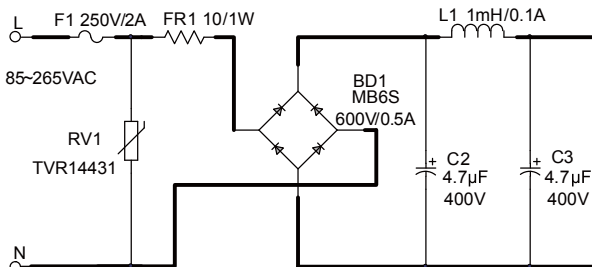

**FIGURE 9. 2kV Surge Solution**

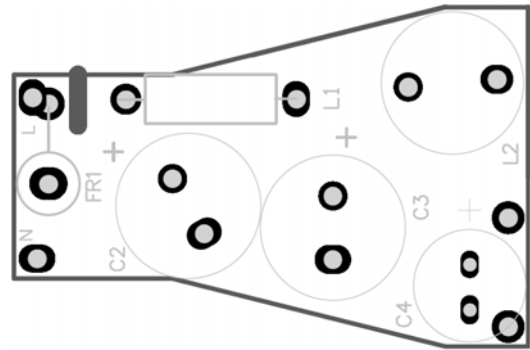

**Top Layer**

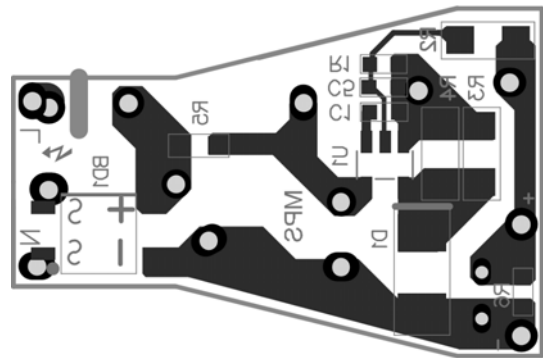

**Bottom Layer**

**Figure 10. Recommended PCB Layout**

**PCB Layout Guidelines**

Efficient PCB layout is critical to achieve reliable operation, good EMI, and good thermal performance, especially in very small sized LED applications. For best results, refer to Fig. 10 and follow the guidelines below:

1. Keep the loop formed between the DRAIN to SOURCE, inductor, freewheeling diode, and output capacitor as small as possible for better EMI.
2. Ensure the AC input is far away from the switching nodes to minimize the noise coupling that may bypass the input filter.
3. Place the VCC and PRO capacitors close to the IC and GND.
4. Place the PRO feedback resistor as close to PRO as possible and minimize the feedback sampling loop to minimize the noise coupling route.



5. Keep the copper area connected to SOURCE short (in the high-side buck topology) to minimize EMI with the thermal constraints of the design (since SOURCE is a switching node).
6. Maximize the connection of the copper area to DRAIN to improve heat sink (since DRAIN is a static node connected to the DC input).



## FLOW CHART

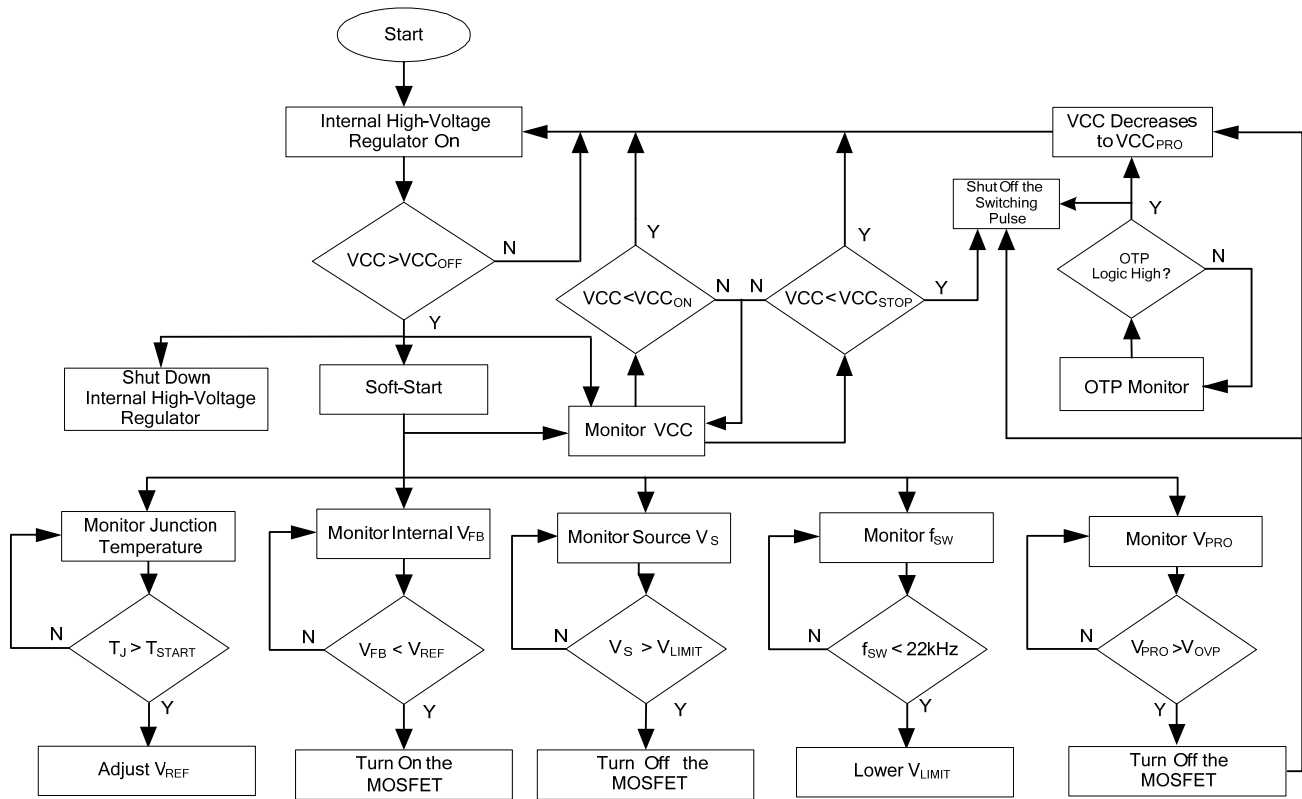

UVLO, OTP, Short-Circuit Protection, Open-LED Protection  
All Protections are Auto-Restart

**FIGURE 12. Control Flow Chart**

**PACKAGE INFORMATION**

**TSOT23-5**

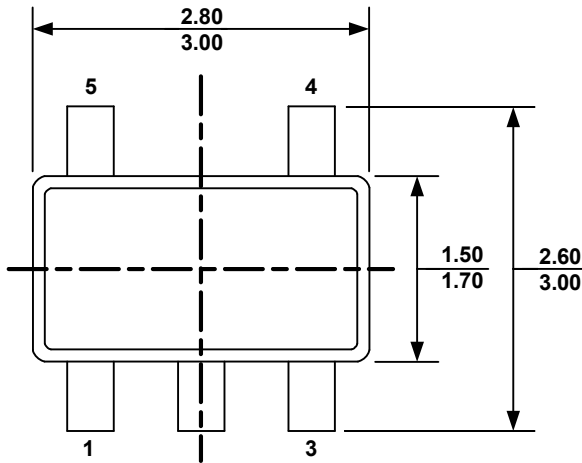

**TOP VIEW**

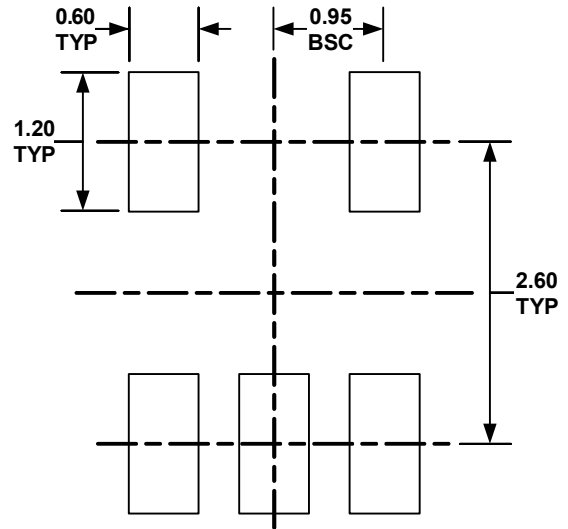

**RECOMMENDED LAND PATTERN**

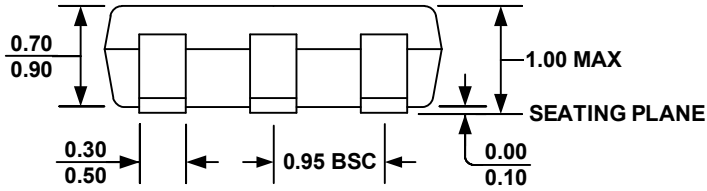

**FRONT VIEW**

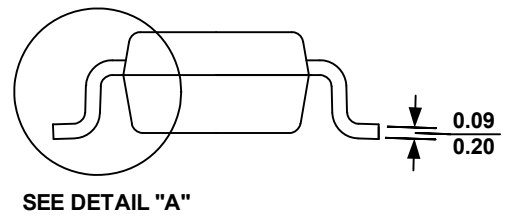

**SIDE VIEW**

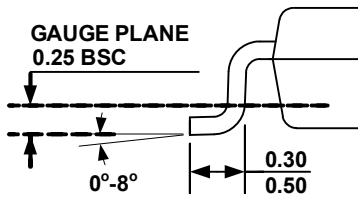

**DETAIL "A"**

**NOTE:**

- 1) ALL DIMENSIONS ARE IN MILLIMETERS
- 2) PACKAGE LENGTH DOES NOT INCLUDE MOLD FLASH, PROTRUSION OR GATE BURR.
- 3) PACKAGE WIDTH DOES NOT INCLUDE INTERLEAD FLASH OR PROTRUSION.
- 4) LEAD COPLANARITY (BOTTOM OF LEADS AFTER FORMING) SHALL BE 0.10 MILLIMETERS MAX
- 5) DRAWING CONFORMS TO JEDEC MO193, VARIATION AA
- 6) DRAWING IS NOT TO SCALE

**PACKAGE INFORMATION** (continued)

**SOIC-8**

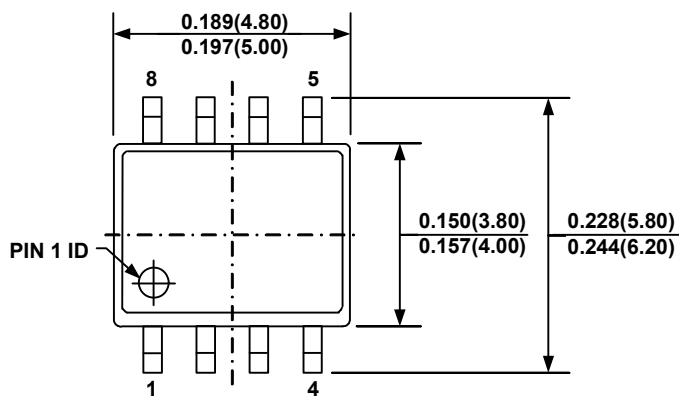

**TOP VIEW**

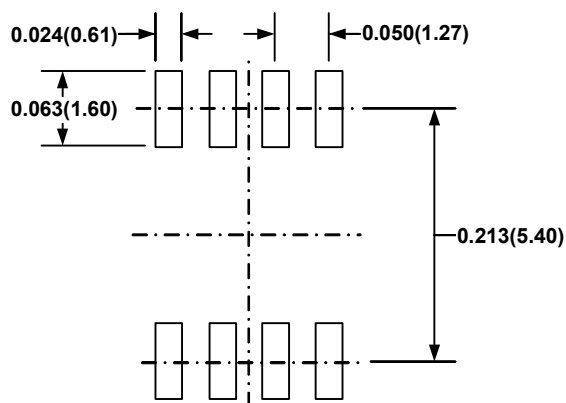

**RECOMMENDED LAND PATTERN**

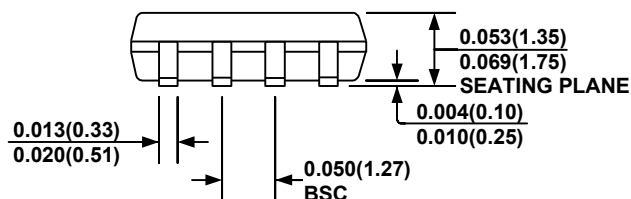

**FRONT VIEW**

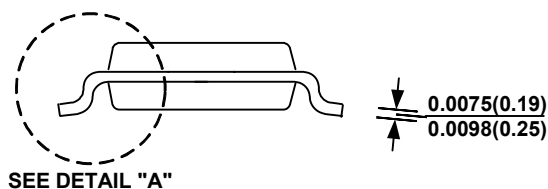

**SIDE VIEW**

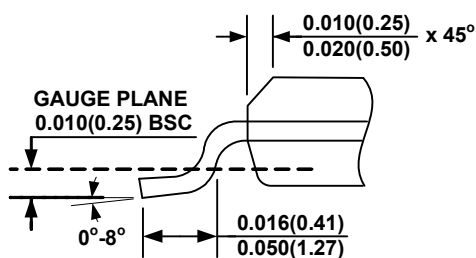

**DETAIL "A"**

**NOTE:**

- 1) CONTROL DIMENSION IS IN INCHES. DIMENSION IN BRACKET IS IN MILLIMETERS.
- 2) PACKAGE LENGTH DOES NOT INCLUDE MOLD FLASH, PROTRUSIONS OR GATE BURRS.
- 3) PACKAGE WIDTH DOES NOT INCLUDE INTERLEAD FLASH OR PROTRUSIONS.
- 4) LEAD COPLANARITY (BOTTOM OF LEADS AFTER FORMING) SHALL BE 0.004" INCHES MAX.
- 5) DRAWING CONFORMS TO JEDEC MS-012, VARIATION AA.
- 6) DRAWING IS NOT TO SCALE.

**NOTICE:** The information in this document is subject to change without notice. Users should warrant and guarantee that third party Intellectual Property rights are not infringed upon when integrating MPS products into any application. MPS will not assume any legal responsibility for any said applications.



Компания «ЭлектроПласт» предлагает заключение долгосрочных отношений при поставках импортных электронных компонентов на взаимовыгодных условиях!

Наши преимущества:

- Оперативные поставки широкого спектра электронных компонентов отечественного и импортного производства напрямую от производителей и с крупнейших мировых складов;
- Поставка более 17-ти миллионов наименований электронных компонентов;
- Поставка сложных, дефицитных, либо снятых с производства позиций;
- Оперативные сроки поставки под заказ (от 5 рабочих дней);
- Экспресс доставка в любую точку России;
- Техническая поддержка проекта, помощь в подборе аналогов, поставка прототипов;
- Система менеджмента качества сертифицирована по Международному стандарту ISO 9001;
- Лицензия ФСБ на осуществление работ с использованием сведений, составляющих государственную тайну;
- Поставка специализированных компонентов (Xilinx, Altera, Analog Devices, Intersil, Interpoint, Microsemi, Aeroflex, Peregrine, Syfer, Eurofarad, Texas Instrument, Miteq, Cobham, E2V, MA-COM, Hittite, Mini-Circuits, General Dynamics и др.);

Помимо этого, одним из направлений компании «ЭлектроПласт» является направление «Источники питания». Мы предлагаем Вам помощь Конструкторского отдела:

- Подбор оптимального решения, техническое обоснование при выборе компонента;
- Подбор аналогов;
- Консультации по применению компонента;
- Поставка образцов и прототипов;
- Техническая поддержка проекта;
- Защита от снятия компонента с производства.



#### Как с нами связаться

**Телефон:** 8 (812) 309 58 32 (многоканальный)

**Факс:** 8 (812) 320-02-42

**Электронная почта:** [org@eplast1.ru](mailto:org@eplast1.ru)

**Адрес:** 198099, г. Санкт-Петербург, ул. Калинина, дом 2, корпус 4, литера А.