



SAW Components

SAW RX filter

WCDMA band VIII / GSM 900

Series/type:	B9461
Ordering code:	B39941B9461P810
Date:	January 13, 2010
Version:	2.0



Data sheet



Application

- Low-loss RF filter for mobile telephone WCDMA Band VIII and GSM 900 systems, receive path (RX)
- Very high TX suppression - suitable for diversity applications
- Useable passband: 35 MHz
- Unbalanced to balanced operation
- Impedance transformation from 50 Ω to 100 Ω
- Suitable for GPRS class 1 to 12



Features

- Package size 1.4 x 1.1 x 0.4 mm³
- RoHS compatible
- Approximate weight 0.003 g
- Package for **Surface Mount Technology (SMT)**
- Ni, gold-plated terminals
- **Electrostatic Sensitive Device (ESD)**

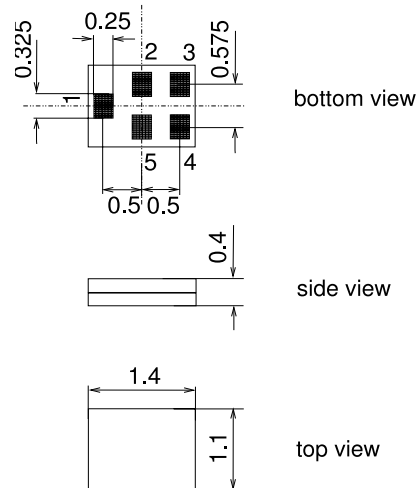

Pin configuration

- 1 Input unbalanced
- 3,4 Output balanced
- 2,5 To be grounded

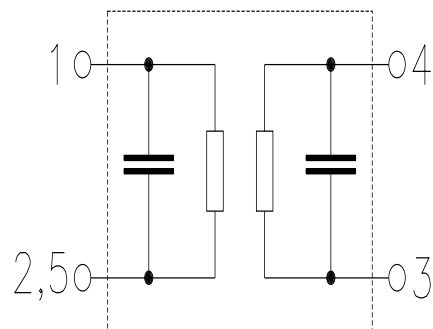



SAW Components

B9461

SAW RX filter

942.5 MHz

Data sheet



Characteristics

Temperature range for specification: T = -20 °C to +85 °C
 Terminating source impedance: Z_S = 50 Ω (unbalanced)
 Terminating load impedance: Z_L = 100 Ω (balanced)

						B9461			
						min.	typ. @ 25 °C	max.	
Center frequency		f _C				—	942.5	—	MHz
Maximum insertion attenuation									
@f _{Carrier Bd 8 RX}	927.4 ... 957.6	MHz	α _{WCDMA} ¹⁾	—	2.6	3.0		dB	
@f _{Carrier Bd 8 RX}	925.7 ... 959.3	MHz	α _{LTE} ²⁾	—	2.7	3.6		dB	
	925.0 ... 960.0	MHz	α _{GSM}	—	2.8	4.0		dB	
Amplitude ripple (p-p)									
	925.0 ... 960.0	MHz	Δα	—	1.5	2.7		dB	
Error Vector Magnitude³⁾									
@f _{Carrier Bd 8 RX}	927.4 ... 957.6	MHz	EVM	—	3.2	6.0		%	
Input VSWR									
	925.0 ... 960.0	MHz		—	2.0	2.2			
Output VSWR									
	925.0 ... 960.0	MHz		—	2.1	2.3			
CMRR (S₂₁-S₃₁ / S₂₁+S₃₁)									
	925.0 ... 960.0	MHz		21	23 ⁴⁾	—		dB	
Attenuation									
	DC ... 880.0	MHz	α	40	59	—		dB	
@f _{Carrier Bd 8 TX}	882.4 ... 912.6	MHz	α _{WCDMA} ¹⁾	50	55	—		dB	
@f _{Carrier Bd 8 TX}	880.7 ... 914.3	MHz	α _{LTE} ²⁾	41	52	—		dB	
	880.0 ... 915.0	MHz	α _{GSM}	35	51	—		dB	
	980.0 ... 1045.0	MHz		24	29	—		dB	
	1045.0 ... 1700.0	MHz		35	51	—		dB	
	1700.0 ... 2600.0	MHz		40	60	—		dB	
	2600.0 ... 2682.0	MHz		45	60	—		dB	
	2682.0 ... 4345.0	MHz		40	53	—		dB	
	4345.0 ... 4470.0	MHz		45	60	—		dB	
	4470.0 ... 6000.0	MHz		45	57	—		dB	

1) Attenuation of WCDMA signal ("Powertransferfunction"). Please refer to annotation on page 7).
 2) Attenuation of LTE signal ("Powertransferfunction"). Please refer to annotation on page (7).
 3) Error Vector Magnitude (EVM) based on definition given in 3GPP TS 25.141.
 4) A CMRR of 22.8 dB corresponds to a phase balance of 5° together an amplitude balance of 1.0 dB



SAW Components

B9461

SAW RX filter

942.5 MHz

Data sheet



Transfer function for WCDMA signals (Powertransferfunction vs. carrier frequency)

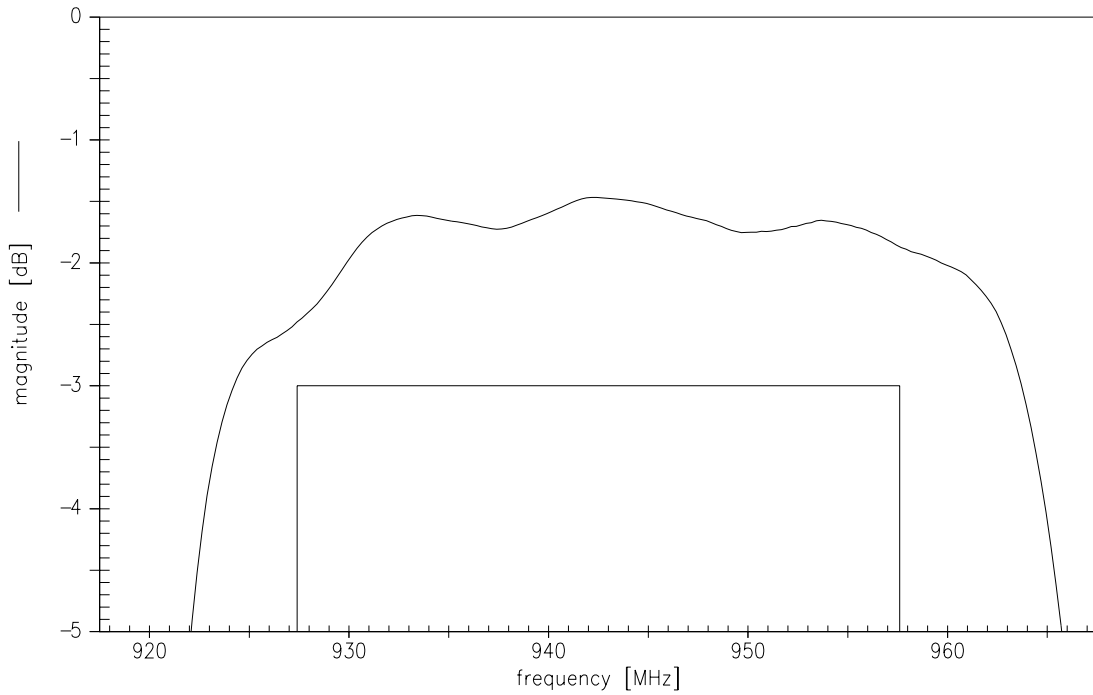

Transfer function for WCDMA signals (Powertransferfunction vs. carrier frequency)

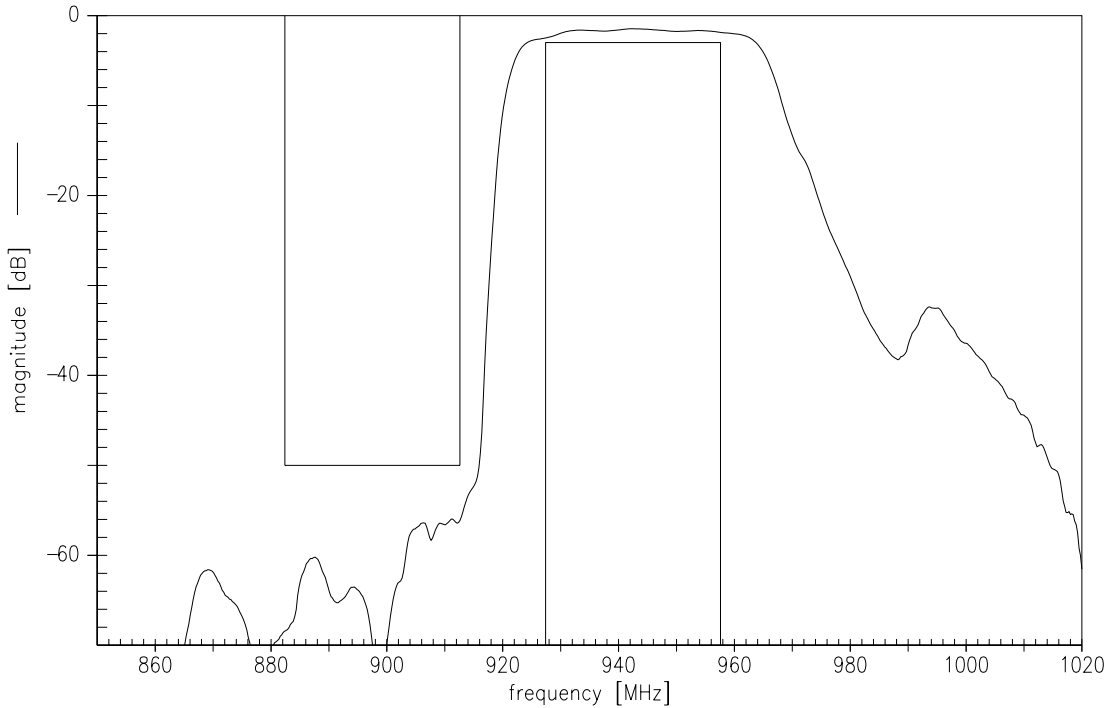

Please read *cautions and warnings* and *important notes* at the end of this document.



SAW Components

B9461

SAW RX filter

942.5 MHz

Data sheet



Transfer function for CW signals

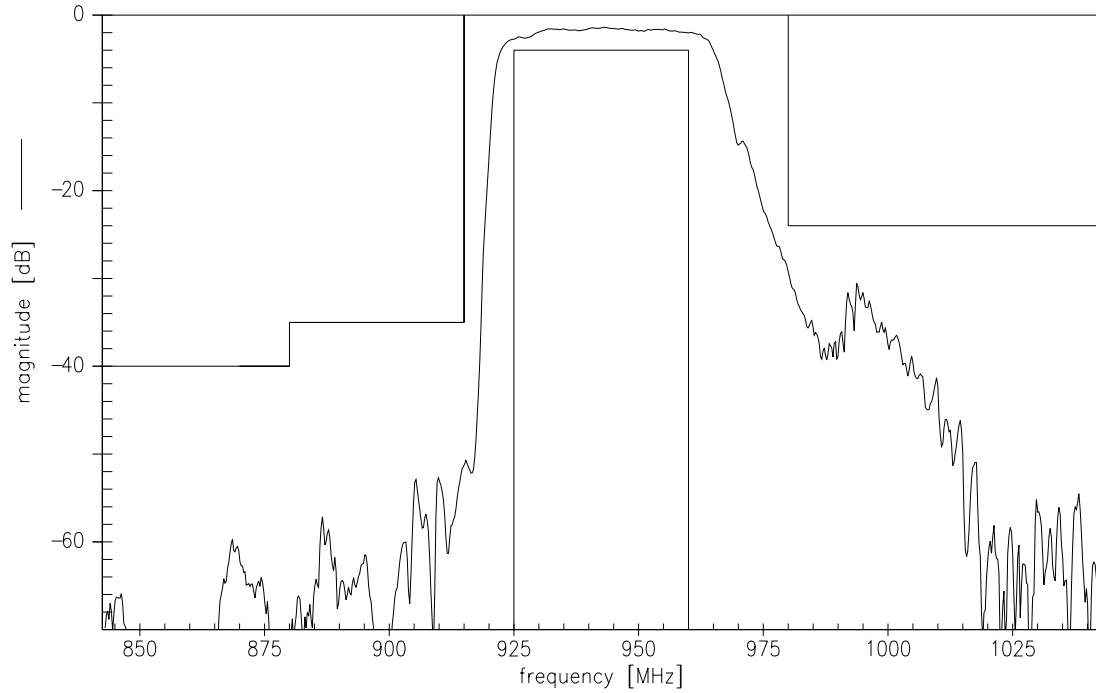

Transfer function for CW signals (wideband)

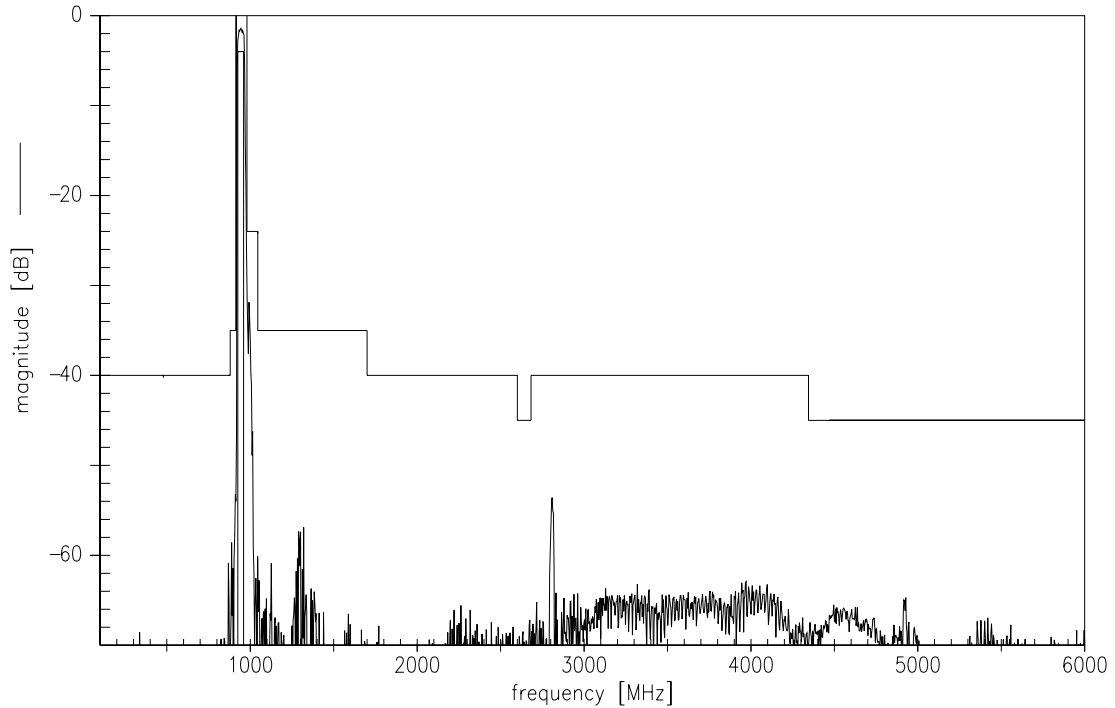

Please read *cautions and warnings and important notes* at the end of this document.



Data sheet



Smith charts

Unbalanced input (pin1)

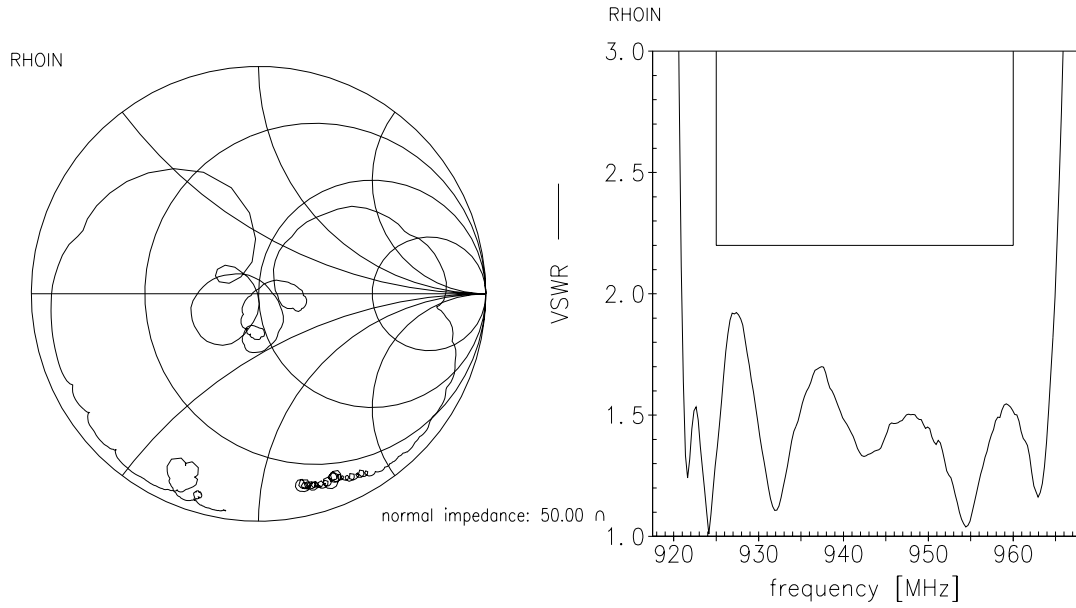

Balanced output (pin3/4)

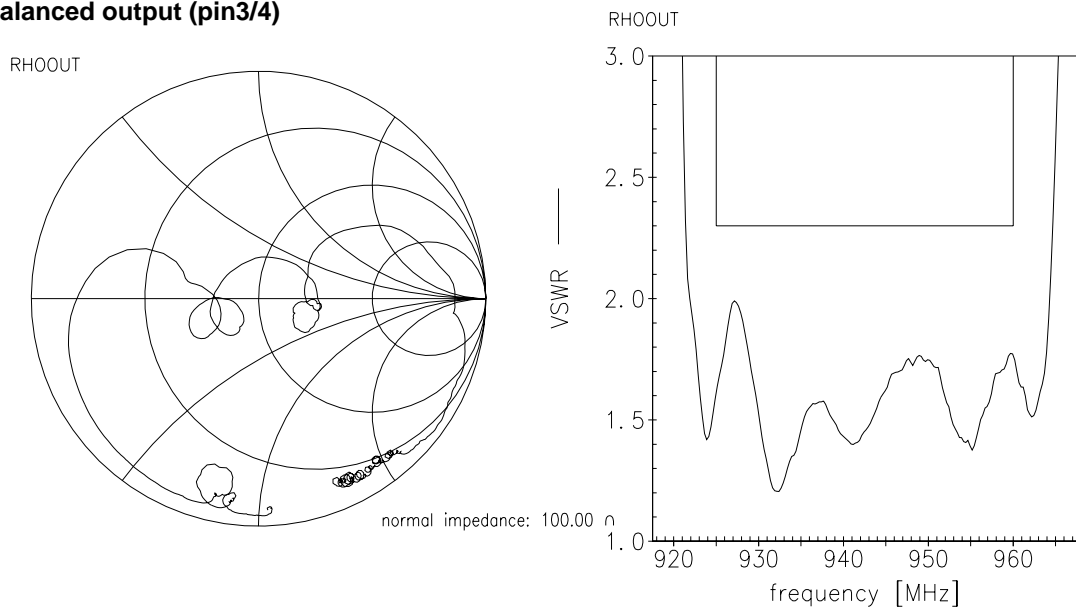



Annotation for characteristics section

Attenuation of WCDMA and LTE signal (“Powertransferfunction”, α_{WCDMA} , α_{LTE}) are determined by

$$\int_{-\infty}^{\infty} |S_{\text{ds21}}(f)H_{\text{RRC}}(f - f_{\text{Carrier}})|^2 df$$

$H_{\text{RRC}}(f)$ is the transfer function of the root-raised cosine transmit pulse shaping filter according to 3GPP TS 25.101 with the following normalization:

$$\int_{-\infty}^{\infty} |H_{\text{RRC}}(f)|^2 df = 1$$

f_{Carrier} of WCDMA signal according to 3GPP TS 25.101 (e.g. for band VIII RX passband, f_{Carrier} ranges from 927.4 MHz (f_{C} of lowest Rx channel) to 957.6 MHz (f_{C} of highest Rx channel)).

f_{Carrier} of LTE signal according to 3GPP TS 36.101 with a channel band width of 1.08 MHz (equals 6 Resource Blocks) and a guard band of 0.16 MHz (e.g. for band VIII RX passband, f_{Carrier} ranges from 925.7 MHz (f_{C} of lowest Rx channel) to 959.3 MHz (f_{C} of highest Rx channel)).

Maximum ratings

Operable temperature range	T	-40/+85	°C	
Storage temperature range	T _{stg}	-40/+85	°C	
DC voltage	V _{DC}	5	V	
ESD voltage	V _{ESD}	100 ¹⁾	V	machine model, 10 pulses
Input power	P _{IN}	17	dBm	10000h @ 55°C

¹⁾ acc. to JESD22-A115A (machine model), 10 negative & 10 positive pulses.



SAW Components	B9461
SAW RX filter	942.5 MHz
Data sheet	

References

Type	B9461
Ordering code	B39941B9461P810
Marking and package	C61157-A8-A3
Packaging	F61074-V8237-Z000
Date codes	L_1126
S-parameters	B9461_NB.s3p B9461_WB.s3p See file header for port/pin assignment table.
Soldering profile	S_6001
RoHS compatible	defined as compatible with the following documents: "DIRECTIVE 2002/95/EC OF THE EUROPEAN PARLIAMENT AND OF THE COUNCIL of 27 January 2003 on the restriction of the use of certain hazardous substances in electrical and electronic equipment. 2005/618/EC from April 18th, 2005, amending Directive 2002/95/EC of the European Parliament and of the Council for the purposes of establishing the maximum concentration values for certain hazardous substances in electrical and electronic equipment."

For further information please contact your local EPCOS sales office or visit our webpage at www.epcos.com.

Published by EPCOS AG
Surface Acoustic Wave Components Division
P.O. Box 80 17 09, 81617 Munich, GERMANY

© EPCOS AG 2010. This brochure replaces the previous edition.

For questions on technology, prices and delivery please contact the Sales Offices of EPCOS AG or the international Representatives.

Due to technical requirements components may contain dangerous substances. For information on the type in question please also contact one of our Sales Offices.

Please read *cautions and warnings and important notes* at the end of this document.



Important notes

The following applies to all products named in this publication:

1. Some parts of this publication contain **statements about the suitability of our products for certain areas of application**. These statements are based on our knowledge of typical requirements that are often placed on our products in the areas of application concerned. We nevertheless expressly point out **that such statements cannot be regarded as binding statements about the suitability of our products for a particular customer application**. As a rule, EPCOS is either unfamiliar with individual customer applications or less familiar with them than the customers themselves. For these reasons, it is always ultimately incumbent on the customer to check and decide whether an EPCOS product with the properties described in the product specification is suitable for use in a particular customer application.
2. We also point out that **in individual cases, a malfunction of electronic components or failure before the end of their usual service life cannot be completely ruled out in the current state of the art, even if they are operated as specified**. In customer applications requiring a very high level of operational safety and especially in customer applications in which the malfunction or failure of an electronic component could endanger human life or health (e.g. in accident prevention or life-saving systems), it must therefore be ensured by means of suitable design of the customer application or other action taken by the customer (e.g. installation of protective circuitry or redundancy) that no injury or damage is sustained by third parties in the event of malfunction or failure of an electronic component.
3. **The warnings, cautions and product-specific notes must be observed.**
4. In order to satisfy certain technical requirements, **some of the products described in this publication may contain substances subject to restrictions in certain jurisdictions (e.g. because they are classed as hazardous)**. Useful information on this will be found in our Material Data Sheets on the Internet (www.epcos.com/material). Should you have any more detailed questions, please contact our sales offices.
5. We constantly strive to improve our products. Consequently, **the products described in this publication may change from time to time**. The same is true of the corresponding product specifications. Please check therefore to what extent product descriptions and specifications contained in this publication are still applicable before or when you place an order. We also **reserve the right to discontinue production and delivery of products**. Consequently, we cannot guarantee that all products named in this publication will always be available. The aforementioned does not apply in the case of individual agreements deviating from the foregoing for customer-specific products.
6. Unless otherwise agreed in individual contracts, **all orders are subject to the current version of the "General Terms of Delivery for Products and Services in the Electrical Industry" published by the German Electrical and Electronics Industry Association (ZVEI)**.
7. The trade names EPCOS, BAOKE, Alu-X, CeraDiode, CSMP, CSSP, CTVS, DeltaCap, DigiSiMic, DSSP, MiniBlue, MiniCell, MKK, MLSC, MotorCap, PCC, PhaseCap, PhaseCube, PhaseMod, PhiCap, SIFERRIT, SIFI, SIKOREL, SilverCap, SIMDAD, SiMic, SIMID, SineFormer, SIOV, SIP5D, SIP5K, ThermoFuse, WindCap are **trademarks registered or pending** in Europe and in other countries. Further information will be found on the Internet at www.epcos.com/trademarks.



Компания «ЭлектроПласт» предлагает заключение долгосрочных отношений при поставках импортных электронных компонентов на взаимовыгодных условиях!

Наши преимущества:

- Оперативные поставки широкого спектра электронных компонентов отечественного и импортного производства напрямую от производителей и с крупнейших мировых складов;
- Поставка более 17-ти миллионов наименований электронных компонентов;
- Поставка сложных, дефицитных, либо снятых с производства позиций;
- Оперативные сроки поставки под заказ (от 5 рабочих дней);
- Экспресс доставка в любую точку России;
- Техническая поддержка проекта, помощь в подборе аналогов, поставка прототипов;
- Система менеджмента качества сертифицирована по Международному стандарту ISO 9001;
- Лицензия ФСБ на осуществление работ с использованием сведений, составляющих государственную тайну;
- Поставка специализированных компонентов (Xilinx, Altera, Analog Devices, Intersil, Interpoint, Microsemi, Aeroflex, Peregrine, Syfer, Eurofarad, Texas Instrument, Miteq, Cobham, E2V, MA-COM, Hittite, Mini-Circuits, General Dynamics и др.);

Помимо этого, одним из направлений компании «ЭлектроПласт» является направление «Источники питания». Мы предлагаем Вам помощь Конструкторского отдела:

- Подбор оптимального решения, техническое обоснование при выборе компонента;
- Подбор аналогов;
- Консультации по применению компонента;
- Поставка образцов и прототипов;
- Техническая поддержка проекта;
- Защита от снятия компонента с производства.



Как с нами связаться

Телефон: 8 (812) 309 58 32 (многоканальный)

Факс: 8 (812) 320-02-42

Электронная почта: org@eplast1.ru

Адрес: 198099, г. Санкт-Петербург, ул. Калинина, дом 2, корпус 4, литера А.