

## Specification

Part No.	:	<b>FMA459.A.LBFCG.001</b>
Product Name	:	Storm Response FMA459 5in1 Permanent Mount Antenna LTE + FirstNet + Wi-Fi MIMO*2 + GNSS
Features	:	Aerodynamic, super low-profile, vandal resistant housing 1*LTE MIMO 698-960MHz / 1710-2170MHz / 2490-2690MHz / 3300-3600MHz 1*FirstNet(Band 14) 2* Wi-Fi 2.4GHz/5.8GHz 1* GPS-GLONASS-GALILEO-BeiDou L1 Antenna Screw-Mount [Permanent Mount] Worldwide 4G Bands including 3G and 2G IP67 Enclosure Dims: 216*93*31mm 3 Meters Low Loss CFD-200 and RG-174 Cable with SMA(M) & RP-SMA(M) connectors Custom Cables and Connectors Available <b>RoHS Compliant</b>



## 1. Introduction

The Storm Response FMA459 antenna is a world first, a 5in1 low profile, heavy-duty, fully IP67 waterproof external antenna for use in worldwide telematics and IoT applications which require best in class LTE, FirstNet, GNSS, and Wi-Fi performance. Until the arrival of the Storm, achieving high efficiency in LTE and Wi-Fi required the use of large dome antennas typically 80mm+ in height.

However, this unique product, at only 31mm high, delivers powerful worldwide 4G LTE antenna technology plus GPS-GLONASS-GALILEO-BeiDou & FirstNet for next generation location accuracy. The antenna also covers legacy 3G and 2G bands for devices that fallback where 4G is unavailable. Dual-band MIMO Wi-Fi antennas enable high throughput Wi-Fi speeds.

Typical applications include:

- Internet of Things (IoT) Gateways and Routers
- Remote Asset and Pipeline Monitoring
- HD Video over LTE
- First Responder and Emergency Services
- Automotive Vehicle Tracking and Telematics

FirstNet also known as Band 14 or PS-LTE (Public Service LTE) is a dedicated communications tool for First Responders in the US. It is an isolated network for providing faster critical information and data-sharing between blue light service providers and their agencies. New FirstNet devices are being deployed to allow for the multitude of services and applications which will be using the network for the following mission critical applications:

- Computer-aided dispatch (vehicle location)
- EMS Electronic Patient Care Reporting
- Vehicle Mounted RMS/ Citations/ Scanners
- Video Streaming

The recommendation is for FirstNet to augment LMR and not replace it. If the LTE network is not covered then the LMR radio will be used.

This antenna demonstrates extremely high efficiency also ensuring longer Battery life for high RF power handsets.

LTE 4G applications demand high speed data uplink and downlink. High efficiency and high gain antennas are necessary to achieve the required signal to noise ratio and throughput required to solve these challenges. The FMA459 does not require a ground plane. Low loss cables are used to keep efficiency high over long cable lengths. In contrast, smaller MIMO antennas with thinner, poorer quality cables will have much reduced efficiency and isolation, which would lead to a large drop in system throughput or drops, and may not make a system connection at all.

The GPS-GLONASS-GALILEO-BeiDou active antenna has been carefully designed for excellent performance across all L1 bands, leading to higher location accuracy and stability of tracking in urban environments. Cable length and connector types are customizable. Contact your regional Taoglas sales office for support.

Conformity is declared under the following standard: **EN55022 Class B**

This is to declare that the product listed above conform to the EMC directive 2014/30/EU.

## 2. Specification

GPS-GLONASS-GALILEO-BeiDou	
Center Frequency	GPS/GALILEO: 1575.42±1.023MHz GLONASS: 1602±5MHz BeiDou: 1561.098±2.046MHz
Passive Antenna Efficiency(with cable loss)	GPS/GALILEO: 27% GLONASS: 32% BeiDou: 32%
Passive Antenna Average gain(with cable loss)	GPS/GALILEO: -5.5dBi GLONASS: -4.8dBi BeiDou: -4.8dBi
Passive Antenna Peak gain(with cable loss)	GPS/GALILEO: 0.9dBi GLONASS: 0.6dBi BeiDou: 1.0dBi
VSWR	2:1 Max
Impedance	50Ω
Axial Ratio	GPS/GALILEO: <12.48 GLONASS: <12.33 BeiDou: <17.03
Polarization	RHCP
Cable	1 meter RG-316 standard, fully customizable
Connector	SMA(M), standard, fully customizable

LNA and Filter Electrical Properties				
Center Frequency	GPS/GALILEO: 1575.42±1.023MHz GLONASS: 1602±5MHz BeiDou: 1561.098±2.046MHz			
Pout 1dB gain Compression point	-6dBm Min. -2dBm Typ. (1561MHz, 1575.42MHz, 1602MHz)			
Output Impedance	50Ω			
VSWR	<2:1			
Return Loss	10 dB Min.			
LNA Gain, Current Draw, and Noise Figure @ GPS	Voltage	LNA Gain (Typ)	Current Draw(mA) Typ	Noise Figure (Typ)
	Min 1.8V	19dB	5mA	2.4dB
	Typ 3.0V	27dB	10mA	2.7dB
	Max 5.5V	30dB	23mA	3.1dB

Total Specification (Through Antenna, SAW Filter, and LNA)			
Frequency	1561.098±2.046MHz	1575.42±1.023MHz	1602±5MHz
Gain@3V	1561MHz: 29±3dBi	1575.42MHz: 29±3dBi	1602MHz: 32±3dBi
Output Impedance	50Ω		

### 4G/3G/2G LTE Antenna

Frequency (MHz)		LTE700	GSM850	GSM900	DCS	PCS	UMTS1	LTE2600	LTE3500
		698~803	824~894	880~960	1710~1880	1850~1990	1920~2170	2490~2690	3300~3600
Efficiency (%)									
MIMO_1	30cm	41.15	34.38	41.39	65.93	42.47	41.42	44.70	51.91
	1M	38.97	32.83	39.52	60.13	38.74	38.05	40.76	46.02
	2M	36.37	30.12	36.05	53.59	34.14	33.38	35.20	38.94
	3M	33.71	27.94	33.39	47.67	30.17	29.48	30.50	32.97
	5M	29.09	23.78	28.23	37.61	23.68	22.98	22.88	23.62
Average Gain(dBi)									
MIMO_1	30cm	-3.98	-4.65	-3.86	-1.86	-3.77	-3.88	-3.54	-2.87
	1M	-4.22	-4.85	-4.06	-2.26	-4.17	-4.25	-3.94	-3.39
	2M	-4.52	-5.22	-4.46	-2.76	-4.73	-4.82	-4.58	-4.12
	3M	-4.85	-5.55	-4.79	-3.27	-5.26	-5.35	-5.21	-4.84
	5M	-5.48	-6.25	-5.52	-4.30	-6.32	-6.44	-6.45	-6.29
Peak Gain(dBi)									
MIMO_1	30cm	2.05	0.97	2.16	6.88	5.62	4.81	5.37	4.41
	1M	1.85	0.77	1.96	6.48	5.22	4.41	4.97	4.41
	2M	1.55	0.37	1.56	5.98	4.72	3.91	4.37	3.71
	3M	1.25	0.07	1.16	5.48	4.22	3.31	3.77	3.01
	5M	0.55	-0.63	0.46	4.48	3.12	2.31	2.57	1.61
Envelope Correlation Coefficient				All bands <0.3					
Impedance				50Ω					
Polarization				Linear					
VSWR				<3					
Cable				1 meter RG-316 standard, fully customizable					
Connector				SMA(M) standard, fully customizable					

## LTE BANDS

Band Number	LTE / LTE-Advanced / WCDMA / HSPA / HSPA+ / TD-SCDMA		
	Uplink	Downlink	
1	UL: 1920 to 1980	DL: 2110 to 2170	✓
2	UL: 1850 to 1910	DL: 1930 to 1990	✓
3	UL: 1710 to 1785	DL: 1805 to 1880	✓
4	UL: 1710 to 1755	DL: 2110 to 2155	✓
5	UL: 824 to 849	DL: 869 to 894	✓
7	UL: 2500 to 2570	DL: 2620 to 2690	✓
8	UL: 880 to 915	DL: 925 to 960	✓
9	UL: 1749.9 to 1784.9	DL: 1844.9 to 1879.9	✓
11	UL: 1427.9 to 1447.9	DL: 1475.9 to 1495.9	✗
12	UL: 699 to 716	DL: 729 to 746	✓
13	UL: 777 to 787	DL: 746 to 756	✓
14	UL: 788 to 798	DL: 758 to 768	✓
17	UL: 704 to 716	DL: 734 to 746 (LTE only)	✓
18	UL: 815 to 830	DL: 860 to 875 (LTE only)	✓
19	UL: 830 to 845	DL: 875 to 890	✓
20	UL: 832 to 862	DL: 791 to 821	✓
21	UL: 1447.9 to 1462.9	DL: 1495.9 to 1510.9	✗
22	UL: 3410 to 3490	DL: 3510 to 3590	✓
23	UL: 2000 to 2020	DL: 2180 to 2200 (LTE only)	✓
24	UL: 1625.5 to 1660.5	DL: 1525 to 1559 (LTE only)	✗
25	UL: 1850 to 1915	DL: 1930 to 1995	✓
26	UL: 814 to 849	DL: 859 to 894	✓
27	UL: 807 to 824	DL: 852 to 869 (LTE only)	✓
28	UL: 703 to 748	DL: 758 to 803 (LTE only)	✓
29	UL: -	DL: 717 to 728 (LTE only)	✓
30	UL: 2305 to 2315	DL: 2350 to 2360 (LTE only)	✓
31	UL: 452.5 to 457.5	DL: 462.5 to 467.5 (LTE only)	✗
32	UL: -	DL: 1452 - 1496	✗
35		1850 to 1910	✓
38		2570 to 2620	✓
39		1880 to 1920	✓
40		2300 to 2400	✓
41		2496 to 2690	✓
42		3400 to 3600	✓
43		3600 to 3800	✗

\*Covered bands represent an efficiency greater than 20%

## 2.4GHz/5.8GHz Wi-Fi Antenna

Frequency (MHz)		2400~2500	4900~5850
Efficiency (%)			
MIMO_1	30cm	68.43	56.73
	1M	62.41	48.80
	2M	54.36	39.53
	3M	47.34	32.06
	5M	35.91	21.05
MIMO_2	30cm	69.16	50.87
	1M	63.08	43.80
	2M	54.94	35.50
	3M	47.85	28.80
	5M	36.30	18.93
Average Gain(dBi)			
MIMO_1	30cm	-1.66	-2.48
	1M	-2.06	-3.14
	2M	-2.66	-4.05
	3M	-3.26	-4.96
	5M	-4.46	-6.79
MIMO_2	30cm	-1.62	-2.99
	1M	-2.02	-3.64
	2M	-2.62	-4.56
	3M	-3.22	-5.47
	5M	-4.42	-7.30
Peak Gain(dBi)			
MIMO_1	30cm	5.37	6.68
	1M	5.37	6.68
	2M	4.77	5.78
	3M	4.17	4.88
	5M	2.97	3.18
MIMO_2	30cm	4.18	7.99
	1M	4.18	7.39
	2M	3.58	6.49
	3M	2.98	5.59
	5M	1.78	3.79
Envelope Correlation Coefficient	2400-2500MHz <0.3 4900-5850MHz <0.3		
Impedance	50Ω		
Polarization	Linear		
VSWR	< 2		
Cable	1 meter RG-316 standard, fully customizable		
Connector	RP-SMA(M) standard, fully customizable		

## MECHANICAL

Antenna Dimensions	216.24*93.25*30.95mm
Casing	ABS+PC
Base and thread	Nickel Plated Aluminum
Weight (including cable)	1120g
Ingress Protection Rating	IP67
Maximum Assembly Torque	39.2 N-m
<b>ENVIRONMENTAL</b>	
Operation Temperature	-40°C to 85°C
Storage Temperature	-40°C to 90°C
Humidity	Non-condensing 65°C 95% RH



### 3. Antenna Characteristics

#### 3.1. GPS-GLONASS-GALILEO-BeiDou Antenna

##### 3.1.1. Block Diagram (Active Antenna)

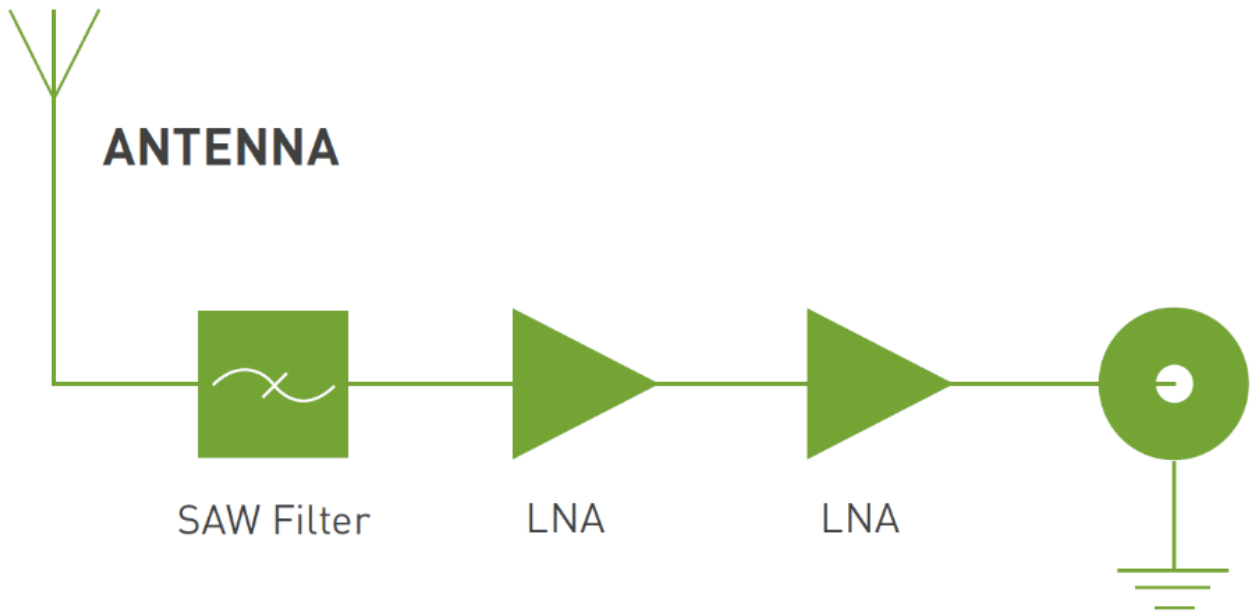

### 3.1.2. Test Setup



XZ Plane

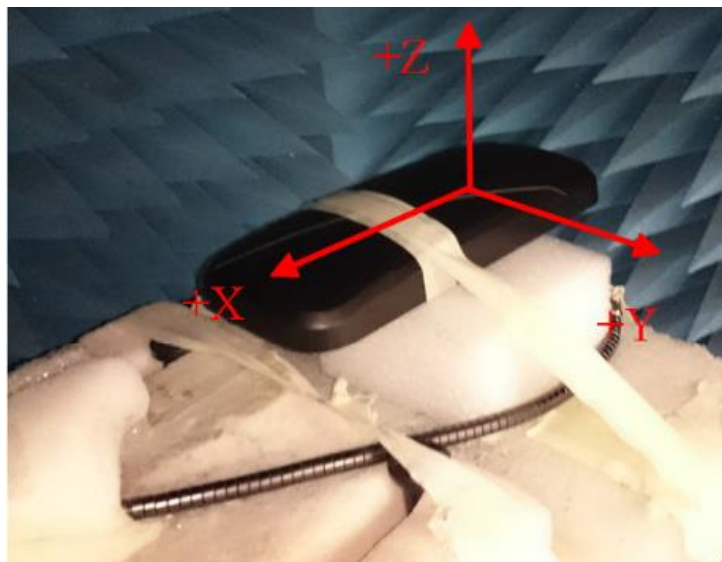

YZ Plane

### 3.1.3. GPS-GLONASS-GALILEO-BeiDou Return Loss (Passive Antenna)

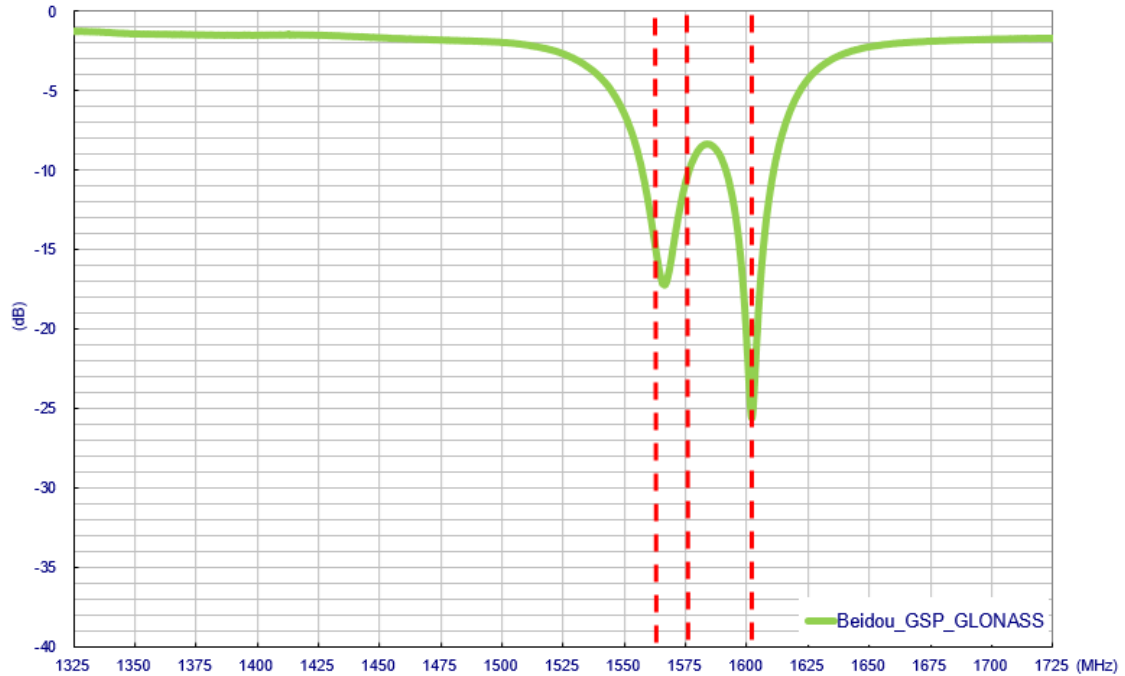

### 3.1.4. GPS-GLONASS-GALILEO-BeiDou VSWR (Passive Antenna)

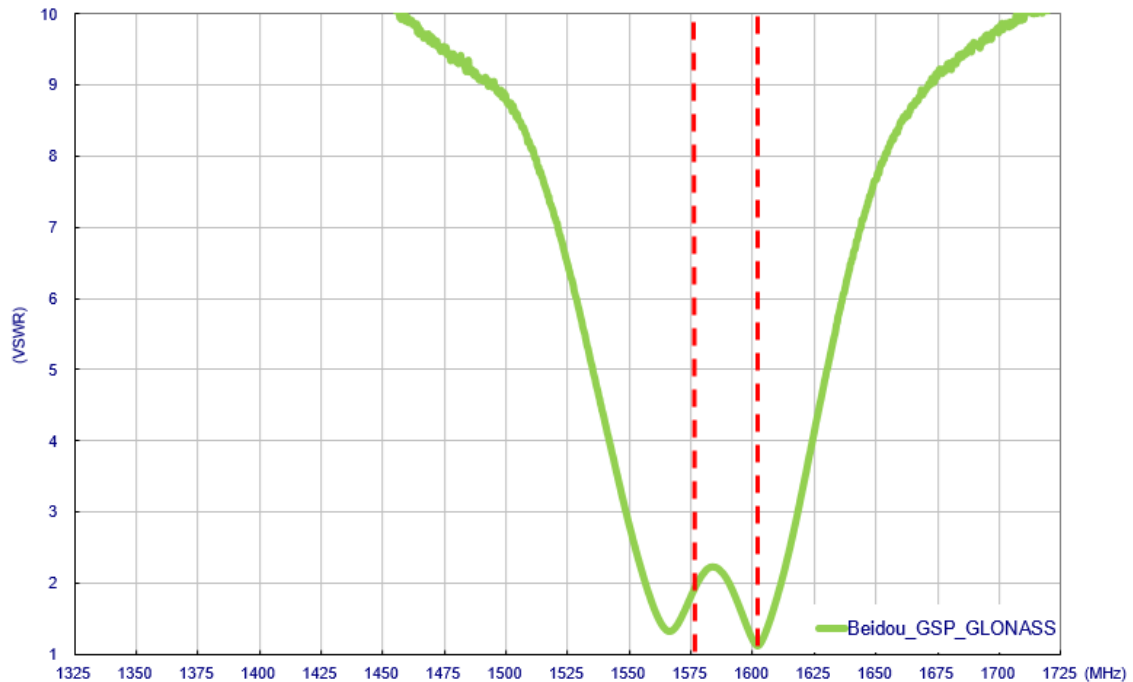

### 3.1.5. GPS-GLONASS-GALILEO-BeiDou Smith Chart (Passive Antenna)

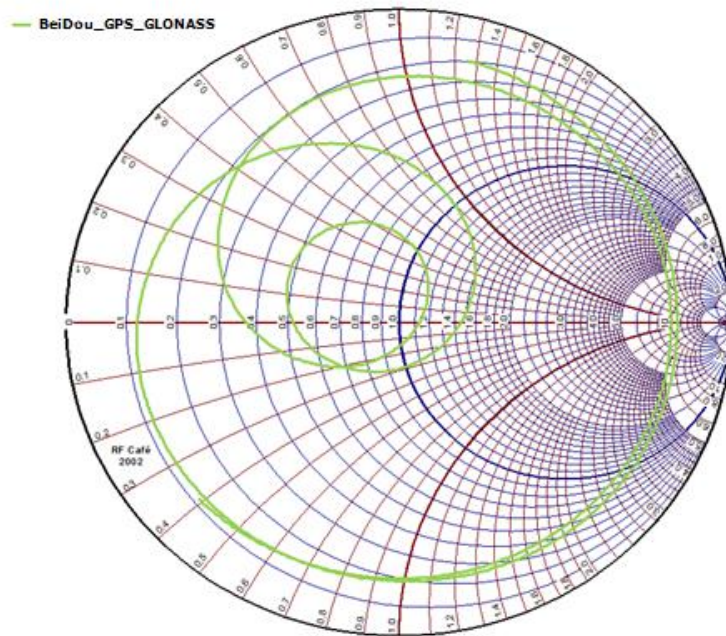

### 3.1.6. GPS-GLONASS-GALILEO-BeiDou Efficiency (Passive Antenna)

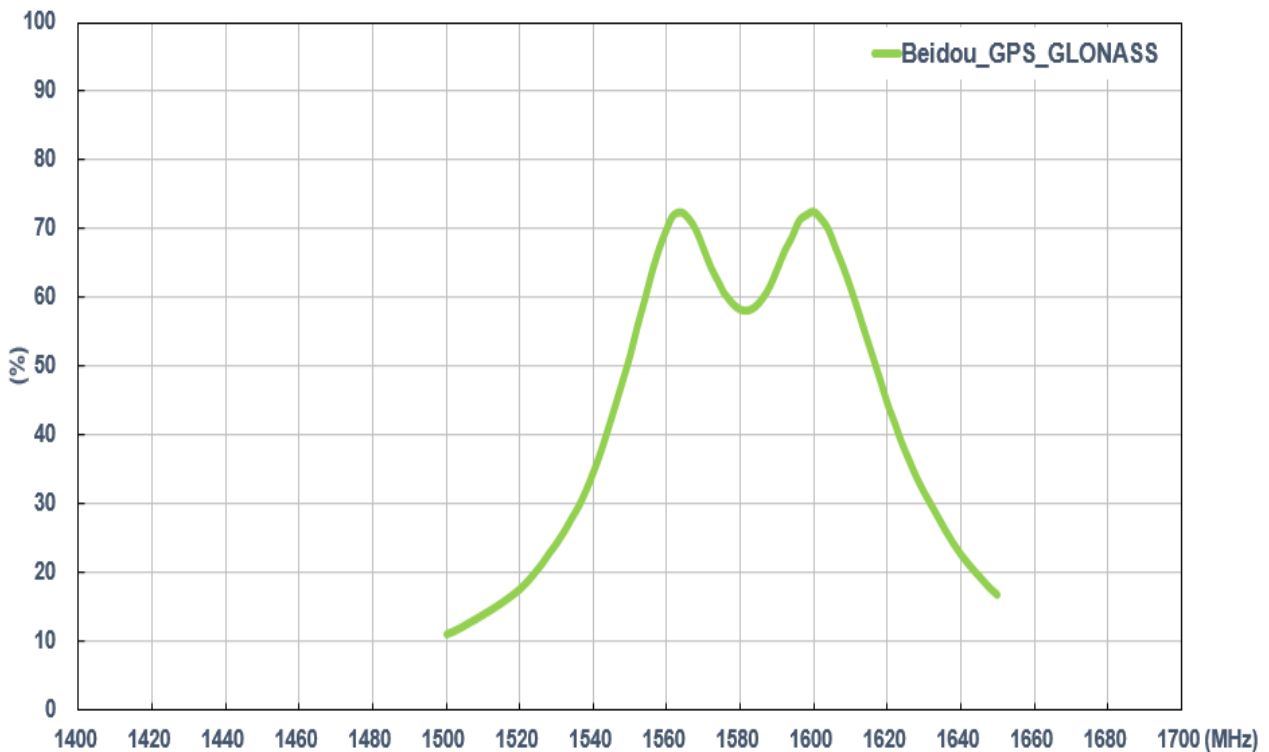

**3.1.7. GPS-GLONASS-GALILEO-BeiDou Average Gain (Passive Antenna)**

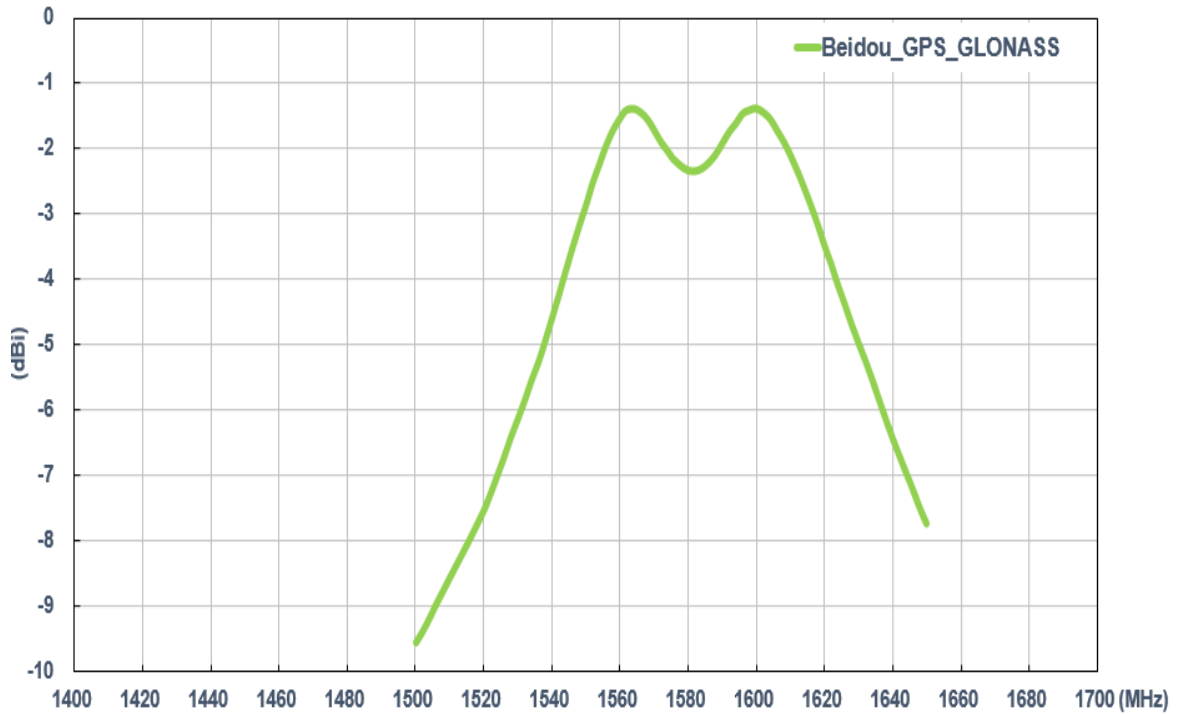

**3.1.8. GPS-GLONASS-GAILEO-BeiDou Peak Gain (Passive Antenna)**

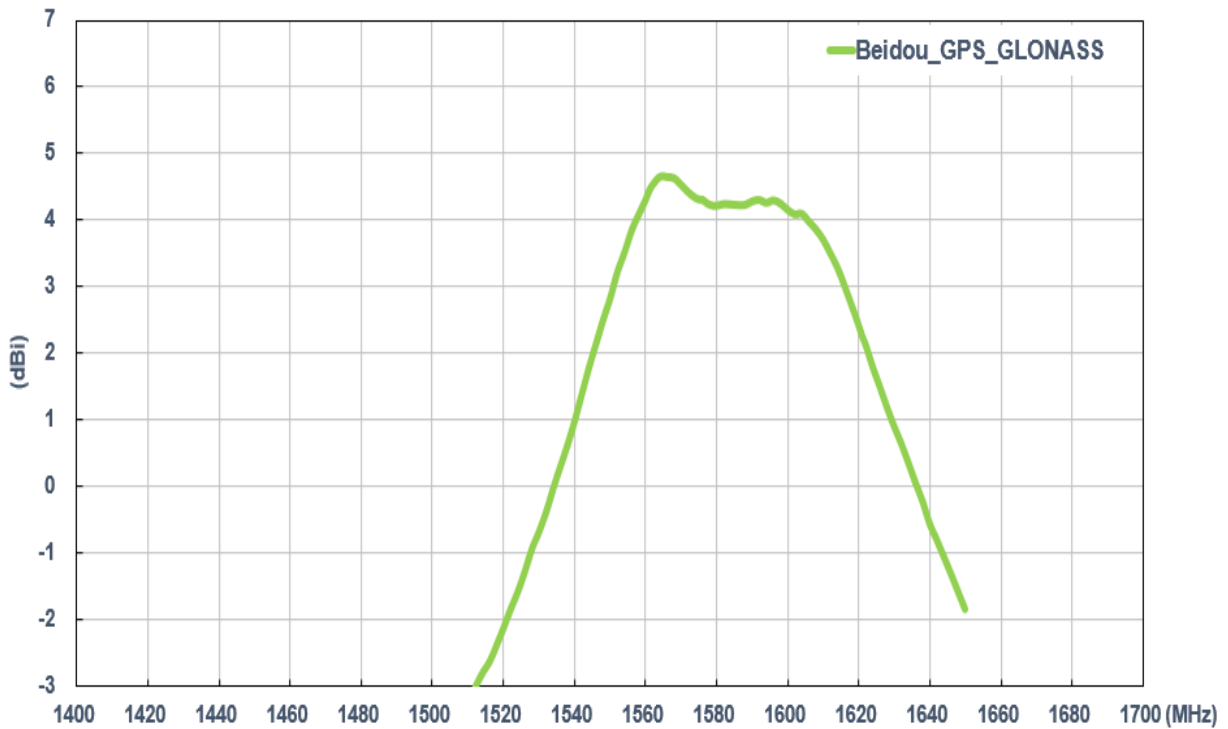

### 3.1.9. GPS-GLONASS-GAILEO-BeiDou Radiation Pattern (Passive Antenna)

2D Radiation pattern

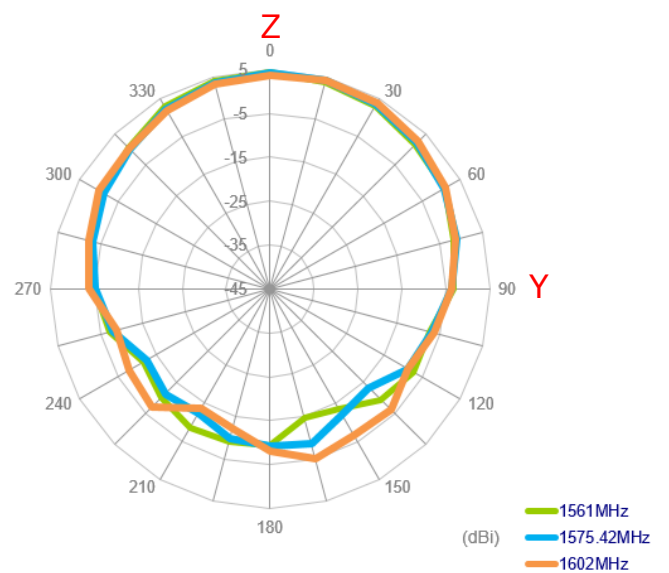
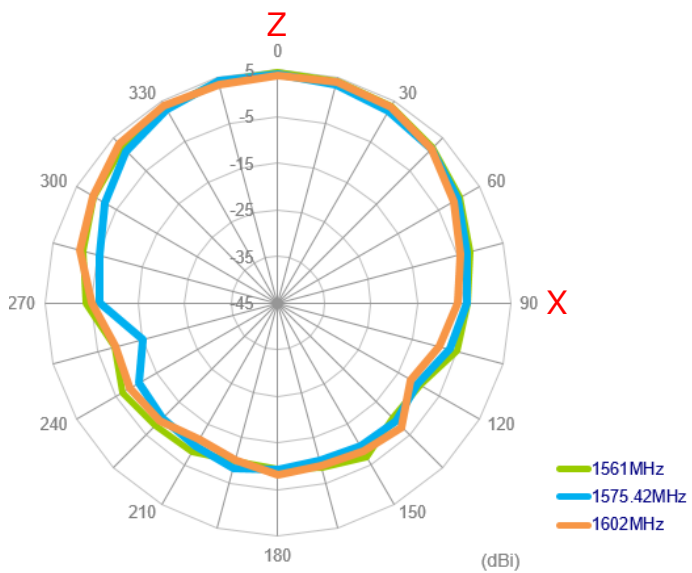
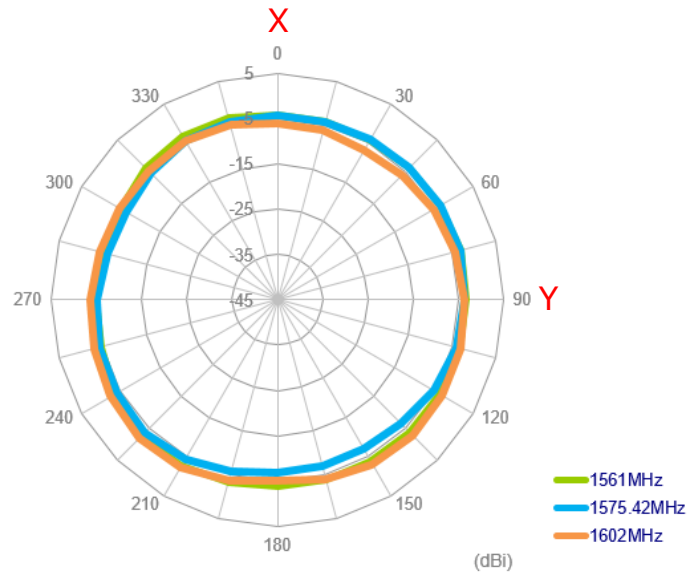

### 3.1.10. 3D Radiation Pattern (Passive antenna)

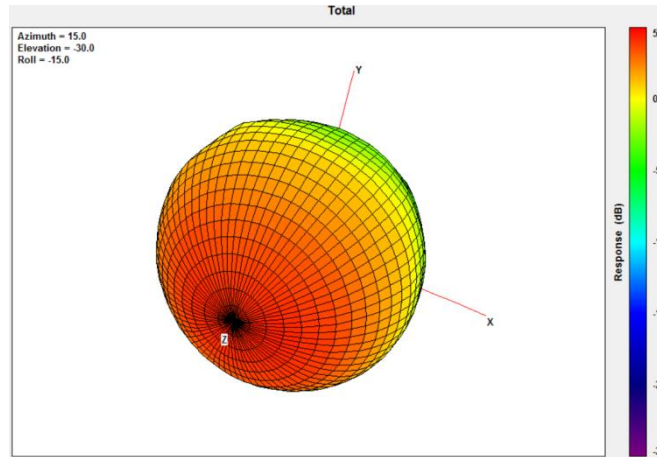

@1561MHz

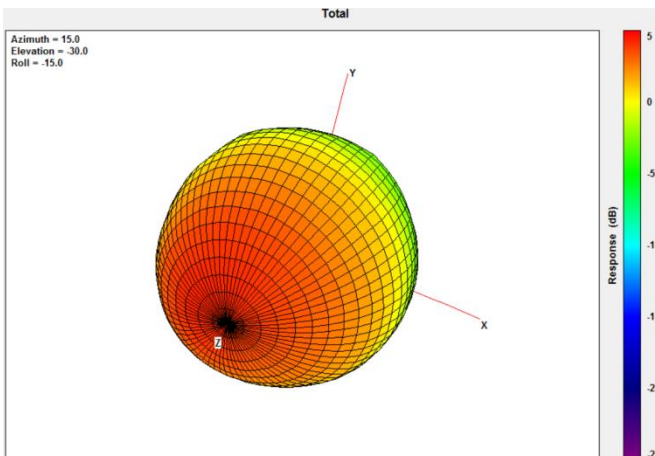

@1575MHz

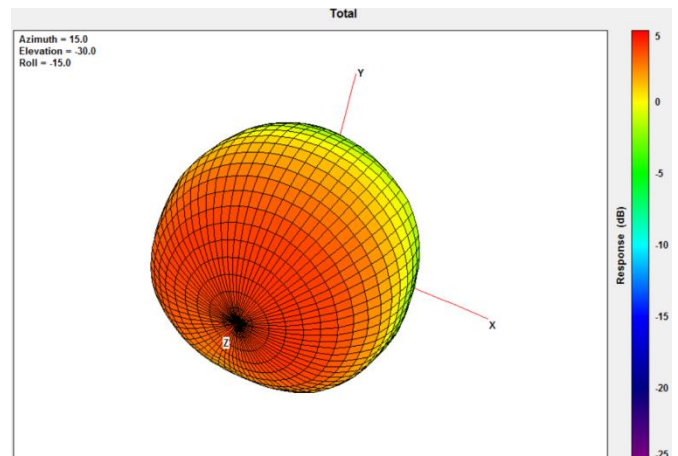

@1602MHz

### 3.1.11. Axial Ratio Pattern (Passive antenna)

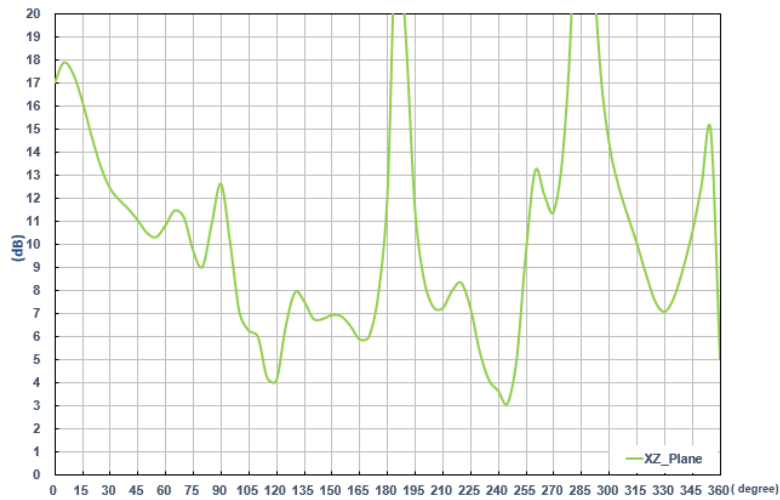

@1561MHz

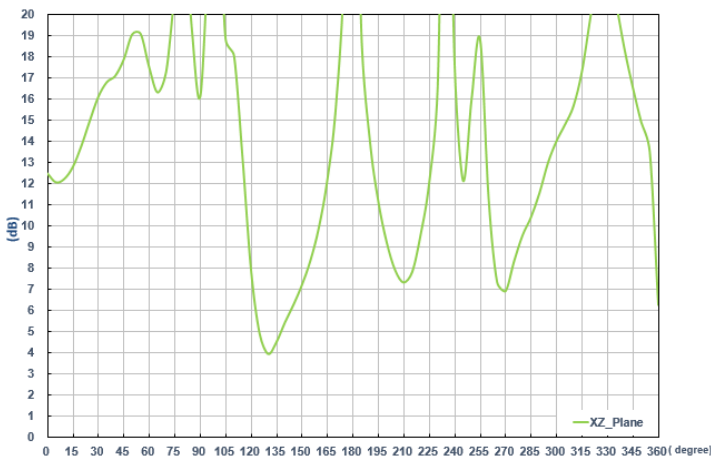

@1575MHz

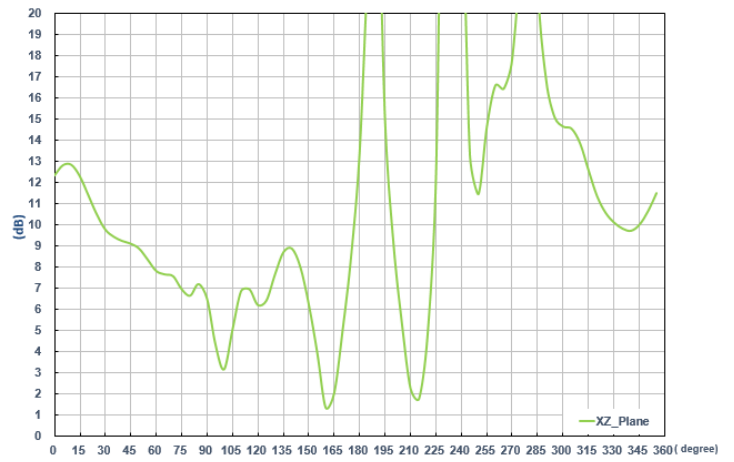

@1602MHz



### 3.1.12. GPS-GLONASS-GALILEO-BeiDou LNA Gain and Noise Figure (Active antenna)

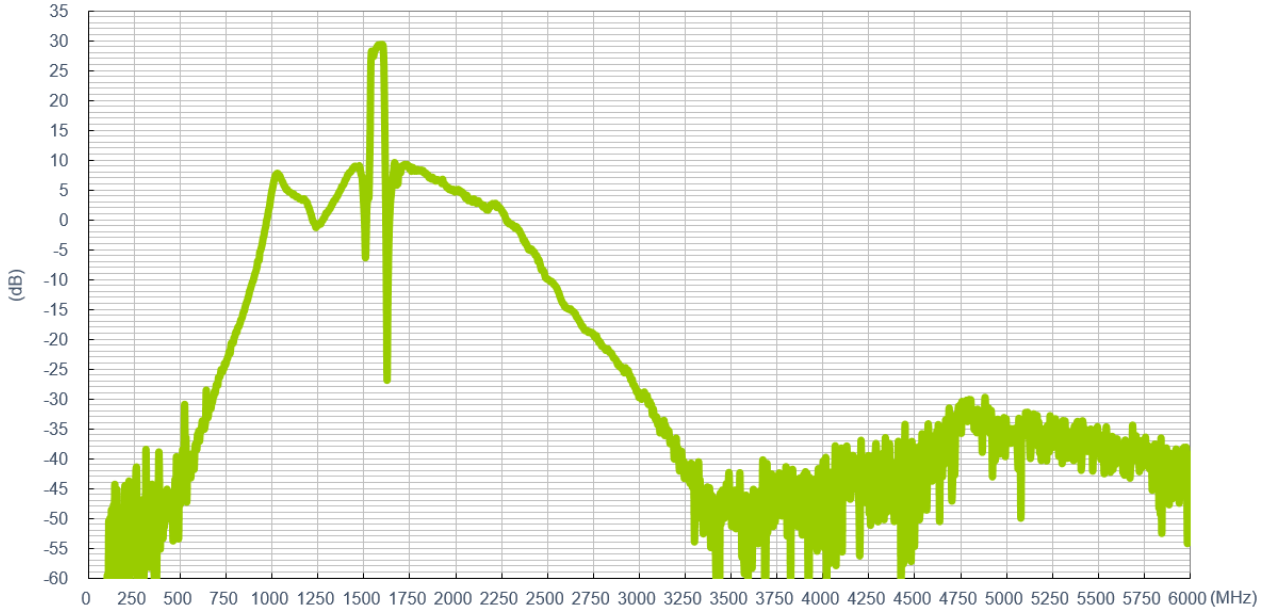

LNA Gain@3.0V

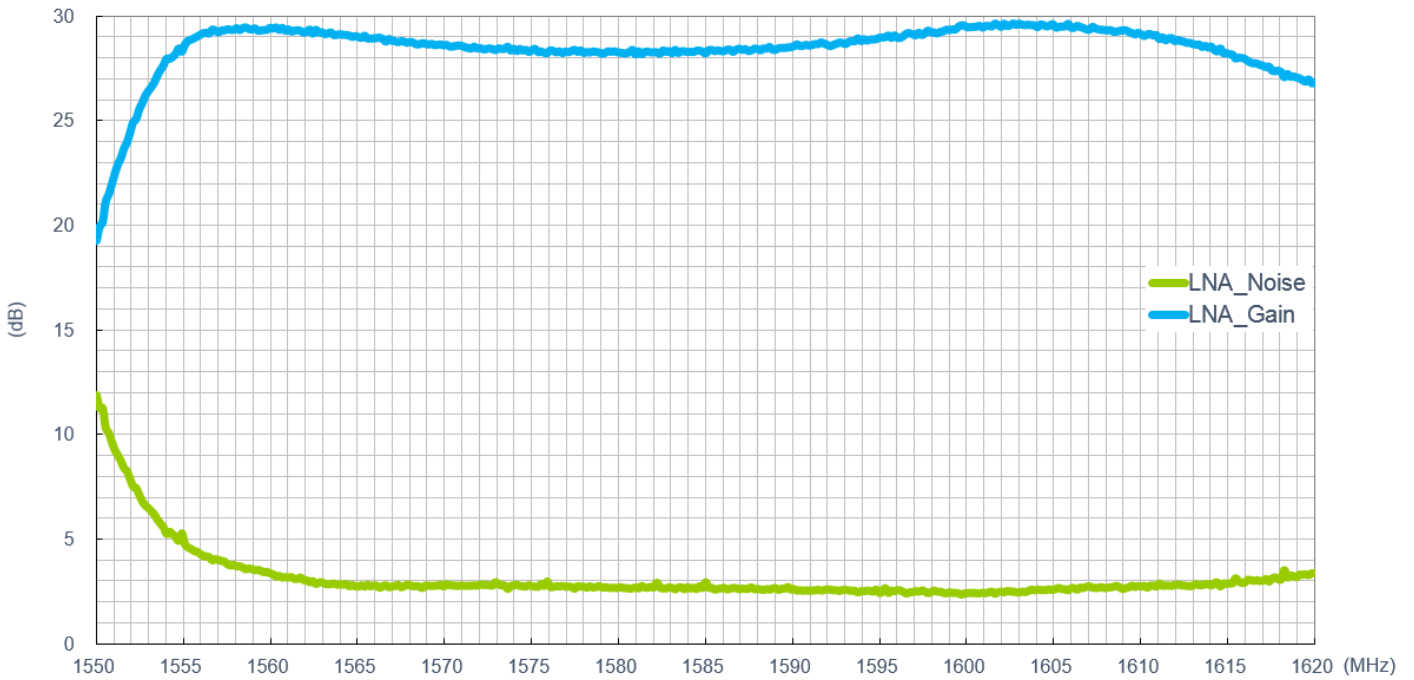

LNA Noise Figure@3.0V

## 3.2. LTE\_MIMO Antenna

### 3.2.1. Test Setup

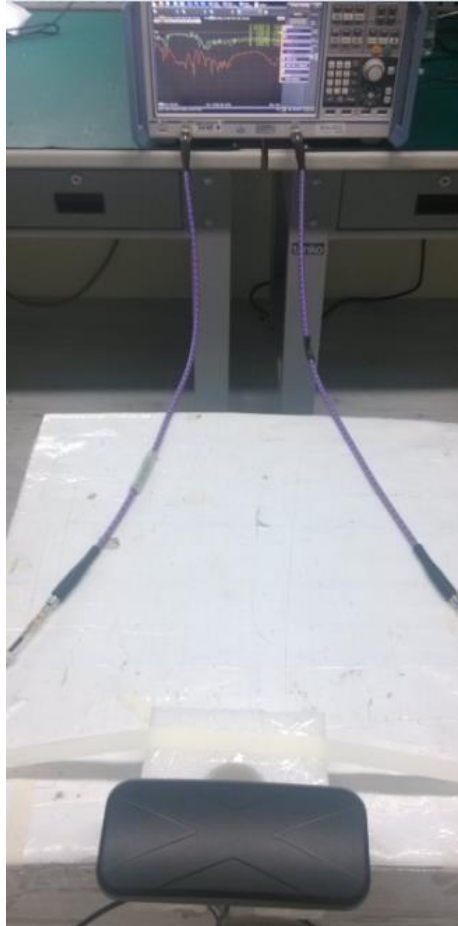

In free space

### 3.2.2. LTE Antenna Return Loss

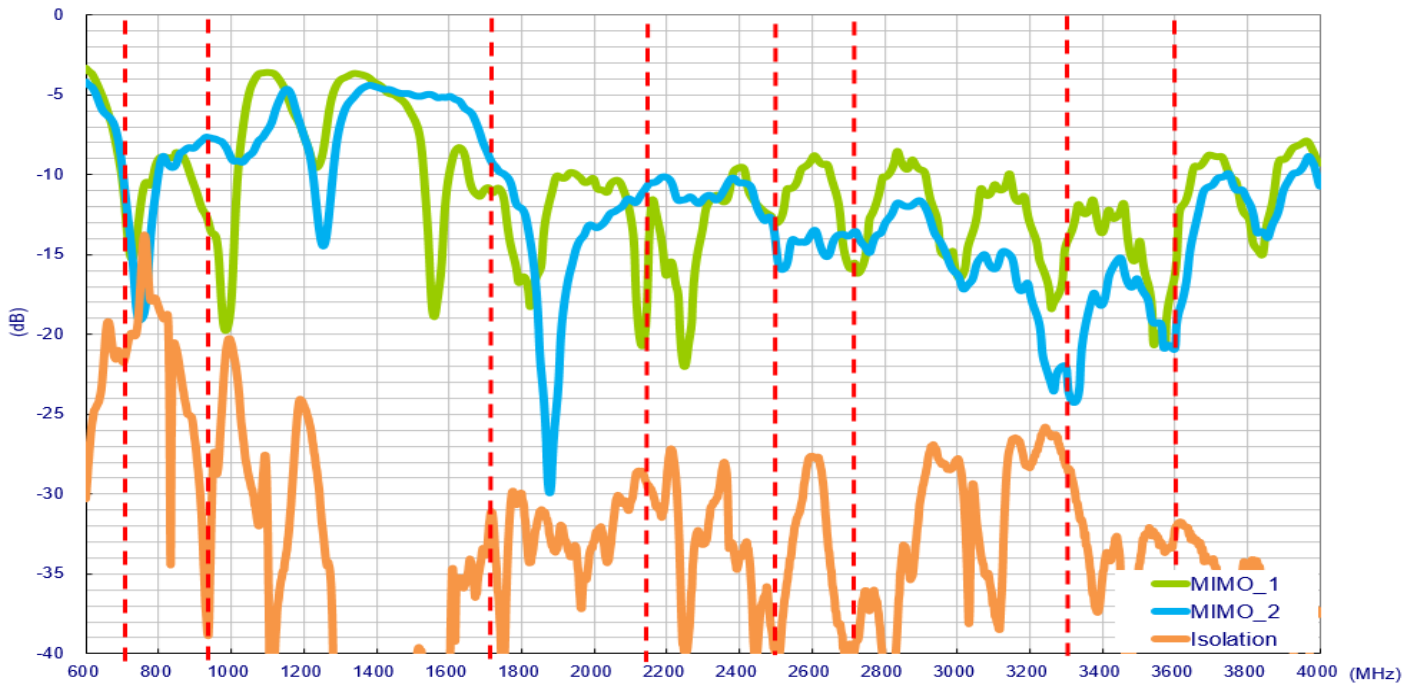

Setup in free space with 3 meter cable length

### 3.2.3. LTE Envelope Correlation Coefficient

Setup in free space with 3 meter cable length

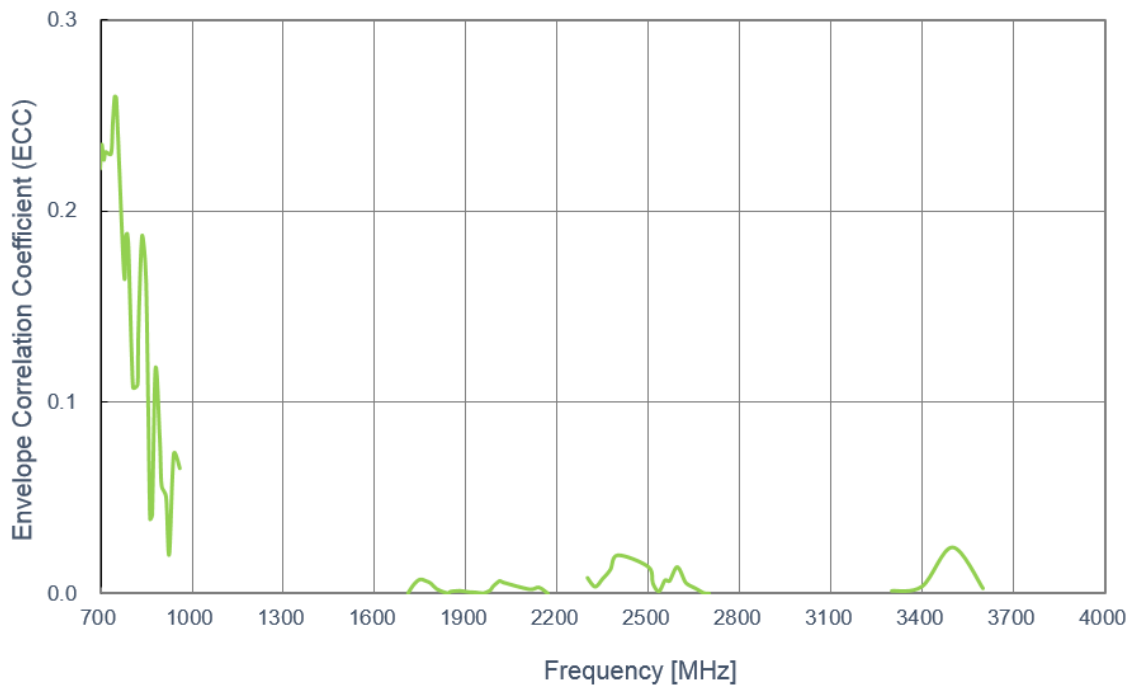

### 3.2.4. LTE Antenna Efficiency

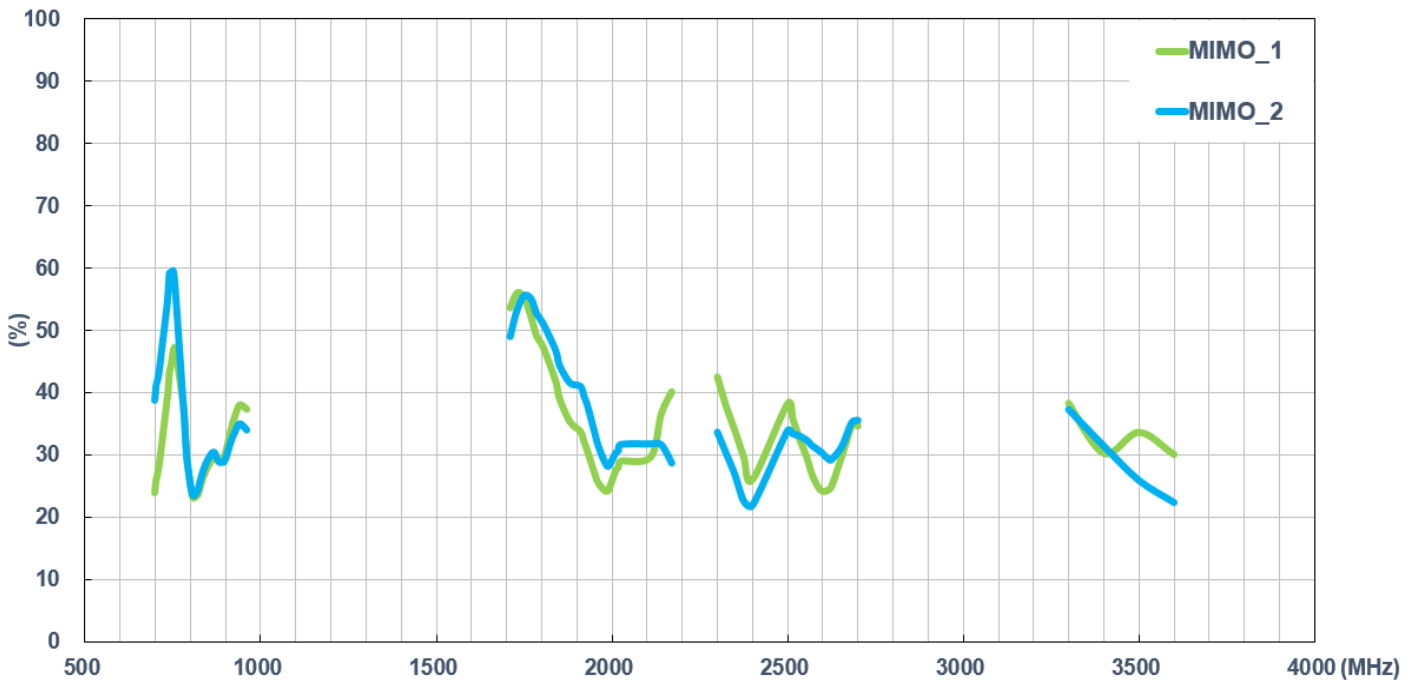

Setup in free space with 3 meters cable length

### 3.2.5. LTE Antenna Peak Gain

Setup in free space with 3 meter cable length

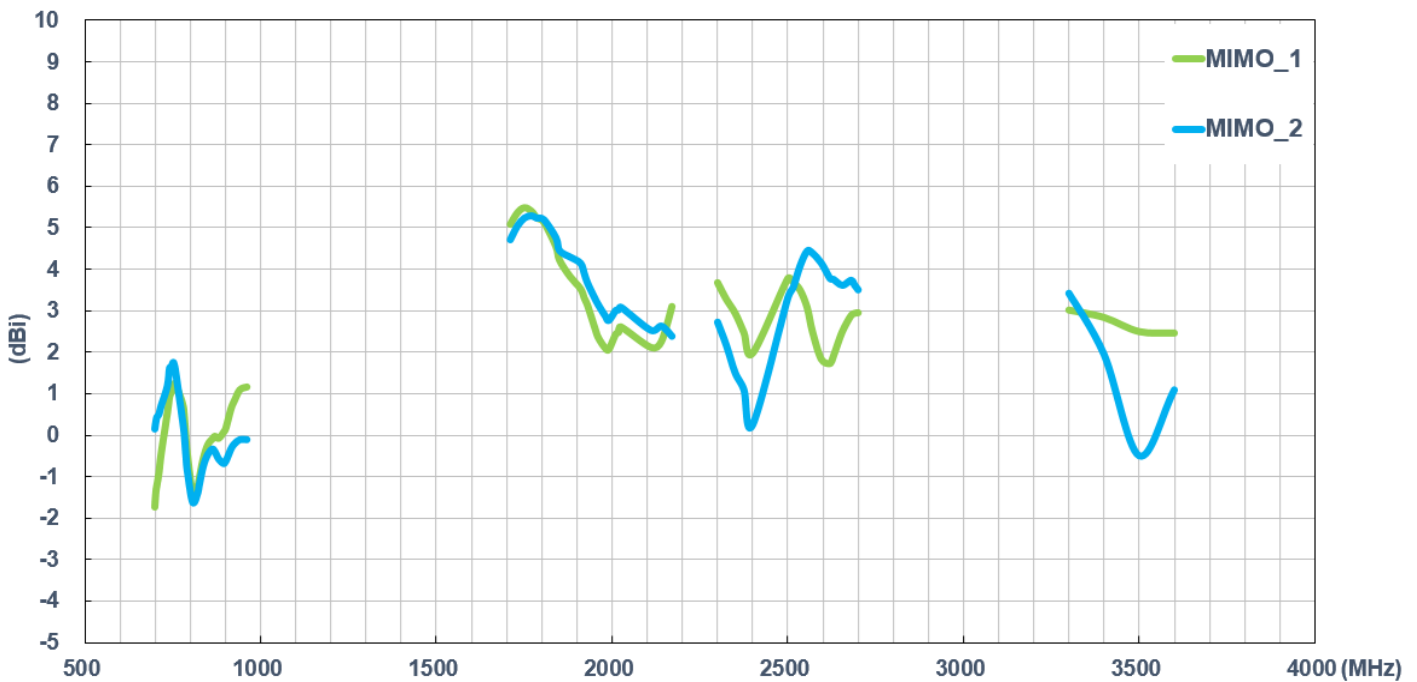

### 3.2.6. LTE Antenna Average Gain

Setup in free space with 3 meter cable length

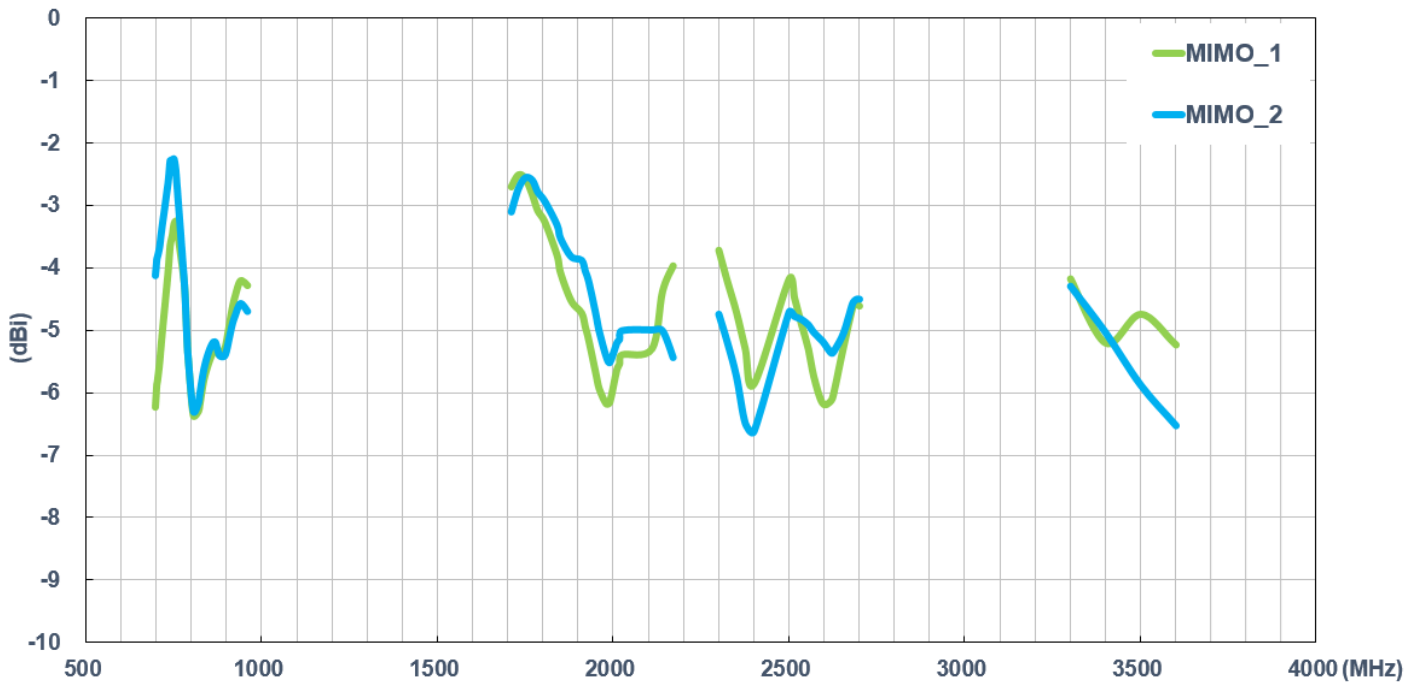

### 3.3. Wi-Fi\_MIMO Antenna

### 3.3.1. Wi-Fi Antenna Return Loss

Setup in free space with 3 meter cable length

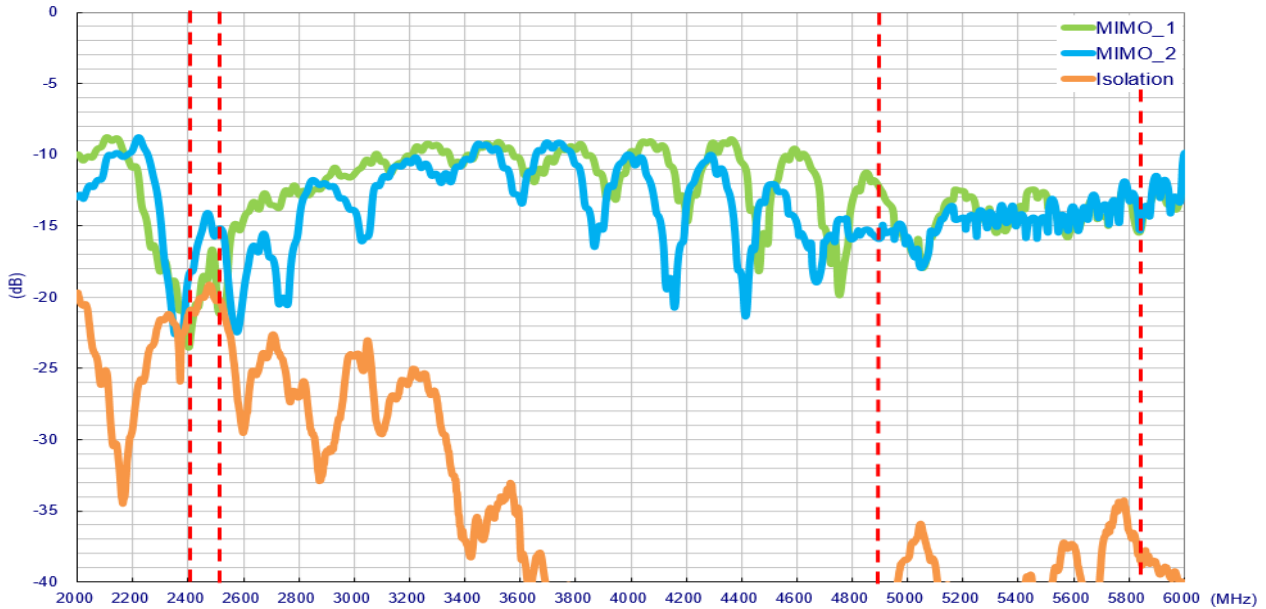

### 3.3.2. Wi-Fi Envelope Correlation Coefficient

Setup in free space with 3 meter cable length

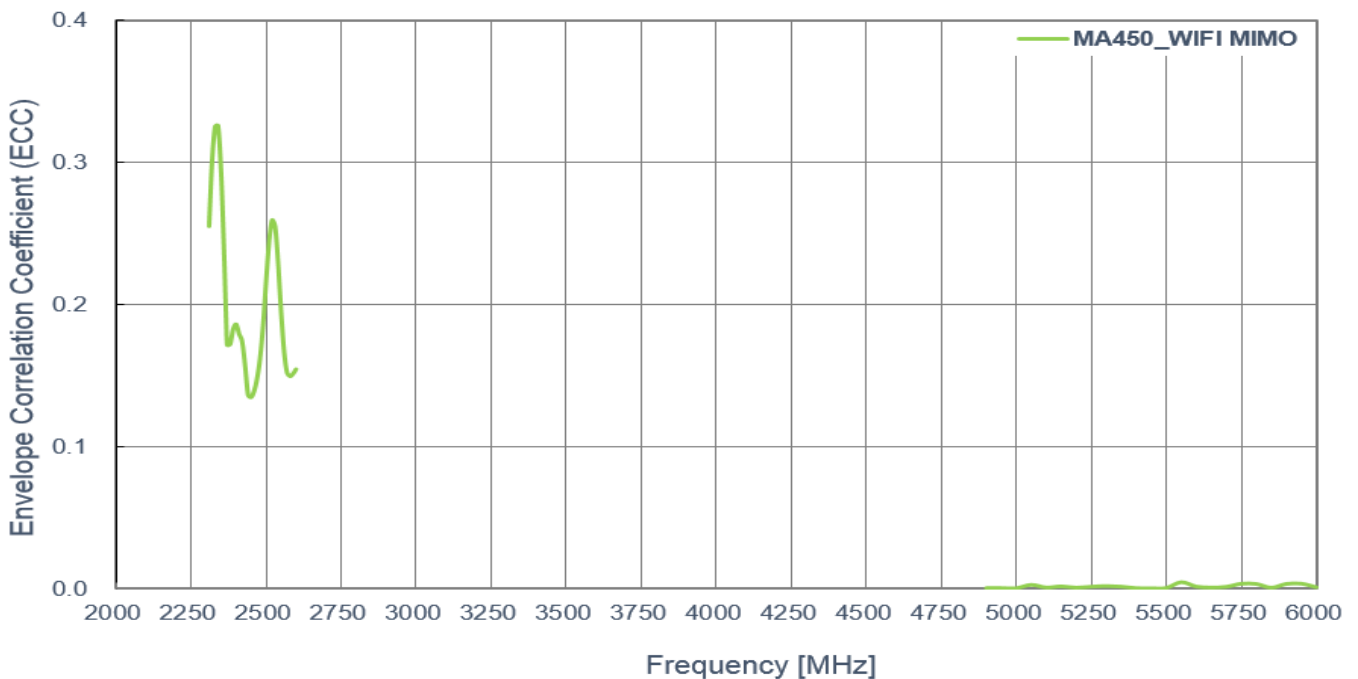

### 3.3.3. Wi-Fi Antenna Efficiency

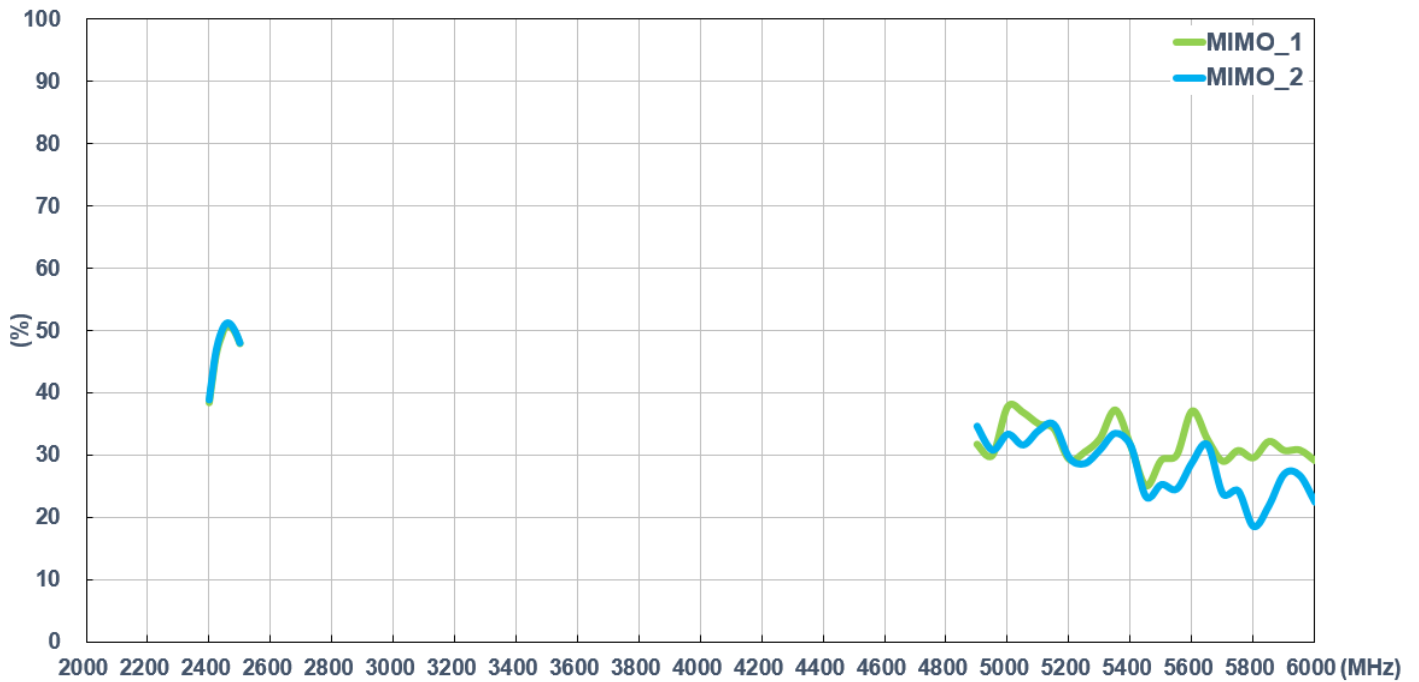

Setup in free space with 3 meter cable length

### 3.3.4. Wi-Fi Antenna Peak Gain

Setup in free space with 3 meter cable length

### 3.3.5. Wi-Fi Antenna Average Gain

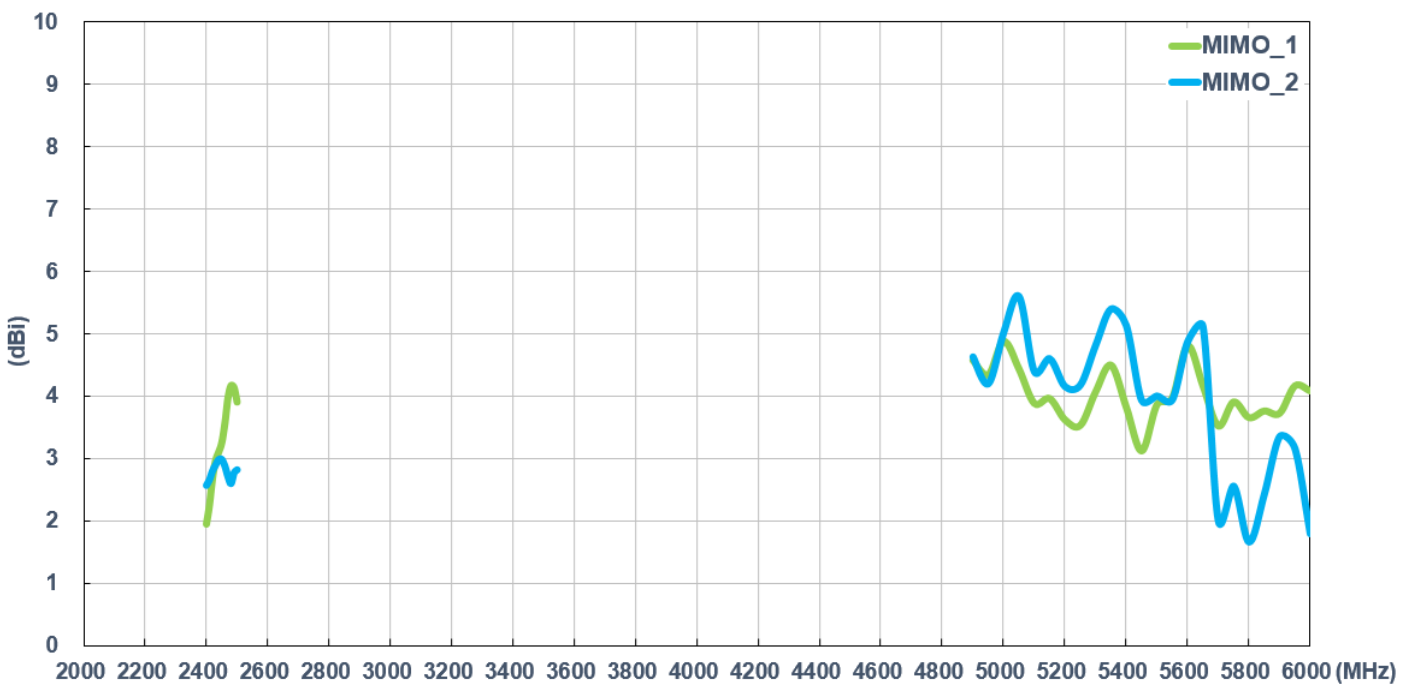

Setup in free space with 3 meter cable length

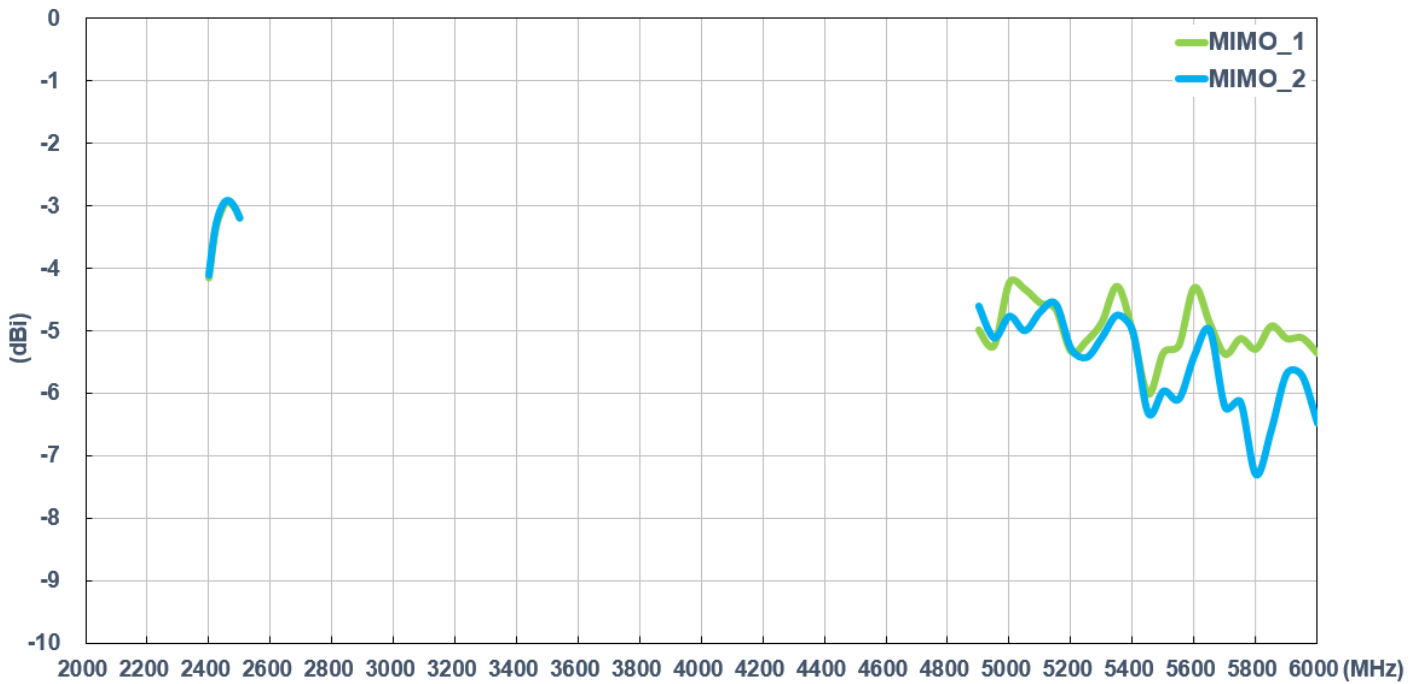

### 3.4. Test Setup for Antenna Radiation Pattern



**(ETS Anechoic chamber)**

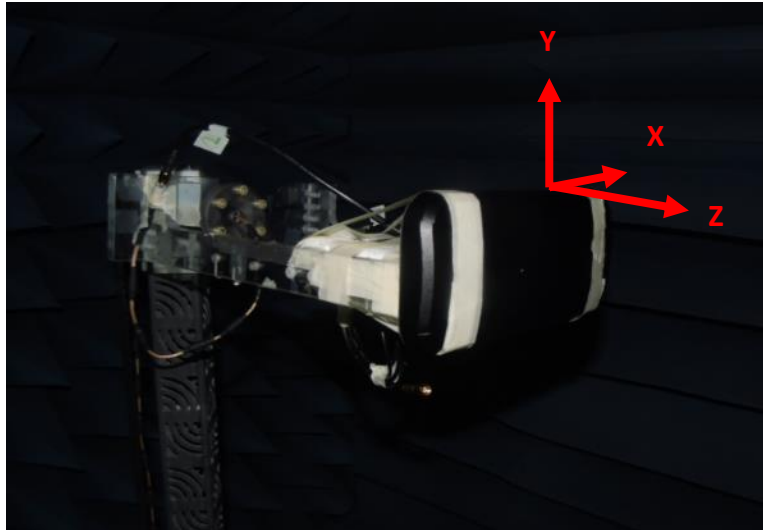

In free space

### **3.4.1. 2D Radiation Pattern (LTE\_MIMO1 with 3M cable length in free space)**

XY Plane

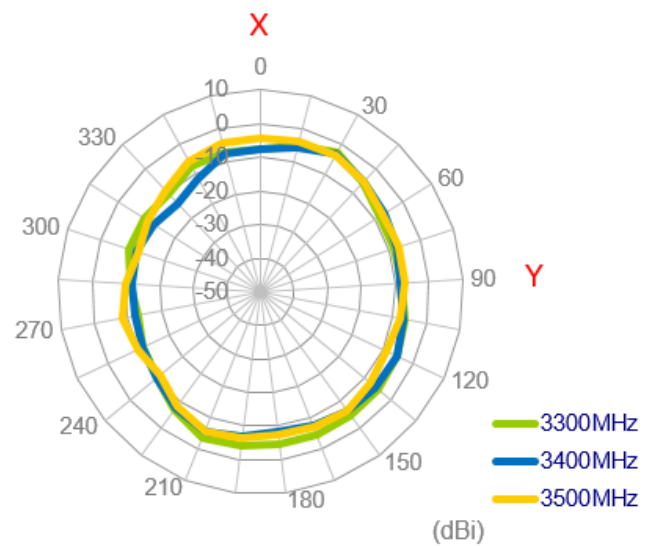
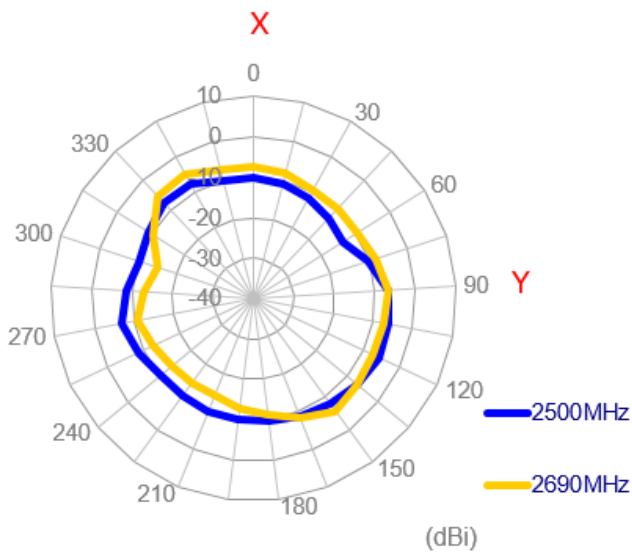
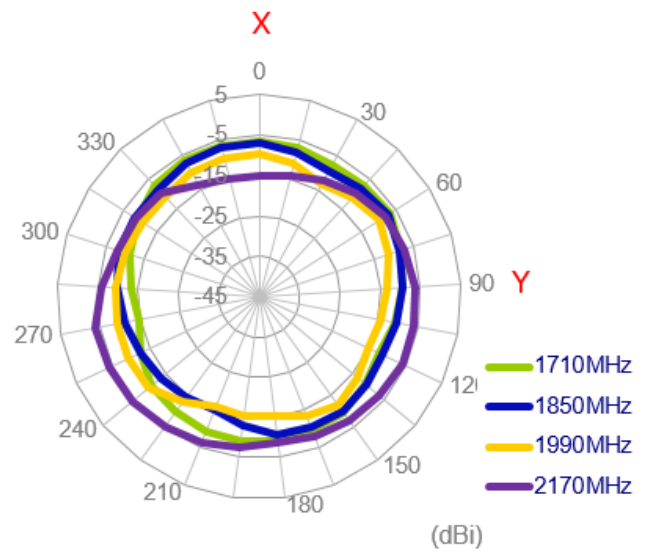
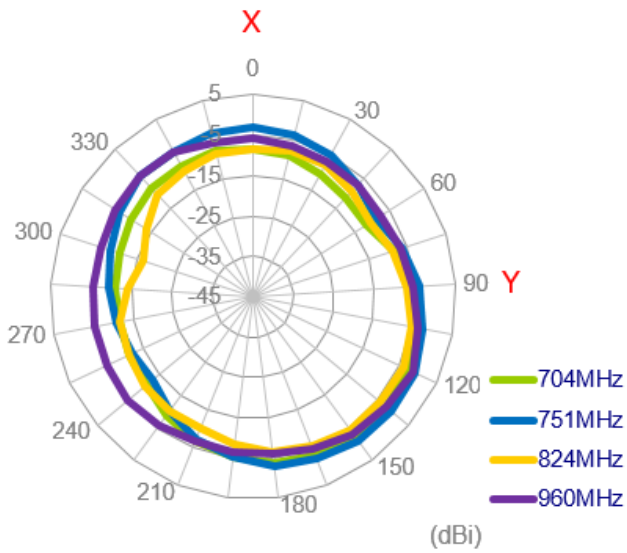

XZ Plane

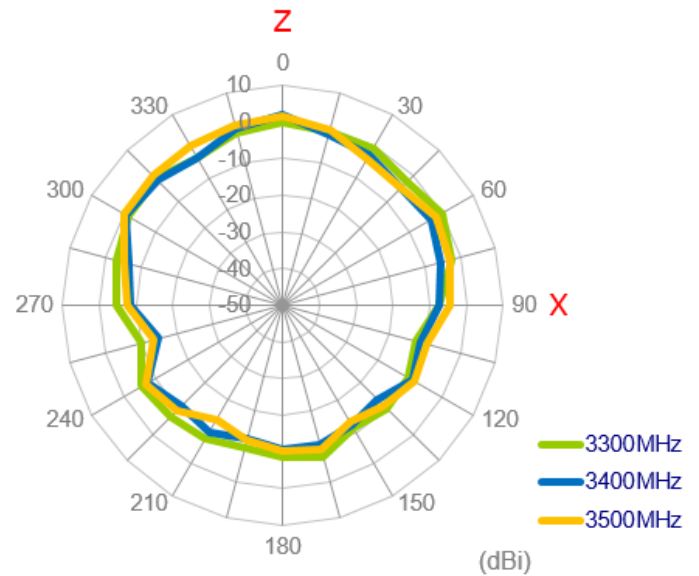
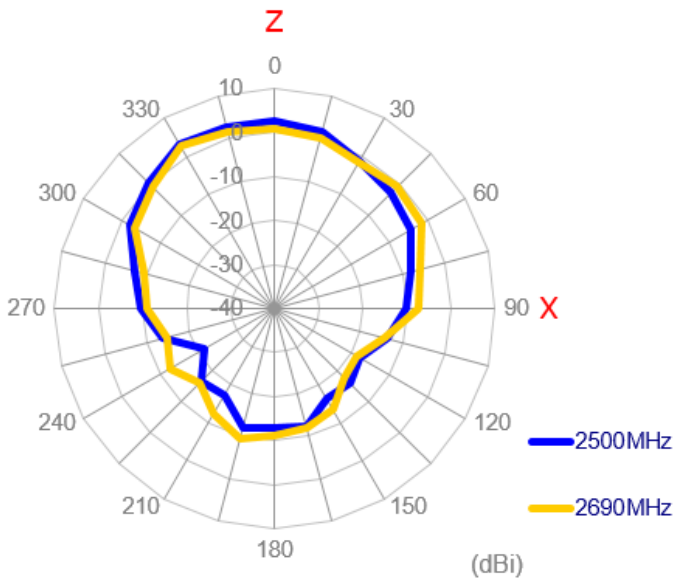
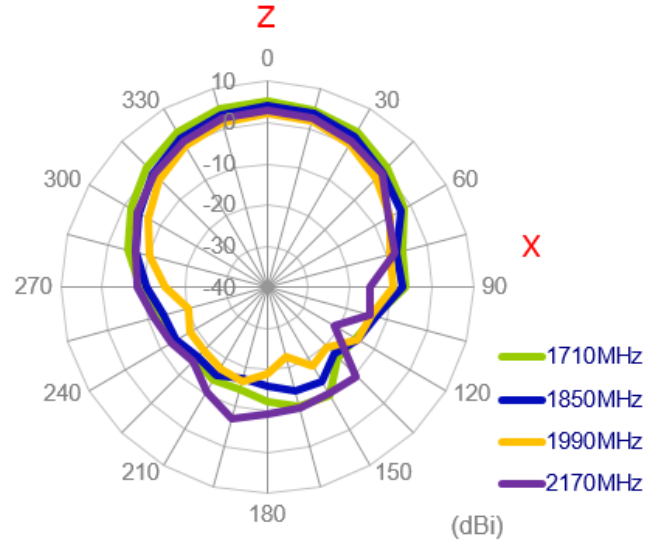
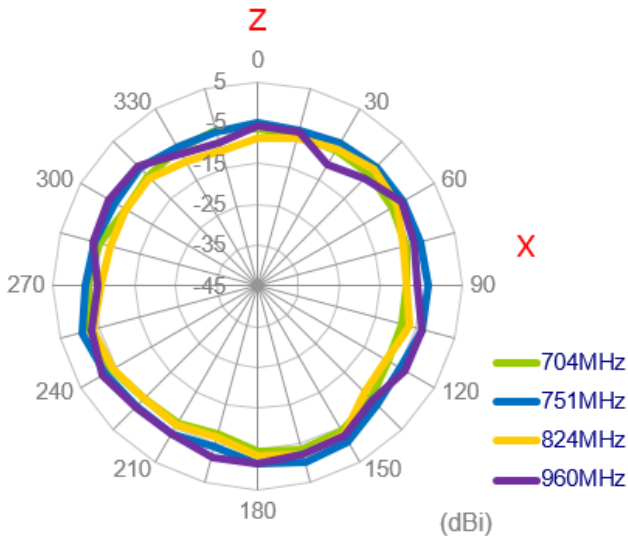

YZ Plane

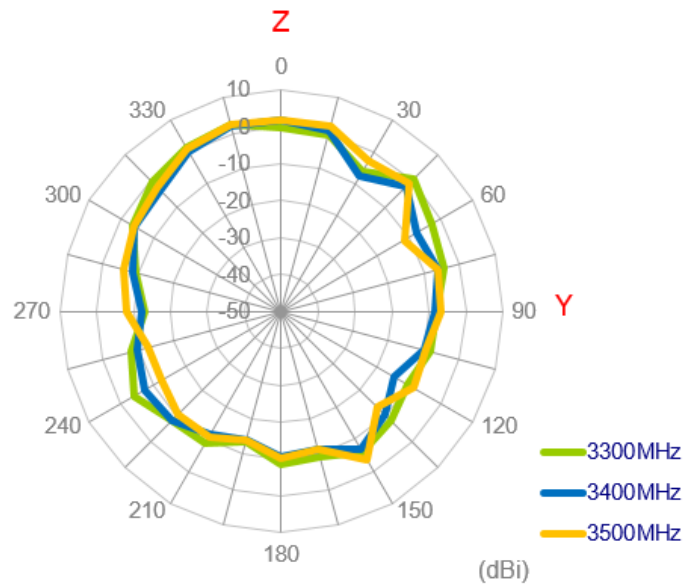
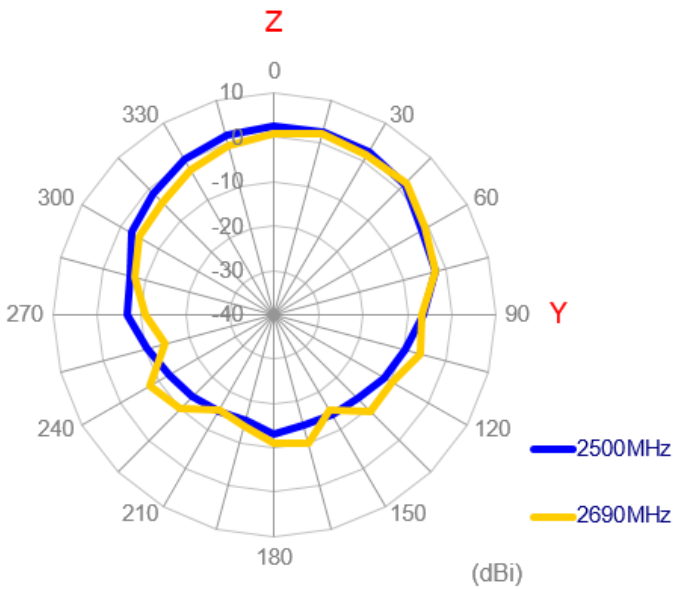
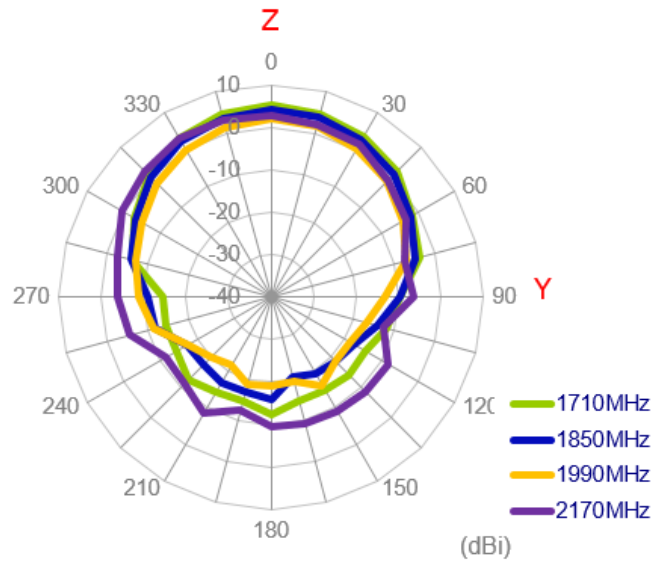
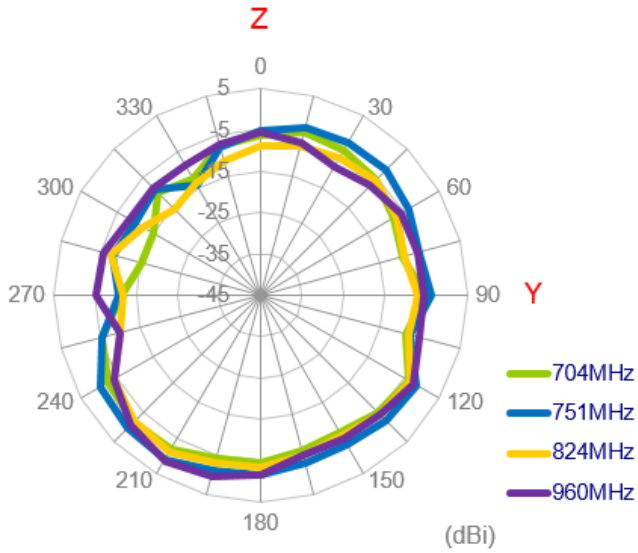

### 3.4.2. 3D Radiation Pattern (LTE\_MIMO1 with 3M cable length in free space)

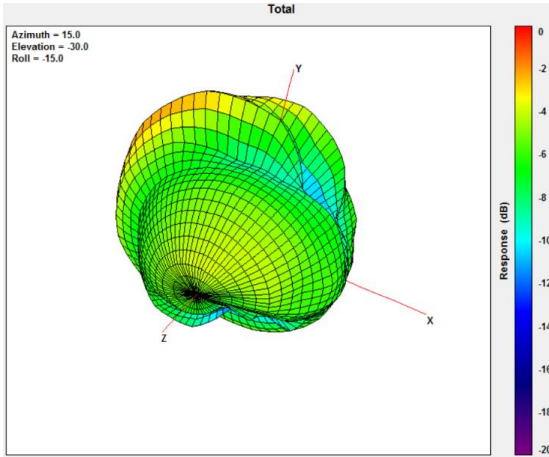

704MHz

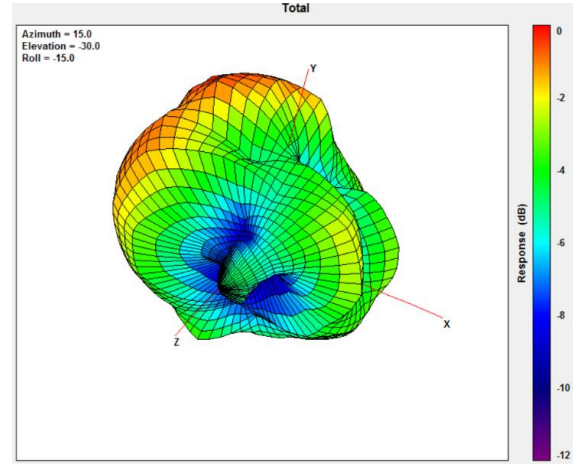

960MHz

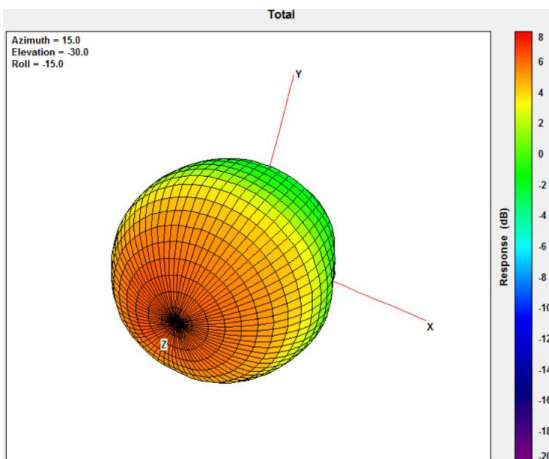

1710MHz

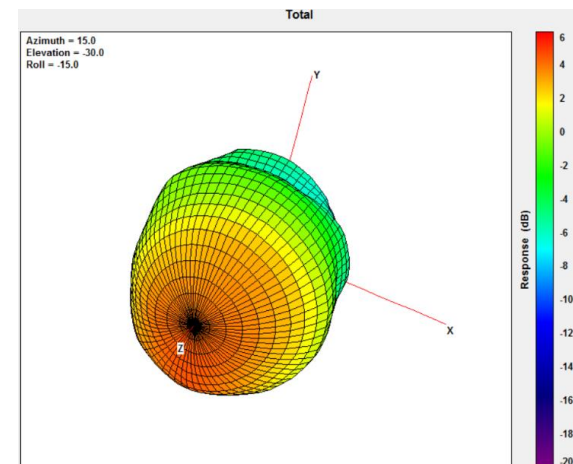

2170MHz

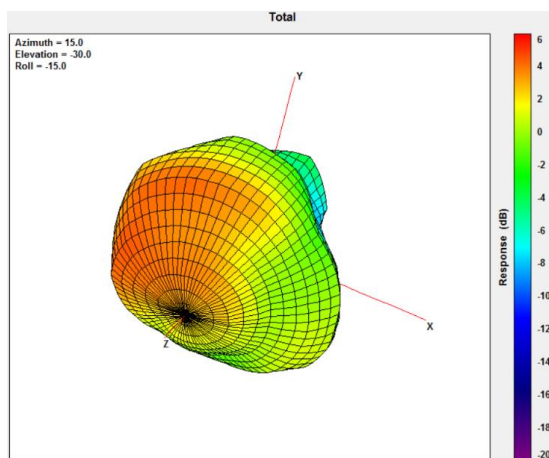

2690MHz

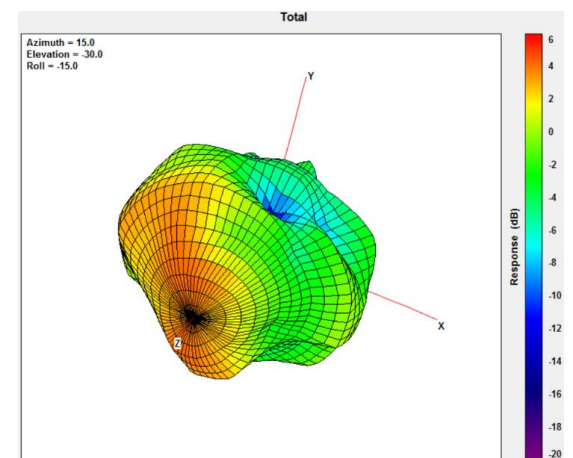

3500MHz

### 3.4.3. 2D Radiation Pattern (LTE\_MIMO2 with 3M cable length in free space)

XY Plane

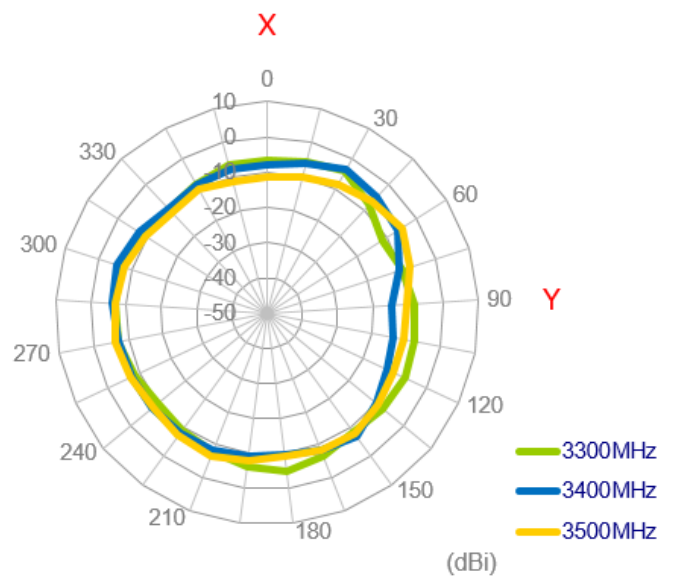
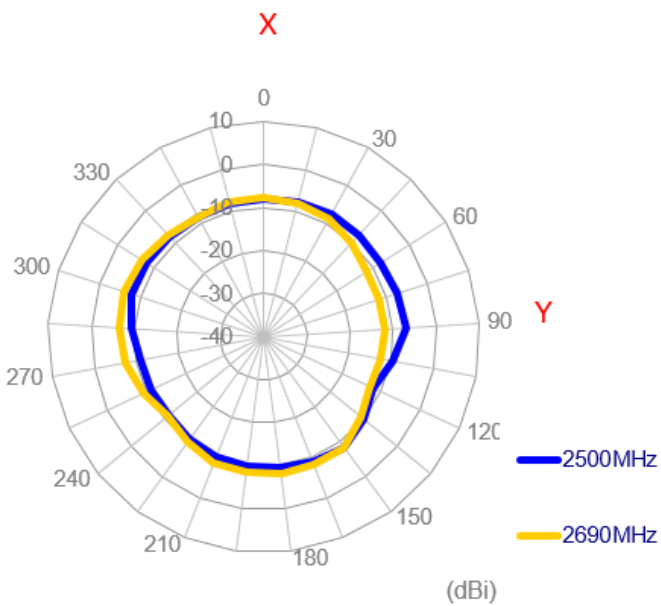
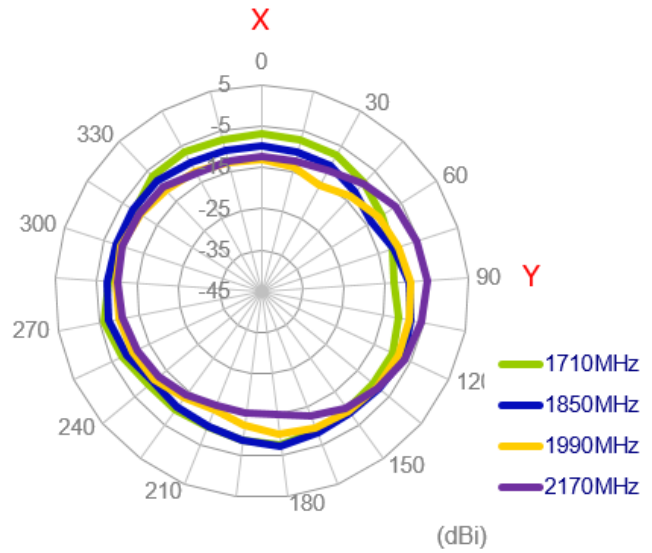
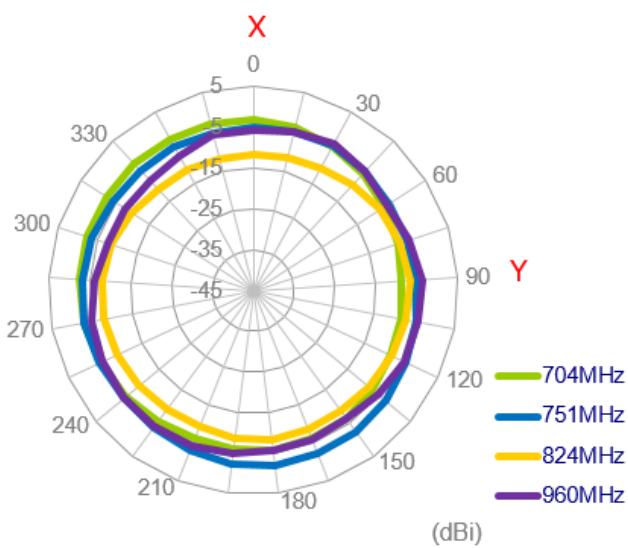



XZ Plane

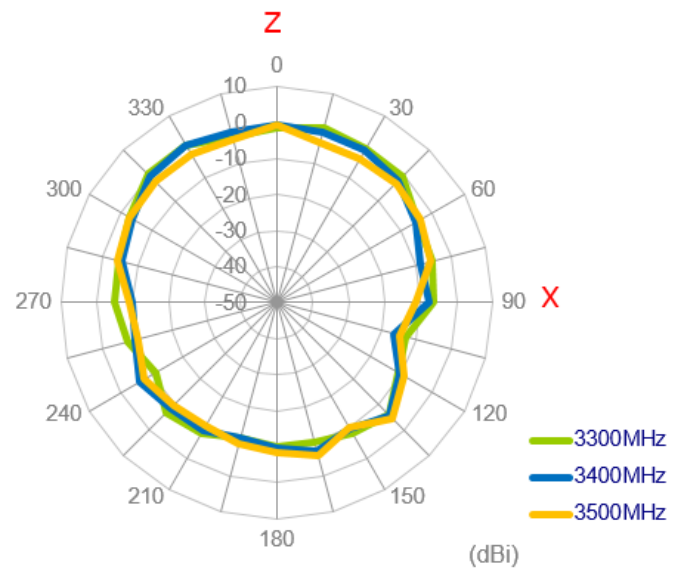
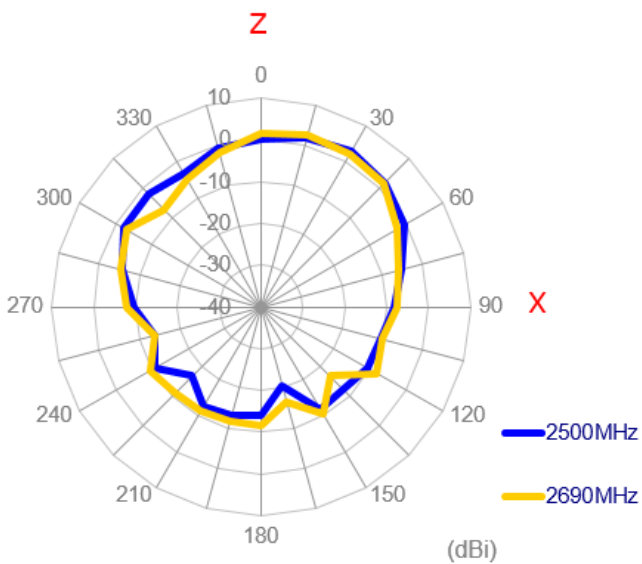
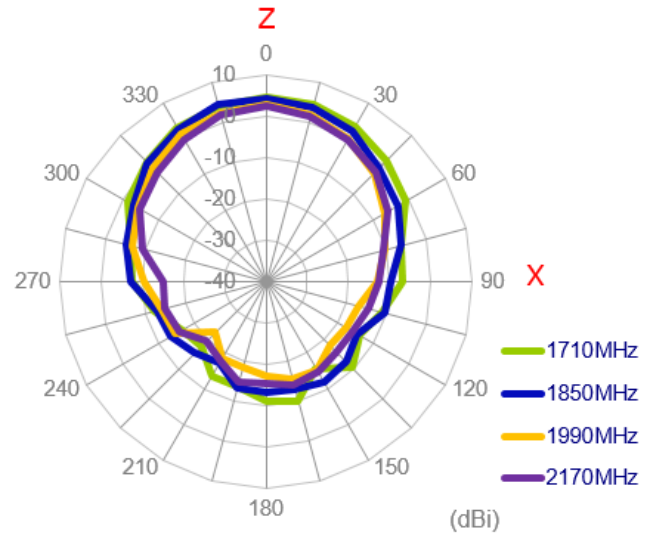
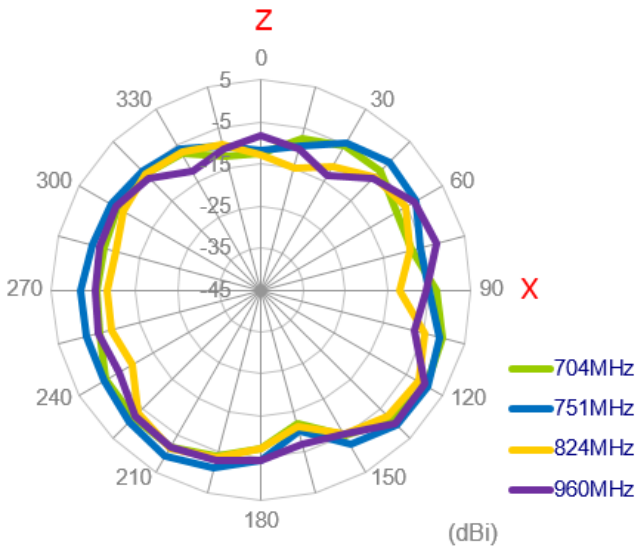

YZ Plane

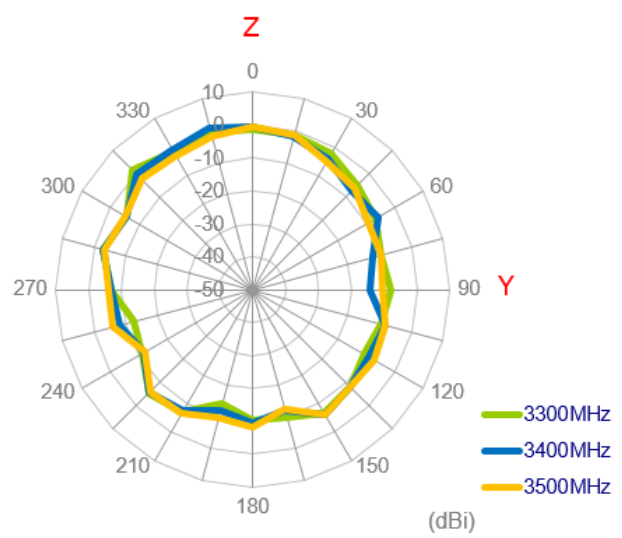
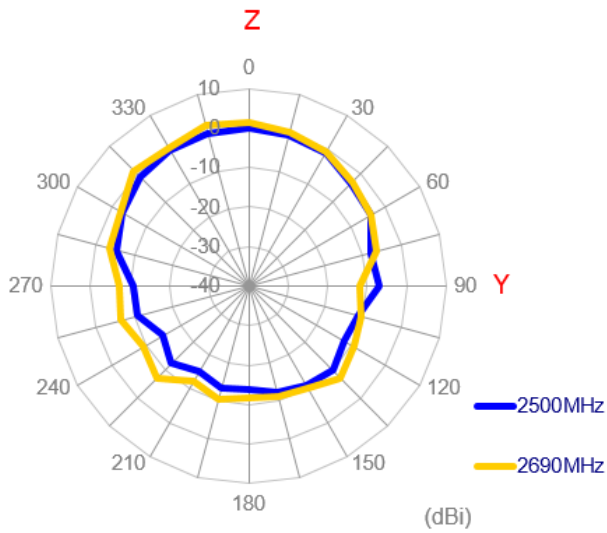
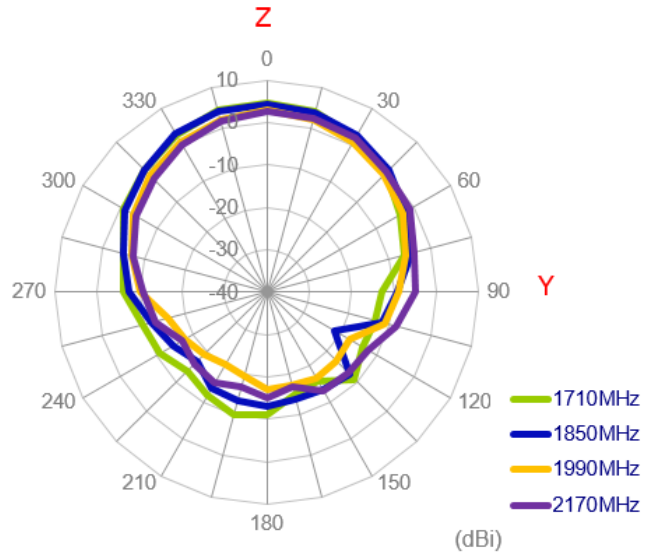
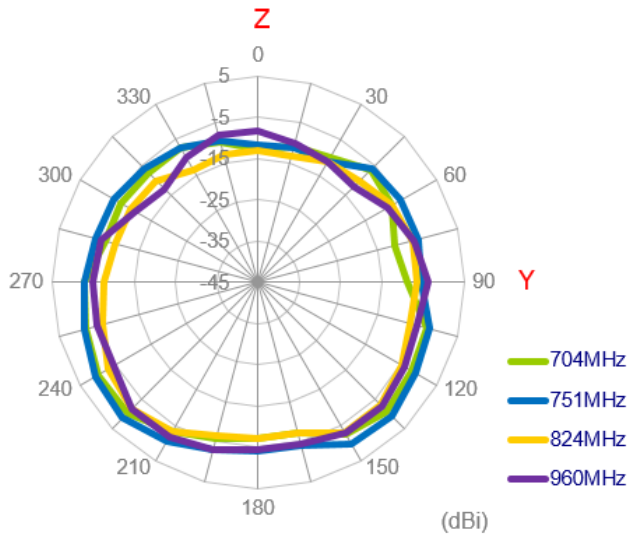



### 3.4.4. 2D Radiation Pattern (LTE\_MIMO2 with 3M cable length in free space)

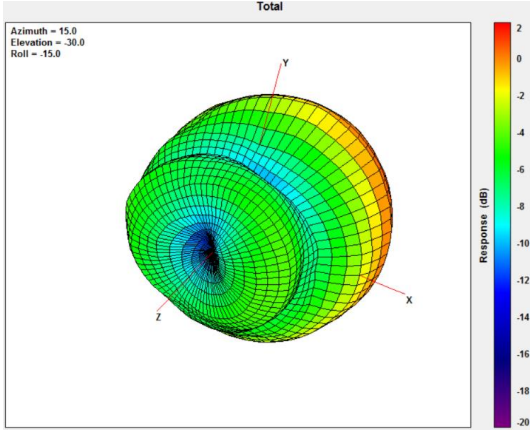

704MHz

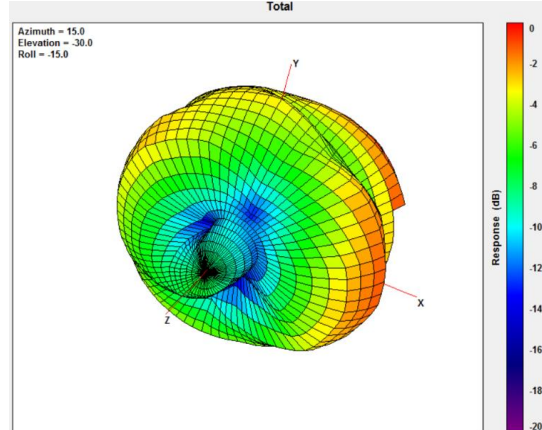

960MHz

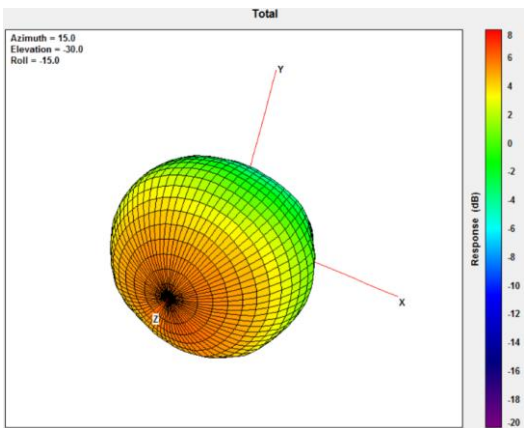

1710MHz

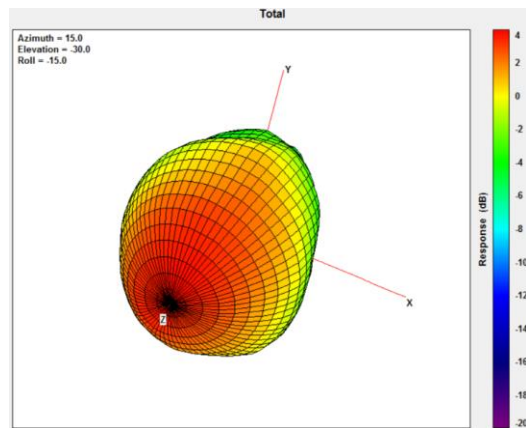

2170MHz

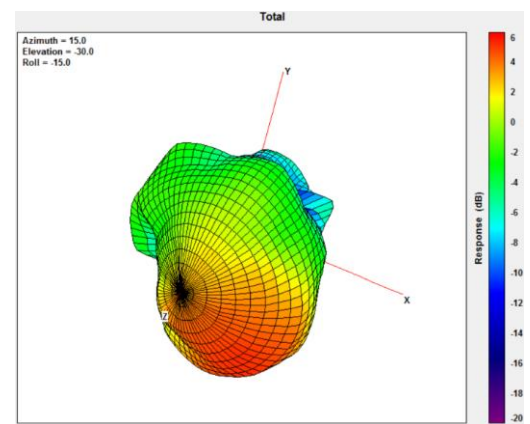

2690MHz

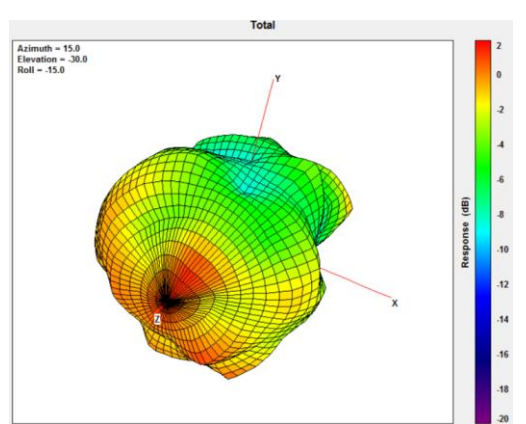

3500MHz

### 3.4.5. 2D Radiation Pattern (Wi-Fi\_MIMO1 with 3M cable length in free space)

XY Plane

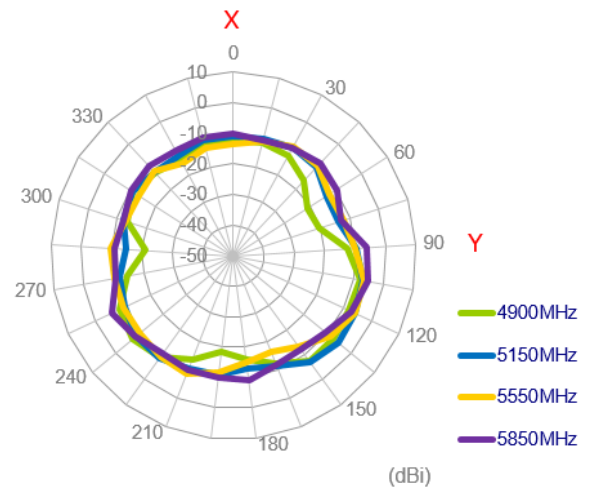
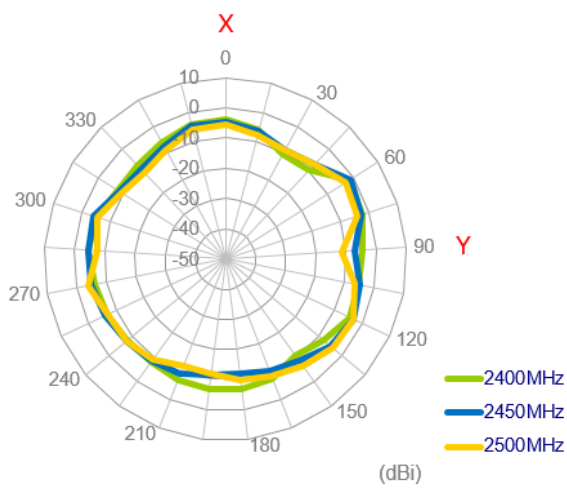

XZ Plane

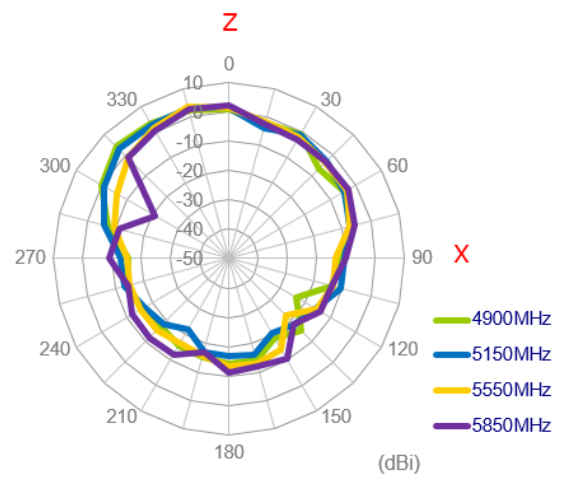
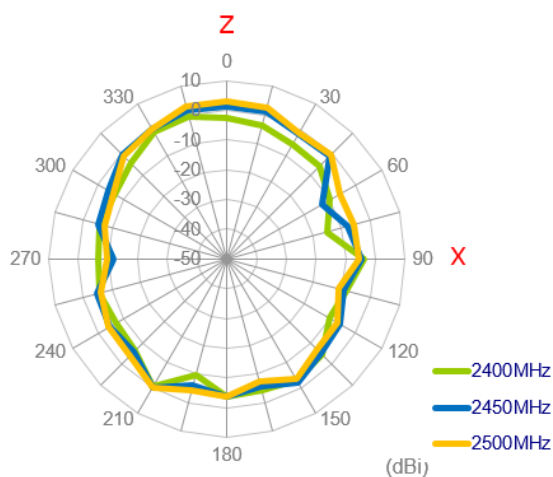

YZ Plane

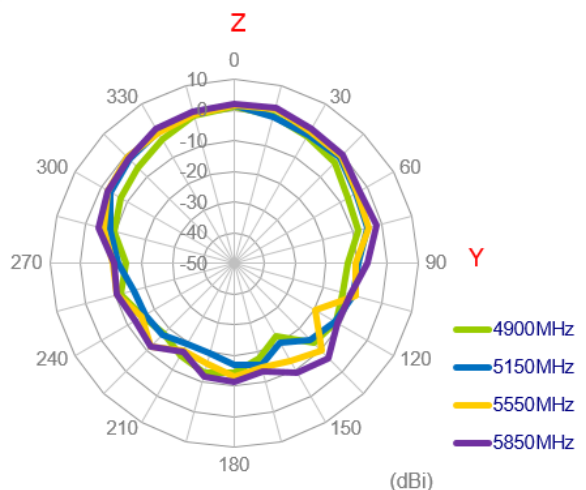
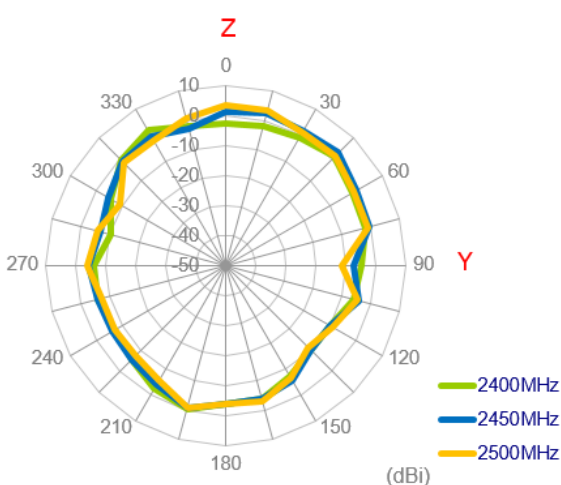

### 3.4.6. 3D Radiation Pattern (Wi-Fi\_MIMO1 with 3M cable length in free space)

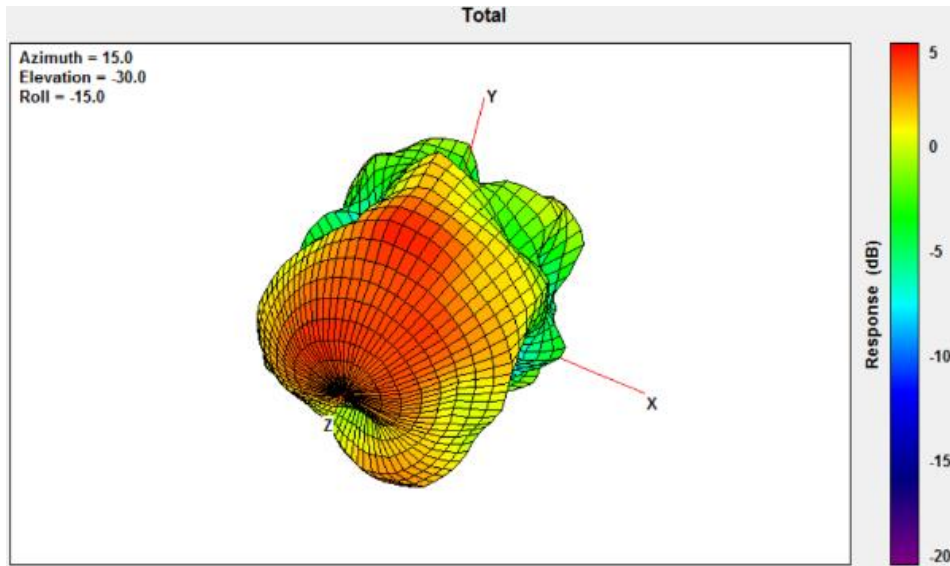

2450MHz

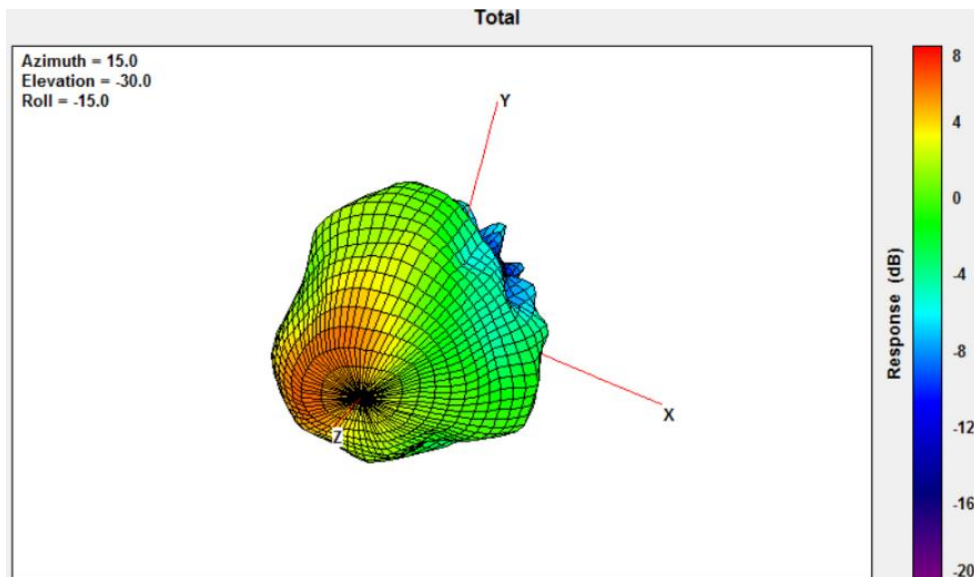

5550MHz

### 3.4.7. 2D Radiation Pattern (Wi-Fi\_MIMO2 with 3M cable length in free space)

XY Plane

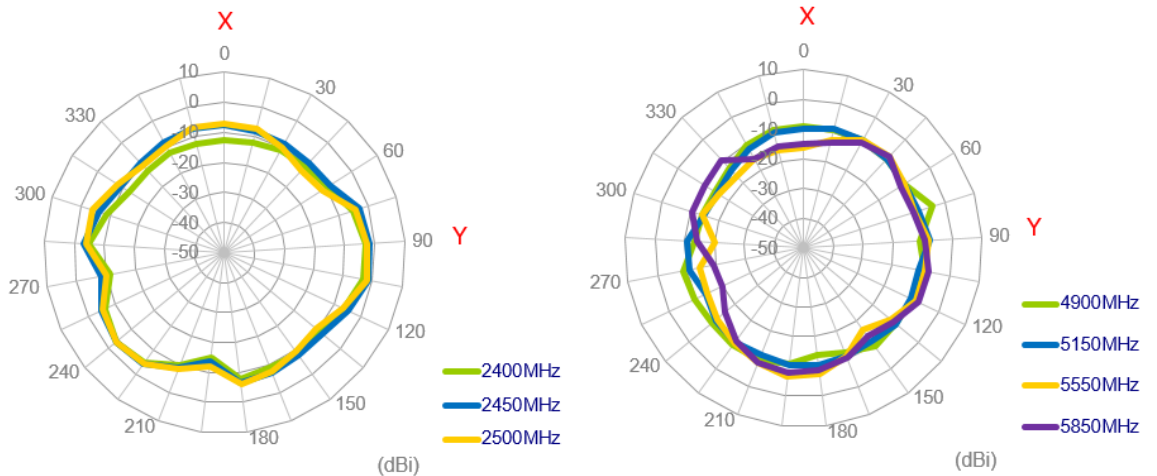

XZ Plane

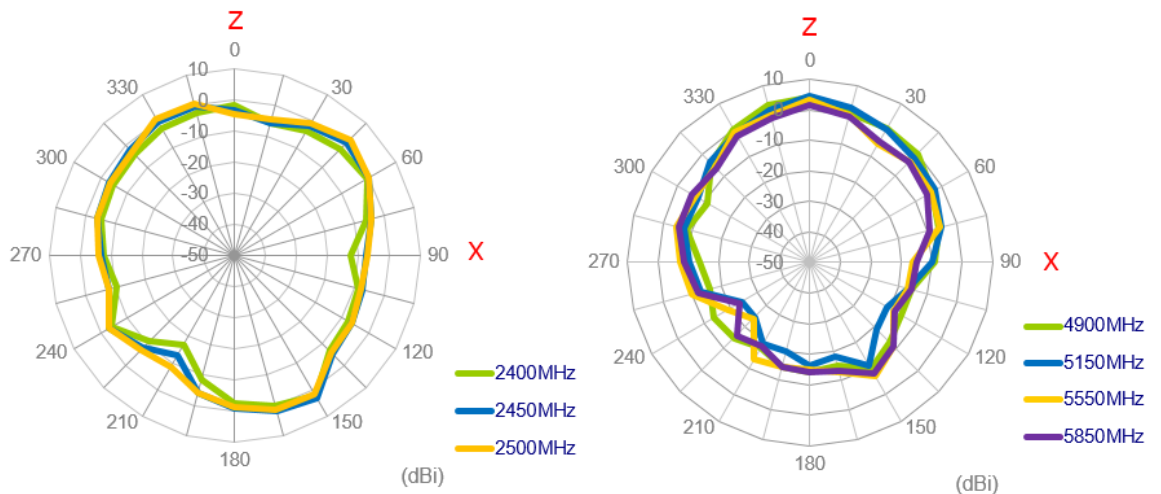

YZ Plane

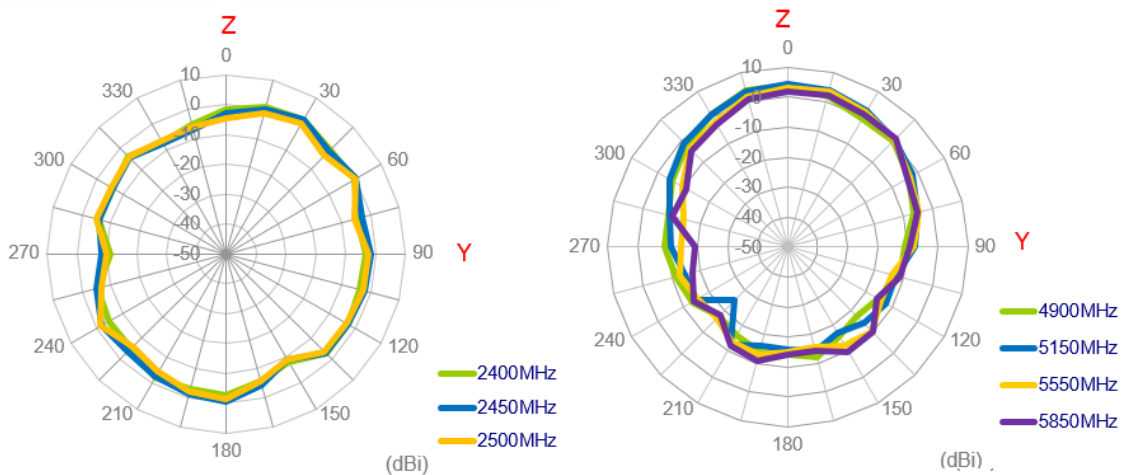

### 3.4.8. 2D Radiation Pattern (Wi-Fi\_MIMO2 with 3M cable length in free space)

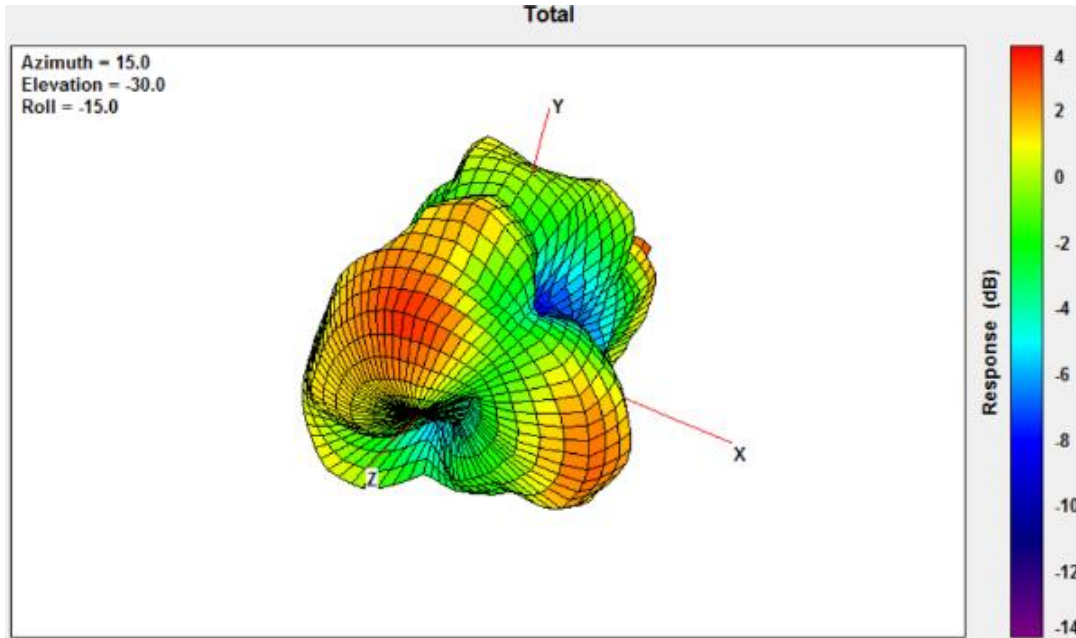

2450MHz

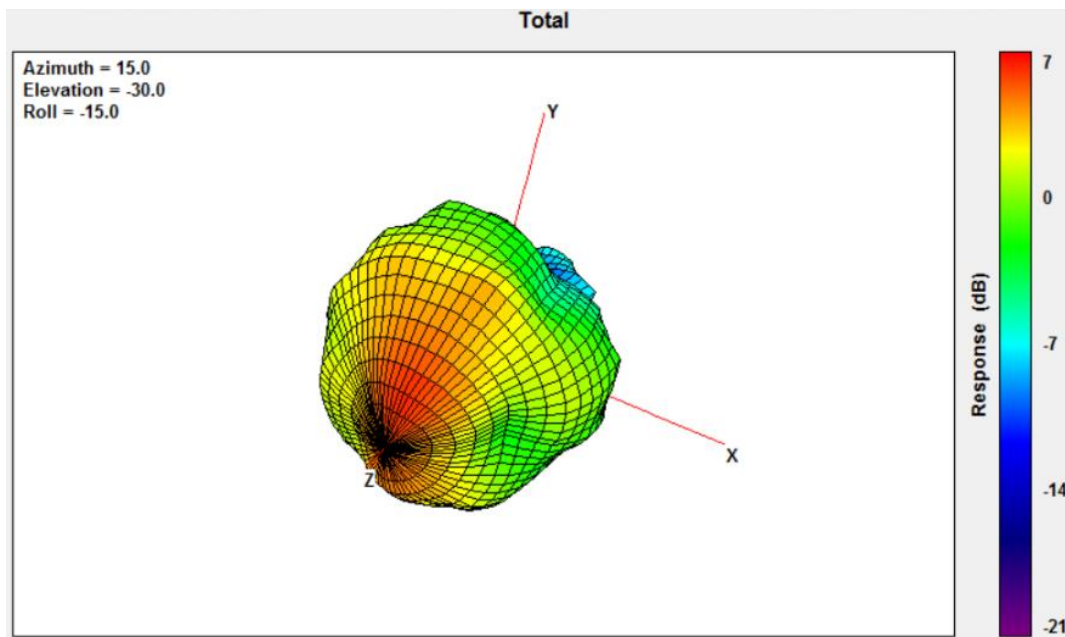

5550MHz



## 4. Mechanical Drawing (Unit: mm)

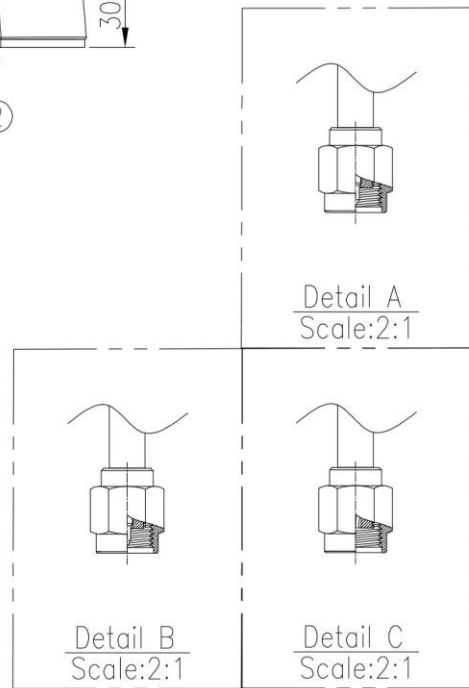
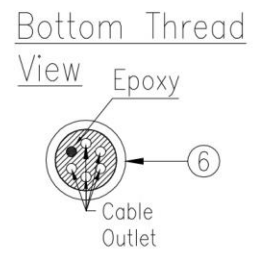
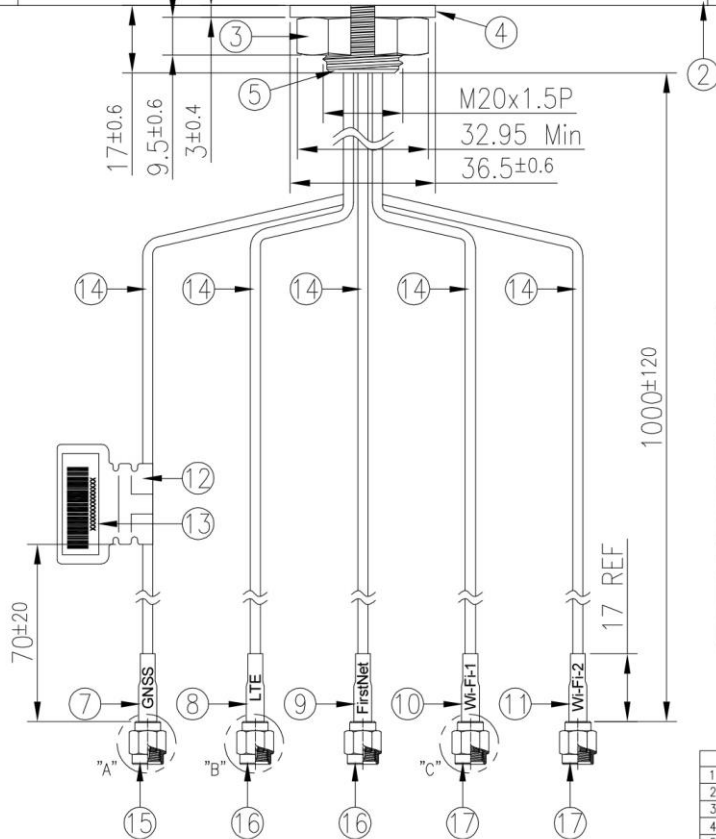
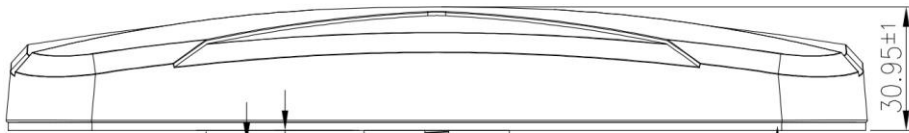
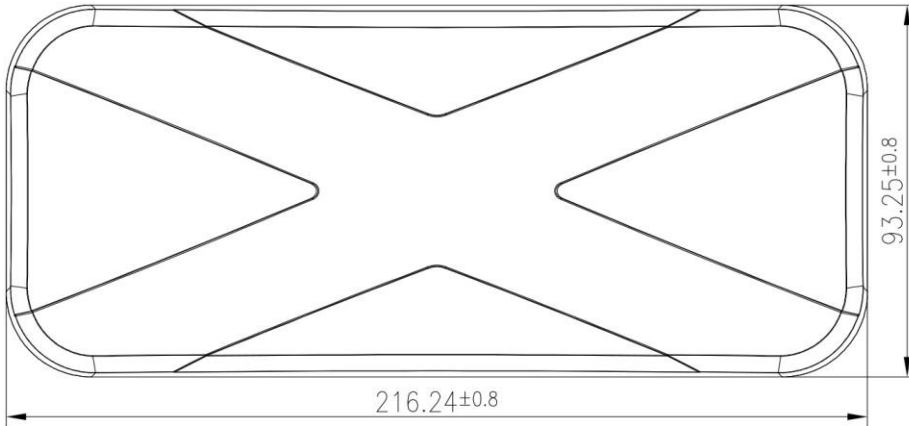

Name	Material	Finish	QTY
1 Housing	ABS+PC	Black	1
2 Closed Cell Foam and Adhesive Tape	3M 9448+CR-4305	Black	1
3 Nut_M20x1.5Px9.5H Cut	Steel Carbon	Ni-Zn Plated	1
4 Washer_Cut	Steel Carbon	Ni-Zn Plated	1
5 Metal Base	AL	Ni Plated	1
6 Cable Rubber	Silicone Rubber	Black	1
7 Heat Shrink Tube (GNSS)	PE	Blue Tube/White Text	1
8 Heat Shrink Tube (LTE)	PE	Red Tube/White Text	1
9 Heat Shrink Tube (FirstNet)	PE	Red Tube/White Text	1
10 Heat Shrink Tube (Wi-Fi-1)	PE	Yellow Tube/Black Text	1
11 Heat Shrink Tube (Wi-Fi-2)	PE	Yellow Tube/Black Text	1
12 Empty Label	PEPA	White	1
13 Barcode Label	PET	White	1
14 RG316 Coaxial Cable	FEP	Brown	5
15 SMA(M)ST	Brass	Au Plated	1
16 SMA(M)ST	Brass	Au Plated	2
17 RP-SMA(M)ST	Brass	Au Plated	2

## 5. Installation

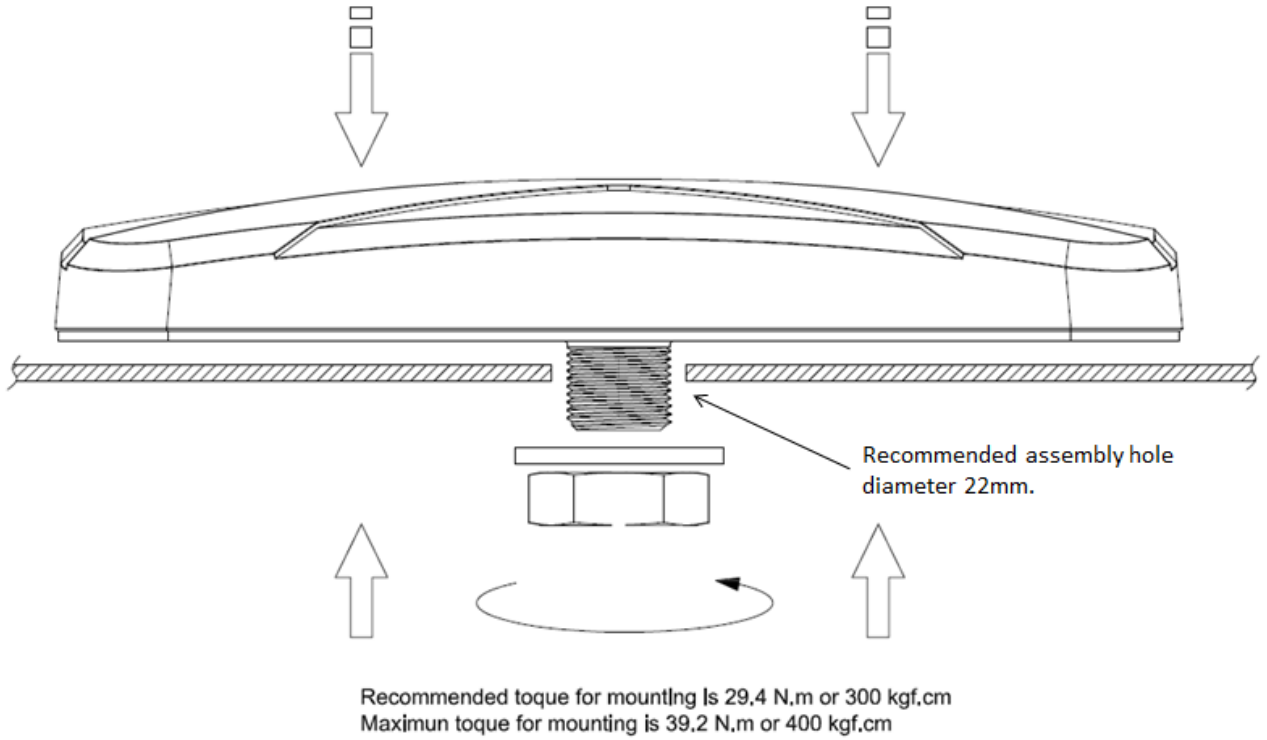

## 6. Packaging

2 pc FMA459.A.LBFCG.001 per carton  
Carton Dimensions - 390\*260\*350mm  
Total Weight - 1.42Kg

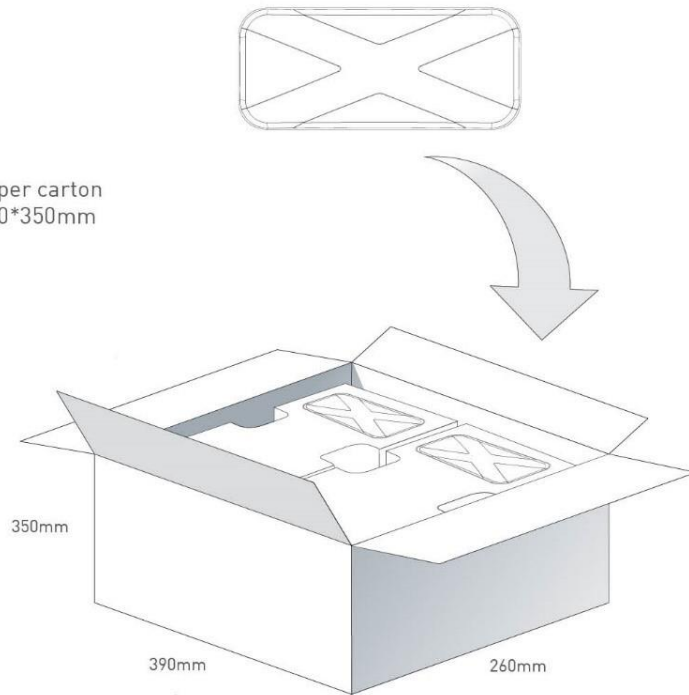

Pallet Dimensions 1180\*900\*1410mm  
54 Cartons per pallet  
9 Cartons per layer  
6 Layers

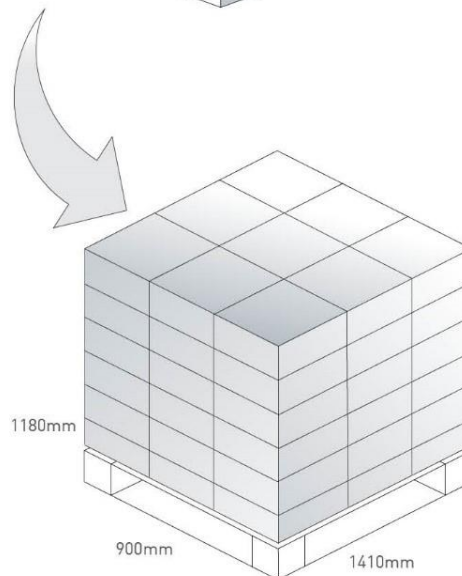



## 7. Application Note

The FMA459 antenna performance with different cable lengths is shown below.

### 7.1. In free space (LTE MIMO Antenna)

#### 7.1.1. Return Loss (LTE MIMO\_1)

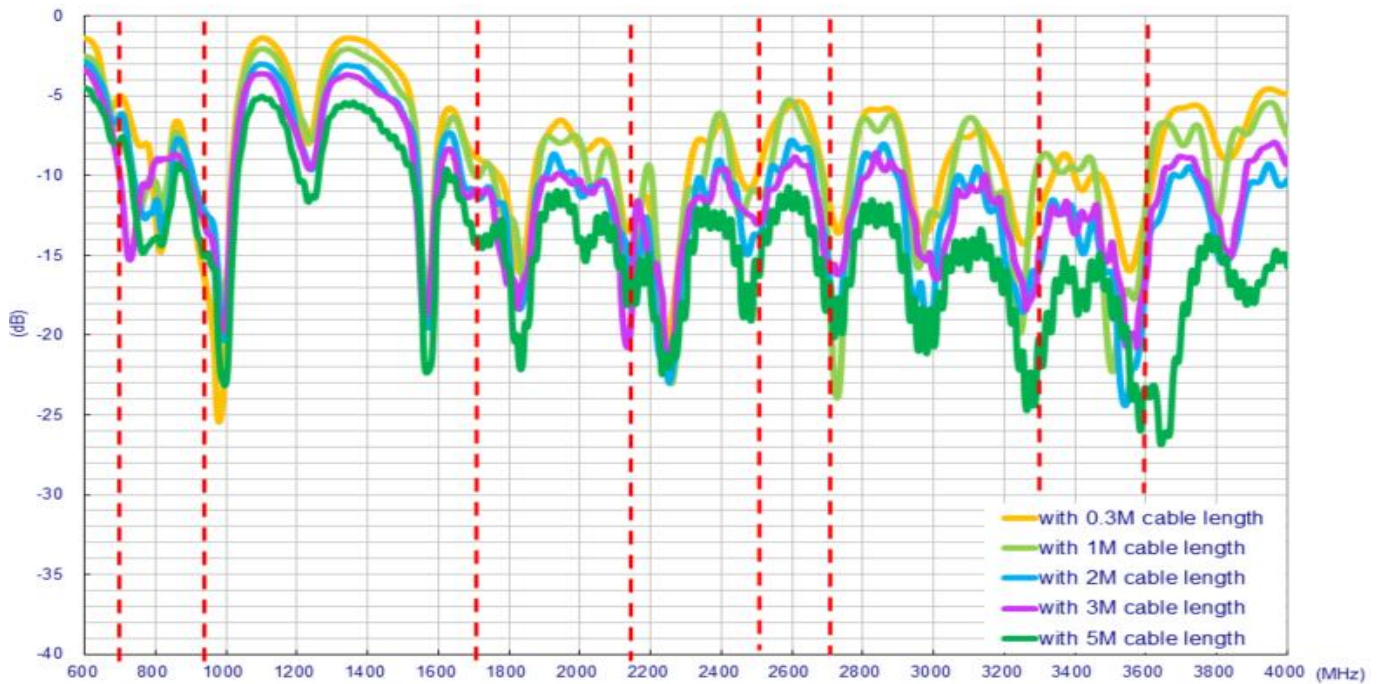

#### 7.1.2. Return Loss (LTE MIMO\_2)

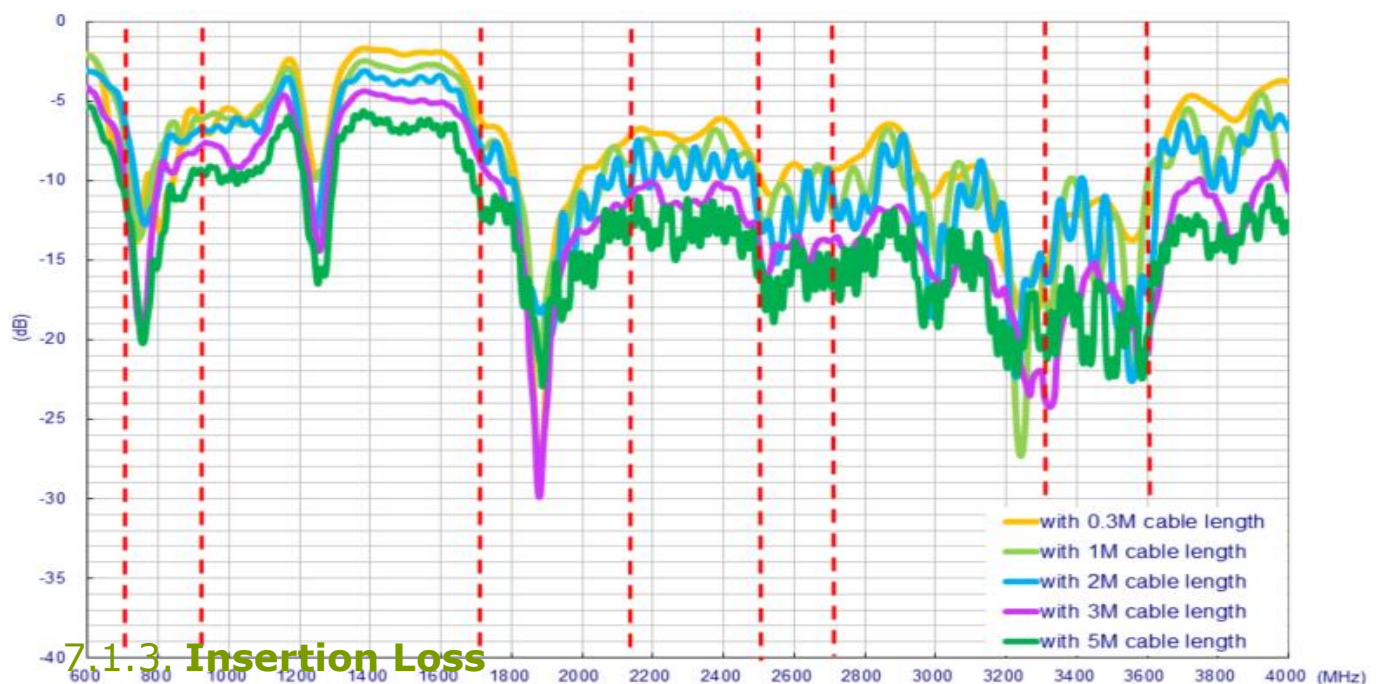

#### 7.1.3. Insertion Loss

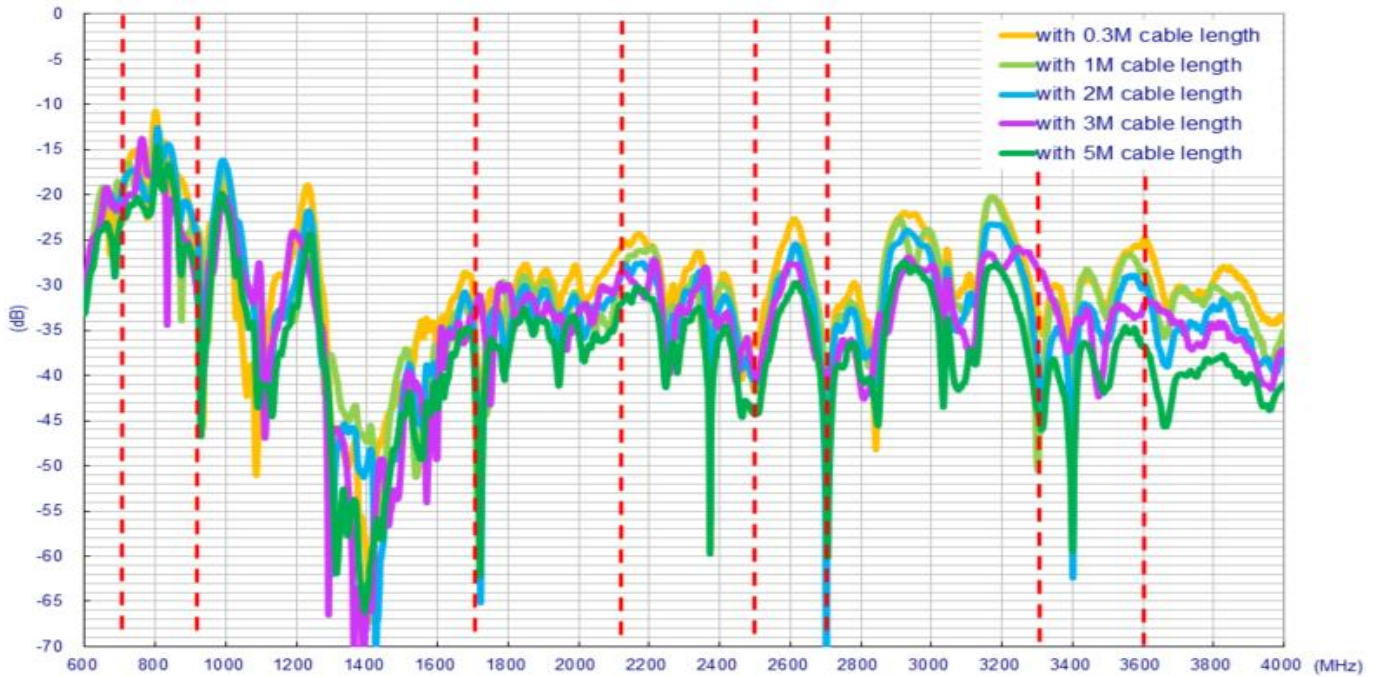

### 7.1.4. Efficiency (LTE MIMO\_1)

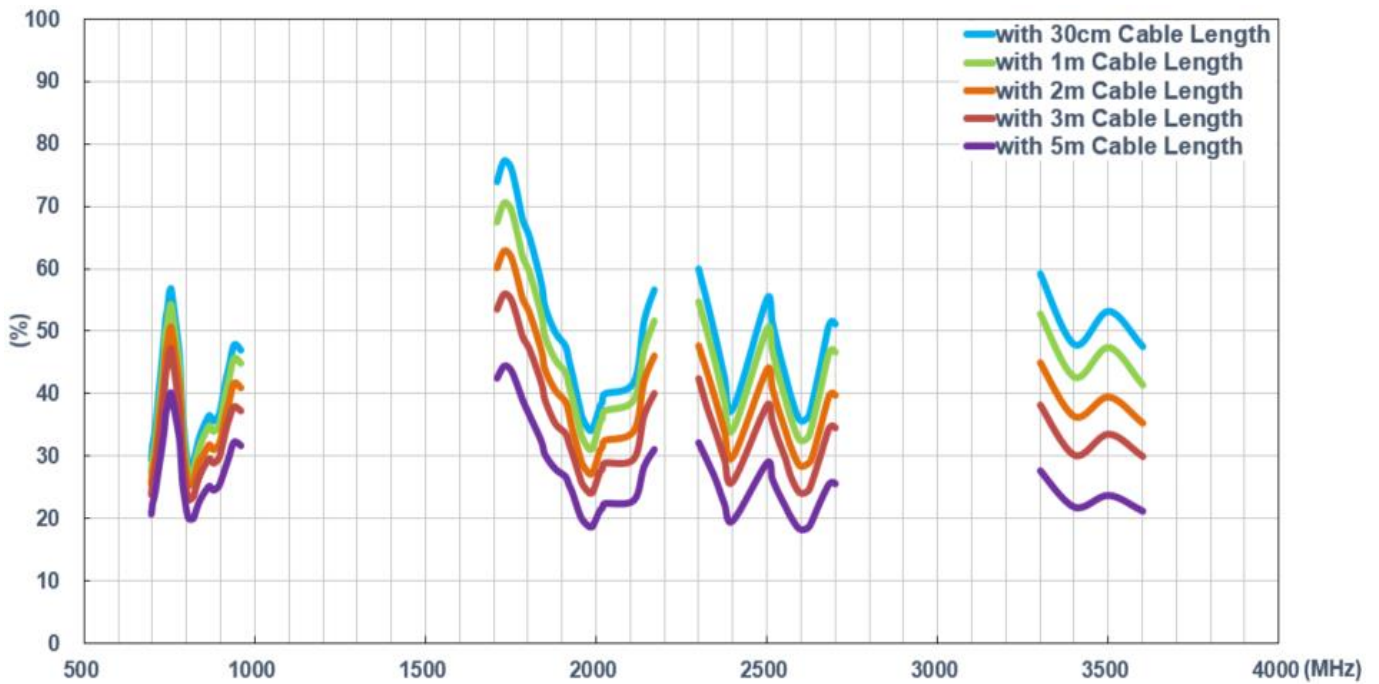

### 7.1.5. Efficiency (LTE MIMO\_2)



### 7.1.6. Average Gain (LTE MIMO\_1)

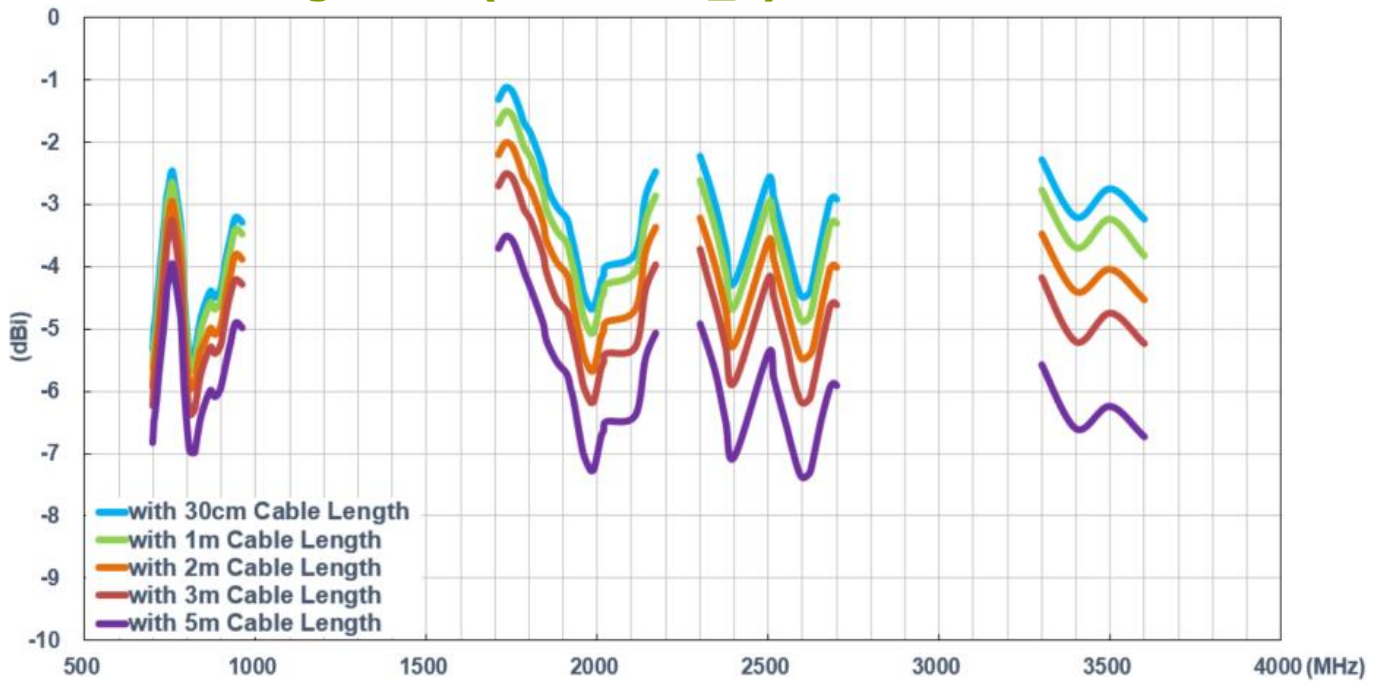

### 7.1.7. Average Gain (LTE MIMO\_2)

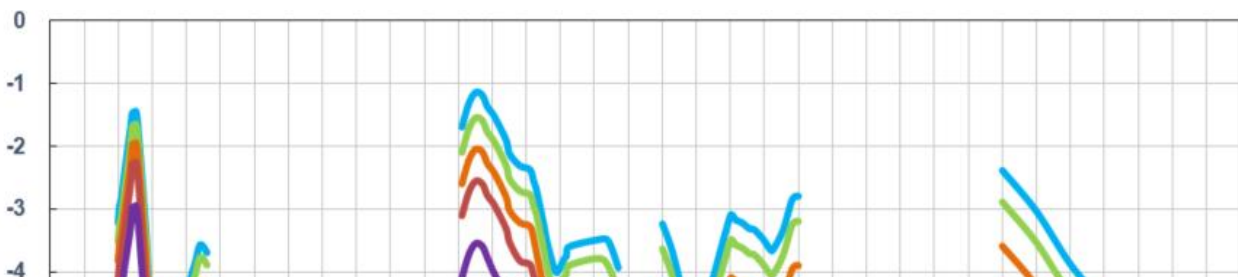



### 7.1.8. Peak Gain (LTE MIMO\_1)

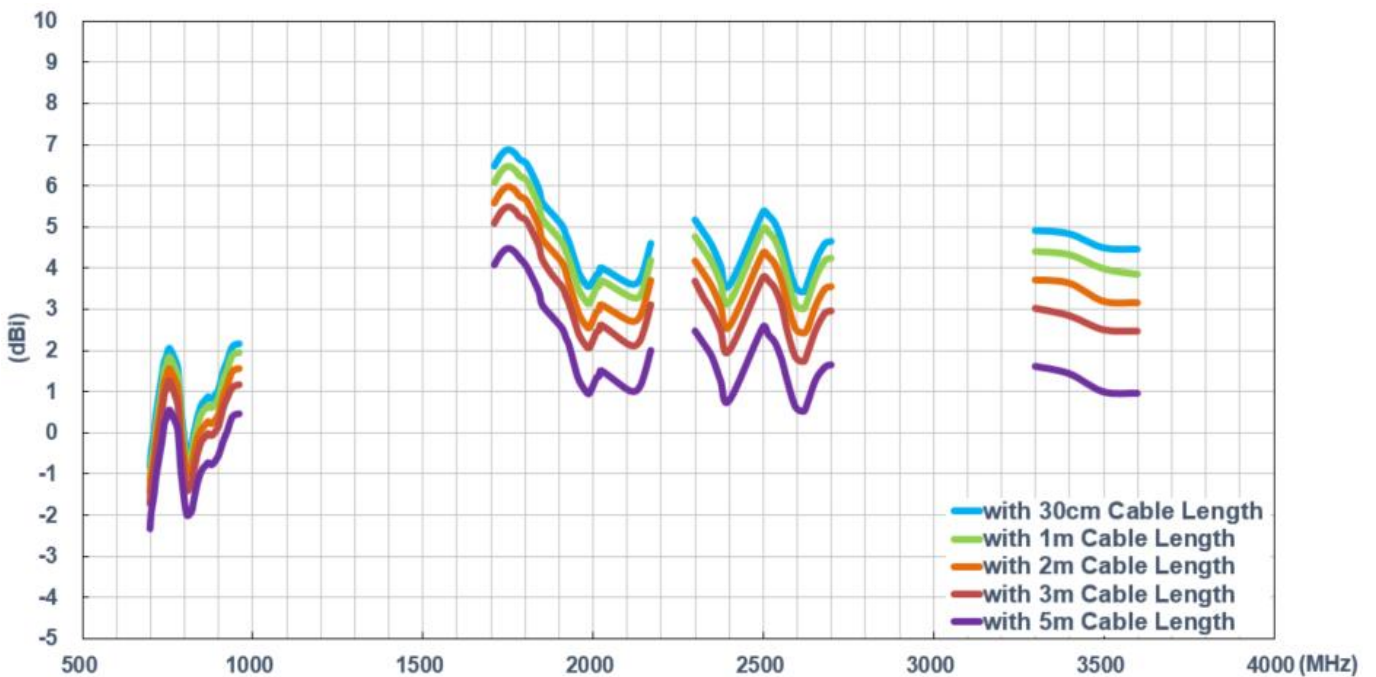

### 7.1.9. Peak Gain (LTE MIMO\_2)

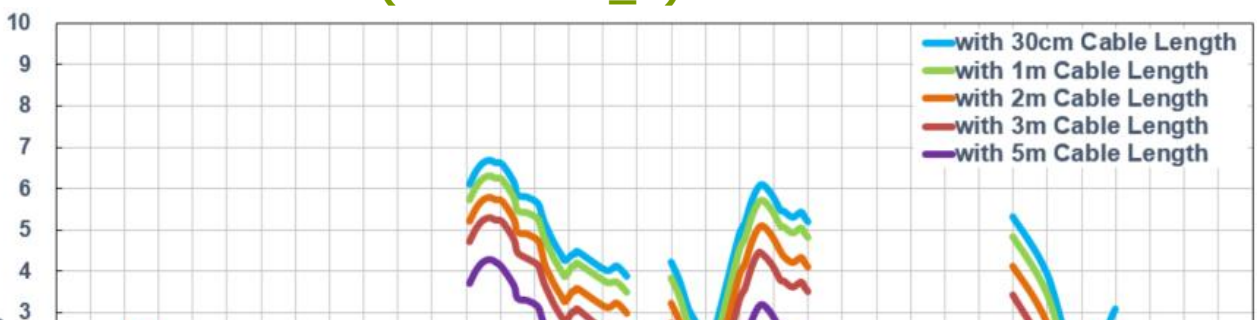

## 7.2. In free space (Wi-Fi MIMO Antenna)

### 7.2.1. Return Loss (Wi-Fi MIMO\_1)

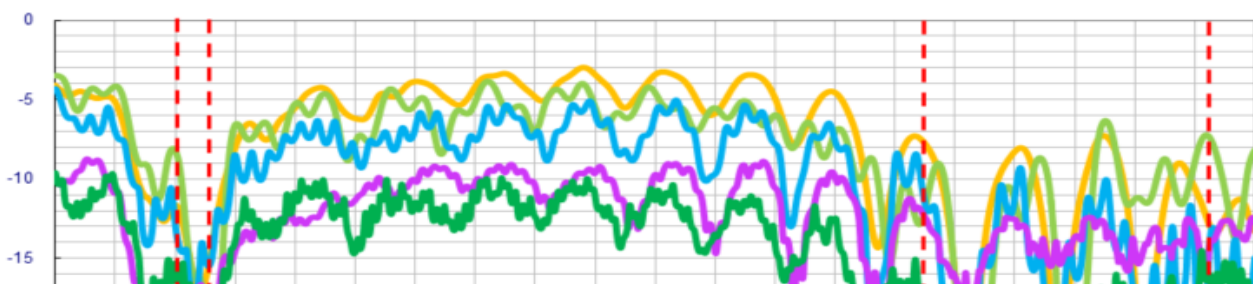

### 7.2.2. Return Loss (Wi-Fi MIMO\_2)

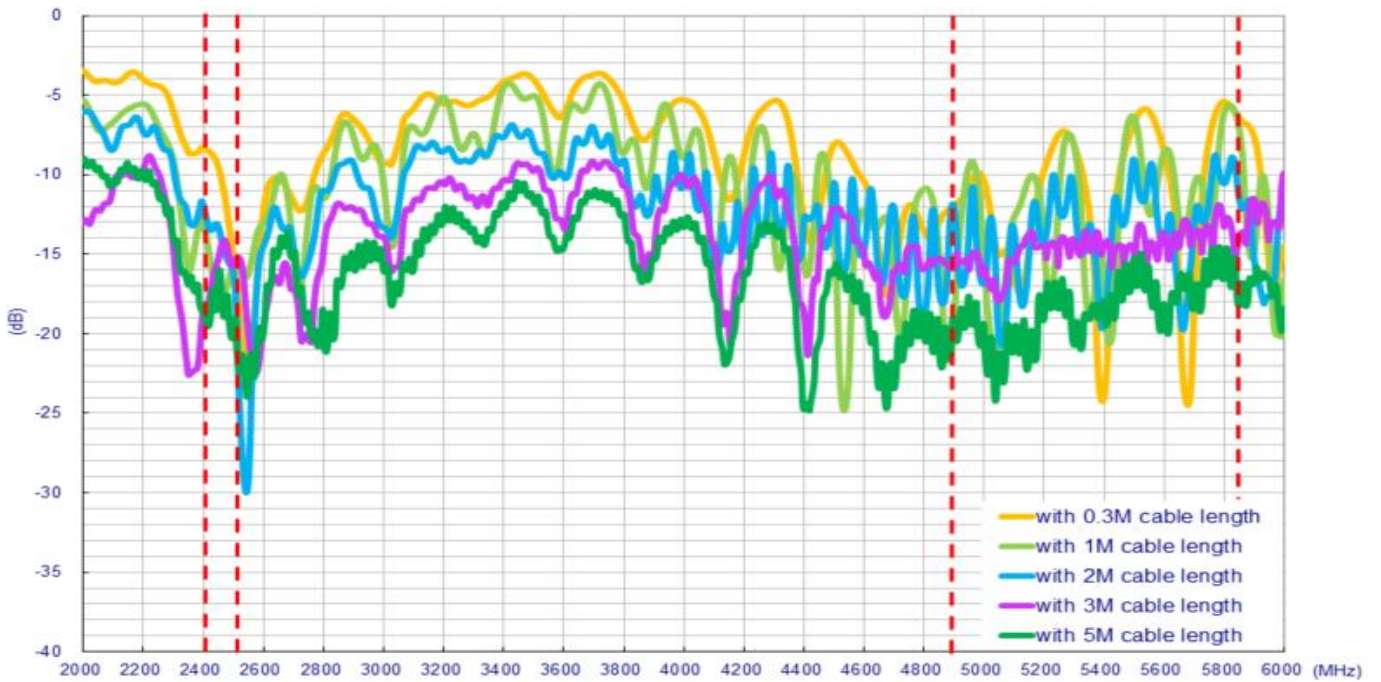

### 7.2.3. Insertion Loss

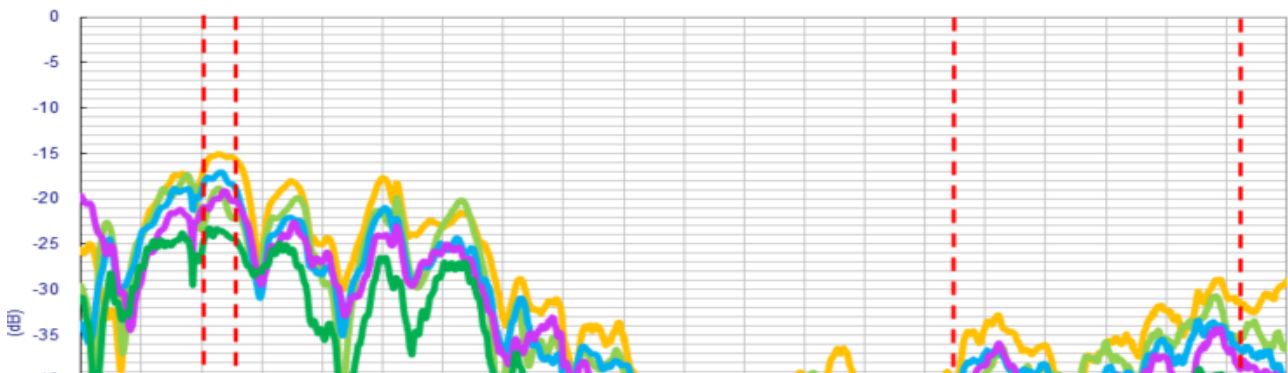

### 7.2.4. Efficiency (Wi-Fi MIMO\_1)

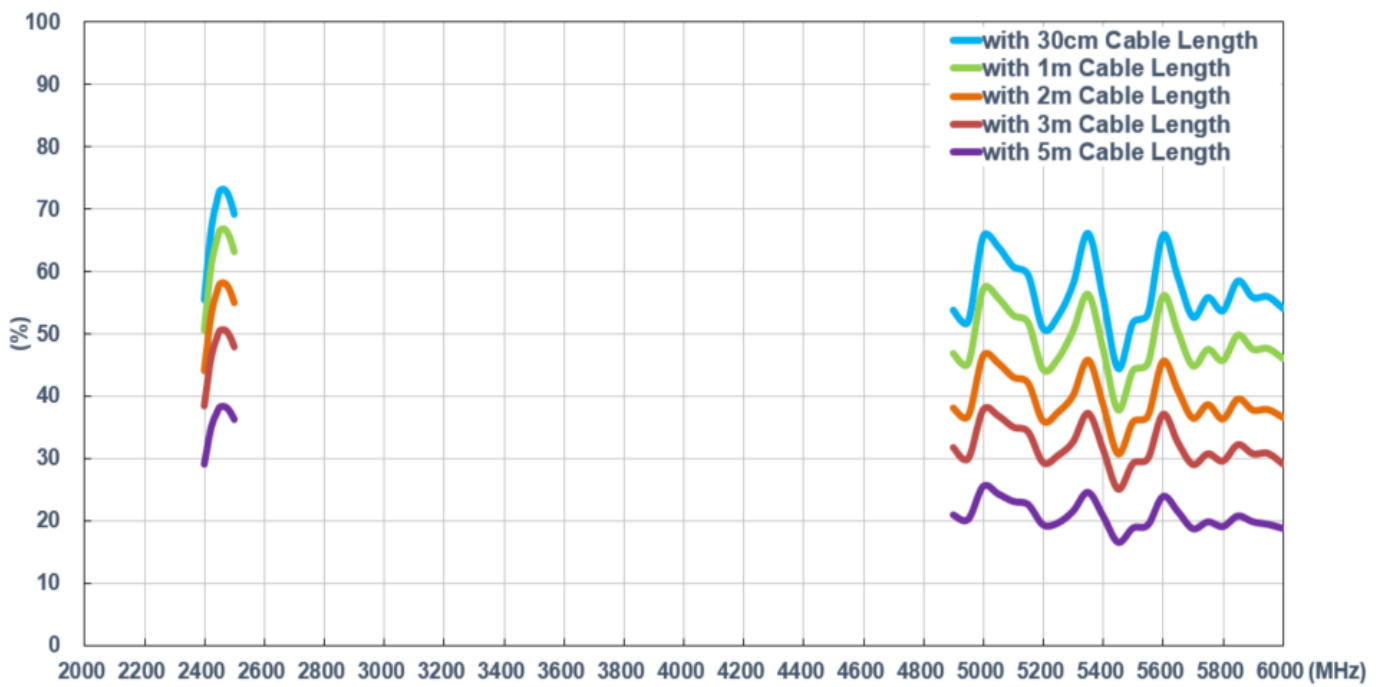

### 7.2.5. Efficiency (Wi-Fi MIMO\_2)

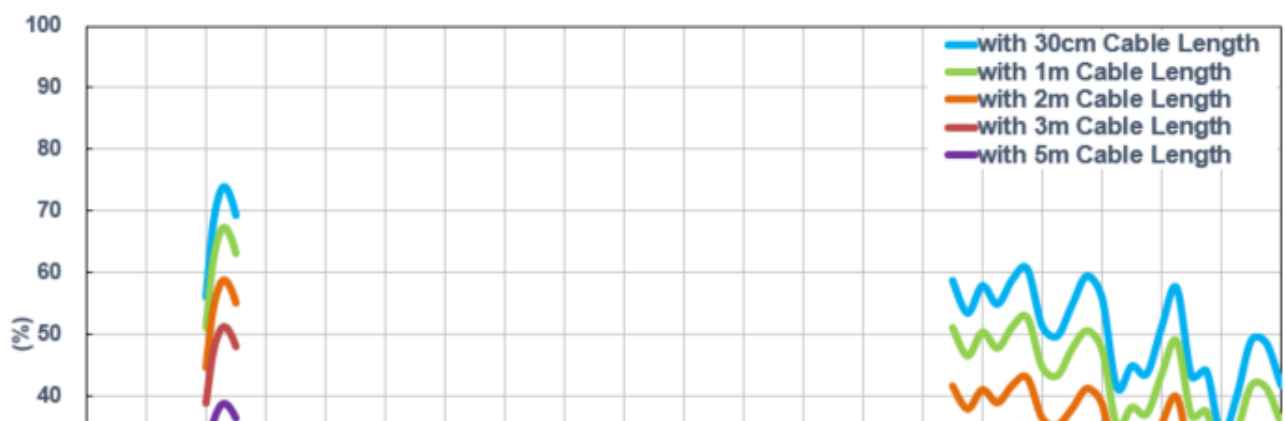

### 7.2.6. Average Gain (Wi-Fi MIMO\_1)

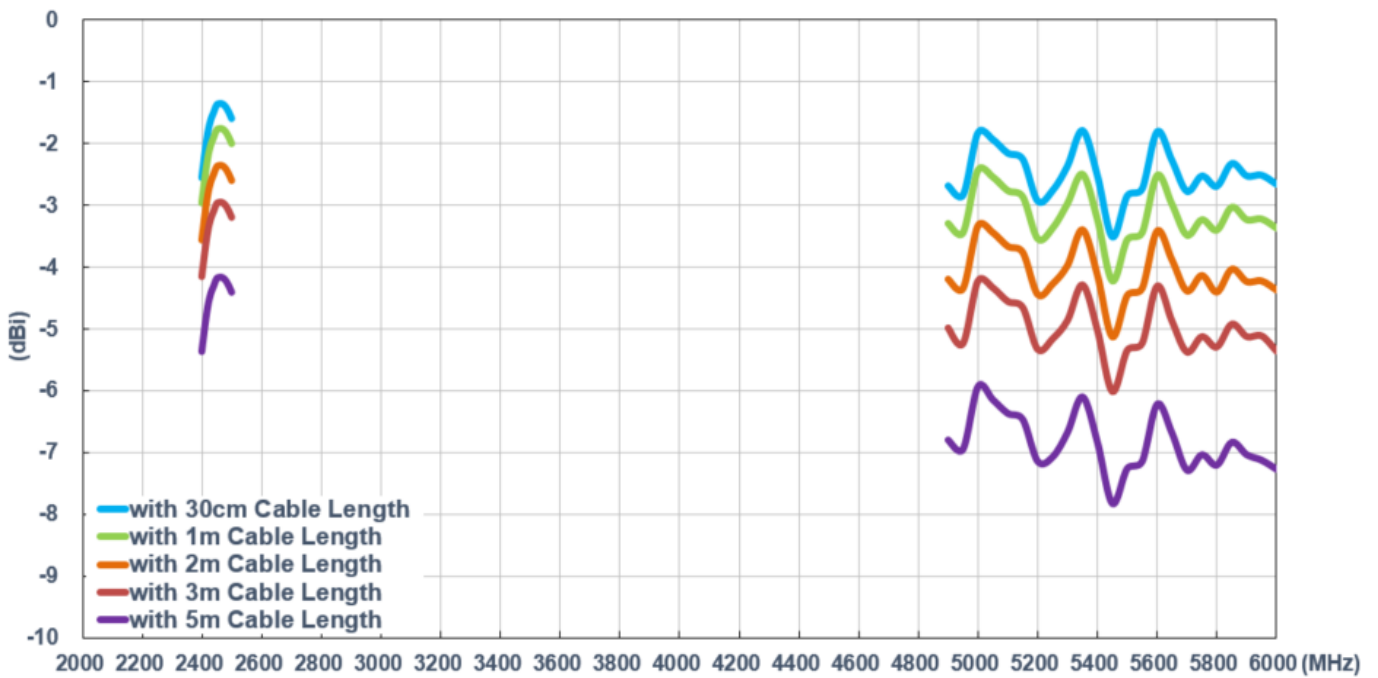

### 7.2.7. Average Gain (Wi-Fi MIMO\_2)

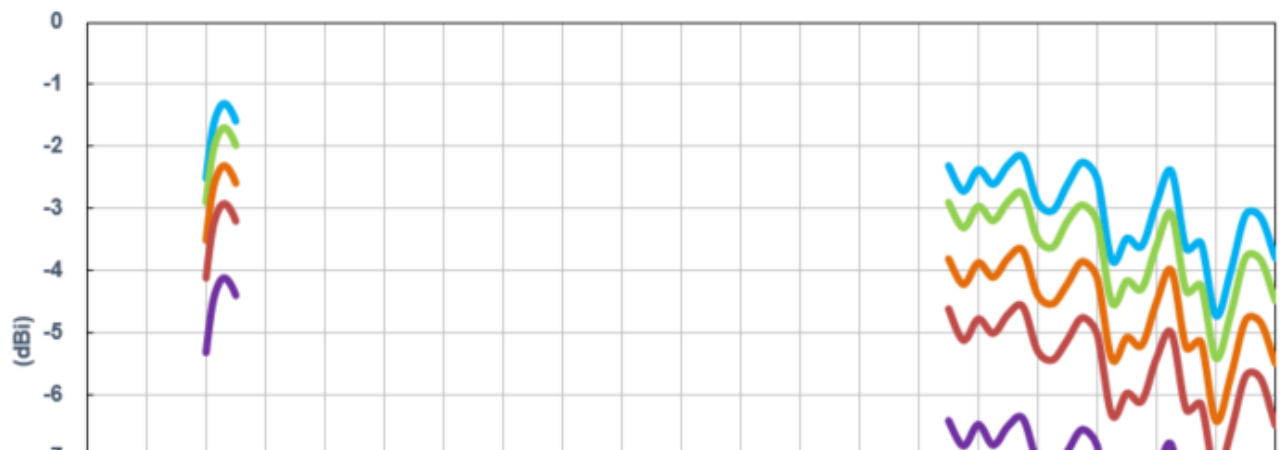



### 7.2.8. Peak Gain (Wi-Fi MIMO\_1)

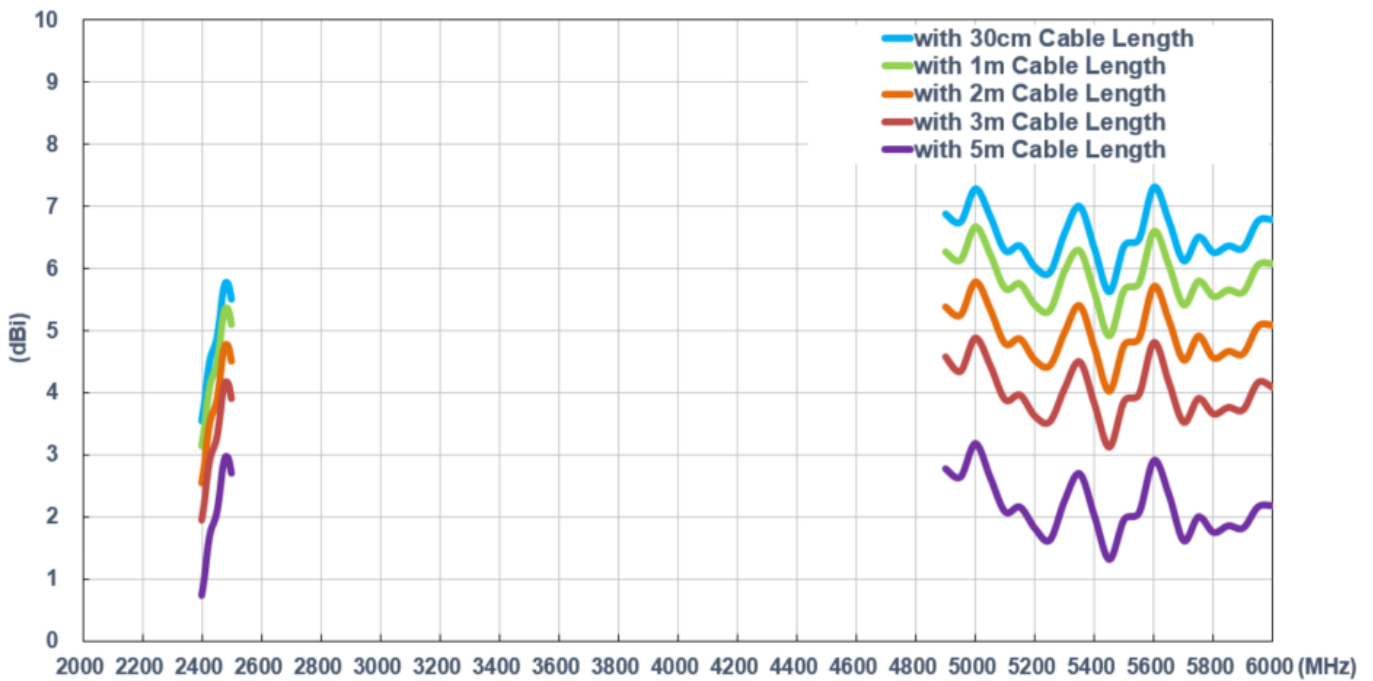

### 7.2.9. Peak Gain (Wi-Fi MIMO\_2)

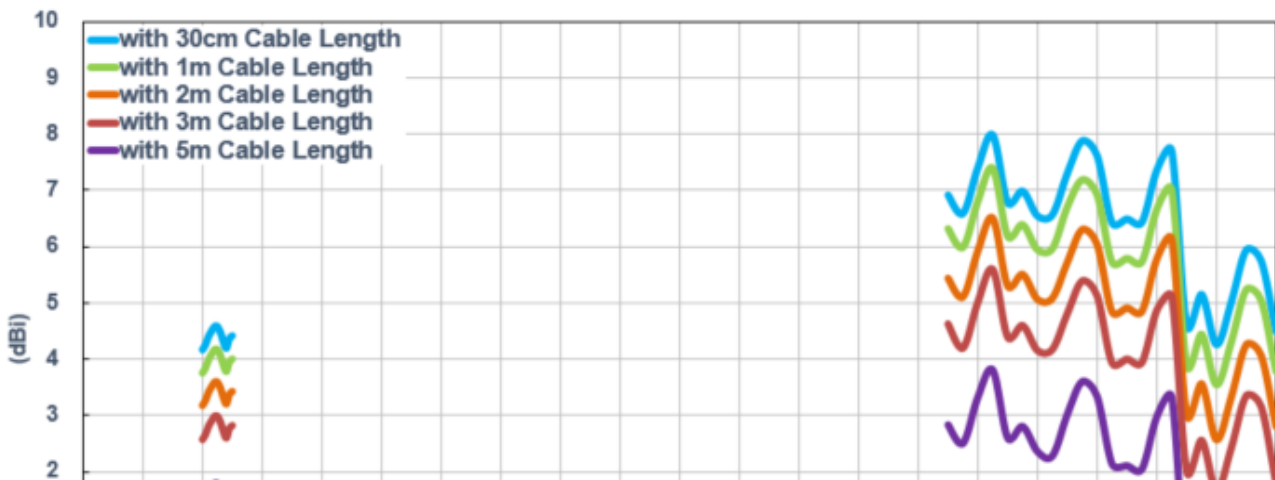



Taoglas makes no warranties based on the accuracy or completeness of the contents of this document and reserves the right to make changes to specifications and product descriptions at any time without notice. Taoglas reserves all rights to this document and the information contained herein.

Reproduction, use or disclosure to third parties without express permission is strictly prohibited.

Copyright © Taoglas Ltd.



Компания «ЭлектроПласт» предлагает заключение долгосрочных отношений при поставках импортных электронных компонентов на взаимовыгодных условиях!

Наши преимущества:

- Оперативные поставки широкого спектра электронных компонентов отечественного и импортного производства напрямую от производителей и с крупнейших мировых складов;
- Поставка более 17-ти миллионов наименований электронных компонентов;
- Поставка сложных, дефицитных, либо снятых с производства позиций;
- Оперативные сроки поставки под заказ (от 5 рабочих дней);
- Экспресс доставка в любую точку России;
- Техническая поддержка проекта, помощь в подборе аналогов, поставка прототипов;
- Система менеджмента качества сертифицирована по Международному стандарту ISO 9001;
- Лицензия ФСБ на осуществление работ с использованием сведений, составляющих государственную тайну;
- Поставка специализированных компонентов (Xilinx, Altera, Analog Devices, Intersil, Interpoint, Microsemi, Aeroflex, Peregrine, Syfer, Eurofarad, Texas Instrument, Miteq, Cobham, E2V, MA-COM, Hittite, Mini-Circuits, General Dynamics и др.);

Помимо этого, одним из направлений компании «ЭлектроПласт» является направление «Источники питания». Мы предлагаем Вам помощь Конструкторского отдела:

- Подбор оптимального решения, техническое обоснование при выборе компонента;
- Подбор аналогов;
- Консультации по применению компонента;
- Поставка образцов и прототипов;
- Техническая поддержка проекта;
- Защита от снятия компонента с производства.



#### Как с нами связаться

**Телефон:** 8 (812) 309 58 32 (многоканальный)

**Факс:** 8 (812) 320-02-42

**Электронная почта:** [org@eplast1.ru](mailto:org@eplast1.ru)

**Адрес:** 198099, г. Санкт-Петербург, ул. Калинина, дом 2, корпус 4, литера А.