

## Optocoupler, Phototriac Output, 400 V<sub>DRM</sub>

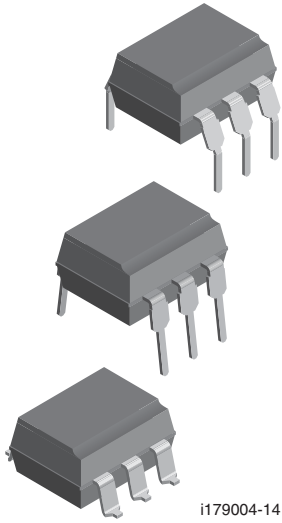

i179004-14

Note: pin 5 must not be connected

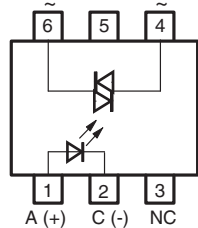

### FEATURES

- 400 V blocking voltage
- Isolation test voltage, 5000 V<sub>RMS</sub>, t = 1 min
- Material categorization: for definitions of compliance please see [www.vishay.com/doc?99912](http://www.vishay.com/doc?99912)



RoHS COMPLIANT

### APPLICATIONS

- High current triac driver
- Solid-state relay
- Switch small AC loads

### AGENCY APPROVALS

(all parts are certified under base model VO3020)

- UL1577, file no. E52744 double protection
- cUL tested to CSA 22.2 bulletin 5A
- DIN EN 60747-5-5 (VDE 0884-5), available with option 1
- FIMKO EN 60950-1
- CQC GB8898-2011, GB4943.1-2011

### DESCRIPTION

The VO3020 series consists of a phototriac optically coupled to a gallium arsenide infrared-emitting diode in a 6-lead plastic dual inline package

ORDERING INFORMATION					
<div style="display: flex; justify-content: space-around; align-items: center;"> <div style="border: 1px solid black; padding: 2px 5px;">V</div> <div style="border: 1px solid black; padding: 2px 5px;">O</div> <div style="border: 1px solid black; padding: 2px 5px;">3</div> <div style="border: 1px solid black; padding: 2px 5px;">0</div> <div style="border: 1px solid black; padding: 2px 5px;">2</div> <div style="border: 1px solid black; padding: 2px 5px;">#</div> <div style="border: 1px solid black; padding: 2px 5px;">-</div> <div style="border: 1px solid black; padding: 2px 5px;">X</div> <div style="border: 1px solid black; padding: 2px 5px;">0</div> <div style="border: 1px solid black; padding: 2px 5px;">0</div> <div style="border: 1px solid black; padding: 2px 5px;">#</div> <div style="border: 1px solid black; padding: 2px 5px;">T</div> </div> <p style="text-align: center;">PART NUMBER                      PACKAGE OPTION                      TAPE AND REEL</p>					
AGENCY CERTIFIED / PACKAGE	TRIGGER CURRENT, I <sub>FT</sub>				
UL, cUL, CQC	5 mA	10 mA	15 mA	30 mA	
DIP-6	VO3023	VO3022	VO3021	VO3020	
DIP-6, 400 mil, option 6	VO3023-X006	VO3022-X006	VO3021-X006	VO3020-X006	
SMD-6, option 7	VO3023-X007T	VO3022-X007T	VO3021-X007T	VO3020-X007T	
VDE, UL, cUL, FIMKO, CQC	5 mA	10 mA	15 mA	30 mA	
DIP-6	VO3023-X001	VO3022-X001	VO3021-X001	VO3020-X001	
SMD-6, option 7	VO3023-X017T	-	VO3021-X017T	VO3020-X017T	

### Note

- Additional options may be possible, please contact sales office



ABSOLUTE MAXIMUM RATINGS (T <sub>amb</sub> = 25 °C, unless otherwise specified)				
PARAMETER	TEST CONDITION	SYMBOL	VALUE	UNIT
<b>INPUT</b>				
Reverse voltage		V <sub>R</sub>	6	V
Forward current		I <sub>F</sub>	50	mA
Peak surge current	100 μs, 200 pps	I <sub>FSM</sub>	0.5	A
Power dissipation		P <sub>diss</sub>	70	mW
<b>OUTPUT</b>				
Peak off-state voltage		V <sub>DRM</sub>	400	V
RMS on-state current		I <sub>T(RMS)</sub>	0.1	A
Peak non-repetitive surge current	PW = 100 ms, 120 pps	I <sub>TSM</sub>	1	A
Power dissipation		P <sub>diss</sub>	300	mW
<b>COUPLER</b>				
Isolation voltage	t = 1 min	V <sub>ISO</sub>	5000	V <sub>RMS</sub>
Total power dissipation		P <sub>tot</sub>	330	mW
Storage temperature range		T <sub>stg</sub>	-55 to +150	°C
Ambient temperature		T <sub>amb</sub>	-40 to +100	°C
Lead soldering temperature <sup>(1)</sup>	2 mm from case, t < 10 s	T <sub>slid</sub>	260	°C
Junction temperature		T <sub>j</sub>	125	°C

Notes

- Stresses in excess of the absolute maximum ratings can cause permanent damage to the device. Functional operation of the device is not implied at these or any other conditions in excess of those given in the operational sections of this document. Exposure to absolute maximum ratings for extended periods of the time can adversely affect reliability.
- <sup>(1)</sup> Refer to reflow profile for soldering conditions for surface mounted devices (SMD). Refer to wave profile for soldering conditions for through hole devices (DIP)

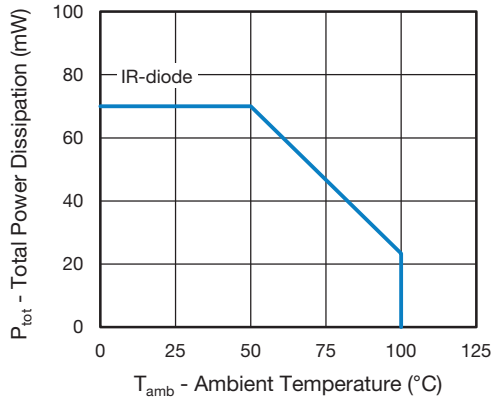

Fig. 1 - Total Power Dissipation vs. Ambient Temperature (IR-Diode)

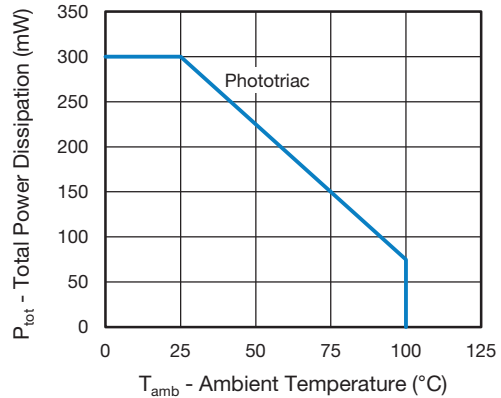

Fig. 2 - Total Power Dissipation vs. Ambient Temperature (Phototriac)



<b>ELECTRICAL CHARACTERISTICS</b> ( $T_{amb} = 25\text{ }^{\circ}\text{C}$ , unless otherwise specified)							
PARAMETER	TEST CONDITION	PART	SYMBOL	MIN.	TYP.	MAX.	UNIT
<b>INPUT</b>							
Forward voltage	$I_F = 20\text{ mA}$		$V_F$	-	1.3	1.5	V
Reverse voltage	$I_R = 10\text{ }\mu\text{A}$		$V_R$	6	-	-	V
Reverse current	$V_R = 6\text{ V}$		$I_R$	-	-	10	$\mu\text{A}$
Junction capacitance	$V_R = 0\text{ V}$ , $f = 1\text{ MHz}$		$C_j$	-	50	-	pF
<b>OUTPUT</b>							
Peak off-state current, either direction	$V_{DRM} = 400\text{ V}^{(1)}$		$I_{DRM}$	-	10	100	nA
Peak off-state voltage, either direction	$I_{TM} = 100\text{ mA}$		$V_{TM}$	-	1.7	3	V
Critical rate of rise of off-state voltage	$I_F = 0\text{ A}$ , $V_D = 0.67\text{ }V_{DRM}$		$dV/dt_{cr}$	100	-	-	V/ $\mu\text{s}$
<b>COUPLER</b> <sup>(2)</sup>							
Emitting diode trigger current	$V_S = 3\text{ V}$ , $R_L = 150\text{ }\Omega$	VO3020	$I_{FT}$	-	15	30	mA
		VO3021	$I_{FT}$	-	8	15	mA
		VO3022	$I_{FT}$	-	5	10	mA
		VO3023	$I_{FT}$	-	3	5	mA
Holding current	$I_F = 10\text{ mA}$ , $V_S \geq 3\text{ V}$		$I_H$	-	200	-	$\mu\text{A}$

**Notes**

- Minimum and maximum values are testing requirements. Typical values are characteristics of the device and are the result of engineering evaluation. Typical values are for information only and are not part of the testing requirements
- (1) Test voltage must be applied within  $dV/dt$  ratings
- (2)  $I_{FT}$  is defined as a minimum trigger current

<b>SAFETY AND INSULATION RATINGS</b>				
PARAMETER		SYMBOL	VALUE	UNIT
<b>MAXIMUM SAFETY RATINGS</b>				
Output safety power		$P_{SO}$	700	mW
Input safety current		$I_{si}$	400	mA
Safety temperature		$T_S$	175	$^{\circ}\text{C}$
Comparative tracking index		CTI	175	
<b>INSULATION RATED PARAMETERS</b>				
Maximum withstanding isolation voltage		$V_{ISO}$	5000	$V_{RMS}$
Maximum transient isolation voltage		$V_{IOTM}$	8000	$V_{peak}$
Maximum repetitive peak isolation voltage		$V_{IORM}$	890	$V_{peak}$
		$V_{IORM}$	1140 <sup>(1)</sup>	$V_{peak}$
Insulation resistance	$T_{amb} = 25\text{ }^{\circ}\text{C}$ , $V_{DC} = 500\text{ V}$	$R_{IO}$	$10^{12}$	$\Omega$
Isolation resistance	$T_{amb} = 100\text{ }^{\circ}\text{C}$ , $V_{DC} = 500\text{ V}$	$R_{IO}$	$10^{11}$	$\Omega$
Climatic classification (according to IEC 68 part 1)			55 / 115 / 21	
Environment (pollution degree in accordance to DIN VDE 0109)			2	
Creepage distance (standard DIP-6)			$\geq 7$	mm
Creepage distance (400 mil DIP-6)			$\geq 8$	mm
Clearance distance (standard DIP-6)			$\geq 7$	mm
Clearance distance (400 mil DIP-6)			$\geq 8$	mm
Insulation thickness			$\geq 0.4$	mm

**Notes**

- As per DIN EN 60747-5-5, § 7.4.3.8.2, this optocoupler is suitable for "safe electrical insulation" only within the safety ratings. Compliance with the safety ratings shall be ensured by means of protective circuits
- (1) 400 mil, option 6 only



TYPICAL CHARACTERISTICS (T<sub>amb</sub> = 25 °C, unless otherwise specified)

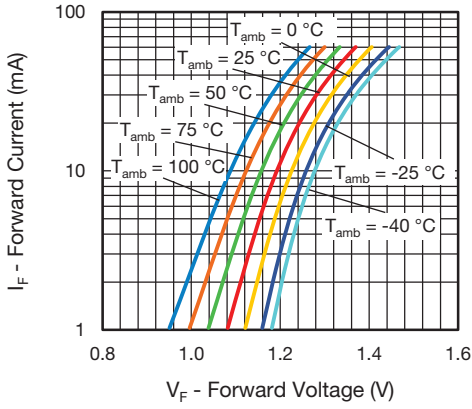

Fig. 3 - Forward Current vs. Forward Voltage

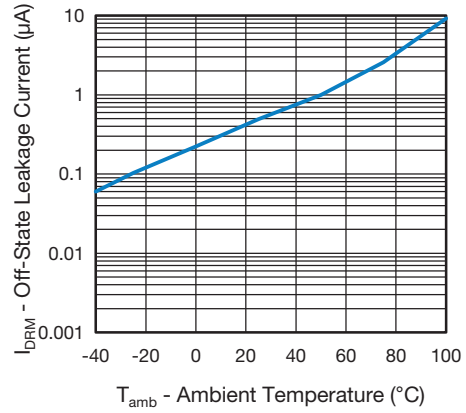

Fig. 6 - Off-State Leakage Current vs. Ambient Temperature

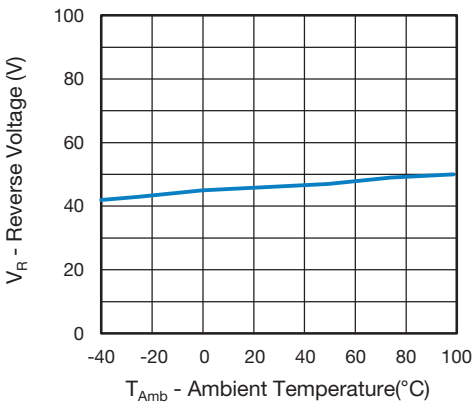

Fig. 4 - Reverse Voltage vs. Ambient Temperature

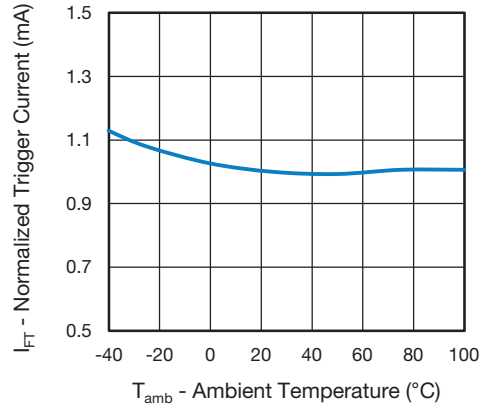

Fig. 7 - Normalized Trigger Current vs. Ambient Temperature

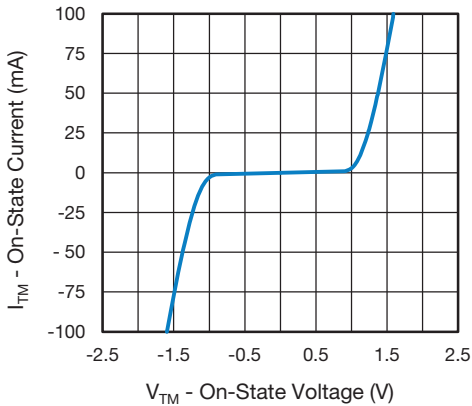

Fig. 5 - On-State Current vs. On-State Voltage

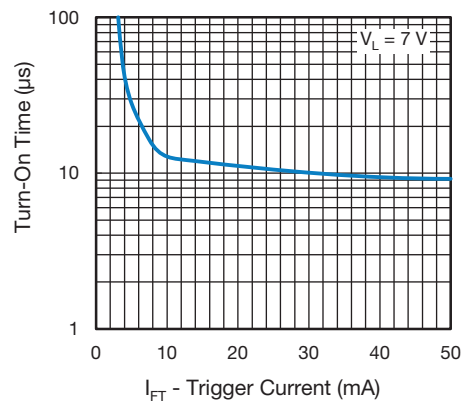

Fig. 8 - Turn-On Time vs. Trigger Current

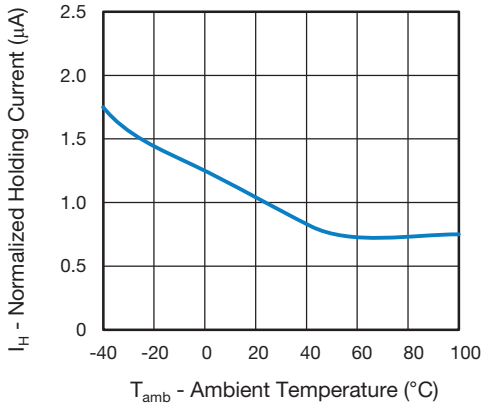

Fig. 9 - Normalized Holding Current vs. Ambient Temperature

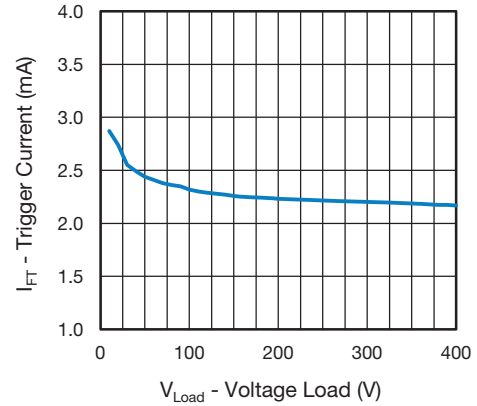

Fig. 12 - Trigger Current vs. Voltage Load

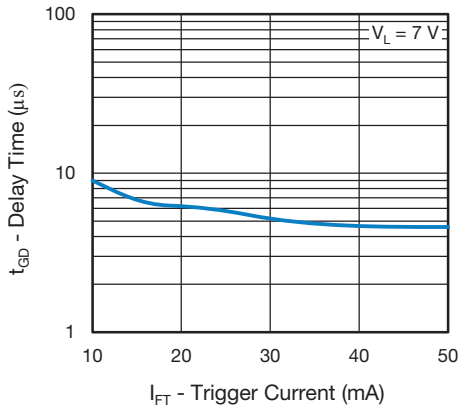

Fig. 10 - Delay Time vs. Trigger Current

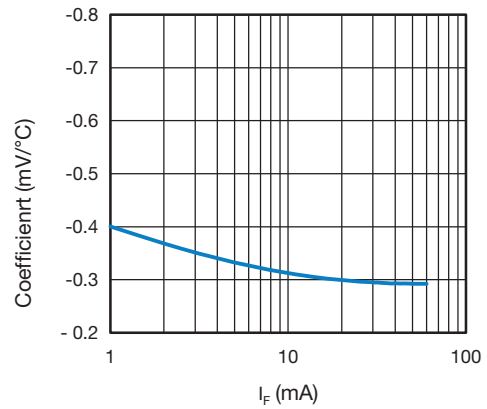

Fig. 13 - Coefficient vs. Forward Current

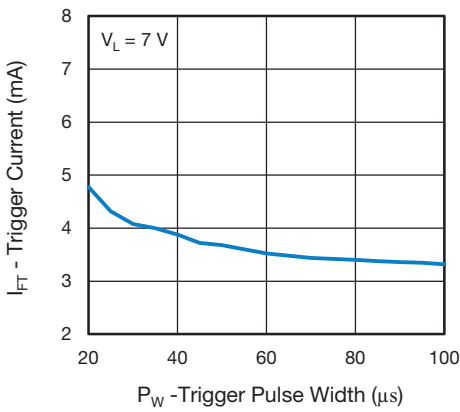

Fig. 11 - Trigger Current vs. Trigger Pulse Width

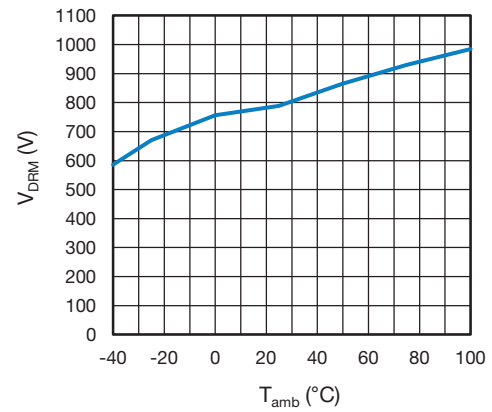

Fig. 14 - Peak Off-State Voltage vs. Ambient Temperature

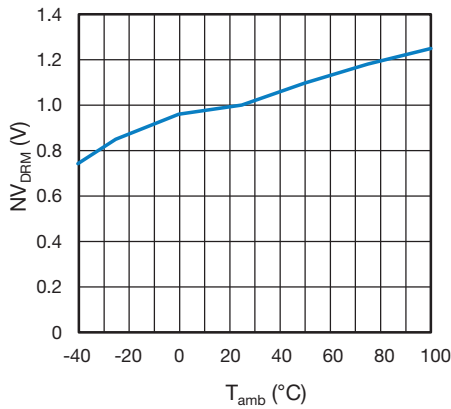
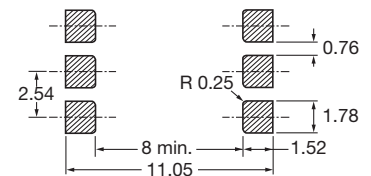
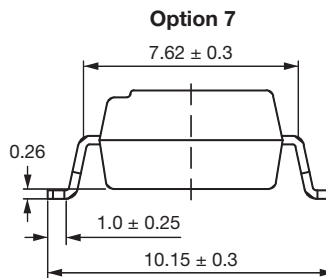
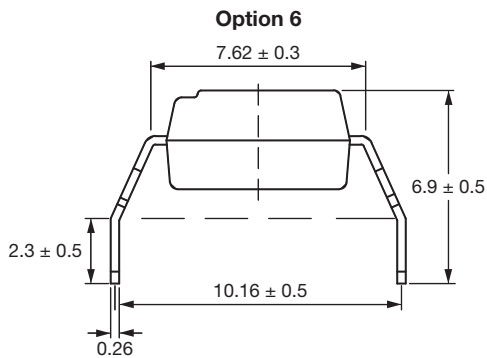
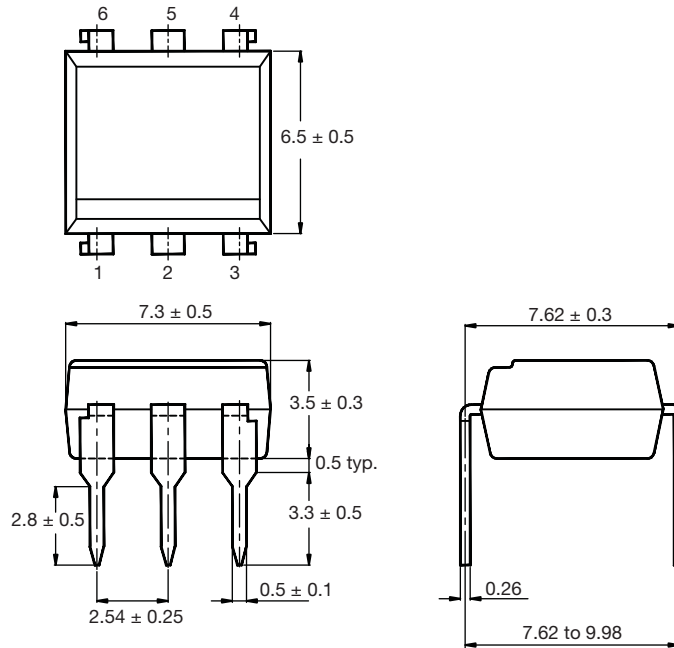

Fig. 15 - Normalized Off-State Voltage M2/M1 vs. Ambient Temperature

**PACKAGE DIMENSIONS** in millimeters



**PACKAGE MARKING**

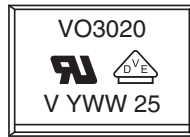

Fig. 16 - Example VO3020-X017T

**Notes**

- VDE logo is only marked on option 1 parts. Option information is not marked on the part
- Tape and reel suffix (T) is not part of the package marking

**PACKING INFORMATION**

DEVICES PER TUBE			
TYPE	UNITS/TUBE	TUBES/BOX	UNITS/BOX
DIP-6	50	40	2000

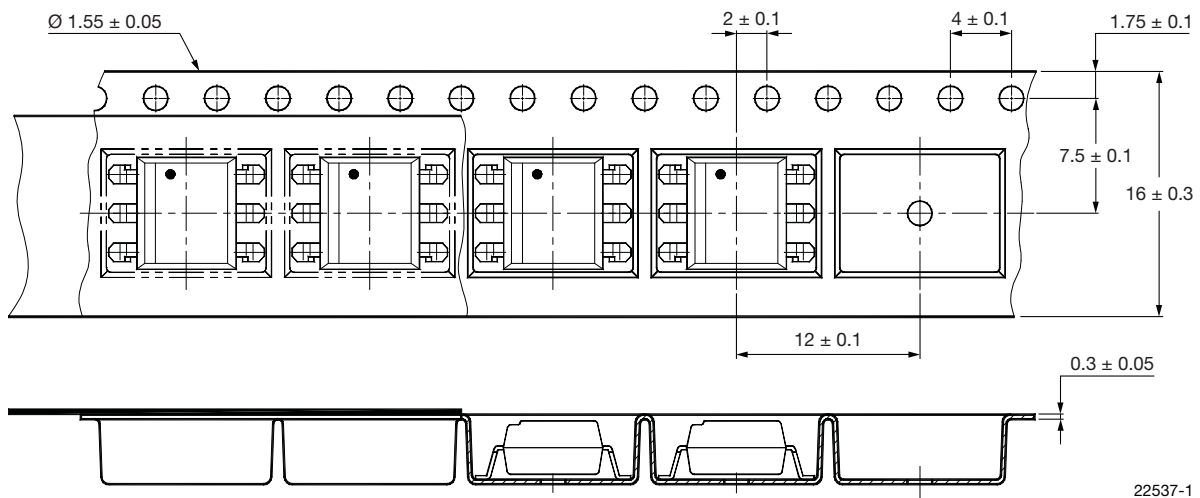

22537-1

Fig. 17 - Tape and Reel Drawing, 1000 Units per Reel

**REEL DIMENSIONS** in millimeters

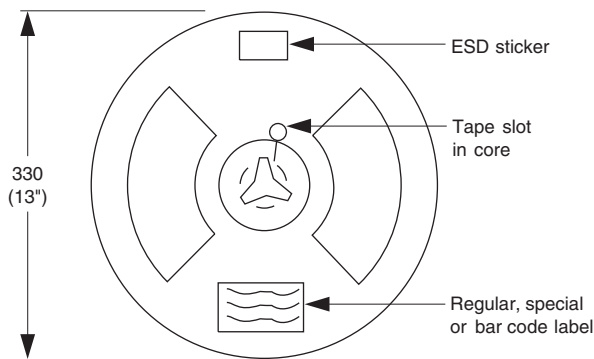

17999

Fig. 18 - Reel Dimensions



## **Disclaimer**

ALL PRODUCT, PRODUCT SPECIFICATIONS AND DATA ARE SUBJECT TO CHANGE WITHOUT NOTICE TO IMPROVE RELIABILITY, FUNCTION OR DESIGN OR OTHERWISE.

Vishay Intertechnology, Inc., its affiliates, agents, and employees, and all persons acting on its or their behalf (collectively, "Vishay"), disclaim any and all liability for any errors, inaccuracies or incompleteness contained in any datasheet or in any other disclosure relating to any product.

Vishay makes no warranty, representation or guarantee regarding the suitability of the products for any particular purpose or the continuing production of any product. To the maximum extent permitted by applicable law, Vishay disclaims (i) any and all liability arising out of the application or use of any product, (ii) any and all liability, including without limitation special, consequential or incidental damages, and (iii) any and all implied warranties, including warranties of fitness for particular purpose, non-infringement and merchantability.

Statements regarding the suitability of products for certain types of applications are based on Vishay's knowledge of typical requirements that are often placed on Vishay products in generic applications. Such statements are not binding statements about the suitability of products for a particular application. It is the customer's responsibility to validate that a particular product with the properties described in the product specification is suitable for use in a particular application. Parameters provided in datasheets and / or specifications may vary in different applications and performance may vary over time. All operating parameters, including typical parameters, must be validated for each customer application by the customer's technical experts. Product specifications do not expand or otherwise modify Vishay's terms and conditions of purchase, including but not limited to the warranty expressed therein.

Except as expressly indicated in writing, Vishay products are not designed for use in medical, life-saving, or life-sustaining applications or for any other application in which the failure of the Vishay product could result in personal injury or death. Customers using or selling Vishay products not expressly indicated for use in such applications do so at their own risk. Please contact authorized Vishay personnel to obtain written terms and conditions regarding products designed for such applications.

No license, express or implied, by estoppel or otherwise, to any intellectual property rights is granted by this document or by any conduct of Vishay. Product names and markings noted herein may be trademarks of their respective owners.





Компания «ЭлектроПласт» предлагает заключение долгосрочных отношений при поставках импортных электронных компонентов на взаимовыгодных условиях!

Наши преимущества:

- Оперативные поставки широкого спектра электронных компонентов отечественного и импортного производства напрямую от производителей и с крупнейших мировых складов;
- Поставка более 17-ти миллионов наименований электронных компонентов;
- Поставка сложных, дефицитных, либо снятых с производства позиций;
- Оперативные сроки поставки под заказ (от 5 рабочих дней);
- Экспресс доставка в любую точку России;
- Техническая поддержка проекта, помощь в подборе аналогов, поставка прототипов;
- Система менеджмента качества сертифицирована по Международному стандарту ISO 9001;
- Лицензия ФСБ на осуществление работ с использованием сведений, составляющих государственную тайну;
- Поставка специализированных компонентов (Xilinx, Altera, Analog Devices, Intersil, Interpoint, Microsemi, Aeroflex, Peregrine, Syfer, Eurofarad, Texas Instrument, Miteq, Cobham, E2V, MA-COM, Hittite, Mini-Circuits, General Dynamics и др.);

Помимо этого, одним из направлений компании «ЭлектроПласт» является направление «Источники питания». Мы предлагаем Вам помощь Конструкторского отдела:

- Подбор оптимального решения, техническое обоснование при выборе компонента;
- Подбор аналогов;
- Консультации по применению компонента;
- Поставка образцов и прототипов;
- Техническая поддержка проекта;
- Защита от снятия компонента с производства.



#### Как с нами связаться

**Телефон:** 8 (812) 309 58 32 (многоканальный)

**Факс:** 8 (812) 320-02-42

**Электронная почта:** [org@eplast1.ru](mailto:org@eplast1.ru)

**Адрес:** 198099, г. Санкт-Петербург, ул. Калинина, дом 2, корпус 4, литера А.