

LOC		DIST		REVISIONS			
P	LTN	DESCRIPTION	DATE	DMN	APVD		
P4		REV PER ECR-13-015977	14OCT2013	CZ	SZ		
P5		REV PER ECR-13-004893	25NOV2013	ML	SZ		
P6		ADD NEW PART 5-6600333-2	11OCT2014	AY	SZ		
P7		REV PER ECR-15-007162	04MAY2015	CZ	SZ		

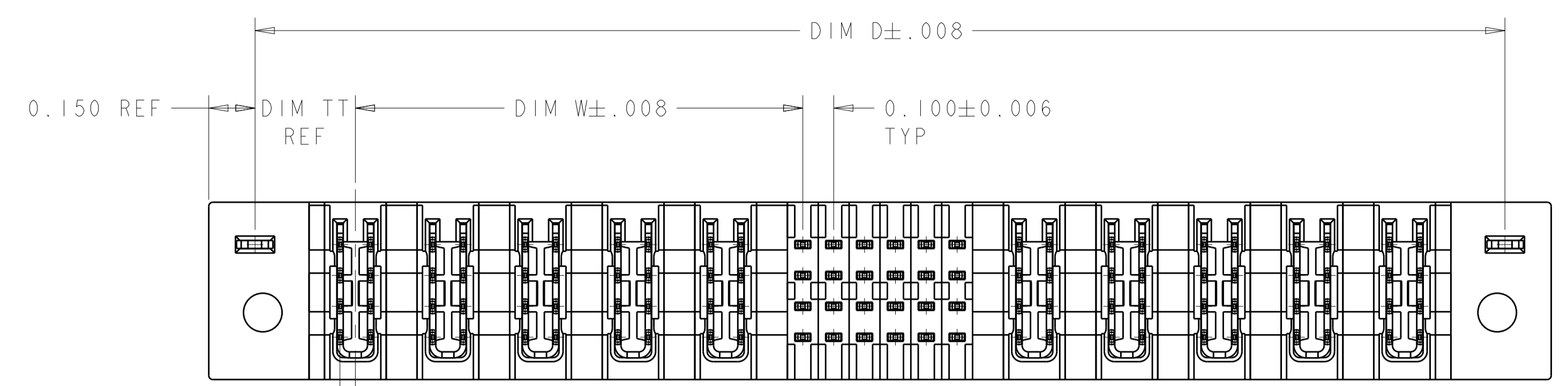

0.050 REF TYP

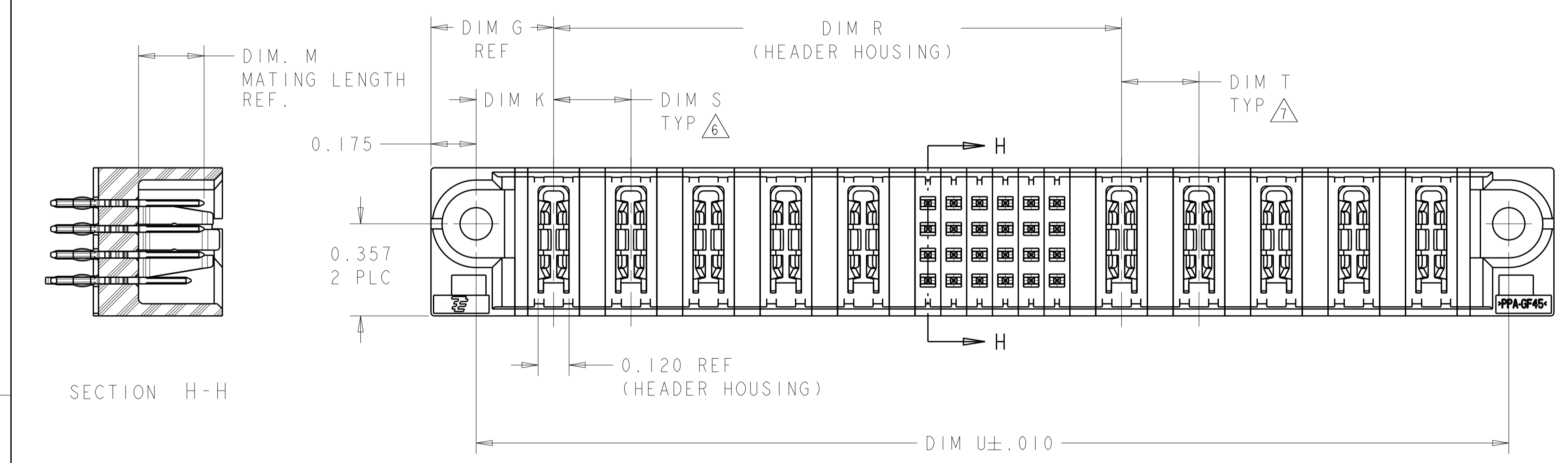
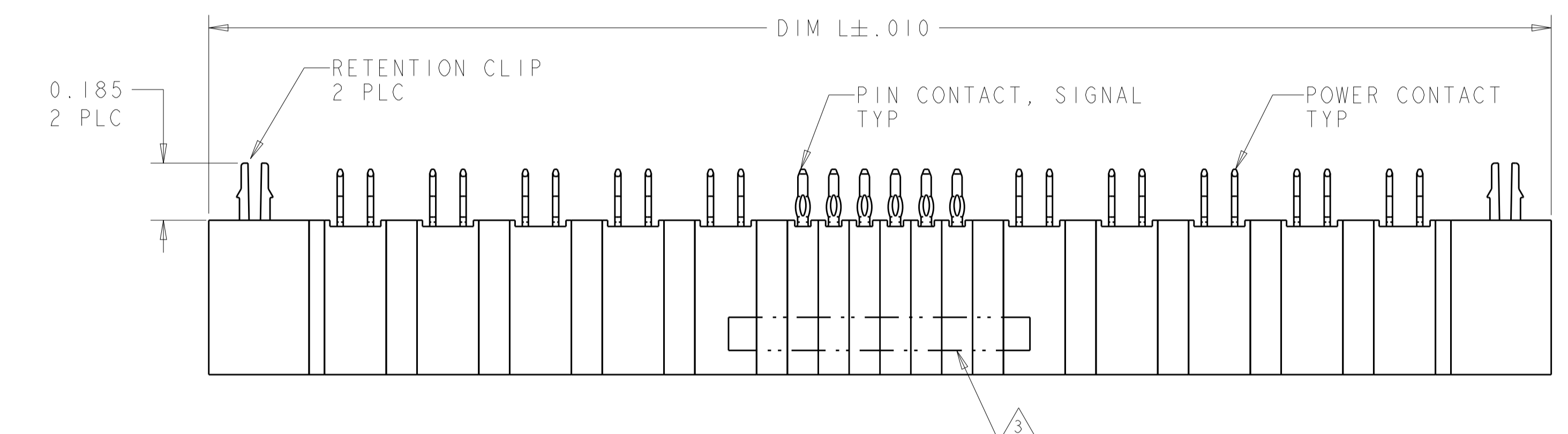

- 1. HEADER HOUSING: THERMO PLASTIC, BLACK, UL94 V-0; CONTACTS AND RETENTION CLIPS: COPPER ALLOY.
- 2. CONTACT PLATING: NOBLE METAL PLATING ON CONTACT FUNCTIONAL AREA OF POWER AND SIGNAL CONTACTS
- 3. "AMP", PART NUMBER AND DATE CODE MARKED IN THIS AREA. PARTS UNDER 2.50 LONG MAY BE MARKED ON BOTH SIDES.
- 4. DATUM AND BASIC DIMENSIONS ESTABLISHED BY CUSTOMER.
- 5. PCB - ALL HOLE DIAMETERS ARE FINISHED HOLE SIZES.
- 6. APPLIES TO POWER MODULES ON LEFT SIDE OF SIGNAL CAVITIES OF HOUSING.
- 7. APPLIES TO POWER MODULES ON RIGHT SIDE OF SIGNAL CAVITIES OF HOUSING.
- 8. A SEATING TOOL IS REQUIRED TO SEAT THE HEADER ON THE P.C. BOARD. PLEASE REFER TO THE 114-13038 APPLICATION SPEC.
- 9. MECHANICAL CONNECTOR KEEP OUT ZONE.
- 10. VARIABLE DIMENSION SHOWN VIEW. (SEE SHEET 6)

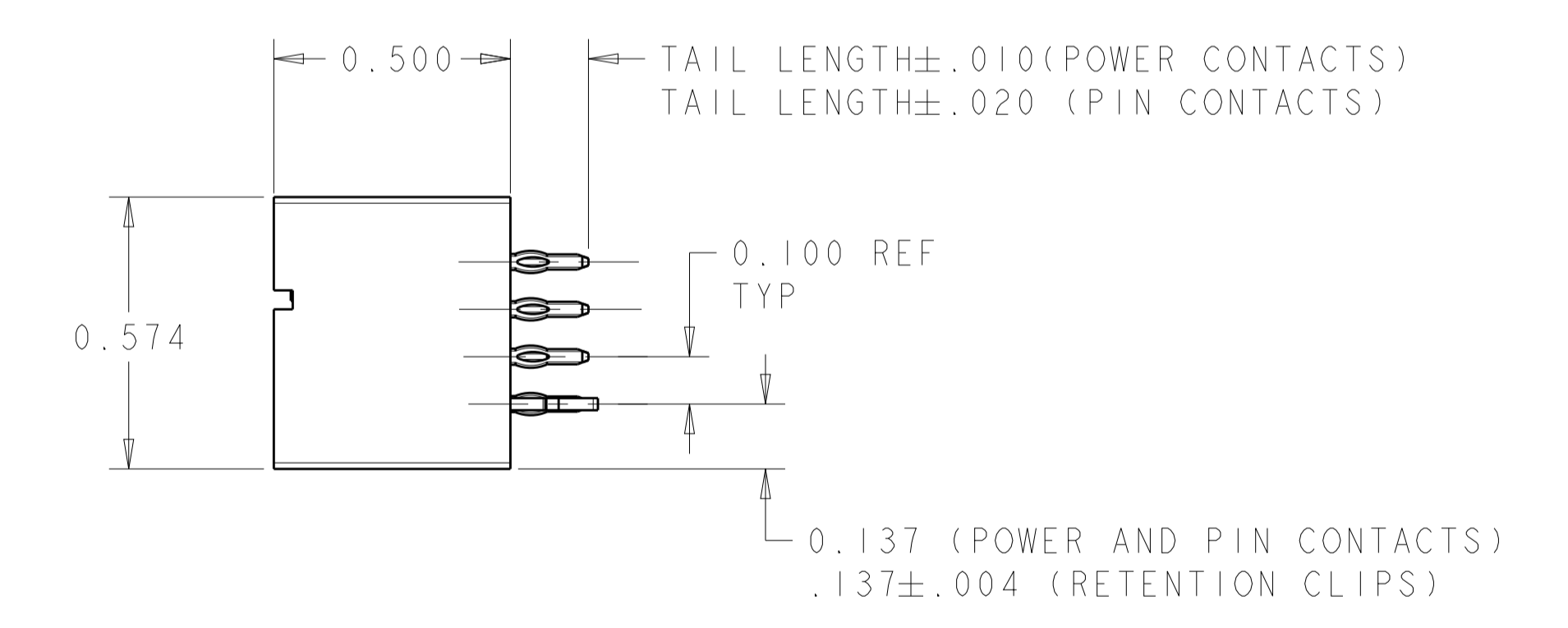

THIS DRAWING IS A CONTROLLED DOCUMENT.		DMN J. McCLINTON 23MAR2005	TE Connectivity VERTICAL HEADER ASSEMBLY, W/GUIDES, PRESS FIT, TYPE PSP MULTI-BEAM XL	
DIMENSIONS: INCH		CHK D. TROUT 23MAR2005		
TOLERANCES UNLESS OTHERWISE SPECIFIED:		APVD R. MLYNE 23MAR2005	PRODUCT SPEC 108-1973	RESTRICTED TO
0 PLC ±. 1 PLC ±.01 2 PLC ±.01 3 PLC ±.005 4 PLC ±.0020 ANGLES ±.7°		APPLICATION SPEC 114-13038	SIZE A1	Customer Drawing
MATERIAL FINISH		WEIGHT	SCALE 3:1	SHEET 1 OF 22
			REV P7	

LOC	DIST	REVISIONS					
ES	00	P	LTN	DESCRIPTION	DATE	OWN	APVD
		-		SEE SHEET 1			

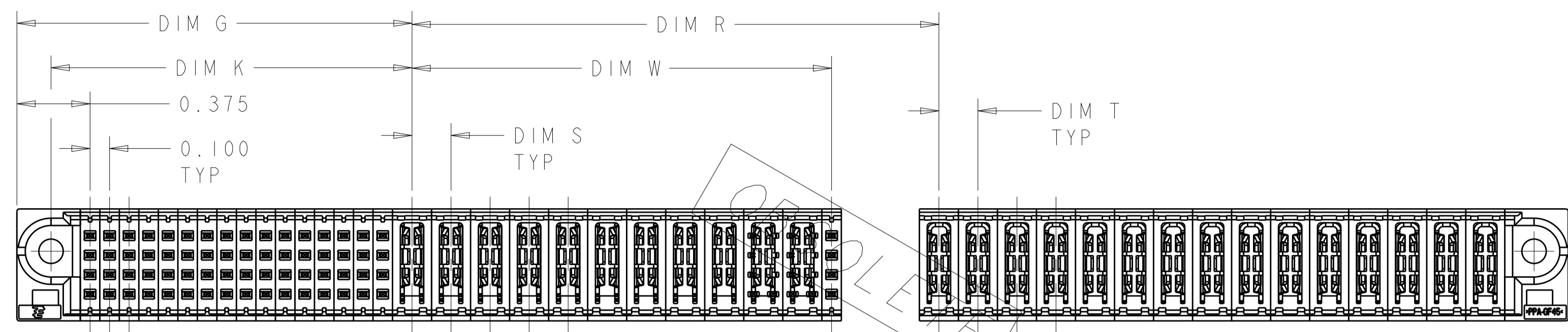

PART NUMBER 2-6600333-3
 UNSPECIFIED REFER TO TEH SHEET 1

	DIM "TT"	DIM "W"	DIM "U"	DIM "T"	DIM "S"	DIM "R"	DIM "L"	DIM "K"	DIM "G"	DIM "D"	RETENTION CLIP	DESCRIPTION	PART NO
P6	.300	.425	2.500	.250	.250	1.700	2.850	.275	.450	2.550	NO	2P + 48S + 2P	5-6600333-2
	.300	1.425	4.250	.250	.250	2.700	4.600	.275	.450	4.300	NO	6P + 48S + 5P	5-6600333-1
P1	.300	.425	2.400	.250	.250	1.100	2.750	.275	.450	2.450	NO	2P + 24S + 4P	5-6600333-0
	.300	.175	1.100	-	-	.550	1.450	.275	.450	1.150	YES	1P + 12S + 1P	4-6600333-9
N7	.300	1.225	4.000	.250	.250	2.200	4.350	.275	.450	4.057	NO	5P + 24S + 6P	4-6600333-8
N3	.300	.925	2.600	.250	.250	1.300	2.950	.275	.450	2.650	YES	4P + 12S + 4P	4-6600333-6
N5	.325	.550	2.200	.300	.300	1.300	2.550	.300	.475	2.250	YES	2ACP + 24S + 2ACP	4-6600333-5
	.300	.425	1.900	.250	.250	1.100	2.250	.275	.450	1.950	YES	2P + 24S + 2P	4-6600333-4
N4	.325	.550	2.200	.300	.300	1.300	2.550	.300	.475	2.250	YES	2ACP + 24S + 2ACP	4-6600333-3
	.300	1.925	4.700	.250	.250	2.400	5.050	.275	.450	4.750	YES	8P + 16S + 8P	4-6600333-2
	.300	.425	1.600	.250	.250	.800	1.950	.275	.450	1.650	YES	2P + 12S + 2P	4-6600333-1
	.325	.850	2.800	.300	.300	1.600	3.150	.300	.475	2.850	YES	3ACP + 24S + 3ACP	3-6600333-9
	.300	1.425	3.500	.250	.250	1.700	3.850	.275	.450	3.550	YES	6P + 8S + 6P	3-6600333-8
	.300	.475	2.000	.250	.250	1.200	2.350	.275	.450	2.050	YES	2P + 24S + 2P	3-6600333-7
	.300	.925	3.700	.250	.250	2.400	4.050	.275	.450	3.750	NO	4P + 56S + 4P	3-6600333-6
	.300	.675	2.400	.250	.250	1.350	2.750	.275	.450	2.450	YES	3P + 24S + 3P	3-6600333-5
	.300	.925	2.500	.250	.250	1.200	2.850	.275	.450	2.550	YES	4P + 8S + 4P	3-6600333-4
	.300	.925	2.700	.250	.250	1.400	3.050	.275	.450	2.750	NO	4P + 16S + 4P	3-6600333-3
	.300	.925	2.900	.250	.250	1.600	3.250	.275	.450	2.950	NO	4P + 24S + 4P	3-6600333-2
	.325	1.750	4.800	.250	.300	2.475	5.150	.300	.475	4.850	YES	6ACP + 24S + 8P	3-6600333-1
	.300	.225	1.300	-	-	.750	1.650	.275	.450	1.350	YES	1P + 16S + 1P	3-6600333-0
	.300	.425	2.100	-	.250	1.300	2.450	.275	.450	2.150	YES	2P + 32S + 2P	2-6600333-9
	.300	.925	2.450	.250	.250	1.400	2.800	.275	.450	2.500	YES	4P + 16S + 3P	2-6600333-8
	.300	.975	3.250	.250	.250	1.700	3.600	.275	.450	3.300	YES	4P + 24S + 5P	2-6600333-7
	.300	.675	2.400	.250	.250	1.350	2.750	.275	.450	2.450	YES	3P + 24S + 3P	2-6600333-6
	.300	.925	2.450	.250	.250	1.400	2.800	.275	.450	2.500	YES	4P + 16S + 3P	2-6600333-5
	.275	2.000	5.450	△	△	2.650	5.800	.250	.425	5.500	YES	10P + 24S + 12P	2-6600333-4
	1.875	2.150	7.600	.200	.200	2.700	7.950	1.850	2.025	7.650	YES	64S+11P+20S+15P	2-6600333-3
	.275	2.000	5.450	△	△	2.650	5.800	.250	.425	5.500	YES	10P + 24S + 12P	2-6600333-2
	.325	1.750	4.800	.250	.300	2.475	5.150	.300	.475	4.850	YES	6ACP + 24S + 8P	2-6600333-1
	.300	.475	2.000	.250	.250	1.200	2.350	.275	.450	2.050	YES	2P + 24S + 2P	1-6600333-6
	.300	1.425	3.900	.250	.250	2.100	4.250	.275	.450	3.950	YES	6P + 24S + 6P	1-6600333-5
	.300	.975	3.200	.250	.250	1.900	3.550	.275	.450	3.250	YES	4P + 32S + 4P	1-6600333-4
	.300	1.425	3.900	.250	.250	2.100	4.250	.275	.450	3.950	YES	6P + 24S + 6P	1-6600333-3
	.300	.425	1.900	.250	.250	1.100	2.250	.275	.450	1.950	YES	2P + 24S + 2P	1-6600333-2
	.325	.850	2.800	.300	.300	1.600	3.150	.300	.475	2.850	YES	3ACP + 24S + 3ACP	1-6600333-1
	.300	.475	1.800	.250	.250	1.000	2.150	.275	.450	1.850	YES	2P + 16S + 2P	1-6600333-0
	.300	.225	1.300	-	-	.750	1.650	.275	.450	1.350	YES	1P + 16S + 1P	6600333-9
	.300	.425	3.250	-	.250	2.700	3.600	.275	.450	3.300	YES	2P + 88S + 1P	6600333-8
	.300	.725	2.300	.250	.250	1.250	2.650	.275	.450	2.350	YES	3P + 16S + 3P	6600333-7
	.300	.975	3.000	.250	.250	1.700	3.350	.275	.450	3.050	YES	4P + 24S + 4P	6600333-6
	.300	.475	2.000	.250	.250	1.200	2.350	.275	.450	2.050	YES	2P + 24S + 2P	6600333-5
	.300	.425	1.700	.250	.250	.900	2.050	.275	.450	1.750	YES	2P + 16S + 2P	6600333-4
	.325	1.450	4.000	.300	.300	2.200	4.350	.300	.475	4.050	YES	5ACP + 24S + 5ACP	6600333-1
DIM "TT"	DIM "W"	DIM "U"	DIM "T"	DIM "S"	DIM "R"	DIM "L"	DIM "K"	DIM "G"	DIM "D"	RETENTION CLIP	DESCRIPTION	PART NO	

OBSOLETE

THIS DRAWING IS A CONTROLLED DOCUMENT.

DIMENSIONS: INCH	TOLERANCES UNLESS OTHERWISE SPECIFIED: 0 PLC ±. 1 PLC ±.01 2 PLC ±.01 3 PLC ±.005 4 PLC ±.002 ANGLES ±.002	OWN J. McCLINTON 23MAR2005 CHK D. TROUT 23MAR2005 APVD B. MLYNE 23MAR2005	NAME VERTICAL HEADER ASSEMBLY, W/GUIDES, PRESS FIT, TYPE PSP MULTI-BEAM XL
MATERIAL	FINISH	PRODUCT SPEC 108-1973 APPLICATION SPEC 114-13038	SIZE 100779 CAGE CODE C=6600333
Customer Drawing		WEIGHT	RESTRICTED TO

SCALE 3:1 SHEET 2 OF 22 REV P7

PART NUMBER	ROWS	POWER					SIGNAL						POWER				
		P1	P2	P3	P4	P5	1	2	3	4	5	6	P6	P7	P8	P9	P10
6600333-1	D	VM	VM	VM	VM	VM	EV	EV	EV	EV	EV	EV	VM	VM	VM	VM	VM
	C						EV	EV	EV	EV	EV	EV					
	B						EV	EV	EV	EV	EV	EV					
	A						ES	ES	ES	ES	ES	ES					
5ACP+24S+5ACP		HD															

PART NUMBER	ROWS	POWER		SIGNAL						POWER		
		P1	P2	1	2	3	4	5	6	P3	P4	
6600333-5	D	VM	VM	EV	EV	EV	EV	EV	EV	EV	VM	VM
	C			EV	EV	EV	EV	EV	EV			
	B			EV	EV	EV	EV	EV	EV			
	A			ES	ES	ES	ES	ES	ES			
2P+24S+2P		HD										

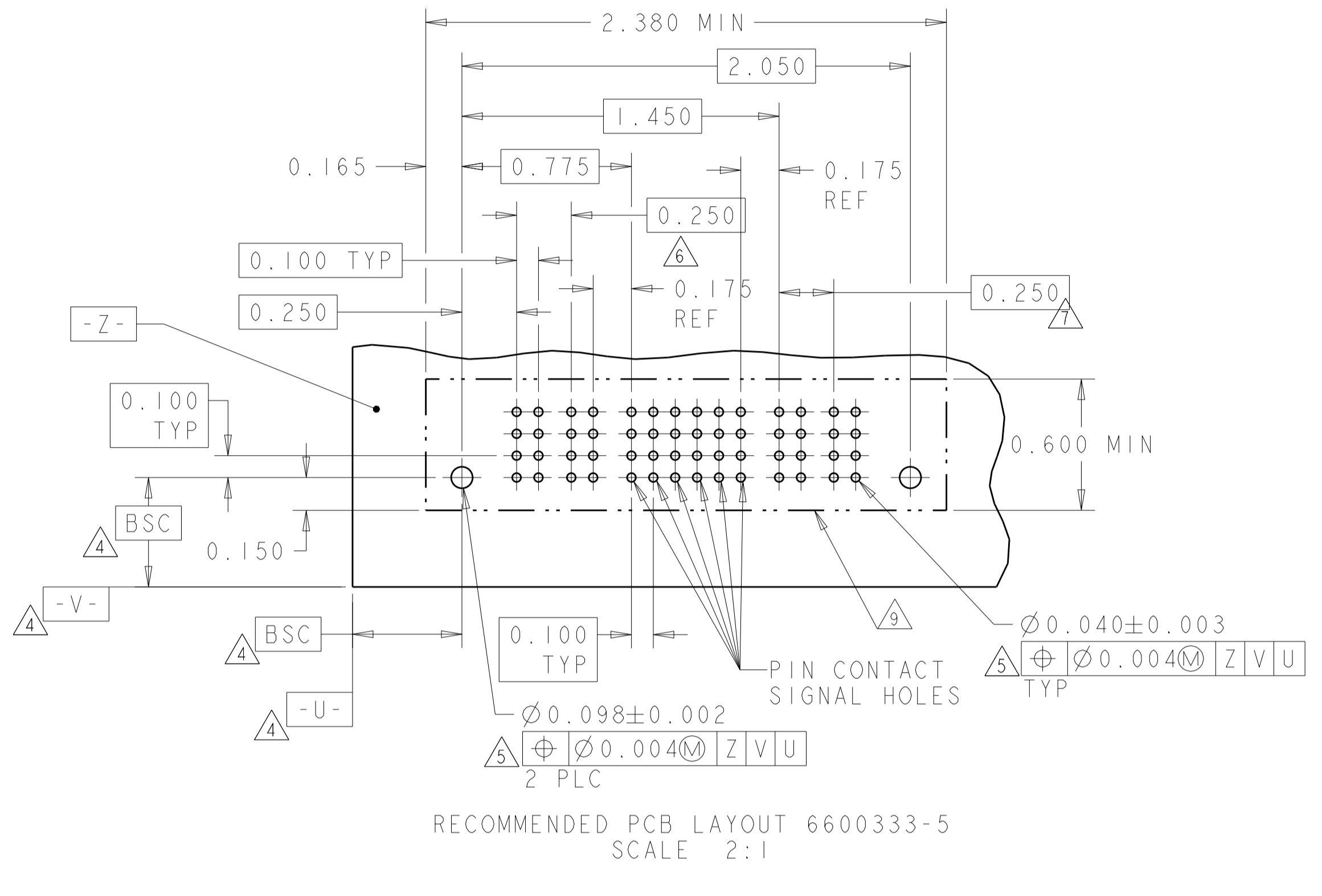
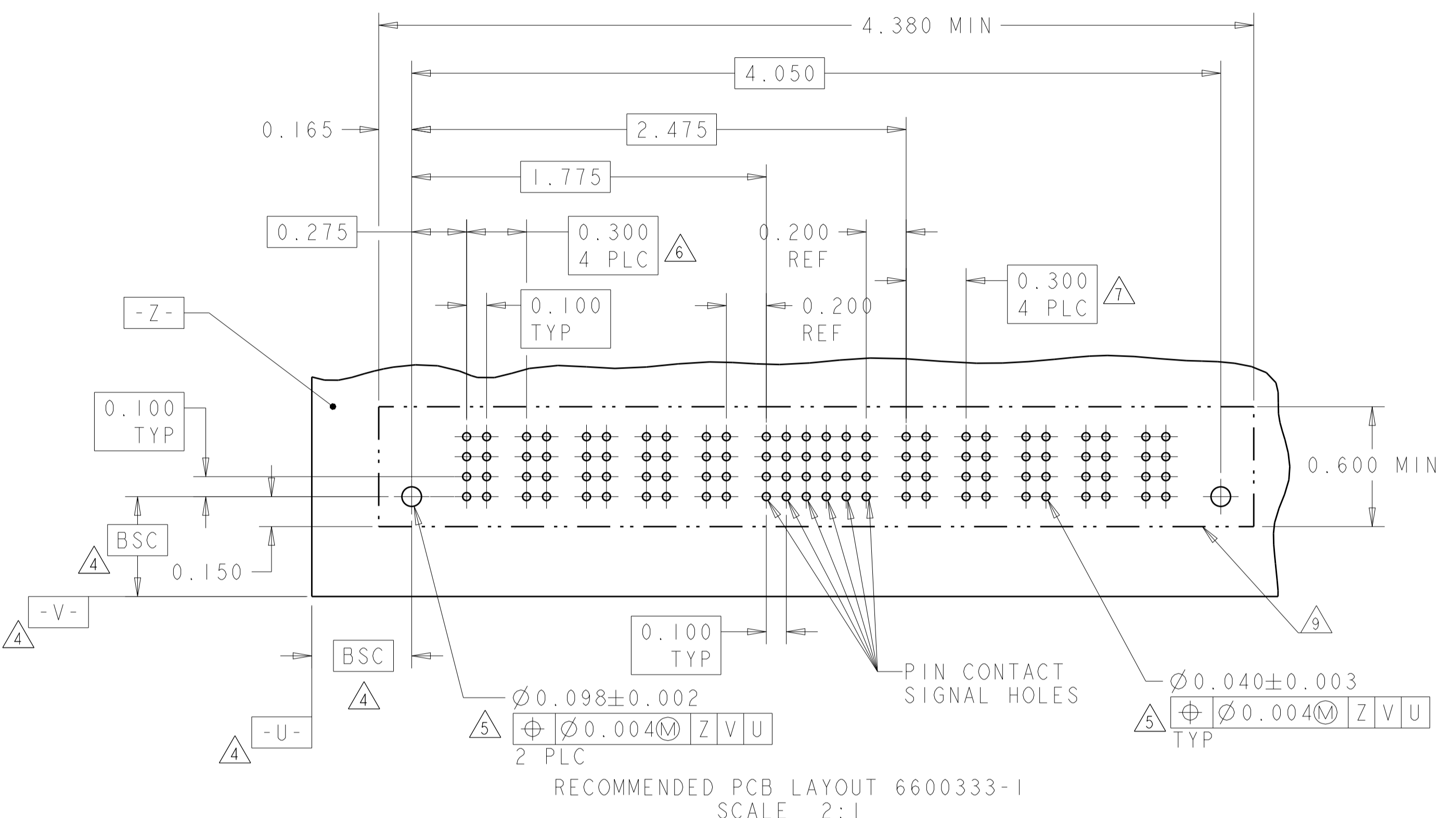

PART NUMBER	ROWS	POWER		SIGNAL				POWER	
		P1	P2	1	2	3	4	P3	P4
6600333-4	D	VM	VM	EV	EV	EV	EV	VM	VM
	C			EV	EV	EV	EV		
	B			EV	EV	EV	EV		
	A			EV	EV	EV	EV		
2P+16S+2P		HD							

PART NUMBER	ROWS	POWER				SIGNAL						POWER			
		P1	P2	P3	P4	1	2	3	4	5	6	P5	P6	P7	P8
6600333-6	D	VM	VM	VM	VM	ES	ES	ES	ES	EV	ES	VM	VM	VM	VM
	C					ES	ES	ES	EV	ES					
	B					ES	ES	ES	EV	ES					
	A					ES	ES	EV	ES	ES					
4P+24S+4P		HD													

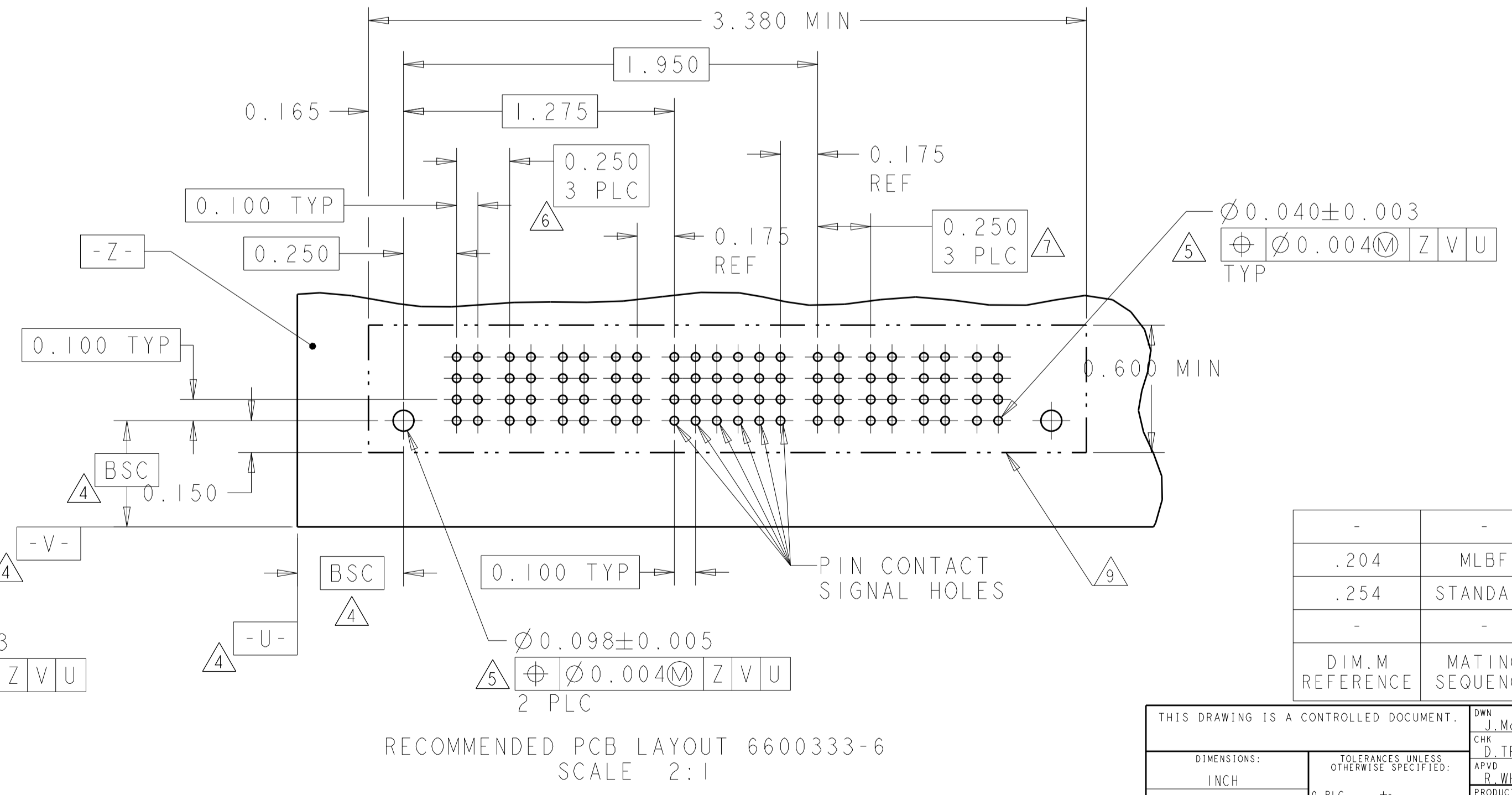
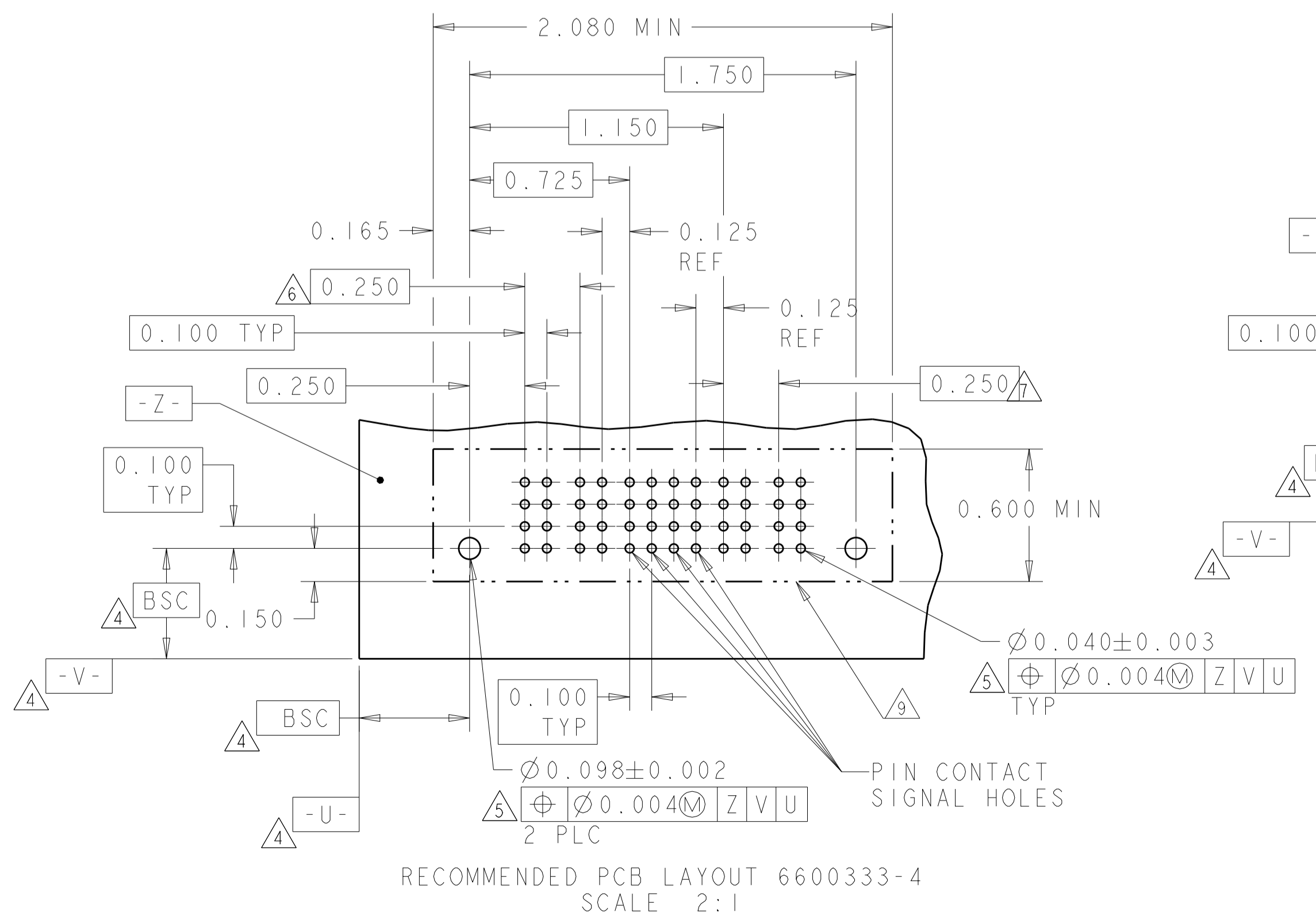

DIM. M REFERENCE	MATING SEQUENCE	DESCRIPTION	IDENTIFIER
-	-	RETENTION CLIP	HD
.204	MLBF	SIGNAL CONTACT .165 TAIL LENGTH	ES
.254	STANDARD	SIGNAL CONTACT .165 TAIL LENGTH	EV
-	-	POWER CONTACT .165 TAIL LENGTH	VM

THIS DRAWING IS A CONTROLLED DOCUMENT.

DIMENSIONS: INCH	TOLERANCES UNLESS OTHERWISE SPECIFIED:	OWN: J. McCLINTON 23MAR2005	CHEK: D. TROUT 23MAR2005	APVD: B. WILBYNE 23MAR2005
0 PLC ±.01	1 PLC ±.01	PRODUCT SPEC		
2 PLC ±.01	3 PLC ±.005	108-1973		
4 PLC ±.002	ANGLES ±.002	APPLICATION SPEC		
FINISH	FINISH	114-13038		
MATERIAL	FINISH	WEIGHT		

Customer Drawing

SCALE 3:1 SHEET 3 OF 22 REV P7

TE Connectivity

NAME: VERTICAL HEADER ASSEMBLY, W/GUIDES, PRESS FIT, TYPE PSP MULTI-BEAM XL

SIZE: A100779 C=6600333

PART NUMBER	ROWS	POWER			SIGNAL				POWER		
		P1	P2	P3	1	2	3	4	P4	P5	P6
6600333-7	D	VM	VM	VM	EV	EV	EV	EV	VM	VM	VM
	C				ES	ES	ES	ES			
	B				ES	ES	ES	ES			
	A				EV	EV	EV	EV			
3P+16S+3P		HD									HD

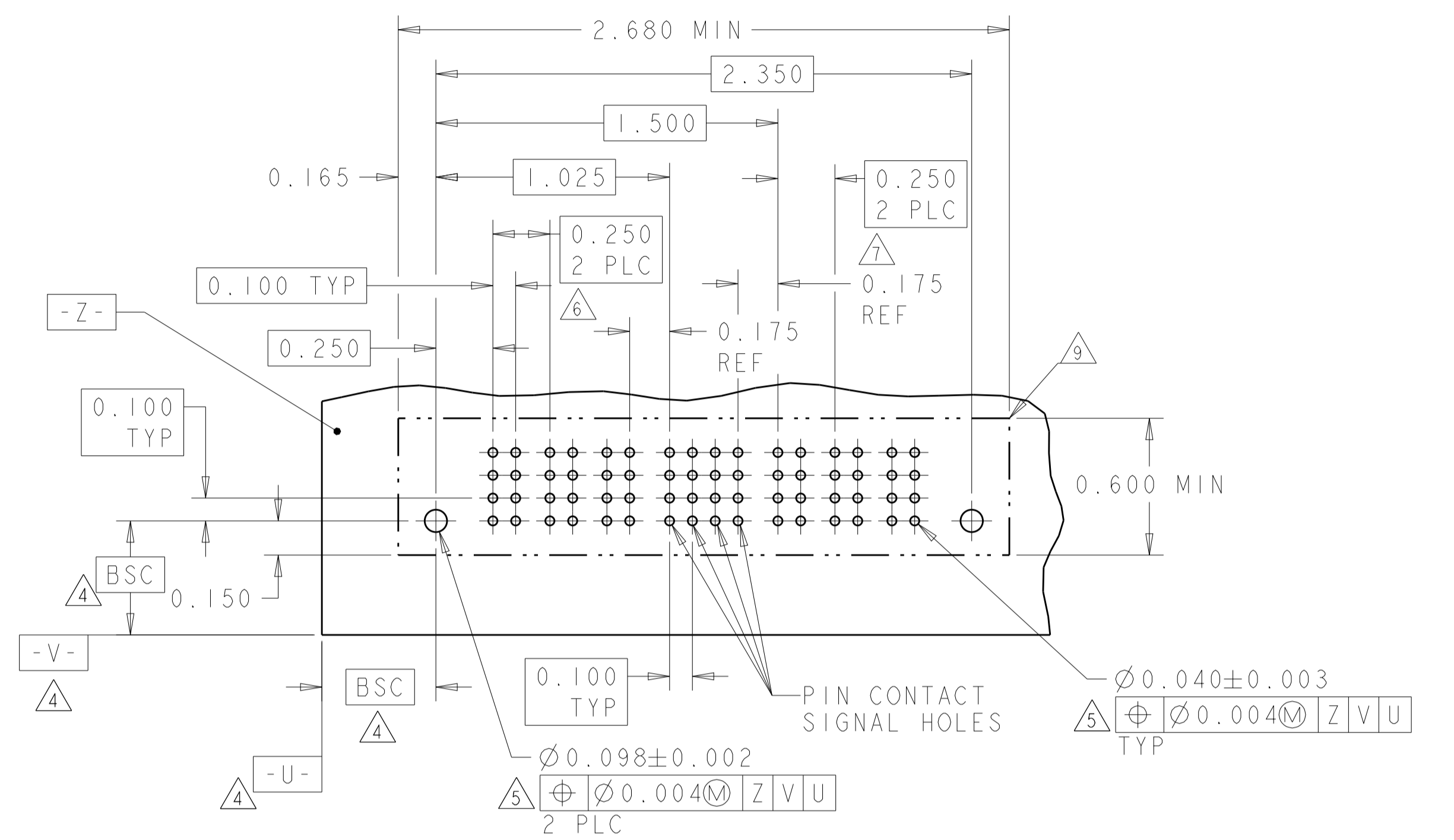

RECOMMENDED PCB LAYOUT 6600333-7
 SCALE 2:1

PART NUMBER	ROWS	POWER		SIGNAL																		POWER						
		P1	P2	1	2	3	4	5	6	7	8	9	10	11	12	13	14	15	16	17	18	19	20	21	22	P3		
6600333-8	D	VM	VM	EV	EV	EV	EV	EV	EV	EV	EV	EV	EV	EV	EV	EV	EV	EV	EV	EV	EV	EV	EV	EV	EV	EV	VM	
	C			EV	EV	EV	EV	EV	EV	EV	EV	EV	EV	EV	EV	EV	EV	EV	EV	EV	EV	EV	EV	EV	EV	EV		
	B			EV	EV	EV	EV	EV	EV	EV	EV	EV	EV	EV	EV	EV	EV	EV	EV	EV	EV	EV	EV	EV	EV	EV		EV
	A			EV	EV	EV	EV	EV	EV	EV	EV	EV	EV	EV	EV	EV	EV	EV	EV	EV	EV	EV	EV	EV	EV	EV		EV
2P+88S+1P		HD																									HD	

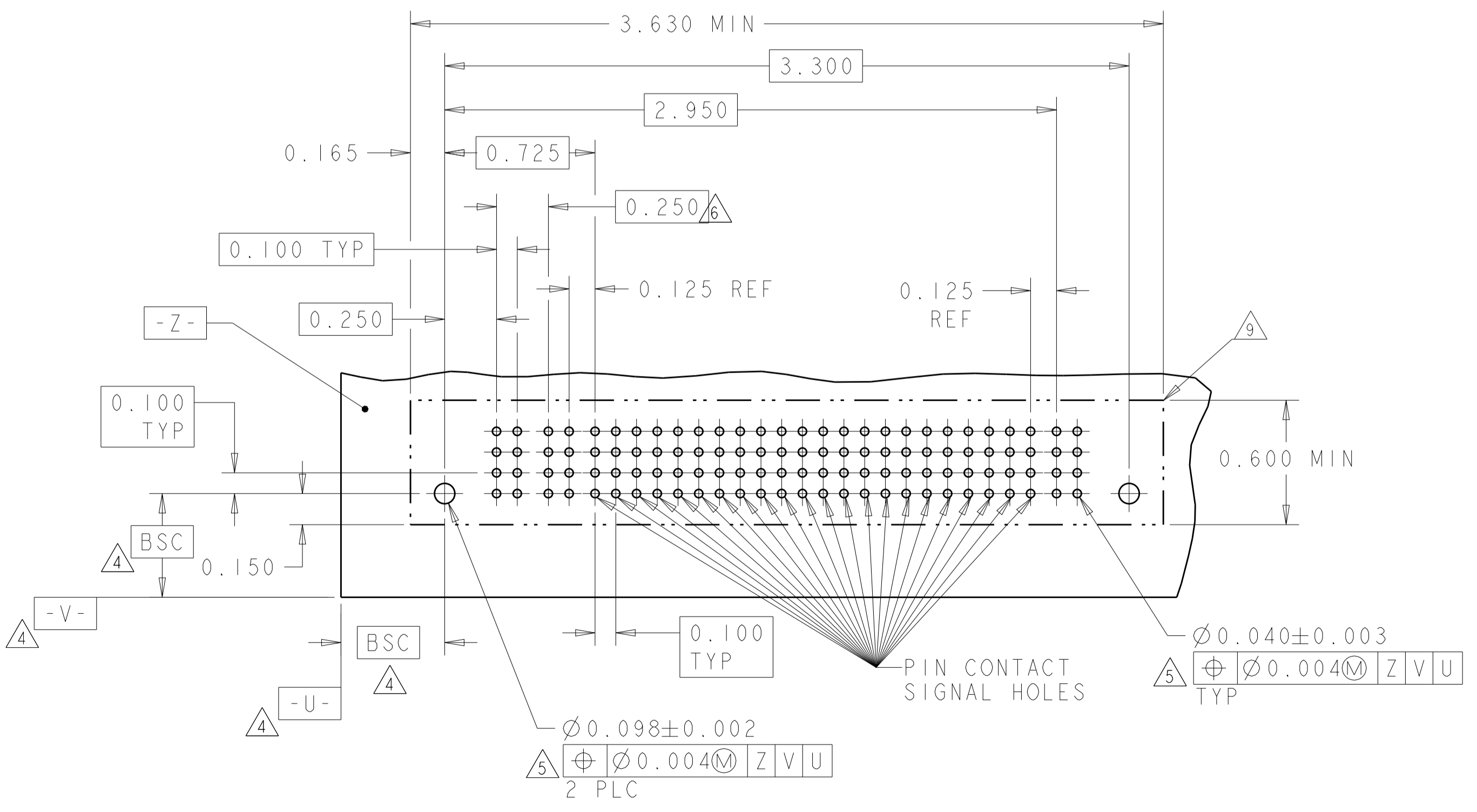

RECOMMENDED PCB LAYOUT 6600333-8
 SCALE 2:1

PART NUMBER	ROWS	POWER		SIGNAL				POWER
		P1	P2	1	2	3	4	P2
6600333-9	D	VM	VM	ES	EV	ES	EV	VM
	C			EV	EV	EV	EV	
	B			ES	EV	ES	EV	
	A			ES	EV	ES	EV	
1P+16S+1P		HD						HD

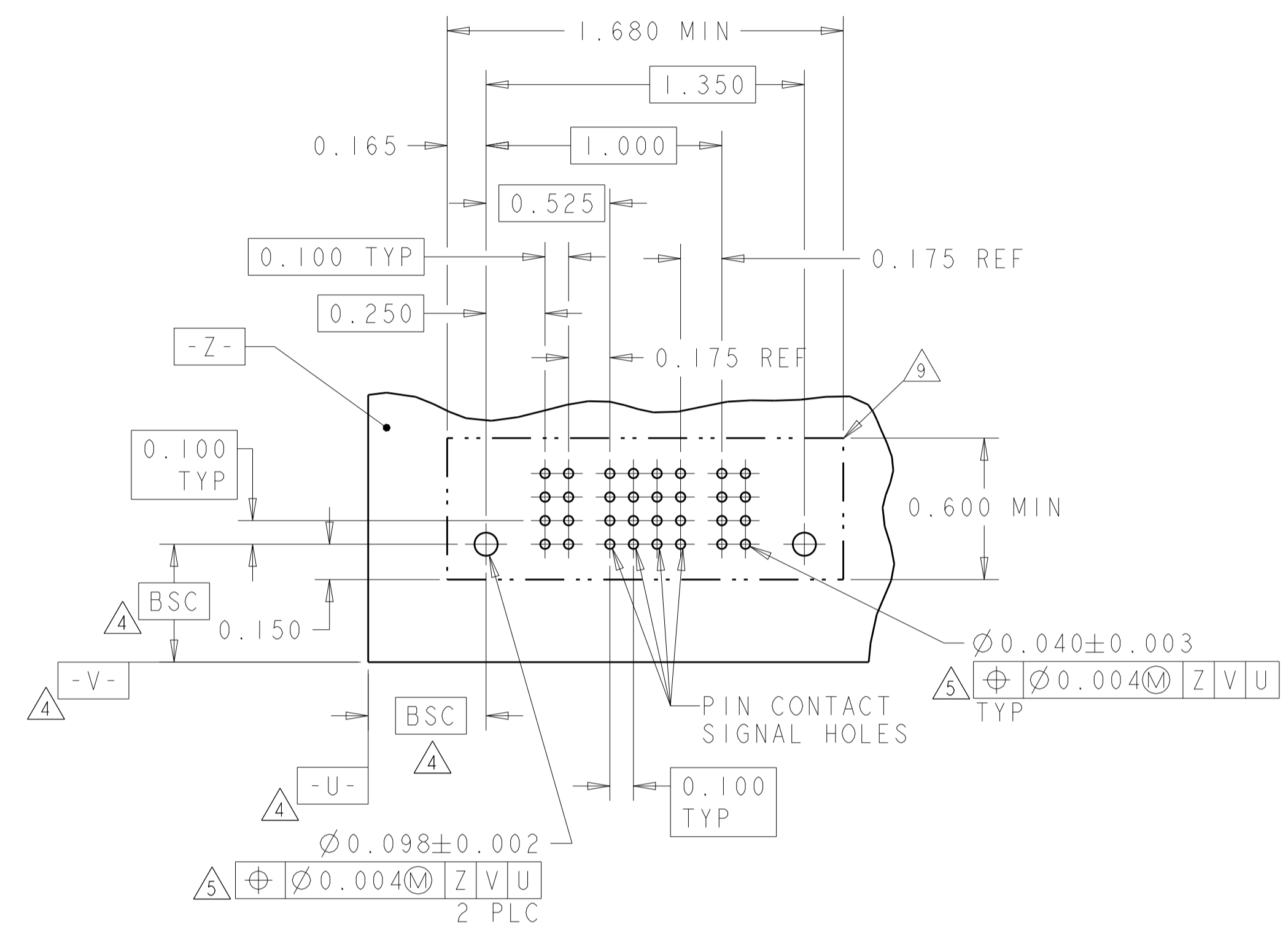

RECOMMENDED PCB LAYOUT 6600333-9
 SCALE 2:1

PART NUMBER	ROWS	POWER		SIGNAL				POWER
		P1	P2	1	2	3	4	P2
3-6600333-0	D	VM	VM	ES	EV	EV	ES	VM
	C			EV	EV	EV	EV	
	B			EV	EV	EV	EV	
	A			EV	EV	EV	EV	
1P+16S+1P		HD						HD

THE PCB LAYOUT OF 3-6600333-0 IS SAME AS 6600333-9

THIS DRAWING IS A CONTROLLED DOCUMENT.

DIMENSIONS:	TOLERANCES UNLESS OTHERWISE SPECIFIED:	DWN J. McCLINTON 23MAR2005	CHK D. TROUT 23MAR2005	APVD B. MLYNE 23MAR2005
INCH	0 PLC ±.01 1 PLC ±.01 2 PLC ±.01 3 PLC ±.005 4 PLC ±.002	PRODUCT SPEC 108-1973	APPLICATION SPEC 114-13038	WEIGHT
MATERIAL	FINISH	SIZE A100779	CAGE CODE C=6600333	RESTRICTED TO
		Customer Drawing	SCALE 3:1	SHEET 4 OF 22

TE Connectivity
 VERTICAL HEADER ASSEMBLY, W/GUIDES, PRESS FIT, TYPE PSP MULTI-BEAM XL

PART NUMBER	ROWS	POWER		SIGNAL				POWER	
		P1	P2	1	2	3	4	P3	P4
I-6600333-0	D	VM	VM	EV	EV	EV	EV	VM	VM
	C			ES	ES	ES	ES		
	B			ES	ES	ES	ES		
	A			EV	EV	EV	EV		
2P+16S+2P		HD						HD	

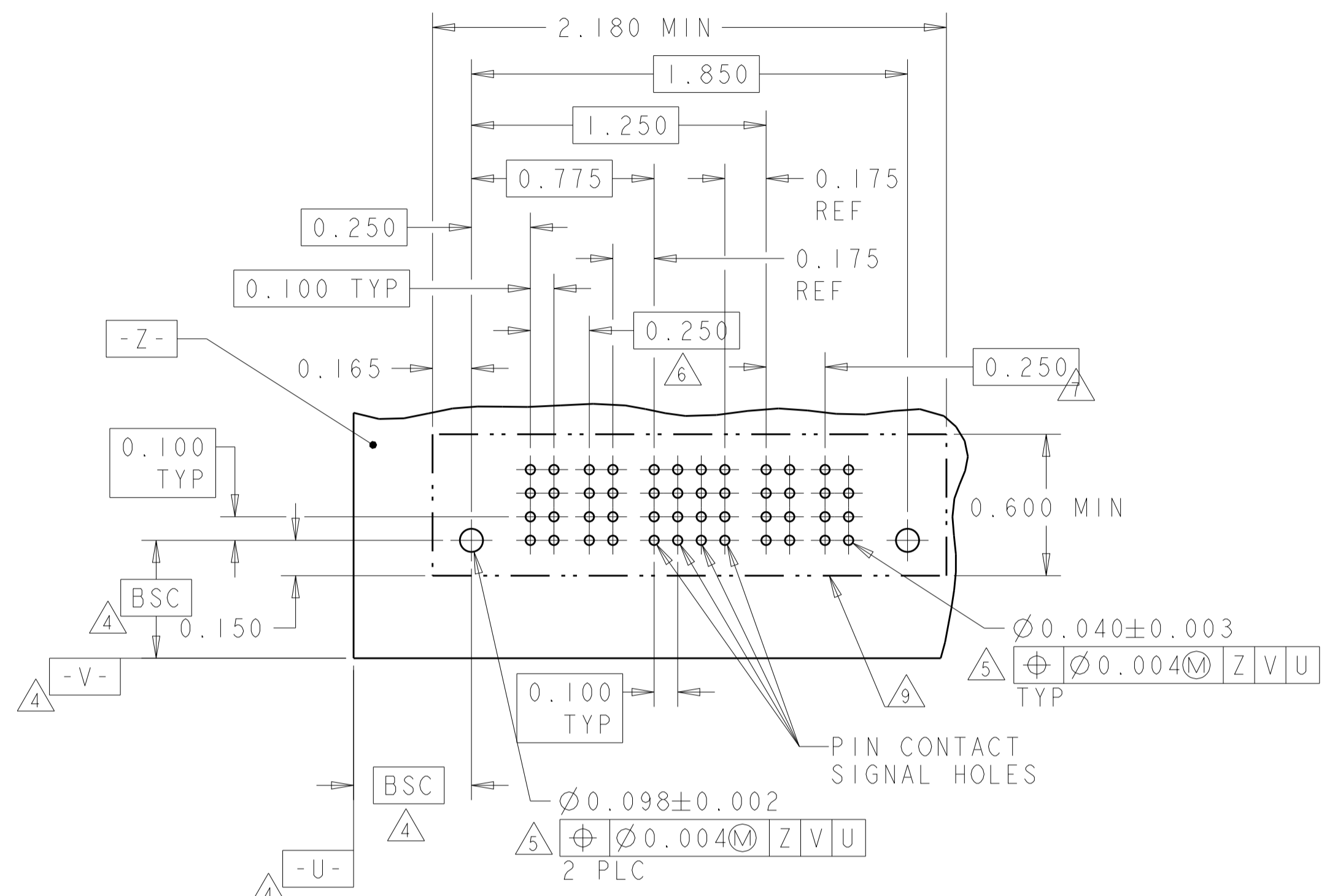

RECOMMENDED PCB LAYOUT I-6600333-0
 SCALE 2:1

PART NUMBER	ROWS	POWER			SIGNAL						POWER		
		P1	P2	P3	1	2	3	4	5	6	P4	P5	P6
I-6600333-1	D	VM	VM	VM	EV	EV	EV	EV	EV	EV	VM	VM	VM
	C				EV	EV	EV	EV	EV				
	B				EV	EV	EV	EV	EV				
	A				EV	EV	EV	EV	EV				
3ACP+24S+3ACP		HD								HD			

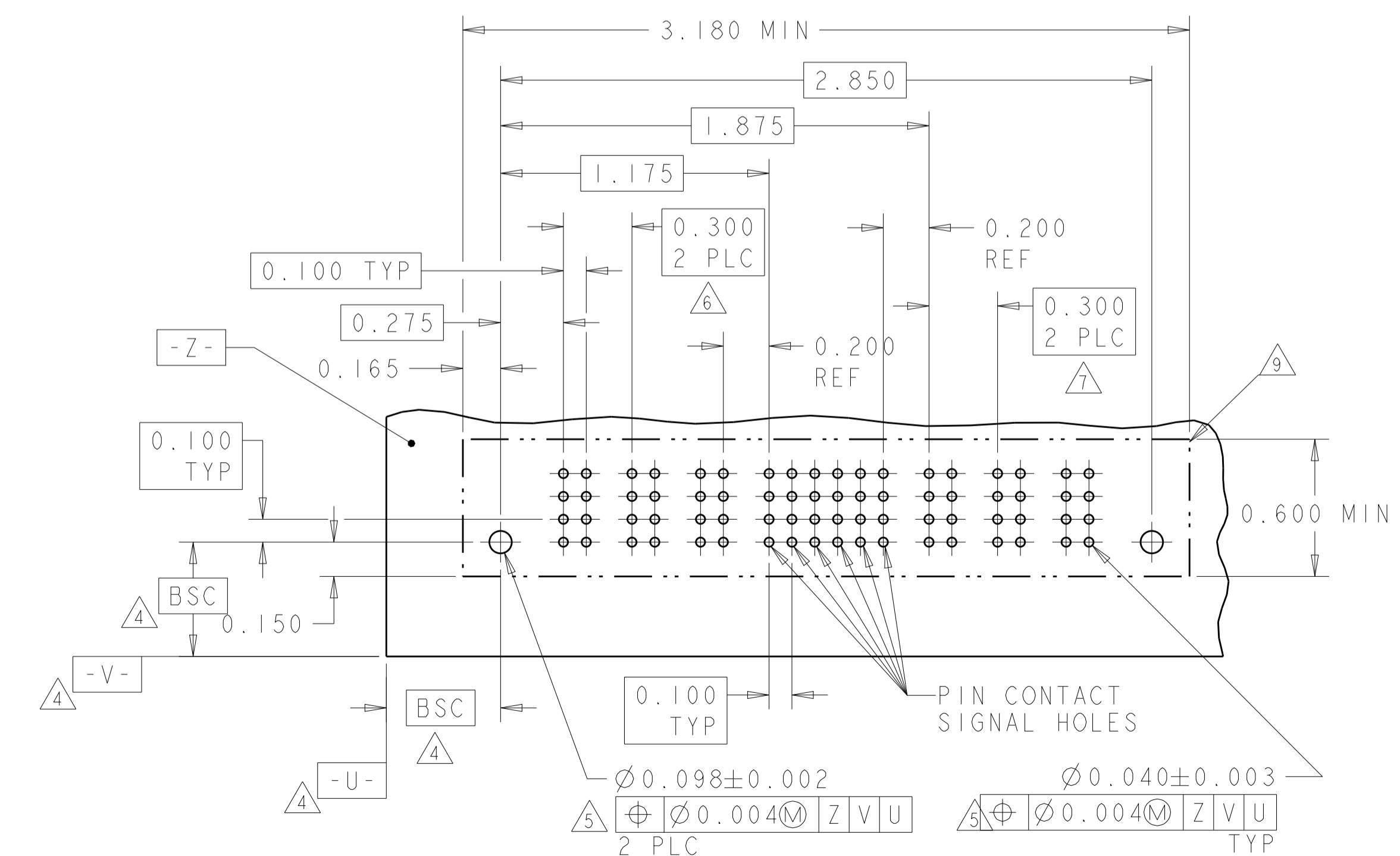

RECOMMENDED PCB LAYOUT I-6600333-1
 SCALE 2:1

PART NUMBER	ROWS	POWER		SIGNAL						POWER	
		P1	P2	1	2	3	4	5	6	P3	P4
I-6600333-2	D	VM	VM	EV	EV	EV	EV	EV	EV	VM	VM
	C			EV	EV	EV	EV	EV			
	B			EV	EV	EV	EV	EV			
	A			EV	EV	EV	EV	EV			
2P+24S+2P		HD								HD	

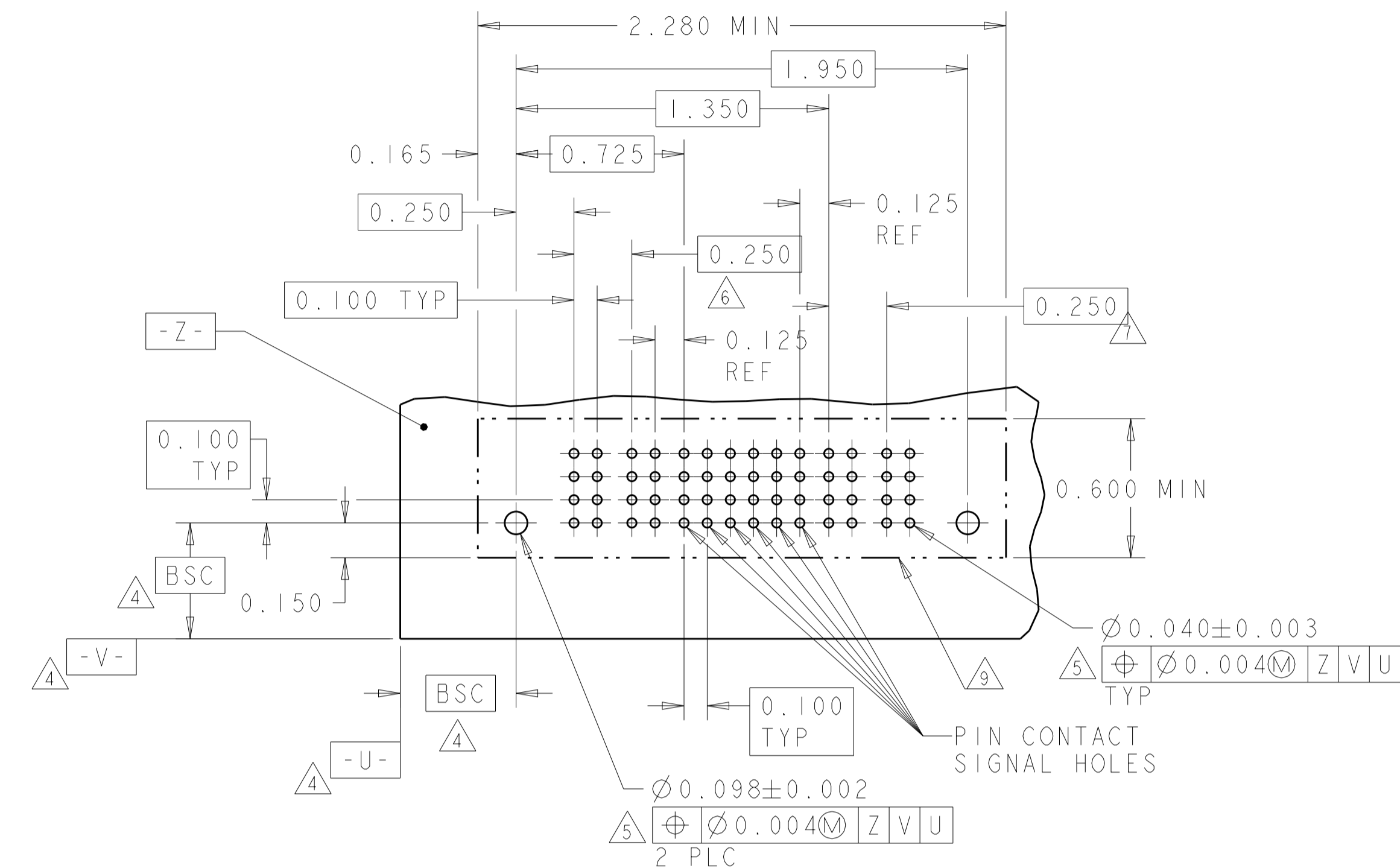

RECOMMENDED PCB LAYOUT I-6600333-2
 SCALE 2:1

PART NUMBER	ROWS	POWER						SIGNAL						POWER							
		P1	P2	P3	P4	P5	P6	1	2	3	4	5	6	P7	P8	P9	P10	P11	P12		
I-6600333-3	D	VM	VM	VM	VM	VM	VM	EV	EV	EV	EV	EV	EV	VM	VM	VM	VM	VM	VM		
	C							EV	EV	EV	EV	EV									
	B							EV	EV	EV	EV	EV									
	A							EV	EV	EV	EV	EV									
6P+24S+6P		HD														HD					

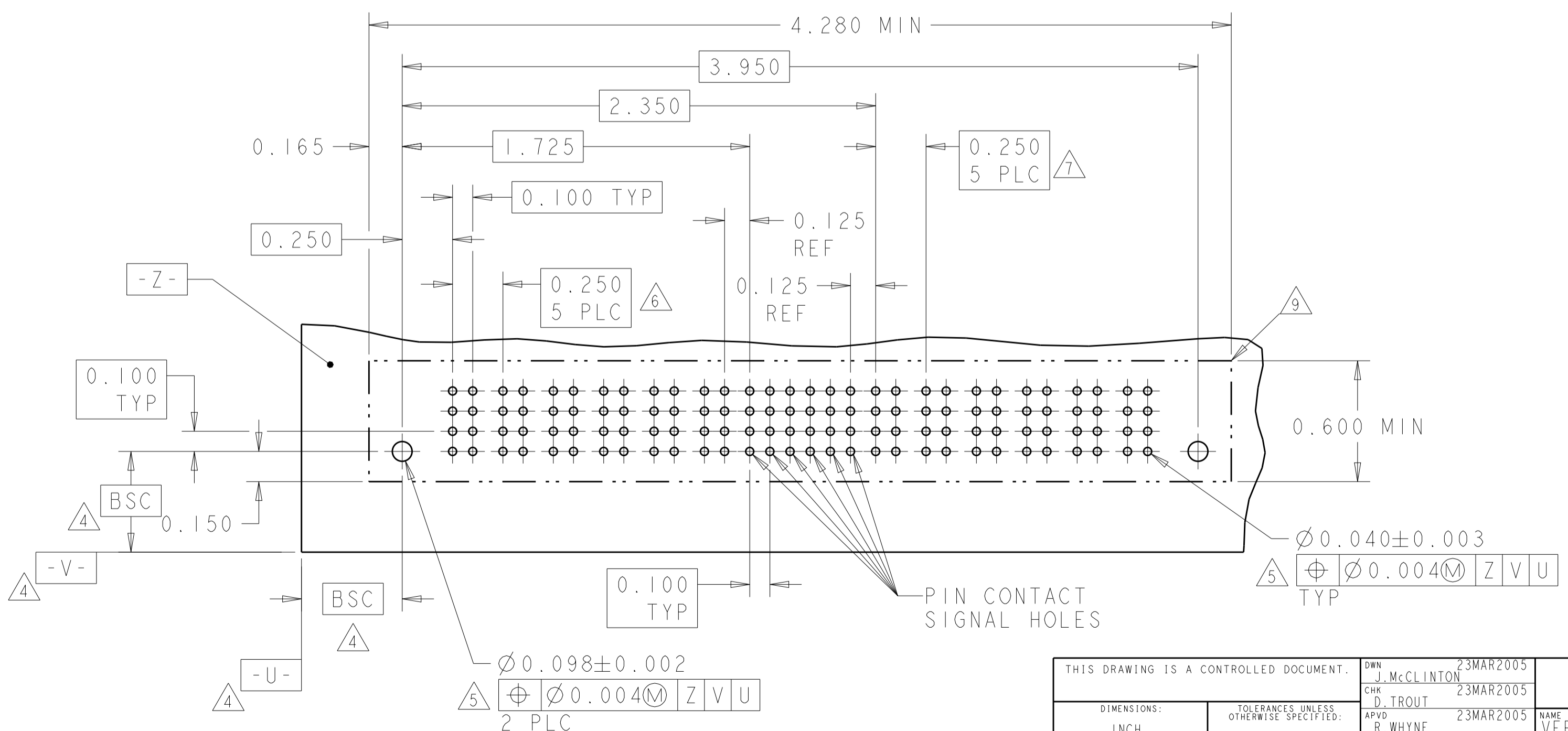

RECOMMENDED PCB LAYOUT I-6600333-3
 SCALE 2:1

LOC	DIST	REVISIONS			
ES	00	REV	DATE	BY	APPV
		1			
		2			

THIS DRAWING IS A CONTROLLED DOCUMENT.

DIMENSIONS: INCH	TOLERANCES UNLESS OTHERWISE SPECIFIED: 0 PLC ±. 1 PLC ±.01 2 PLC ±.005 3 PLC ±.002 4 PLC ±.002 ANGLES ±.002	OWN: J. McCLINTON 23MAR2005 CHK: D. TROUT 23MAR2005 APPV: P. MLYNE 23MAR2005	NAME: VERTICAL HEADER ASSEMBLY, W/GUIDES, PRESS FIT, TYPE PSP MULTI-BEAM XL SIZE: CAGE CODE DRAWING NO: 114-13038 RESTRICTED TO: A100779C=6600333
MATERIAL:	FINISH:	WEIGHT:	Customer Drawing

SCALE 3:1 SHEET 5 OF 22 REV P7

PART NUMBER	ROWS	POWER				SIGNAL								POWER			
		P1	P2	P3	P4	1	2	3	4	5	6	7	8	P5	P6	P7	P8
1-6600333-4	D	VM	VM	VM	VM	EV	EV	EV	EV	EV	EV	EV	EV	VM	VM	VM	VM
	C					EV	EV	EV	EV	EV	EV	EV					
	B					EV	EV	EV	EV	EV	EV	EV					
	A					EV	EV	EV	EV	EV	EV	EV					
4P+32S+4P		HD															

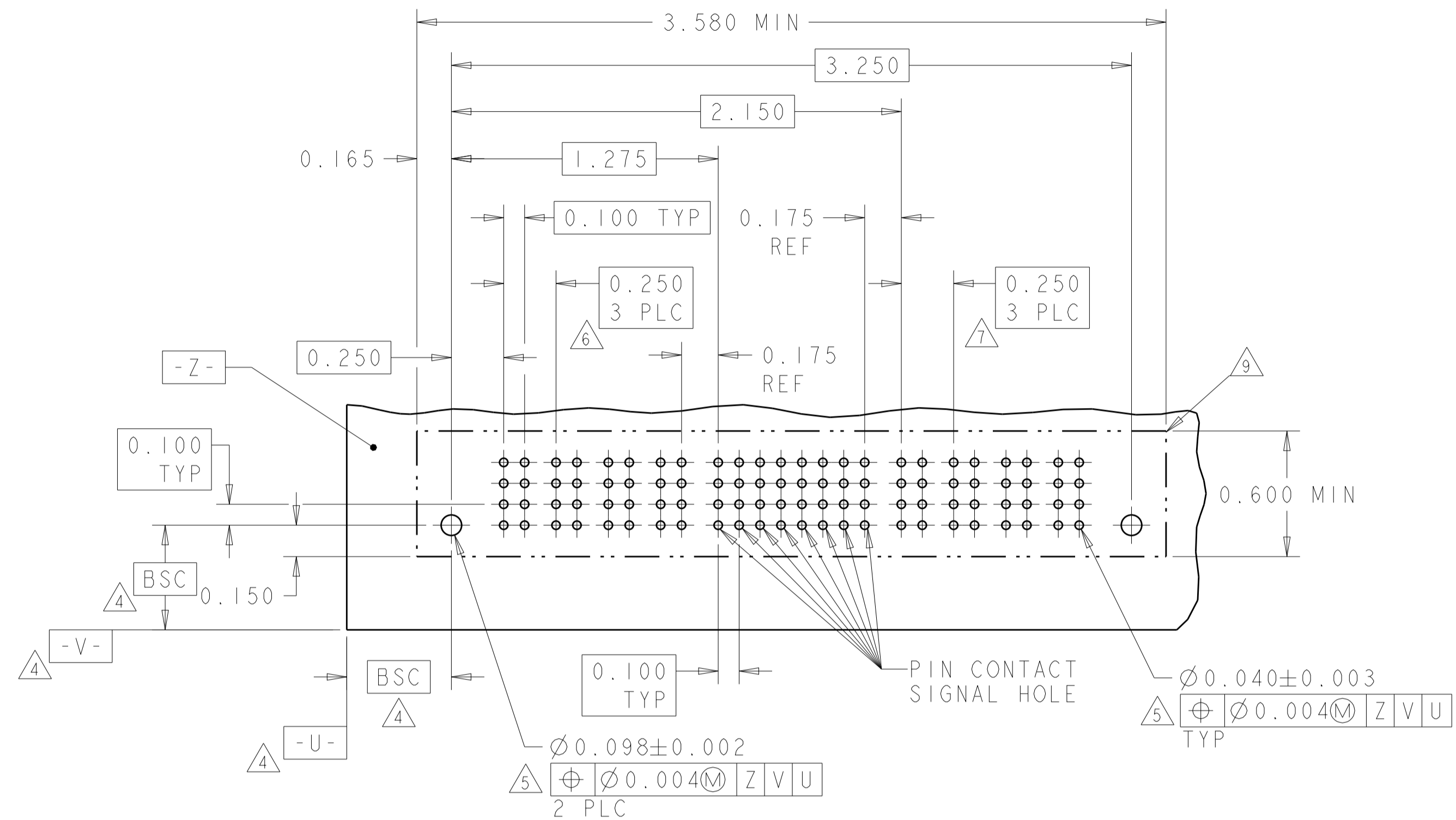

RECOMMENDED PCB LAYOUT 1-6600333-4
 SCALE 2:1

PART NUMBER	ROWS	POWER					SIGNAL						POWER							
		P1	P2	P3	P4	P5	P6	1	2	3	4	5	6	P7	P8	P9	P10	P11	P12	
1-6600333-5	D	VM	VM	VM	VM	VM	EV		EV	EV	EV	EV	VM	VM	VM	VM	VM	VM	VM	
	C						EV		EV	EV	EV	EV								
	B						EV		EV	EV	EV	EV								EV
	A						EV		EV	EV	EV	EV								ES
6P+24S+6P		HD																		

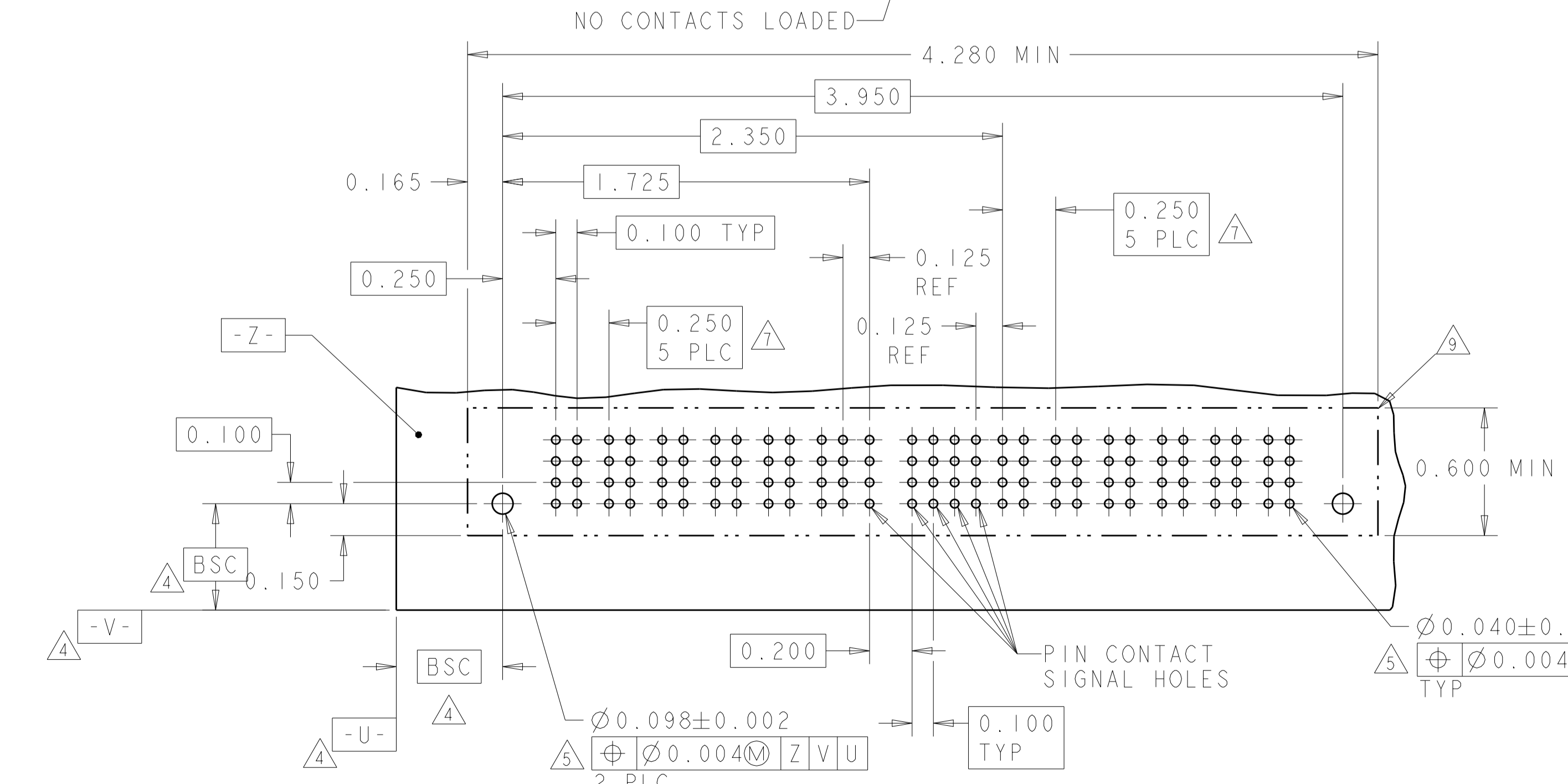

RECOMMENDED PCB LAYOUT 1-6600333-5
 SCALE 2:1

PART NUMBER	ROWS	POWER		SIGNAL						POWER		
		P1	P2	1	2	3	4	5	6	P3	P4	
1-6600333-6	D	VM	VM	ES	ES	ES	ES	ES	ES	EV	VM	VM
	C			ES	EV	EV	EV	EV	ES			
	B			ES	ES	ES	ES	ES	ES			
	A			ES	ES	ES	ES	ES	EV			
2P+24S+2P		HD										

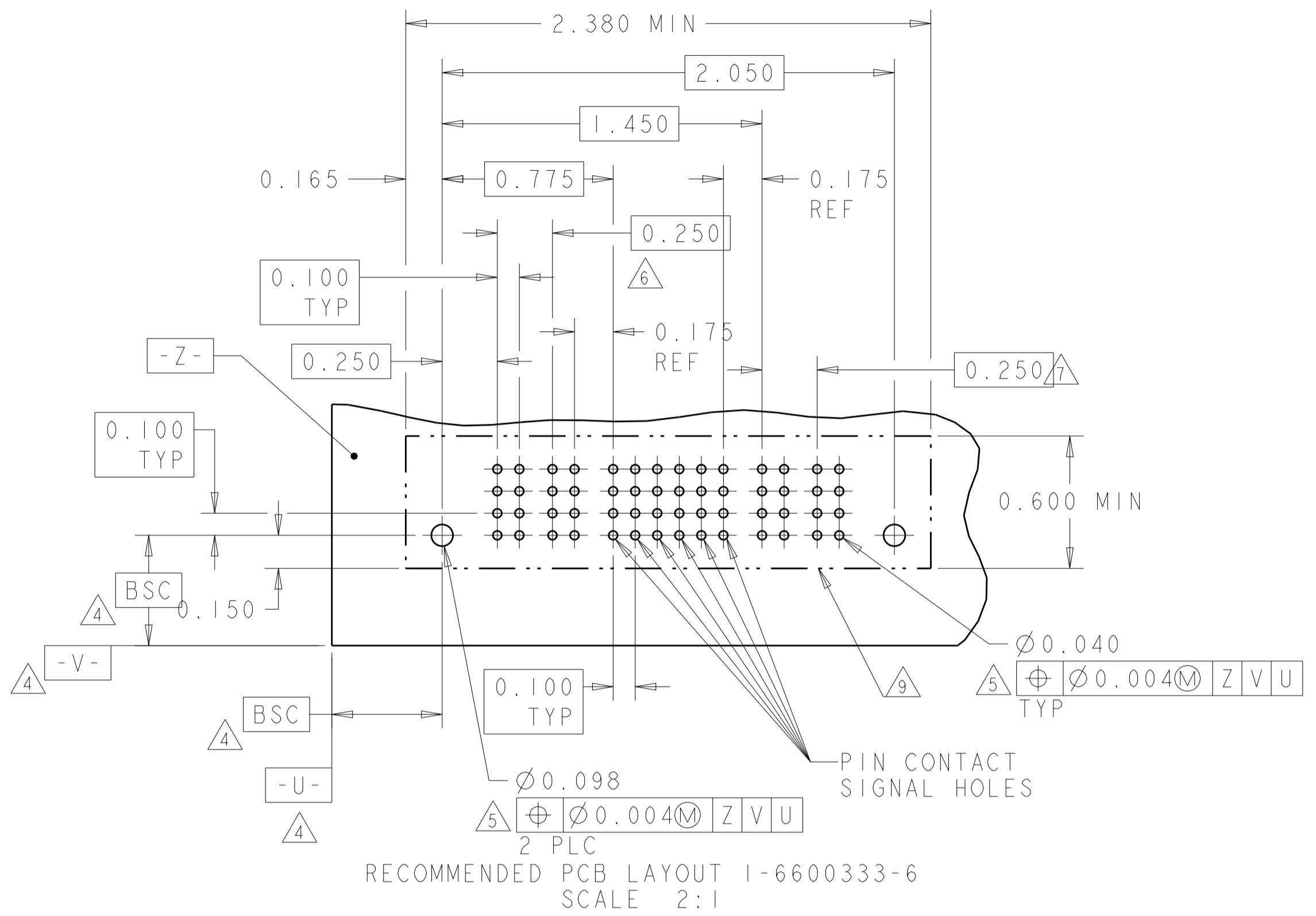

RECOMMENDED PCB LAYOUT 1-6600333-6
 SCALE 2:1

PART NUMBER	ROWS	POWER						SIGNAL						POWER							
		P1	P2	P3	P4	P5	P6	1	2	3	4	5	6	P7	P8	P9	P10	P11	P12	P13	P14
2-6600333-1	D	VM	VM	VM	VM	VM	EV	EV	EV	EV	EV	EV	VM	VM	VM	VM	VM	VM	VM	VM	
	C						EV	EV	EV	EV	EV	EV									
	B						EV	EV	EV	EV	EV	EV									
	A						EV	EV	EV	EV	EV	EV									
6ACP + 24S + 8P		HD																			

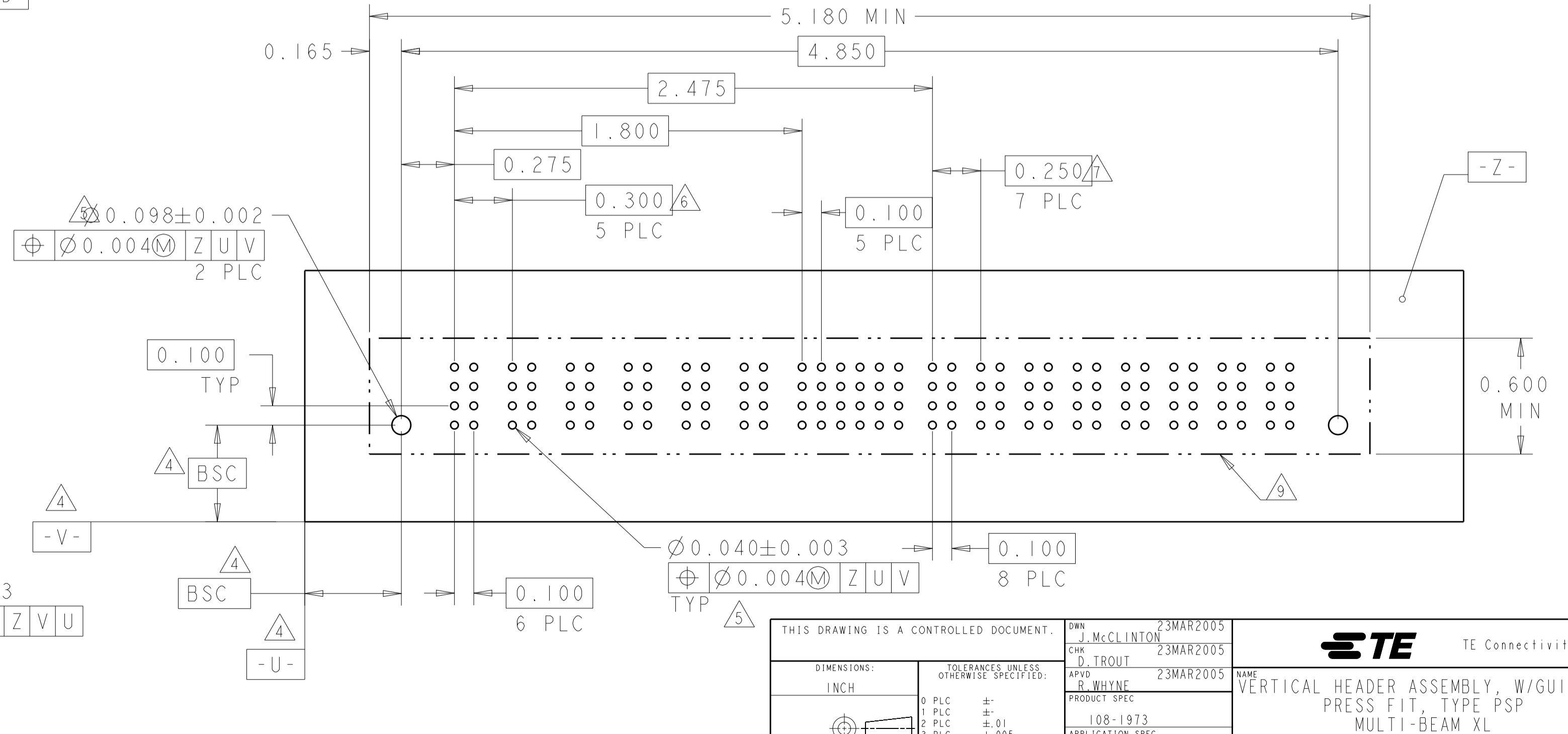

THIS DRAWING IS A CONTROLLED DOCUMENT.

DIMENSIONS:	TOLERANCES UNLESS OTHERWISE SPECIFIED:	OWN: J. McCLINTON 23MAR2005	CHK: D. TROUT 23MAR2005	APVD: B. MLYNE 23MAR2005
INCH	0 PLC ±.01 1 PLC ±.01 2 PLC ±.01 3 PLC ±.005 4 PLC ±.002	PRODUCT SPEC	108-1973	APPLICATION SPEC
MATERIAL:	FINISH:	WEIGHT:	114-13038	Customer Drawing

NAME: VERTICAL HEADER ASSEMBLY, W/GUIDES, PRESS FIT, TYPE PSP MULTI-BEAM XL

SIZE: A1 00779 C=6600333

SCALE: 3:1 SHEET 6 OF 22 REV P7

LOC	DIST	REV	DATE	BY	APPV
ES	00				

REVISIONS		DATE	BY	APPV
1	SEE SHEET 1			

LOC		DIST		REVOLUTIONS				
P	LTN	DATE	DMN	APVD	DESCRIPTION	DATE	DMN	APVD
-	-	-	-	-	SEE SHEET 1	-	-	-

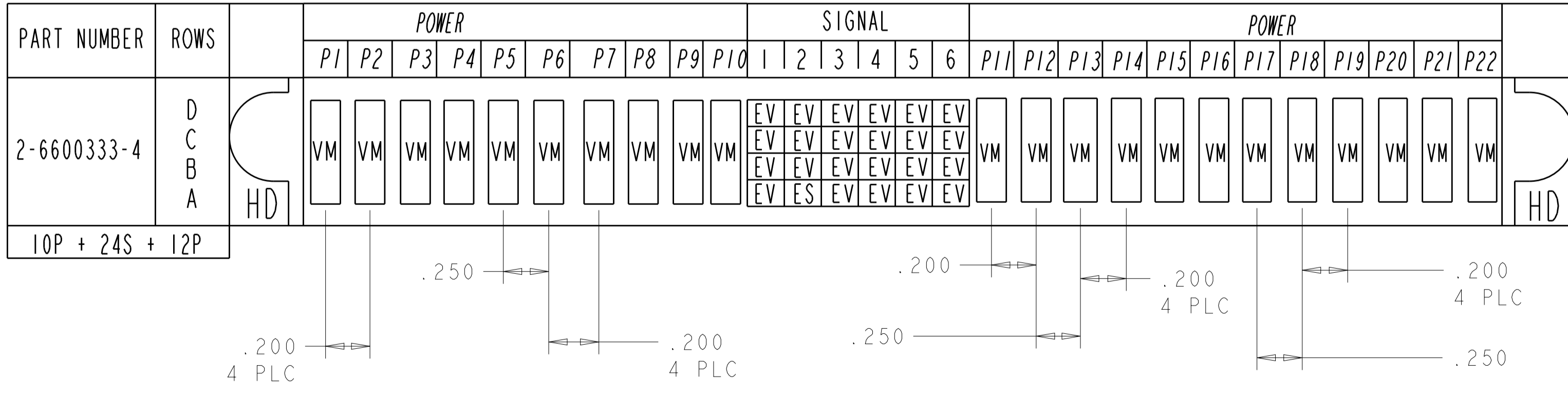
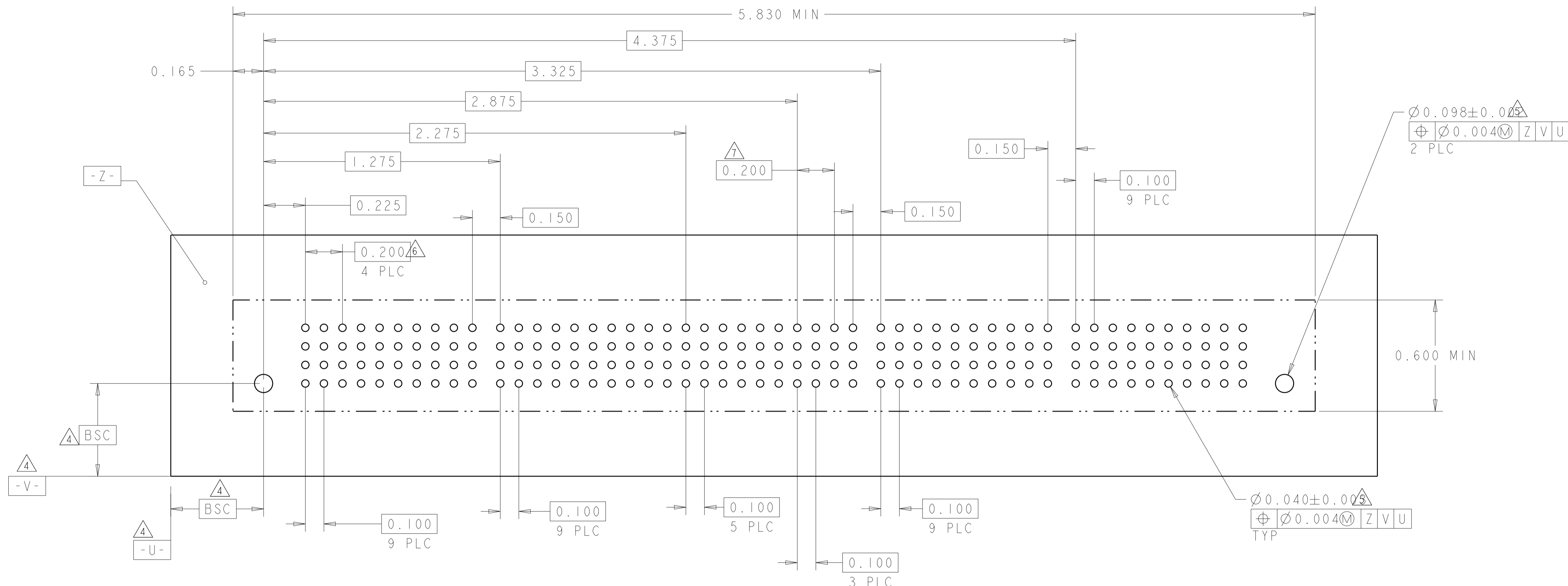
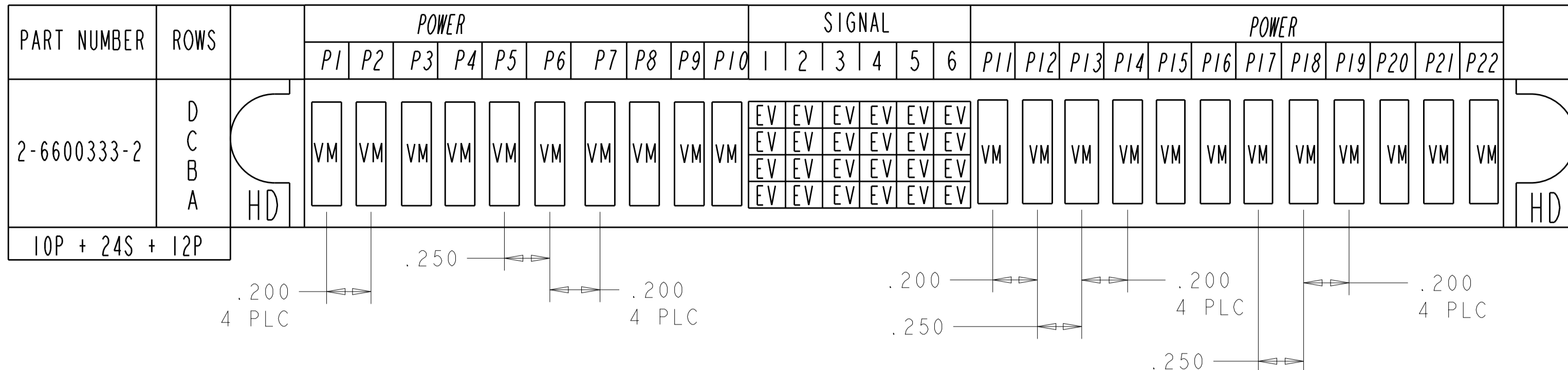

THE PART NUMBER 2-6600333-4 PCB LAYOUT IS SAME AS 2-6600333-2

THIS DRAWING IS A CONTROLLED DOCUMENT.		DMN J. McCLINTON 23MAR2005	STE		TE Connectivity	
DIMENSIONS:		CHK D. TROUT 23MAR2005	NAME VERTICAL HEADER ASSEMBLY, W/GUIDES, PRESS FIT, TYPE PSP MULTI-BEAM XL			
INCH		APVD B. WHYNE 23MAR2005	PRODUCT SPEC 108-1973			
TOLERANCES UNLESS OTHERWISE SPECIFIED:		APPLICATION SPEC 114-13038				
0 PLC ±.01		SIZE A100779C=6600333				
1 PLC ±.01		RESTRICTED TO				
3 PLC ±.005		SCALE 3:1 SHEET 7 OF 22 REV P7				
4 PLC ±.002		WEIGHT				
ANGLES ±.020		Customer Drawing				
FINISH		SCALE 3:1 SHEET 7 OF 22 REV P7				

LOC	DIST	REV	DATE	BY	APPV
ES	00				
REVISIONS					

PART NUMBER	ROWS	SIGNAL																POWER											SIGNAL											POWER										
		1	2	3	4	5	6	7	8	9	10	11	12	13	14	15	16	PI1	P2	P3	P4	P5	P6	P7	P8	P9	PI10	PI11	17	18	19	20	21	PI2	PI3	PI4	PI5	PI6	PI7	PI8	PI9	P20	P21	P22	P23	P24	P25	P26		
2-6600333-3	D	EV	EV	EV	EV	EV	EV	EV	EV	EV	EV	EV	EV	EV	EV	EV	VM	VM	VM	VM	VM	VM	VM	VM	VM	VM	VM	VM	EV	EV	EV	EV	EV	VM	VM	VM	VM	VM	VM	VM	VM	VM	VM	VM	VM	VM	VM	VM	VM	
	C	EV	EV	EV	EV	EV	EV	EV	EV	EV	EV	EV	EV	EV	EV	EV	VM	VM	VM	VM	VM	VM	VM	VM	VM	VM	VM	EV	EV	EV	EV	EV	VM	VM	VM	VM	VM	VM	VM	VM	VM	VM	VM	VM	VM	VM	VM			
	B	EV	EV	EV	EV	EV	EV	EV	EV	EV	EV	EV	EV	EV	EV	EV	VM	VM	VM	VM	VM	VM	VM	VM	VM	VM	VM	EV	EV	EV	EV	EV	VM	VM	VM	VM	VM	VM	VM	VM	VM	VM	VM	VM	VM	VM	VM			
	A	EV	EV	EV	EV	EV	EV	EV	EV	EV	EV	EV	EV	EV	EV	EV	VM	VM	VM	VM	VM	VM	VM	VM	VM	VM	VM	EV	EV	EV	EV	EV	VM	VM	VM	VM	VM	VM	VM	VM	VM	VM	VM	VM	VM	VM	VM			
64S+11P+20S+15P	HD																																																	

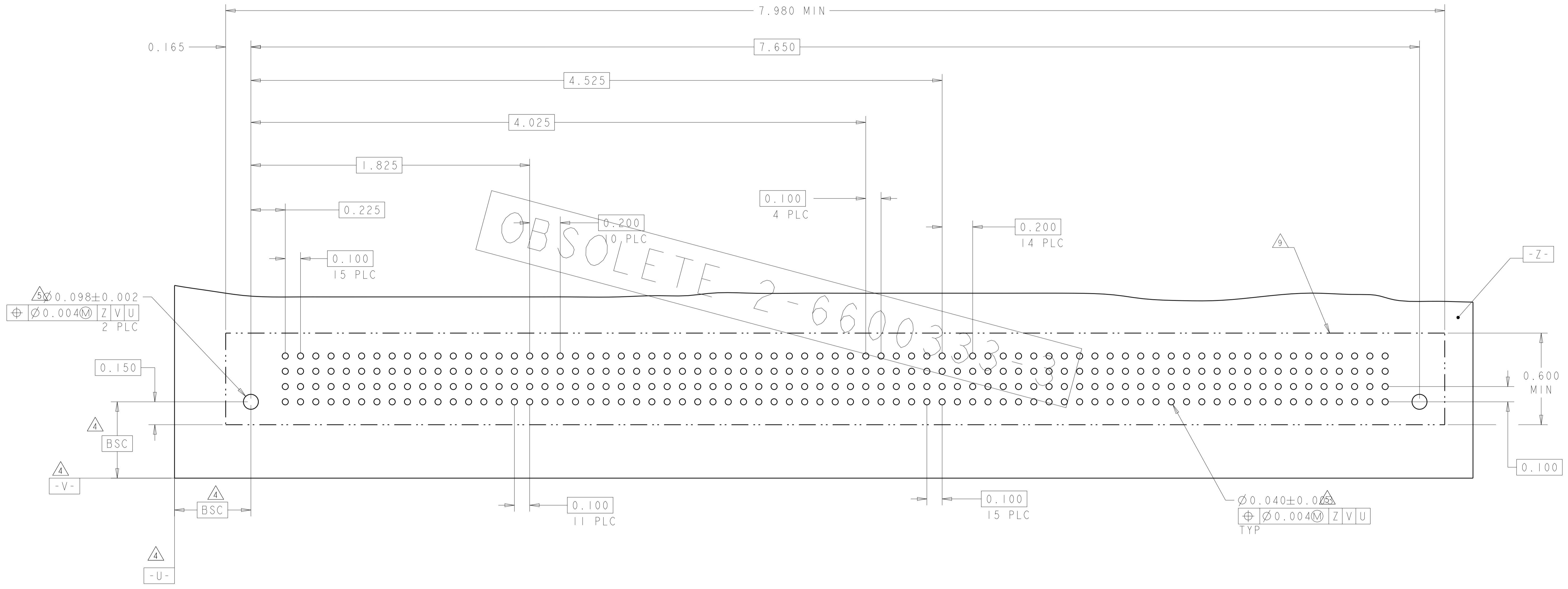

THIS DRAWING IS A CONTROLLED DOCUMENT.		OWN	J. McCLINTON	23MAR2005	 TE Connectivity
DIMENSIONS:		CHK	D. TROUT	23MAR2005	
INCH		APV	B. WHYNE	23MAR2005	
		TOLERANCES UNLESS OTHERWISE SPECIFIED:			
		0 PLC ±			NAME VERTICAL HEADER ASSEMBLY, W/GUIDES, PRESS FIT, TYPE PSP MULTI-BEAM XL
		1 PLC ±.01			
		2 PLC ±.01			
		3 PLC ±.005			
		4 PLC ±.0020			SIZE A100779C=6600333
		ANGLES ±.020			
		FINISH			
		MATERIAL			
		WEIGHT			RESTRICTED TO -
		Customer Drawing			
		SCALE		3:1	
		SHEET		8 OF 22	
		REV		P7	

LOC		DIST		REVISIONS			
ES	00	P	LTN	DESCRIPTION	DATE	DMN	APVD
		-		SEE SHEET 1			

PART NUMBER	ROWS	POWER				SIGNAL				POWER		
		P1	P2	P3	P4	1	2	3	4	P5	P6	P7
2-6600333-5	D	VM	VM	VM	VM	EV	EV	EV	EV	VM	VM	VM
	C					EV	EV	EV	EV			
	B					EV	EV	EV	EV			
	A					ES	EV	EV	EV			
4P+16S+3P		HD										HD

PART NUMBER	ROWS	POWER			SIGNAL						POWER		
		P1	P2	P3	1	2	3	4	5	6	P4	P5	P6
2-6600333-6	D	VM	VM	VM	EV	EV	EV	EV	EV	EV	VM	VM	VM
	C				EV	EV	EV	EV	EV				
	B				EV	EV	EV	EV	EV				
	A				ES	EV	EV	EV	EV				
3P+24S+3P		HD											HD

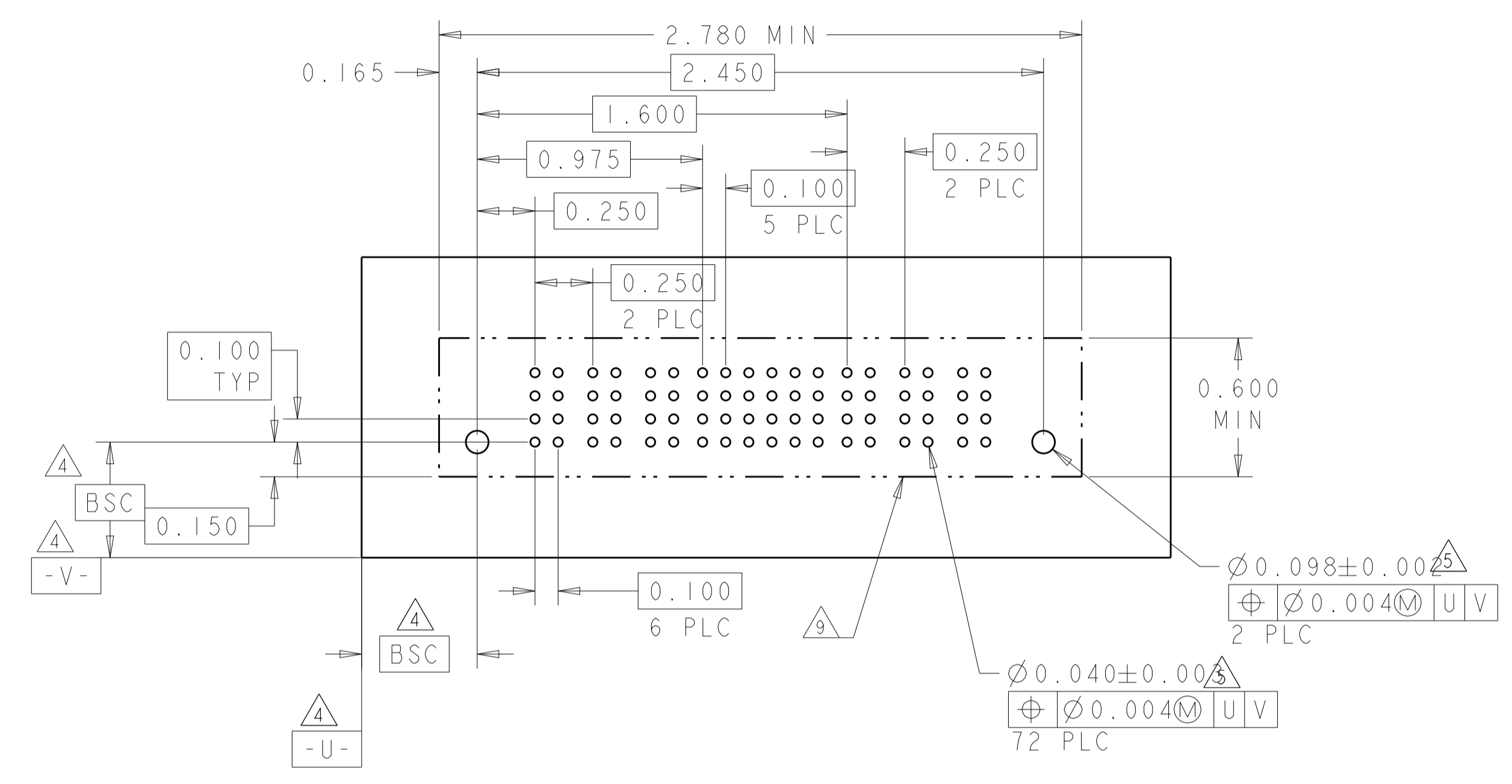
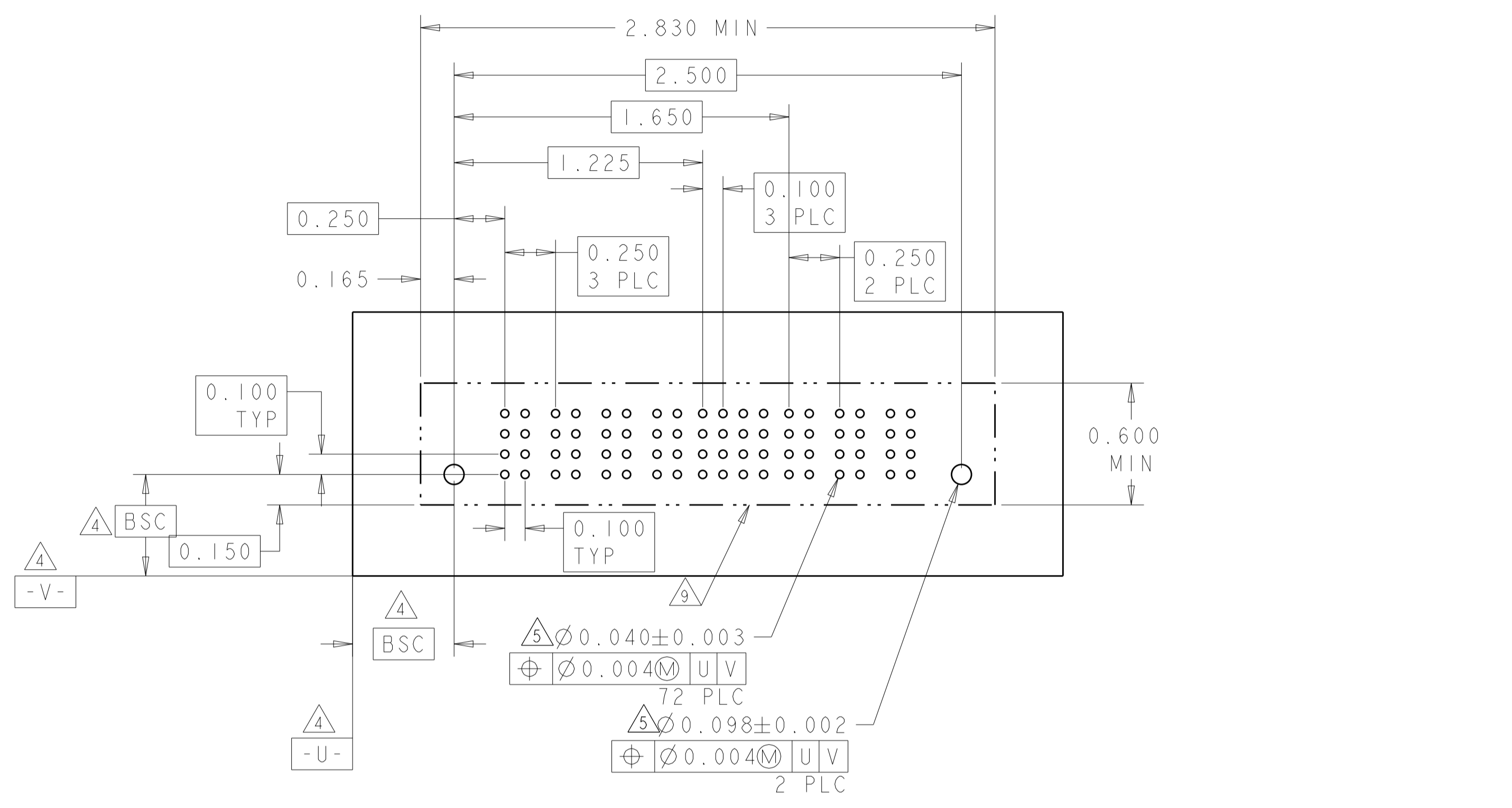

PART NUMBER	ROWS	POWER				SIGNAL						POWER					
		P1	P2	P3	P4	1	2	3	4	5	6	P5	P6	P7	P8	P9	
2-6600333-7	D	VM	VM	VM	VM	ES	EV	ES	EV	ES	EV	VM	VM	VM	VM	VM	
	C					EV	EV	EV	ES	EV							
	B					EV	ES	EV	EV	EV							
	A					ES	ES	EV	EV	ES							
4P+24S+5P		HD															HD

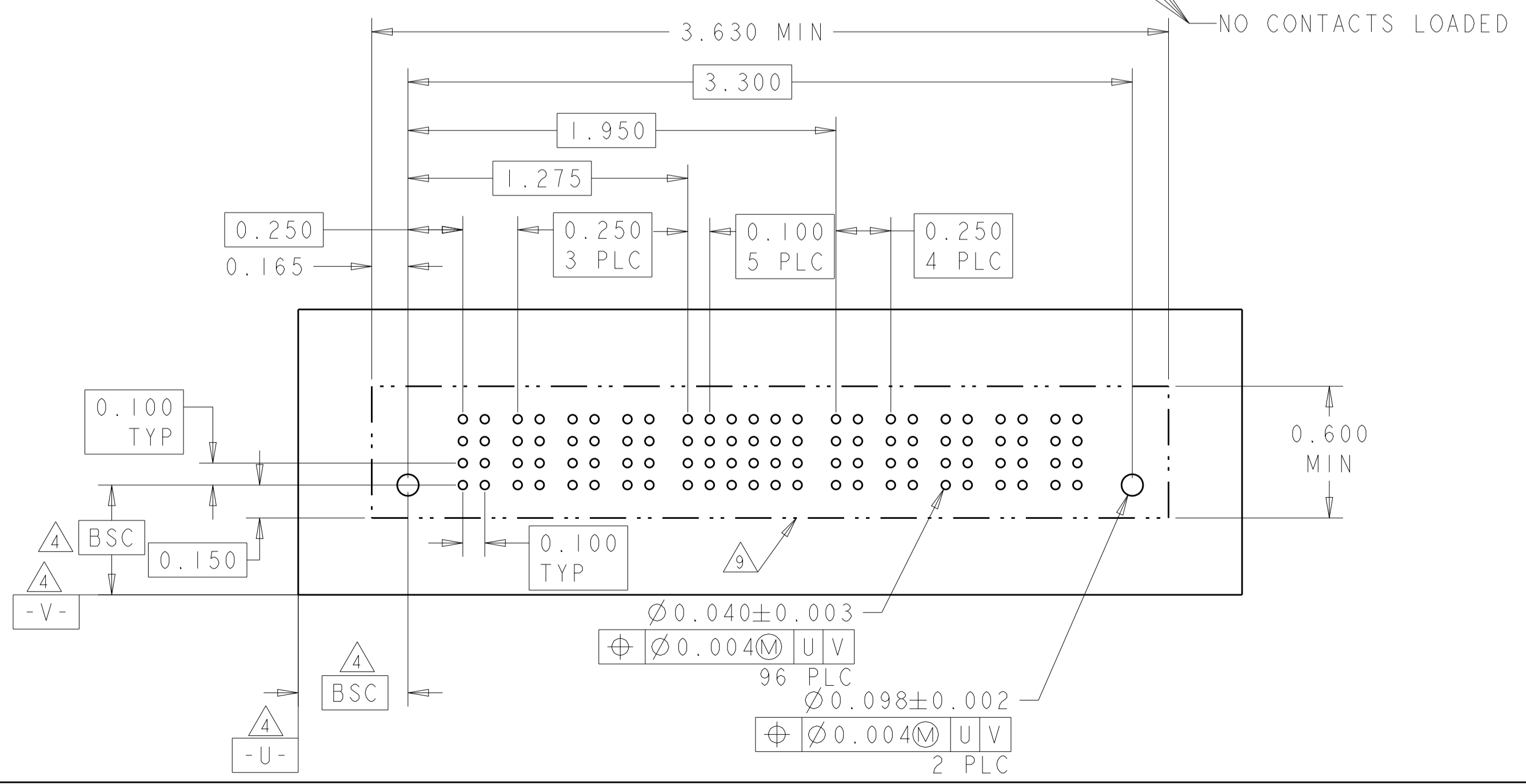

THIS DRAWING IS A CONTROLLED DOCUMENT.

DIMENSIONS: INCH	TOLERANCES UNLESS OTHERWISE SPECIFIED:	DMN: J. McCLINTON 23MAR2005	CHK: D. TROUT 23MAR2005	APVD: B. WHYNE 23MAR2005
	0 PLC ±.01	PRODUCT SPEC	NAME: VERTICAL HEADER ASSEMBLY, W/GUIDES, PRESS FIT, TYPE PSP MULTI-BEAM XL	
	1 PLC ±.01	APPLICATION SPEC	SIZE: A100779	DRAWING NO: C=6600333
MATERIAL:	FINISH:	WEIGHT:	SCALE: 3:1	SHEET 9 OF 22
Customer Drawing		REV P7		

LOC	DIST	REVISIONS			
P	LTN	DESCRIPTION	DATE	DMN	APVD
ES	00	SEE SHEET 1	-	-	-

PART NUMBER	ROWS	POWER				SIGNAL				POWER		
		P1	P2	P3	P4	1	2	3	4	P5	P6	P7
2-6600333-8	D	VM	VM	VM	VM	ES	ES	EV	EV	VM	VM	VM
	C					ES	EV	EV	EV			
	B					ES	EV	EV	EV			
	A					EV	EV	ES	ES			
4P+16S+3P												HD

PART NUMBER	ROWS	POWER		SIGNAL								POWER			
		P1	P2	1	2	3	4	5	6	7	8	P3	P4		
2-6600333-9	D	VM	VM	ES	EV	EV	EV	EV	EV	EV	EV	EV	EV	VM	
	C			EV	EV	EV	EV	EV	EV	EV	EV				
	B			EV	EV	EV	EV	EV	EV	EV	EV				
	A			ES	EV	EV	EV	EV	EV	EV	ES				
2P+32S+2P															HD

NO CONTACT LOADED

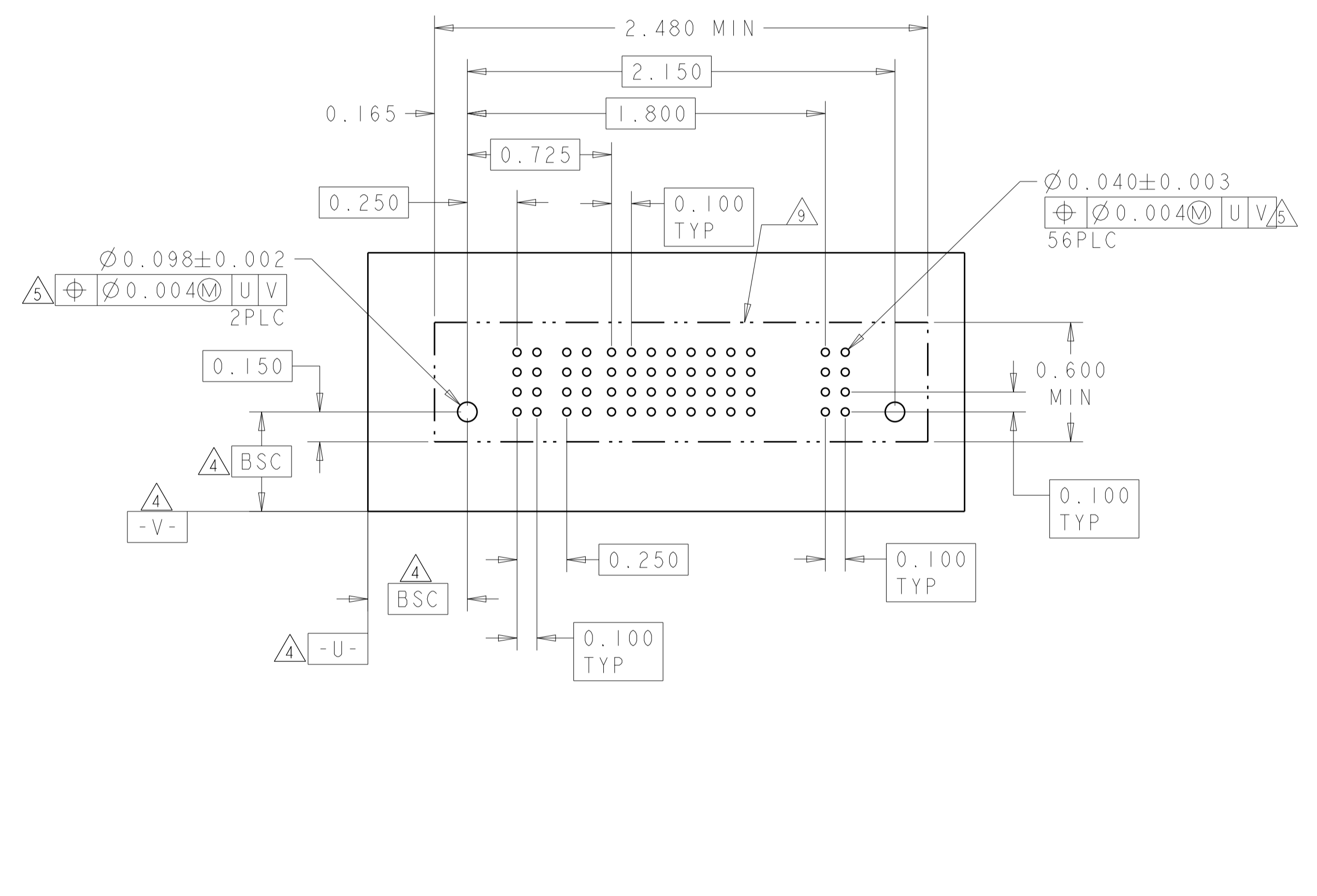
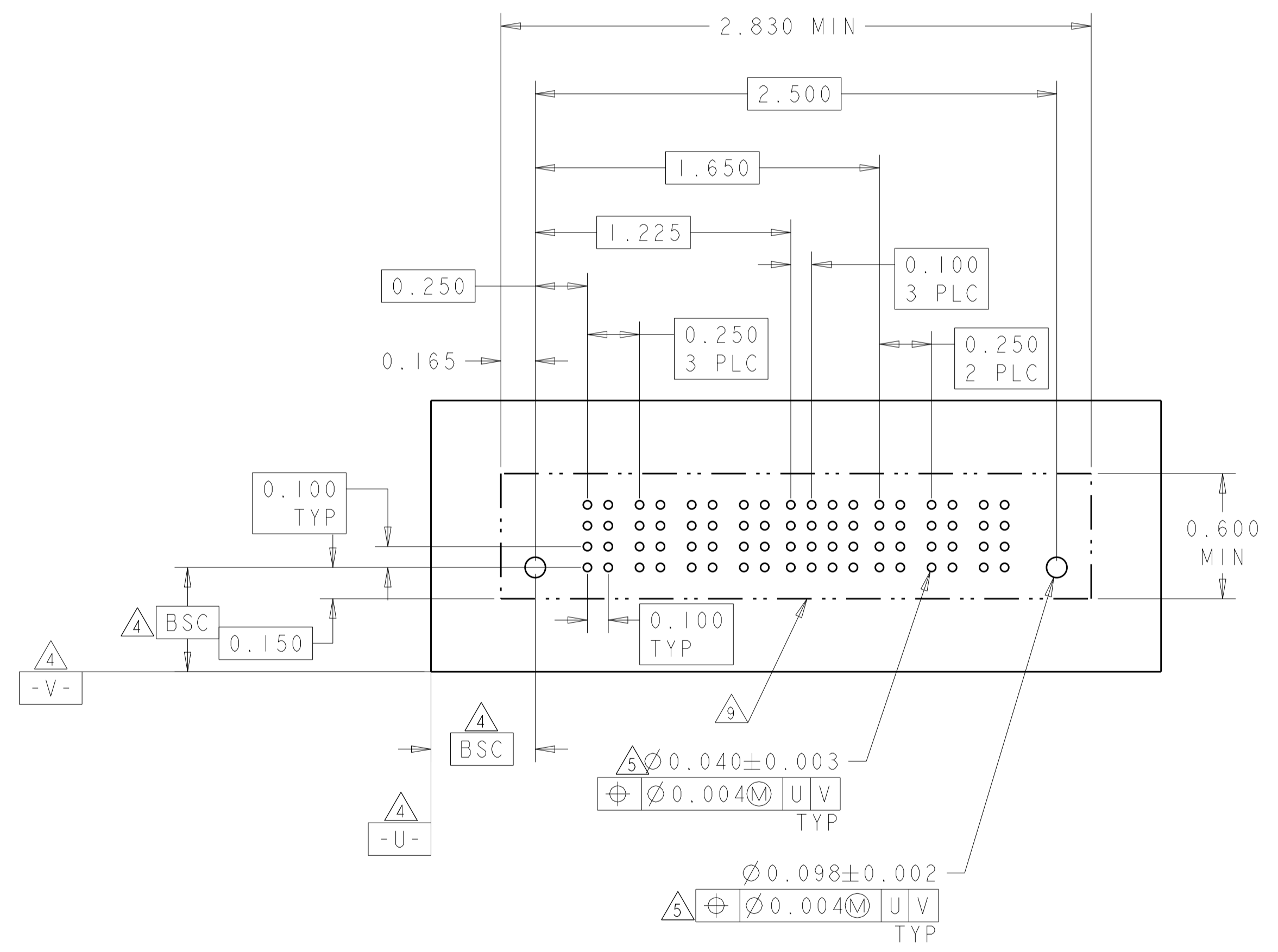

THIS DRAWING IS A CONTROLLED DOCUMENT.

DIMENSIONS:	TOLERANCES UNLESS OTHERWISE SPECIFIED:	DMN	J. McCLINTON	23MAR2005
INCH	0 PLC ±.01	CHK	D. TROUT	23MAR2005
	1 PLC ±.01	APVD	P. MLYNE	23MAR2005
	2 PLC ±.01	PRODUCT SPEC		
	3 PLC ±.005	108-1973		
	4 PLC ±.0020	APPLICATION SPEC		
	ANGLES ±.2°	114-13038		
MATERIAL	FINISH	WEIGHT		

Customer Drawing

SCALE 3:1 SHEET 10 OF 22 REV P7

STE TE Connectivity

VERTICAL HEADER ASSEMBLY, W/GUIDES, PRESS FIT, TYPE PSP MULTI-BEAM XL

SIZE CAGE CODE DRAWING NO RESTRICTED TO

A100779C=6600333

LOC	DIST	REV	DATE	BY	APPV
ES	00				
		REVISIONS			
		DESCRIPTION	DATE	BY	APPV
		SEE SHEET 1			

PART NUMBER	ROWS	POWER						SIGNAL						POWER							
		P1	P2	P3	P4	P5	P6	1	2	3	4	5	6	P7	P8	P9	P10	P11	P12	P13	P14
3-6600333-1	D	VM	VM	VM	VM	VM	EV	EV	EV	EV	EV	EV	VM	VM	VM	VM	VM	VM			
	C						EV	EV	EV	EV	EV	EV									
	B						EV	EV	EV	EV	EV	EV									
	A						ES	ES	EV		EV	EV									
6ACP + 24S + 8P		HD																			

PART NUMBER	ROWS	POWER				SIGNAL						POWER			
		P1	P2	P3	P4	1	2	3	4	5	6	P5	P6	P7	P8
3-6600333-2	D	VM	VM	VM	VM	EV	EV	EV	EV	EV	EV	VM	VM	VM	VM
	C					EV	EV	EV	EV	EV	EV				
	B					EV	EV	EV	EV	EV	EV				
	A					EV	EV	EV	EV	EV	EV				
4P+24S+4P		HD													

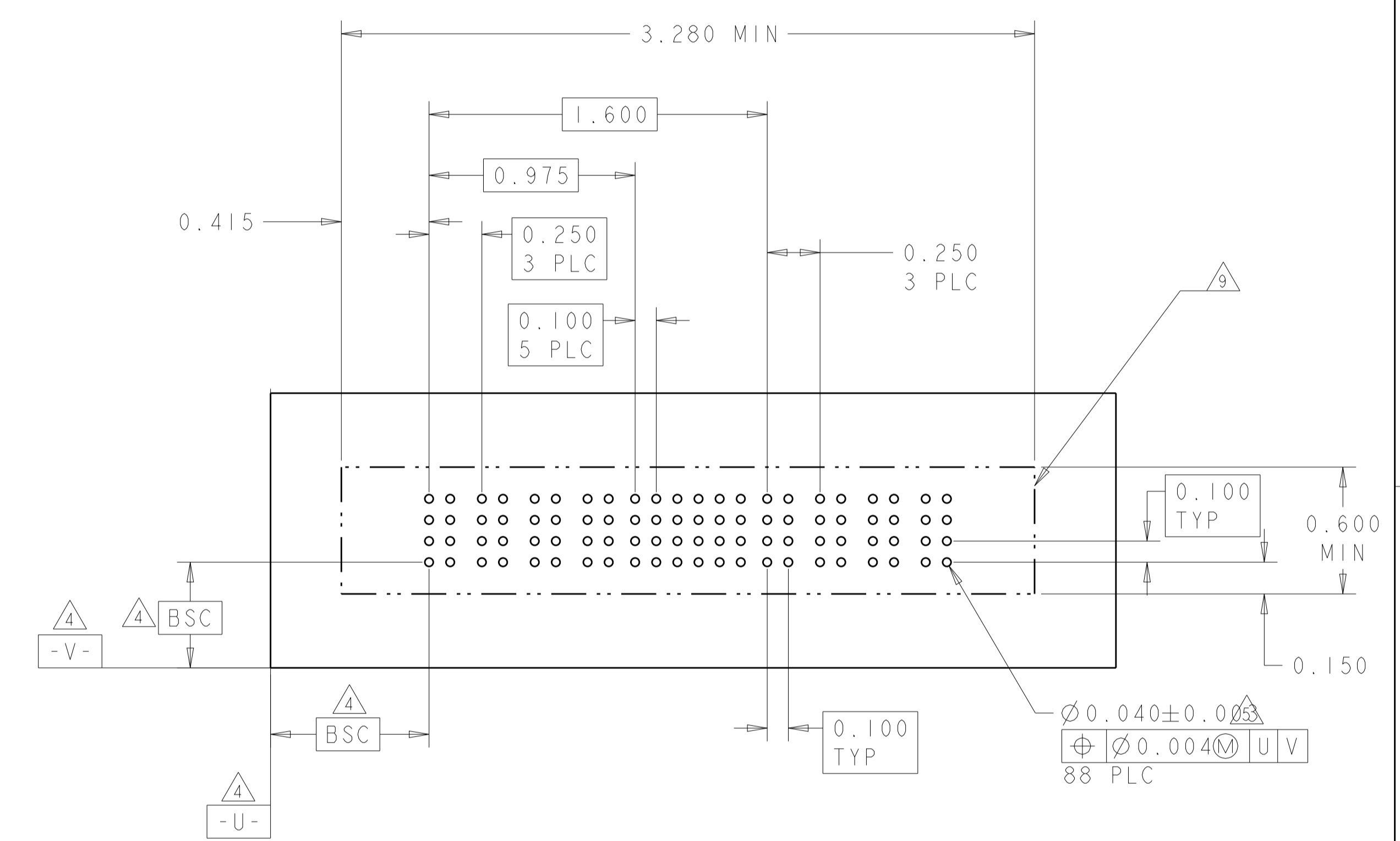
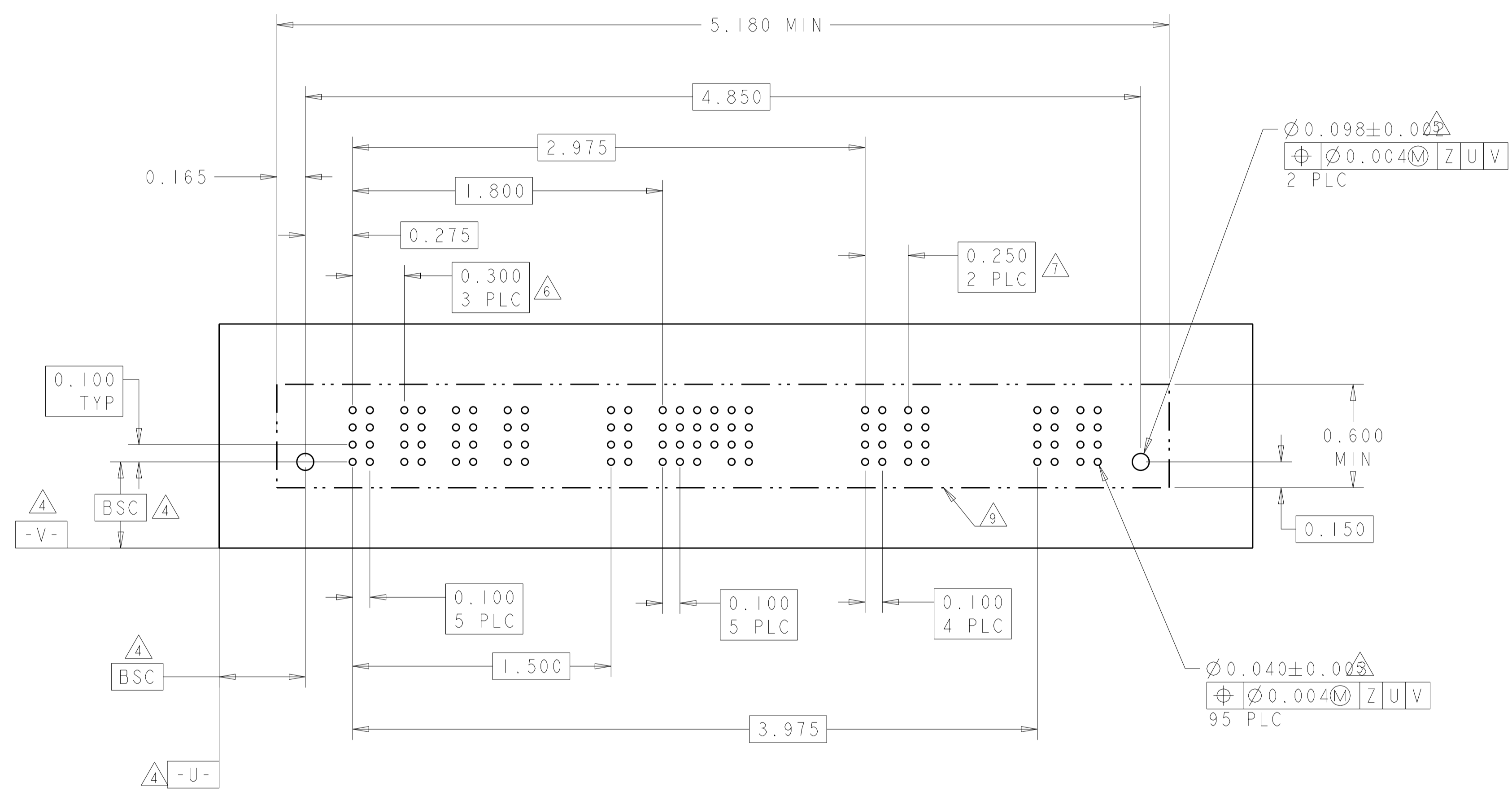

THIS DRAWING IS A CONTROLLED DOCUMENT.

DIMENSIONS:	TOLERANCES UNLESS OTHERWISE SPECIFIED:	OWN	J. McCLINTON	23MAR2005
INCH	0 PLC ±	CHK	D. TROUT	23MAR2005
	1 PLC ±.01	APPV	P. WHYNE	23MAR2005
	2 PLC ±.01	PRODUCT SPEC		
	3 PLC ±.005	APPLICATION SPEC		
	4 PLC ±.0020	SIZE	114-13038	
	ANGLES ±.020	WEIGHT		
MATERIAL	FINISH	Customer Drawing		

NAME: VERTICAL HEADER ASSEMBLY, W/GUIDES, PRESS FIT, TYPE PSP MULTI-BEAM XL

SIZE: A1 00779 C=6600333

SCALE: 3:1 SHEET 11 OF 22 REV P7

LOC	DIST	REV	DATE	BY	APPD
ES	00				
REVISIONS			DESCRIPTION	DATE	BY
			SEE SHEET 1		

PART NUMBER	ROWS	POWER				SIGNAL		POWER			
		P1	P2	P3	P4	1	2	P5	P6	P7	P8
3-6600333-4	D C B A	VM	VM	VM	VM	EV	EV	VM	VM	VM	VM
4P + 8S + 4P											

PART NUMBER	ROWS	POWER				SIGNAL				POWER			
		P1	P2	P3	P4	1	2	3	4	P5	P6	P7	P8
3-6600333-3	D C B A	VM	VM	VM	VM	EV	EV	EV	EV	VM	VM	VM	VM
4P + 16S + 4P													

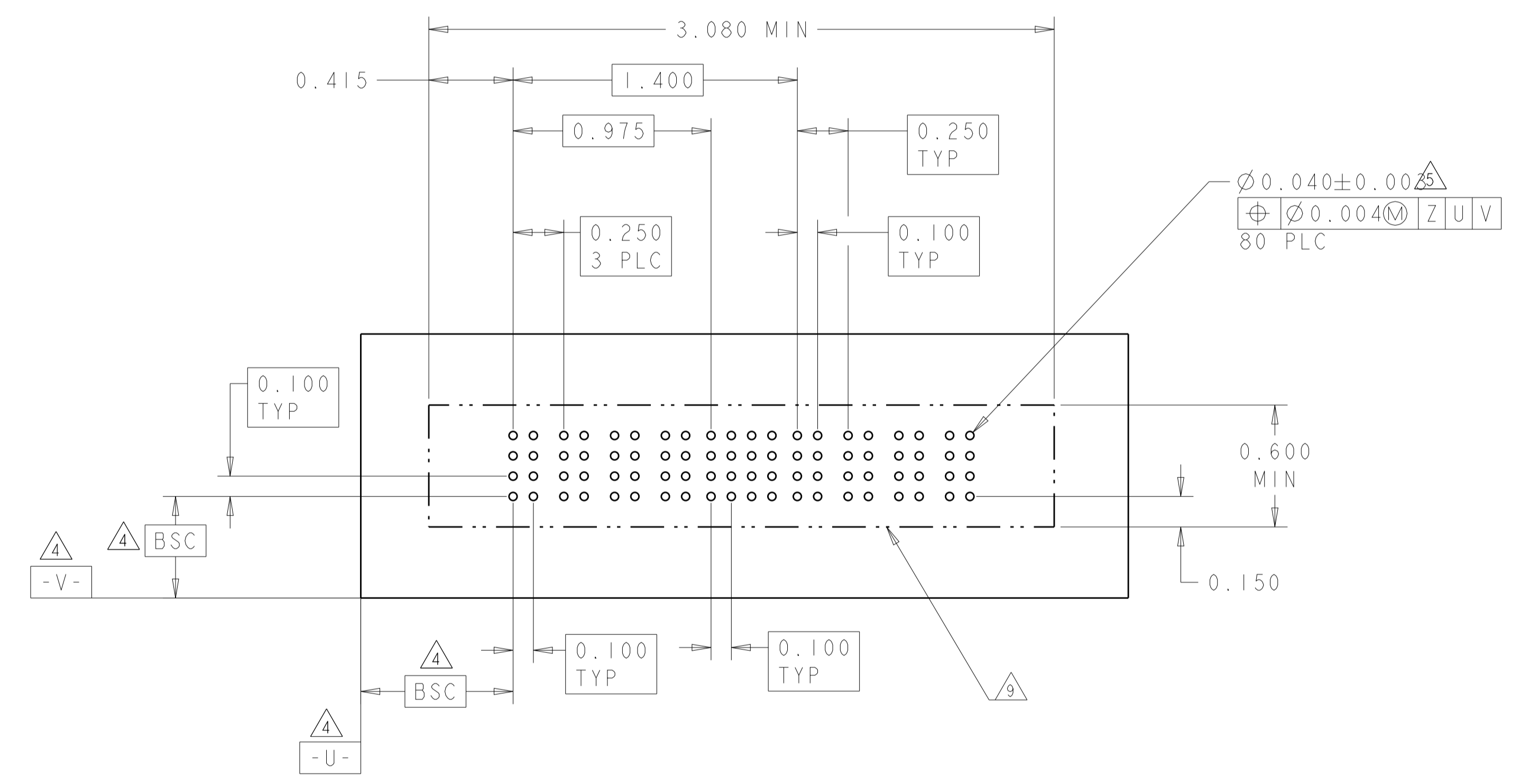
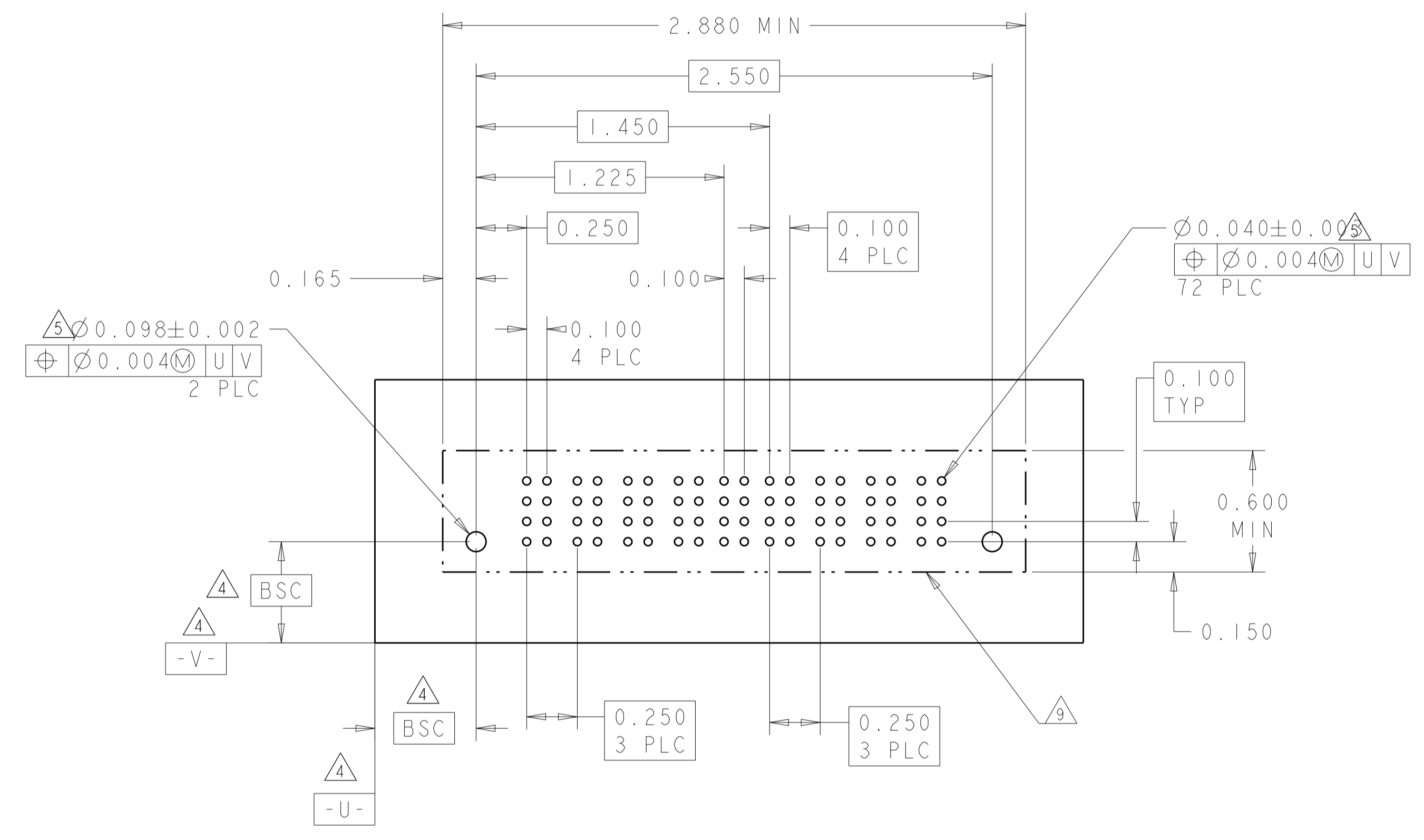

THIS DRAWING IS A CONTROLLED DOCUMENT.		OWN J. McCLINTON 23MAR2005	 TE Connectivity										
DIMENSIONS: INCH		CHK D. TROUT 23MAR2005											
TOLERANCES UNLESS OTHERWISE SPECIFIED:		APVD P. WHYNE 23MAR2005	NAME VERTICAL HEADER ASSEMBLY, W/GUIDES, PRESS FIT, TYPE PSP MULTI-BEAM XL										
<table border="1"> <tr> <td>0 PLC</td> <td>±</td> </tr> <tr> <td>2 PLC</td> <td>±.01</td> </tr> <tr> <td>3 PLC</td> <td>±.005</td> </tr> <tr> <td>4 PLC</td> <td>±.0020</td> </tr> <tr> <td>ANGLES</td> <td>±.020</td> </tr> </table>		0 PLC	±	2 PLC	±.01	3 PLC	±.005	4 PLC	±.0020	ANGLES	±.020	PRODUCT SPEC 108-1973	SIZE A100779
0 PLC	±												
2 PLC	±.01												
3 PLC	±.005												
4 PLC	±.0020												
ANGLES	±.020												
MATERIAL		APPLICATION SPEC 114-13038	CAGE CODE C=6600333										
FINISH		WEIGHT	RESTRICTED TO										
		Customer Drawing	SCALE 3:1 SHEET 12 OF 22 REV P7										

LOC	DIST	REV	DATE	BY	APPD
ES	00				
REVISIONS			DATE	BY	APPD
-			SEE SHEET 1	-	-

PART NUMBER	ROWS	POWER			SIGNAL						POWER			
		P1	P2	P3	1	2	3	4	5	6	P4	P5	P6	
3-6600333-5	D	VM	VM	VM	EV	EV	EV	EV	EV	EV	VM	VM	VM	
	C				EV	EV	EV	EV	EV	EV				
	B				EV	EV	EV	EV	EV	EV				
	A				EV	EV	EV	EV	EV	EV				
3P+24S+3P														

(K1)

PART NUMBER	ROWS	POWER		SIGNAL						POWER		
		P1	P2	1	2	3	4	5	6	P3	P4	
3-6600333-7	D	VM	VM	ES	EV	EV	EV	EV	EV	VM	VM	
	C			ES	EV	EV	EV	EV	EV			
	B			EV	EV	EV	EV	EV	EV			
	A			ES	EV	EV	EV	EV	EV			
2P+24S+2P												

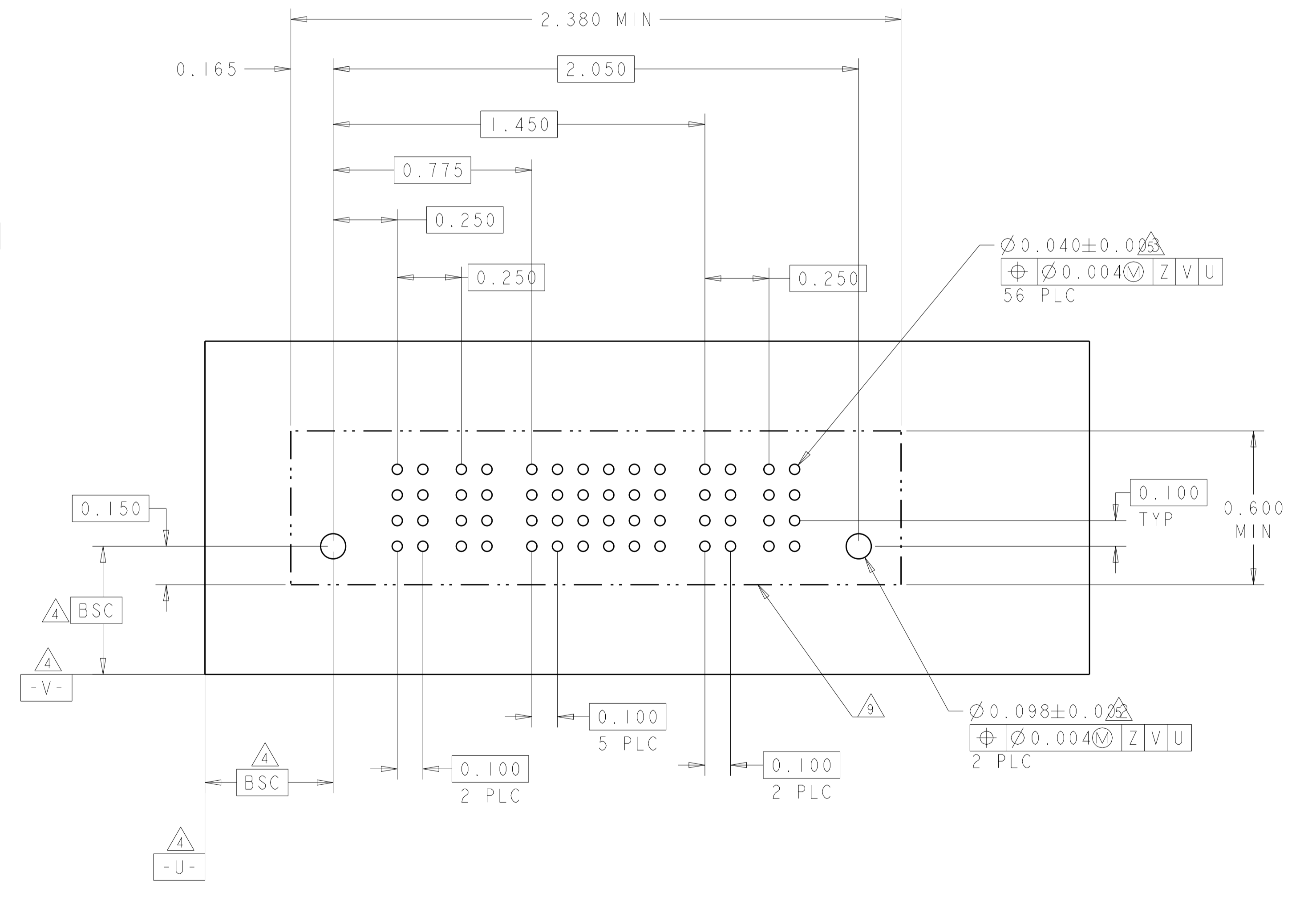
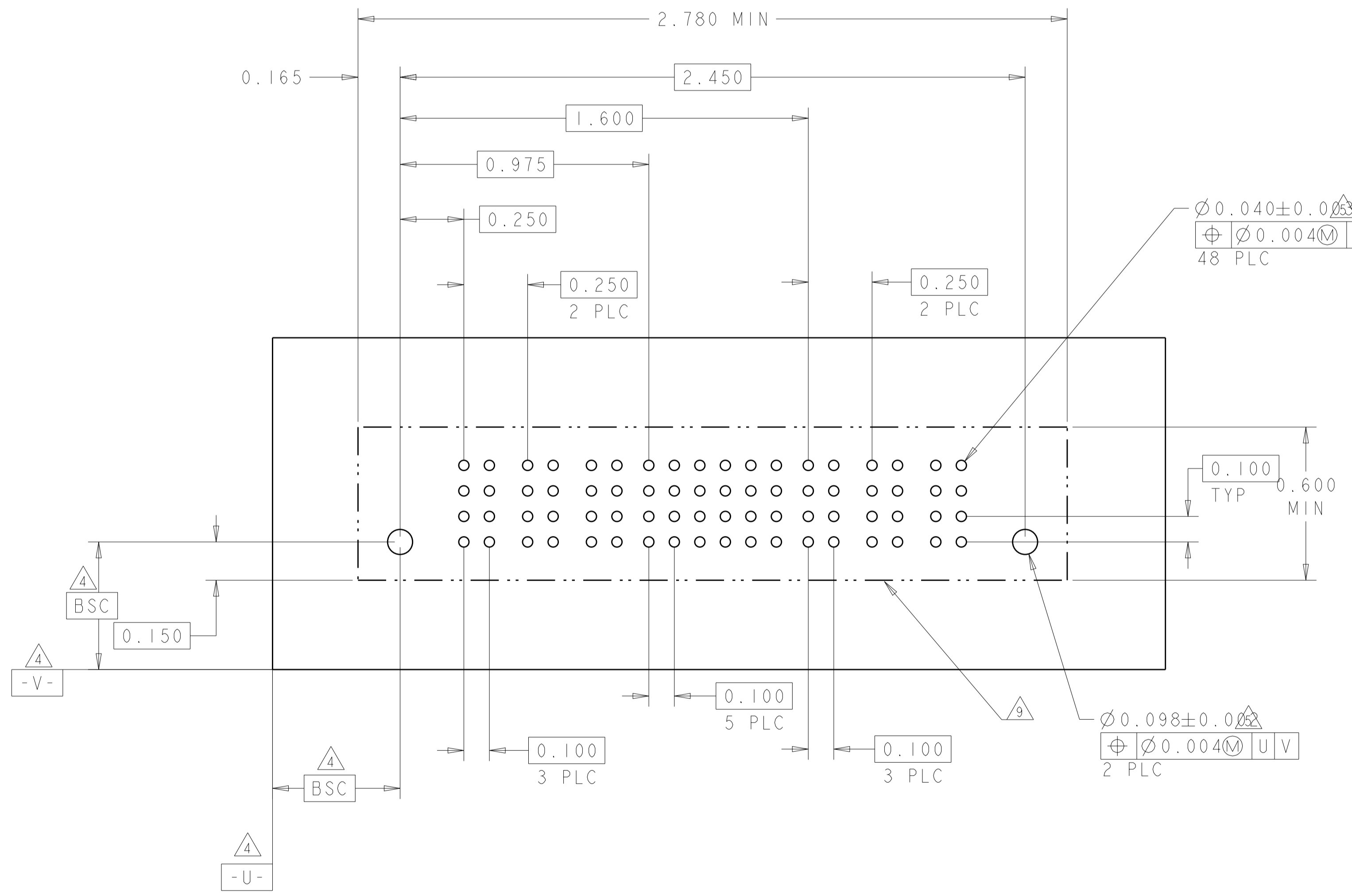

THIS DRAWING IS A CONTROLLED DOCUMENT.

DIMENSIONS:	TOLERANCES UNLESS OTHERWISE SPECIFIED:	OWN	J. McCLINTON	23MAR2005
INCH	0 PLC ±	CHK	D. TROUT	23MAR2005
	1 PLC ±.01	APPD	B. WHYNE	23MAR2005
	2 PLC ±.01	PRODUCT SPEC		
	3 PLC ±.005	APPLICATION SPEC		
	4 PLC ±.0020	SIZE	114-13038	
	ANGLES ±.2°	WEIGHT		
MATERIAL	FINISH	Customer Drawing		

NAME: VERTICAL HEADER ASSEMBLY, W/GUIDES, PRESS FIT, TYPE PSP MULTI-BEAM XL

SIZE: A1 00779 C=6600333

SCALE: 3:1 SHEET 13 OF 22 REV P7

LOC	DIST	REVISIONS			
P	LTN	DESCRIPTION	DATE	DMN	APVD
-	-	SEE SHEET 1	-	-	-

PART NUMBER	ROWS	POWER				SIGNAL														POWER						
		P1	P2	P3	P4	1	2	3	4	5	6	7	8	9	10	11	12	13	14	P5	P6	P7	P8			
3-6600333-6	D	VM	VM	VM	VM	EV	EV	EV	EV	EV	EV	EV	EV	EV	EV	EV	EV	EV	EV	EV	EV	VM	VM	VM	VM	
	C					EV	EV	EV	EV	EV	EV	EV	EV	EV	EV	EV	EV	EV	EV	EV	EV					
	B					EV	EV	EV	EV	EV	EV	EV	EV	EV	EV	EV	EV	EV	EV	EV	EV					EV
	A					EV	EV	EV	EV	EV	EV	EV	EV	EV	EV	EV	EV	EV	EV	EV	EV					EV
4P+56S+4P																										

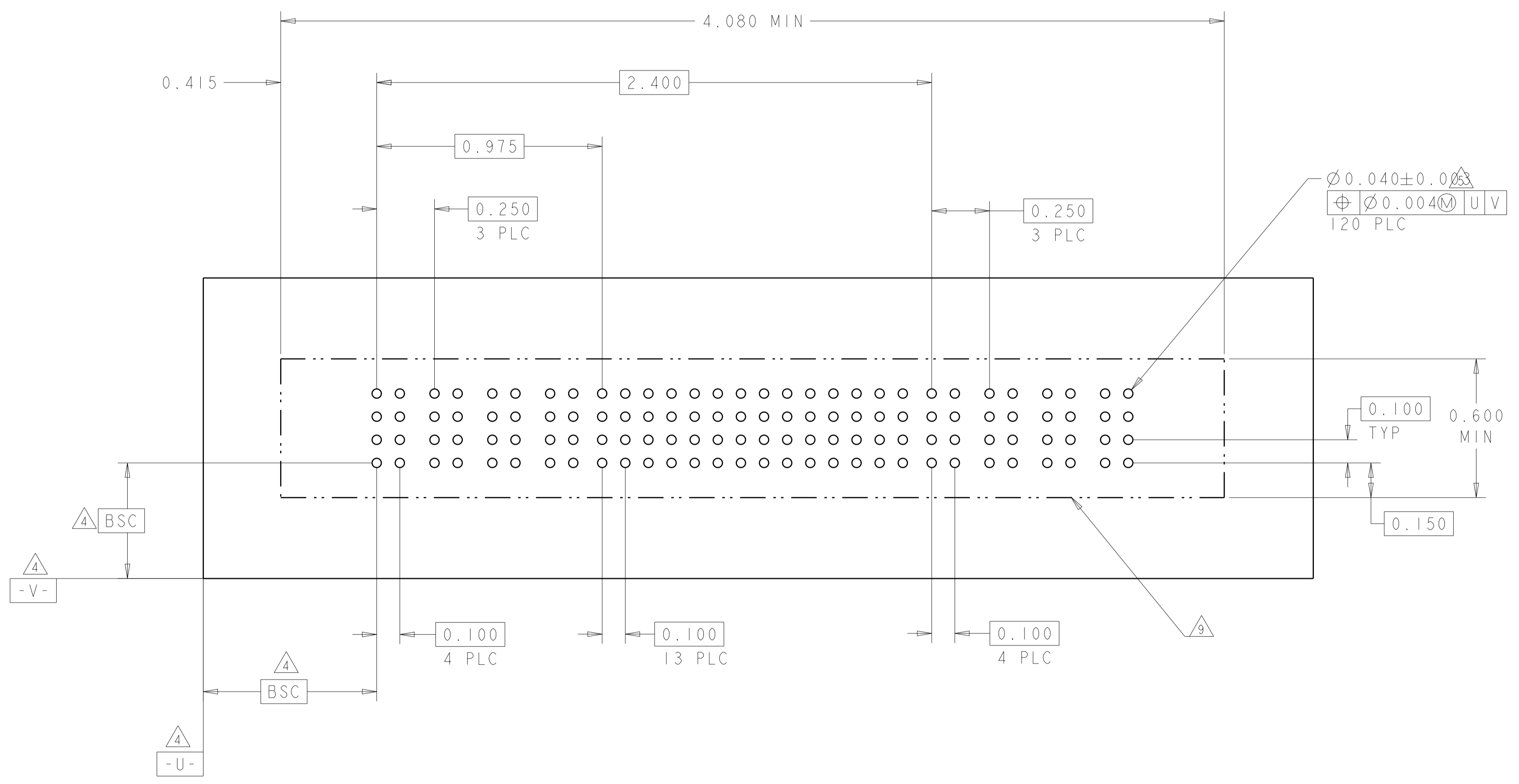

THIS DRAWING IS A CONTROLLED DOCUMENT.

DIMENSIONS:	TOLERANCES UNLESS OTHERWISE SPECIFIED:	DMN	J. McCLINTON	23MAR2005
INCH	0 PLC ± 2 PLC ±.01 3 PLC ±.005 4 PLC ±.0020	CHK	D. TROUT	23MAR2005
	ANGLES ±.2°	APVD	P. WHYNE	23MAR2005
MATERIAL	FINISH	PRODUCT SPEC	NAME	
		108-1973	VERTICAL HEADER ASSEMBLY, W/GUIDES, PRESS FIT, TYPE PSP	
		APPLICATION SPEC	SIZE	CAGE CODE
		114-13038	A100779	C=6600333
		WEIGHT	RESTRICTED TO	
			Customer Drawing	
		SCALE	3:1	SHEET 14 OF 22
				REV P7

TE Connectivity

LOC	DIST	REV	DATE	BY	APPD
ES	00				

REVISIONS					
REV	DATE	BY	APPD	DESCRIPTION	DATE
-	-	-	-	SEE SHEET 1	-

PART NUMBER	ROWS	POWER						SIGNAL		POWER					
		P1	P2	P3	P4	P5	P6	I	2	P7	P8	P9	P10	P11	P12
3-6600333-8	D	VM	VM	VM	VM	VM	VM	EV	EV	VM	VM	VM	VM	VM	VM
	C							EV	EV						
	B							EV	EV						
	A							EV	EV						
6P+8S+6P		HD													HD

PART NUMBER	ROWS	POWER			SIGNAL						POWER		
		P1	P2	P3	1	2	3	4	5	6	P4	P5	P6
3-6600333-9	D	VM	VM	VM	EV	EV	EV	EV	EV	EV	VM	VM	VM
	C				EV	EV	EV	EV	EV				
	B				EV	EV	EV	EV	EV				
	A				ES	EV	EV	EV	EV				
3ACP+24S+3ACP		HD											HD

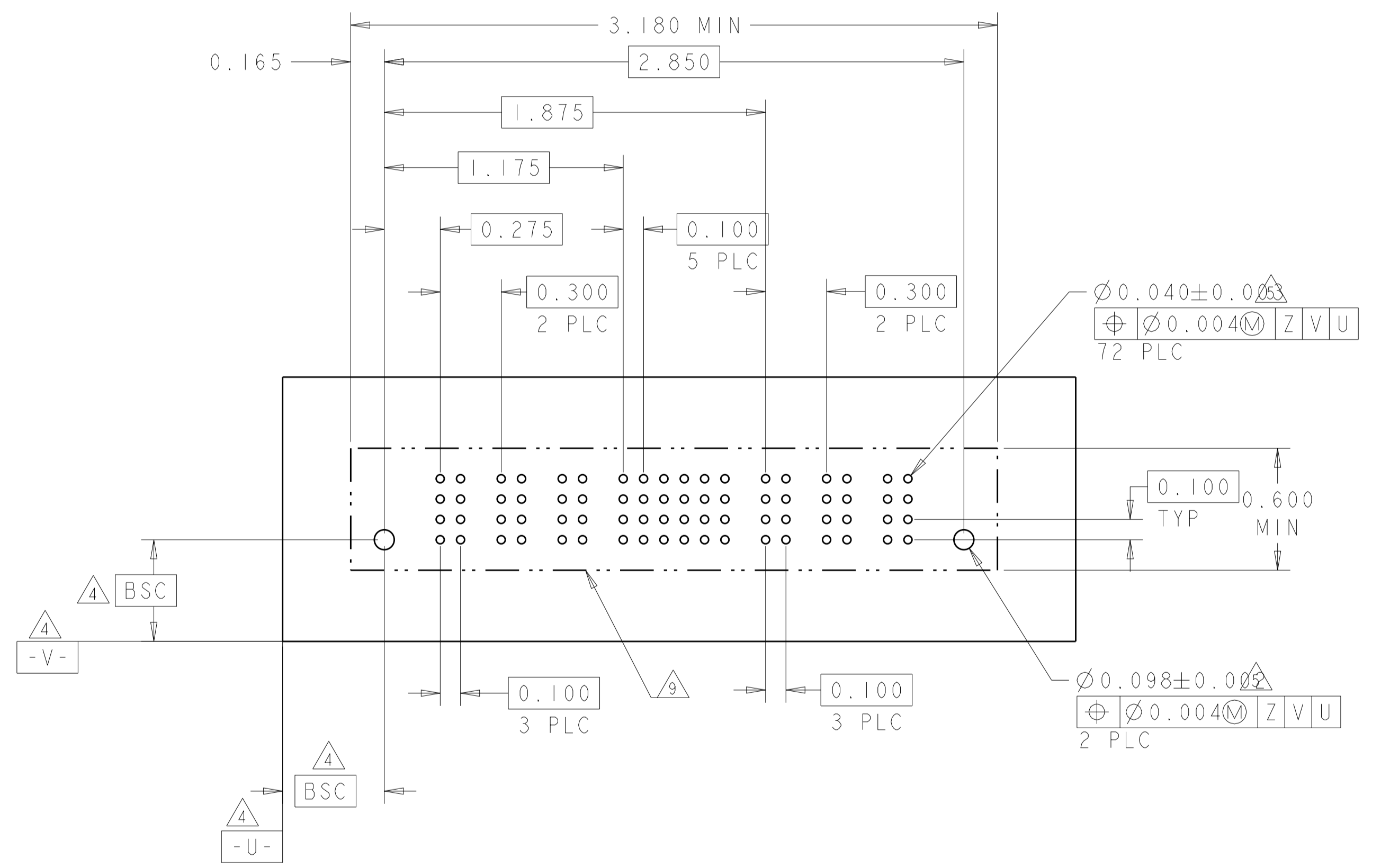
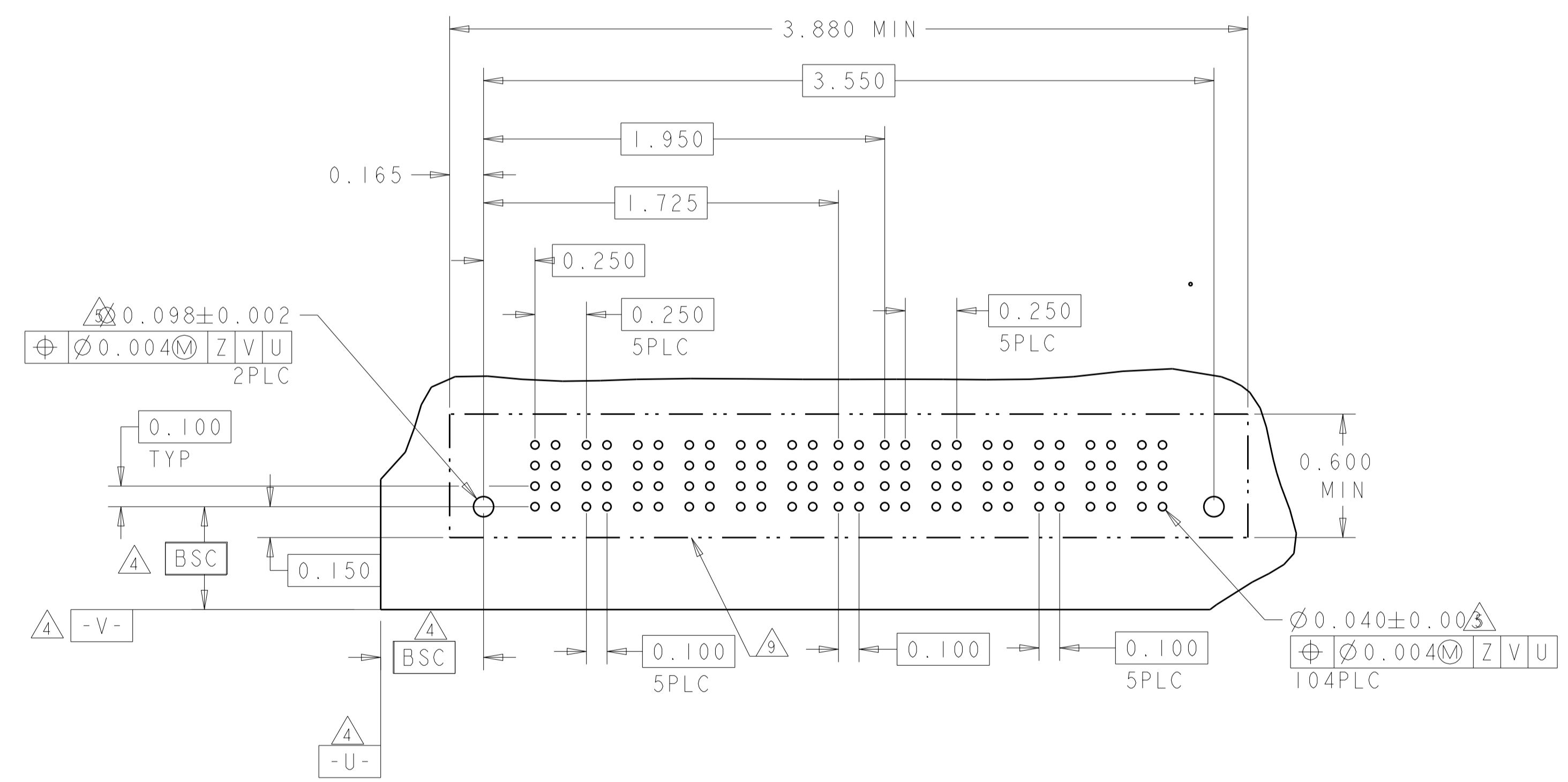

THIS DRAWING IS A CONTROLLED DOCUMENT.

DIMENSIONS:	TOLERANCES UNLESS OTHERWISE SPECIFIED:	OWN	J. McCLINTON	23MAR2005
INCH	0 PLC ±.01	CHK	D. TROUT	23MAR2005
	1 PLC ±.01	APPD	P. WHYNE	23MAR2005
	2 PLC ±.01	PRODUCT SPEC		
	3 PLC ±.005	APPLICATION SPEC		
	4 PLC ±.0020	SIZE	114-13038	
	ANGLES ±.2°	WEIGHT		
MATERIAL	FINISH	Customer Drawing		

NAME: VERTICAL HEADER ASSEMBLY, W/GUIDES, PRESS FIT, TYPE PSP MULTI-BEAM XL

SIZE: A1 00779 C=6600333

SCALE: 3:1 SHEET 15 OF 22 REV P7

LOC	DIST	REV	DATE	BY	APPD
ES	00				
REVISIONS			DESCRIPTION	DATE	BY
			SEE SHEET 1		

PART NUMBER	ROWS	POWER		SIGNAL			POWER	
		P1	P2	1	2	3	P3	P4
4-6600330-1	D	VM	VM	EV	EV	EV	VM	VM
	C			EV	EV	EV		
	B			EV	EV	EV		
	A			EV	EV	EV		
2P + 12S + 2P								

PART NUMBER	ROWS	POWER		SIGNAL			POWER	
		P1	P2	1	2	3	P3	P4
4-6600333-9	D	VM	VM	ES	EV	EV	VM	VM
	C			EV	EV	EV		
	B			EV	EV	EV		
	A			EV	EV	EV		
IP+12S+IP								

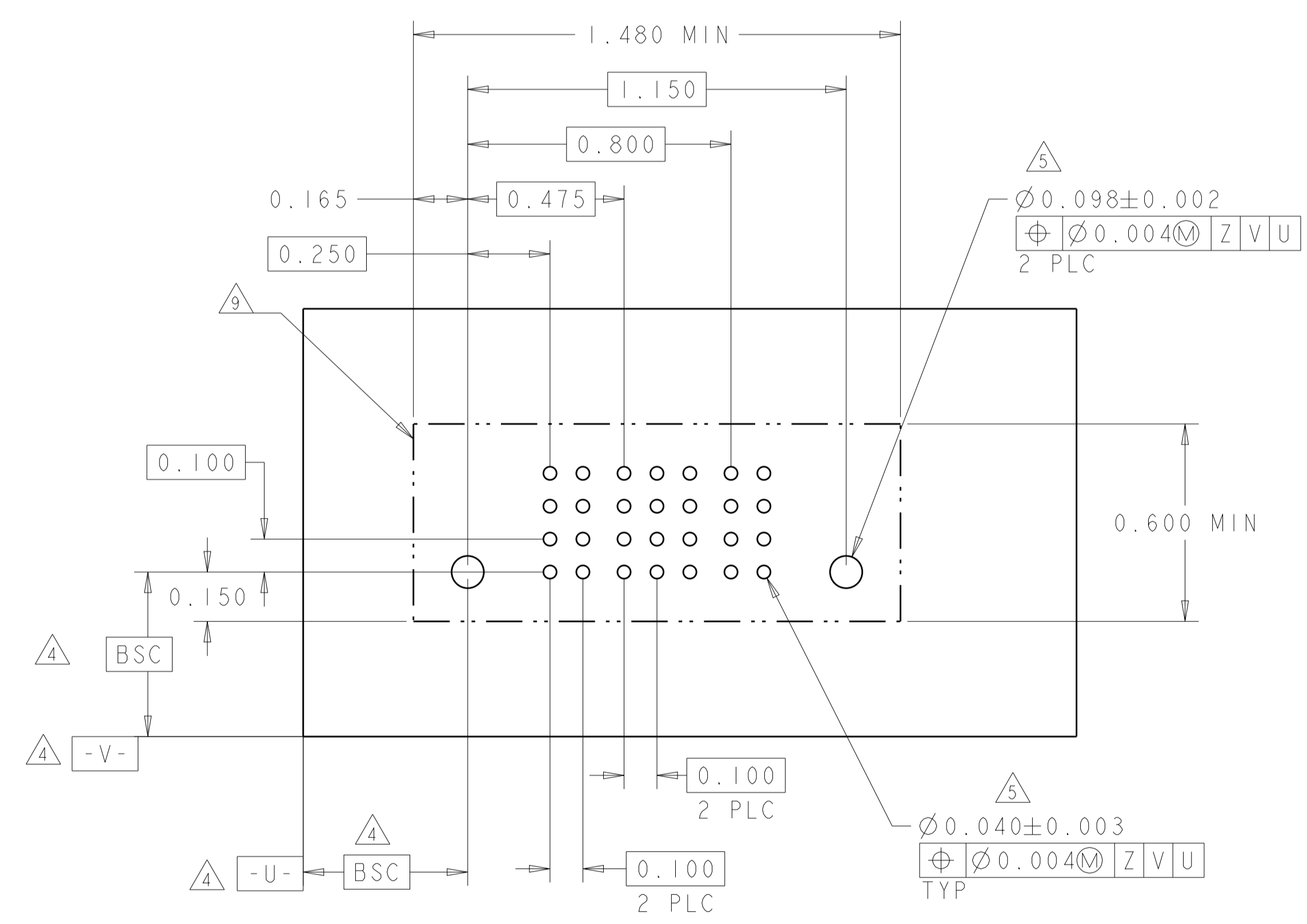
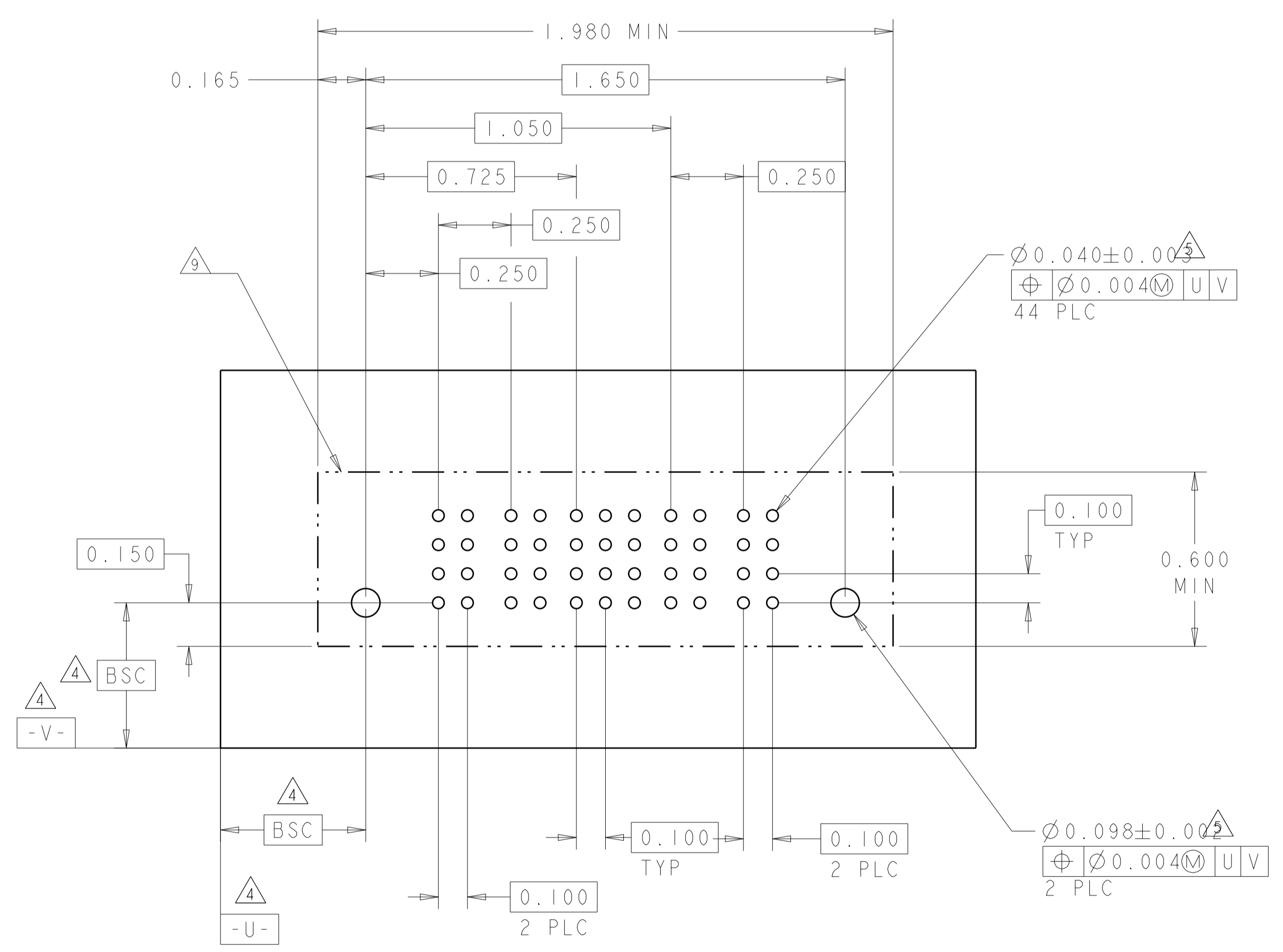

THIS DRAWING IS A CONTROLLED DOCUMENT.

DIMENSIONS: INCH

TOLERANCES UNLESS OTHERWISE SPECIFIED:

0 PLC	±
1 PLC	±.01
2 PLC	±.005
3 PLC	±.002
4 PLC	±.002
ANGLES	±.020
FINISH	±.020

MATERIAL: -

FINISH: -

Customer Drawing

SCALE: 3:1

SHEET 16 OF 22

REV P7

DATE: 23MAR2005

CHK: J. McCLINTON

APPD: D. TROUT

BY: B. MHYNE

PRODUCT SPEC: 108-1973

APPLICATION SPEC: 114-13038

WEIGHT: -

SIZE: A100779



CAGE CODE: C=6600333

RESTRICTED TO: -

NAME: VERTICAL HEADER ASSEMBLY, W/GUIDES, PRESS FIT, TYPE PSP MULTI-BEAM XL

TE Connectivity

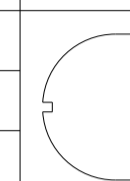
LOC	DIST	REVISIONS			
P	LTN	DESCRIPTION	DATE	DMN	APVD
ES	00	SEE SHEET 1	-	-	-

PART NUMBER	ROWS	POWER								SIGNAL				POWER								HD	
		P1	P2	P3	P4	P5	P6	P7	P8	1	2	3	4	P9	P10	P11	P12	P13	P14	P15	P16		
4-6600333-2	D		VM	VM	VM	VM	VM	VM	VM	VM	EV	EV	EV	EV	VM	VM	VM	VM	VM	VM	VM	VM	
	EV										EV	EV	EV										
	EV										EV	EV	EV										
	EV										EV	EV	EV										
8P+16S+8P	HD																					HD	

(N)

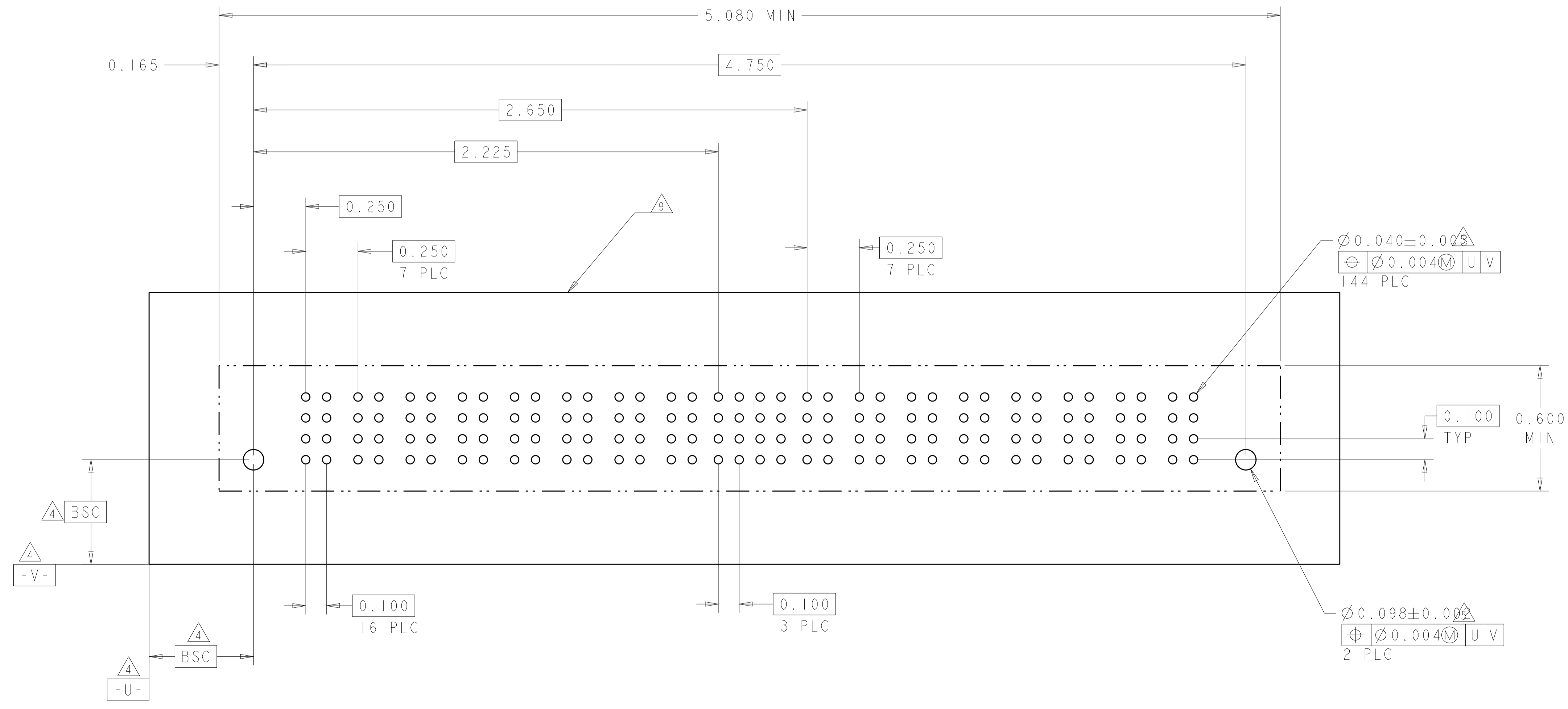

THIS DRAWING IS A CONTROLLED DOCUMENT.

DIMENSIONS: INCH	TOLERANCES UNLESS OTHERWISE SPECIFIED: 0 PLC ±. 1 PLC ±.01 2 PLC ±.01 3 PLC ±.005 4 PLC ±.0020 ANGLES ±.2°	DMN J. McCLINTON 23MAR2005	CHK D. TROUT 23MAR2005	APVD B. WHYNE 23MAR2005	NAME VERTICAL HEADER ASSEMBLY, W/GUIDES, PRESS FIT, TYPE PSP MULTI-BEAM XL
MATERIAL	FINISH	PRODUCT SPEC 108-1973	APPLICATION SPEC 114-13038	WEIGHT	SIZE A100779
Customer Drawing		SCALE 3:1		SHEET 17 OF 22	

4805 (3/11)

LOC	DIST	REVISIONS			
P	LTN	DESCRIPTION	DATE	DMN	APVD
ES	00	SEE SHEET 1	-	-	-

(N2)

PART NUMBER	ROWS	POWER		SIGNAL						POWER	
		P1	P2	1	2	3	4	5	6	P3	P4
4-6600333-4	D	VM	VM	EV	EV	EV	EV	EV	EV	VM	VM
	C			EV	EV	EV	EV	EV			
	B			EV	EV	EV	EV	EV			
	A			ES	ES	ES	ES	ES			
2P+24S+2P											

(N3)

PART NUMBER	ROWS	POWER				SIGNAL			POWER			
		P1	P2	P3	P4	1	2	3	P5	P6	P7	P8
4-6600333-6	D	VM	VM	VM	VM	EV	EV	EV	VM	VM	VM	VM
	C					EV	EV	EV				
	B					EV	EV	EV				
	A					EV	EV	EV				
4P + 12S + 4P												

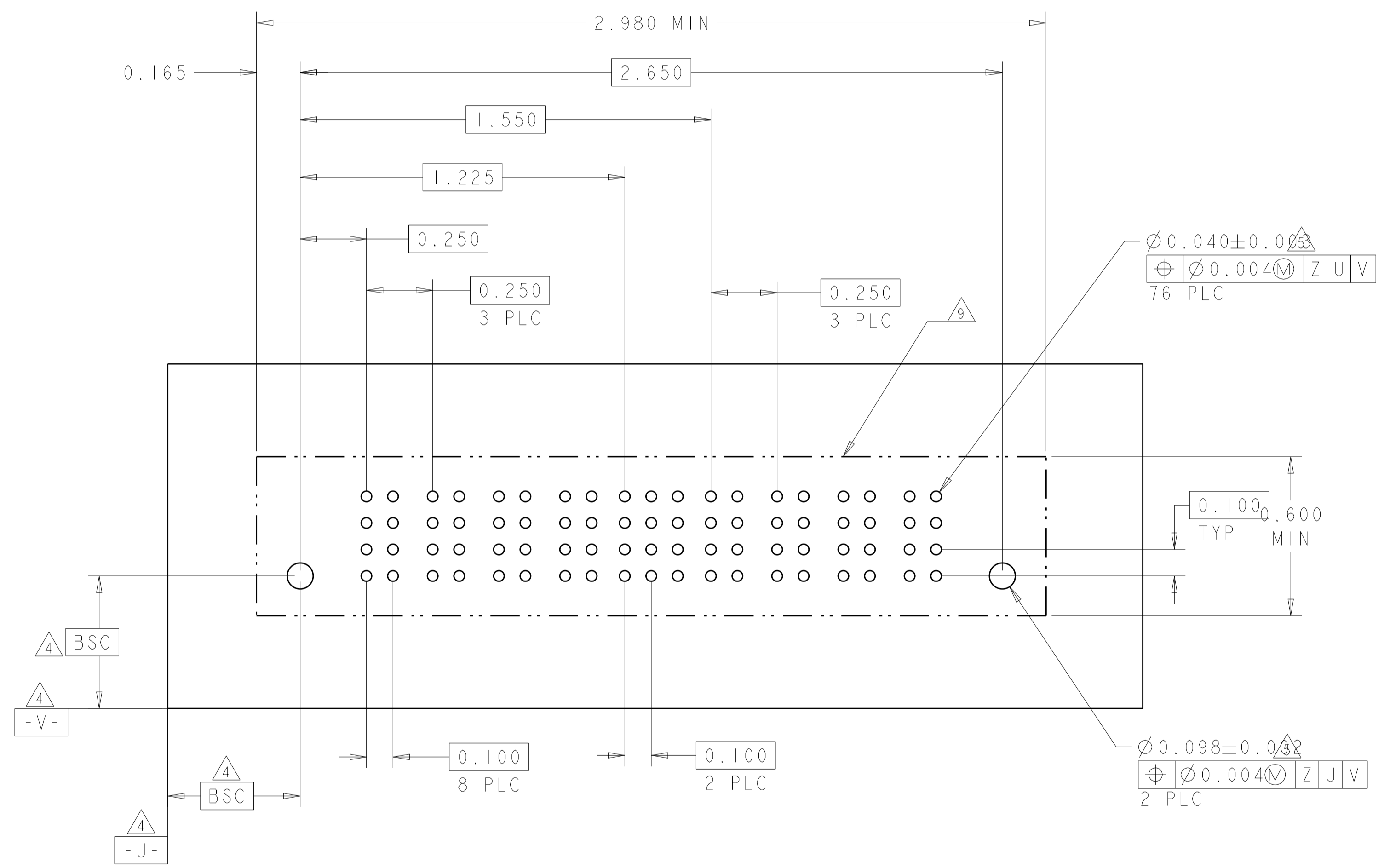
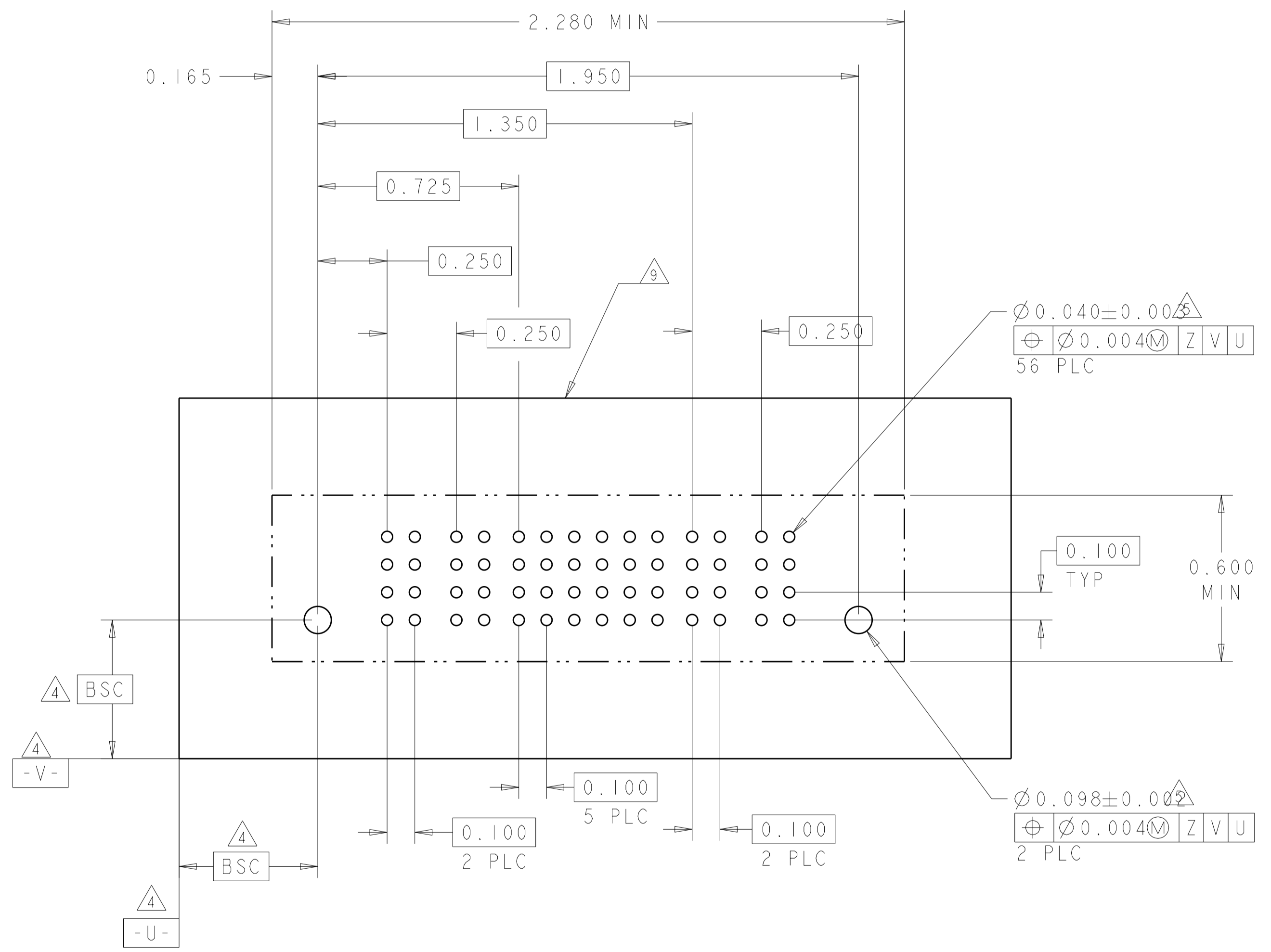

THIS DRAWING IS A CONTROLLED DOCUMENT.

DIMENSIONS:	TOLERANCES UNLESS OTHERWISE SPECIFIED:	DMN	J. McCLINTON	23MAR2005	TE Connectivity
INCH	0 PLC ±.01 1 PLC ±.01 2 PLC ±.01 3 PLC ±.005 4 PLC ±.0020 ANGLES ±.7°	CHK	D. TROUT	23MAR2005	
MATERIAL	FINISH	APVD	P. WYNE	23MAR2005	NAME
		PRODUCT SPEC			VERTICAL HEADER ASSEMBLY, W/GUIDES, PRESS FIT, TYPE PSP
		APPLICATION SPEC			MULTI-BEAM XL
		SIZE	114-13038		RESTRICTED TO
		WEIGHT			A100779
		Customer Drawing			SCALE 3:1 SHEET 18 OF 22 REV P7

LOC	DIST	REV	DATE	BY	APPD
ES	00				
REVISIONS					
DESCRIPTION			DATE	BY	APPD
SEE SHEET 1					

PART NUMBER	ROWS	POWER		SIGNAL						POWER	
		P1	P2	1	2	3	4	5	6	P3	P4
4-6600333-3	D	VM	VM	ES	EV	EV	EV	EV	EV	VM	VM
	C			EV	EV	EV	EV	EV			
	B			EV	EV	EV	EV	EV			
	A			EV	EV	EV	EV	EV			
2ACP+24S+2ACP	HD										

PART NUMBER	ROWS	POWER		SIGNAL						POWER	
		P1	P2	1	2	3	4	5	6	P3	P4
4-6600333-5	D	VM	VM	EV	EV	EV	EV	EV	EV	VM	VM
	C			EV	EV	EV	EV	EV			
	B			EV	EV	ES	EV	EV	EV		
	A			ES	EV	EV	EV	EV	EV		
2ACP+24S+2ACP	HD										

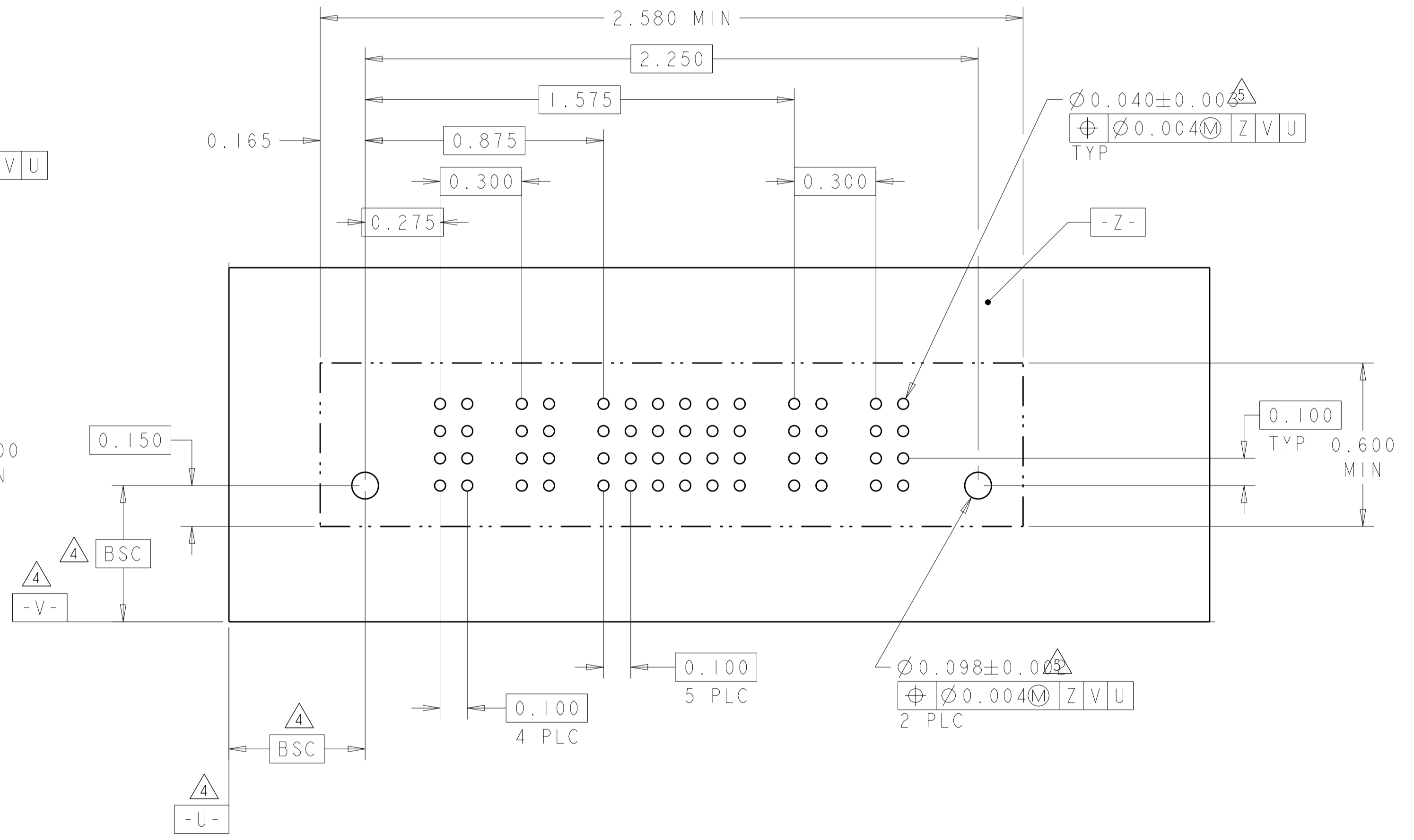
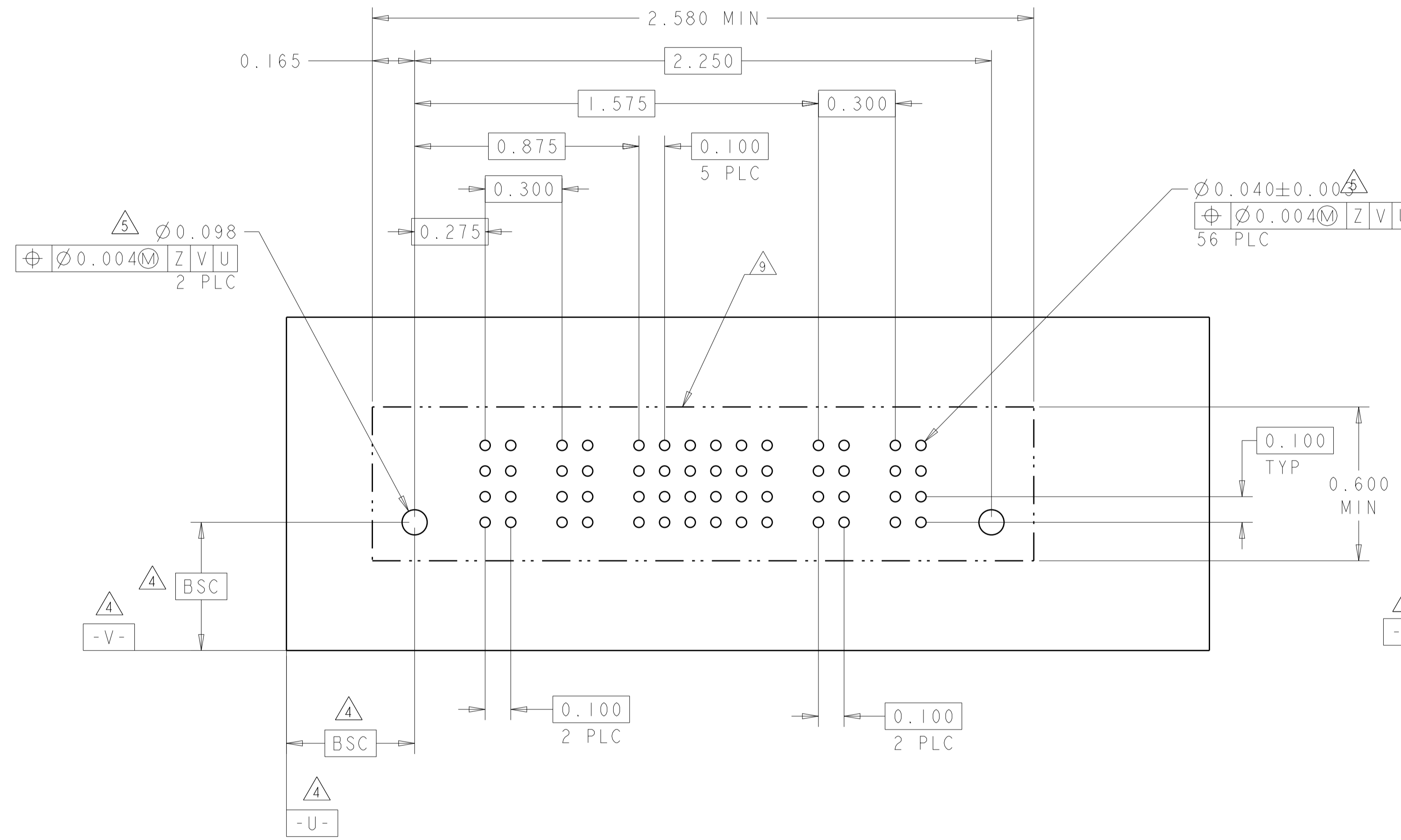

THIS DRAWING IS A CONTROLLED DOCUMENT.

DIMENSIONS:	TOLERANCES UNLESS OTHERWISE SPECIFIED:	OWN	J. McCLINTON	23MAR2005
INCH	0 PLC ±	CHK	D. TROUT	23MAR2005
	1 PLC ±.01	APPD	P. WHYNE	23MAR2005
	2 PLC ±.01	PRODUCT SPEC		
	3 PLC ±.005	APPLICATION SPEC		
	4 PLC ±.0020	SIZE	114-13038	
	ANGLES ±.2°	WEIGHT		
MATERIAL	FINISH	Customer Drawing		

NAME: VERTICAL HEADER ASSEMBLY, W/GUIDES, PRESS FIT, TYPE PSP MULTI-BEAM XL

SIZE: A100779 C=6600333

SCALE: 3:1 SHEET 19 OF 22 REV P7

LOC	DIST	REVISIONS			
P	LTN	DESCRIPTION	DATE	DMN	APVD
-	-	SEE SHEET 1	-	-	-

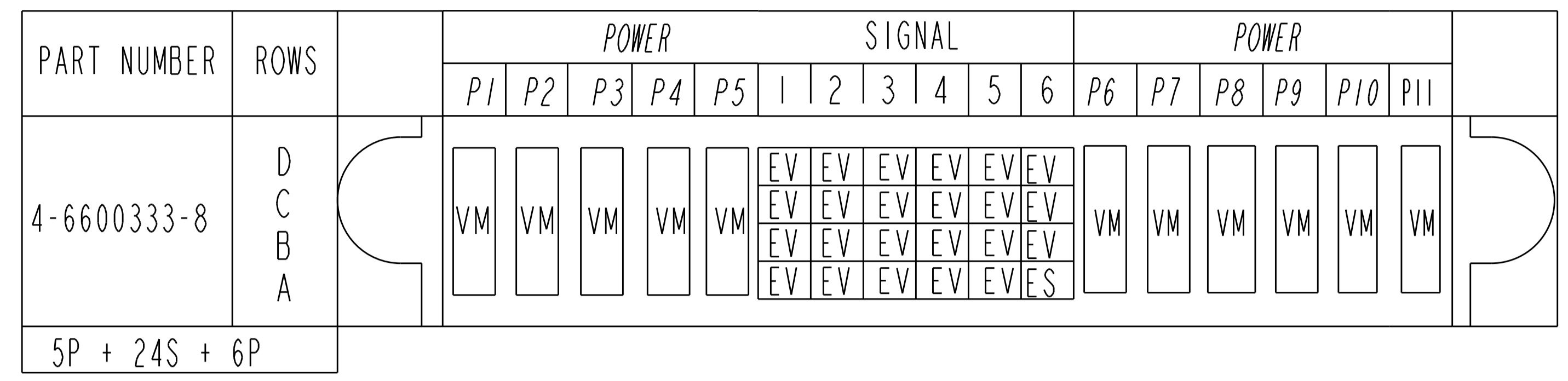

(N7)

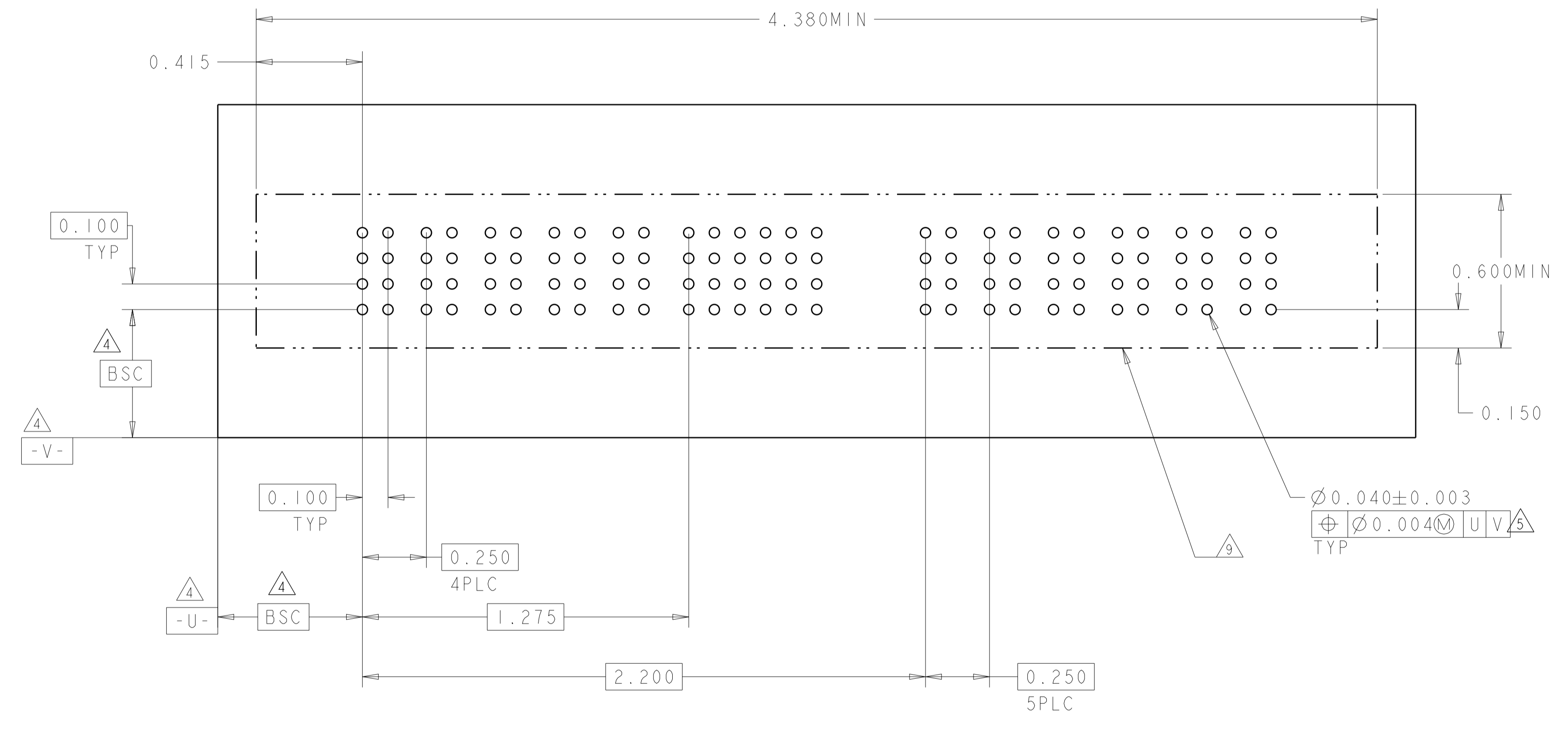

(N6)

RECOMMENDED PCB LAYOUT 4-6600333-8

THIS DRAWING IS A CONTROLLED DOCUMENT.		DMN J. McCLINTON 23MAR2005	 TE Connectivity
DIMENSIONS: INCH		CHK D. TROUT 23MAR2005	
		APVD B. WHYNE 23MAR2005	NAME VERTICAL HEADER ASSEMBLY, W/GUIDES, PRESS FIT, TYPE PSP MULTI-BEAM XL
TOLERANCES UNLESS OTHERWISE SPECIFIED:		PRODUCT SPEC	SIZE A100779
0 PLC ±	1 PLC ±.01	APPLICATION SPEC	CAGE CODE C=6600333
2 PLC ±.01	3 PLC ±.005	114-13038	RESTRICTED TO
4 PLC ±.0020	ANGLES ±7°	WEIGHT	SCALE 3:1
MATERIAL	FINISH	Customer Drawing	SHEET 20 OF 22
		REV P7	

LOC		DIST		REVISONS		
ES	00					

PART NUMBER	ROWS	POWER		SIGNAL						POWER			
		P1	P2	1	2	3	4	5	6	P3	P4	P5	P6
5-6600333-0	D C B A	VM	VM	EV	EV	EV	EV	EV	EV	VM	VM	VM	VM
				EV	EV	EV	EV	EV	EV				
				EV	EV	EV	EV	EV	EV				
				EV	EV	EV	EV	EV	EV				
2P + 24S + 4P													

PART NUMBER	ROWS	POWER						SIGNAL												POWER															
		P1	P2	P3	P4	P5	P6	1	2	3	4	5	6	7	8	9	10	11	12	P7	P8	P9	P10	P11											
5-6600333-1	D C B A	VM	VM	VM	VM	VM	VM	ES	ES	ES	ES	ES	ES	ES	ES	ES	ES	ES	ES	ES	ES	ES	ES	ES	ES	ES	EV	VM	VM	VM	VM	VM			
								ES	ES	ES	ES	ES	ES	ES	ES	ES	ES	ES	ES	ES	ES	ES	ES	ES	ES	ES	ES						ES	ES	EV
								ES	ES	ES	ES	ES	ES	ES	ES	ES	ES	ES	ES	ES	ES	ES	ES	ES	ES	ES	ES						ES	ES	EV
								ES	ES	ES	ES	ES	ES	ES	ES	ES	ES	ES	ES	ES	ES	ES	ES	ES	ES	ES	ES						ES	ES	EV
6P + 48S + 5P																																			

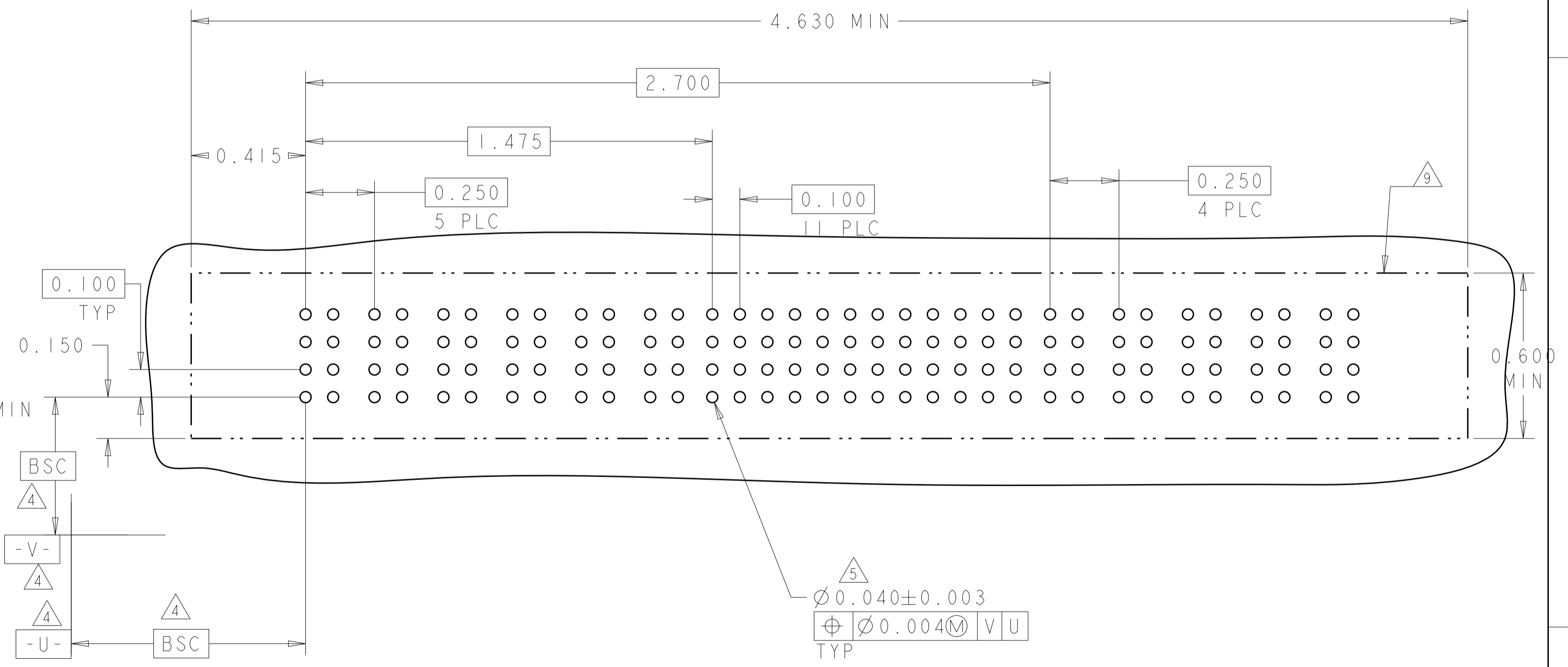
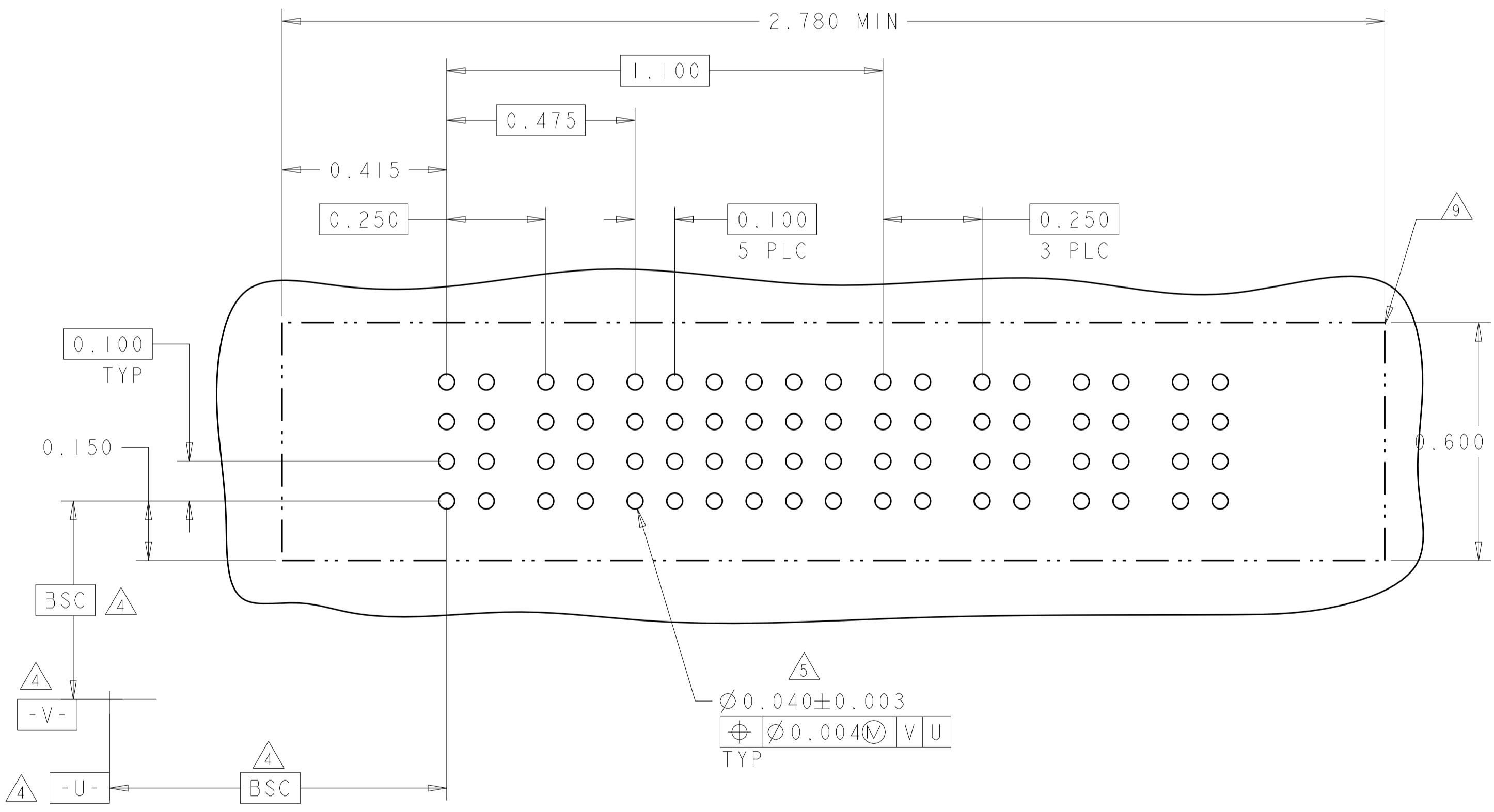

THIS DRAWING IS A CONTROLLED DOCUMENT.		OWN: J. McCLINTON 23MAR2005	STE		TE Connectivity		
DIMENSIONS: INCH		CHK: D. TROUT 23MAR2005	NAME: VERTICAL HEADER ASSEMBLY, W/GUIDES, PRESS FIT, TYPE PSP MULTI-BEAM XL		RESTRICTED TO		
TOLERANCES UNLESS OTHERWISE SPECIFIED:		APVD: B. WHYNE 23MAR2005	SIZE: A1		CAGE CODE: 6600333		
0 PLC ±	1 PLC ±.01	PRODUCT SPEC: 108-1973	SCALE: 3:1		SHEET 21 OF 22		
2 PLC ±.005	3 PLC ±.002	APPLICATION SPEC: 114-13038	REV: P7		DATE: 23MAR2005		
4 PLC ±.0020	ANGLES ±.002	WEIGHT: -	REV: P7		DATE: 23MAR2005		
FINISH: -		Customer Drawing		REV: P7		DATE: 23MAR2005	

LOC	DIST	REVISIONS					
		P	LTN	DESCRIPTION	DATE	DWN	APVD
ES	00	-	-	SEE SHEET 1	-	-	-

PART NUMBER	ROWS	POWER		SIGNAL												POWER			
		P1	P2	1	2	3	4	5	6	7	8	9	10	11	12	P3	P4		
5-6600333-2	D	VM	VM	EV	EV	EV	EV	EV	EV	EV	EV	EV	EV	EV	EV	EV	EV	EV	
	C			EV	EV	EV	EV	EV	EV	EV	EV	EV	EV	EV	EV	EV	EV	EV	
	B			EV	EV	EV	EV	EV	EV	EV	EV	EV	EV	EV	EV	EV	EV	EV	EV
	A			ES	ES	ES	ES	ES	ES	EV	EV	EV	EV	EV	EV	EV	EV	EV	EV
2P+48S+2P																			

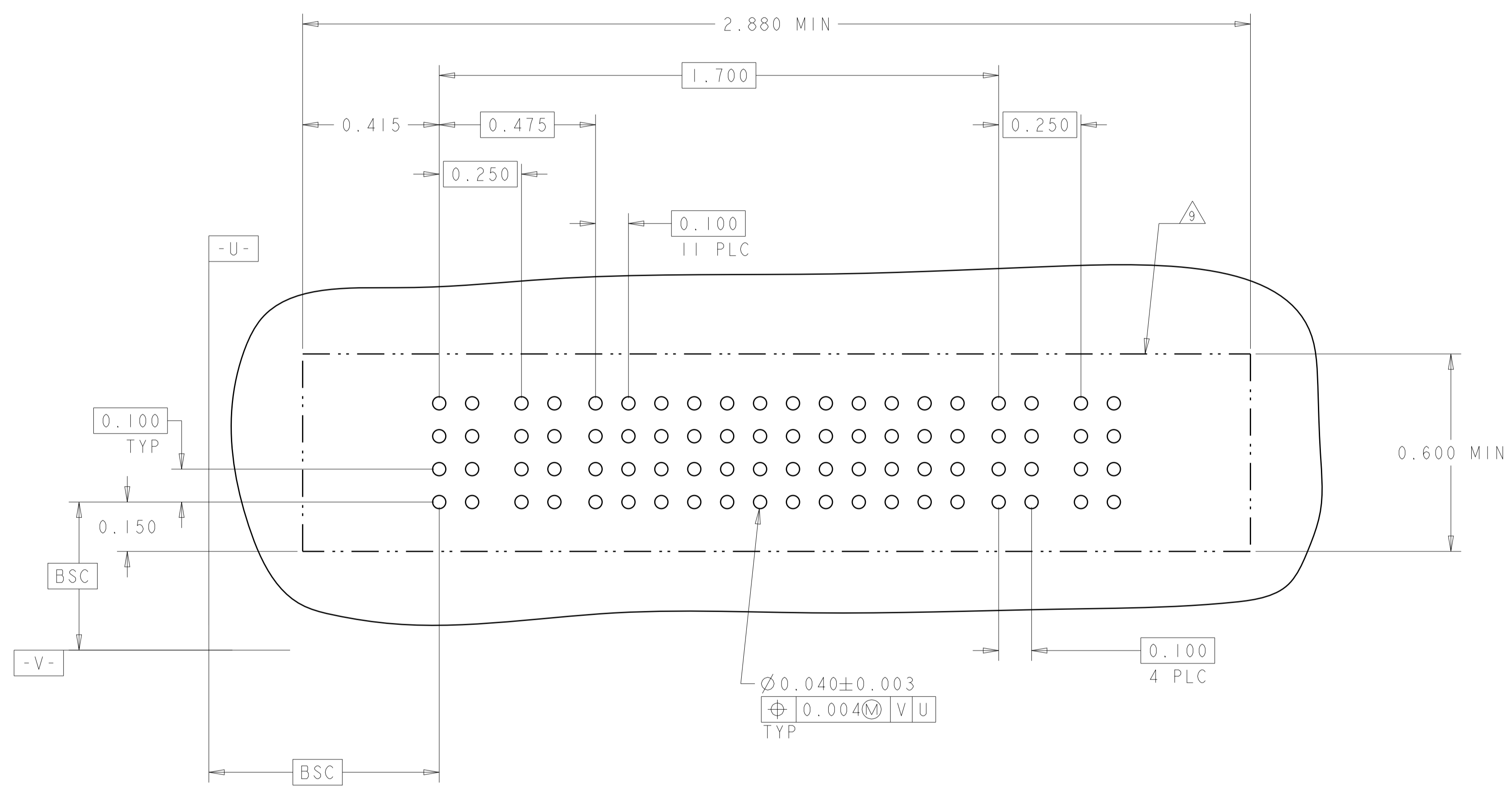

THIS DRAWING IS A CONTROLLED DOCUMENT.		DWN J. McCLINTON 23MAR2005	TE Connectivity
DIMENSIONS: INCH		CHK D. TROUT 23MAR2005	
TOLERANCES UNLESS OTHERWISE SPECIFIED:		APVD B. WHYNE 23MAR2005	NAME VERTICAL HEADER ASSEMBLY, W/GUIDES, PRESS FIT, TYPE PSP MULTI-BEAM XL
0 PLC ± 2 PLC ±.01 3 PLC ±.005 4 PLC ±.0020 ANGLES ±.2°		PRODUCT SPEC 108-1973	SIZE 114-13038
MATERIAL		APPLICATION SPEC	RESTRICTED TO
FINISH		WEIGHT	SCALE 3:1 SHEET 22 OF 22 REV P7
Customer Drawing		SIZE CAGE CODE DRAWING NO A100779C=6600333	



Компания «ЭлектроПласт» предлагает заключение долгосрочных отношений при поставках импортных электронных компонентов на взаимовыгодных условиях!

Наши преимущества:

- Оперативные поставки широкого спектра электронных компонентов отечественного и импортного производства напрямую от производителей и с крупнейших мировых складов;
- Поставка более 17-ти миллионов наименований электронных компонентов;
- Поставка сложных, дефицитных, либо снятых с производства позиций;
- Оперативные сроки поставки под заказ (от 5 рабочих дней);
- Экспресс доставка в любую точку России;
- Техническая поддержка проекта, помощь в подборе аналогов, поставка прототипов;
- Система менеджмента качества сертифицирована по Международному стандарту ISO 9001;
- Лицензия ФСБ на осуществление работ с использованием сведений, составляющих государственную тайну;
- Поставка специализированных компонентов (Xilinx, Altera, Analog Devices, Intersil, Interpoint, Microsemi, Aeroflex, Peregrine, Syfer, Eurofarad, Texas Instrument, Miteq, Cobham, E2V, MA-COM, Hittite, Mini-Circuits, General Dynamics и др.);

Помимо этого, одним из направлений компании «ЭлектроПласт» является направление «Источники питания». Мы предлагаем Вам помощь Конструкторского отдела:

- Подбор оптимального решения, техническое обоснование при выборе компонента;
- Подбор аналогов;
- Консультации по применению компонента;
- Поставка образцов и прототипов;
- Техническая поддержка проекта;
- Защита от снятия компонента с производства.



Как с нами связаться

Телефон: 8 (812) 309 58 32 (многоканальный)

Факс: 8 (812) 320-02-42

Электронная почта: org@eplast1.ru

Адрес: 198099, г. Санкт-Петербург, ул. Калинина, дом 2, корпус 4, литера А.