

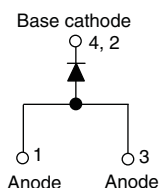

Ultrafast Rectifier, 30 A FRED Pt®



TO-247AC



VS-APU3006-F3
VS-APU3006-N3



TO-247AC modified

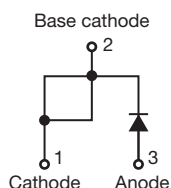

VS-EPU3006-F3
VS-EPU3006-N3

FEATURES

- Low forward voltage drop
- Ultrafast recovery time
- 175 °C operating junction temperature
- Designed and qualified according to JEDEC-JESD47
- Material categorization:
For definitions of compliance please see www.vishay.com/doc?99912



RoHS
COMPLIANT
HALOGEN
FREE
Available

DESCRIPTION/APPLICATIONS

Ultralow V_F , soft-switching ultrafast rectifiers optimized for Discontinuous (Critical) Mode (DCM) Power Factor Correction (PFC).

The minimized conduction loss, optimized stored charge and low recovery current minimized the switching losses and reduce over dissipation in the switching element and snubbers.

The device is also intended for use as a freewheeling diode in power supplies and other power switching applications.

APPLICATIONS

AC/DC SMPS 70 W to 400 W
e.g. laptop and printer AC adaptors, desktop PC, TV and monitor, games units, and DVD AC/DC power supplies.

PRODUCT SUMMARY

Package	TO-247AC, TO-247AC modified (2 pins)
$I_{F(AV)}$	30 A
V_R	600 V
V_F at I_F	2 V
t_{rr} typ.	30 ns
T_J max.	175 °C
Diode variation	Single die

ABSOLUTE MAXIMUM RATINGS

PARAMETER	SYMBOL	TEST CONDITIONS	MAX.	UNITS
Repetitive peak reverse voltage	V_{RRM}		600	V
Average rectified forward current	$I_{F(AV)}$	$T_C = 127\text{ °C}$	30	A
Non-repetitive peak surge current	I_{FSM}	$T_C = 25\text{ °C}$	220	
Operating junction and storage temperatures	T_J, T_{Stg}		- 65 to 175	°C

ELECTRICAL SPECIFICATIONS ($T_J = 25\text{ °C}$ unless otherwise specified)

PARAMETER	SYMBOL	TEST CONDITIONS	MIN.	TYP.	MAX.	UNITS
Breakdown voltage, blocking voltage	V_{BR}, V_R	$I_R = 100\text{ }\mu\text{A}$	600	-	-	V
Forward voltage	V_F	$I_F = 30\text{ A}$ $I_F = 30\text{ A}, T_J = 150\text{ °C}$	-	1.4 1.15	2 1.35	
Reverse leakage current	I_R	$V_R = V_R$ rated $T_J = 150\text{ °C}, V_R = V_R$ rated	-	-	30 250	μA
Junction capacitance	C_T	$V_R = 600\text{ V}$	-	20	-	pF
Series inductance	L_S	Measured lead to lead 5 mm from package body	-	8.0	-	nH



DYNAMIC RECOVERY CHARACTERISTICS ($T_J = 25\text{ }^\circ\text{C}$ unless otherwise specified)						
PARAMETER	SYMBOL	TEST CONDITIONS	MIN.	TYP.	MAX.	UNITS
Reverse recovery time	t_{rr}	$I_F = 1\text{ A}$, $di_F/dt = 50\text{ A}/\mu\text{s}$, $V_R = 30\text{ V}$	-	30	45	ns
		$T_J = 25\text{ }^\circ\text{C}$	-	45	-	
		$T_J = 125\text{ }^\circ\text{C}$	-	100	-	
Peak recovery current	I_{RRM}	$T_J = 25\text{ }^\circ\text{C}$	-	5.6	-	A
		$T_J = 125\text{ }^\circ\text{C}$	-	10	-	
Reverse recovery charge	Q_{rr}	$T_J = 25\text{ }^\circ\text{C}$	-	127	-	nC
		$T_J = 125\text{ }^\circ\text{C}$	-	580	-	

THERMAL - MECHANICAL SPECIFICATIONS						
PARAMETER	SYMBOL	TEST CONDITIONS	MIN.	TYP.	MAX.	UNITS
Maximum junction and storage temperature range	T_J, T_{Stg}		- 65	-	175	$^\circ\text{C}$
Thermal resistance, junction to case	R_{thJC}		-	0.7	1.1	$^\circ\text{C}/\text{W}$
Thermal resistance, junction to ambient per leg	R_{thJA}	Typical socket mount	-	-	70	
Thermal resistance, case to heatsink	R_{thCS}	Mounting surface, flat, smooth and greased	-	0.5	-	
Weight			-	2.0	-	g
			-	0.07	-	oz.
Mounting torque			1.2 (10)	-	2.4 (20)	kgf · cm (lbf · in)
Marking device		Case style TO-247AC	APU3006			
		Case style TO-247AC modified	EPU3006			

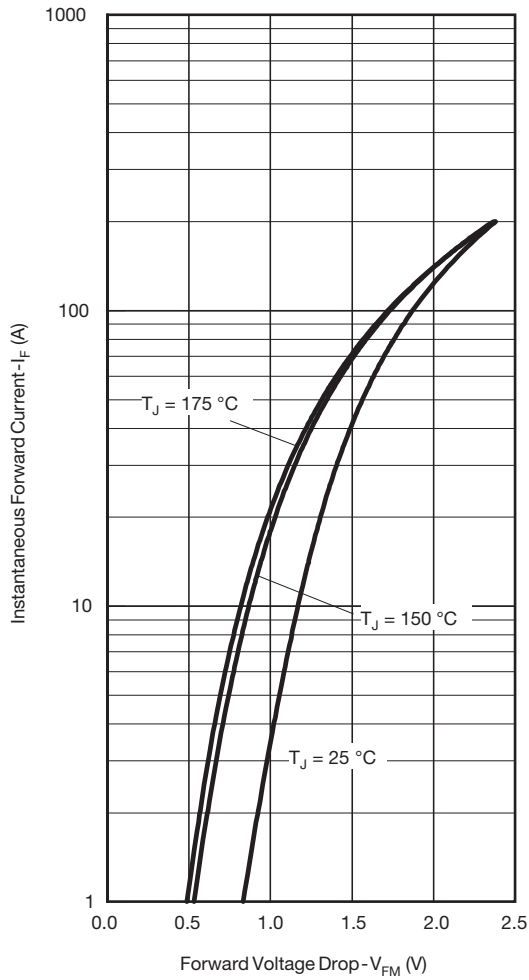

Fig. 1 - Typical Forward Voltage Drop Characteristics

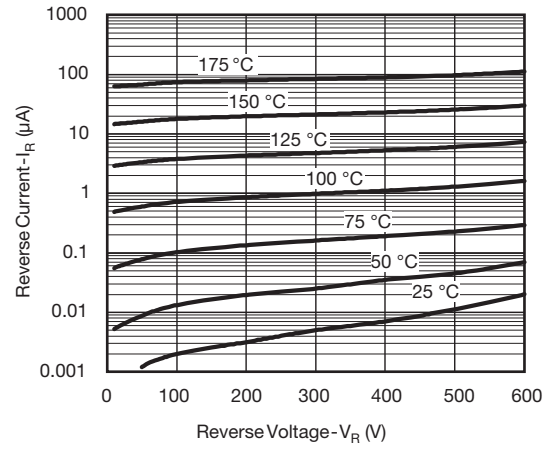

Fig. 2 - Typical Values of Reverse Current vs. Reverse Voltage

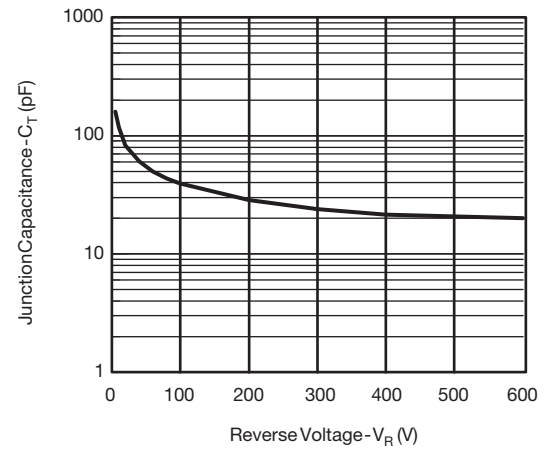

Fig. 3 - Typical Junction Capacitance vs. Reverse Voltage

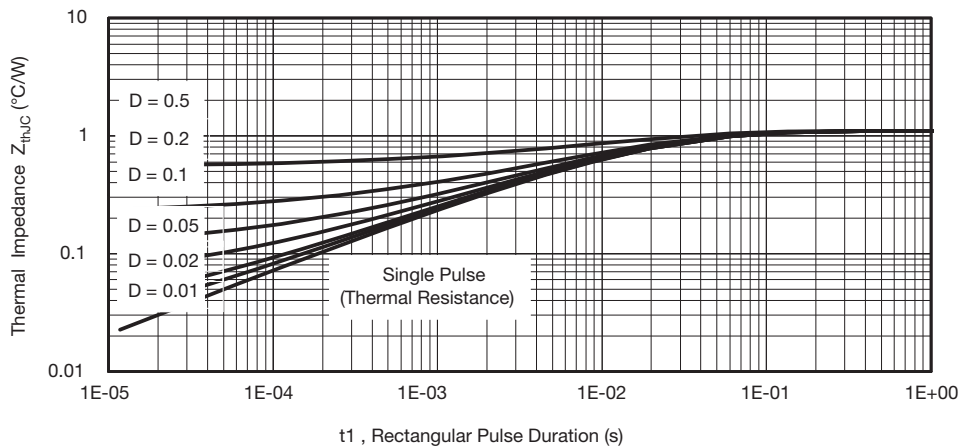

Fig. 4 - Max. Thermal Impedance Z_{thJC} Characteristics

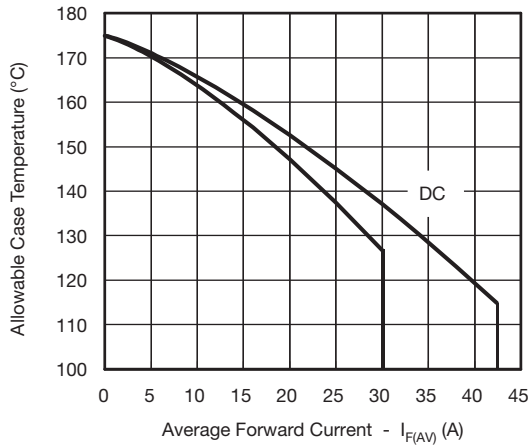

Fig. 5 - Maximum Allowable Case Temperature vs. Average Forward Current

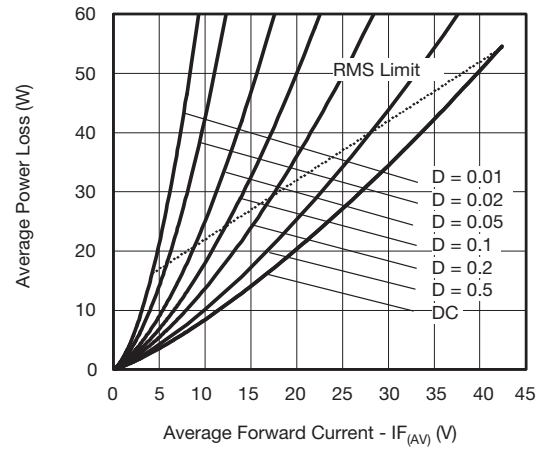

Fig. 6 - Forward Power Loss Characteristics

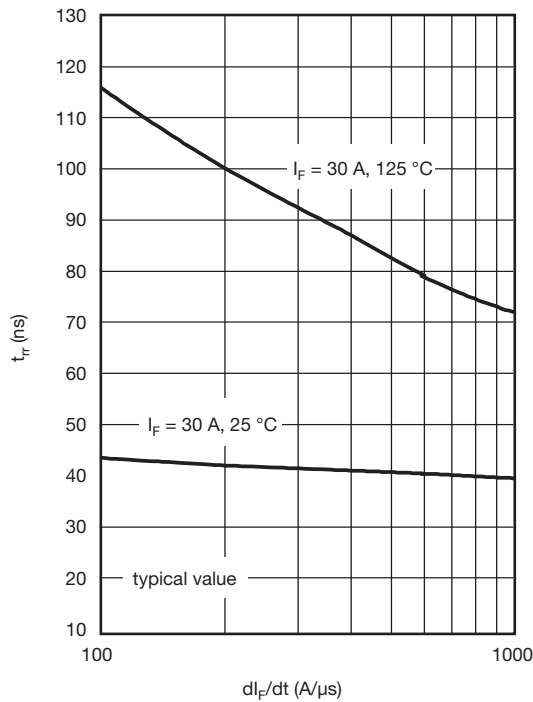

Fig. 7 - Typical Reverse Recovery Time vs. dI_F/dt

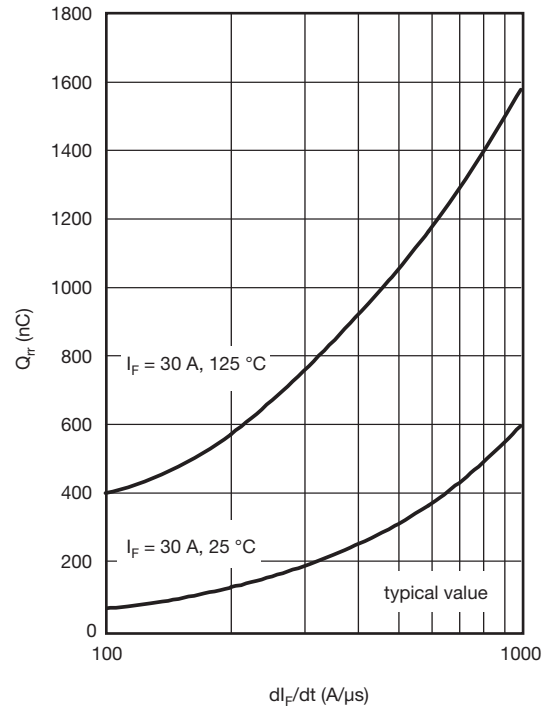

Fig. 8 - Typical Stored Charge vs. dI_F/dt

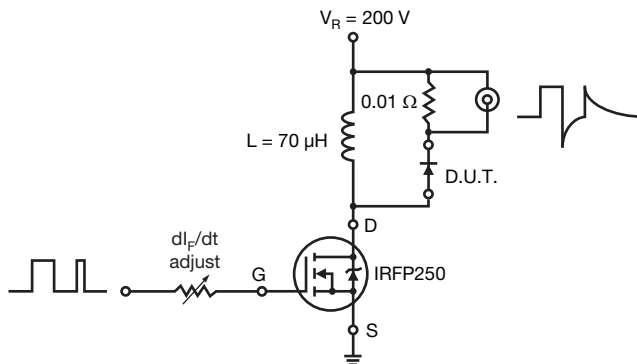
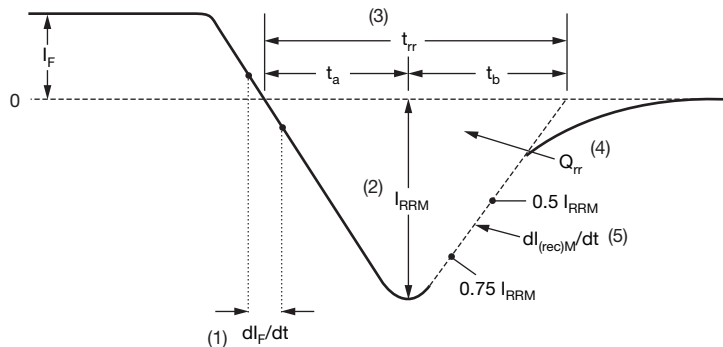

Fig. 9 - Reverse Recovery Parameter Test Circuit



- (1) dI_F/dt - rate of change of current through zero crossing
- (2) I_{RRM} - peak reverse recovery current
- (3) t_{rr} - reverse recovery time measured from zero crossing point of negative going I_F to point where a line passing through $0.75 I_{RRM}$ and $0.50 I_{RRM}$ extrapolated to zero current.
- (4) Q_{rr} - area under curve defined by t_{rr} and I_{RRM}
- (5) $dI_{(rec)M}/dt$ - peak rate of change of current during t_b portion of t_{rr}

$$Q_{rr} = \frac{t_{rr} \times I_{RRM}}{2}$$

Fig. 10 - Reverse Recovery Waveform and Definitions



ORDERING INFORMATION TABLE

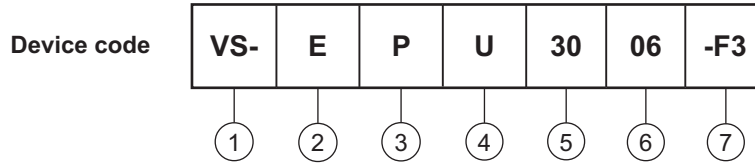

- 1** - Vishay Semiconductors product
- 2** - Ultrafast MUR series
 - A = Single diode
 - E = Single diode (modified)
- 3** - P = TO-247AC
- 4** - U = Ultrafast recovery time
- 5** - Current code (30 = 30 A)
- 6** - Voltage code (06 = 600 V)
- 7** - Environmental digit:
 - F3 = RoHS compliant and totally lead (Pb)-free
 - N3 = Halogen-free, RoHS compliant and totally lead (Pb)-free

ORDERING INFORMATION (Example)			
PREFERRED P/N	QUANTITY PER TUBE	MINIMUM ORDER QUANTITY	PACKAGING DESCRIPTION
VS-APU3006-F3	25	500	Antistatic plastic tube
VS-APU3006-N3	25	500	Antistatic plastic tube
VS-EPU3006-F3	25	500	Antistatic plastic tube
VS-EPU3006-N3	25	500	Antistatic plastic tube

LINKS TO RELATED DOCUMENTS		
Dimensions	TO-247AC	www.vishay.com/doc?95223
	TO-247AC modified	www.vishay.com/doc?95253
Part marking information	TO-247AC	www.vishay.com/doc?95007
	TO-247AC modified	www.vishay.com/doc?95442



DIMENSIONS in millimeters and inches



Lead assignments

- Diodes
 1. - Anode/open
 2. - Cathode
 3. - Anode

SYMBOL	MILLIMETERS		INCHES		NOTES	SYMBOL	MILLIMETERS		INCHES		NOTES
	MIN.	MAX.	MIN.	MAX.			MIN.	MAX.	MIN.	MAX.	
A	4.65	5.31	0.183	0.209		D2	0.51	1.30	0.020	0.051	
A1	2.21	2.59	0.087	0.102		E	15.29	15.87	0.602	0.625	3
A2	1.50	2.49	0.059	0.098		E1	13.72	-	0.540	-	
b	0.99	1.40	0.039	0.055		e	5.46 BSC		0.215 BSC		
b1	0.99	1.35	0.039	0.053		FK	2.54		0.010		
b2	1.65	2.39	0.065	0.094		L	14.20	16.10	0.559	0.634	
b3	1.65	2.37	0.065	0.094		L1	3.71	4.29	0.146	0.169	
b4	2.59	3.43	0.102	0.135		N	7.62 BSC		0.3		
b5	2.59	3.38	0.102	0.133		ΦP	3.56	3.66	0.14	0.144	
c	0.38	0.86	0.015	0.034		ΦP1	-	6.98	-	0.275	
c1	0.38	0.76	0.015	0.030		Q	5.31	5.69	0.209	0.224	
D	19.71	20.70	0.776	0.815	3	R	4.52	5.49	1.78	0.216	
D1	13.08	-	0.515	-	4	S	5.51 BSC		0.217 BSC		

Notes

- (1) Dimensioning and tolerancing per ASME Y14.5M-1994
- (2) Contour of slot optional
- (3) Dimension D and E do not include mold flash. Mold flash shall not exceed 0.127 mm (0.005") per side. These dimensions are measured at the outermost extremes of the plastic body
- (4) Thermal pad contour optional with dimensions D1 and E1
- (5) Lead finish uncontrolled in L1
- (6) Ø P to have a maximum draft angle of 1.5 to the top of the part with a maximum hole diameter of 3.91 mm (0.154")
- (7) Outline conforms to JEDEC outline TO-247 with exception of dimension c



DIMENSIONS in millimeters and inches



Lead assignments

- Diodes
 1. - Anode/open
 2. - Cathode
 3. - Anode

SYMBOL	MILLIMETERS		INCHES		NOTES
	MIN.	MAX.	MIN.	MAX.	
A	4.65	5.31	0.183	0.209	
A1	2.21	2.59	0.087	0.102	
A2	1.50	2.49	0.059	0.098	
b	0.99	1.40	0.039	0.055	
b1	0.99	1.35	0.039	0.053	
b2	1.65	2.39	0.065	0.094	
b3	1.65	2.37	0.065	0.094	
b4	2.59	3.43	0.102	0.135	
b5	2.59	3.38	0.102	0.133	
c	0.38	0.86	0.015	0.034	
c1	0.38	0.76	0.015	0.030	
D	19.71	20.70	0.776	0.815	3
D1	13.08	-	0.515	-	4
D2	0.51	1.30	0.020	0.051	
E	15.29	15.87	0.602	0.625	3
E1	13.72	-	0.540	-	
e	5.46 BSC		0.215 BSC		
ΦK	2.54		0.010		
L	14.20	16.10	0.559	0.634	
L1	3.71	4.29	0.146	0.169	
N	7.62 BSC		0.3		
ΦP	3.56	3.66	0.14	0.144	
ΦP1	-	6.98	-	0.275	
Q	5.31	5.69	0.209	0.224	
R	4.52	5.49	1.78	0.216	
S	5.51 BSC		0.217 BSC		

Notes

- (1) Dimensioning and tolerance per ASME Y14.5M-1994
- (2) Contour of slot optional
- (3) Dimension D and E do not include mold flash. Mold flash shall not exceed 0.127 mm (0.005") per side. These dimensions are measured at the outermost extremes of the plastic body
- (4) Thermal pad contour optional with dimensions D1 and E1
- (5) Lead finish uncontrolled in L1
- (6) ΦP to have a maximum draft angle of 1.5 to the top of the part with a maximum hole diameter of 3.91 mm (0.154")
- (7) Outline conforms to JEDEC outline TO-247 with exception of dimension c



TO-247AC modified E

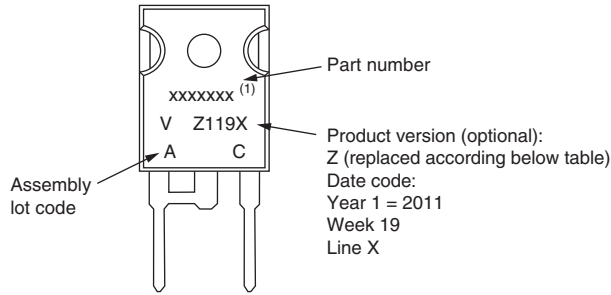

Example: This is a xxxxxxxx ⁽¹⁾ with assembly lot code AC, assembled on WW 19, 2011 in the assembly line "X"

Note

⁽¹⁾ If part number contain "H" as last digit, product is AEC-Q101 qualified

ENVIRONMENTAL NAMING CODE (Z)	PRODUCT DEFINITION
A	Termination lead (Pb)-free
B	Totally lead (Pb)-free
E	RoHS compliant and termination lead (Pb)-free
F	RoHS compliant and totally lead (Pb)-free
M	Halogen-free, RoHS compliant and termination lead (Pb)-free
N	Halogen-free, RoHS compliant and totally lead (Pb)-free
G	Green



Disclaimer

ALL PRODUCT, PRODUCT SPECIFICATIONS AND DATA ARE SUBJECT TO CHANGE WITHOUT NOTICE TO IMPROVE RELIABILITY, FUNCTION OR DESIGN OR OTHERWISE.

Vishay Intertechnology, Inc., its affiliates, agents, and employees, and all persons acting on its or their behalf (collectively, "Vishay"), disclaim any and all liability for any errors, inaccuracies or incompleteness contained in any datasheet or in any other disclosure relating to any product.

Vishay makes no warranty, representation or guarantee regarding the suitability of the products for any particular purpose or the continuing production of any product. To the maximum extent permitted by applicable law, Vishay disclaims (i) any and all liability arising out of the application or use of any product, (ii) any and all liability, including without limitation special, consequential or incidental damages, and (iii) any and all implied warranties, including warranties of fitness for particular purpose, non-infringement and merchantability.

Statements regarding the suitability of products for certain types of applications are based on Vishay's knowledge of typical requirements that are often placed on Vishay products in generic applications. Such statements are not binding statements about the suitability of products for a particular application. It is the customer's responsibility to validate that a particular product with the properties described in the product specification is suitable for use in a particular application. Parameters provided in datasheets and/or specifications may vary in different applications and performance may vary over time. All operating parameters, including typical parameters, must be validated for each customer application by the customer's technical experts. Product specifications do not expand or otherwise modify Vishay's terms and conditions of purchase, including but not limited to the warranty expressed therein.

Except as expressly indicated in writing, Vishay products are not designed for use in medical, life-saving, or life-sustaining applications or for any other application in which the failure of the Vishay product could result in personal injury or death. Customers using or selling Vishay products not expressly indicated for use in such applications do so at their own risk. Please contact authorized Vishay personnel to obtain written terms and conditions regarding products designed for such applications.

No license, express or implied, by estoppel or otherwise, to any intellectual property rights is granted by this document or by any conduct of Vishay. Product names and markings noted herein may be trademarks of their respective owners.

Material Category Policy

Vishay Intertechnology, Inc. hereby certifies that all its products that are identified as RoHS-Compliant fulfill the definitions and restrictions defined under Directive 2011/65/EU of The European Parliament and of the Council of June 8, 2011 on the restriction of the use of certain hazardous substances in electrical and electronic equipment (EEE) - recast, unless otherwise specified as non-compliant.

Please note that some Vishay documentation may still make reference to RoHS Directive 2002/95/EC. We confirm that all the products identified as being compliant to Directive 2002/95/EC conform to Directive 2011/65/EU.

Vishay Intertechnology, Inc. hereby certifies that all its products that are identified as Halogen-Free follow Halogen-Free requirements as per JEDEC JS709A standards. Please note that some Vishay documentation may still make reference to the IEC 61249-2-21 definition. We confirm that all the products identified as being compliant to IEC 61249-2-21 conform to JEDEC JS709A standards.



Компания «ЭлектроПласт» предлагает заключение долгосрочных отношений при поставках импортных электронных компонентов на взаимовыгодных условиях!

Наши преимущества:

- Оперативные поставки широкого спектра электронных компонентов отечественного и импортного производства напрямую от производителей и с крупнейших мировых складов;
- Поставка более 17-ти миллионов наименований электронных компонентов;
- Поставка сложных, дефицитных, либо снятых с производства позиций;
- Оперативные сроки поставки под заказ (от 5 рабочих дней);
- Экспресс доставка в любую точку России;
- Техническая поддержка проекта, помощь в подборе аналогов, поставка прототипов;
- Система менеджмента качества сертифицирована по Международному стандарту ISO 9001;
- Лицензия ФСБ на осуществление работ с использованием сведений, составляющих государственную тайну;
- Поставка специализированных компонентов (Xilinx, Altera, Analog Devices, Intersil, Interpoint, Microsemi, Aeroflex, Peregrine, Syfer, Eurofarad, Texas Instrument, Miteq, Cobham, E2V, MA-COM, Hittite, Mini-Circuits, General Dynamics и др.);

Помимо этого, одним из направлений компании «ЭлектроПласт» является направление «Источники питания». Мы предлагаем Вам помощь Конструкторского отдела:

- Подбор оптимального решения, техническое обоснование при выборе компонента;
- Подбор аналогов;
- Консультации по применению компонента;
- Поставка образцов и прототипов;
- Техническая поддержка проекта;
- Защита от снятия компонента с производства.



Как с нами связаться

Телефон: 8 (812) 309 58 32 (многоканальный)

Факс: 8 (812) 320-02-42

Электронная почта: org@eplast1.ru

Адрес: 198099, г. Санкт-Петербург, ул. Калинина, дом 2, корпус 4, литера А.