

## GNSS LOW NOISE AMPLIFIER

### ■ GENERAL DESCRIPTION

The NJG1155UX2 is a low noise amplifier GaAs MMIC designed for GNSS (Global Navigation Satellite Systems). The NJG1155UX2 is featured low noise figure, and operates from 1.5V to 3.3V single voltage. The NJG1155UX2 has stand-by mode to save the supply current, has the on-chip ESD protection devices.

The NJG1155UX2 achieves ultra small mounting area by only two external components and ultra small package that is lead-free and halogen-free 6-pin EPFFP6-X2 package.

### ■ PACKAGE OUTLINE

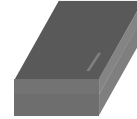

NJG1155UX2

### ■ APPLICATIONS

GNSS applications, like GPS, Galileo, GLONASS and COMPASS.

### ■ FEATURES

- Operating frequencies 1550 to 1615MHz
- Low supply voltage 2.8 / 1.8V typ.
- Low current consumption 3.5 / 3.1mA typ. @ $V_{DD}=2.8 / 1.8V$ ,  $V_{CTL}=1.8V$   
0.1 $\mu$ A typ. @ $V_{DD}=2.8 / 1.8V$ ,  $V_{CTL}=0V$  (Stand-by mode)
- High gain 19.0 / 18.5dB typ. @ $V_{DD}=2.8 / 1.8V$ ,  $V_{CTL}=1.8V$
- Low noise figure 0.75dB typ. @ $V_{DD}=2.8 / 1.8V$ ,  $V_{CTL}=1.8V$
- Ultra small package EPFFP6-X2 (Package size: 1.1mm x 0.7mm x 0.37mm typ.)
- Low external component count 2pcs.
- RoHS compliant and Halogen Free
- MSL1

### ■ PIN CONFIGURATION

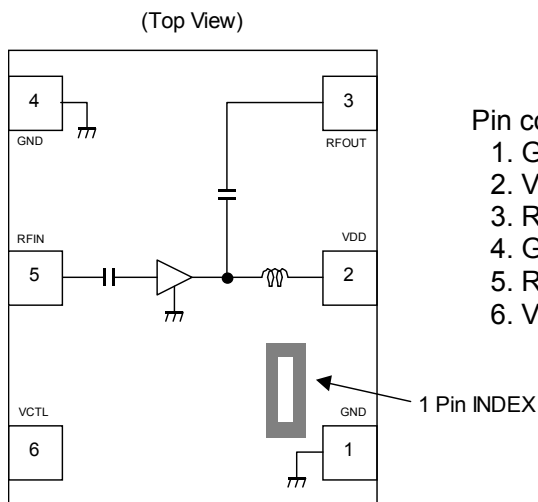

### ■ TRUTH TABLE

$V_{CTL}$	LNA mode
H	Active mode
L	Stand-by mode

“H”= $V_{CTL(H)}$ , “L”= $V_{CTL(L)}$

Note: Specifications and description listed in this datasheet are subject to change without notice.

# NJG1155UX2

## ■ ABSOLUTE MAXIMUM RATINGS

General conditions:  $T_a=+25^{\circ}\text{C}$ ,  $Z_s=Z_l=50\Omega$

PARAMETERS	SYMBOL	CONDITIONS	RATINGS	UNITS
Supply voltage	$V_{DD}$		5.0	V
Control voltage	$V_{CTL}$		5.0	V
Input power	$P_{IN}$	$V_{DD}=2.8\text{V}$	+15	dBm
Power dissipation	$P_D$	4-layer FR4 PCB without through-hole (101.5mm x 114.5mm), $T_j=150^{\circ}\text{C}$	430	mW
Operating temperature	$T_{opr}$		-40 to +85	$^{\circ}\text{C}$
Storage temperature	$T_{stg}$		-55 to +150	$^{\circ}\text{C}$

## ■ ELECTRICAL CHARACTERISTICS 1 (DC)

General conditions:  $T_a=+25^{\circ}\text{C}$ ,  $Z_s=Z_l=50\Omega$

PARAMETER	SYMBOL	CONDITIONS	MIN	TYP	MAX	UNITS
Supply Voltage	$V_{DD}$		1.5	-	3.3	V
Control Voltage (High)	$V_{CTL(H)}$		1.2	1.8	3.3	V
Control Voltage (Low)	$V_{CTL(L)}$		0	0	0.3	V
Supply Current1 (Active mode)	$I_{DD1}$	$V_{DD}=2.8\text{V}$ , $V_{CTL}=1.8\text{V}$	-	3.5	6.0	mA
Supply Current2 (Active mode)	$I_{DD2}$	$V_{DD}=1.8\text{V}$ , $V_{CTL}=1.8\text{V}$	-	3.1	5.5	mA
Supply Current3 (Stand-by mode)	$I_{DD3}$	$V_{DD}=2.8\text{V}$ , $V_{CTL}=0\text{V}$	-	0.1	3.0	$\mu\text{A}$
Supply Current4 (Stand-by mode)	$I_{DD4}$	$V_{DD}=1.8\text{V}$ , $V_{CTL}=0\text{V}$	-	0.1	3.0	$\mu\text{A}$
Control Current	$I_{CTL}$	$V_{CTL}=1.8\text{V}$	-	5.0	12.0	$\mu\text{A}$

## ■ ELECTRICAL CHARACTERISTICS 2 (RF, V<sub>DD</sub>=2.8V)

General conditions: V<sub>DD</sub>=2.8V, V<sub>CTL</sub>=1.8V, f<sub>RF</sub>=1550 to 1615MHz, T<sub>a</sub>=+25°C, Z<sub>s</sub>=Z<sub>l</sub>=50Ω, with application circuit

PARAMETER	SYMBOL	CONDITIONS	MIN	TYP	MAX	UNITS
Small Signal Gain1	Gain1	Exclude PCB and connector losses (0.18dB)	16.5	19.0	21.0	dB
Noise Figure1	NF1	Exclude PCB and connector losses (0.08dB)	-	0.75	1.0	dB
Isolation1	ISL1		25.0	35.0	-	dB
Input Power at 1dB Gain Compression Point1	P <sub>-1dB</sub> (IN)1		-17.0	-12.5	-	dBm
Input 3rd Order Intercept Point1	IIP3_1	f <sub>1</sub> =f <sub>RF</sub> , f <sub>2</sub> =f <sub>1</sub> +/-1MHz, Pin=-30dBm	-5.0	-1.5	-	dBm
Out of Band Input 3rd Order Intercept Point1	IIP3_OB1	f <sub>1</sub> =1712.7MHz, Pin=-20dBm, f <sub>2</sub> =1850MHz, Pin=-20dBm, f <sub>meas</sub> =1575.4MHz	-4.0	0.0	-	dBm
RFIN Port Return Loss1	RLi1		6.0	10.0	-	dB
RFOUT Port Return Loss1	RLo1		8.0	12.0	-	dB

## ■ ELECTRICAL CHARACTERISTICS 3 (RF, V<sub>DD</sub>=1.8V)

General conditions: V<sub>DD</sub>=1.8V, V<sub>CTL</sub>=1.8V, f<sub>RF</sub>=1550 to 1615MHz, T<sub>a</sub>=+25°C, Z<sub>s</sub>=Z<sub>l</sub>=50Ω, with application circuit

PARAMETER	SYMBOL	CONDITIONS	MIN	TYP	MAX	UNITS
Small Signal Gain2	Gain2	Exclude PCB and connector losses (0.18dB)	15.0	18.5	21.0	dB
Noise Figure2	NF2	Exclude PCB and connector losses (0.08dB)	-	0.75	1.1	dB
Isolation2	ISL2		25.0	35.0	-	dB
Input Power at 1dB Gain Compression Point2	P <sub>-1dB</sub> (IN)2		-20.0	-16.0	-	dBm
Input 3rd Order Intercept Point2	IIP3_2	f <sub>1</sub> =f <sub>RF</sub> , f <sub>2</sub> =f <sub>1</sub> +/-1MHz, Pin=-30dBm	-10.0	-5.0	-	dBm
Out of Band Input 3rd Order Intercept Point2	IIP3_OB2	f <sub>1</sub> =1712.7MHz, Pin=-20dBm, f <sub>2</sub> =1850MHz, Pin=-20dBm, f <sub>meas</sub> =1575.4MHz	-7.0	-3.0	-	dBm
RF IN Port Return Loss2	RLi2		6.0	10.0	-	dB
RF OUT Port Return Loss2	RLo2		7.0	12.0	-	dB

# NJG1155UX2

---

## ■ TERMINAL INFORMATION

No.	SYMBOL	DESCRIPTION
1	GND	Ground terminal. This terminal should be connected to the ground plane as close as possible for excellent RF performance.
2	VDD	Supply voltage terminal. Please connect bypass capacitor C1 with ground as close as possible.
3	RFOUT	RF output terminal. This terminal requires no DC blocking capacitor since this IC has internal output matching circuit including DC blocking capacitor.
4	GND	Ground terminal. This terminal should be connected to the ground plane as close as possible for excellent RF performance.
5	RFIN	RF input terminal. This terminal requires only a matching inductor L1, and does not require DC blocking capacitor.
6	VCTL	Control voltage terminal.

## ELECTRICAL CHARACTERISTICS

Conditions:  $V_{DD}=2.8V$ ,  $V_{CTL}=1.8V$ ,  $T_a=25^\circ C$ ,  $Z_s=Z_l=50\Omega$

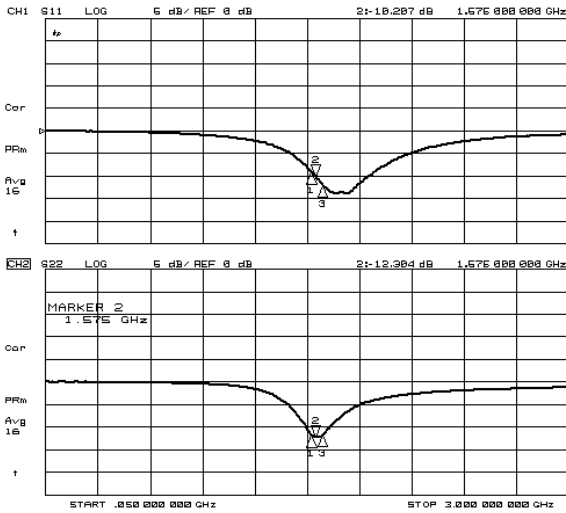

S11, S22

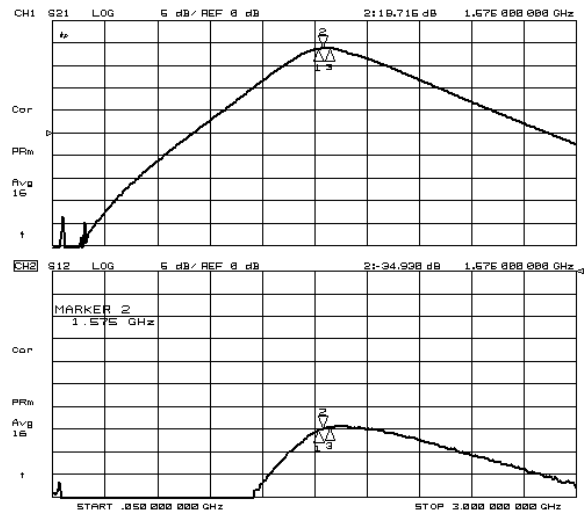

S21, S12

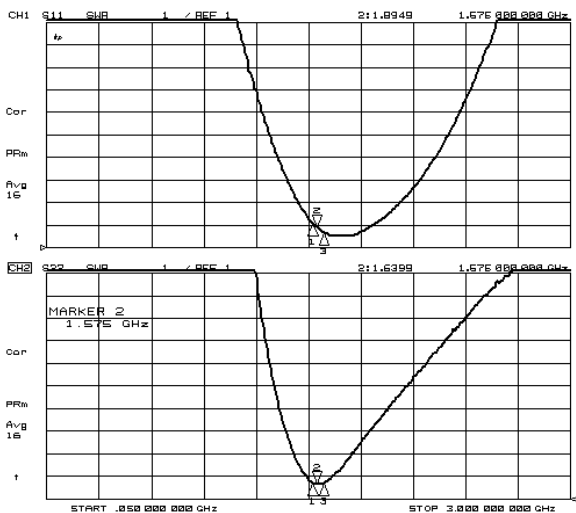

VSWR

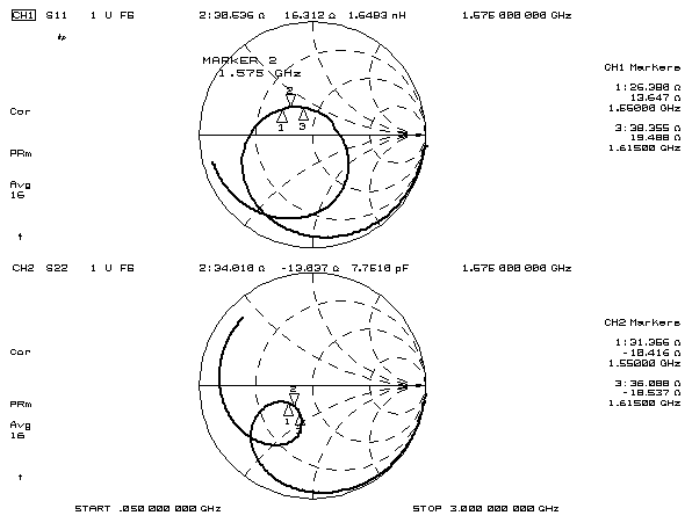

Zin, Zout

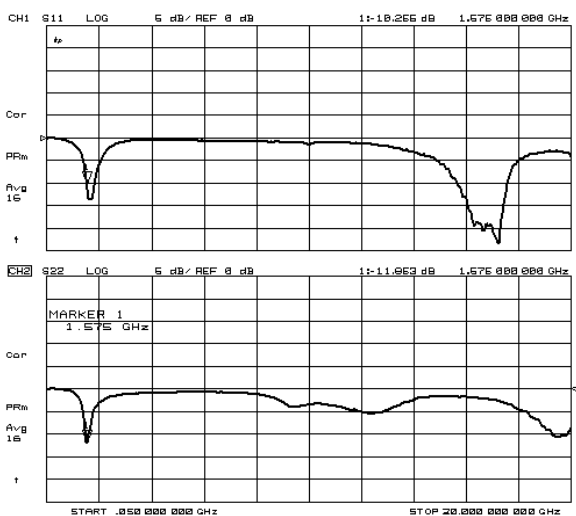

S11, S22 (f=50M to 20GHz)

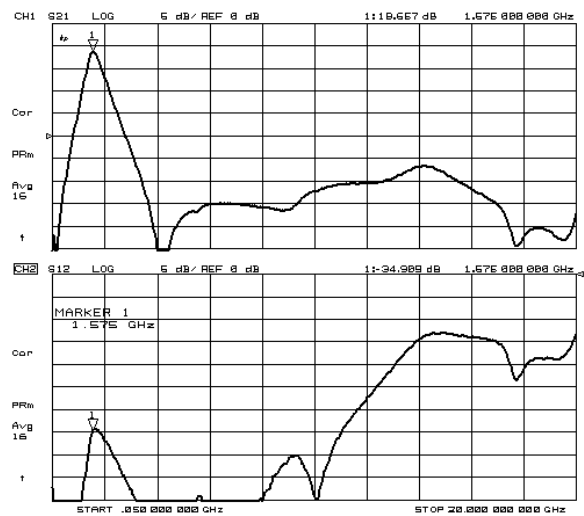

S21, S12 (f=50M to 20GHz)

# NJG1155UX2

## ELECTRICAL CHARACTERISTICS

Conditions:  $V_{DD}=2.8V$ ,  $V_{CTL}=1.8V$ ,  $T_a=25^\circ C$ ,  $Z_s=Z_l=50\Omega$

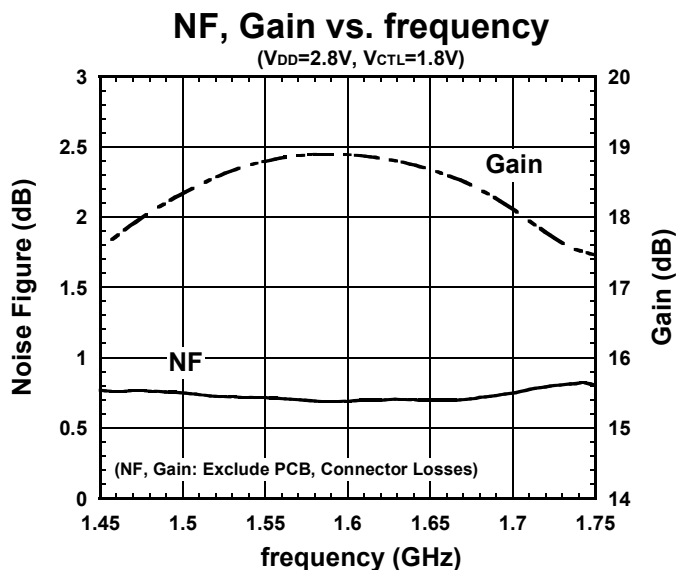
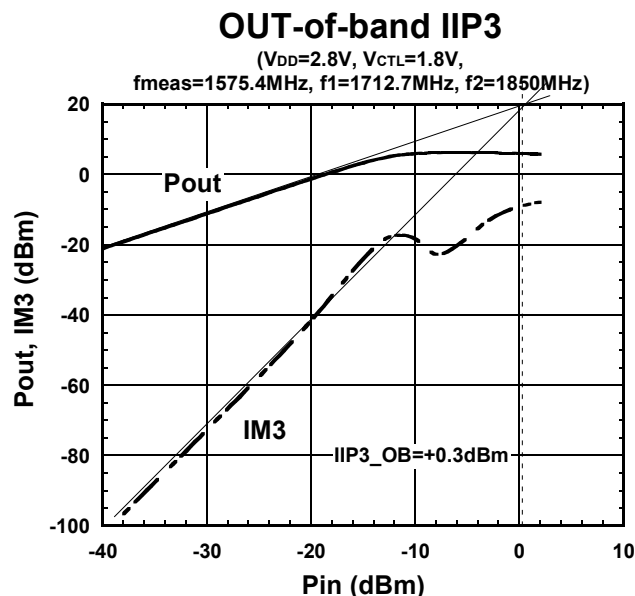
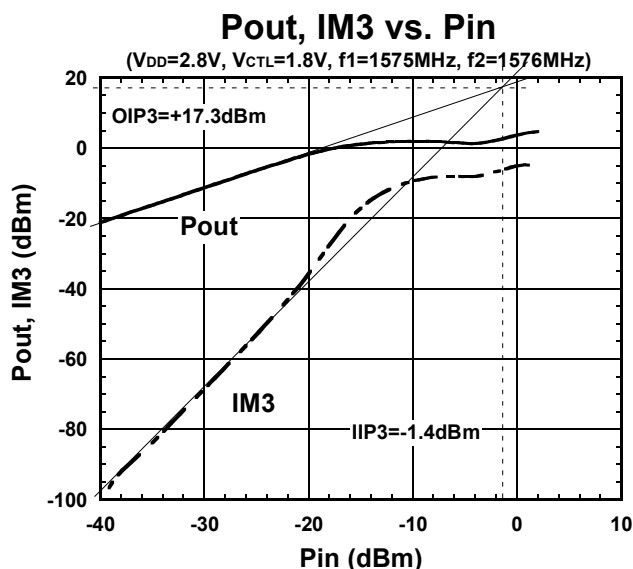
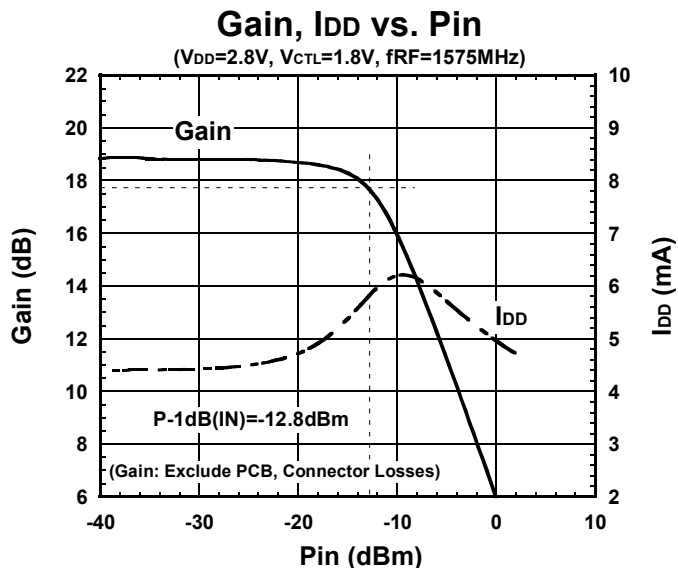
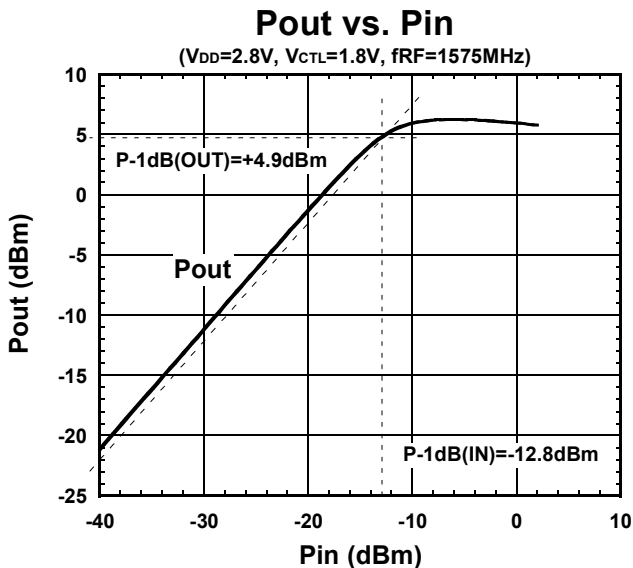

## ELECTRICAL CHARACTERISTICS

Conditions:  $V_{DD}=2.8V$ ,  $V_{CTL}=1.8V$ ,  $f_{RF}=1575MHz$ ,  $Z_S=Z_I=50\Omega$

### Gain, NF vs. Temperature

( $V_{DD}=2.8V$ ,  $V_{CTL}=1.8V$ ,  $f_{RF}=1575MHz$ )

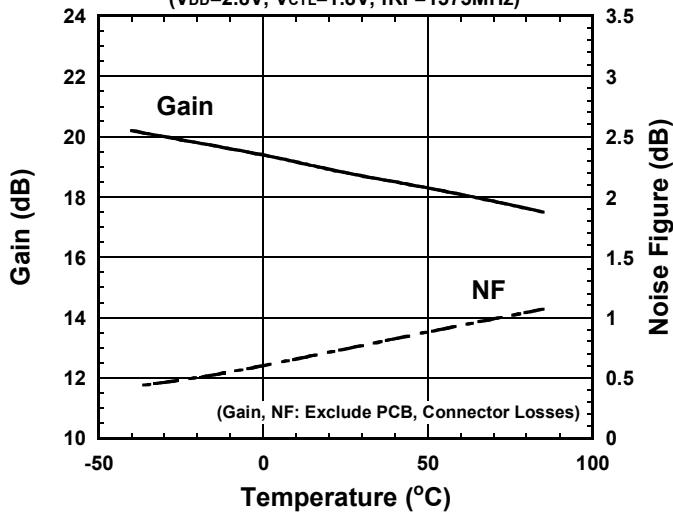

### I<sub>DD</sub> vs. Temperature

( $V_{DD}=2.8V$ ,  $V_{CTL}=1.8V/0V$ , RF OFF)

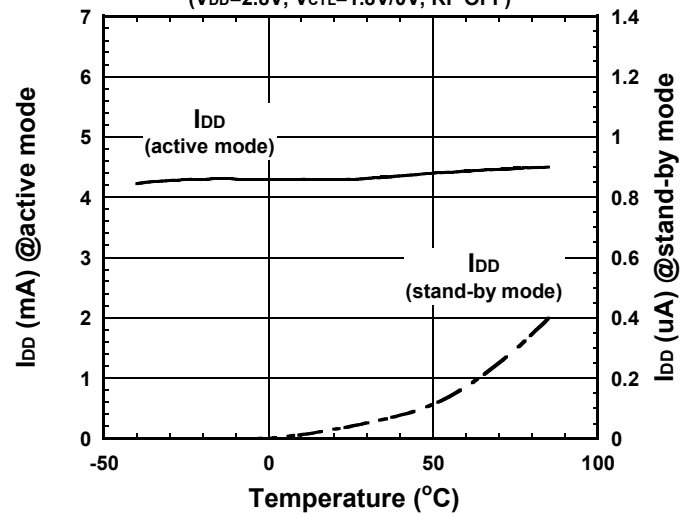

### OIP3, IIP3 vs. Temperature

( $V_{DD}=2.8V$ ,  $V_{CTL}=1.8V$ ,  $f_1=1575MHz$ ,  $f_2=1576MHz$ ,  $Pin=-30dBm$ )

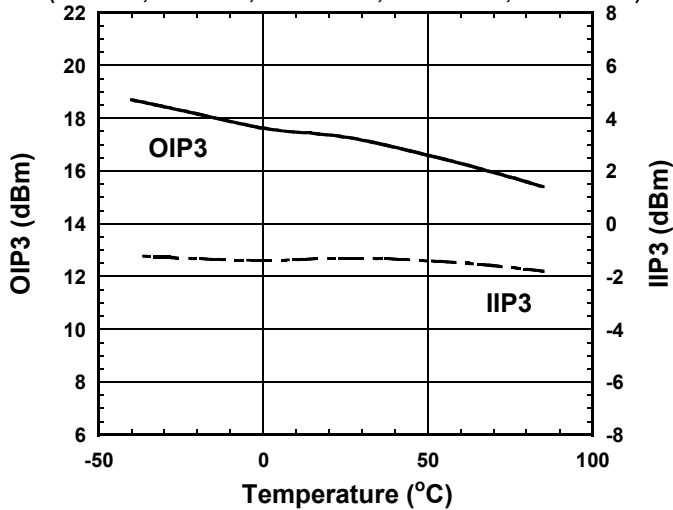

### Out-of-band IIP3 vs. Temperature

( $V_{DD}=2.8V$ ,  $V_{CTL}=1.8V$ ,  $f_{meas}=1575.4MHz$ ,  $f_1=1712.7MHz$  at  $Pin=-20dBm$ ,  $f_2=1850MHz$  at  $Pin=-20dBm$ )

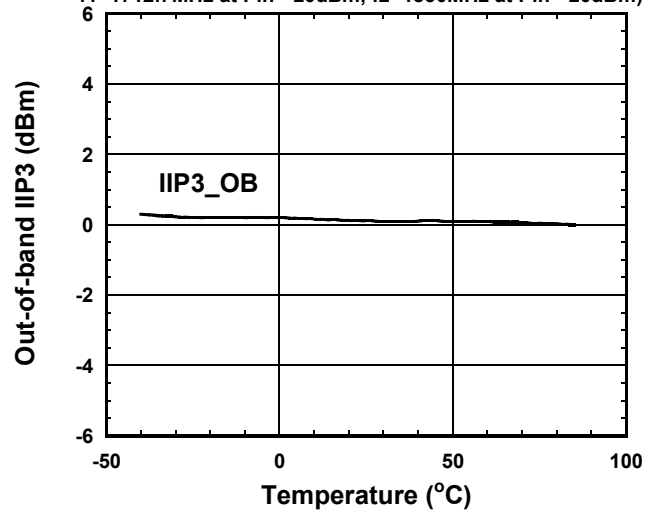

### P-1dB(IN) vs. Temperature

( $V_{DD}=2.8V$ ,  $V_{CTL}=1.8V$ ,  $f_{RF}=1575MHz$ )

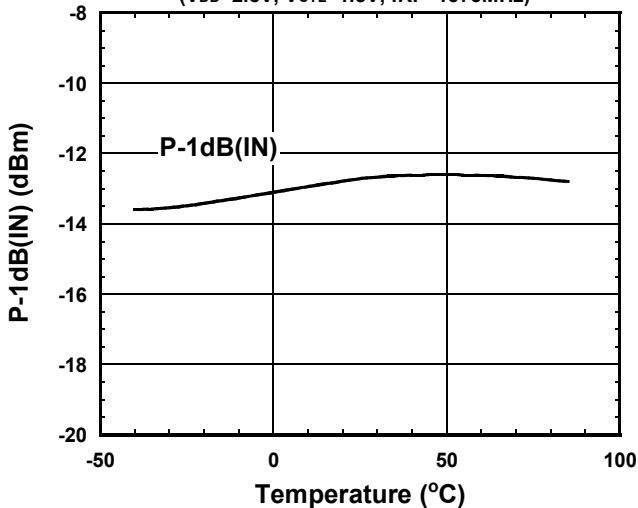

### Return Loss vs. Temperature

( $V_{DD}=2.8V$ ,  $V_{CTL}=1.8V$ ,  $f_{RF}=1575MHz$ )

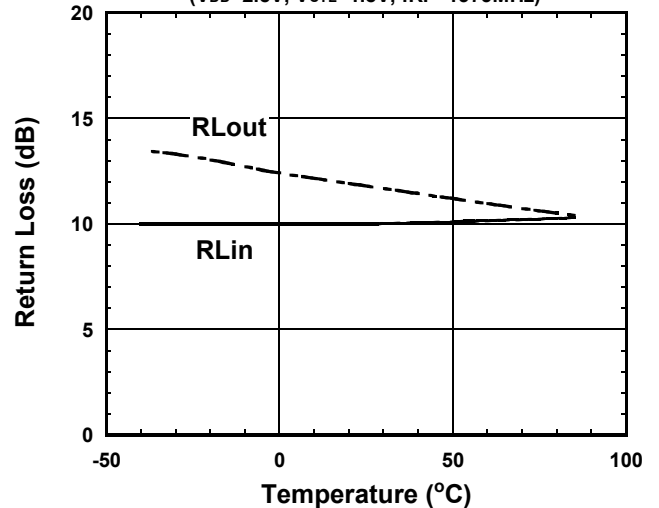

# NJG1155UX2

## ELECTRICAL CHARACTERISTICS

Conditions:  $V_{DD}=1.8V$ ,  $V_{CTL}=1.8V$ ,  $T_a=25^\circ C$ ,  $Z_S=Z_L=50\Omega$

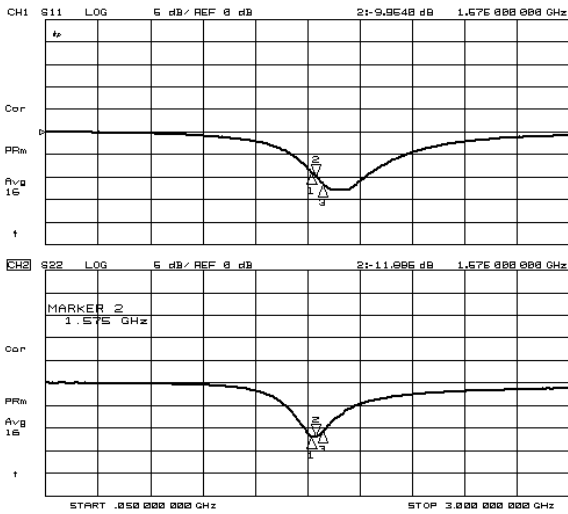

S11, S22

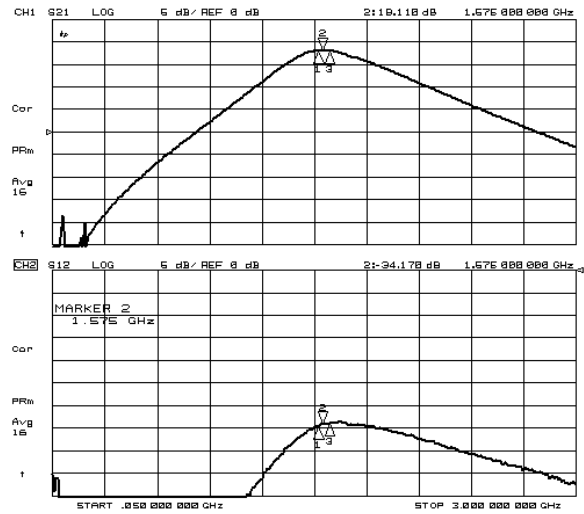

S21, S12

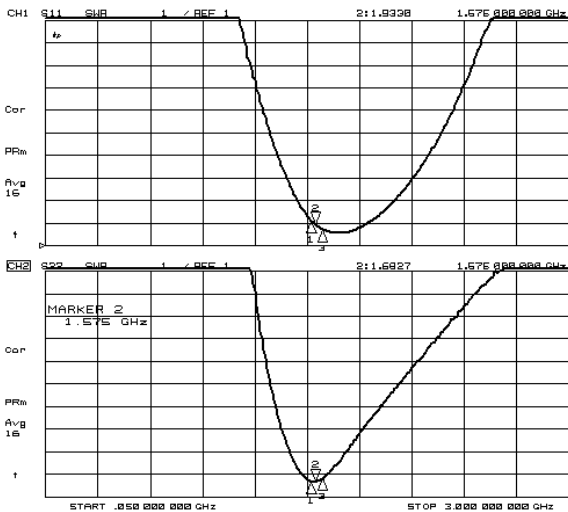

VSWR

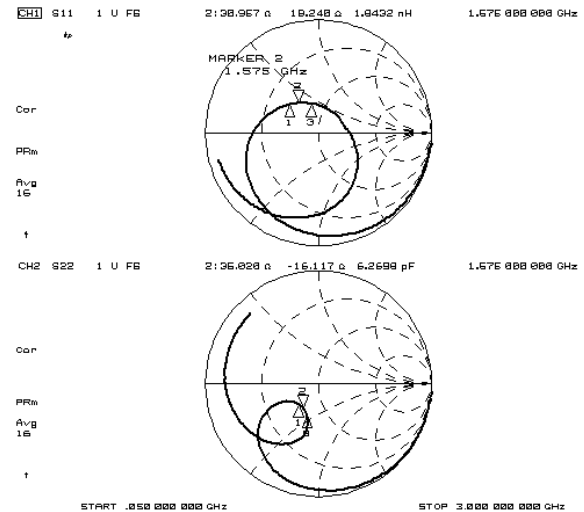

Zin, Zout

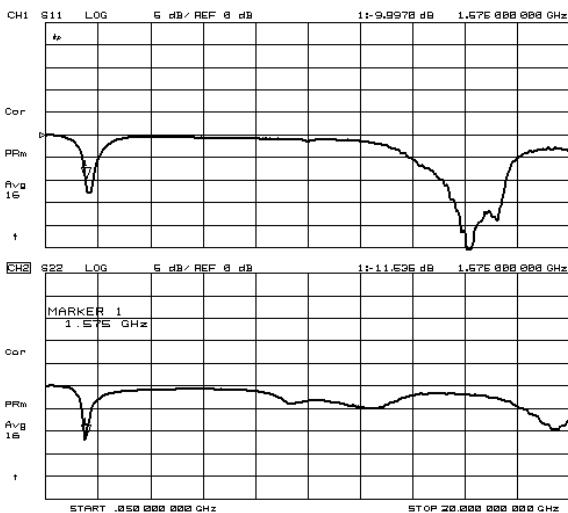

S11, S22 (f=50M to 20GHz)

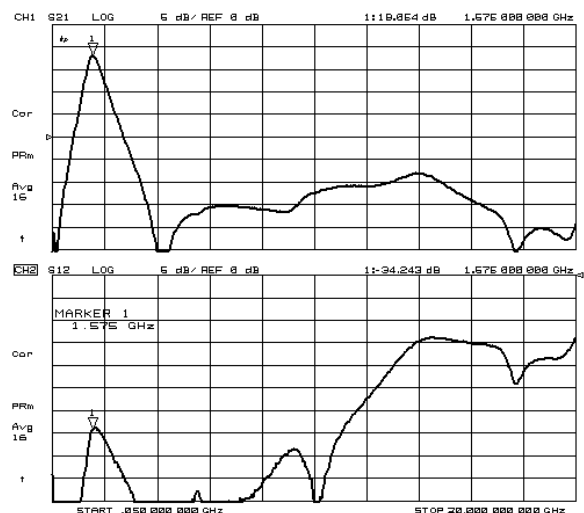

S21, S12 (f=50M to 20GHz)



## ELECTRICAL CHARACTERISTICS

Conditions:  $V_{DD}=1.8V$ ,  $V_{CTL}=1.8V$ ,  $T_a=25^\circ C$ ,  $Z_s=Z_l=50\Omega$

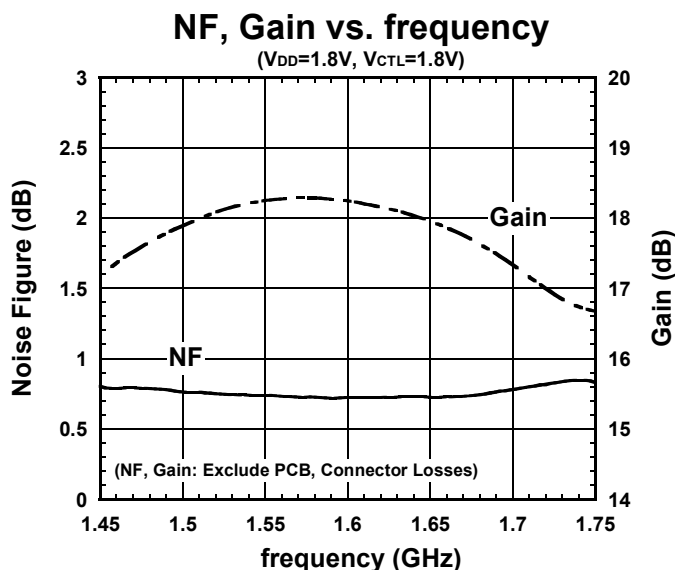
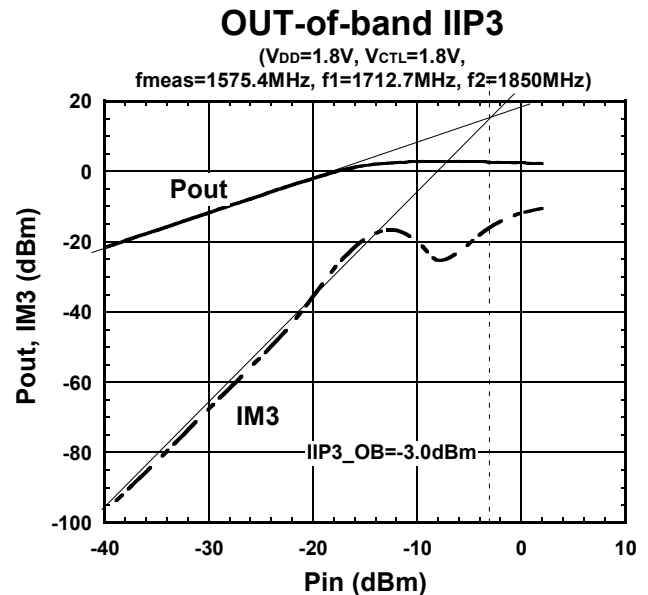
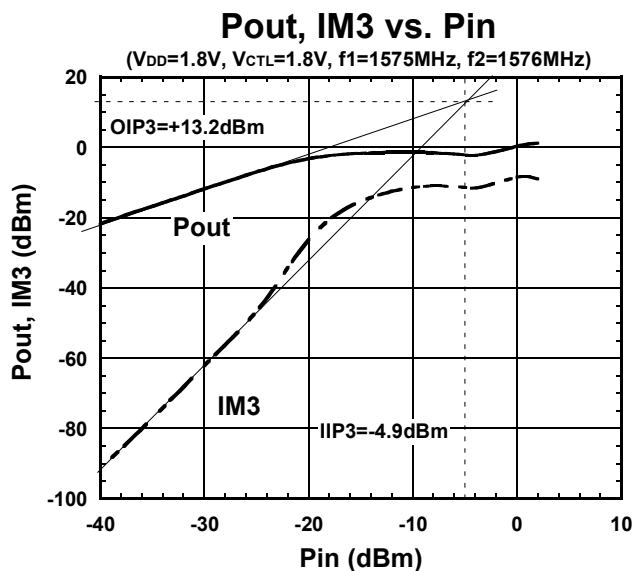
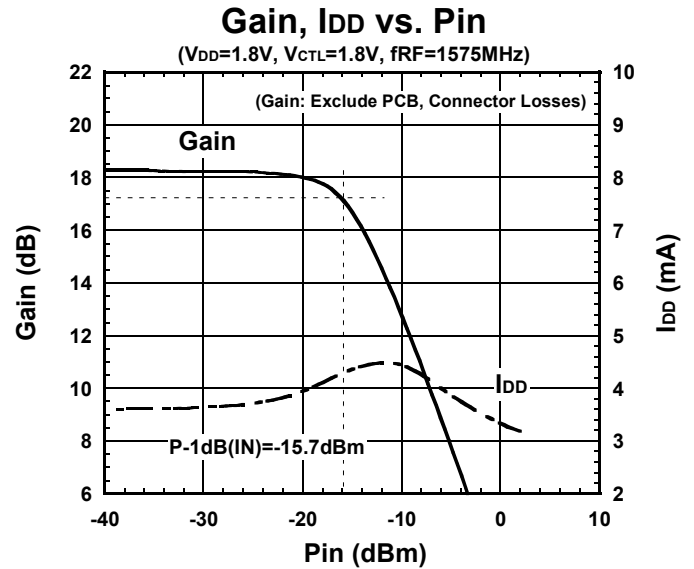
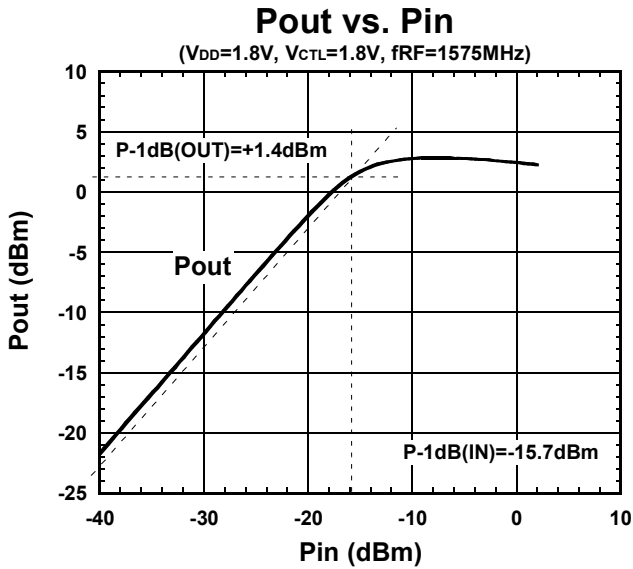

# NJG1155UX2

## ELECTRICAL CHARACTERISTICS

Conditions:  $V_{DD}=1.8V$ ,  $V_{CTL}=1.8V$ ,  $f_{RF}=1575MHz$ ,  $Z_S=Z_I=50\Omega$

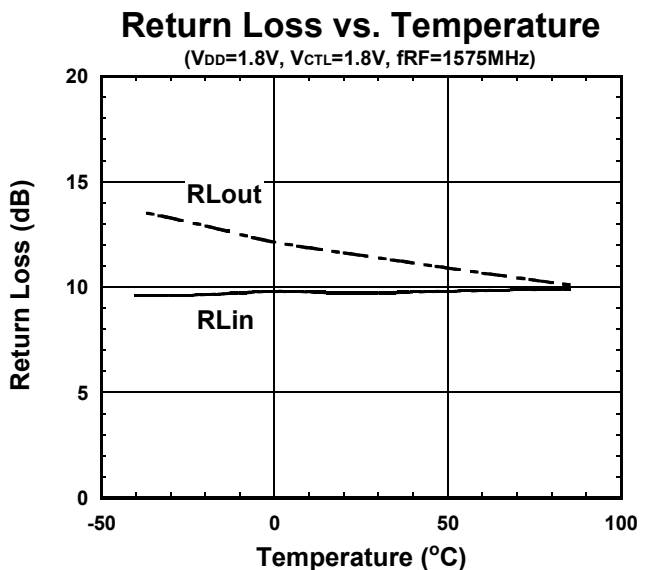
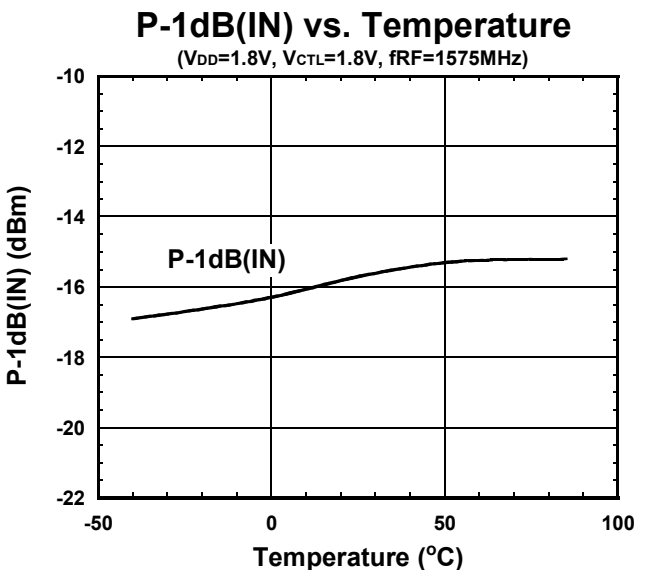
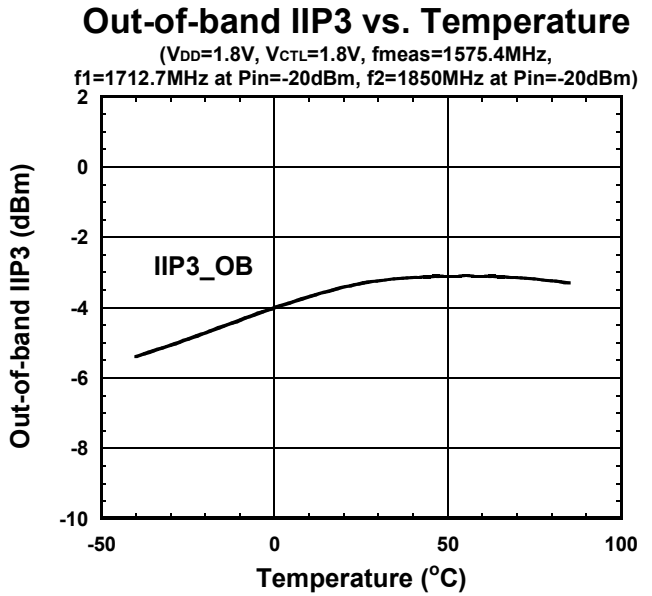
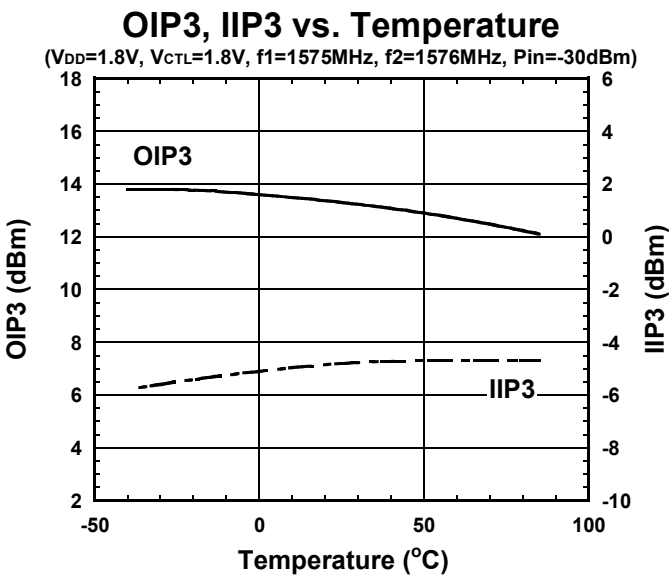
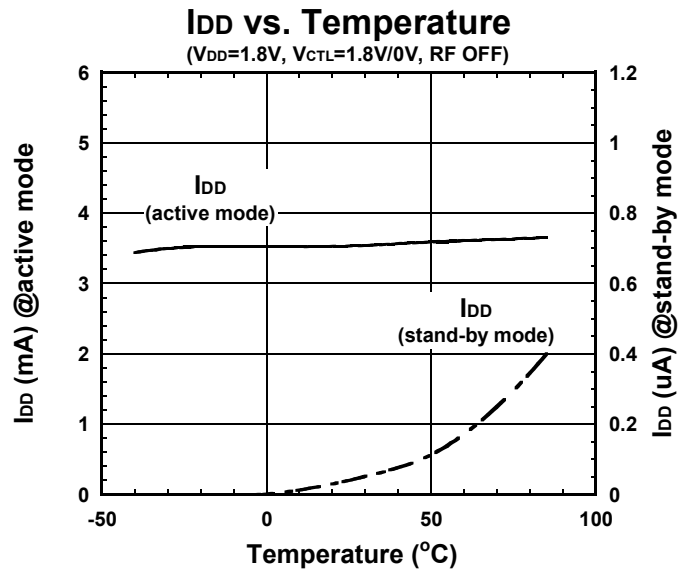
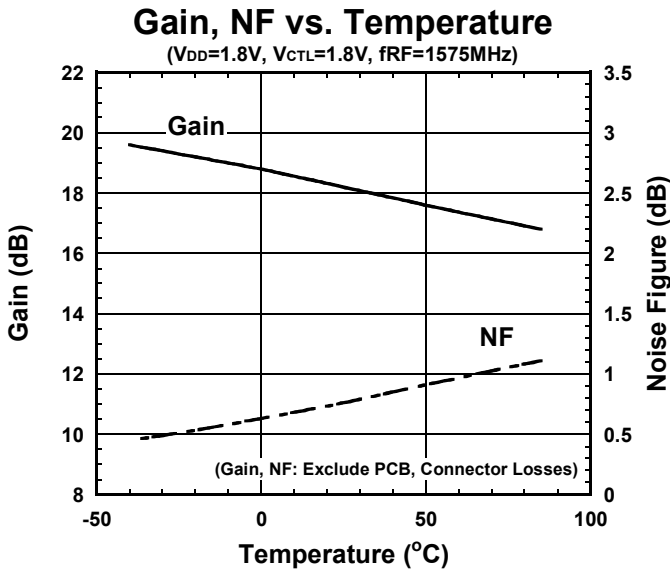

## ELECTRICAL CHARACTERISTICS

Conditions:  $V_{CTL}=1.8V$ ,  $f_{RF}=1575MHz$ ,  $T_a=25^\circ C$ ,  $Z_s=Z_l=50\Omega$

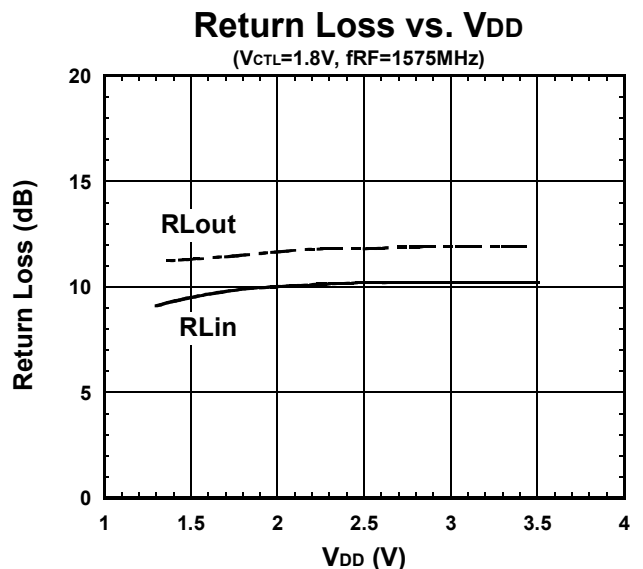
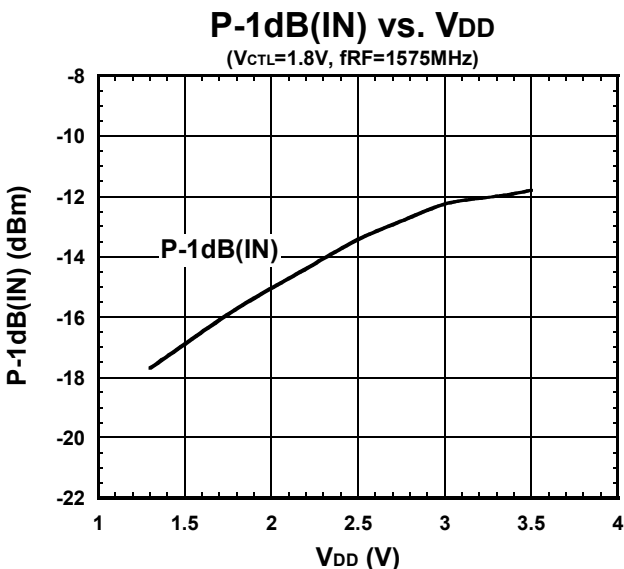
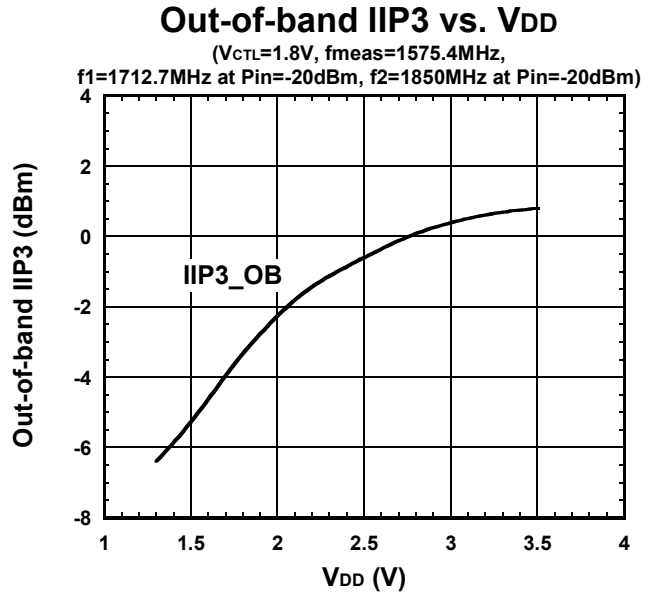
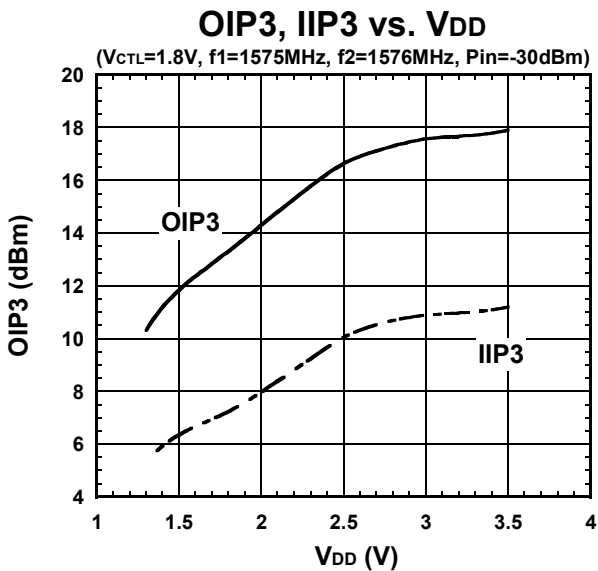
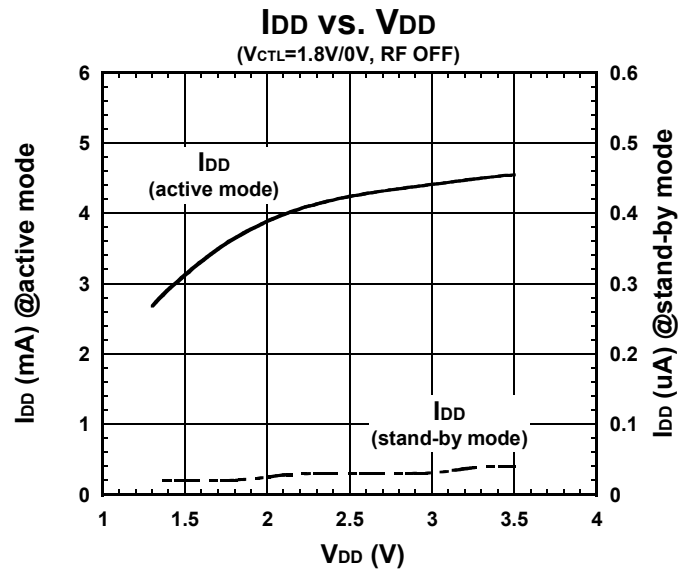
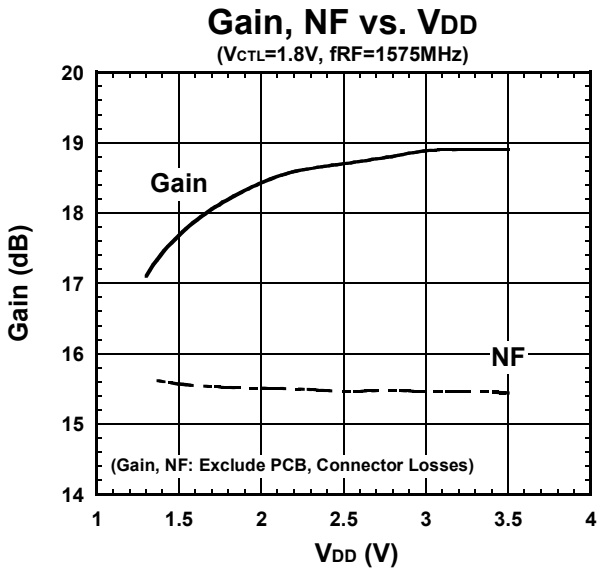

# NJG1155UX2

## APPLICATION CIRCUIT

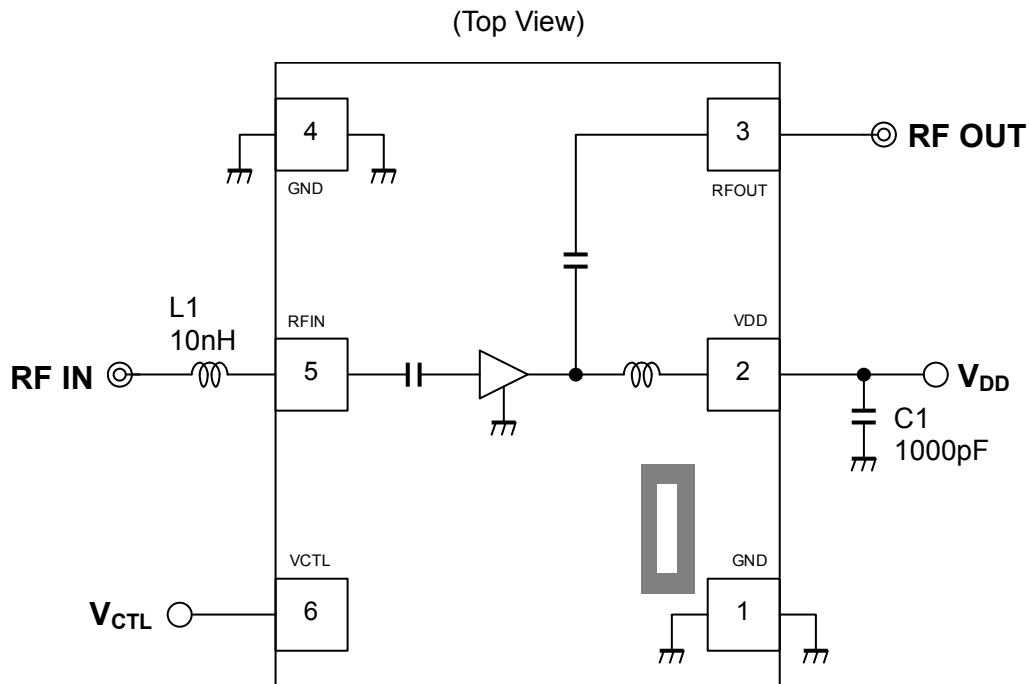

### Parts list

Parts ID	Manufacture
L1	LQG15HS Series (MURATA)
C1	GRM03 Series (MURATA)

## ■ EVALUATION BOARD

(Top View)

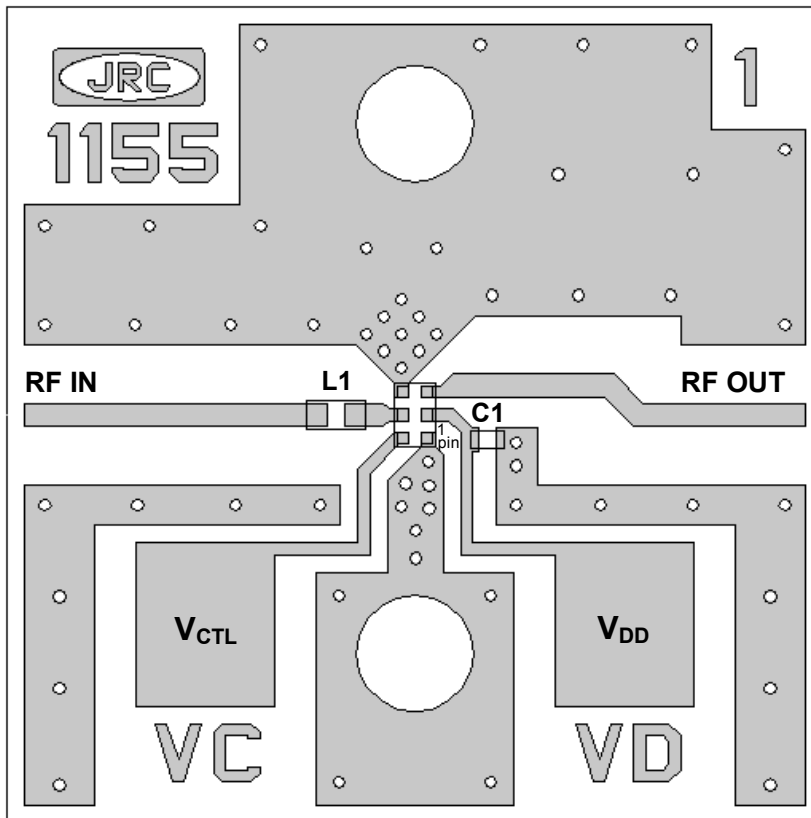

### PCB Information

Substrate:	FR-4
Thickness:	0.2mm
Microstrip line width:	0.4mm ( $Z_0=50\Omega$ )
Size:	14.0mm x 14.0mm

### <PCB LAYOUT GUIDELINE>

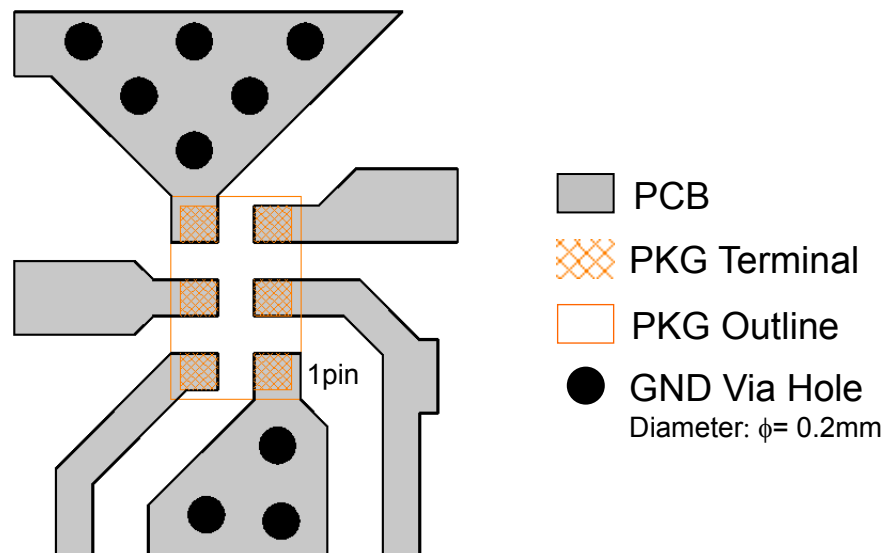



### PRECAUTIONS

- All external parts should be placed as close as possible to the IC.
- For good RF performance, all GND terminals must be connected to PCB ground plane of substrate, and via-holes for GND should be placed near the IC.

# NJG1155UX2

## RECOMMENDED FOOTPRINT PATTERN (EPFFP6-X2 PACKAGE)

PKG: 1.1mm x 0.7mm  
Pin pitch: 0.4mm

-  : Land
-  : Mask (Open area) \*Metal mask thickness : 100μm
-  : Resist (Open area)

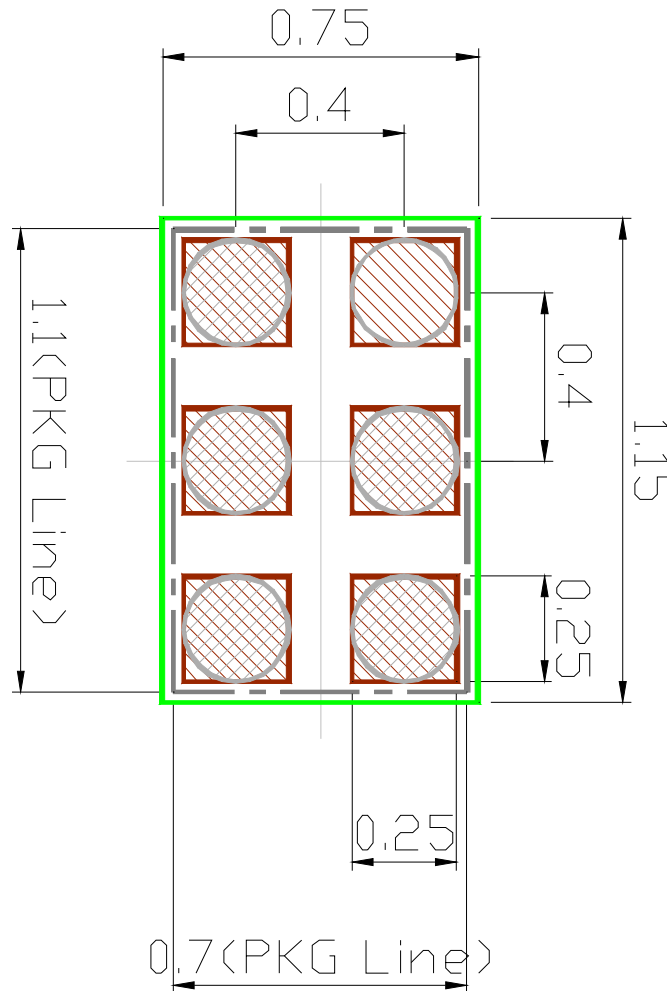

## APPLICATION NOTE FOR ULTRA LOW NOISE FIGURE (Using LQW15A Series high-Q inductor)

This application note shows an example in order to achieve ultra low noise figure (NF).  
LQW15A (MURATA) Series inductor is used for this application.

The example of electrical characteristics are shown as follows:

### ■ ELECTRICAL CHARACTERISTICS (DC)

General conditions:  $T_a=+25^{\circ}\text{C}$ ,  $Z_s=Z_i=50\Omega$

PARAMETER	SYMBOL	CONDITIONS	MEASURED DATA	UNITS
Supply Voltage	$V_{DD}$		2.8 / 1.8	V
Control Voltage (High)	$V_{CTL(H)}$		1.8	V
Control Voltage (Low)	$V_{CTL(L)}$		0	V
Supply Current1 (Active mode)	$I_{DD}$	$V_{DD}=2.8\text{V}$ , $V_{CTL}=1.8\text{V}$	4.13	mA
Supply Current2 (Active mode)	$I_{DD}$	$V_{DD}=1.8\text{V}$ , $V_{CTL}=1.8\text{V}$	3.43	mA
Supply Current3 (Stand-by mode)	$I_{DD}$	$V_{DD}=2.8\text{V}$ , $V_{CTL}=0\text{V}$	0.1	$\mu\text{A}$
Supply Current4 (Stand-by mode)	$I_{DD}$	$V_{DD}=1.8\text{V}$ , $V_{CTL}=0\text{V}$	0.0	$\mu\text{A}$
Control Current	$I_{CTL}$	$V_{CTL}=1.8\text{V}$	6.6	$\mu\text{A}$

# NJG1155UX2

## ■ Electrical characteristics (RF, V<sub>DD</sub>=2.8V)

General conditions: V<sub>DD</sub>=2.8V, V<sub>CTL</sub>=1.8V, f<sub>RF</sub>=1550 to 1615MHz, T<sub>a</sub>=+25°C, Z<sub>s</sub>=Z<sub>l</sub>=50Ω, with application circuit

PARAMETER	SYMBOL	CONDITIONS	MEASURED DATA	UNITS
Small Signal Gain	Gain	Exclude PCB and connector losses (0.18dB)	19.0 to 19.1	dB
Noise Figure	NF	Exclude PCB and connector losses (0.08dB)	0.56 to 0.59	dB
Input Power at 1dB Gain Compression Point	P <sub>-1dB(IN)</sub>		-13.6 to -13.2	dBm
Input 3rd Order Intercept Point	IIP3	f <sub>1</sub> =f <sub>RF</sub> , f <sub>2</sub> =f <sub>1</sub> +/-1MHz, Pin=-30dBm	-2.1	dBm
Out of Band Input 3 <sup>rd</sup> Order Intercept Point	IIP3_OB	f <sub>1</sub> =1712.7MHz, Pin=-20dBm, f <sub>2</sub> =1850MHz, Pin=-20dBm, f <sub>meas</sub> =1575.4MHz	-0.4	dBm
RF IN Port Return Loss	RLi		8.8 to 10.3	dB
RF OUT Port Return Loss	RLo		11.1 to 11.8	dB

## ■ ELECTRICAL CHARACTERISTICS (RF, V<sub>DD</sub>=1.8V)

General conditions: V<sub>DD</sub>=1.8V, V<sub>CTL</sub>=1.8V, f<sub>RF</sub>=1550 to 1615MHz, T<sub>a</sub>=+25°C, Z<sub>s</sub>=Z<sub>l</sub>=50Ω, with application circuit

PARAMETER	SYMBOL	CONDITIONS	MEASURED DATA	UNITS
Small Signal Gain	Gain	Exclude PCB and connector losses (0.18dB)	18.3 to 18.5	dB
Noise Figure	NF	Exclude PCB and connector losses (0.08dB)	0.59 to 0.62	dB
Input Power at 1dB Gain Compression Point	P <sub>-1dB (IN)</sub>		-16.5 to -16.1	dBm
Input 3rd Order Intercept Point	IIP3	f <sub>1</sub> =f <sub>RF</sub> , f <sub>2</sub> =f <sub>1</sub> +/-1MHz, Pin=-30dBm	-5.3	dBm
Out of Band Input 3rd Order Intercept Point	IIP3_OB	f <sub>1</sub> =1712.7MHz, Pin=-20dBm, f <sub>2</sub> =1850MHz, Pin=-20dBm, f <sub>meas</sub> =1575.4MHz	-3.6	dBm
RF IN Port Return Loss	RLi		8.4 to 9.8	dB
RF OUT Port Return Loss	RLo		10.3 to 11.5	dB



## APPLICATION CIRCUIT (Using LQW15A Series high-Q inductor)

(Top View)

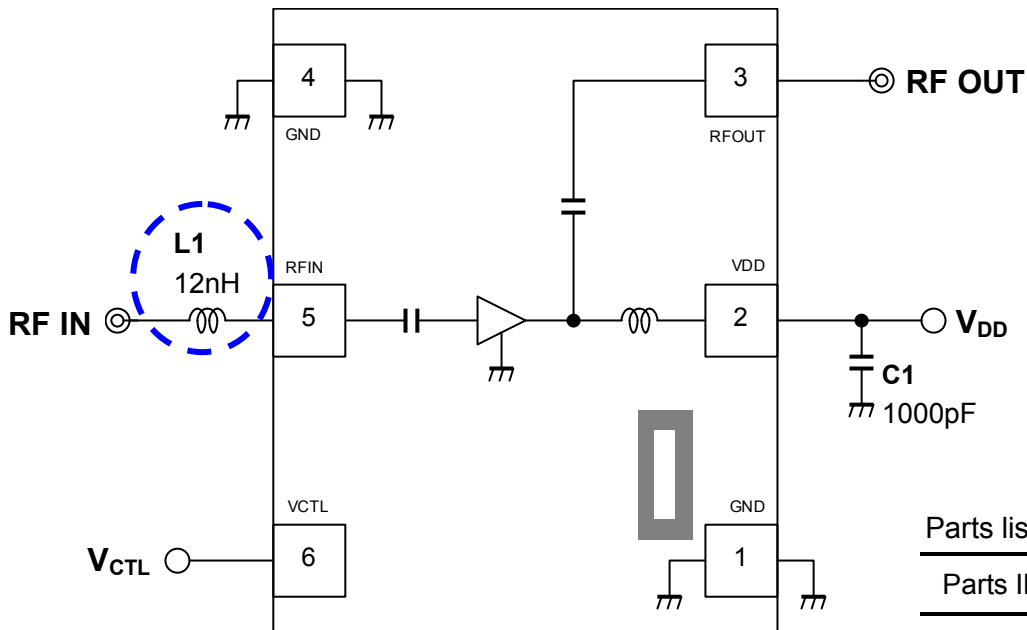

### Parts list

Parts ID	Manufacture
L1	LQW15A Series (MURATA)
C1	GRM03 Series (MURATA)

## EVALUATION BOARD (Using LQW15A Series high-Q inductor)

(Top View)

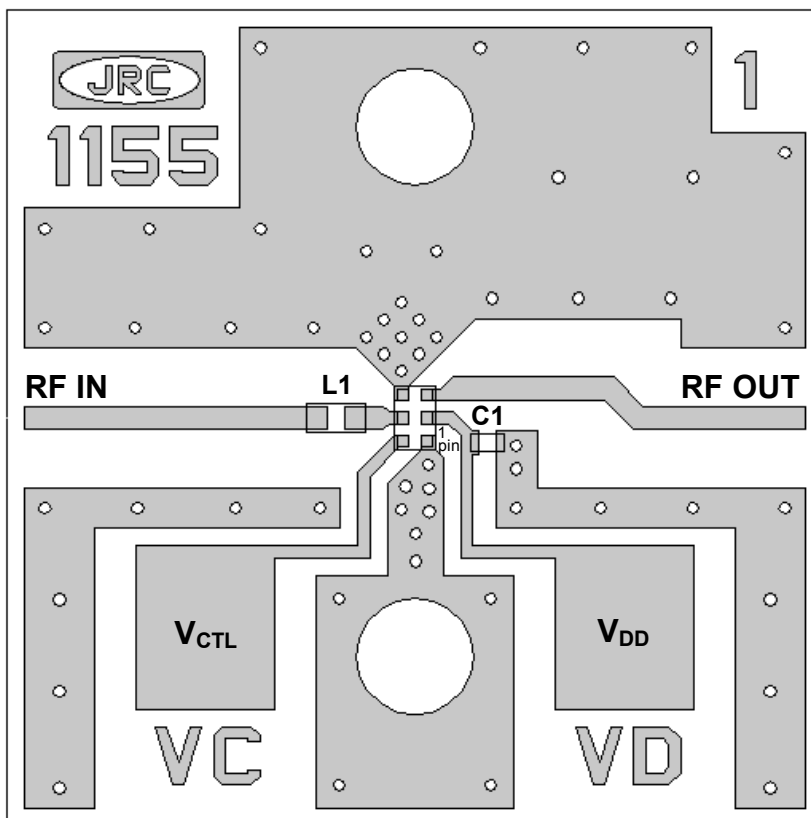

### PCB Information

Material: FR-4  
 Thickness: 0.2mm  
 Microstrip line width: 0.4mm ( $Z_0=50\Omega$ )  
 Outline size: 14.0mm x 14.0mm

# NJG115UX2

## ■ NOISE FIGURE MEASUREMENT BLOCK DIAGRAM

### Measuring instruments

NF Analyzer : Agilent N8973A  
Noise Source : Agilent 346A

### Setting the NF analyzer

Measurement mode form

Device under test : Amplifier  
System downconverter : off

Mode setup form

Sideband : LSB  
Averages : 16  
Average mode : Point  
Bandwidth : 4MHz  
Loss comp : off  
Tcold : setting the temperature of noise source (303.15K)

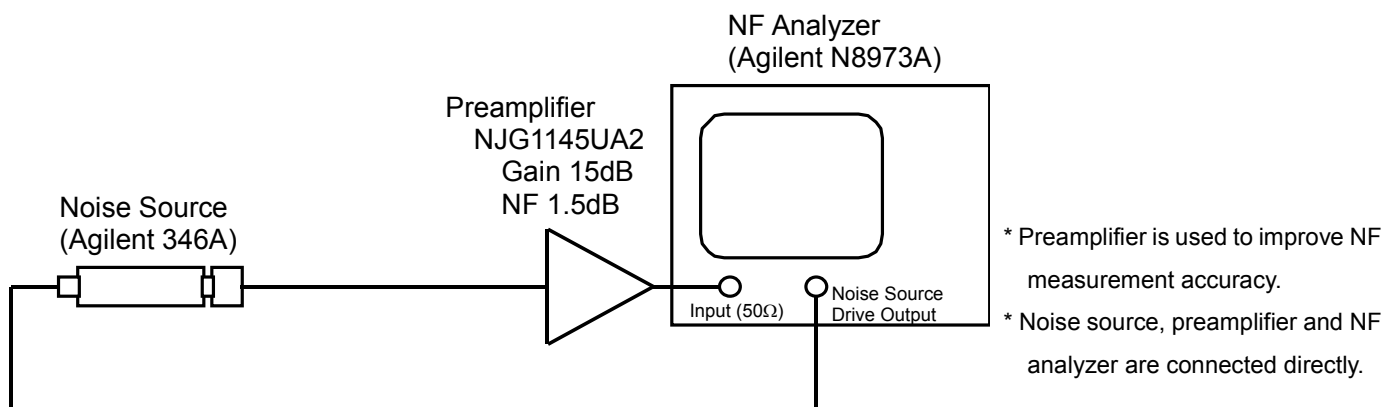

**Calibration setup**

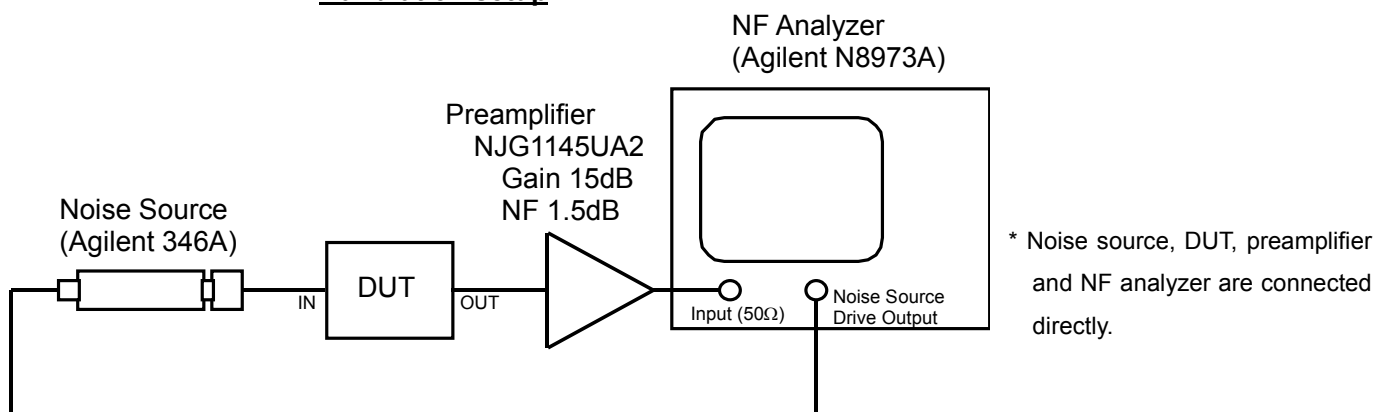

**Measurement Setup**

## PACKAGE OUTLINE (EPFFP6-X2)

TOP VIEW

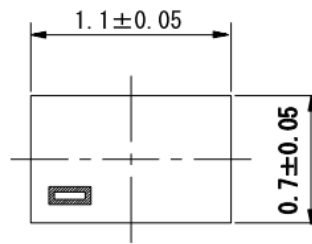

SIDE VIEW

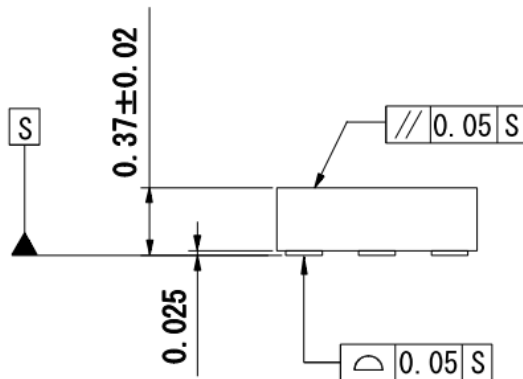

BOTTOM VIEW

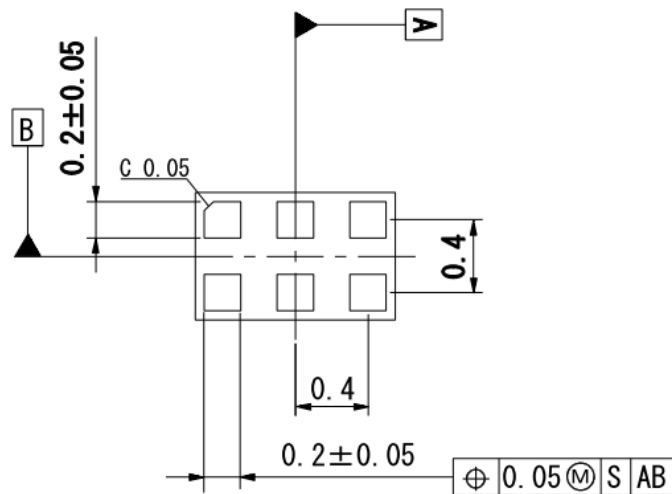

Unit	: mm
Substrate	: FR4
Terminal treat	: Au
Molding material	: Epoxy resin
Weight (typ.)	: 0.7mg

### Cautions on using this product

This product contains Gallium-Arsenide (GaAs) which is a harmful material.

- Do NOT eat or put into mouth.
- Do NOT dispose in fire or break up this product.
- Do NOT chemically make gas or powder with this product.
- To waste this product, please obey the relating law of your country.

### [CAUTION]

The specifications on this databook are only given for information, without any guarantee as regards either mistakes or omissions.

The application circuits in this databook are described only to show representative usages of the product and not intended for the guarantee or permission of any right including the industrial rights.

This product may be damaged with electric static discharge (ESD) or spike voltage. Please handle with care to avoid these damages.

# Mouser Electronics

Authorized Distributor

Click to View Pricing, Inventory, Delivery & Lifecycle Information:

[NJR:](#)

[NJG1155UX2-TE1](#)



Компания «ЭлектроПласт» предлагает заключение долгосрочных отношений при поставках импортных электронных компонентов на взаимовыгодных условиях!

Наши преимущества:

- Оперативные поставки широкого спектра электронных компонентов отечественного и импортного производства напрямую от производителей и с крупнейших мировых складов;
- Поставка более 17-ти миллионов наименований электронных компонентов;
- Поставка сложных, дефицитных, либо снятых с производства позиций;
- Оперативные сроки поставки под заказ (от 5 рабочих дней);
- Экспресс доставка в любую точку России;
- Техническая поддержка проекта, помощь в подборе аналогов, поставка прототипов;
- Система менеджмента качества сертифицирована по Международному стандарту ISO 9001;
- Лицензия ФСБ на осуществление работ с использованием сведений, составляющих государственную тайну;
- Поставка специализированных компонентов (Xilinx, Altera, Analog Devices, Intersil, Interpoint, Microsemi, Aeroflex, Peregrine, Syfer, Eurofarad, Texas Instrument, Miteq, Cobham, E2V, MA-COM, Hittite, Mini-Circuits, General Dynamics и др.);

Помимо этого, одним из направлений компании «ЭлектроПласт» является направление «Источники питания». Мы предлагаем Вам помощь Конструкторского отдела:

- Подбор оптимального решения, техническое обоснование при выборе компонента;
- Подбор аналогов;
- Консультации по применению компонента;
- Поставка образцов и прототипов;
- Техническая поддержка проекта;
- Защита от снятия компонента с производства.



#### Как с нами связаться

**Телефон:** 8 (812) 309 58 32 (многоканальный)

**Факс:** 8 (812) 320-02-42

**Электронная почта:** [org@eplast1.ru](mailto:org@eplast1.ru)

**Адрес:** 198099, г. Санкт-Петербург, ул. Калинина, дом 2, корпус 4, литера А.