

# MC74ACT564

## Octal D-Type Flip-Flop with 3-State Outputs

The MC74ACT564 is a high-speed, low power octal flip-flop with a buffered common Clock (CP) and a buffered common Output Enable ( $\overline{OE}$ ).

The information presented to the D inputs is stored in the flip-flops on the LOW-to-HIGH Clock (CP) transition.

The MC74ACT564 device is functionally identical to the MC74ACT574, but with inverted outputs.

### Features

- Inputs and Outputs on the Opposite Sides of the Package Allowing Easy Interface with Microprocessors
- Useful as Input or Output Port for Microprocessor
- Functionally Identical to the MC74ACT574 but with Inverted Outputs
- 3-State Outputs for Bus-Oriented Applications
- Outputs Source/Sink 24 mA
- TTL Compatible Inputs
- Pb-Free Packages are Available\*

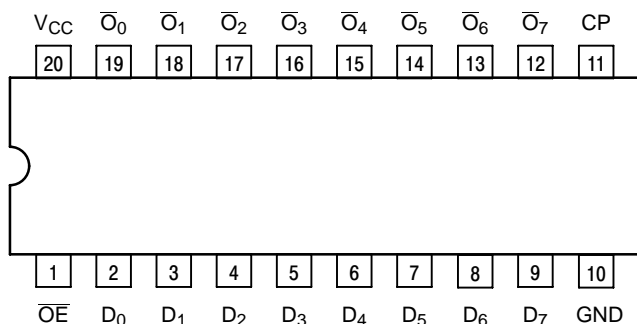

**Figure 1. Pinout: 20-Lead Packages Conductors**  
(Top View)

### PIN ASSIGNMENT

PIN	FUNCTION
D <sub>0</sub> -D <sub>7</sub>	Data Inputs
CP	Clock Pulse Input
$\overline{OE}$	3-State Output Enable Input
$\overline{O}_0$ - $\overline{O}_7$	3-State Outputs

\*For additional information on our Pb-Free strategy and soldering details, please download the ON Semiconductor Soldering and Mounting Techniques Reference Manual, SOLDERRM/D.



**ON Semiconductor**<sup>®</sup>

<http://onsemi.com>

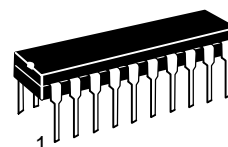

PDIP-20  
N SUFFIX  
CASE 738

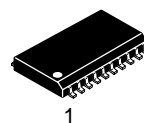

SOIC-20W  
DW SUFFIX  
CASE 751D

### ORDERING INFORMATION

See detailed ordering and shipping information in the package dimensions section on page 5 of this data sheet.

### DEVICE MARKING INFORMATION

See general marking information in the device marking section on page 5 of this data sheet.

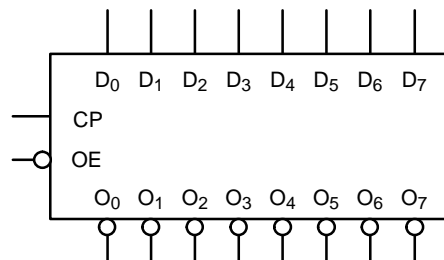

**Figure 2. Logic Symbol**

# MC74ACT564

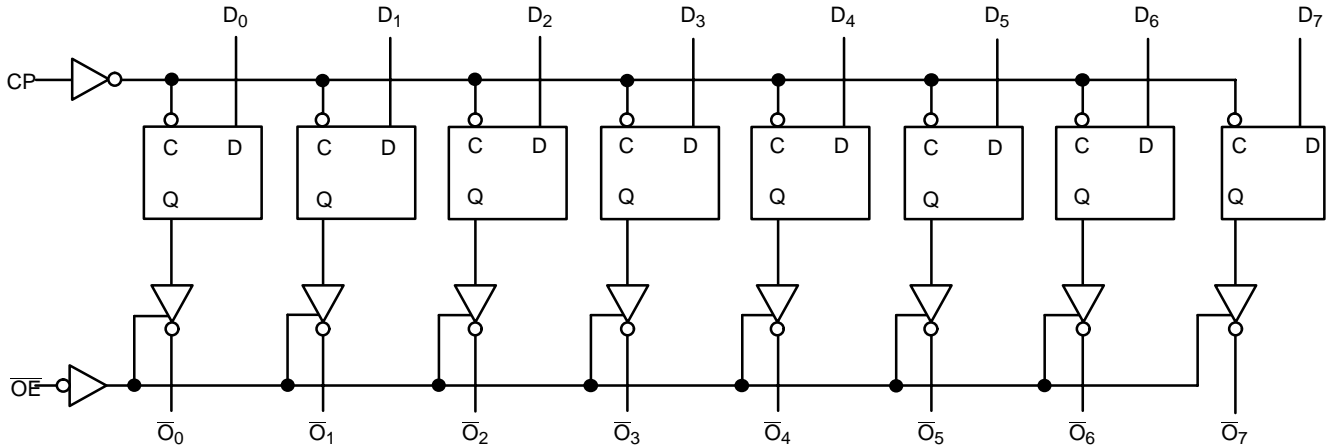

Please note that this diagram is provided only for the understanding of logic operations and should not be used to estimate propagation delays.

Figure 3. Logic Diagram

## FUNCTION TABLE

Inputs			Internal	Outputs	Function
$\overline{OE}$	CP	D	Q	O	
H	H	L	NC	Z	Hold
H	H	H	NC	Z	Hold
H	$\uparrow$	L	H	Z	Load
H	$\uparrow$	H	L	Z	Load
L	$\uparrow$	L	H	H	Data Available
L	$\uparrow$	H	L	L	Data Available
L	H	L	NC	NC	No Change in Data
L	H	H	NC	NC	No Change in Data

H = HIGH Voltage Level  
 L = LOW Voltage Level  
 X = Immaterial  
 Z = High Impedance  
 $\uparrow$  = LOW-to-HIGH Transition  
 NC = No Change

## FUNCTIONAL DESCRIPTION

The MC74ACT564 consists of eight edge-triggered flip-flops with individual D-type inputs and 3-state complementary outputs. The buffered clock and buffered Output Enable are common to all flip-flops. The eight flip-flops will store the state of their individual D inputs that

meet the setup and hold times requirements on the LOW-to-HIGH Clock (CP) transition. With the Output Enable ( $\overline{OE}$ ) LOW, the contents of the eight flip-flops are available at the outputs. When  $\overline{OE}$  is HIGH, the outputs go to the high impedance state. Operation of the  $\overline{OE}$  input does not affect the state of the flip-flops.

# MC74ACT564

## MAXIMUM RATINGS

Symbol	Parameter	Value	Unit	
$V_{CC}$	DC Supply Voltage	-0.5 to +7.0	V	
$V_I$	DC Input Voltage	$-0.5 \leq V_I \leq V_{CC} + 0.5$	V	
$V_O$	DC Output Voltage (Note 1)	$-0.5 \leq V_O \leq V_{CC} + 0.5$	V	
$I_{IK}$	DC Input Diode Current	$\pm 20$	mA	
$I_{OK}$	DC Output Diode Current	$\pm 50$	mA	
$I_O$	DC Output Sink/Source Current	$\pm 50$	mA	
$I_{CC}$	DC Supply Current per Output Pin	$\pm 50$	mA	
$I_{GND}$	DC Ground Current per Output Pin	$\pm 50$	mA	
$T_{STG}$	Storage Temperature Range	-65 to +150	°C	
$T_L$	Lead Temperature, 1 mm from Case for 10 Seconds	260	°C	
$T_J$	Junction Temperature under Bias	+150	°C	
$\theta_{JA}$	Thermal Resistance	PDIP SOIC	67 96	°C/W
$P_D$	Power Dissipation in Still Air at 85°C	PDIP SOIC	750 500	mW
MSL	Moisture Sensitivity	Level 1		
$F_R$	Flammability Rating Oxygen Index: 30% – 35%	UL 94-V0 @ 0.125 in		
$V_{ESD}$	ESD Withstand Voltage Human Body Model (Note 2) Machine Model (Note 3) Charged Device Model (Note 4)	> 2000 > 200 > 1000	V	
$I_{Latchup}$	Latchup Performance Above $V_{CC}$ and Below GND at 85°C (Note 5)	$\pm 100$	mA	

Stresses exceeding Maximum Ratings may damage the device. Maximum Ratings are stress ratings only. Functional operation above the Recommended Operating Conditions is not implied. Extended exposure to stresses above the Recommended Operating Conditions may affect device reliability.

1.  $I_O$  absolute maximum rating must be observed.
2. Tested to EIA/JESD22-A114-A.
3. Tested to EIA/JESD22-A115-A.
4. Tested to JESD22-C101-A.
5. Tested to EIA/JESD78.

## RECOMMENDED OPERATING CONDITIONS

Symbol	Parameter	Min	Typ	Max	Unit	
$V_{CC}$	DC Input Voltage (Referenced to GND)	4.5		5.5	V	
$V_{in}, V_{out}$	DC Input Voltage, Output Voltage (Referenced to GND)	0		$V_{CC}$	V	
$T_A$	Operating Temperature, All Package Types	-40	25	+85	°C	
$t_r, t_f$	Input Rise and Fall Time (Note 7)					
		$V_{CC} = 4.5\text{ V}$	0	10	10	ns/V
		$V_{CC} = 5.5\text{ V}$	0	8.0	8.0	
$T_J$	Junction Temperature (PDIP)			140	°C	
$I_{OH}$	Output Current – High			-24	mA	
$I_{OL}$	Output Current – Low			24	mA	

6. Unused Inputs may not be left open. All inputs must be tied to a high voltage level or low logic voltage level.
7.  $V_{in}$  from 0.8 V to 2.0 V; refer to individual Data Sheets for devices that differ from the typical input rise and fall times.

# MC74ACT564

## DC CHARACTERISTICS

Symbol	Parameter	V <sub>CC</sub> (V)	T <sub>A</sub> = +25°C		T <sub>A</sub> = -40°C to +85°C		Unit	Conditions
			Typ	Guaranteed Limits	Typ	Guaranteed Limits		
V <sub>IH</sub>	Minimum High Level Input Voltage	4.5	1.5	2.0	2.0	2.0	V	V <sub>OUT</sub> = 0.1 V or V <sub>CC</sub> - 0.1 V
		5.5	1.5	2.0	2.0	2.0		
V <sub>IL</sub>	Maximum Low Level Input Voltage	4.5	1.5	0.8	0.8	0.8	V	V <sub>OUT</sub> = 0.1 V or V <sub>CC</sub> - 0.1 V
		5.5	1.5	0.8	0.8	0.8		
V <sub>OH</sub>	Minimum High Level Output Voltage	4.5	4.49	4.4	4.4	4.4	V	I <sub>OUT</sub> = -50 μA
		5.5	5.49	5.4	5.4	5.4		
V <sub>OL</sub>	Maximum Low Level Output Voltage	4.5		3.86	3.76	3.76	V	*V <sub>IN</sub> = V <sub>IL</sub> or V <sub>IH</sub> I <sub>OH</sub> -24 mA
		5.5		4.86	4.76	4.76		
V <sub>OL</sub>	Maximum Low Level Output Voltage	4.5	0.001	0.1	0.1	0.1	V	I <sub>OUT</sub> = 50 μA
		5.5	0.001	0.1	0.1	0.1		
V <sub>OL</sub>	Maximum Low Level Output Voltage	4.5		0.36	0.44	0.44	V	*V <sub>IN</sub> = V <sub>IL</sub> or V <sub>IH</sub> I <sub>OL</sub> 24 mA
		5.5		0.36	0.44	0.44		
I <sub>IN</sub>	Maximum Input Leakage Current	5.5		±0.1	±1.0		μA	V <sub>I</sub> = V <sub>CC</sub> , GND
ΔI <sub>CCT</sub>	Additional Max. I <sub>CC</sub> /Input	5.5	0.6		1.5		mA	V <sub>I</sub> = V <sub>CC</sub> - 2.1 V
I <sub>OZ</sub>	Maximum 3-State Current	5.5		±0.5	±5.0		μA	V <sub>I</sub> (OE) = V <sub>IL</sub> , V <sub>IH</sub> V <sub>I</sub> = V <sub>CC</sub> , GND V <sub>O</sub> = V <sub>CC</sub> , GND
I <sub>OLD</sub> I <sub>OHD</sub>	†Minimum Dynamic Output Current	5.5 5.5			75 -75		mA mA	V <sub>OLD</sub> = 1.65 V Max V <sub>OHD</sub> = 3.85 V Min
I <sub>CC</sub>	Maximum Quiescent Supply Current	5.5		8.0	80		μA	V <sub>IN</sub> = V <sub>CC</sub> or GND

\*All outputs loaded; thresholds on input associated with output under test.

†Maximum test duration 2.0 ms, one output loaded at a time.

## AC CHARACTERISTICS t<sub>r</sub> = t<sub>f</sub> = 3.0 ns (For Figures and Waveforms, See Figures 4, 5, and 6.)

Symbol	Parameter	V <sub>CC</sub> * (V)	T <sub>A</sub> = +25°C C <sub>L</sub> = 50 pF			T <sub>A</sub> = -40°C to +85°C C <sub>L</sub> = 50 pF		Unit
			Min	Typ	Max	Min	Max	
f <sub>max</sub>	Maximum Clock Frequency	5.0	85	-	-	75	-	MHz
t <sub>PLH</sub>	Propagation Delay CP to Q <sub>n</sub>	5.0	2.0	-	10.5	1.5	11.5	ns
t <sub>PHL</sub>	Propagation Delay CP to Q <sub>n</sub>	5.0	1.5	-	9.5	1.5	10.5	ns
t <sub>PZH</sub>	Output Enable Time	5.0	1.5	-	9.0	1.5	9.5	ns
t <sub>PZL</sub>	Output Enable Time	5.0	1.5	-	8.5	1.0	9.5	ns
t <sub>PHZ</sub>	Output Disable Time	5.0	1.5	-	10.5	1.5	11.5	ns
t <sub>PLZ</sub>	Output Disable Time	5.0	1.5	-	8.0	1.0	8.5	ns

\*Voltage Range 5.0 V is 5.0 V ±0.5 V

# MC74ACT564

## AC OPERATING REQUIREMENTS

Symbol	Parameter	$V_{CC}^*$ (V)	$T_A = +25^\circ\text{C}$ $C_L = 50\text{ pF}$		$T_A = -40^\circ\text{C to } +85^\circ\text{C}$ $C_L = 50\text{ pF}$		Unit
			Typ	Guaranteed Minimum			
$t_s$	Setup Time, HIGH or LOW	$D_n$ to $C_P$	5.0	–	2.5	3.0	ns
$t_h$	Hold Time, HIGH or LOW	$D_n$ to $C_P$	5.0	–	1.0	1.0	ns
$t_w$	$C_P$ Pulse Width	HIGH or LOW	5.0	–	3.0	3.5	ns

\*Voltage Range 3.3 V is 3.3 V  $\pm$ 0.3 V.

\*Voltage Range 5.0 V is 5.0 V  $\pm$ 0.5 V.

## CAPACITANCE

Symbol	Parameter	Value Typ	Unit	Test Conditions
$C_{IN}$	Input Capacitance	4.5	pF	$V_{CC} = 5.0\text{ V}$
$C_{PD}$	Power Dissipation Capacitance	50	pF	$V_{CC} = 5.0\text{ V}$

## ORDERING INFORMATION

Device	Package	Shipping <sup>†</sup>
MC74ACT564N	PDIP–20	18 Units / Rail
MC74ACT564NG	PDIP–20 (Pb–Free)	
MC74ACT564DWR2	SOIC–20	1000 / Tape & Reel
MC74ACT564DWR2G	SOIC–20 (Pb–Free)	

<sup>†</sup>For information on tape and reel specifications, including part orientation and tape sizes, please refer to our Tape and Reel Packaging Specifications Brochure, BRD8011/D.

## MARKING DIAGRAMS

PDIP–20



SOIC–20W

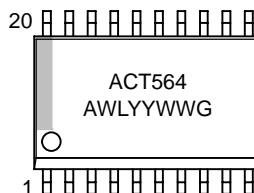

A = Assembly Location  
 WL = Wafer Lot  
 YY = Year  
 WW = Work Week  
 G = Pb–Free Package

SWITCHING WAVEFORMS

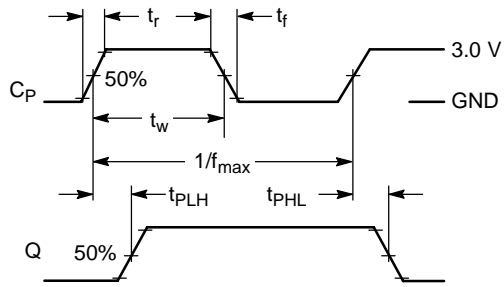

Figure 4.

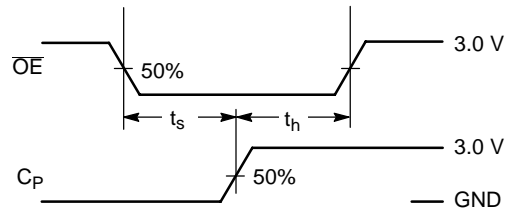

Figure 5.

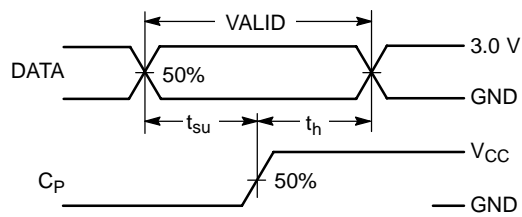
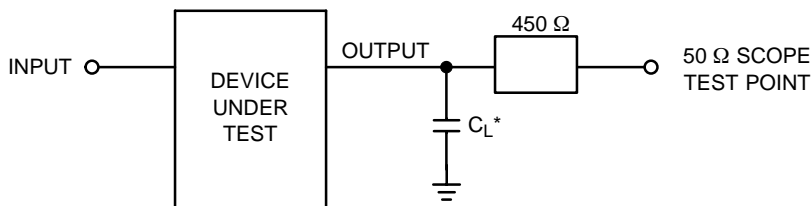

Figure 6.



\*Includes all probe and jig capacitance

Figure 7. Test Circuit

# MC74ACT564

## PACKAGE DIMENSIONS

PDIP-20  
 N SUFFIX  
 PLASTIC DIP PACKAGE  
 CASE 738-03  
 ISSUE E

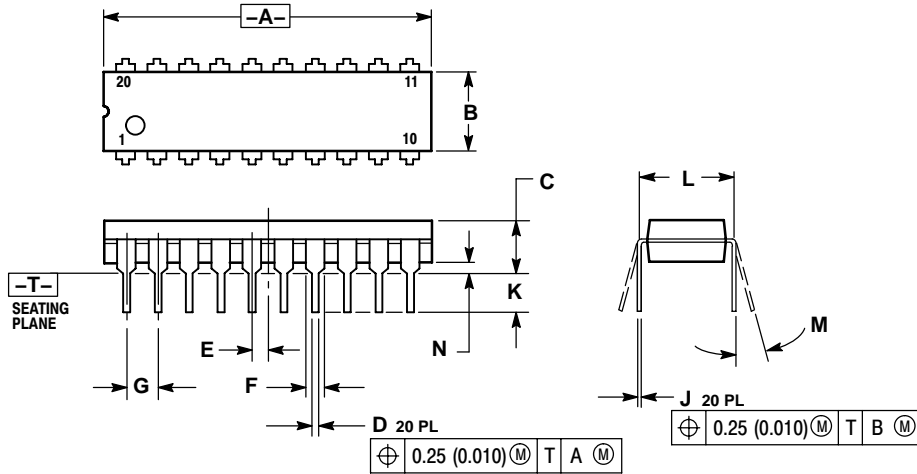

- NOTES:
1. DIMENSIONING AND TOLERANCING PER ANSI Y14.5M, 1982.
  2. CONTROLLING DIMENSION: INCH.
  3. DIMENSION L TO CENTER OF LEAD WHEN FORMED PARALLEL.
  4. DIMENSION B DOES NOT INCLUDE MOLD FLASH.

DIM	INCHES		MILLIMETERS	
	MIN	MAX	MIN	MAX
A	1.010	1.070	25.66	27.17
B	0.240	0.260	6.10	6.60
C	0.150	0.180	3.81	4.57
D	0.015	0.022	0.39	0.55
E	0.050 BSC		1.27 BSC	
F	0.050	0.070	1.27	1.77
G	0.100 BSC		2.54 BSC	
J	0.008	0.015	0.21	0.38
K	0.110	0.140	2.80	3.55
L	0.300 BSC		7.62 BSC	
M	0°	15°	0°	15°
N	0.020	0.040	0.51	1.01

# MC74ACT564

## PACKAGE DIMENSIONS

SOIC-20W  
DW SUFFIX  
CASE 751D-05  
ISSUE G

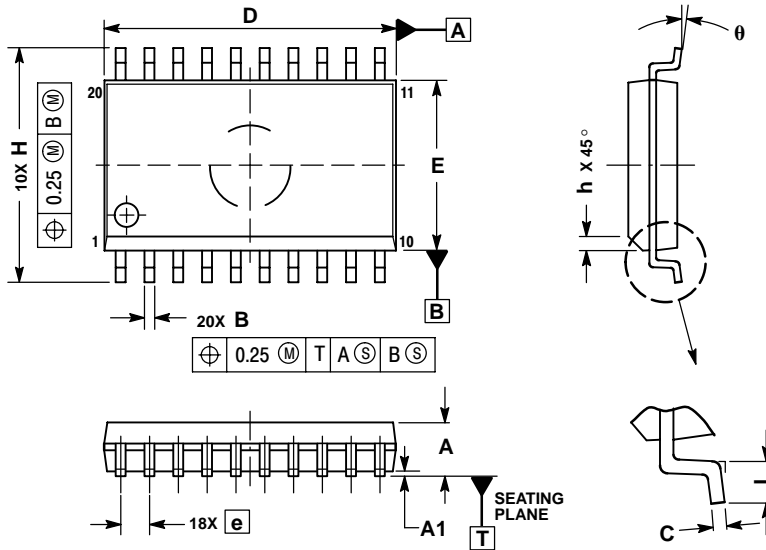

### NOTES:

1. DIMENSIONS ARE IN MILLIMETERS.
2. INTERPRET DIMENSIONS AND TOLERANCES PER ASME Y14.5M, 1994.
3. DIMENSIONS D AND E DO NOT INCLUDE MOLD PROTRUSION.
4. MAXIMUM MOLD PROTRUSION 0.15 PER SIDE.
5. DIMENSION B DOES NOT INCLUDE DAMBAR PROTRUSION. ALLOWABLE PROTRUSION SHALL BE 0.13 TOTAL IN EXCESS OF B DIMENSION AT MAXIMUM MATERIAL CONDITION.

DIM	MILLIMETERS	
	MIN	MAX
A	2.35	2.65
A1	0.10	0.25
B	0.35	0.49
C	0.23	0.32
D	12.65	12.95
E	7.40	7.60
e	1.27 BSC	
H	10.05	10.55
h	0.25	0.75
L	0.50	0.90
θ	0°	7°

ON Semiconductor and are registered trademarks of Semiconductor Components Industries, LLC (SCILLC). SCILLC reserves the right to make changes without further notice to any products herein. SCILLC makes no warranty, representation or guarantee regarding the suitability of its products for any particular purpose, nor does SCILLC assume any liability arising out of the application or use of any product or circuit, and specifically disclaims any and all liability, including without limitation special, consequential or incidental damages. "Typical" parameters which may be provided in SCILLC data sheets and/or specifications can and do vary in different applications and actual performance may vary over time. All operating parameters, including "Typicals" must be validated for each customer application by customer's technical experts. SCILLC does not convey any license under its patent rights nor the rights of others. SCILLC products are not designed, intended, or authorized for use as components in systems intended for surgical implant into the body, or other applications intended to support or sustain life, or for any other application in which the failure of the SCILLC product could create a situation where personal injury or death may occur. Should Buyer purchase or use SCILLC products for any such unintended or unauthorized application, Buyer shall indemnify and hold SCILLC and its officers, employees, subsidiaries, affiliates, and distributors harmless against all claims, costs, damages, and expenses, and reasonable attorney fees arising out of, directly or indirectly, any claim of personal injury or death associated with such unintended or unauthorized use, even if such claim alleges that SCILLC was negligent regarding the design or manufacture of the part. SCILLC is an Equal Opportunity/Affirmative Action Employer. This literature is subject to all applicable copyright laws and is not for resale in any manner.

### PUBLICATION ORDERING INFORMATION

**LITERATURE FULFILLMENT:**  
Literature Distribution Center for ON Semiconductor  
P.O. Box 5163, Denver, Colorado 80217 USA  
**Phone:** 303-675-2175 or 800-344-3860 Toll Free USA/Canada  
**Fax:** 303-675-2176 or 800-344-3867 Toll Free USA/Canada  
**Email:** orderlit@onsemi.com

**N. American Technical Support:** 800-282-9855 Toll Free USA/Canada  
**Europe, Middle East and Africa Technical Support:**  
Phone: 421 33 790 2910  
**Japan Customer Focus Center**  
Phone: 81-3-5773-3850

**ON Semiconductor Website:** [www.onsemi.com](http://www.onsemi.com)  
**Order Literature:** <http://www.onsemi.com/orderlit>

For additional information, please contact your local Sales Representative





Компания «ЭлектроПласт» предлагает заключение долгосрочных отношений при поставках импортных электронных компонентов на взаимовыгодных условиях!

Наши преимущества:

- Оперативные поставки широкого спектра электронных компонентов отечественного и импортного производства напрямую от производителей и с крупнейших мировых складов;
- Поставка более 17-ти миллионов наименований электронных компонентов;
- Поставка сложных, дефицитных, либо снятых с производства позиций;
- Оперативные сроки поставки под заказ (от 5 рабочих дней);
- Экспресс доставка в любую точку России;
- Техническая поддержка проекта, помощь в подборе аналогов, поставка прототипов;
- Система менеджмента качества сертифицирована по Международному стандарту ISO 9001;
- Лицензия ФСБ на осуществление работ с использованием сведений, составляющих государственную тайну;
- Поставка специализированных компонентов (Xilinx, Altera, Analog Devices, Intersil, Interpoint, Microsemi, Aeroflex, Peregrine, Syfer, Eurofarad, Texas Instrument, Miteq, Cobham, E2V, MA-COM, Hittite, Mini-Circuits, General Dynamics и др.);

Помимо этого, одним из направлений компании «ЭлектроПласт» является направление «Источники питания». Мы предлагаем Вам помощь Конструкторского отдела:

- Подбор оптимального решения, техническое обоснование при выборе компонента;
- Подбор аналогов;
- Консультации по применению компонента;
- Поставка образцов и прототипов;
- Техническая поддержка проекта;
- Защита от снятия компонента с производства.



#### Как с нами связаться

**Телефон:** 8 (812) 309 58 32 (многоканальный)

**Факс:** 8 (812) 320-02-42

**Электронная почта:** [org@eplast1.ru](mailto:org@eplast1.ru)

**Адрес:** 198099, г. Санкт-Петербург, ул. Калинина, дом 2, корпус 4, литера А.