

Part Number: DF3CGKD

Green

### Features

- Uniform light emitting area.
- Easily mounted on P.C. boards or industry standard sockets.
- Flush mountable.
- Excellent on / off contrast.
- Can be used with panels and legend mounts.
- Mechanically rugged.
- RoHS compliant.

### Description

The Green source color devices are made with AlGaInP on GaAs substrate Light Emitting Diode.

### Package Dimensions & Internal Circuit Diagram

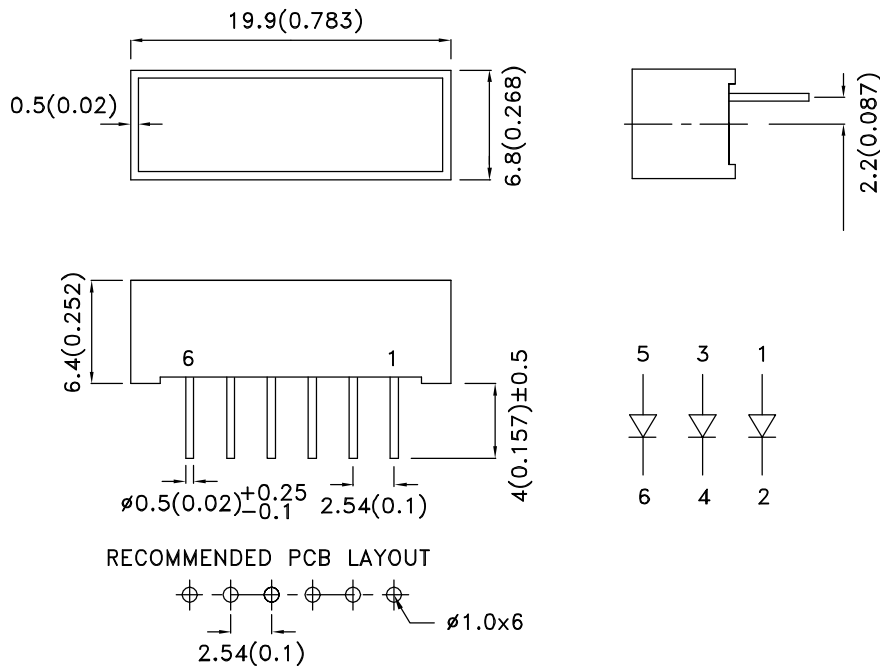

Notes:

1. All dimensions are in millimeters (inches), Tolerance is ±0.25(0.01") unless otherwise noted.
2. The specifications, characteristics and technical data described in the datasheet are subject to change without prior notice.



## Selection Guide

Part No.	Dice	Lens Type	Iv (mcd) [1] @ 20mA	
			Min.	Typ.
DF3CGKD	Green (AlGaInP)	Green Diffused	120	270
			*55	*94

Notes:

- Luminous intensity / Luminous Flux: +/-15%.
- \* Luminous intensity value is traceable to the CIE127-2007 compliant national standards.

## Electrical / Optical Characteristics at TA=25°C

Symbol	Parameter	Device	Typ.	Max.	Units	Test Conditions
$\lambda_{peak}$	Peak Wavelength	Green	574		nm	I <sub>F</sub> =20mA
$\lambda_D$ [1]	Dominant Wavelength	Green	570		nm	I <sub>F</sub> =20mA
$\Delta\lambda_{1/2}$	Spectral Line Half-width	Green	20		nm	I <sub>F</sub> =20mA
C	Capacitance	Green	15		pF	V <sub>F</sub> =0V;f=1MHz
V <sub>F</sub> [2]	Forward Voltage	Green	2.1	2.5	V	I <sub>F</sub> =20mA
I <sub>R</sub>	Reverse Current	Green		10	uA	V <sub>R</sub> =5V

Notes:

- Wavelength: +/-1nm.
- Forward Voltage: +/-0.1V.
- Wavelength value is traceable to the CIE127-2007 compliant national standards.
- Excess driving current and/or operating temperature higher than recommended conditions may result in severe light degradation or premature failure.

## Absolute Maximum Ratings at TA=25°C

Parameter	Green	Units
Power dissipation	75	mW
DC Forward Current	30	mA
Peak Forward Current [1]	150	mA
Reverse Voltage	5	V
Operating / Storage Temperature	-40°C To +85°C	
Lead Solder Temperature[2]	260°C For 3-5 Seconds	

Notes:

- 1/10 Duty Cycle, 0.1ms Pulse Width.
- 2mm below package base.

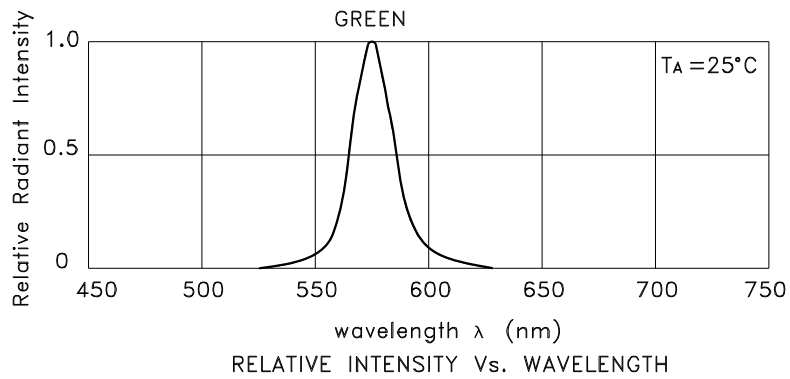

**Green**

**DF3CGKD**

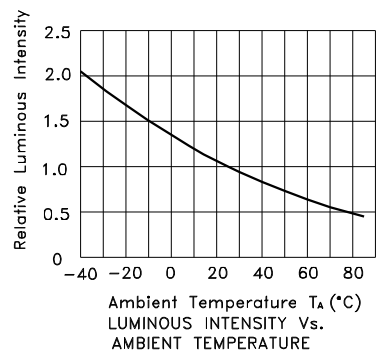
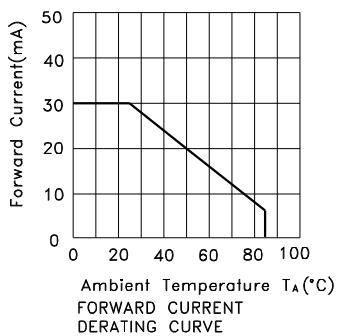
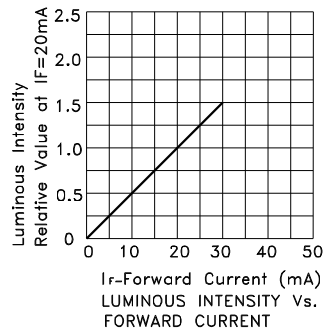
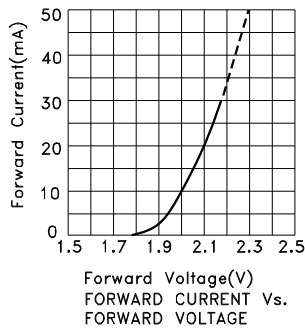

## PACKING & LABEL SPECIFICATIONS

## DF3CGKD

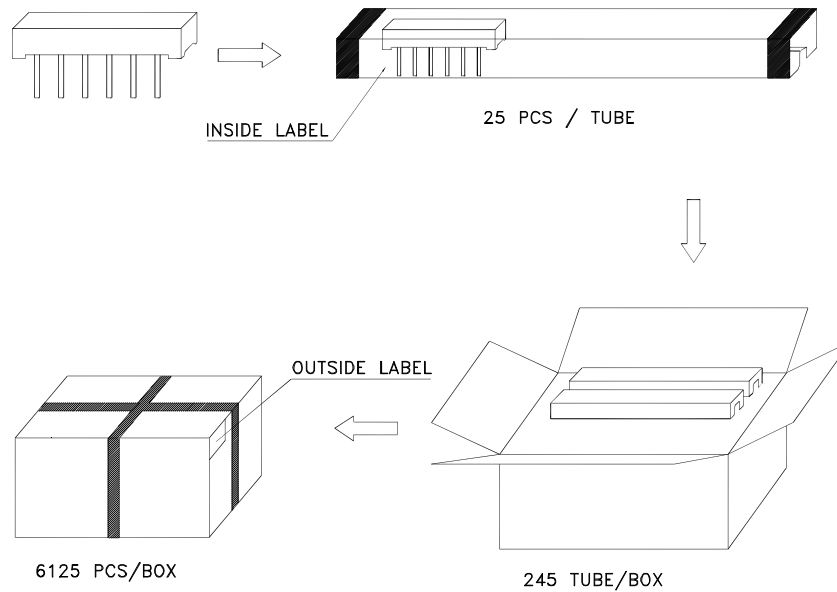

Inside Label On IC-TUBE

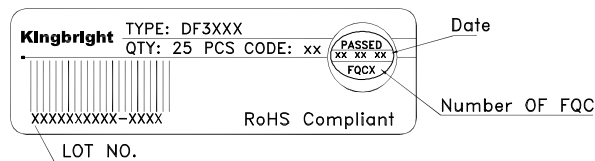

Outside Label On Box

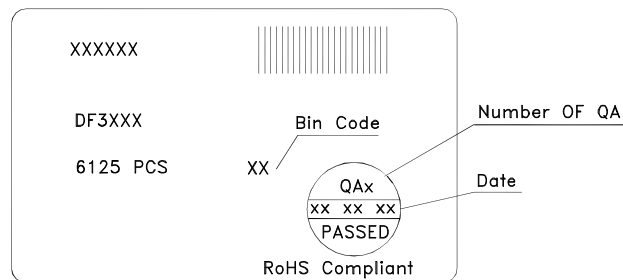

### Terms and conditions for the usage of this document

1. The information included in this document reflects representative usage scenarios and is intended for technical reference only.
2. The part number, type, and specifications mentioned in this document are subject to future change and improvement without notice. Before production usage customer should refer to the latest datasheet for the updated specifications.
3. When using the products referenced in this document, please make sure the product is being operated within the environmental and electrical limits specified in the datasheet. If customer usage exceeds the specified limits, Kingbright will not be responsible for any subsequent issues.
4. The information in this document applies to typical usage in consumer electronics applications. If customer's application has special reliability requirements or have life-threatening liabilities, such as automotive or medical usage, please consult with Kingbright representative for further assistance.
5. The contents and information of this document may not be reproduced or re-transmitted without permission by Kingbright.
6. All design applications should refer to Kingbright application notes available at <http://www.KingbrightUSA.com/ApplicationNotes>

## THROUGH HOLE DISPLAY MOUNTING METHOD

### Lead Forming

Do not bend the component leads by hand without proper tools.  
The leads should be bent by clinching the upper part of the lead firmly such that the bending force is not exerted on the plastic body.

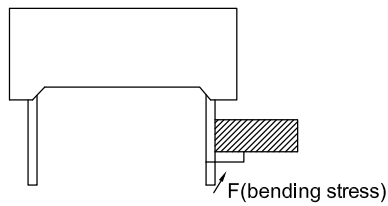

Not Recommended

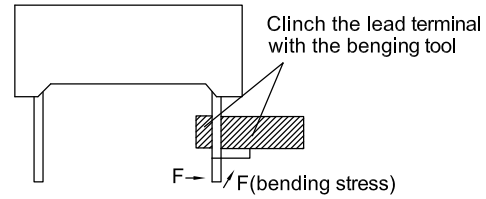

Recommended

### Installation

- 1.The installation process should not apply stress to the lead terminals.
- 2.When inserting for assembly, ensure the terminal pitch matches the substrate board's hole pitch to prevent spreading or pinching the lead terminals.

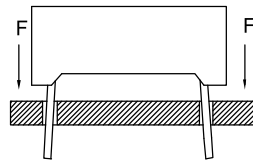

Not Recommended

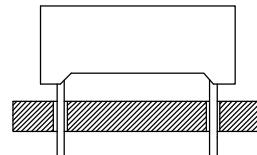

Recommended

- 3.The component shall be placed at least 5mm from edge of PCB to avoid damage caused excessive heat during wave soldering.



Not Recommended



Recommended

## Recommended Wave Soldering Profiles:

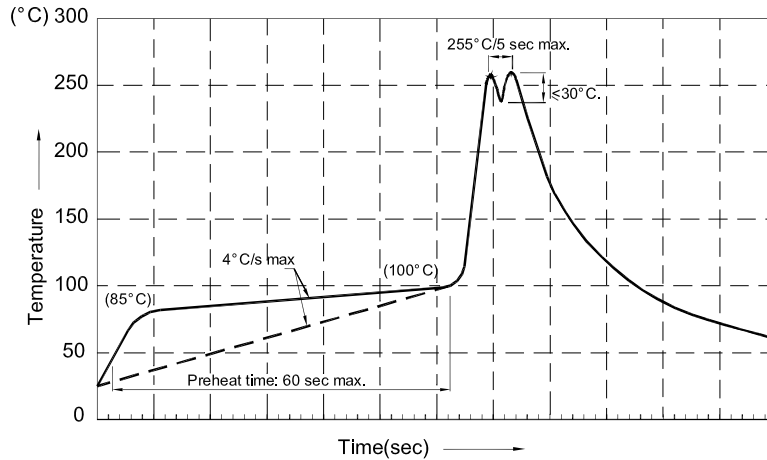

### Notes:

1. Recommend pre-heat temperature of 105° C or less (as measured with a thermocouple attached to the LED pins) prior to immersion in the solder wave with a maximum solder bath temperature of 260° C
2. Peak wave soldering temperature between 245° C ~ 255° C for 3 sec (5 sec max).
3. Do not apply stress to the epoxy resin while the temperature is above 85° C.
4. Fixtures should not incur stress on the component when mounting and during soldering process.
5. SAC 305 solder alloy is recommended.
6. No more than one wave soldering pass.
7. During wave soldering, the PCB top-surface temperature should be kept below 105° C.

### Soldering General Notes:

1. Through-hole displays are incompatible with reflow soldering.
2. If components will undergo multiple soldering processes, or other processes where the components may be subjected to intense heat, please check with Kingbright for compatibility.

### CLEANING

1. Mild "no-clean" fluxes are recommended for use in soldering.
2. If cleaning is required, Kingbright recommends to wash components with water only. Do not use harsh organic solvents for cleaning because they may damage the plastic parts .
3. The cleaning process should take place at room temperature and the devices should not be washed for more than one minute.
4. When water is used in the cleaning process, immediately remove excess moisture from the component with forced-air drying afterwards.

### CIRCUIT DESIGN NOTES

1. Protective current-limiting resistors may be necessary to operate the LEDs within the specified range.
2. LEDs mounted in parallel should each be placed in series with its own current-limiting resistor.



3. The driving circuit should be designed to protect the LED against reverse voltages and transient voltage spikes when the circuit is powered up or shut down.
4. The safe operating current should be chosen after considering the maximum ambient temperature of the operating environment.
5. Prolonged reverse bias should be avoided, as it could cause metal migration, leading to an increase in leakage current or causing a short circuit.



Компания «ЭлектроПласт» предлагает заключение долгосрочных отношений при поставках импортных электронных компонентов на взаимовыгодных условиях!

Наши преимущества:

- Оперативные поставки широкого спектра электронных компонентов отечественного и импортного производства напрямую от производителей и с крупнейших мировых складов;
- Поставка более 17-ти миллионов наименований электронных компонентов;
- Поставка сложных, дефицитных, либо снятых с производства позиций;
- Оперативные сроки поставки под заказ (от 5 рабочих дней);
- Экспресс доставка в любую точку России;
- Техническая поддержка проекта, помощь в подборе аналогов, поставка прототипов;
- Система менеджмента качества сертифицирована по Международному стандарту ISO 9001;
- Лицензия ФСБ на осуществление работ с использованием сведений, составляющих государственную тайну;
- Поставка специализированных компонентов (Xilinx, Altera, Analog Devices, Intersil, Interpoint, Microsemi, Aeroflex, Peregrine, Syfer, Eurofarad, Texas Instrument, Miteq, Cobham, E2V, MA-COM, Hittite, Mini-Circuits, General Dynamics и др.);

Помимо этого, одним из направлений компании «ЭлектроПласт» является направление «Источники питания». Мы предлагаем Вам помощь Конструкторского отдела:

- Подбор оптимального решения, техническое обоснование при выборе компонента;
- Подбор аналогов;
- Консультации по применению компонента;
- Поставка образцов и прототипов;
- Техническая поддержка проекта;
- Защита от снятия компонента с производства.



#### Как с нами связаться

**Телефон:** 8 (812) 309 58 32 (многоканальный)

**Факс:** 8 (812) 320-02-42

**Электронная почта:** [org@eplast1.ru](mailto:org@eplast1.ru)

**Адрес:** 198099, г. Санкт-Петербург, ул. Калинина, дом 2, корпус 4, литера А.