

AA4040P3C-P22 Phototransistor

DESCRIPTION

- Made with NPN silicon phototransistor chips

FEATURES

- Mechanically and spectrally matched to infrared emitting LED lamp
- Package: 500 pcs / reel
- Moisture sensitivity level: 4
- RoHS compliant

APPLICATIONS

- Infrared applied systems
- Optoelectronic switches
- Photodetector control circuits
- Sensor technology

PACKAGE DIMENSIONS

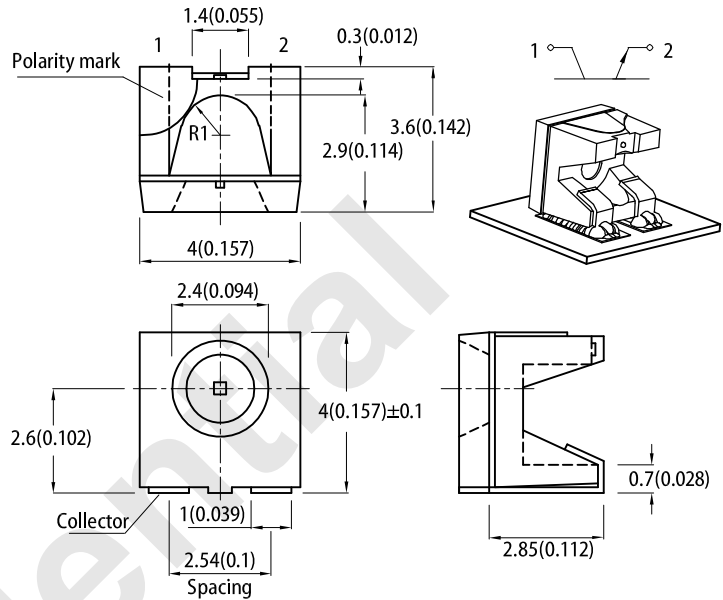

RECOMMENDED SOLDERING PATTERN

(units : mm; tolerance : ± 0.1)

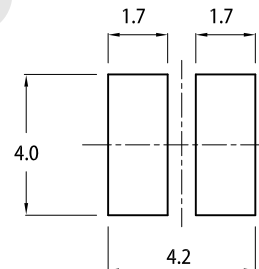

Notes:

- All dimensions are in millimeters (inches).
- Tolerance is $\pm 0.25(0.01)$ unless otherwise noted.
- The specifications, characteristics and technical data described in the datasheet are subject to change without prior notice.
- The device has a single mounting surface. The device must be mounted according to the specifications.

ABSOLUTE MAXIMUM RATINGS at $T_A=25^\circ\text{C}$

Parameter	Max.Ratings	Units
Collector-to-Emitter Voltage	30	V
Emitter-to-Collector Voltage	5	V
Power Dissipation at(or below) 25°C Free Air Temperature	100	mW
Operating Temperature	-40 to +85	$^\circ\text{C}$
Storage Temperature	-40 to +85	$^\circ\text{C}$

Note:

- Relative humidity levels maintained between 40% and 60% in production area are recommended to avoid the build-up of static electricity – Ref JEDEC/JESD625-A and JEDEC/J-STD-033.

ELECTRICAL / OPTICAL CHARACTERISTICS at $T_A=25^\circ\text{C}$

Parameter	Symbol	Min.	Typ.	Max.	Units	Test Conditions
Collector-to-Emitter Breakdown Voltage	$V_{BR\ CE0}$	30	-	-	V	$I_C = 100\mu\text{A}$ $E_e = 0\text{mW/cm}^2$
Emitter-to-Collector Breakdown Voltage	$V_{BR\ ECO}$	5	-	-	V	$I_E = 100\mu\text{A}$ $E_e = 0\text{mW/cm}^2$
Collector-to-Emitter Saturation Voltage	$V_{CE(SAT)}$	-	-	0.8	V	$I_C = 2\text{mA}$ $E_e = 20\text{mW/cm}^2$
Collector Dark Current	I_{CEO}	-	-	100	nA	$V_{CE} = 10\text{V}$ $E_e = 0\text{mW/cm}^2$
Rise Time(10% to 90%)	T_R	-	15	-	μS	$V_{CE} = 5\text{V}$ $I_C = 1\text{mA}$ $R_L = 1000\Omega$
Fall Time(90% to 10%)	T_F	-	15	-	μS	
On State Collector Current	$I_{(ON)}$	0.35	0.6	-	mA	$V_{CE} = 5\text{V}$ $E_e = 1\text{mW/cm}^2$ $\lambda = 940\text{nm}$
Range of spectral bandwidth	$\lambda_{0.1}$	420	-	1120	nm	-
Wavelength of peak Sensitivity	λ_p	-	940	-	nm	-
Angle of half sensitivity	$2\theta_{1/2}$	-	120	-	deg	-

TECHNICAL DATA

RELATIVE SPECTRAL SENSITIVITY vs. WAVELENGTH

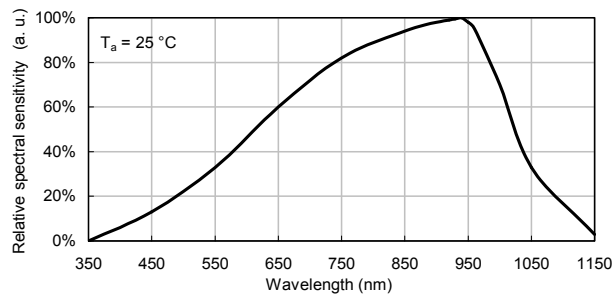

RELATIVE RADIANT SENSITIVITY vs. ANGULAR DISPLACEMENT

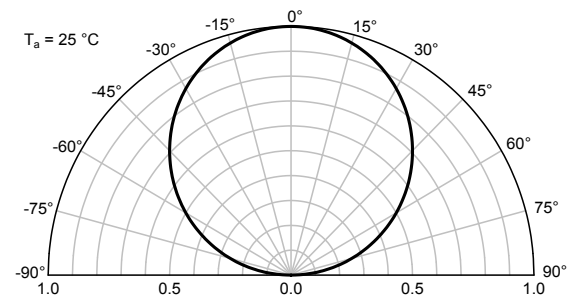

TECHNICAL DATA

PHOTOTRANSISTOR

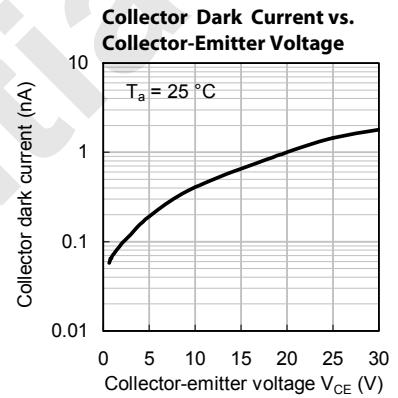
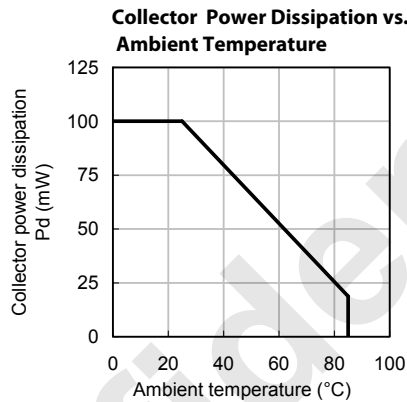
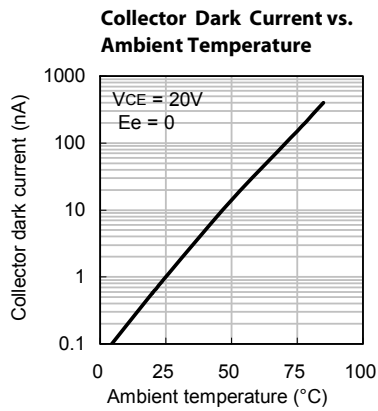
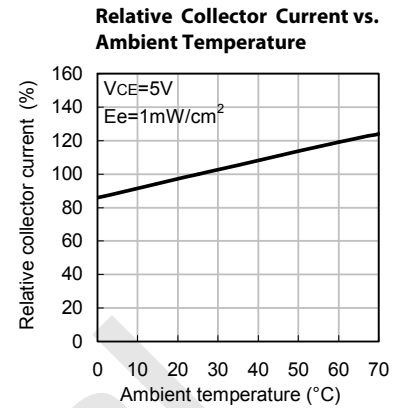
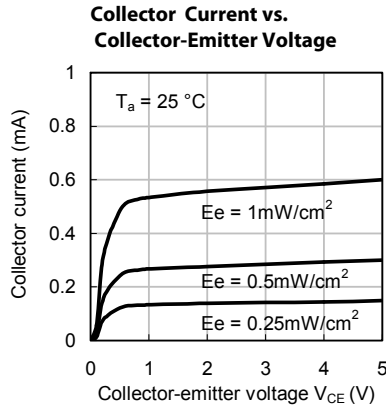
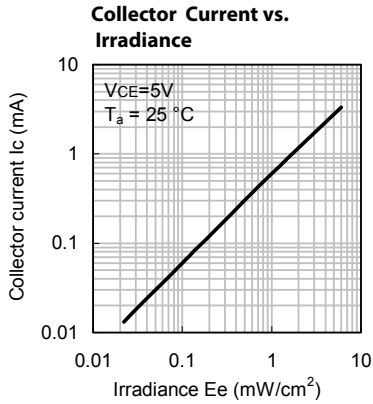

REFLOW SOLDERING PROFILE for LEAD-FREE SMD PROCESS

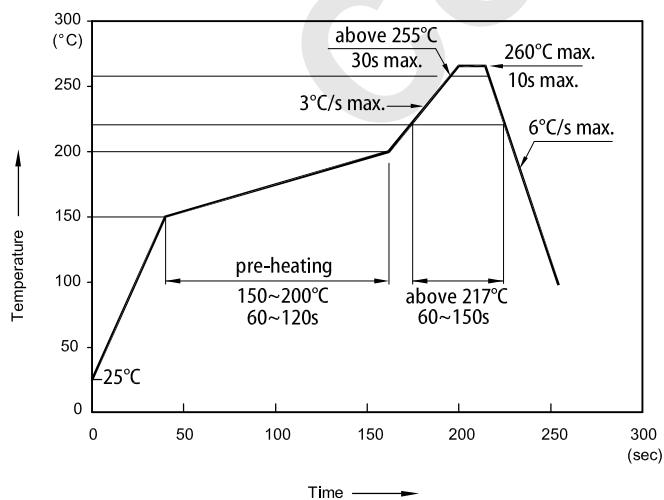

- Notes:
1. Don't cause stress to the LEDs while it is exposed to high temperature.
 2. The maximum number of reflow soldering passes is 2 times.
 3. Reflow soldering is recommended. Other soldering methods are not recommended as they might cause damage to the product.

TAPE SPECIFICATIONS (units : mm)

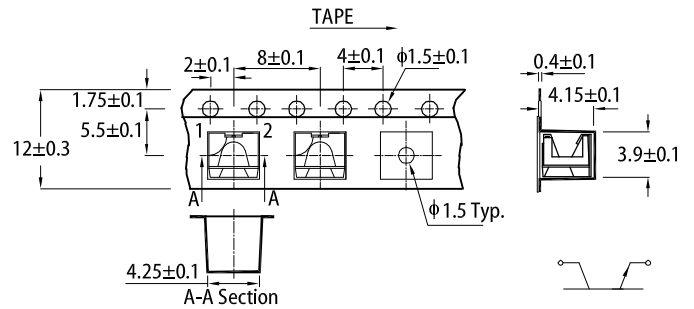

REEL DIMENSION (units : mm)

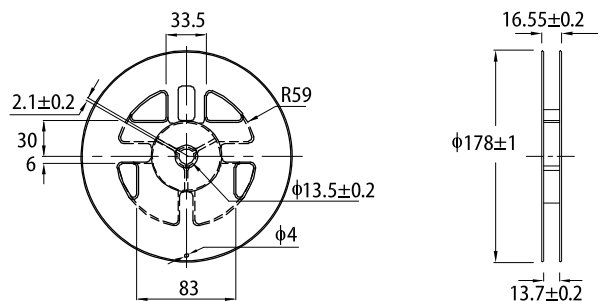

PACKING & LABEL SPECIFICATIONS

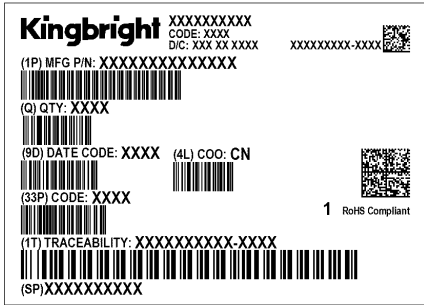
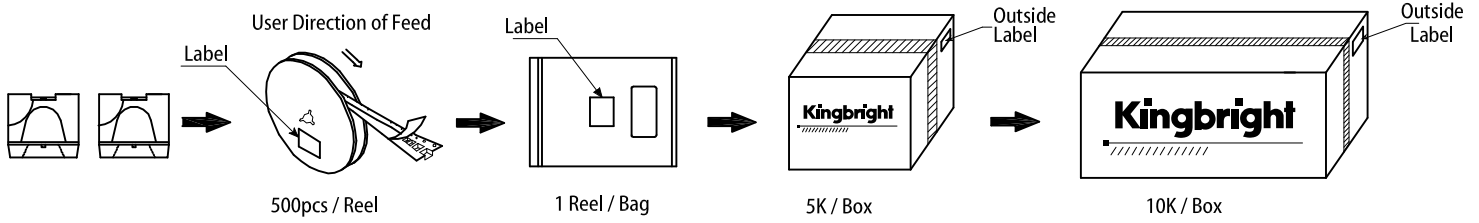

Confidential

PRECAUTIONARY NOTES

1. The information included in this document reflects representative usage scenarios and is intended for technical reference only.
2. The part number, type, and specifications mentioned in this document are subject to future change and improvement without notice. Before production usage customer should refer to the latest datasheet for the updated specifications.
3. When using the products referenced in this document, please make sure the product is being operated within the environmental and electrical limits specified in the datasheet. If customer usage exceeds the specified limits, Kingbright will not be responsible for any subsequent issues.
4. The information in this document applies to typical usage in consumer electronics applications. If customer's application has special reliability requirements or have life-threatening liabilities, such as automotive or medical usage, please consult with Kingbright representative for further assistance.
5. The contents and information of this document may not be reproduced or re-transmitted without permission by Kingbright.
6. All design applications should refer to Kingbright application notes available at <https://www.KingbrightUSA.com/ApplicationNotes>



Компания «ЭлектроПласт» предлагает заключение долгосрочных отношений при поставках импортных электронных компонентов на взаимовыгодных условиях!

Наши преимущества:

- Оперативные поставки широкого спектра электронных компонентов отечественного и импортного производства напрямую от производителей и с крупнейших мировых складов;
- Поставка более 17-ти миллионов наименований электронных компонентов;
- Поставка сложных, дефицитных, либо снятых с производства позиций;
- Оперативные сроки поставки под заказ (от 5 рабочих дней);
- Экспресс доставка в любую точку России;
- Техническая поддержка проекта, помощь в подборе аналогов, поставка прототипов;
- Система менеджмента качества сертифицирована по Международному стандарту ISO 9001;
- Лицензия ФСБ на осуществление работ с использованием сведений, составляющих государственную тайну;
- Поставка специализированных компонентов (Xilinx, Altera, Analog Devices, Intersil, Interpoint, Microsemi, Aeroflex, Peregrine, Syfer, Eurofarad, Texas Instrument, Miteq, Cobham, E2V, MA-COM, Hittite, Mini-Circuits, General Dynamics и др.);

Помимо этого, одним из направлений компании «ЭлектроПласт» является направление «Источники питания». Мы предлагаем Вам помощь Конструкторского отдела:

- Подбор оптимального решения, техническое обоснование при выборе компонента;
- Подбор аналогов;
- Консультации по применению компонента;
- Поставка образцов и прототипов;
- Техническая поддержка проекта;
- Защита от снятия компонента с производства.



Как с нами связаться

Телефон: 8 (812) 309 58 32 (многоканальный)

Факс: 8 (812) 320-02-42

Электронная почта: org@eplast1.ru

Адрес: 198099, г. Санкт-Петербург, ул. Калинина, дом 2, корпус 4, литера А.