

ISL8117EVAL2Z

Evaluation Board User Guide

UG020  
Rev 0.00  
March 17, 2015

**Description**

The ISL8117EVAL2Z evaluation board (shown in [Figure 1](#)) features the [ISL8117](#). The ISL8117 is a 60V high voltage synchronous buck controller that offers external soft-start, independent enable functions and integrates UV/OV/OC/OT protection. Its current mode control architecture and internal compensation network keep peripheral component count minimal. Programmable switching frequency ranging from 200kHz to 2MHz helps to optimize inductor size while the strong gate driver delivers up to 30A for the buck output.

**Specifications**

The ISL8117EVAL2Z evaluation board is designed for high current applications. The current rating of the ISL8117EVAL2Z is limited by the FETs and inductor selected. The ISL8117 gate driver is capable of delivering up to 20A for the buck output as long as the proper FETs and inductor are provided. The electrical ratings of ISL8117EVAL2Z are shown in [Table 1](#).

TABLE 1. ELECTRICAL RATING

PARAMETER	RATING
Input Voltage	18V to 60V
Switching Frequency	300kHz
Output Voltage	12V
Output Current	20A
OCP Set Point	Minimum 25A at ambient room temperature

**Key Features**

- Wide input range: 18V to 60V
- High light-load efficiency in pulse skipping DEM operation
- Programmable soft-start
- Optional DEM/CCM operation
- Supports prebias output with SR soft-start
- External frequency sync
- PGOOD indicator
- OCP, OVP, OTP, UVP protection
- Back biased from output to improve efficiency

**References**

[ISL8117](#) Datasheet

**Ordering Information**

PART NUMBER	DESCRIPTION
ISL8117EVAL2Z	High Voltage PWM Step-down Synchronous Buck Controller Evaluation Board

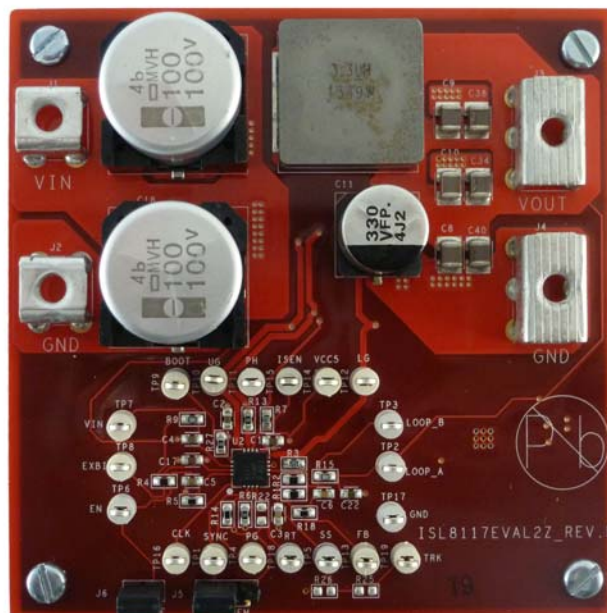

FIGURE 1. ISL8117EVAL2Z TOP SIDE

## Recommended Testing Equipment

The following materials are recommended to perform testing:

- 0V to 60V power supply with at least 30A source current capability
- Electronic loads capable of sinking current up to 30A
- Digital Multimeters (DMMs)
- 100MHz quad-trace oscilloscope

## Quick Test Guide

1. Jumper J5 provides the option to select CCM or DEM. Please refer to [Table 2](#) for the desired operating option. Ensure that the circuit is correctly connected to the supply and electronic loads prior to applying any power. Please refer to [Figure 3](#) for proper set-up.
2. Turn on the power supply.
3. Adjust input voltage  $V_{IN}$  within the specified range and observe output voltage. The output voltage variation should be within 3%.
4. Adjust load current within the specified range and observe output voltage. The output voltage variation should be within 3%.
5. Use an oscilloscope to observe output voltage ripple and Phase node ringing. For accurate measurement, please refer to [Figure 2](#) for proper test set-up.

TABLE 2. DESIRED OPERATING OPTIONS

JUMPER #	POSITION	FUNCTION
J5	CCM (Pin 1-2)	Continuous current mode
	DEM (Pin 2-3)	Diode emulation mode
J6	(Pin 1-2)	Disable the PWM

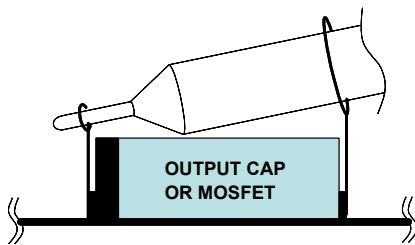

FIGURE 2. PROPER PROBE SET-UP TO MEASURE OUTPUT RIPPLE AND PHASE NODE RINGING

## Functional Description

The ISL8117EVAL2Z is the same test board used by the Intersil application engineers and IC designers to evaluate the performance of the ISL8117 QFN IC. The board is set to provide an easy and complete evaluation of all the IC and board functions.

As shown in [Figure 3 on page 3](#), 18V to 60V  $V_{IN}$  is supplied to J1 (+) and J2 (-). The regulated 12V output on J3 (+) and J4 (-) can supply up to 20A to the load. Due to the high thermal efficiency, the evaluation board can run at 20A continuously without airflow under room temperature ambient conditions.

Test points TP1 through TP19 provide easy access to IC pin and external signal injection terminals.

As shown in [Table 2](#), connector J5 provides selection of either CCM mode (shorting pin 1 and pin 2) or DEM mode (shorting pin 2 and pin 3). Connector J6 provides an option to disable the converter by shorting its pin 1 and 2.

## Operating Range

The input voltage range is from 18V to 60V for an output voltage of 12V. If the output voltage is set to a lower value, the minimum  $V_{IN}$  can be reset to a lower value by changing the ratio of  $R_4$  and  $R_5$ . The minimum EN threshold that  $V_{IN}$  can be set to is 4.5V.

The rated load current is 20A with the OCP point set at minimum 25A at room ambient condition.

The operating temperature range is from  $-40^{\circ}\text{C}$  to  $+125^{\circ}\text{C}$ . Please note that airflow is needed for higher temperature ambient conditions.

## PCB Layout Guideline

Careful attention to layout requirements is necessary for successful implementation of an ISL8117 based DC/DC converter. The ISL8117 switches at a very high frequency and therefore the switching times are very short. At these switching frequencies, even the shortest trace has significant impedance. Also, the peak gate drive current rises significantly in an extremely short time. Transition speed of the current from one device to another causes voltage spikes across the interconnecting impedances and parasitic circuit elements. These voltage spikes can degrade efficiency, generate EMI, and increase device overvoltage stress and ringing. Careful component selection and proper PC board layout minimizes the magnitude of these voltage spikes.

There are three sets of critical components in a DC/DC converter using the ISL8117: the controller, the switching power components and the small signal components. The switching power components are the most critical from a layout point of view because they switch a large amount of energy, which tends to generate a large amount of noise. The critical small signal components are those connected to sensitive nodes or those supplying critical bias currents. A multilayer printed circuit board is recommended.

## Layout Considerations

1. The input capacitors, upper FET, lower FET, inductor and output capacitor should be placed first. Isolate these power components on the top side of the board with their ground terminals adjacent to one another. Place the input high frequency decoupling ceramic capacitors very close to the MOSFETs.
2. Use separate ground planes for power ground and small signal ground. Connect the SGND and PGND together close to the IC. DO NOT connect them together anywhere else.
3. The loop formed by the input capacitor, the top FET and the bottom FET must be kept as small as possible.
4. Ensure the current paths from the input capacitor to the MOSFET, to the output inductor and the output capacitor are as short as possible with maximum allowable trace widths.
5. Place the PWM controller IC close to the lower FET. The LGATE connection should be short and wide. The IC can be best placed over a quiet ground area. Avoid switching ground loop currents in this area.
6. Place VCC5V bypass capacitor very close to the VCC5V pin of the IC and connect its ground to the PGND plane.
7. Place the gate drive components (optional BOOT diode and BOOT capacitors) together near the controller IC.
8. The output capacitors should be placed as close to the load as possible. Use short wide copper regions to connect output capacitors to load in order to avoid inductance and resistances.
9. Use copper filled polygons or wide but short trace to connect the junction of the upper FET, lower FET and output inductor. Also keep the PHASE node connection to the IC short. DO NOT unnecessarily oversize the copper islands for the PHASE node. Since the phase nodes are subjected to very high dv/dt voltages, the stray capacitor formed between these islands and the surrounding circuitry will tend to couple switching noise.
10. Route all high speed switching nodes away from the control circuitry.
11. Create a separate small analog ground plane near the IC. Connect the SGND pin to this plane. All small signal grounding paths including feedback resistors, current limit setting resistor, soft-starting capacitor and EN pull-down resistors should be connected to this SGND plane.
12. Separate the current sensing trace from the PHASE node connection.
13. Ensure the feedback connection to the output capacitor is short and direct.

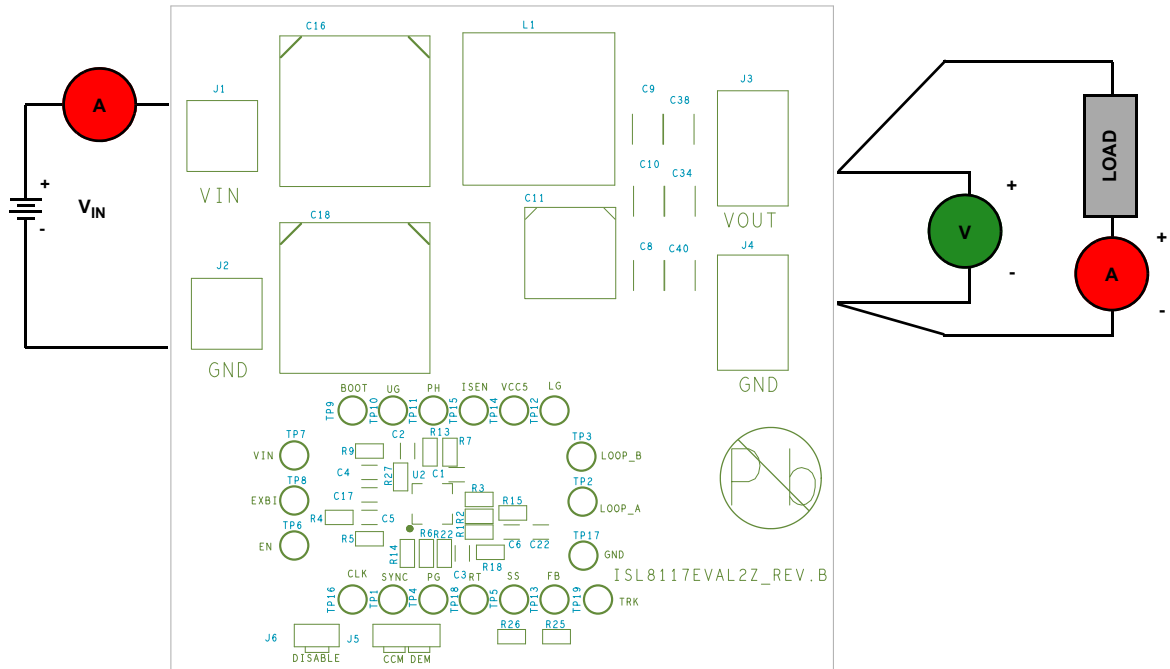

FIGURE 3. PROPER TEST SET-UP

# Typical Evaluation Board Performance Curves $V_{IN} = 48V$ , unless otherwise noted.

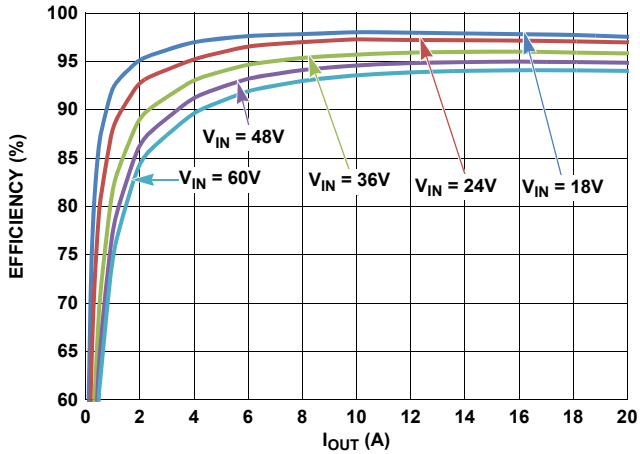

FIGURE 4. CCM EFFICIENCY vs LOAD

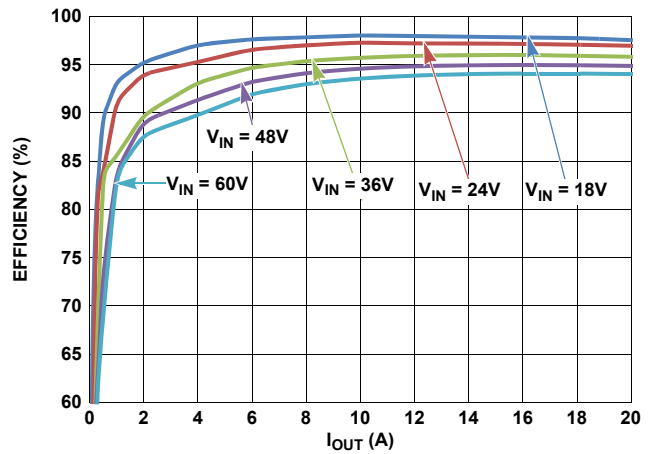

FIGURE 5. DEM EFFICIENCY vs LOAD

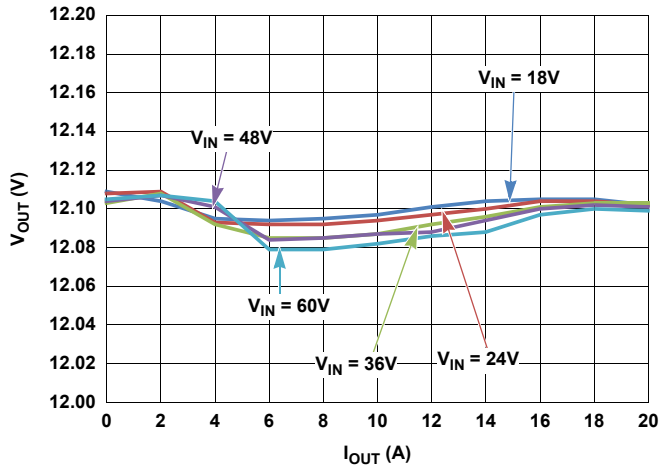

FIGURE 6. CCM MODE LOAD REGULATION

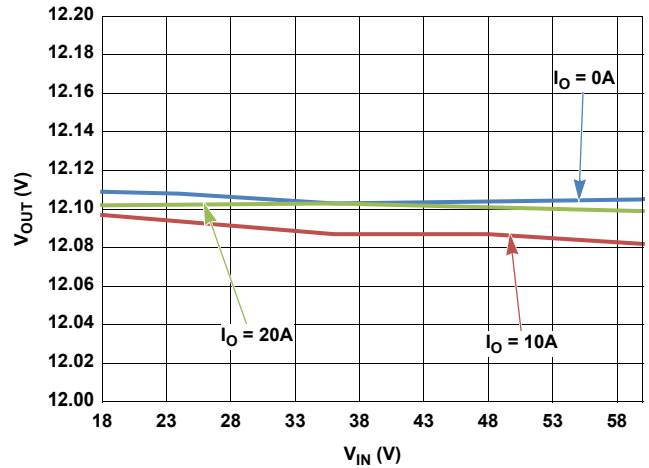

FIGURE 7. CCM MODE LINE REGULATION

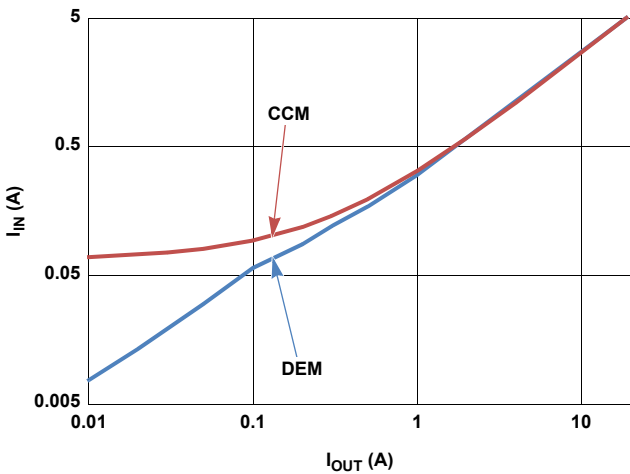

FIGURE 8. INPUT CURRENT COMPARISON WITH MODE = CCM/DEM

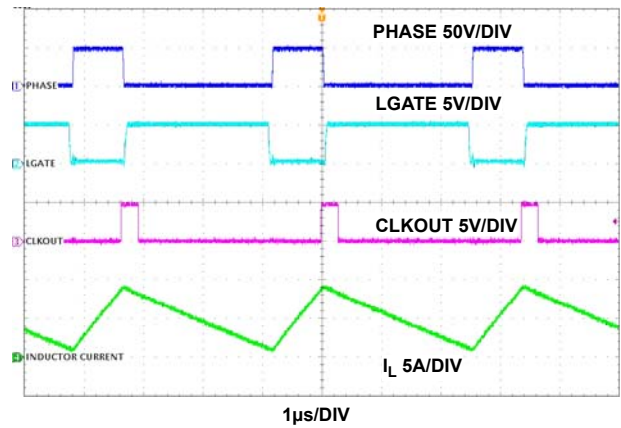

FIGURE 9. PHASE, LGATE, CLKOUT AND INDUCTOR CURRENT WAVEFORMS

**Typical Evaluation Board Performance Curves**  $V_{IN} = 48V$ , unless otherwise noted. (Continued)

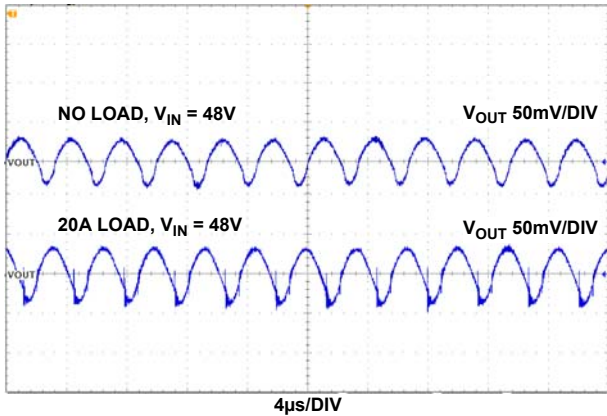

FIGURE 10. OUTPUT RIPPLE, MODE = CCM

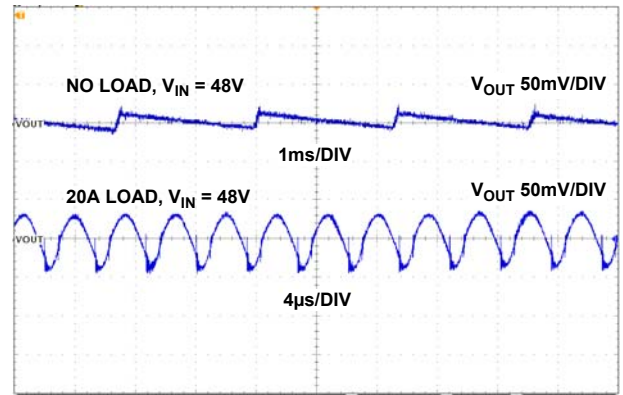

FIGURE 11. OUTPUT RIPPLE, MODE = DEM

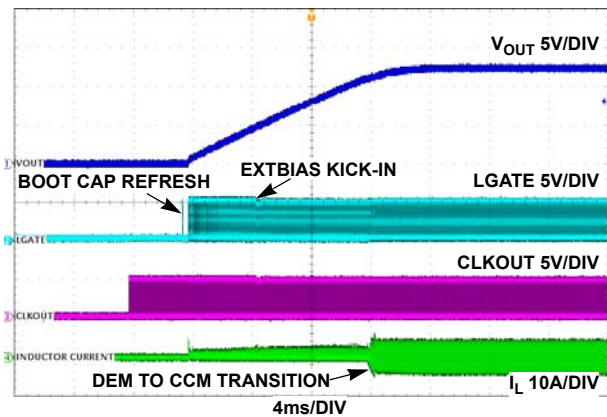

FIGURE 12. START-UP WAVEFORMS; MODE = CCM, LOAD = 0A,  $V_{IN} = 48V$

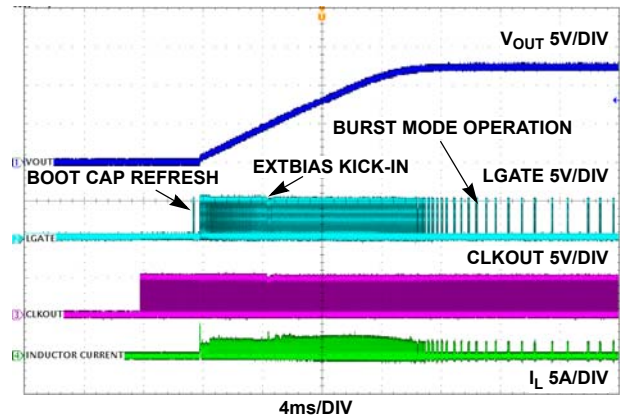

FIGURE 13. START-UP WAVEFORMS; MODE = DEM, LOAD = 0A,  $V_{IN} = 48V$

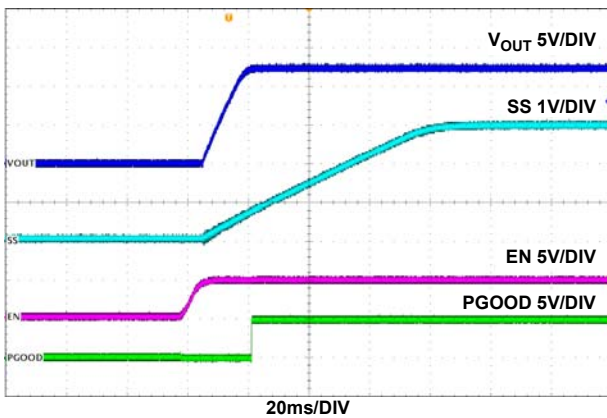

FIGURE 14. START-UP WAVEFORMS; MODE = CCM, LOAD = 0A,  $V_{IN} = 48V$

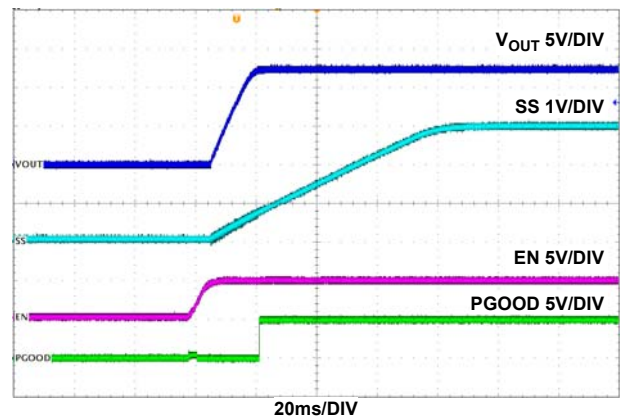
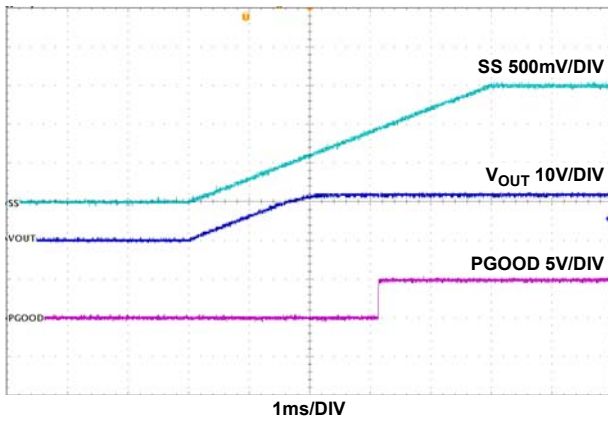
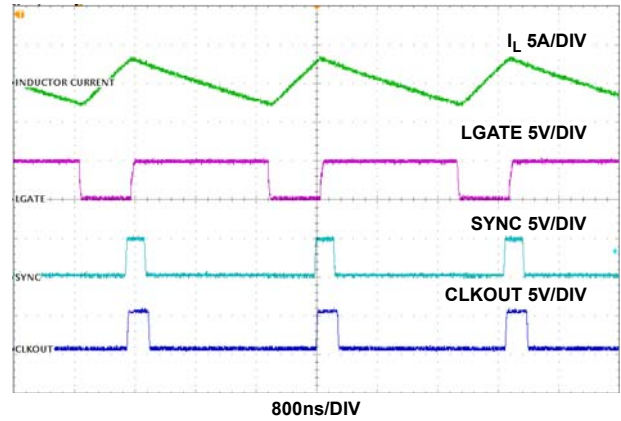

FIGURE 15. START-UP WAVEFORMS; MODE = DEM, LOAD = 0A,  $V_{IN} = 48V$

**Typical Evaluation Board Performance Curves**  $V_{IN} = 48V$ , unless otherwise noted. (Continued)



**FIGURE 16. TRACKING;**  $V_{IN} = 48V$ , LOAD = 0A, MODE = CCM



**FIGURE 17. FREQUENCY SYNCHRONIZATION;**  $V_{IN} = 48V$ , LOAD = 0A, DEFAULT  $f_{SW} = 300kHz$ , SYNC  $f_{SW} = 400kHz$

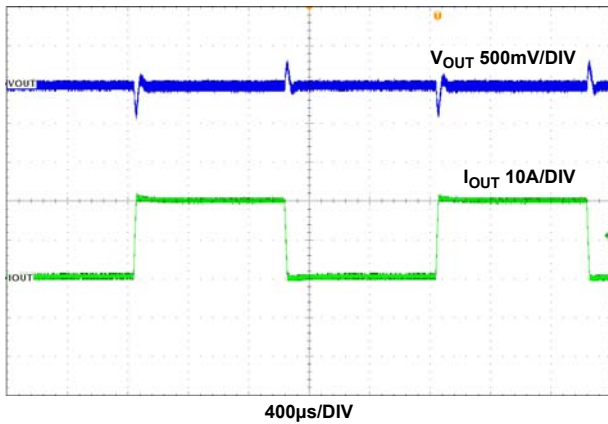

**FIGURE 18. LOAD TRANSIENT RESPONSE;**  $V_{IN} = 48V$ , 2A TO 18A  $1A/\mu s$  STEP LOAD, CCM MODE

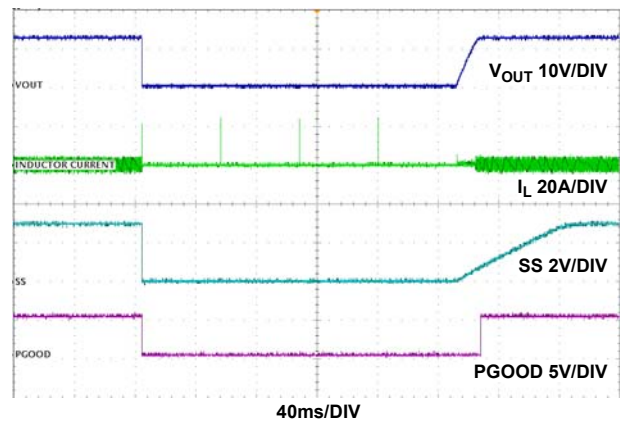

**FIGURE 19. OCP RESPONSE, OUTPUT SHORT-CIRCUITED TO GROUND AND RELEASED, CCM MODE,  $V_{IN} = 48V$  NO LOAD TO SHORT AND RELEASE**

# Schematic

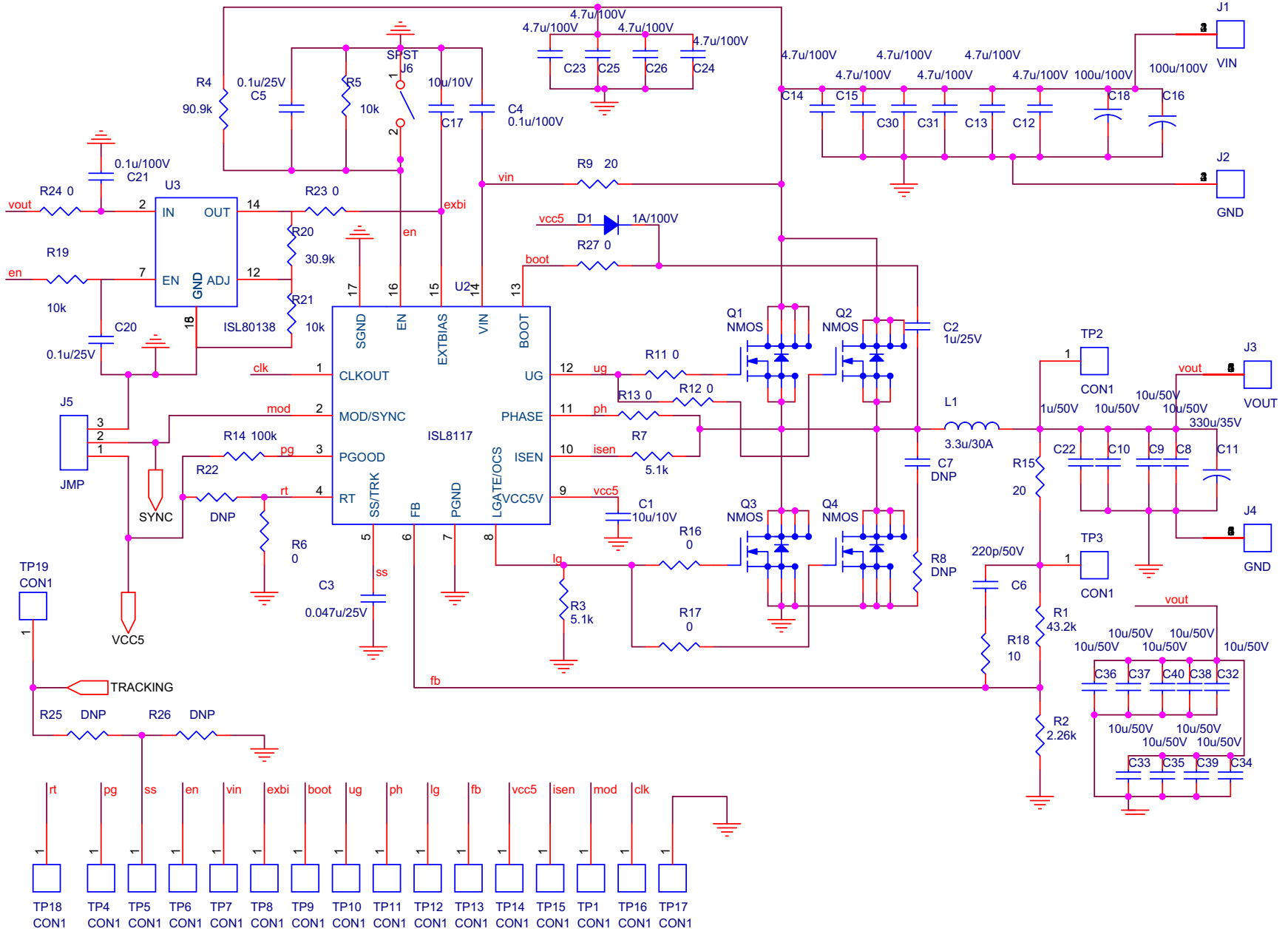

FIGURE 20. ISL8117EVAL2Z SCHEMATIC

## Bill of Materials

MANUFACTURER PART	QTY	UNITS	REFERENCE DESIGNATOR	DESCRIPTION	MANUFACTURER
ISL8117EVAL2ZREVBPCB	1	ea		PWB-PCB,ISL8117EVAL2Z,REVB,ROHS	IMAGINEERING INC
C0603X7R101-104KNE	2	ea	C4, C21	CAP, SMD, 0603, 0.1µF, 100V, 10%, X7R, ROHS	VENKEL
GRM39X7R104K025AD	2	ea	C5, C20	CAP, SMD, 0603, 0.1µF, 25V, 10%, X7R, ROHS	MURATA
C1608X5R1H105K	2	ea	C2, C22	CAP, SMD, 0603, 1µF, 50V, 10%, X5R, ROHS	TDK
ECJ-1VB1A106M	2	ea	C1, C17	CAP, SMD, 0603, 10µF, 10V, 20%, X5R, ROHS	PANASONIC
GRM188R71H221KA01D	1	ea	C6	CAP, SMD, 0603, 220pF, 50V, 10%, X7R, ROHS	MURATA
GRM188R71E473KA01D	1	ea	C3	CAP, SMD, 0603, 0.047µF, 25V, 10%, X7R, ROHS	MURATA
	0	ea	C7	CAP, SMD, 0603, DNP-PLACE HOLDER, ROHS	
UMK325BJ106KM-T	12	ea	a) C8, C9, C10, C32, C33, C34, C35, C36, C37, C38	CAP, SMD, 1210, 10µF, 50V, 10%, X5R, ROHS	TAIYO YUDEN
UMK325BJ106KM-T	0	ea	b) C39, C40	CAP, SMD, 1210, 10µF, 50V, 10%, X5R, ROHS	TAIYO YUDEN
CGA6M3X7S2A475K200AB	10	ea	C12, C13, C14, C15, C23, C24, C25, C26, C30, C31	CAP, SMD, 1210, 4.7µF, 100V, 10%, X7S, ROHS	TDK
EEE-FP1V331AP	1	ea	C11	CAP, SMD, 10x10.2mm, 330µF, 35V, 20%, ALUM.ELEC., ROHS	PANASONIC
EMVH101GDA101MLH0S	2	ea	C16, C18	CAP, SMD, 16x16.5mm, 100µF, 100V, 20%, ALUM.ELEC., ROHS	UNITED CHEMI-CON
IHLP6767GZER3R3M11	1	ea	L1	COIL-PWR INDUCTOR, SMD, 17.15mm <sup>2</sup> , 3.3µH, 20%, 35A, ROHS	VISHAY
5007	19	ea	TP1-TP19	CONN-COMPACT TEST PT, VERTICAL, WHT, ROHS	KEYSTONE
68000-236HLF	1	ea	J5	CONN-HEADER, 1x3, BREAKAWY 1x36, 2.54mm, ROHS	BERG/FCI
69190-202HLF	1	ea	J6	CONN-HEADER, 1X2, RETENTIVE, 2.54mm, 0.230 x 0.120, ROHS	BERG/FCI
SPC02SYAN	2	ea	J5, J6	CONN-JUMPER, SHORTING, 2PIN, BLACK, GOLD, ROHS	SULLINS
MBR1H100SFT3G	1	ea	D1	DIODE-RECTIFIER, SMD, 2P, SOD-123FL, 100V, 1A, ROHS	ON SEMICONDUCTOR
ISL80138IVEAJZ	1	ea	U3	IC-40V LDO ADJ. LINEAR REGULATOR, 14P, HTSSOP, ROHS	INTERSIL
ISL8117FRZ	1	ea	U2	IC-55V SWITCHING CONTROLLER, 16P, QFN, ROHS	INTERSIL
BSC067N06LS3G	4	ea	Q1, Q2, Q3, Q4	TRANSISTOR-MOS, N-CHANNEL, 8P, PG-TDSON-8, 60V, 50A, ROHS	INFINEON TECHNOLOGY
RK73H1JT10R0F	1	ea	R18	RES, SMD, 0603, 10Ω, 1/10W, 1%, TF, ROHS	KOA
ERJ-3EKF20R0V	2	ea	R9, R15	RES, SMD, 0603, 20Ω, 1/10W, 1%, TF, ROHS	PANASONIC
CR0603-10W-000T	9	ea	R6, R11, R12, R13, R16, R17, R23, R24, R27	RES, SMD, 0603, 0Ω, 1/10W, TF, ROHS	VENKEL
RK73H1JT1002F	3	ea	R5, R19, R21	RES, SMD, 0603, 10k, 1/10W, 1%, TF, ROHS	KOA
CR0603-10W-1003FT	1	ea	R14	RES, SMD, 0603, 100k, 1/10W, 1%, TF, ROHS	VENKEL
RC0603FR-072K26L	1	ea	R2	RES, SMD, 0603, 2.26k, 1/10W, 1%, TF, ROHS	YAGEO
RC0603FR-0730K9L	1	ea	R20	RES, SMD, 0603, 30.9k, 1/10W, 1%, TF, ROHS	YAGEO
RC0603FR-0743K2L (Pb-free)	1	ea	R1	RES, SMD, 0603, 43.2k, 1/10W, 1%, TF, ROHS	YAGEO
CR0603-10W-5101FT	2	ea	R3, R7	RES, SMD, 0603, 5.1k, 1/10W, 1%, TF, ROHS	VENKEL



## Bill of Materials (Continued)

MANUFACTURER PART	QTY	UNITS	REFERENCE DESIGNATOR	DESCRIPTION	MANUFACTURER
ERJ-3EKF9092V	1	ea	R4	RES, SMD, 0603, 90.9k, 1/10W, 1%, TF, ROHS	PANASONIC
	0	ea	R22, R25, R26	RES, SMD, 0603, DNP-PLACE HOLDER, ROHS	
	0	ea	R8	RES, SMD, 1206, DNP, DNP, DNP, TF, ROHS	
7795	2	ea	J1, J2	HDWARE, TERMINAL, M4 METRIC SCREW, TH, 4P, SNAP-FIT, ROHS	KEYSTONE
7798	2	ea	J3, J4	HDWARE, TERMINAL, M4 METRIC SCREW, TH, 6P, SNAP-FIT, ROHS	KEYSTONE
R25-1001002	4	ea	Four corners	STANDOFF, M2.5, 10mm, METRIC, F/F, HEX, THREADED, ROHS	HARWIN INC
29301	4	ea	Four corners	SCREW, M2.5, 6mm, METRIC, PANHEAD, SLOTTED, STEEL, ROHS	KEYSTONE

## ISL8117EVAL2Z PCB Layout

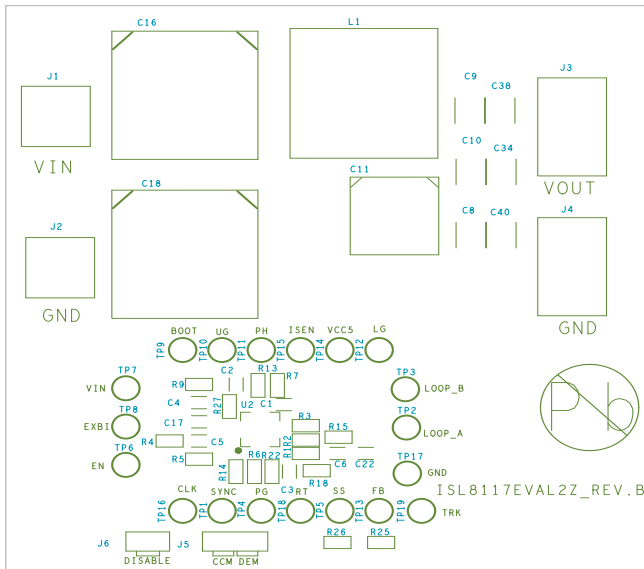

FIGURE 21. SILKSCREEN TOP

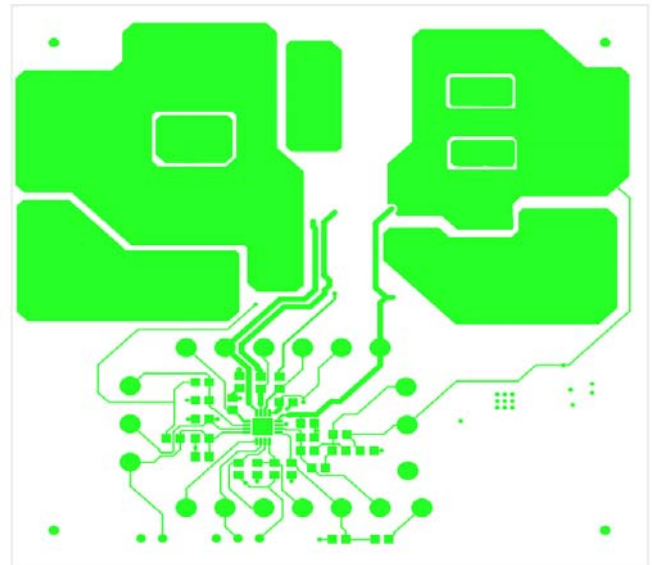

FIGURE 22. TOP LAYER

**ISL8117EVAL2Z PCB Layout (Continued)**

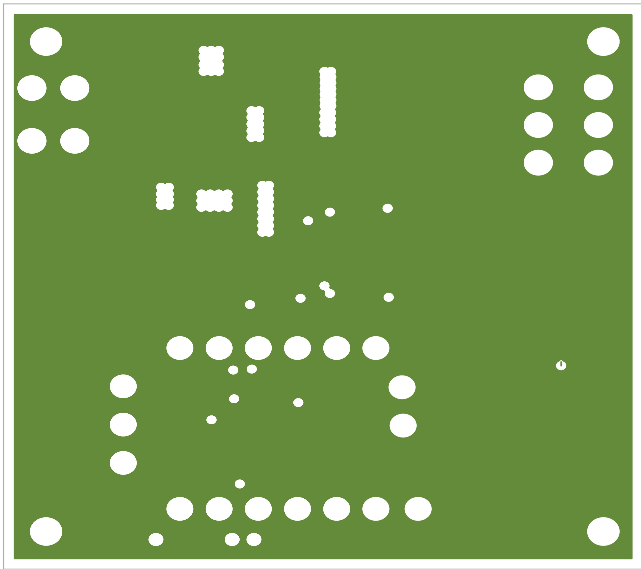

FIGURE 23. SECOND LAYER (SOLID GROUND)

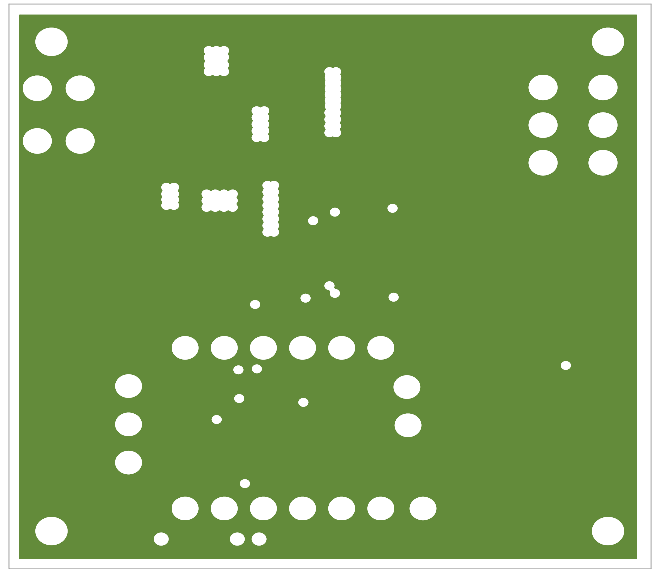

FIGURE 24. THIRD LAYER

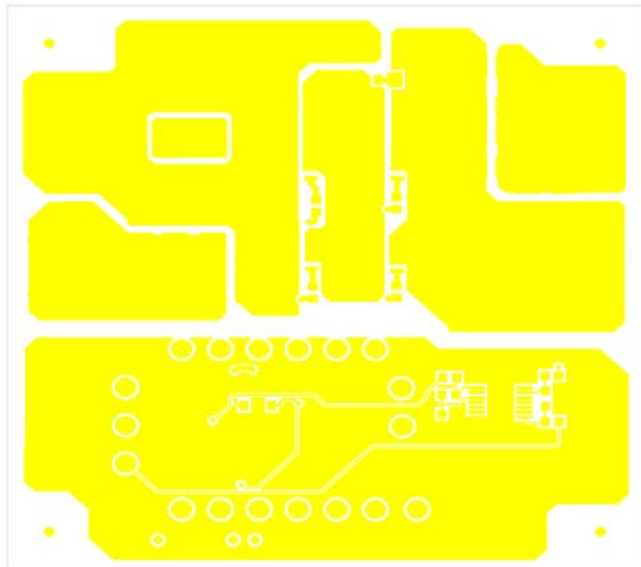

FIGURE 25. BOTTOM LAYER

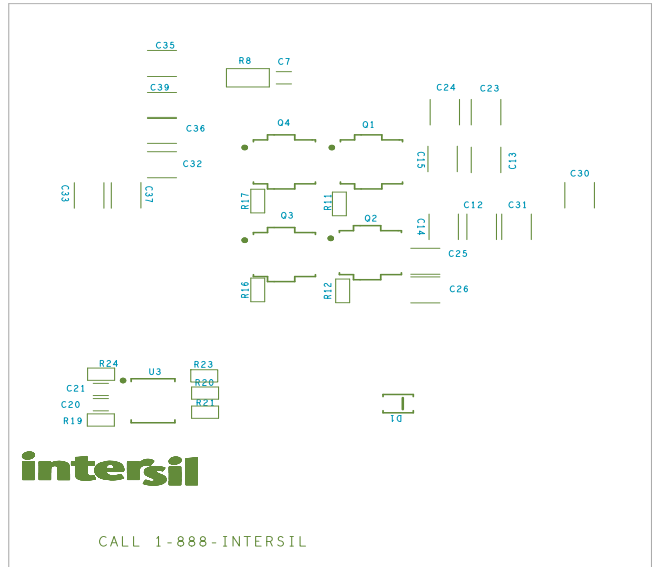

FIGURE 26. SILKSCREEN BOTTOM

## Notice

1. Descriptions of circuits, software and other related information in this document are provided only to illustrate the operation of semiconductor products and application examples. You are fully responsible for the incorporation or any other use of the circuits, software, and information in the design of your product or system. Renesas Electronics disclaims any and all liability for any losses and damages incurred by you or third parties arising from the use of these circuits, software, or information.
2. Renesas Electronics hereby expressly disclaims any warranties against and liability for infringement or any other claims involving patents, copyrights, or other intellectual property rights of third parties, by or arising from the use of Renesas Electronics products or technical information described in this document, including but not limited to, the product data, drawings, charts, programs, algorithms, and application examples.
3. No license, express, implied or otherwise, is granted hereby under any patents, copyrights or other intellectual property rights of Renesas Electronics or others.
4. You shall not alter, modify, copy, or reverse engineer any Renesas Electronics product, whether in whole or in part. Renesas Electronics disclaims any and all liability for any losses or damages incurred by you or third parties arising from such alteration, modification, copying or reverse engineering.
5. Renesas Electronics products are classified according to the following two quality grades: "Standard" and "High Quality". The intended applications for each Renesas Electronics product depends on the product's quality grade, as indicated below.  
"Standard": Computers; office equipment; communications equipment; test and measurement equipment; audio and visual equipment; home electronic appliances; machine tools; personal electronic equipment; industrial robots; etc.  
"High Quality": Transportation equipment (automobiles, trains, ships, etc.); traffic control (traffic lights); large-scale communication equipment; key financial terminal systems; safety control equipment; etc.  
Unless expressly designated as a high reliability product or a product for harsh environments in a Renesas Electronics data sheet or other Renesas Electronics document, Renesas Electronics products are not intended or authorized for use in products or systems that may pose a direct threat to human life or bodily injury (artificial life support devices or systems; surgical implantations; etc.), or may cause serious property damage (space system; undersea repeaters; nuclear power control systems; aircraft control systems; key plant systems; military equipment; etc.). Renesas Electronics disclaims any and all liability for any damages or losses incurred by you or any third parties arising from the use of any Renesas Electronics product that is inconsistent with any Renesas Electronics data sheet, user's manual or other Renesas Electronics document.
6. When using Renesas Electronics products, refer to the latest product information (data sheets, user's manuals, application notes, "General Notes for Handling and Using Semiconductor Devices" in the reliability handbook, etc.), and ensure that usage conditions are within the ranges specified by Renesas Electronics with respect to maximum ratings, operating power supply voltage range, heat dissipation characteristics, installation, etc. Renesas Electronics disclaims any and all liability for any malfunctions, failure or accident arising out of the use of Renesas Electronics products outside of such specified ranges.
7. Although Renesas Electronics endeavors to improve the quality and reliability of Renesas Electronics products, semiconductor products have specific characteristics, such as the occurrence of failure at a certain rate and malfunctions under certain use conditions. Unless designated as a high reliability product or a product for harsh environments in a Renesas Electronics data sheet or other Renesas Electronics document, Renesas Electronics products are not subject to radiation resistance design. You are responsible for implementing safety measures to guard against the possibility of bodily injury, injury or damage caused by fire, and/or danger to the public in the event of a failure or malfunction of Renesas Electronics products, such as safety design for hardware and software, including but not limited to redundancy, fire control and malfunction prevention, appropriate treatment for aging degradation or any other appropriate measures. Because the evaluation of microcomputer software alone is very difficult and impractical, you are responsible for evaluating the safety of the final products or systems manufactured by you.
8. Please contact a Renesas Electronics sales office for details as to environmental matters such as the environmental compatibility of each Renesas Electronics product. You are responsible for carefully and sufficiently investigating applicable laws and regulations that regulate the inclusion or use of controlled substances, including without limitation, the EU RoHS Directive, and using Renesas Electronics products in compliance with all these applicable laws and regulations. Renesas Electronics disclaims any and all liability for damages or losses occurring as a result of your noncompliance with applicable laws and regulations.
9. Renesas Electronics products and technologies shall not be used for or incorporated into any products or systems whose manufacture, use, or sale is prohibited under any applicable domestic or foreign laws or regulations. You shall comply with any applicable export control laws and regulations promulgated and administered by the governments of any countries asserting jurisdiction over the parties or transactions.
10. It is the responsibility of the buyer or distributor of Renesas Electronics products, or any other party who distributes, disposes of, or otherwise sells or transfers the product to a third party, to notify such third party in advance of the contents and conditions set forth in this document.
11. This document shall not be reprinted, reproduced or duplicated in any form, in whole or in part, without prior written consent of Renesas Electronics.
12. Please contact a Renesas Electronics sales office if you have any questions regarding the information contained in this document or Renesas Electronics products.  
(Note 1) "Renesas Electronics" as used in this document means Renesas Electronics Corporation and also includes its directly or indirectly controlled subsidiaries.  
(Note 2) "Renesas Electronics product(s)" means any product developed or manufactured by or for Renesas Electronics.

(Rev.4.0-1 November 2017)



### SALES OFFICES

Renesas Electronics Corporation

<http://www.renesas.com>

Refer to "<http://www.renesas.com/>" for the latest and detailed information.

**Renesas Electronics America Inc.**  
1001 Murphy Ranch Road, Milpitas, CA 95035, U.S.A.  
Tel: +1-408-432-8888, Fax: +1-408-434-5351

**Renesas Electronics Canada Limited**  
9251 Yonge Street, Suite 8309 Richmond Hill, Ontario Canada L4C 9T3  
Tel: +1-905-237-2004

**Renesas Electronics Europe Limited**  
Dukes Meadow, Millboard Road, Bourne End, Buckinghamshire, SL8 5FH, U.K.  
Tel: +44-1628-651-700, Fax: +44-1628-651-804

**Renesas Electronics Europe GmbH**  
Arcadiastrasse 10, 40472 Düsseldorf, Germany  
Tel: +49-211-6503-0, Fax: +49-211-6503-1327

**Renesas Electronics (China) Co., Ltd.**  
Room 1709 Quantum Plaza, No.27 ZhichunLu, Haidian District, Beijing, 100191 P. R. China  
Tel: +86-10-8235-1155, Fax: +86-10-8235-7679

**Renesas Electronics (Shanghai) Co., Ltd.**  
Unit 301, Tower A, Central Towers, 555 Langao Road, Putuo District, Shanghai, 200333 P. R. China  
Tel: +86-21-2226-0888, Fax: +86-21-2226-0999

**Renesas Electronics Hong Kong Limited**  
Unit 1601-1611, 16/F., Tower 2, Grand Century Place, 193 Prince Edward Road West, Mongkok, Kowloon, Hong Kong  
Tel: +852-2265-6688, Fax: +852-2886-9022

**Renesas Electronics Taiwan Co., Ltd.**  
13F, No. 363, Fu Shing North Road, Taipei 10543, Taiwan  
Tel: +886-2-8175-9600, Fax: +886-2-8175-9670

**Renesas Electronics Singapore Pte. Ltd.**  
80 Bendemeer Road, Unit #06-02 Hyflux Innovation Centre, Singapore 339949  
Tel: +65-6213-0200, Fax: +65-6213-0300

**Renesas Electronics Malaysia Sdn.Bhd.**  
Unit 1207, Block B, Menara Amcorp, Amcorp Trade Centre, No. 18, Jln Persiaran Barat, 46050 Petaling Jaya, Selangor Darul Ehsan, Malaysia  
Tel: +60-3-7955-9390, Fax: +60-3-7955-9510

**Renesas Electronics India Pvt. Ltd.**  
No.777C, 100 Feet Road, HAL 2nd Stage, Indiranagar, Bangalore 560 038, India  
Tel: +91-80-67208700, Fax: +91-80-67208777

**Renesas Electronics Korea Co., Ltd.**  
17F, KAMCO Yangjae Tower, 262, Gangnam-daero, Gangnam-gu, Seoul, 06265 Korea  
Tel: +82-2-558-3737, Fax: +82-2-558-5338



Компания «ЭлектроПласт» предлагает заключение долгосрочных отношений при поставках импортных электронных компонентов на взаимовыгодных условиях!

Наши преимущества:

- Оперативные поставки широкого спектра электронных компонентов отечественного и импортного производства напрямую от производителей и с крупнейших мировых складов;
- Поставка более 17-ти миллионов наименований электронных компонентов;
- Поставка сложных, дефицитных, либо снятых с производства позиций;
- Оперативные сроки поставки под заказ (от 5 рабочих дней);
- Экспресс доставка в любую точку России;
- Техническая поддержка проекта, помощь в подборе аналогов, поставка прототипов;
- Система менеджмента качества сертифицирована по Международному стандарту ISO 9001;
- Лицензия ФСБ на осуществление работ с использованием сведений, составляющих государственную тайну;
- Поставка специализированных компонентов (Xilinx, Altera, Analog Devices, Intersil, Interpoint, Microsemi, Aeroflex, Peregrine, Syfer, Eurofarad, Texas Instrument, Miteq, Cobham, E2V, MA-COM, Hittite, Mini-Circuits, General Dynamics и др.);

Помимо этого, одним из направлений компании «ЭлектроПласт» является направление «Источники питания». Мы предлагаем Вам помощь Конструкторского отдела:

- Подбор оптимального решения, техническое обоснование при выборе компонента;
- Подбор аналогов;
- Консультации по применению компонента;
- Поставка образцов и прототипов;
- Техническая поддержка проекта;
- Защита от снятия компонента с производства.



#### Как с нами связаться

**Телефон:** 8 (812) 309 58 32 (многоканальный)

**Факс:** 8 (812) 320-02-42

**Электронная почта:** [org@eplast1.ru](mailto:org@eplast1.ru)

**Адрес:** 198099, г. Санкт-Петербург, ул. Калинина, дом 2, корпус 4, литера А.