

## Product Summary

Device	BV <sub>DSS</sub>	R <sub>DS(ON)</sub> max	I <sub>D</sub> max T <sub>A</sub> = +25°C
Q1	20V	0.4Ω @ V <sub>GS</sub> = 4.5V	870mA
		0.5Ω @ V <sub>GS</sub> = 2.5V	780mA
		0.7Ω @ V <sub>GS</sub> = 1.8V	640mA
Q2	-20V	0.7Ω @ V <sub>GS</sub> = -4.5V	-640mA
		0.9Ω @ V <sub>GS</sub> = -2.5V	-580mA
		1.3Ω @ V <sub>GS</sub> = -1.8V	-465mA

## Description and Applications

This MOSFET is designed to minimize the on-state resistance and yet maintain superior switching performance, making it ideal for high efficiency power management applications.

- Switches

## Features

- Low On-Resistance
- Low Gate Threshold Voltage V<sub>GS(th)</sub> <1V
- Low Input Capacitance
- Fast Switching Speed
- Low Input/Output Leakage
- Complementary Pair MOSFET
- Ultra-Small Surface Mount Package
- ESD Protected Gate to 2.5kV HBM**
- Totally Lead-Free & Fully RoHS Compliant (Notes 1 & 2)**
- Halogen and Antimony Free. "Green" Device (Note 3)**
- Qualified to AEC-Q101 Standards for High Reliability**
- PPAP Capable (Note 4)**

## Mechanical Data

- Case: SOT-563
- Case Material: Molded Plastic, "Green" Molding Compound; UL Flammability Classification Rating 94V-0
- Moisture Sensitivity: Level 1 per J-STD-020
- Terminal Connections: See Diagram
- Terminal Finish - Matte Tin Annealed over Copper Leadframe; Solderable per MIL-STD-202, Method 208
- Weight: 0.006 grams (Approximate)

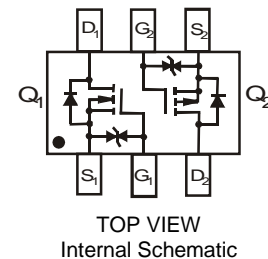
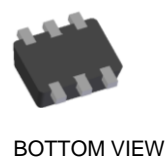

## Ordering Information (Note 5)

Part Number	Case	Packaging
DMG1016VQ-7	SOT-563	3,000/Tape & Reel
DMG1016VQ-13	SOT-563	10,000/Tape & Reel

- Notes:
- No purposely added lead. Fully EU Directive 2002/95/EC (RoHS) & 2011/65/EU (RoHS 2) compliant.
  - See [http://www.diodes.com/quality/lead\\_free.html](http://www.diodes.com/quality/lead_free.html) for more information about Diodes Incorporated's definitions of Halogen- and Antimony-free, "Green" and Lead-free.
  - Halogen- and Antimony-free "Green" products are defined as those which contain <900ppm bromine, <900ppm chlorine (<1500ppm total Br + Cl) and <1000ppm antimony compounds.
  - Automotive products are AEC-Q101 qualified and are PPAP capable. Automotive, AEC-Q101 and standard products are electrically and thermally the same, except where specified. For more information, please refer to [http://www.diodes.com/quality/product\\_compliance\\_definitions/](http://www.diodes.com/quality/product_compliance_definitions/).
  - For packaging details, go to our website at <http://www.diodes.com/products/packages.html>.

## Marking Information

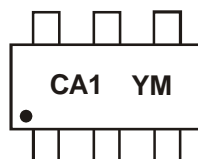

CA1 = Product Type Marking Code  
 YM = Date Code Marking  
 Y = Year (ex: W = 2009)  
 M = Month (ex: 9 = September)

### Date Code Key

Year	2009	2010	2011	2012	2013	2014	2015	2016	2017	2018	2019	2020
Code	W	X	Y	Z	A	B	C	D	E	F	G	H
Month	Jan	Feb	Mar	Apr	May	Jun	Jul	Aug	Sep	Oct	Nov	Dec
Code	1	2	3	4	5	6	7	8	9	O	N	D

**Maximum Ratings** (Q1 N-Channel) (@ $T_A = +25^\circ\text{C}$ , unless otherwise specified.)

Characteristic	Symbol	Value	Unit
Drain Source Voltage	$V_{DSS}$	20	V
Gate-Source Voltage	$V_{GSS}$	$\pm 6$	V
Drain Current (Note 6)	$I_D$	$T_A = +25^\circ\text{C}$	870
		$T_A = +85^\circ\text{C}$	630

**Maximum Ratings** (Q2 P-Channel) (@ $T_A = +25^\circ\text{C}$ , unless otherwise specified.)

Characteristic	Symbol	Value	Unit
Drain Source Voltage	$V_{DSS}$	-20	V
Gate-Source Voltage	$V_{GSS}$	$\pm 6$	V
Drain Current (Note 6)	$I_D$	$T_A = +25^\circ\text{C}$	-640
		$T_A = +85^\circ\text{C}$	-460

**Thermal Characteristics**

Characteristic	Symbol	Value	Unit
Power Dissipation (Note 6)	$P_D$	530	mW
Thermal Resistance, Junction to Ambient (Note 6)	$R_{\theta JA}$	235	$^\circ\text{C}/\text{W}$
Operating and Storage Temperature Range	$T_J, T_{STG}$	-55 to +150	$^\circ\text{C}$

**Electrical Characteristics** (Q1 N-Channel) (@T<sub>A</sub> = +25°C, unless otherwise specified.)

Characteristic	Symbol	Min	Typ	Max	Unit	Test Condition
<b>OFF CHARACTERISTICS</b> (Note 7)						
Drain-Source Breakdown Voltage	BV <sub>DSS</sub>	20	—	—	V	V <sub>GS</sub> = 0V, I <sub>D</sub> = 250μA
Zero Gate Voltage Drain Current	I <sub>DSS</sub>	—	—	100	nA	V <sub>DS</sub> = 20V, V <sub>GS</sub> = 0V
Gate-Source Leakage	I <sub>GSS</sub>	—	—	± 1.0	μA	V <sub>GS</sub> = ±4.5V, V <sub>DS</sub> = 0V
<b>ON CHARACTERISTICS</b> (Note 7)						
Gate Threshold Voltage	V <sub>GS(th)</sub>	0.5	—	1.0	V	V <sub>DS</sub> = V <sub>GS</sub> , I <sub>D</sub> = 250μA
Static Drain-Source On-Resistance	R <sub>DS(ON)</sub>	—	0.3	0.4	Ω	V <sub>GS</sub> = 4.5V, I <sub>D</sub> = 600mA
		—	0.4	0.5		V <sub>GS</sub> = 2.5V, I <sub>D</sub> = 500mA
		—	0.5	0.7		V <sub>GS</sub> = 1.8V, I <sub>D</sub> = 350mA
Forward Transfer Admittance	Y <sub>fs</sub>	—	1.4	—	S	V <sub>DS</sub> = 10V, I <sub>D</sub> = 400mA
Diode Forward Voltage (Note 7)	V <sub>SD</sub>	—	0.7	1.2	V	V <sub>GS</sub> = 0V, I <sub>S</sub> = 150mA
<b>DYNAMIC CHARACTERISTICS</b>						
Input Capacitance	C <sub>iss</sub>	—	60.67	—	pF	V <sub>DS</sub> = 16V, V <sub>GS</sub> = 0V f = 1.0MHz
Output Capacitance	C <sub>oss</sub>	—	9.68	—	pF	
Reverse Transfer Capacitance	C <sub>rss</sub>	—	5.37	—	pF	
Total Gate Charge	Q <sub>g</sub>	—	736.6	—	pC	V <sub>GS</sub> = 4.5V, V <sub>DS</sub> = 10V, I <sub>D</sub> = 250mA
Gate-Source Charge	Q <sub>gs</sub>	—	93.6	—		
Gate-Drain Charge	Q <sub>gd</sub>	—	116.6	—		
Turn-On Delay Time	t <sub>d(on)</sub>	—	5.1	—	nS	V <sub>DD</sub> = 10V, V <sub>GS</sub> = 4.5V, R <sub>L</sub> = 47Ω, R <sub>G</sub> = 10Ω, I <sub>D</sub> = 200mA
Turn-On Rise Time	t <sub>r</sub>	—	7.4	—		
Turn-Off Delay Time	t <sub>d(off)</sub>	—	26.7	—		
Turn-Off Fall Time	t <sub>f</sub>	—	12.3	—		

**Electrical Characteristics** (Q2 P-Channel) (@T<sub>A</sub> = +25°C, unless otherwise specified.)

Characteristic	Symbol	Min	Typ	Max	Unit	Test Condition
<b>OFF CHARACTERISTICS</b> (Note 7)						
Drain-Source Breakdown Voltage	BV <sub>DSS</sub>	-20	—	—	V	V <sub>GS</sub> = 0V, I <sub>D</sub> = -250μA
Zero Gate Voltage Drain Current	I <sub>DSS</sub>	—	—	-100	nA	V <sub>DS</sub> = -20V, V <sub>GS</sub> = 0V
Gate-Source Leakage	I <sub>GSS</sub>	—	—	± 2.0	μA	V <sub>GS</sub> = ±4.5V, V <sub>DS</sub> = 0V
<b>ON CHARACTERISTICS</b> (Note 7)						
Gate Threshold Voltage	V <sub>GS(th)</sub>	-0.5	—	-1.0	V	V <sub>DS</sub> = V <sub>GS</sub> , I <sub>D</sub> = -250μA
Static Drain-Source On-Resistance	R <sub>DS(ON)</sub>	—	0.5	0.7	Ω	V <sub>GS</sub> = -4.5V, I <sub>D</sub> = -430mA
		—	0.7	0.9		V <sub>GS</sub> = -2.5V, I <sub>D</sub> = -300mA
		—	1.0	1.3		V <sub>GS</sub> = -1.8V, I <sub>D</sub> = -150mA
Forward Transfer Admittance	Y <sub>fs</sub>	—	-0.9	—	S	V <sub>DS</sub> = 10V, I <sub>D</sub> = -250mA
Diode Forward Voltage (Note 7)	V <sub>SD</sub>	—	-0.8	-1.2	V	V <sub>GS</sub> = 0V, I <sub>S</sub> = -150mA
<b>DYNAMIC CHARACTERISTICS</b>						
Input Capacitance	C <sub>iss</sub>	—	59.76	—	pF	V <sub>DS</sub> = -16V, V <sub>GS</sub> = 0V f = 1.0MHz
Output Capacitance	C <sub>oss</sub>	—	12.07	—	pF	
Reverse Transfer Capacitance	C <sub>rss</sub>	—	6.36	—	pF	
Total Gate Charge	Q <sub>g</sub>	—	622.4	—	pC	V <sub>GS</sub> = -4.5V, V <sub>DS</sub> = -10V, I <sub>D</sub> = -250mA
Gate-Source Charge	Q <sub>gs</sub>	—	100.3	—		
Gate-Drain Charge	Q <sub>gd</sub>	—	132.2	—		
Turn-On Delay Time	t <sub>d(on)</sub>	—	5.1	—	nS	V <sub>DD</sub> = -10V, V <sub>GS</sub> = -4.5V, R <sub>L</sub> = 47Ω, R <sub>G</sub> = 10Ω, I <sub>D</sub> = -200mA
Turn-On Rise Time	t <sub>r</sub>	—	8.1	—		
Turn-Off Delay Time	t <sub>d(off)</sub>	—	28.4	—		
Turn-Off Fall Time	t <sub>f</sub>	—	20.7	—		

- Notes: 6. Device mounted on FR-4 PCB.  
7. Short duration pulse test used to minimize self-heating effect.

**Typical Characteristics** (Q1 N-Channel)

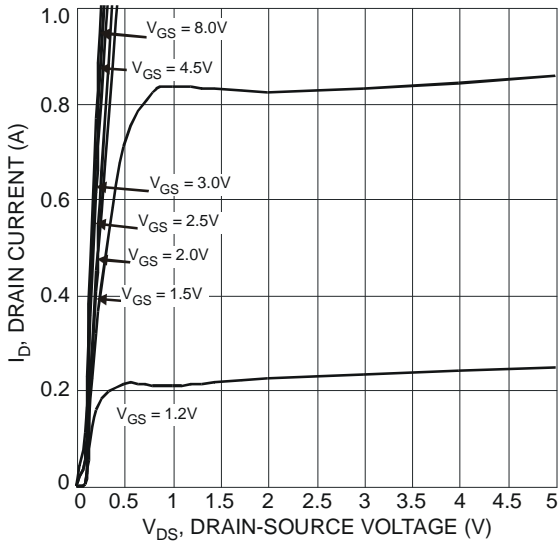

Fig. 1 Typical Output Characteristic

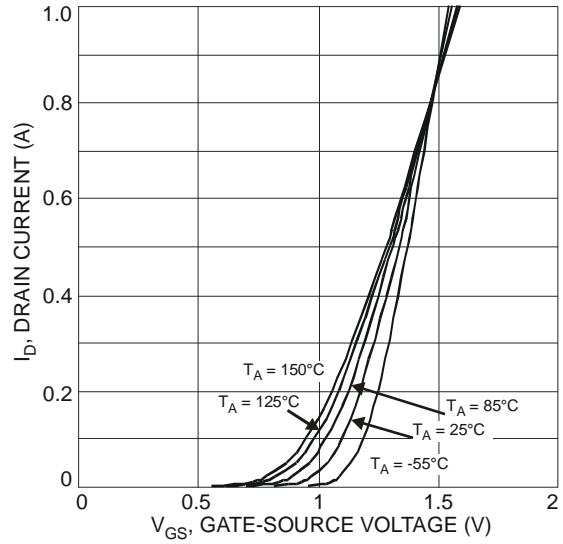

Fig. 2 Typical Transfer Characteristic

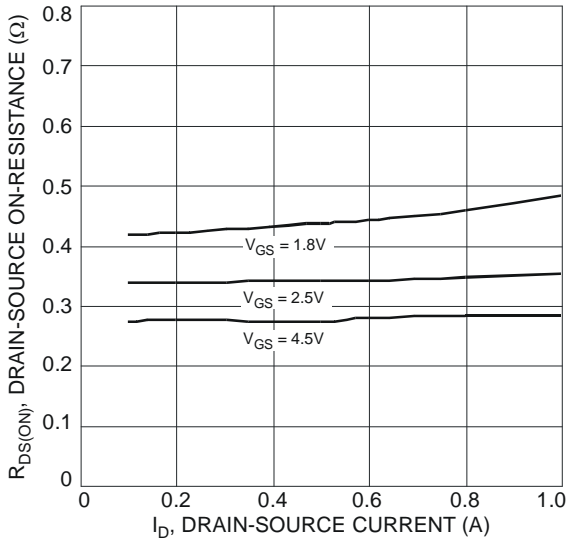

Fig. 3 Typical On-Resistance vs. Drain Current and Gate Voltage

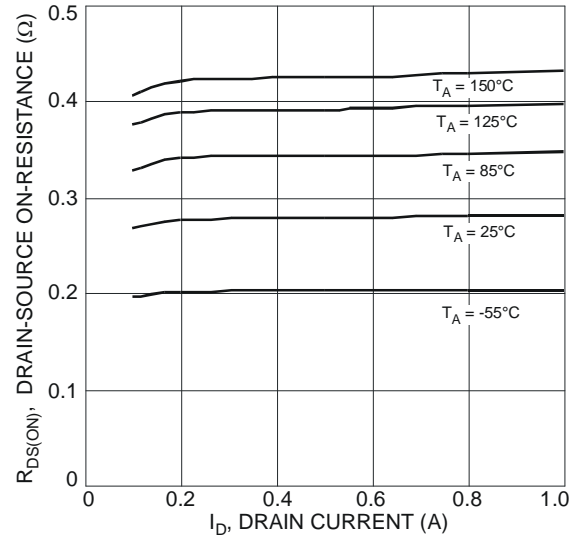

Fig. 4 Typical On-Resistance vs. Drain Current and Temperature

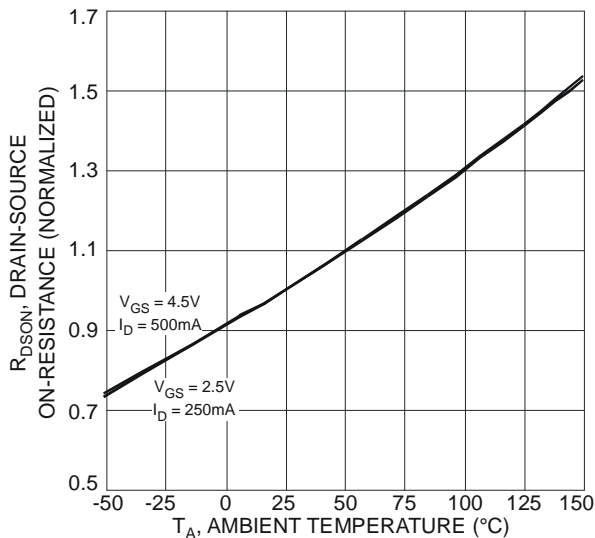

Fig. 5 On-Resistance Variation with Temperature

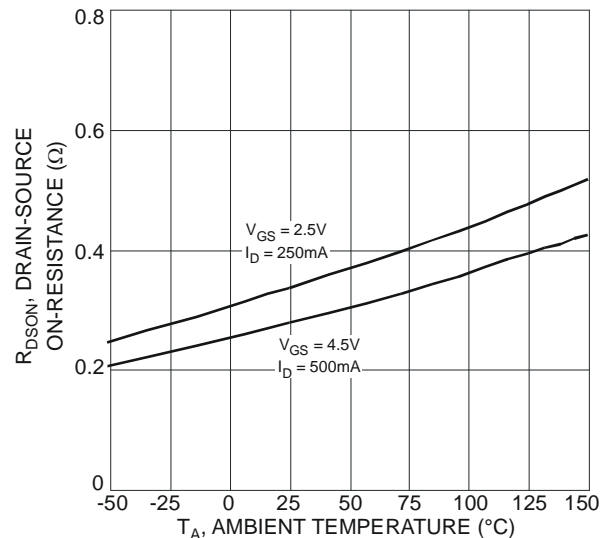

Fig. 6 On-Resistance Variation with Temperature

**Typical Characteristics (Q1 N-Channel) (Continued)**

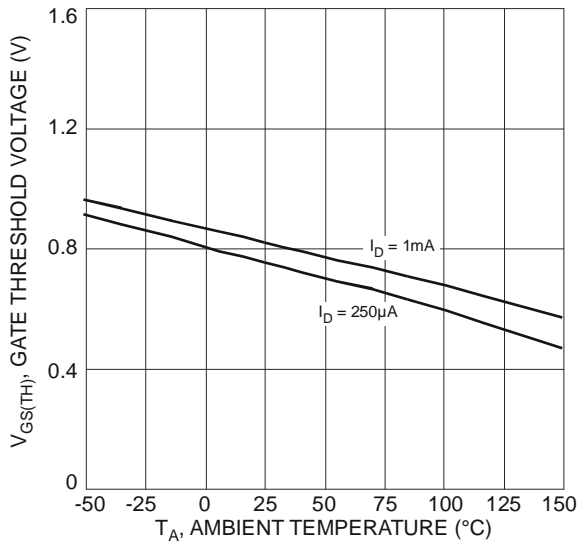

Fig. 7 Gate Threshold Variation vs. Ambient Temperature

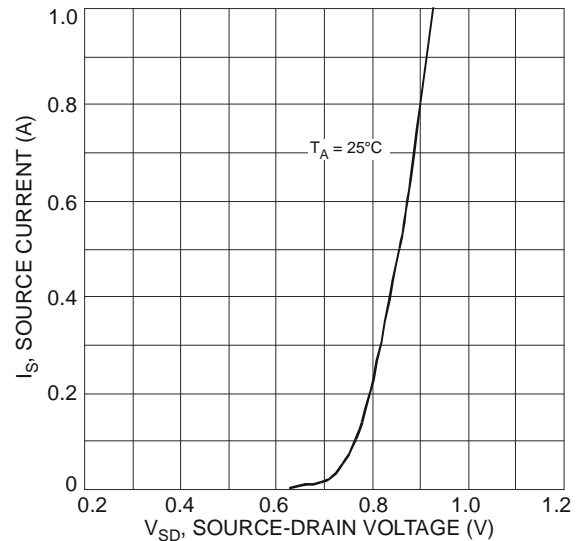

Fig. 8 Diode Forward Voltage vs. Current

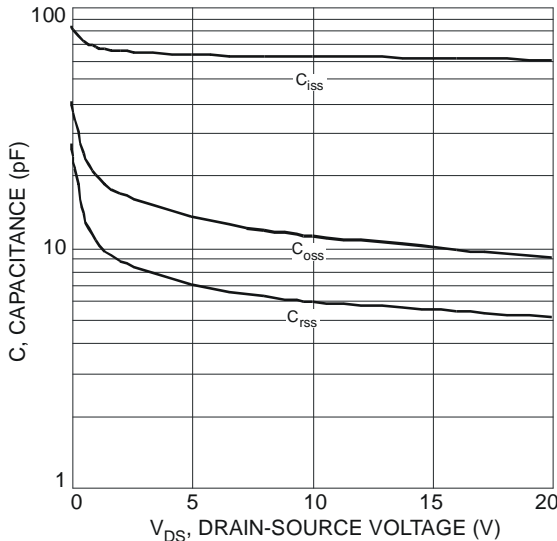

Fig. 9 Typical Total Capacitance

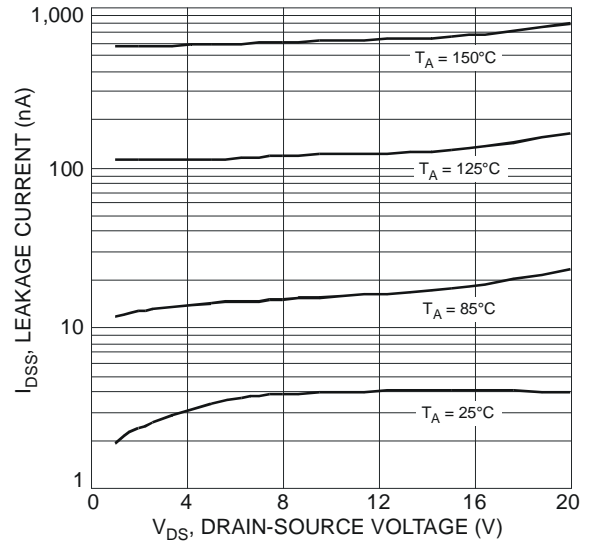

Fig. 10 Typical Leakage Current vs. Drain-Source Voltage

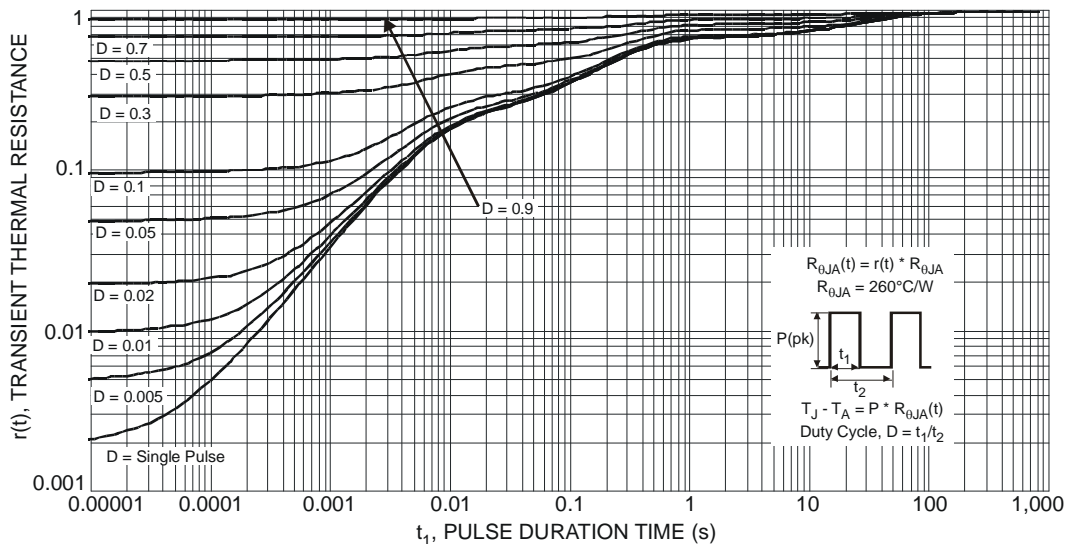

Fig. 11 Transient Thermal Response

**Typical Characteristics (Q2 P-Channel)**

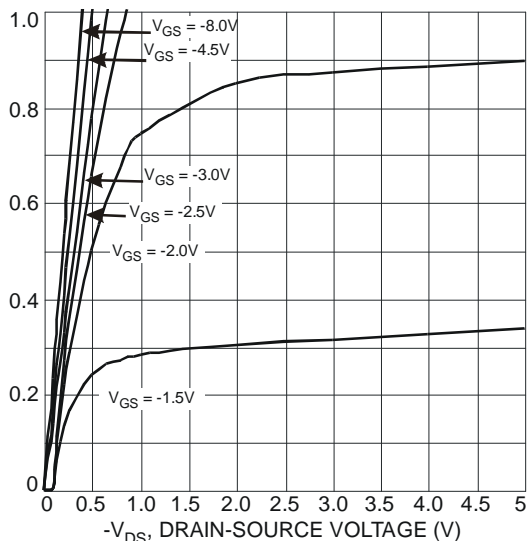

Fig. 12 Typical Output Characteristic

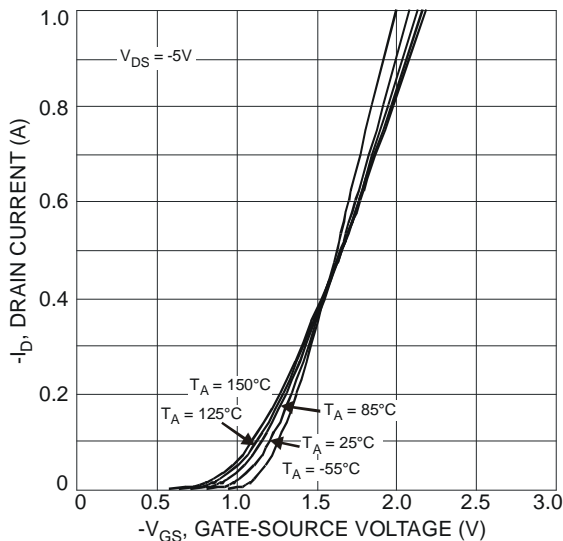

Fig. 13 Typical Transfer Characteristic

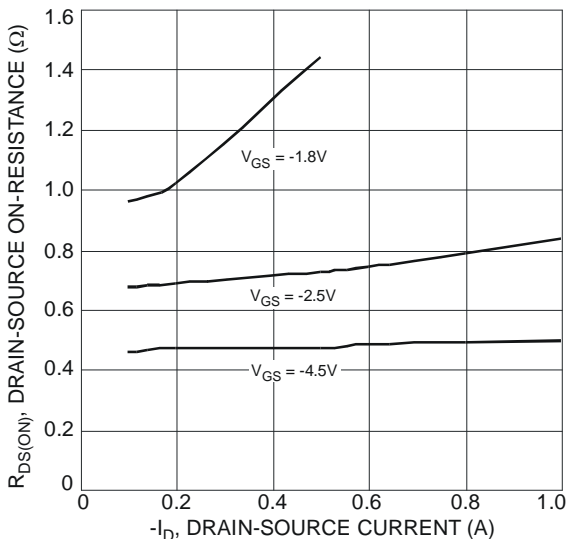

Fig. 14 Typical On-Resistance vs. Drain Current and Gate Voltage

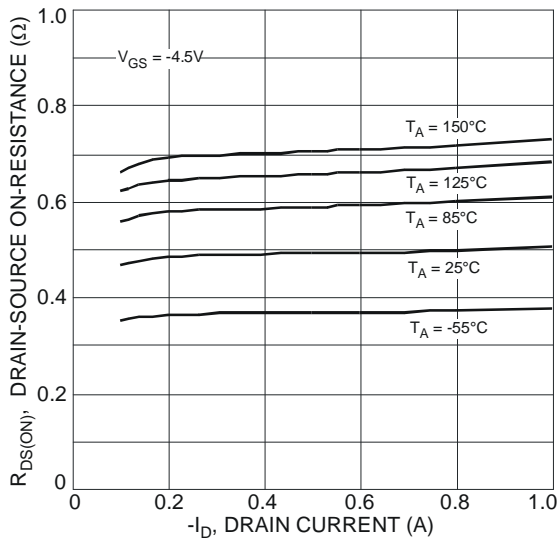

Fig. 15 Typical On-Resistance vs. Drain Current and Temperature

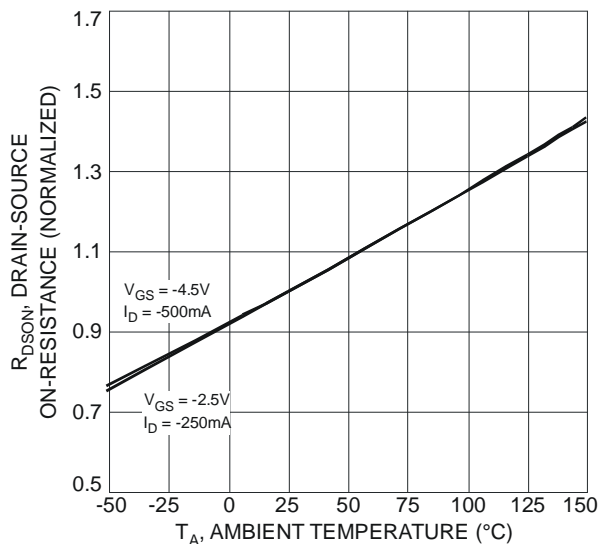

Fig. 16 On-Resistance Variation with Temperature

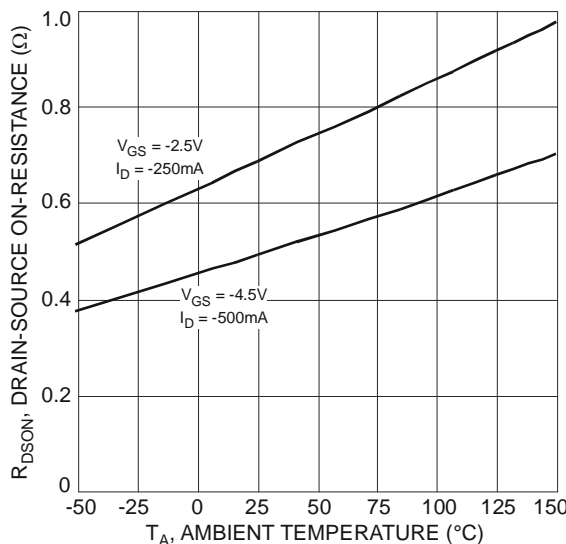

Fig. 17 On-Resistance Variation with Temperature

**Typical Characteristics (Q2 P-Channel) (Continued)**

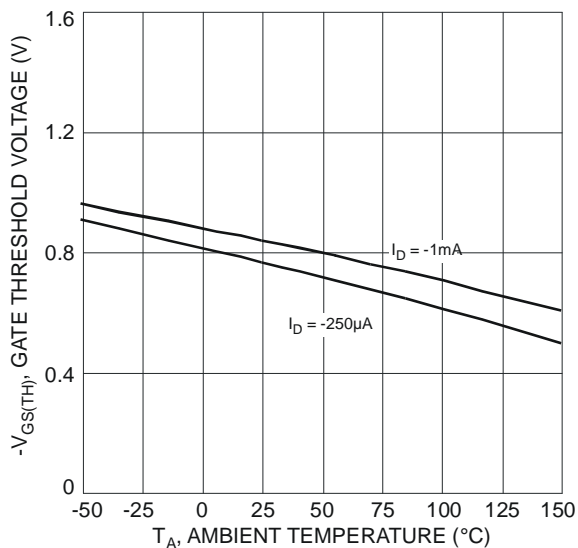

Fig. 18 Gate Threshold Variation vs. Ambient Temperature

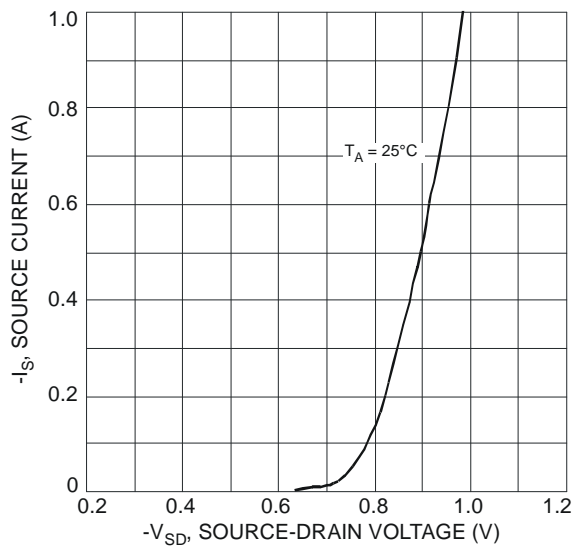

Fig. 19 Diode Forward Voltage vs. Current

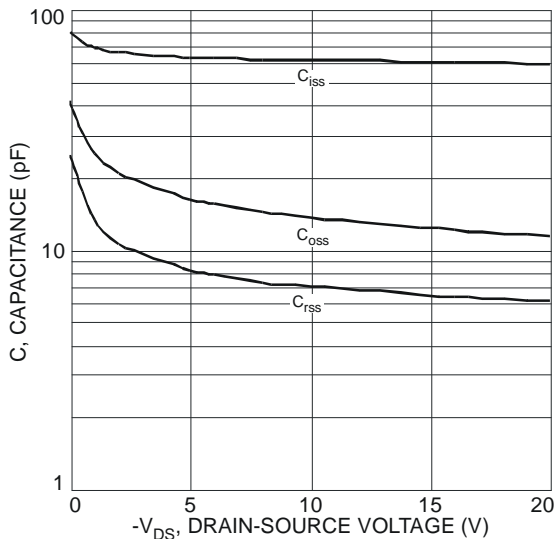

Fig. 20 Typical Total Capacitance

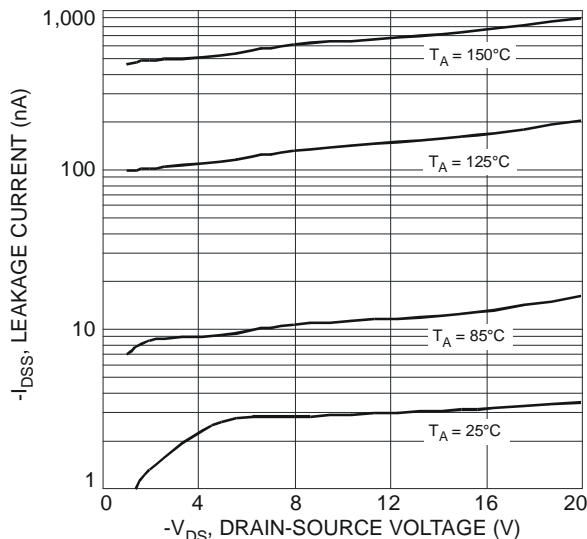

Fig. 21 Typical Leakage Current vs. Drain-Source Voltage

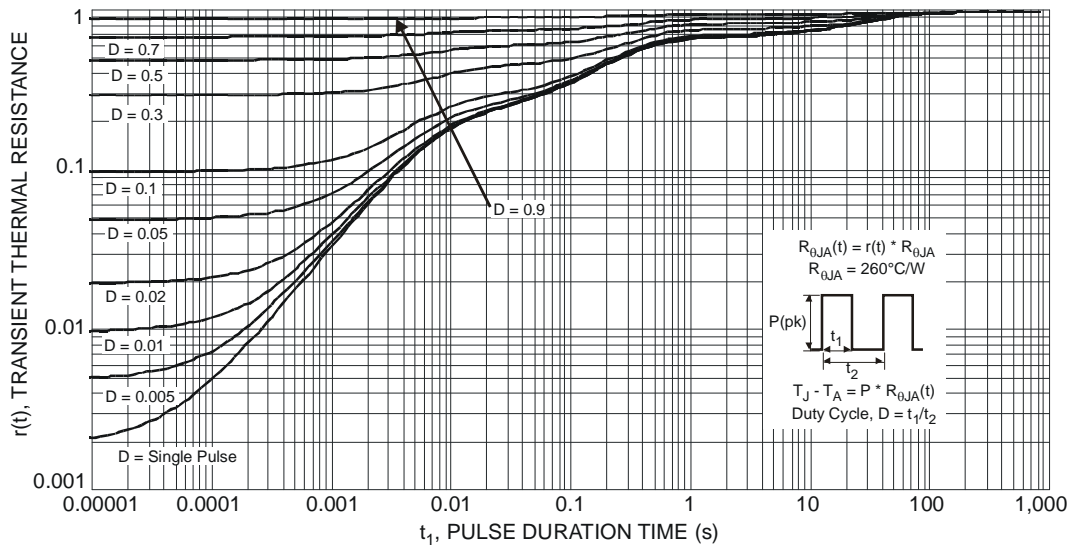
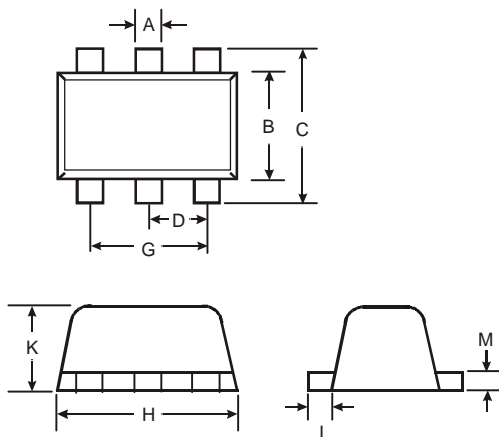

Fig. 22 Transient Thermal Response

**Package Outline Dimensions**

Please see AP02002 at <http://www.diodes.com/datasheets/ap02002.pdf> for the latest version.

**SOT-563**



SOT-563			
Dim	Min	Max	Typ
A	0.15	0.30	0.20
B	1.10	1.25	1.20
C	1.55	1.70	1.60
D	—	—	0.50
G	0.90	1.10	1.00
H	1.50	1.70	1.60
K	0.55	0.60	0.60
L	0.10	0.30	0.20
M	0.10	0.18	0.11
All Dimensions in mm			

**Suggested Pad Layout**

Please see AP02001 at <http://www.diodes.com/datasheets/ap02001.pdf> for the latest version.

**SOT-563**

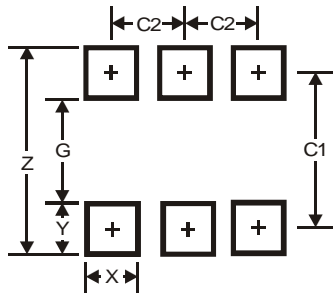

Dimensions	Value (in mm)
Z	2.2
G	1.2
X	0.375
Y	0.5
C1	1.7
C2	0.5



**IMPORTANT NOTICE**

DIODES INCORPORATED MAKES NO WARRANTY OF ANY KIND, EXPRESS OR IMPLIED, WITH REGARDS TO THIS DOCUMENT, INCLUDING, BUT NOT LIMITED TO, THE IMPLIED WARRANTIES OF MERCHANTABILITY AND FITNESS FOR A PARTICULAR PURPOSE (AND THEIR EQUIVALENTS UNDER THE LAWS OF ANY JURISDICTION).

Diodes Incorporated and its subsidiaries reserve the right to make modifications, enhancements, improvements, corrections or other changes without further notice to this document and any product described herein. Diodes Incorporated does not assume any liability arising out of the application or use of this document or any product described herein; neither does Diodes Incorporated convey any license under its patent or trademark rights, nor the rights of others. Any Customer or user of this document or products described herein in such applications shall assume all risks of such use and will agree to hold Diodes Incorporated and all the companies whose products are represented on Diodes Incorporated website, harmless against all damages.

Diodes Incorporated does not warrant or accept any liability whatsoever in respect of any products purchased through unauthorized sales channel. Should Customers purchase or use Diodes Incorporated products for any unintended or unauthorized application, Customers shall indemnify and hold Diodes Incorporated and its representatives harmless against all claims, damages, expenses, and attorney fees arising out of, directly or indirectly, any claim of personal injury or death associated with such unintended or unauthorized application.

Products described herein may be covered by one or more United States, international or foreign patents pending. Product names and markings noted herein may also be covered by one or more United States, international or foreign trademarks.

This document is written in English but may be translated into multiple languages for reference. Only the English version of this document is the final and determinative format released by Diodes Incorporated.

**LIFE SUPPORT**

Diodes Incorporated products are specifically not authorized for use as critical components in life support devices or systems without the express written approval of the Chief Executive Officer of Diodes Incorporated. As used herein:

A. Life support devices or systems are devices or systems which:

1. are intended to implant into the body, or
2. support or sustain life and whose failure to perform when properly used in accordance with instructions for use provided in the labeling can be reasonably expected to result in significant injury to the user.

B. A critical component is any component in a life support device or system whose failure to perform can be reasonably expected to cause the failure of the life support device or to affect its safety or effectiveness.

Customers represent that they have all necessary expertise in the safety and regulatory ramifications of their life support devices or systems, and acknowledge and agree that they are solely responsible for all legal, regulatory and safety-related requirements concerning their products and any use of Diodes Incorporated products in such safety-critical, life support devices or systems, notwithstanding any devices- or systems-related information or support that may be provided by Diodes Incorporated. Further, Customers must fully indemnify Diodes Incorporated and its representatives against any damages arising out of the use of Diodes Incorporated products in such safety-critical, life support devices or systems.

Copyright © 2015, Diodes Incorporated

[www.diodes.com](http://www.diodes.com)



Компания «ЭлектроПласт» предлагает заключение долгосрочных отношений при поставках импортных электронных компонентов на взаимовыгодных условиях!

Наши преимущества:

- Оперативные поставки широкого спектра электронных компонентов отечественного и импортного производства напрямую от производителей и с крупнейших мировых складов;
- Поставка более 17-ти миллионов наименований электронных компонентов;
- Поставка сложных, дефицитных, либо снятых с производства позиций;
- Оперативные сроки поставки под заказ (от 5 рабочих дней);
- Экспресс доставка в любую точку России;
- Техническая поддержка проекта, помощь в подборе аналогов, поставка прототипов;
- Система менеджмента качества сертифицирована по Международному стандарту ISO 9001;
- Лицензия ФСБ на осуществление работ с использованием сведений, составляющих государственную тайну;
- Поставка специализированных компонентов (Xilinx, Altera, Analog Devices, Intersil, Interpoint, Microsemi, Aeroflex, Peregrine, Syfer, Eurofarad, Texas Instrument, Miteq, Cobham, E2V, MA-COM, Hittite, Mini-Circuits, General Dynamics и др.);

Помимо этого, одним из направлений компании «ЭлектроПласт» является направление «Источники питания». Мы предлагаем Вам помощь Конструкторского отдела:

- Подбор оптимального решения, техническое обоснование при выборе компонента;
- Подбор аналогов;
- Консультации по применению компонента;
- Поставка образцов и прототипов;
- Техническая поддержка проекта;
- Защита от снятия компонента с производства.



#### Как с нами связаться

**Телефон:** 8 (812) 309 58 32 (многоканальный)

**Факс:** 8 (812) 320-02-42

**Электронная почта:** [org@eplast1.ru](mailto:org@eplast1.ru)

**Адрес:** 198099, г. Санкт-Петербург, ул. Калинина, дом 2, корпус 4, литера А.