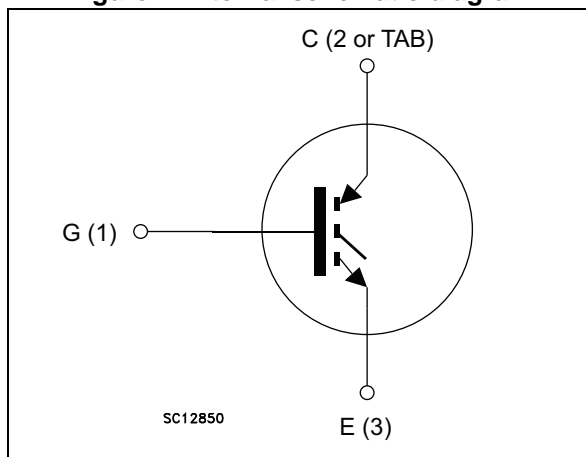

Figure 1. Internal schematic diagram



### Features

- Maximum junction temperature:  $T_J = 175\text{ °C}$
- Tail-less switching off
- $V_{CE(sat)} = 1.85\text{ V (typ.) @ } I_C = 80\text{ A}$
- Tight parameters distribution
- Safe paralleling
- Low thermal resistance

### Applications

- Photovoltaic inverters
- Uninterruptible power supply
- Welding
- Power factor correction
- Very high frequency converters

### Description

This device is an IGBT developed using an advanced proprietary trench gate field stop structure. The device is part of the V series of IGBTs, which represent an optimum compromise between conduction and switching losses to maximize the efficiency of very high frequency converters. Furthermore, a positive  $V_{CE(sat)}$  temperature coefficient and very tight parameter distribution result in safer paralleling operation.

Table 1. Device summary

Order code	Marking	Package	Packaging
STGFW80V60F	GFW80V60F	TO-3PF	Tube
STGW80V60F	GW80V60F	TO-247	Tube
STGWT80V60F	GWT80V60F	TO-3P	Tube

# Contents

<b>1</b>	<b>Electrical ratings</b> .....	<b>3</b>
<b>2</b>	<b>Electrical characteristics</b> .....	<b>4</b>
2.1	Electrical characteristics (curves) .....	6
<b>3</b>	<b>Test circuits</b> .....	<b>11</b>
<b>4</b>	<b>Package mechanical data</b> .....	<b>12</b>
4.1	TO-3PF, STGFW80V60F .....	12
4.2	TO-247, STGW80V60F .....	14
4.3	TO-3P, STGWT80V60F .....	16
<b>5</b>	<b>Revision history</b> .....	<b>18</b>

# 1 Electrical ratings

**Table 2. Absolute maximum ratings**

Symbol	Parameter	Value		Unit
		TO-247 TO-3P	TO-3PF	
$V_{CES}$	Collector-emitter voltage ( $V_{GE} = 0$ )	600		V
$I_C$	Continuous collector current at $T_C = 25\text{ °C}$	120 <sup>(1)</sup>		A
$I_C$	Continuous collector current at $T_C = 100\text{ °C}$	80		A
$I_{CP}$ <sup>(2)</sup>	Pulsed collector current	240		A
$V_{GE}$	Gate-emitter voltage	±20		V
$P_{TOT}$	Total dissipation at $T_C = 25\text{ °C}$	469	79	W
$V_{ISO}$	Insulation withstand voltage (RMS) from all three leads to external heat sink ( $t = 1\text{ s}$ ; $T_C = 25\text{ °C}$ )	3.5		kV
$T_{STG}$	Storage temperature range	- 55 to 150		°C
$T_J$	Operating junction temperature	- 55 to 175		°C

1. Current level is limited by bond wires.
2. Pulse width limited by maximum junction temperature.

**Table 3. Thermal data**

Symbol	Parameter	Value		Unit
		TO-247 TO-3P	TO-3PF	
$R_{thJC}$	Thermal resistance junction-case	0.32	1.9	°C/W
$R_{thJA}$	Thermal resistance junction-ambient	50		°C/W

## 2 Electrical characteristics

$T_J = 25\text{ °C}$  unless otherwise specified.

**Table 4. Static characteristics**

Symbol	Parameter	Test conditions	Min.	Typ.	Max.	Unit
$V_{(BR)CES}$	Collector-emitter breakdown voltage ( $V_{GE} = 0$ )	$I_C = 2\text{ mA}$	600			V
$V_{CE(sat)}$	Collector-emitter saturation voltage	$V_{GE} = 15\text{ V}, I_C = 80\text{ A}$		1.85	2.3	V
		$V_{GE} = 15\text{ V}, I_C = 80\text{ A}$ $T_J = 125\text{ °C}$		2.15		
		$V_{GE} = 15\text{ V}, I_C = 80\text{ A}$ $T_J = 175\text{ °C}$		2.4		
$V_{GE(th)}$	Gate threshold voltage	$V_{CE} = V_{GE}, I_C = 1\text{ mA}$	5	6	7	V
$I_{CES}$	Collector cut-off current ( $V_{GE} = 0$ )	$V_{CE} = 600\text{ V}$			100	$\mu\text{A}$
$I_{GES}$	Gate-emitter leakage current ( $V_{CE} = 0$ )	$V_{GE} = \pm 20\text{ V}$			250	nA

**Table 5. Dynamic characteristics**

Symbol	Parameter	Test conditions	Min.	Typ.	Max.	Unit
$C_{ies}$	Input capacitance	$V_{CE} = 25\text{ V}, f = 1\text{ MHz},$ $V_{GE} = 0$	-	10800	-	nF
$C_{oes}$	Output capacitance		-	390	-	pF
$C_{res}$	Reverse transfer capacitance		-	220	-	pF
$Q_g$	Total gate charge	$V_{CC} = 480\text{ V}, I_C = 80\text{ A},$ $V_{GE} = 15\text{ V},$ see <a href="#">Figure 28</a>	-	448	-	nC
$Q_{ge}$	Gate-emitter charge		-	76	-	nC
$Q_{gc}$	Gate-collector charge		-	184	-	nC

Table 6. Switching characteristics (inductive load)

Symbol	Parameter	Test conditions	Min.	Typ.	Max.	Unit
$t_{d(on)}$	Turn-on delay time	$V_{CE} = 400\text{ V}$ , $I_C = 80\text{ A}$ , $R_G = 10\ \Omega$ , $V_{GE} = 15\text{ V}$ , see <a href="#">Figure 27</a>	-	60	-	ns
$t_r$	Current rise time		-	30	-	ns
$(di/dt)_{on}$	Turn-on current slope		-	2200	-	A/ $\mu\text{s}$
$t_{d(off)}$	Turn-off delay time		-	220	-	ns
$t_f$	Current fall time		-	17	-	ns
$E_{on}^{(1)}$	Turn-on switching losses		-	1.8	-	mJ
$E_{off}^{(2)}$	Turn-off switching losses		-	1	-	mJ
$E_{ts}$	Total switching losses	-	2.8	-	mJ	
$t_{d(on)}$	Turn-on delay time	$V_{CE} = 400\text{ V}$ , $I_C = 80\text{ A}$ , $R_G = 10\ \Omega$ , $V_{GE} = 15\text{ V}$ , $T_J = 175\text{ }^\circ\text{C}$ , see <a href="#">Figure 27</a>	-	60	-	ns
$t_r$	Current rise time		-	30	-	ns
$(di/dt)_{on}$	Turn-on current slope		-	2100	-	A/ $\mu\text{s}$
$t_{d(off)}$	Turn-off delay time		-	240	-	ns
$t_f$	Current fall time		-	22	-	ns
$E_{on}^{(1)}$	Turn-on switching losses		-	3.8	-	mJ
$E_{off}^{(2)}$	Turn-off switching losses		-	1.25	-	mJ
$E_{ts}$	Total switching losses	-	5.05	-	mJ	

1. Energy loss include reverse recovery of the external diode. The diode is the same of the co-packed STGW80V60DF
2. Turn-off losses include also the tail of the collector current.

## 2.1 Electrical characteristics (curves)

Figure 2. Power dissipation vs. case temperature for TO-247 and TO-3P

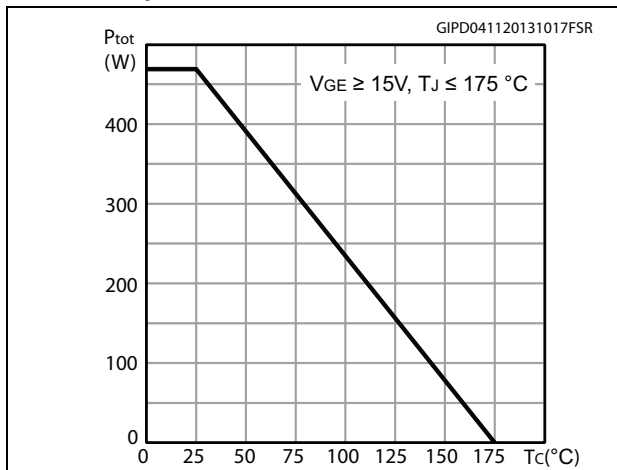

Figure 3. Collector current vs. case temperature for TO-247 and TO-3P

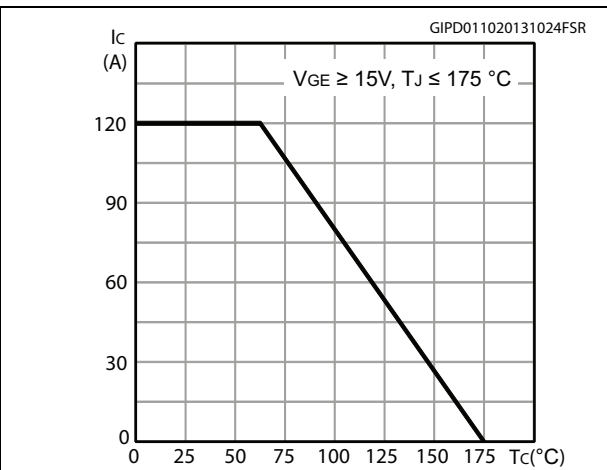

Figure 4. Power dissipation vs. case temperature for TO-3PF

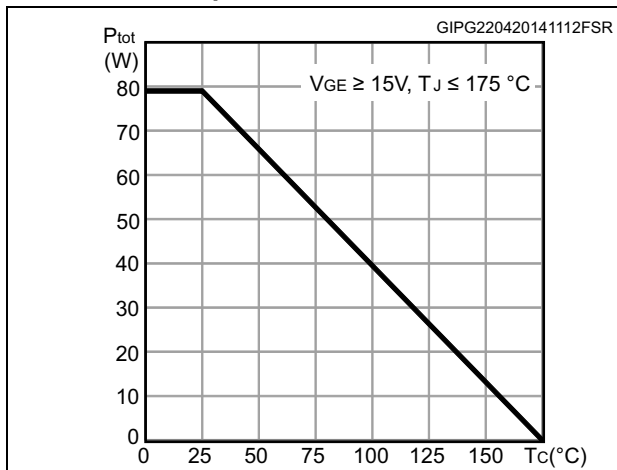

Figure 5. Collector current vs. case temperature for TO-3PF

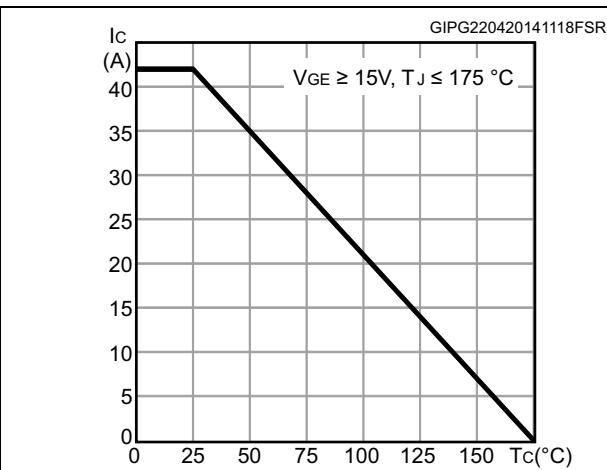

Figure 6. Output characteristics (T<sub>J</sub> = 25°C)

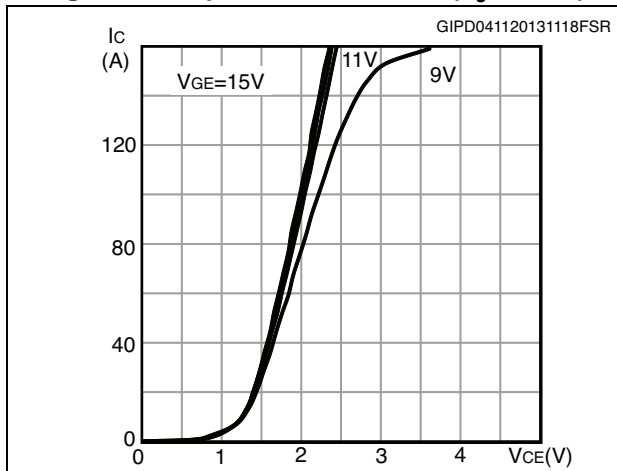

Figure 7. Output characteristics (T<sub>J</sub> = 175°C)

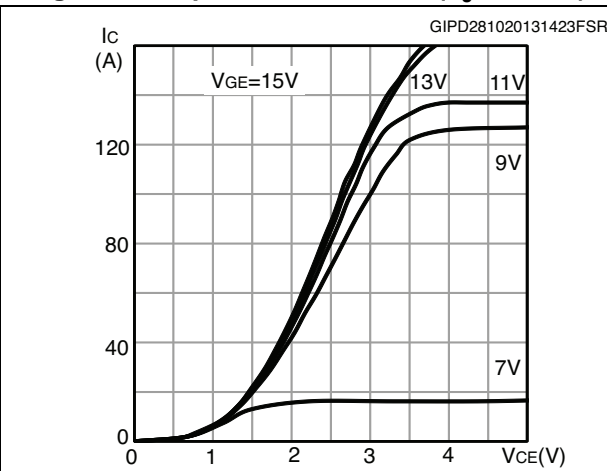

Figure 8.  $V_{CE(sat)}$  vs. junction temperature

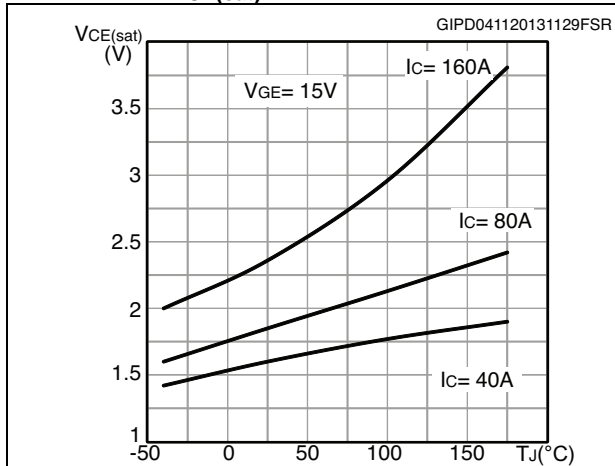

Figure 9.  $V_{CE(sat)}$  vs. collector current

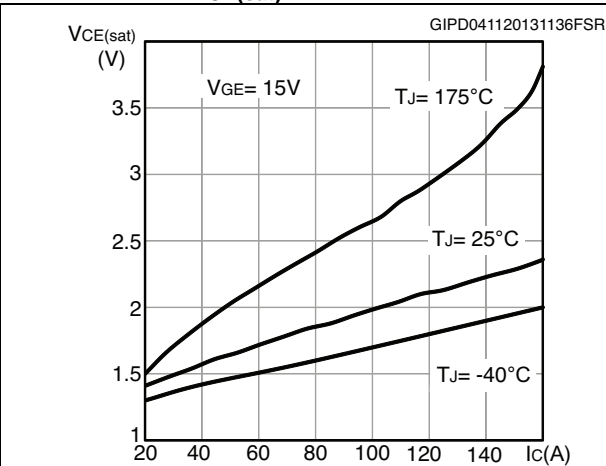

Figure 10. Collector current vs. switching frequency for TO-247 and TO-3P

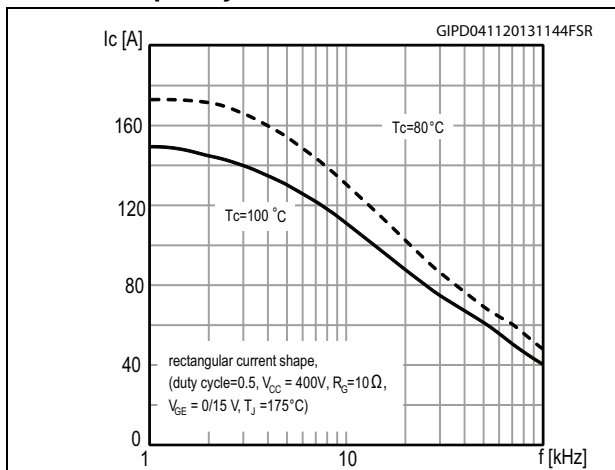

Figure 11. Collector current vs. switching frequency for TO-3PF

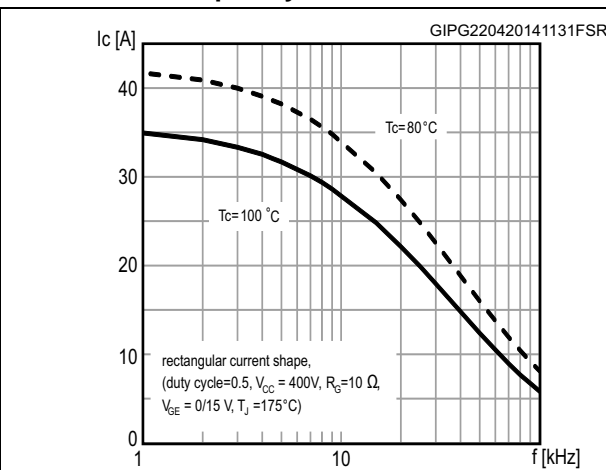

Figure 12. Forward bias safe operating area for TO-247 and TO-3P

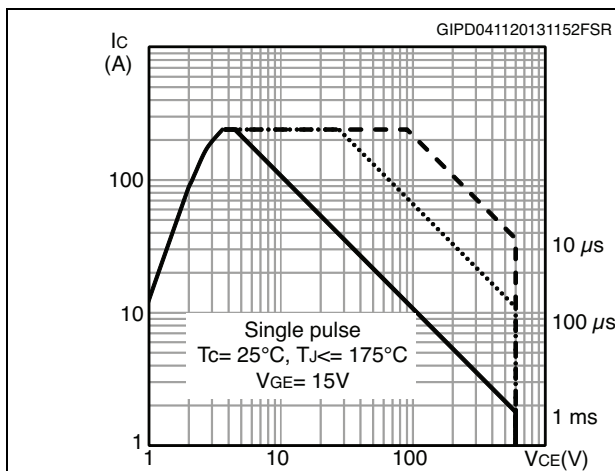

Figure 13. Forward bias safe operating area for TO-3PF

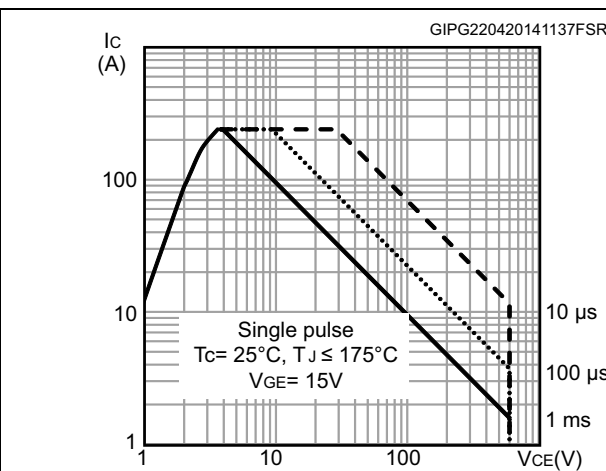

Figure 14. Normalized  $V_{GE(th)}$  vs junction temperature

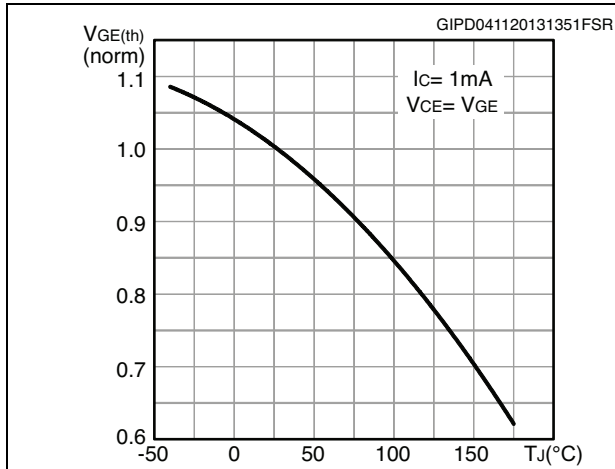

Figure 15. Normalized  $V_{(BR)CES}$  vs. junction temperature

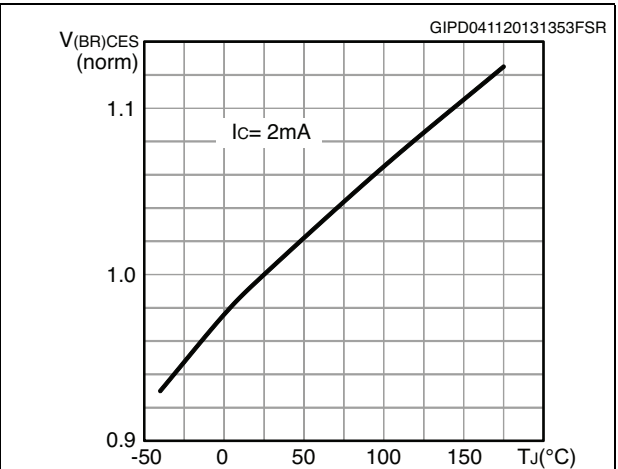

Figure 16. Capacitance variation

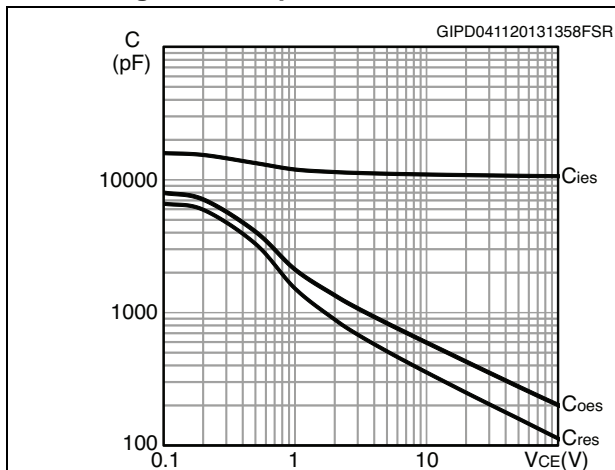

Figure 17. Gate charge vs. gate-emitter voltage

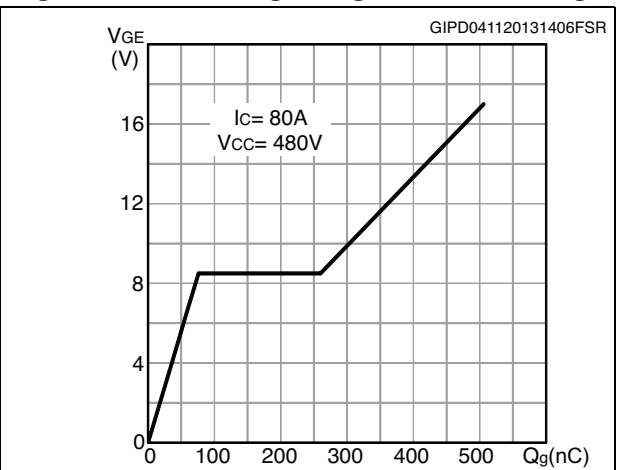

Figure 18. Switching loss vs collector current

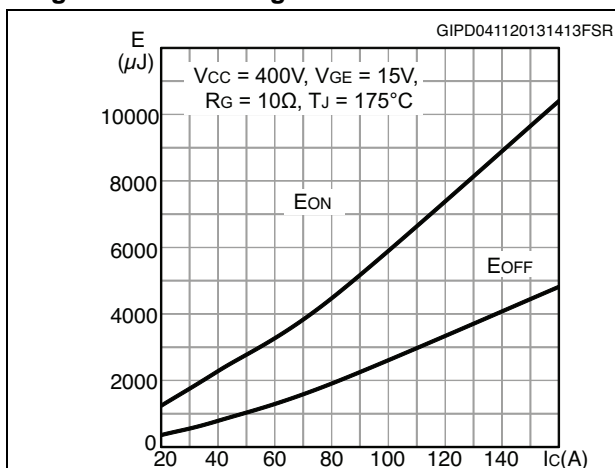

Figure 19. Switching loss vs gate resistance

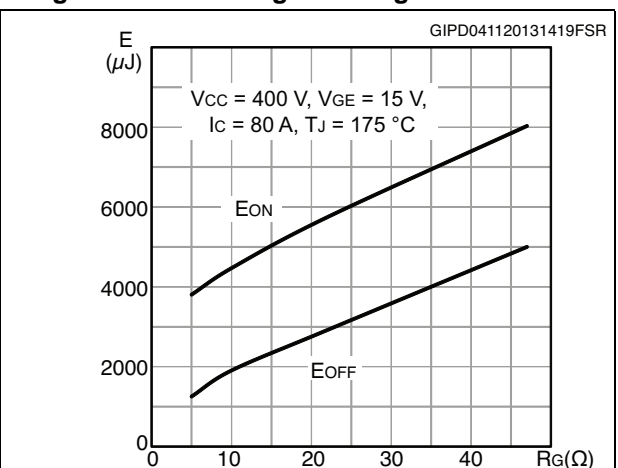



Figure 20. Switching loss vs temperature

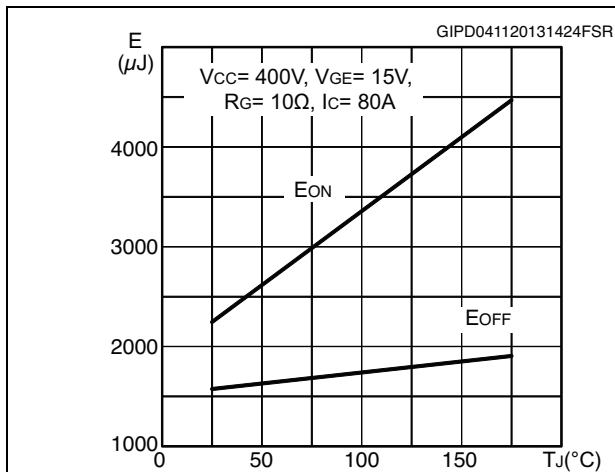

Figure 21. Switching loss vs collector-emitter voltage

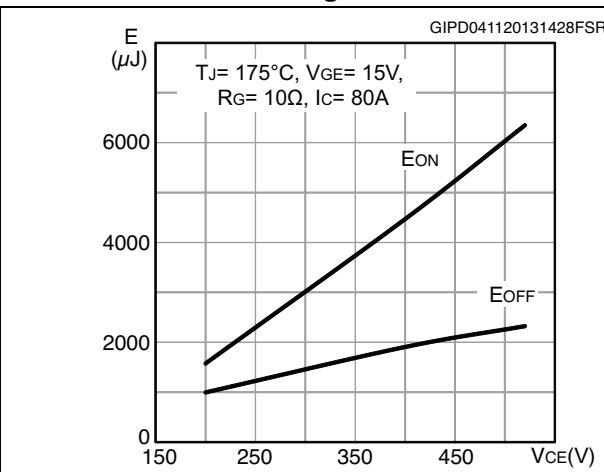

Figure 22. Switching times vs. collector current

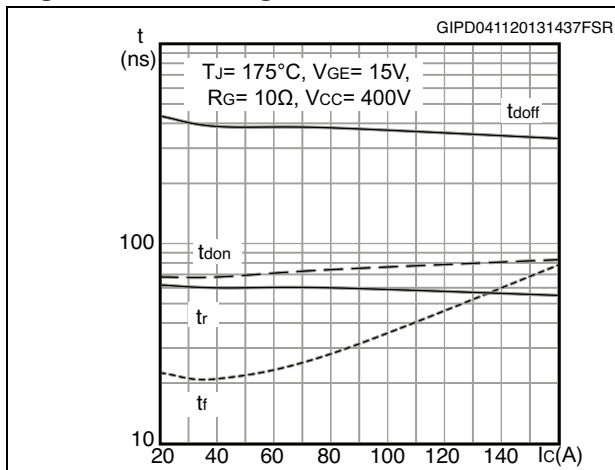

Figure 23. Switching times vs. gate resistance

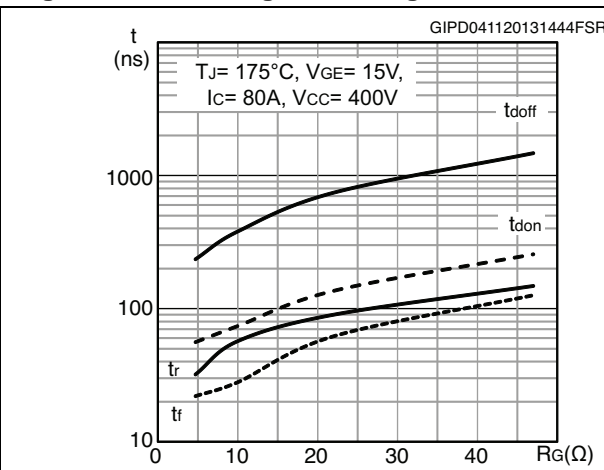

Figure 24. Transfer characteristics

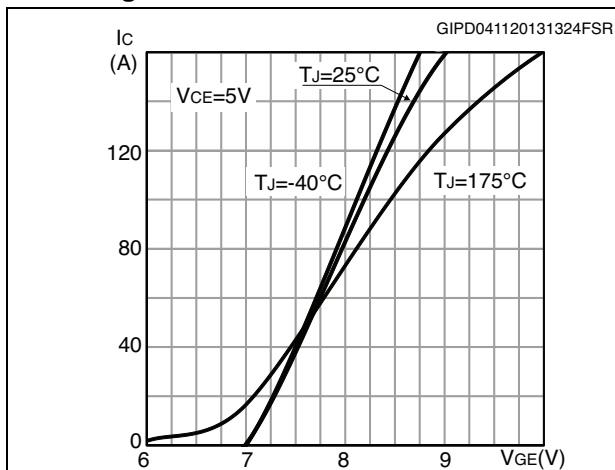

Figure 25. Thermal impedance for TO-247 and TO-3P

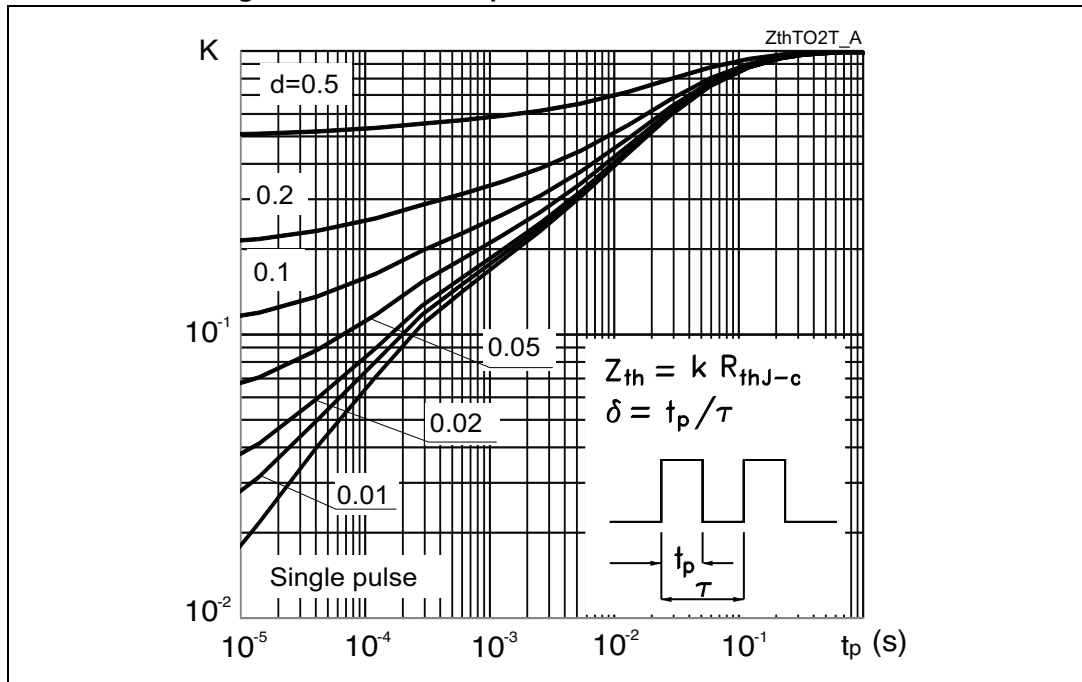
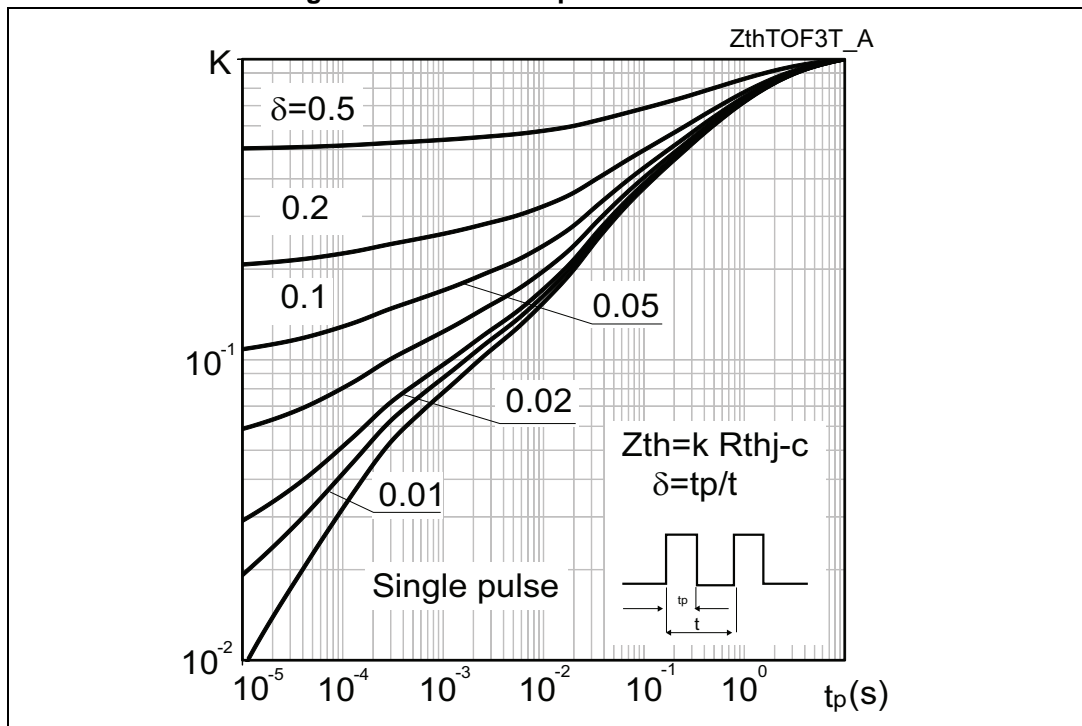

Figure 26. Thermal impedance for TO-3PF



### 3 Test circuits

Figure 27. Test circuit for inductive load switching



Figure 28. Gate charge test circuit

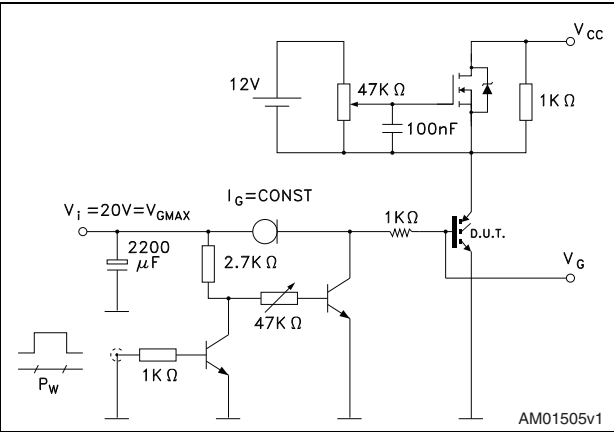

Figure 29. Switching waveform



## 4 Package mechanical data

In order to meet environmental requirements, ST offers these devices in different grades of ECOPACK® packages, depending on their level of environmental compliance. ECOPACK® specifications, grade definitions and product status are available at: [www.st.com](http://www.st.com). ECOPACK is an ST trademark.

### 4.1 TO-3PF, STGFW80V60F

Figure 30. TO-3PF drawing

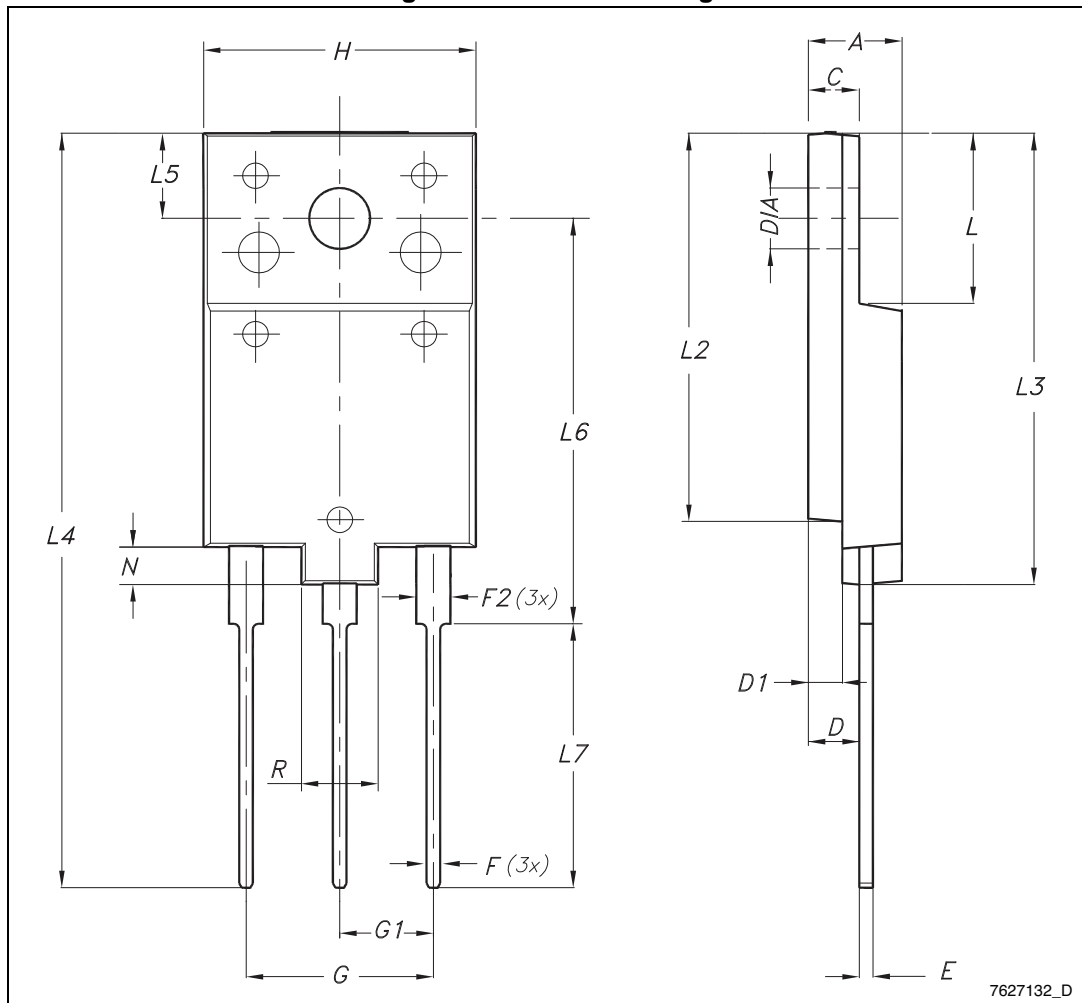

7627132\_D

Table 7. TO-3PF mechanical data

Dim.	mm		
	Min.	Typ.	Max.
A	5.30		5.70
C	2.80		3.20
D	3.10		3.50
D1	1.80		2.20
E	0.80		1.10
F	0.65		0.95
F2	1.80		2.20
G	10.30		11.50
G1		5.45	
H	15.30		15.70
L	9.80	10	10.20
L2	22.80		23.20
L3	26.30		26.70
L4	43.20		44.40
L5	4.30		4.70
L6	24.30		24.70
L7	14.60		15
N	1.80		2.20
R	3.80		4.20
Dia	3.40		3.80

### 4.2 TO-247, STGW80V60F

Figure 31. TO-247 drawing

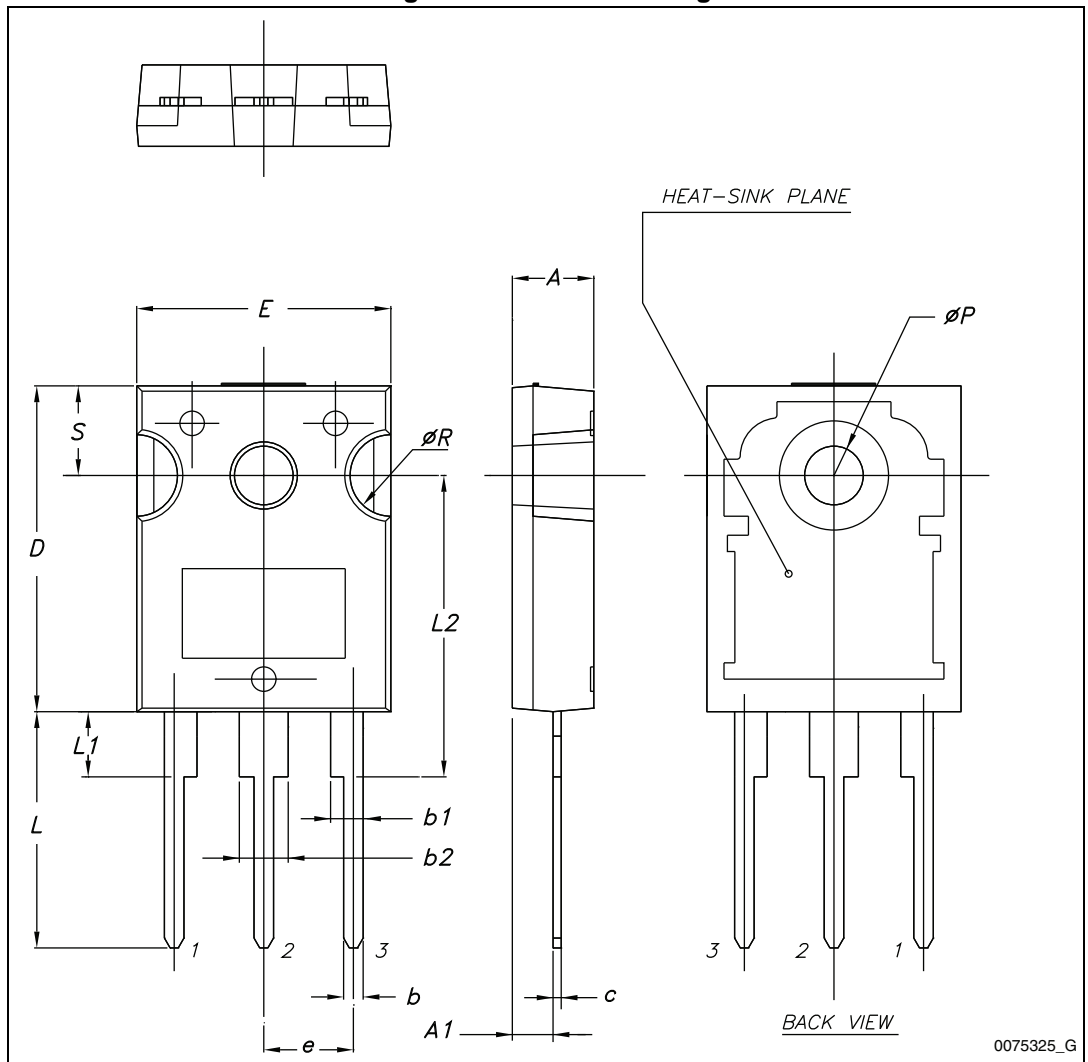
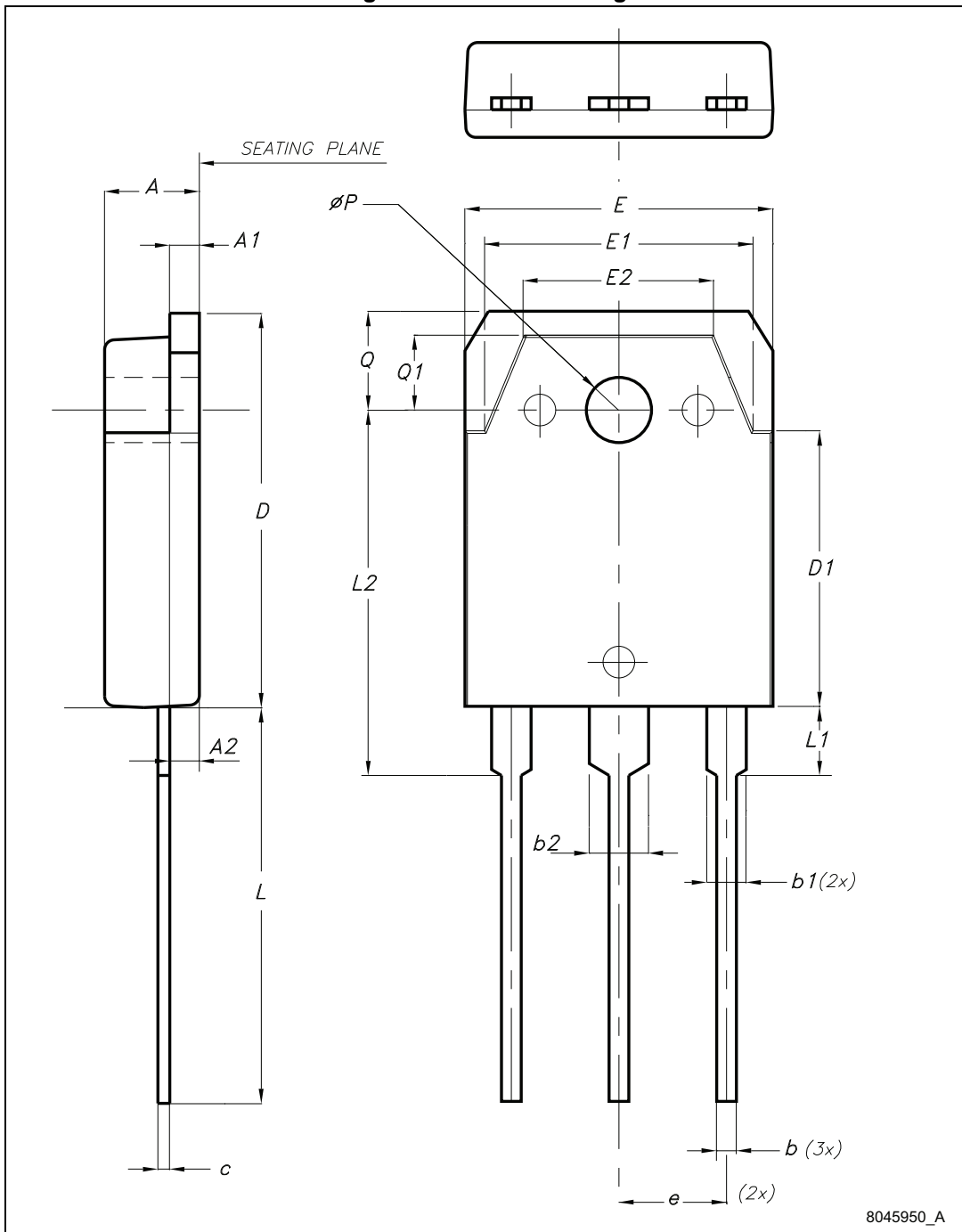

Table 8. TO-247 mechanical data

Dim.	mm.		
	Min.	Typ.	Max.
A	4.85		5.15
A1	2.20		2.60
b	1.0		1.40
b1	2.0		2.40
b2	3.0		3.40
c	0.40		0.80
D	19.85		20.15
E	15.45		15.75
e	5.30	5.45	5.60
L	14.20		14.80
L1	3.70		4.30
L2		18.50	
ØP	3.55		3.65
ØR	4.50		5.50
S	5.30	5.50	5.70

### 4.3 TO-3P, STGWT80V60F

Figure 32. TO-3P drawing



8045950\_A



Table 9. TO-3P mechanical data

Dim.	mm		
	Min.	Typ.	Max.
A	4.60		5
A1	1.45	1.50	1.65
A2	1.20	1.40	1.60
b	0.80	1	1.20
b1	1.80		2.20
b2	2.80		3.20
c	0.55	0.60	0.75
D	19.70	19.90	20.10
D1		13.90	
E	15.40		15.80
E1		13.60	
E2		9.60	
e	5.15	5.45	5.75
L	19.50	20	20.50
L1		3.50	
L2	18.20	18.40	18.60
øP	3.10		3.30
Q		5	
Q1		3.80	

## 5 Revision history

Table 10. Document revision history

Date	Revision	Changes
22-May-2014	1	Initial release.

**Please Read Carefully:**

Information in this document is provided solely in connection with ST products. STMicroelectronics NV and its subsidiaries ("ST") reserve the right to make changes, corrections, modifications or improvements, to this document, and the products and services described herein at any time, without notice.

All ST products are sold pursuant to ST's terms and conditions of sale.

Purchasers are solely responsible for the choice, selection and use of the ST products and services described herein, and ST assumes no liability whatsoever relating to the choice, selection or use of the ST products and services described herein.

No license, express or implied, by estoppel or otherwise, to any intellectual property rights is granted under this document. If any part of this document refers to any third party products or services it shall not be deemed a license grant by ST for the use of such third party products or services, or any intellectual property contained therein or considered as a warranty covering the use in any manner whatsoever of such third party products or services or any intellectual property contained therein.

**UNLESS OTHERWISE SET FORTH IN ST'S TERMS AND CONDITIONS OF SALE ST DISCLAIMS ANY EXPRESS OR IMPLIED WARRANTY WITH RESPECT TO THE USE AND/OR SALE OF ST PRODUCTS INCLUDING WITHOUT LIMITATION IMPLIED WARRANTIES OF MERCHANTABILITY, FITNESS FOR A PARTICULAR PURPOSE (AND THEIR EQUIVALENTS UNDER THE LAWS OF ANY JURISDICTION), OR INFRINGEMENT OF ANY PATENT, COPYRIGHT OR OTHER INTELLECTUAL PROPERTY RIGHT.**

**ST PRODUCTS ARE NOT DESIGNED OR AUTHORIZED FOR USE IN: (A) SAFETY CRITICAL APPLICATIONS SUCH AS LIFE SUPPORTING, ACTIVE IMPLANTED DEVICES OR SYSTEMS WITH PRODUCT FUNCTIONAL SAFETY REQUIREMENTS; (B) AERONAUTIC APPLICATIONS; (C) AUTOMOTIVE APPLICATIONS OR ENVIRONMENTS, AND/OR (D) AEROSPACE APPLICATIONS OR ENVIRONMENTS. WHERE ST PRODUCTS ARE NOT DESIGNED FOR SUCH USE, THE PURCHASER SHALL USE PRODUCTS AT PURCHASER'S SOLE RISK, EVEN IF ST HAS BEEN INFORMED IN WRITING OF SUCH USAGE, UNLESS A PRODUCT IS EXPRESSLY DESIGNATED BY ST AS BEING INTENDED FOR "AUTOMOTIVE, AUTOMOTIVE SAFETY OR MEDICAL" INDUSTRY DOMAINS ACCORDING TO ST PRODUCT DESIGN SPECIFICATIONS. PRODUCTS FORMALLY ESCC, QML OR JAN QUALIFIED ARE DEEMED SUITABLE FOR USE IN AEROSPACE BY THE CORRESPONDING GOVERNMENTAL AGENCY.**

Resale of ST products with provisions different from the statements and/or technical features set forth in this document shall immediately void any warranty granted by ST for the ST product or service described herein and shall not create or extend in any manner whatsoever, any liability of ST.

ST and the ST logo are trademarks or registered trademarks of ST in various countries.

Information in this document supersedes and replaces all information previously supplied.

The ST logo is a registered trademark of STMicroelectronics. All other names are the property of their respective owners.

© 2014 STMicroelectronics - All rights reserved

STMicroelectronics group of companies

Australia - Belgium - Brazil - Canada - China - Czech Republic - Finland - France - Germany - Hong Kong - India - Israel - Italy - Japan - Malaysia - Malta - Morocco - Philippines - Singapore - Spain - Sweden - Switzerland - United Kingdom - United States of America

[www.st.com](http://www.st.com)



Компания «ЭлектроПласт» предлагает заключение долгосрочных отношений при поставках импортных электронных компонентов на взаимовыгодных условиях!

Наши преимущества:

- Оперативные поставки широкого спектра электронных компонентов отечественного и импортного производства напрямую от производителей и с крупнейших мировых складов;
- Поставка более 17-ти миллионов наименований электронных компонентов;
- Поставка сложных, дефицитных, либо снятых с производства позиций;
- Оперативные сроки поставки под заказ (от 5 рабочих дней);
- Экспресс доставка в любую точку России;
- Техническая поддержка проекта, помощь в подборе аналогов, поставка прототипов;
- Система менеджмента качества сертифицирована по Международному стандарту ISO 9001;
- Лицензия ФСБ на осуществление работ с использованием сведений, составляющих государственную тайну;
- Поставка специализированных компонентов (Xilinx, Altera, Analog Devices, Intersil, Interpoint, Microsemi, Aeroflex, Peregrine, Syfer, Eurofarad, Texas Instrument, Miteq, Cobham, E2V, MA-COM, Hittite, Mini-Circuits, General Dynamics и др.);

Помимо этого, одним из направлений компании «ЭлектроПласт» является направление «Источники питания». Мы предлагаем Вам помощь Конструкторского отдела:

- Подбор оптимального решения, техническое обоснование при выборе компонента;
- Подбор аналогов;
- Консультации по применению компонента;
- Поставка образцов и прототипов;
- Техническая поддержка проекта;
- Защита от снятия компонента с производства.



#### Как с нами связаться

**Телефон:** 8 (812) 309 58 32 (многоканальный)

**Факс:** 8 (812) 320-02-42

**Электронная почта:** [org@eplast1.ru](mailto:org@eplast1.ru)

**Адрес:** 198099, г. Санкт-Петербург, ул. Калинина, дом 2, корпус 4, литера А.