

Toggle Switches, Tiny, Part Number Matrix

MATERIAL SPECIFICATIONS:

Contacts.....Gold over nickel or silver plate
 Case Material.....Thermoplastic 94V-0
 Terminals/Fixed Contacts.....Tin lead plate
 Terminal Seal.....Epoxy on single pole, optional
 on double pole
 Process Seal.....ES version only (see page C16 - C17)

ENVIRONMENTAL SPECIFICATIONS

Operating Temperature.....-22°F to +185°F (-30°C to +85°C)
 Storage Temperature.....-67°F to +185°F (-55°C to +85°C)
 Solder Heat Resistance.....See page M3-4
 U.L. (File E-46765).....Silver only

TYPICAL PERFORMANCE CHARACTERISTICS:

Contact Rating..... Gold: 0.4 VA max. @ 20 VDC or peak AC
 Silver (2 pos.): 3 A @ 125 VAC or 28 VDC
 Silver (3 pos.): 2 A @ 125 VAC or 28 VDC
 Initial Contact Resistance..... 20 Milliohms max.
 Contact Timing..... Break before Make
 Insulation Resistance..... 1,000 Megohms 500 VDC min.
 Dielectric Strength..... 1,000 Volts RMS @ sea level
 Plunger/Actuator Travel..... 26°
 High Torque Bushing Shoulder Yes
 Life Expectancy..... See chart below
 Note: Hardware included with switch

TT Series

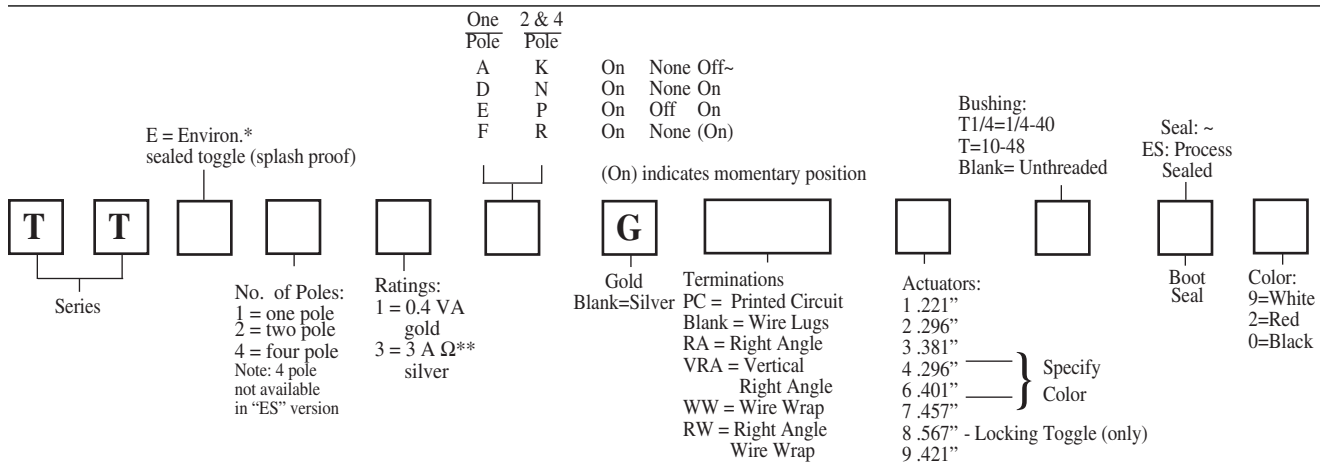

One Pole	0.4VA	80,000 (2 Pos.)	60,000 (3 Pos.)
Two Pole	0.4VA	80,000 (2 Pos.)	60,000 (3 Pos.)
Three Pole	3 Amp	20,000 (2 Pos.)	10,000 (3 Pos.)
Four Pole	0.4VA	80,000 (2 Pos.)	60,000 (3 Pos.)
Three Pole	3 Amp	20,000 (2 Pos.)	10,000 (3 Pos.)

APPLICATION NOTE:

For surface mount termination, use the "TST" series on page C5.
 For 3 pole refer to the MT Series on page C43

Actuator Dimensions shown with	
1,2,3,4,6	10-48 bushing
7,8,9	1/4-40 bushing

* Not available on 7 actuator or with VRA.
 ** Not available in RA.
 Ω Available in PC & WL only.
 ~ Available in WL & PC only.

TERMINATIONS

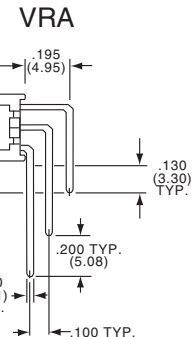
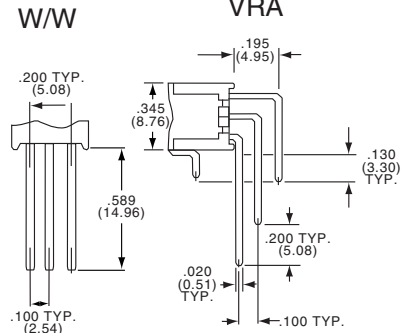
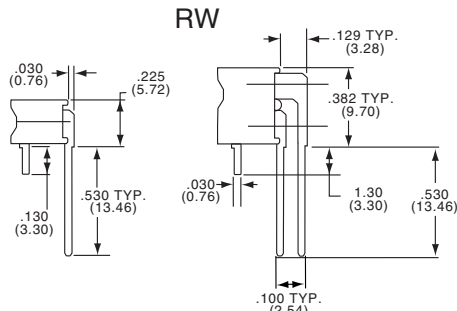
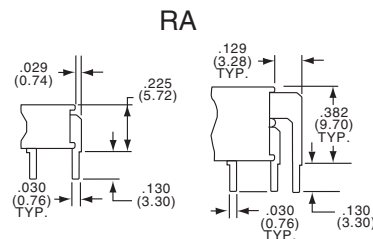
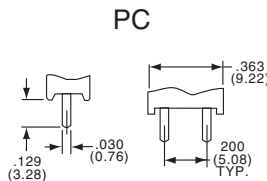
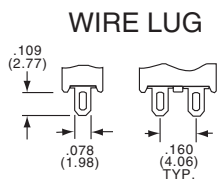

Toggle Switches, Tiny, Actuator and Bushing Options

Toggle Cap
Series C-11*
Available



TT Series

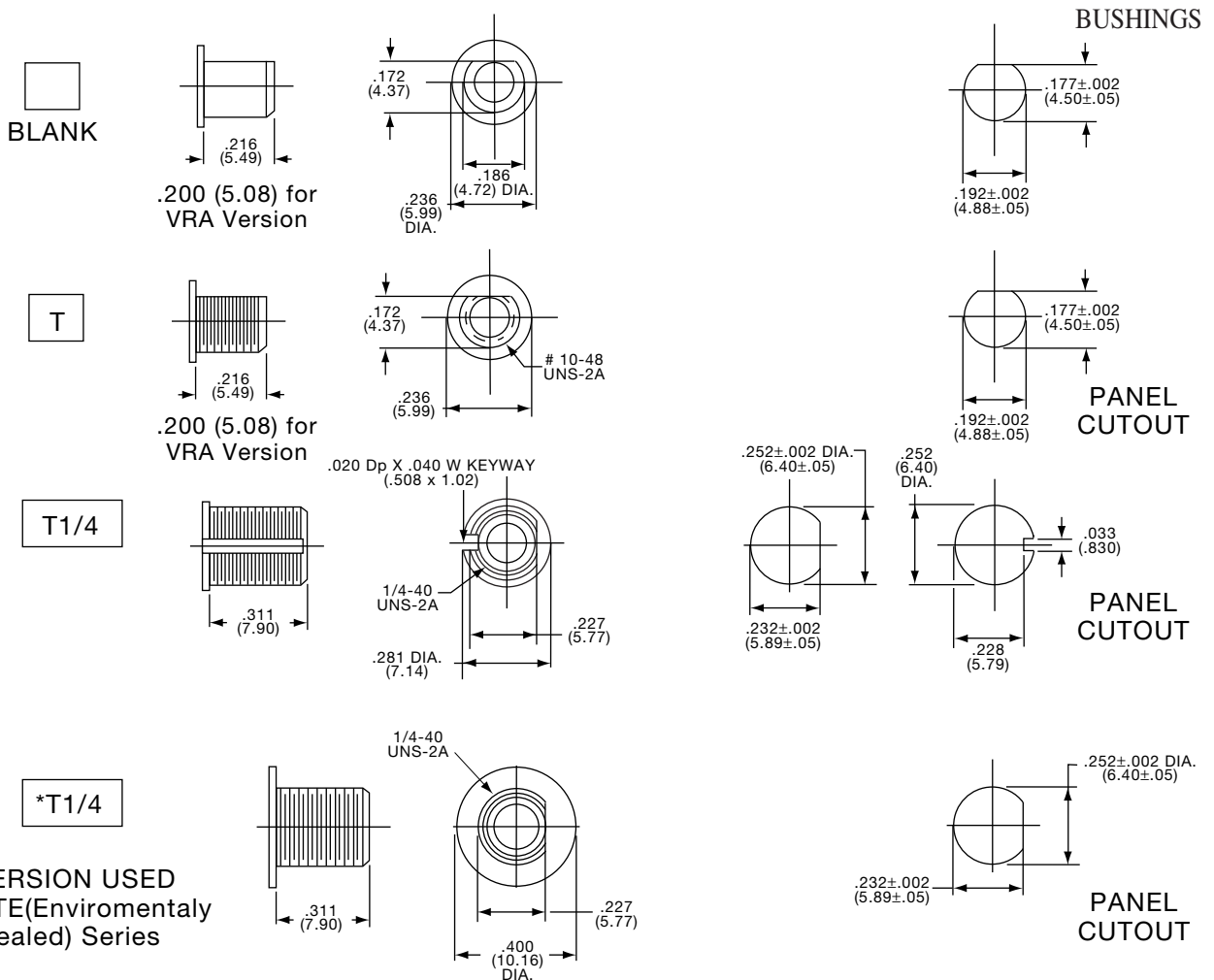

Toggle Switches, Tiny, Vertical, PC Mount

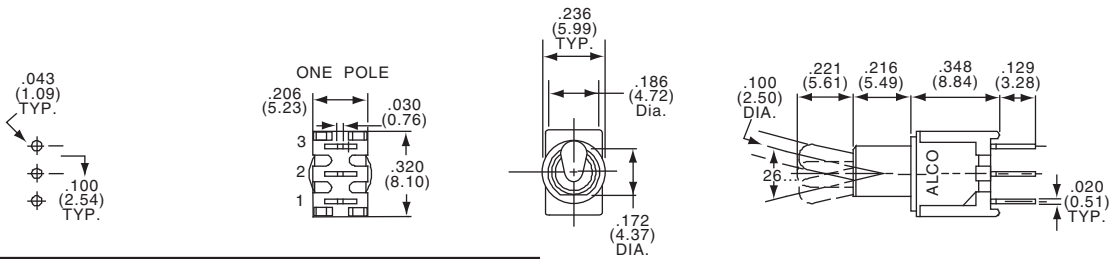

1 POLE
For Terminal Connections refer to Code Chart (see page M5-6)



TT11DGPC1

Tyco Electronics	Alcoswitch	Type	Act. Code	P.	M5	↘	↓	↙
2-1437561-3	TT11AGPC1	SPST	A	On	None	Off		
2-1437561-6	TT11DGPC1	SPDT	D	On	None	On		
5-1437561-1	TT11EGPC1	SPDT	E	On	Off	On		

Note: No center terminal on "A" switches

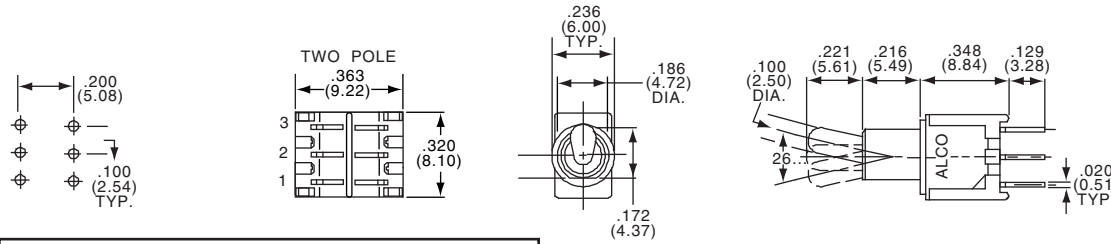

2 POLE
For Terminal Connections refer to Code Chart (see page M5-6)



TT21NGPC1

Tyco Electronics	Alcoswitch	Type	Act. Code	P.	M5	↘	↓	↙
9-1437561-9	TT21KGPC1	DPST	K	On	None	Off		
1437562-3	TT21NGPC1	DPDT	N	On	None	On		
3-1437562-4	TT21PGPC1	DPDT	P	On	Off	On		

Note: No center terminal on "K" switches

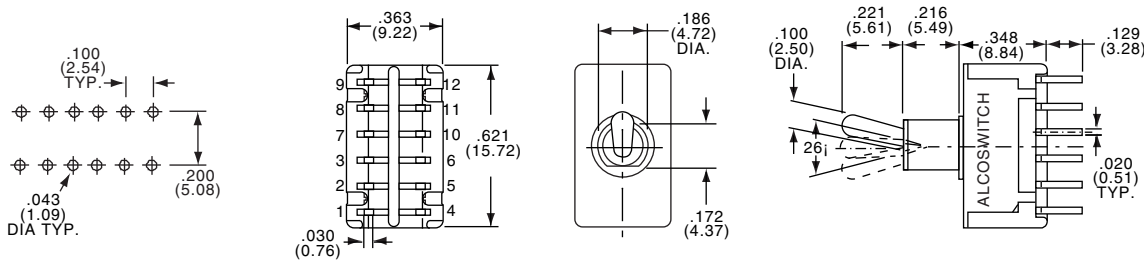

4 POLE

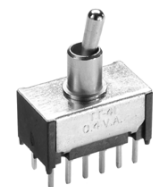

TT41NGPC1

Tyco Electronics	Alcoswitch	Type	Act. Code	P.	M5	↘	↓	↙
6-1437562-6	TT41NGPC1	4PDT	N	On	None	On		

Toggle Switches, Tiny, Vertical and Vertical Right Angle, PC Mount

SEE PAGE C8 FOR PRODUCT SPECIFICATIONS

For terminal connections refer to Code Chart on page M5-6

1 & 2 POLE

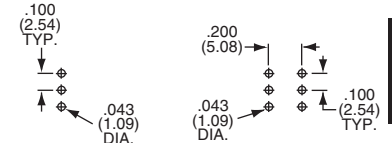
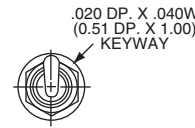
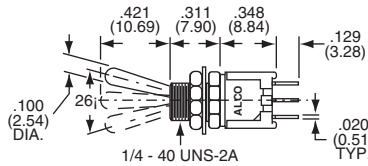

TT21NGPC9T1/4

4 POLE

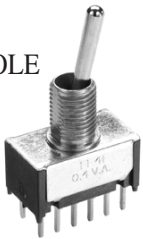

TT41NGPC9T1/4

Tyco Electronics	Alcoswitch	Type	Act.	Code	P.	M5	Tyco Electronics	Alcoswitch	Type	Act.	Code	P.	M5	
2-1437561-5	TT11AGPC9T1/4	SPST	A		On	None	Off	1-1437562-1	TT21NGPC9T1/4	DPDT	N	On	None	On
3-1437561-5	TT11DGPC9T1/4	SPDT	D		On	None	On	3-1437562-8	TT21PGPC9T1/4	DPDT	P	On	Off	On
5-1437561-9	TT11EGPC9T1/4	SPDT	E		On	Off	On	4-1437562-6	TT21RGPC9T1/4	DPDT	R	On	None	(On)
7-1437561-3	TT11FGPC9T1/4	SPDT	F		On	None	On	6-1437562-8	TT41NGPC9T1/4	4PDT	N	On	None	On
1437562-1	TT21KGPC9T1/4	DPST	K		On	None	Off	7-1437562-5	TT41PGPC9T1/4	4PDT	P	On	Off	On

Note: No center terminal on "A" or "K" switches.

(On) indicates momentary position.

Note: Hardware Included

1 & 2 POLE



TT1DGVRA1
Vertical Actuation

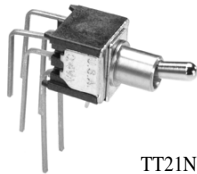

TT21NGVRA1
Vertical Actuation

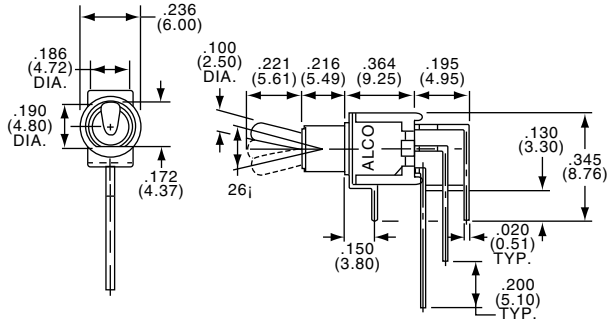
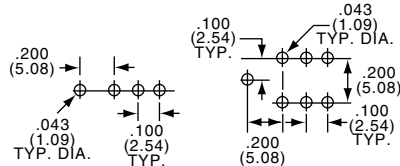
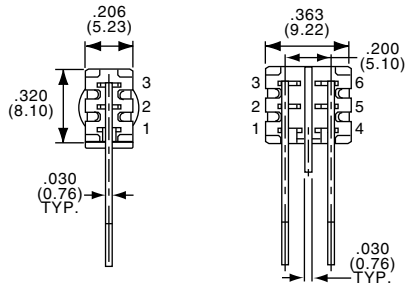

Tyco Electronics	Alcoswitch	Type	Act.	Code	P.	M5
4-1437561-8	TT11DGVRA1	SPDT	D	On	None	On
6-1437561-9	TT11EGVRA1	SPDT	E	On	Off	On
2-1437562-2	TT21NGVRA1	DPDT	N	On	None	On
4-1437562-3	TT21PGVRA1	DPDT	P	On	Off	On

1 & 2 POLE

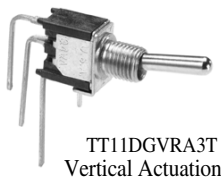

TT1DGVRA3T
Vertical Actuation

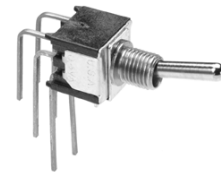

TT21NGVRA3T
Vertical Actuation

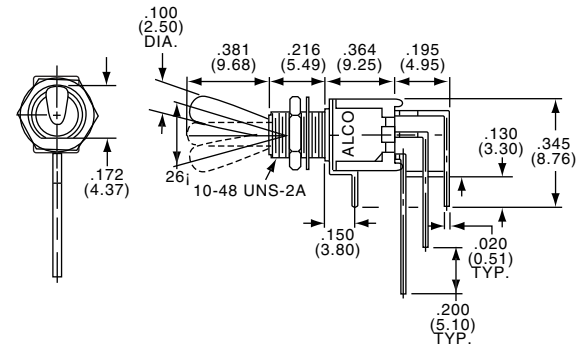
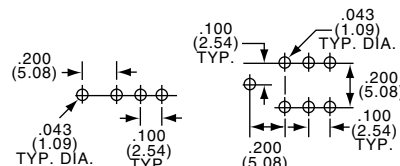
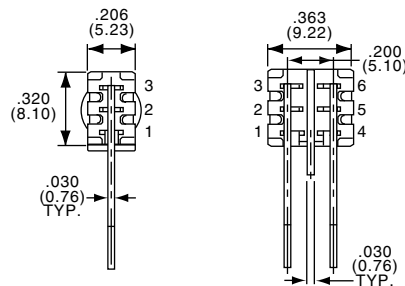

Tyco Electronics	Alcoswitch	Type	Act.	Code	P.	M5
4-1437561-9	TT11DGVRA3T	SPDT	D	On	None	On
7-1437561-0	TT11EGVRA3T	SPDT	E	On	Off	On
2-1437562-3	TT21NGVRA3T	DPDT	N	On	None	On

Toggle Switches, Tiny, Right Angle, Flat Actuator

SEE PAGE C8 FOR PRODUCT SPECIFICATIONS

* Refer to Page C8 for Other Options *

1 & 2 POLE FLAT

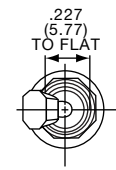
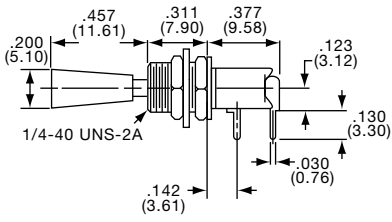
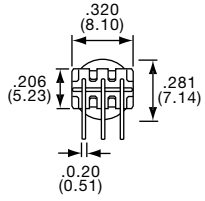
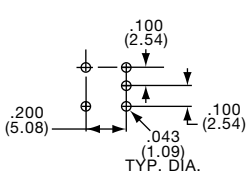

TT11DGRA7T1/4
Horizontal Actuation

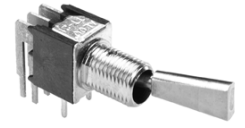
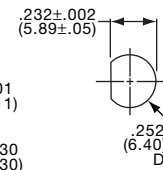
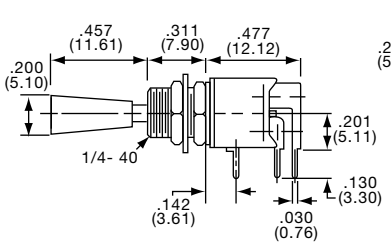
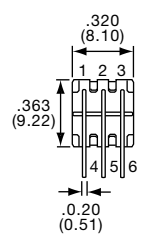
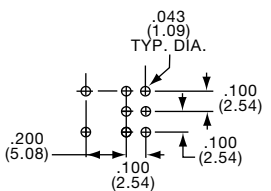

TT21NGRA7T1/4
Horizontal Actuation

Tyco Electronics	Alcoswitch	Type	Act. Code	P. M5	↘	↓	↙
4-1437561-5	TT11DGRA7T1/4	SPDT	D		On	None	On
6-1437561-7	TT11EGRA7T1/4	SPDT	E		On	Off	On
7-1437561-4	TT11FGRA7T1/4	SPDT	F		On	None	(On)
1-1437562-9	TT21NGRA7T1/4	DPDT	N		On	None	On
4-1437562-0	TT21PGRA7T1/4	DPDT	P		On	Off	On

(On) indicates momentary position

Pinned for Anti-Rotation

4 POLE FLAT

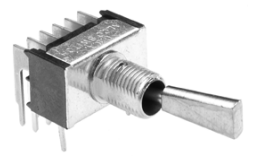
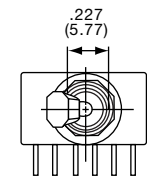
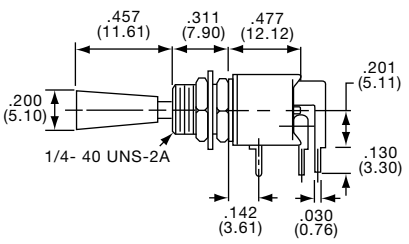
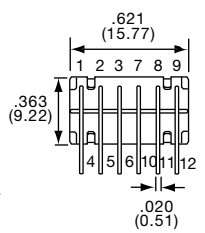
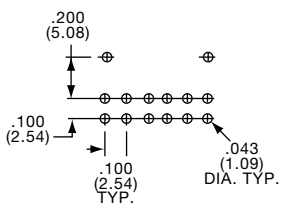

TT41NGRA7T14
Horizontal Actuation

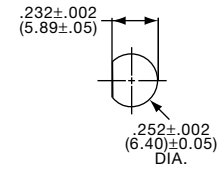

Tyco Electronics	Alcoswitch	Type	Act. Code	P. M5	↘	↓	↙
7-1437562-2	TT41NGRA7T1/4	4PDT	N		On	None	On

Pinned for Anti-Rotation

Toggle Switches, Tiny, Wire Wrap Termination

SEE PAGE C8 FOR PRODUCT SPECIFICATIONS

For terminal connections refer to Code Chart on page M5-6

1 POLE



TT11DGWW2T

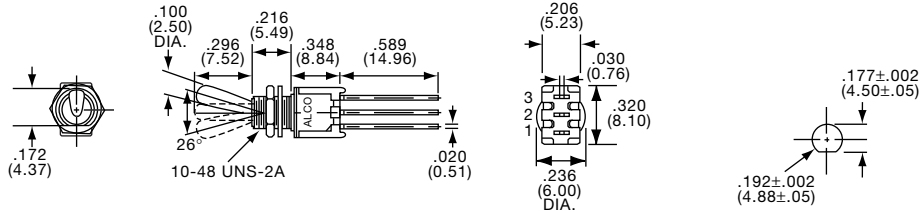

Tyco Electronics	Alcoswitch	Type	Act. Code P. M5		
5-1437561-0	TT11DGWW2T	SPDT	D	On	None On
7-1437561-1	TT11EGWW2T	SPDT	E	On	Off On

2 POLE



TT21NGWW2T

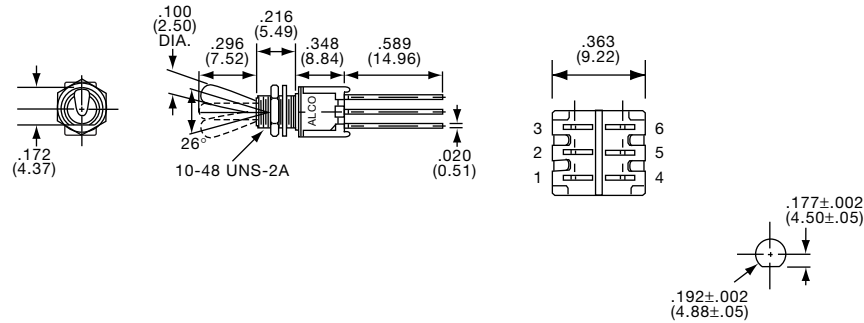

Tyco Electronics	Alcoswitch	Type	Act. Code P. M5		
2-1437562-4	TT21NGWW2T	DPDT	N	On	None On
4-1437562-4	TT21PGWW2T	DPDT	P	On	Off On

4 POLE

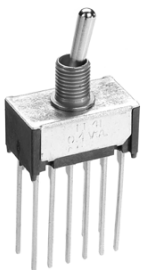

TT41NGWW2T



Tyco Electronics	Alcoswitch	Type	Act. Code P. M5		
7-1437562-4	TT41NGWW2T	4PDT	N	On	None On

Toggle Switches, Tiny, Wire Lug, Round or Flat Actuators

SEE PAGE C8 FOR PRODUCT SPECIFICATIONS

For terminal connections refer to Code Chart on page M5-6

NOTICE: Wire lug terminals accept two No. 20 AWG wires.



1 & 2 POLE



TT13D2T



TT23N2T

4 POLE

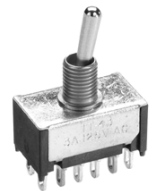

TT43N2T

Tyco Electronics	Alcoswitch	Type	Act. Code P. M5	On	None	Off	Tyco Electronics	Alcoswitch	Type	Act. Code P. M5	On	None	Off
7-1437561-8	TT13A2T	SPST	A	On	None	Off	5-1437562-1	TT23N2T	DPDT	N	On	None	On
8-1437561-5	TT13D2T	SPDT	D	On	None	On	5-1437562-7	TT23P2T	DPDT	P	On	Off	On
9-1437561-5	TT13E2T	SPDT	E	On	Off	On	7-1437562-6	TT43N2T	4PDT	N	On	None	On
4-1437562-7	TT23K2T	DPST	K	On	None	Off							

Note: No center terminal "A" or "K" action switches.

1 & 2 POLE

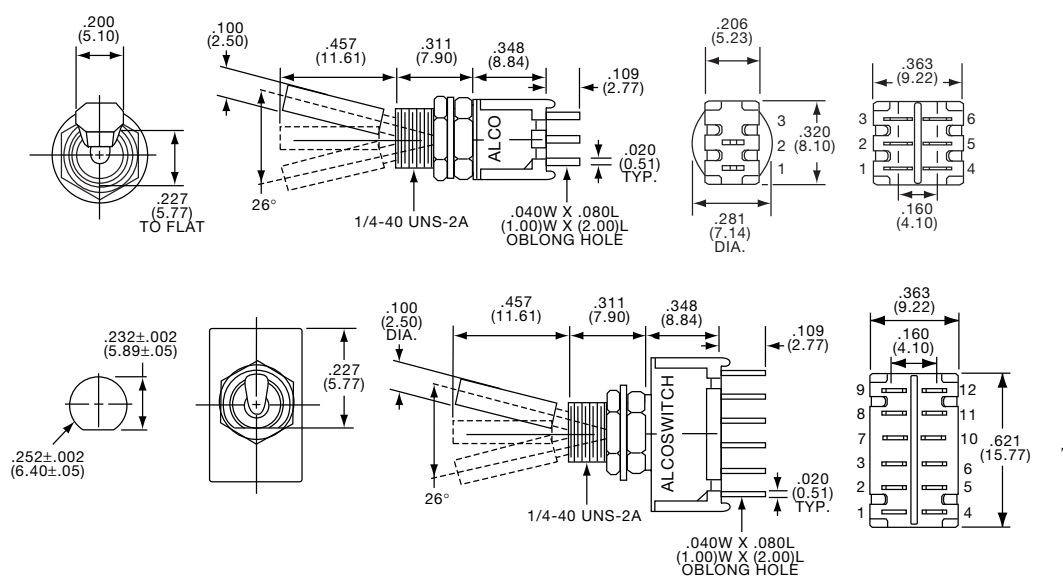

TT13D7T1/4



TT23N7T1/4

4 POLE



TT43N7T1/4

Pinned for Anti-Rotation

Tyco Electronics	Alcoswitch	Type	Act. Code P. M5	On	None	Off	Tyco Electronics	Alcoswitch	Type	Act. Code P. M5	On	None	Off
9-1437561-1	TT13D7T1/4	SPDT	D	On	None	On	6-1437562-0	TT23P7T1/4	DPDT	P	On	Off	On
9-1437561-7	TT13E7T1/4	SPDT	E	On	Off	On	7-1437562-8	TT43N7T1/4	4PDT	N	On	None	On
5-1437562-5	TT23N7T1/4	DPST	N	On	None	On		TT43P7T1/4	4PDT	P	On	Off	On

Toggle Switches, Tiny, Wire Lug, Long Actuators

SEE PAGE C8 FOR PRODUCT SPECIFICATIONS

For terminal connections refer to Code Chart on page M5-6

1 & 2 POLE



TT13D3T



TT23N3T

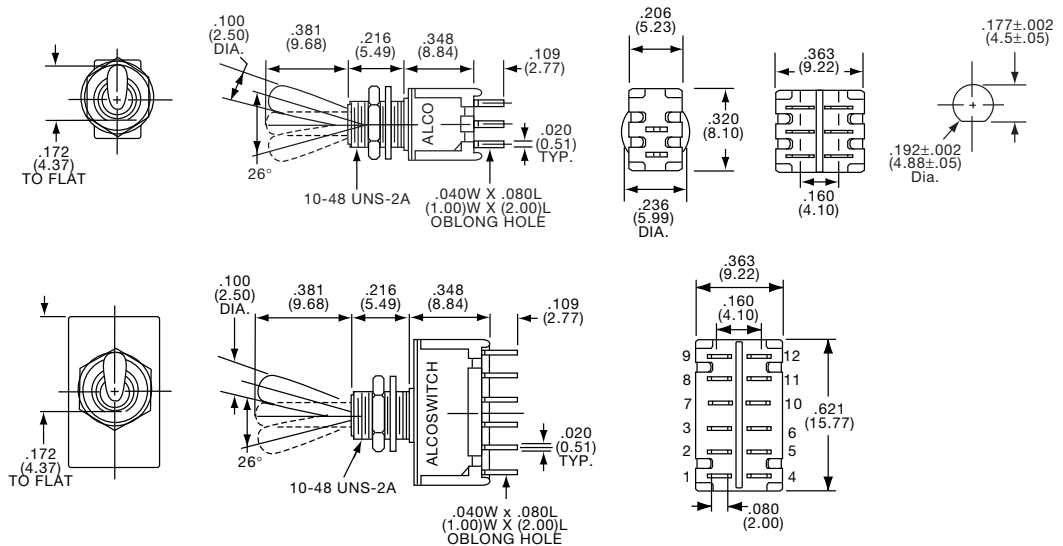

Tyco Electronics	Alcoswitch	Type	Act. Code	P. M5	On	None	Off	Tyco Electronics	Alcoswitch	Type	Act. Code	P. M5	On	None	Off
8-1437561-0	TT13A3T	SPST	A		On	None	Off	5-1437562-8	TT23P3T	DPDT	P		On	None	Off
8-1437561-8	TT13D3T	SPDT	D		On	None	On	7-1437562-7	TT43N3T	4PDT	N		On	None	On
9-1437561-6	TT13E3T	SPDT	E		On	Off	On	8-1437562-0	TT43P3T	4PDT	P		On	Off	On
4-1437562-8	TT23K3T	DPST	K		On	None	Off								
5-1437562-2	TT23N3T	DPDT	N		On	None	On								

Note: No center terminal on "A" or "K" action switches.

1 & 2 POLE



TT13A9T1/4



TT23N9T1/4

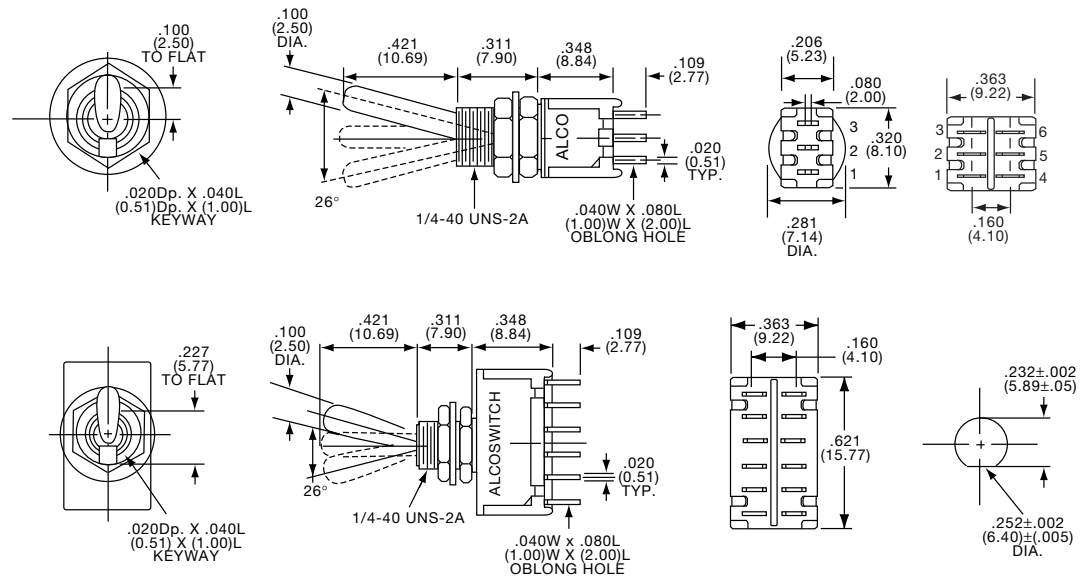

Tyco Electronics	Alcoswitch	Type	Act. Code	P. M5	On	None	Off	Tyco Electronics	Alcoswitch	Type	Act. Code	P. M5	On	None	Off
8-1437561-4	TT13A9T1/4	SPST	A		On	None	Off	6-1437562-2	TT23P9T1/4	DPDT	P		On	None	Off
9-1437561-2	TT13D9T1/4	SPDT	D		On	None	On	7-1437562-9	TT43N9T1/4	4PDT	N		On	None	On
9-1437561-8	TT13E9T1/4	SPDT	E		On	Off	On	8-1437562-1	TT43P9T1/4	4PDT	P		On	Off	On
4-1437562-9	TT23K9T1/4	DPST	K		On	None	Off								
5-1437562-6	TT23N9T1/4	DPDT	N		On	None	On								

Note: No center terminal on "A" or "K" action switches.

4 POLE



TT43N9T1/4

Toggle Switches, Process Sealed, Vertical

MATERIAL SPECIFICATIONS:

ContactsGold over nickel
 Inner Case MaterialHigh temperature polyester
 Outer Case MaterialPolyamide
 Terminals/Fixed ContactsTin lead plate
 Terminal SealEpoxy
 Process SealDisposable boot, epoxied double case

TYPICAL PERFORMANCE CHARACTERISTICS:

Contact Rating0.4VA Max. @ 20 VDC or peak AC
 Initial Contact Resistance.....20 Milliohms max.
 Contact Timing.....Break-before-make
 Insulation Resistance1,000 Megohms min. 500 VDC
 Dielectric Strength1,000 Volts RMS @ sea level
 Plunger/Actuator Travel.....26°
 Life ExpectancySee page C8

ENVIRONMENTAL SPECIFICATIONS

Operating Temperature-22°F to +185°F (-30°C to +85°C)
 Storage Temperature-67°F to +185°F (-55°C to +85°C)
 Solder Heat Resistance.....See page M3-4

APPLICATION NOTE: Each switch is provided with a disposable boot used only during cleaning operation.

* Refer to Page C8 for Other Options *

Note: Hardware included with switch

TT-ES Series

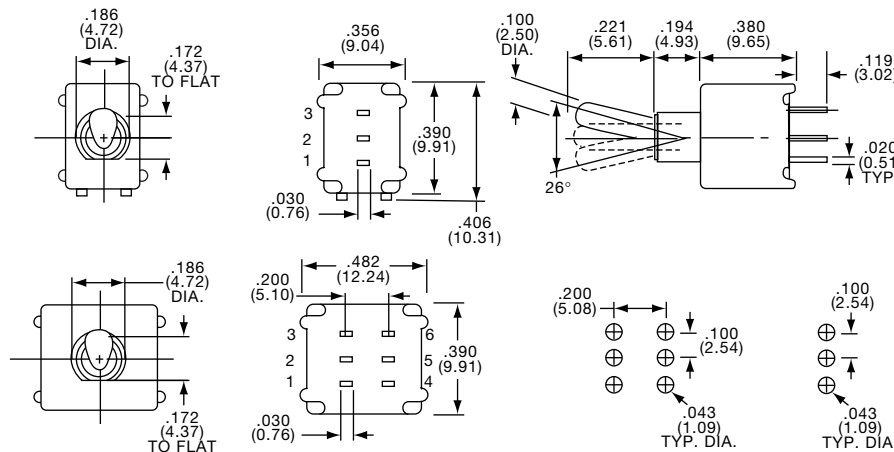

1 & 2 POLE
UNTHREADED BUSHING



TT11DGPC1ES

Tyco Electronics	Alcoswitch	Type	Act. Code P. M5	On	None	Off	Tyco Electronics	Alcoswitch	Type	Act. Code P. M5	On	None	On
2-1437561-4	TT11AGPC1ES	SPST	A	On	None	Off	1437562-4	TT21NGPC1ES	DPDT	N	On	None	On
2-1437561-7	TT11DGPC1ES	SPDT	D	On	None	On							

Note: No center terminal "A".

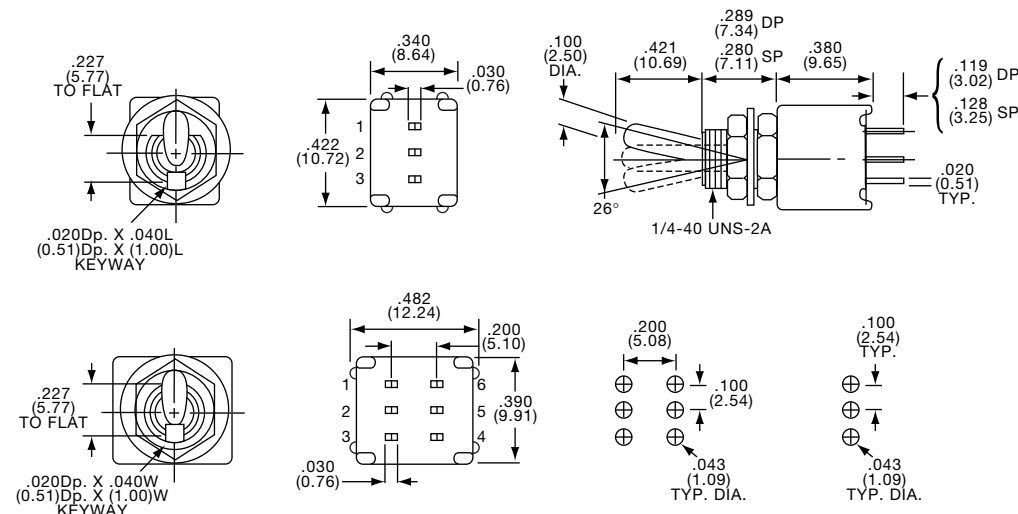

1 & 2 POLE
THREADED BUSHING

TT11DGPC9T1/4ES



TT21NGPC9T1/4ES



Tyco Electronics	Alcoswitch	Type	Act. Code P. M5	On	None	Off	Tyco Electronics	Alcoswitch	Type	Act. Code P. M5	On	None	On
	TT11AGPC9T1/4ES	SPST	A	On	None	Off	1-1437562-2	TT21NGPC9T1/4ES	DPDT	N	On	None	On
6-1437830-2	TT11DGPC9T1/4ES	SPDT	D	On	None	On		TT21PGPC9T1/4ES	DPDT	P	On	Off	On
	TT11EGPC9T1/4ES	SPDT	E	On	Off	(On)							
	TT21KGPC9T1/4ES	DPST	K	On	None	Off							

Note: No center terminal "A" or "K" action switches.
 (On) indicates momentary position.

Toggle Switches, Tiny, Enviromental and Process Sealed

SEE PAGE C16 FOR PRODUCT SPECIFICATIONS

For terminal connections refer to Code Chart on page M5-6

1 POLE-PC VERTICAL MOUNT



Tyco Electronics	Alcoswitch	Type	Act. Code P. M5			
8-1437562-6	TTE11DGPC1ES	SPDT	D	On	None	On
	TTE11EGPC1ES	SPDT	E	On	Off	On

2 POLE-PC VERTICAL MOUNT

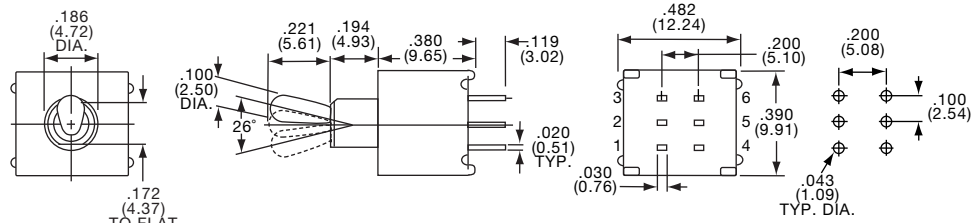

Tyco Electronics	Alcoswitch	Type	Act. Code P. M5			
1437563-1	TTE21NGPC1ES	DPDT	N	On	None	On
	TTE21PGPC1ES	DPDT	P	On	Off	On

1 POLE-PC RIGHT ANGLE



TTE11DGRA1ES
Horizontal Actuation

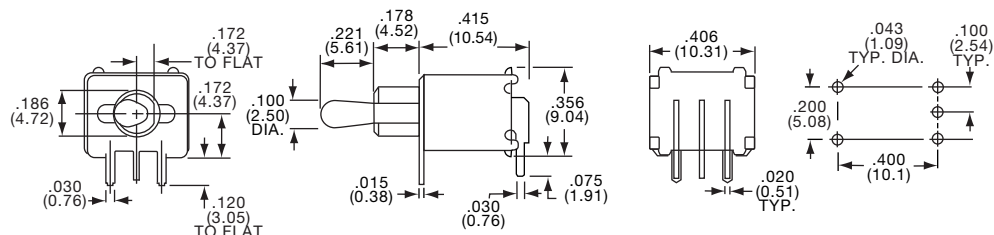

Tyco Electronics	Alcoswitch	Type	Act. Code P. M5			
8-1437562-9	TTE11DGRA1ES	SPDT	D	On	None	On
9-1437562-2	TTE11EGRA1ES	SPDT	E	On	Off	On

2 POLE-PC RIGHT ANGLE



TTE21NGRA1ES
Horizontal Actuation

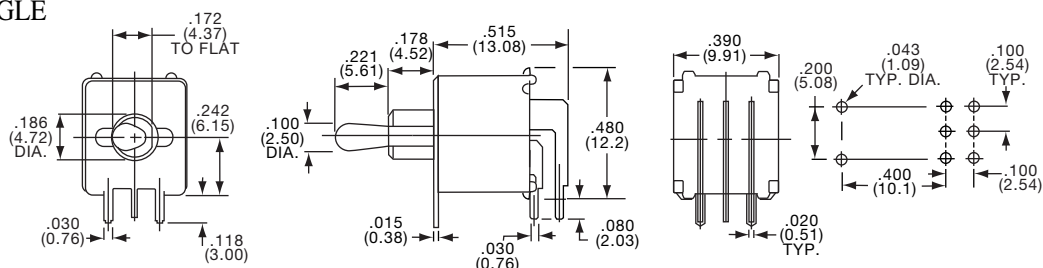

Tyco Electronics	Alcoswitch	Type	Act. Code P. M5			
1437563-4	TTE21NGRA1ES	DPDT	N	On	None	On
	TTE21PGRA1ES	DPDT	P	On	Off	On

Toggle Switches, Tiny, Enviromental and Process Sealed

For terminal connections refer to Code Chart on page M5-6.

SEE PAGE C16 FOR PRODUCT SPECIFICATIONS

* Refer to Page C8 for Other Options *

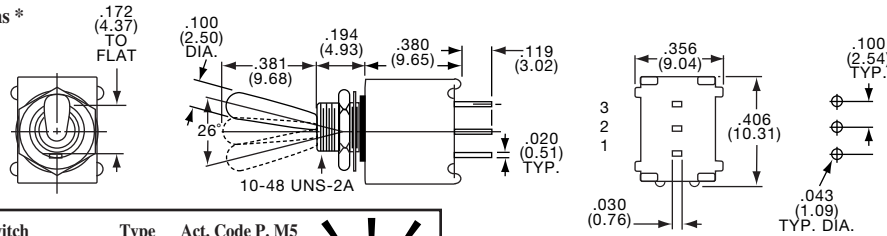

1 POLE



TTE11DGPC3TES

Tyco Electronics	Alcoswitch	Type	Act. Code	P. M5	On	None	Off
8-1437562-5	TTE11AGPC3TES	SPST	A		On	None	Off
8-1437562-7	TTE11DGPC3TES	SPDT	D		On	None	On
9-1437562-0	TTE11EGPC3TES	SPDT	E		On	Off	On

Note: No center terminal on "A" action switches.

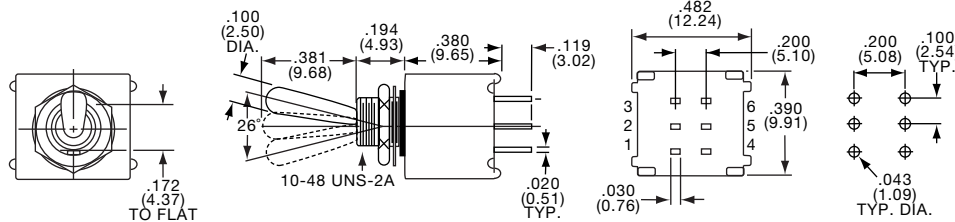

2 POLE



TTE21NGPC3TES

Tyco Electronics	Alcoswitch	Type	Act. Code	P. M5	On	None	On
1437563-2	TTE21NGPC3TES	DPDT	N		On	None	On
	TTE21PGPC3TES	DPDT	P		On	Off	On

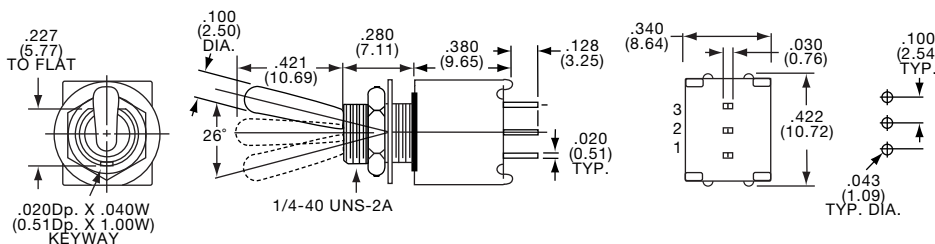

1 POLE



TTE11DGPC9T4ES

Tyco Electronics	Alcoswitch	Type	Act. Code	P. M5	On	None	Off
	TTE11AGPC9T1/4ES	SPST	A		On	None	Off
8-1437562-8	TTE11DGPC9T1/4ES	SPDT	D		On	None	On
9-1437562-1	TTE11EGPC9T1/4ES	SPDT	E		On	Off	On

Note: No center terminal on "A" action switches.

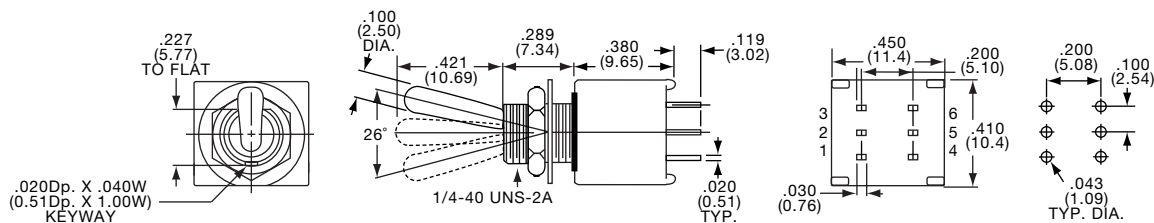

2 POLE



TTE21NGPC9T4ES

Tyco Electronics	Alcoswitch	Type	Act. Code	P. M5	On	None	Off
	TTE21KGPC9T1/4ES	DPST	K		On	None	Off
1437563-3	TTE21NGPC9T1/4ES	DPDT	N		On	None	On
	TTE21PGPC9T1/4ES	DPDT	P		On	Off	On

Note: No center terminal on "K" action switches.



Компания «ЭлектроПласт» предлагает заключение долгосрочных отношений при поставках импортных электронных компонентов на взаимовыгодных условиях!

Наши преимущества:

- Оперативные поставки широкого спектра электронных компонентов отечественного и импортного производства напрямую от производителей и с крупнейших мировых складов;
- Поставка более 17-ти миллионов наименований электронных компонентов;
- Поставка сложных, дефицитных, либо снятых с производства позиций;
- Оперативные сроки поставки под заказ (от 5 рабочих дней);
- Экспресс доставка в любую точку России;
- Техническая поддержка проекта, помощь в подборе аналогов, поставка прототипов;
- Система менеджмента качества сертифицирована по Международному стандарту ISO 9001;
- Лицензия ФСБ на осуществление работ с использованием сведений, составляющих государственную тайну;
- Поставка специализированных компонентов (Xilinx, Altera, Analog Devices, Intersil, Interpoint, Microsemi, Aeroflex, Peregrine, Syfer, Eurofarad, Texas Instrument, Miteq, Cobham, E2V, MA-COM, Hittite, Mini-Circuits, General Dynamics и др.);

Помимо этого, одним из направлений компании «ЭлектроПласт» является направление «Источники питания». Мы предлагаем Вам помощь Конструкторского отдела:

- Подбор оптимального решения, техническое обоснование при выборе компонента;
- Подбор аналогов;
- Консультации по применению компонента;
- Поставка образцов и прототипов;
- Техническая поддержка проекта;
- Защита от снятия компонента с производства.



Как с нами связаться

Телефон: 8 (812) 309 58 32 (многоканальный)

Факс: 8 (812) 320-02-42

Электронная почта: org@eplast1.ru

Адрес: 198099, г. Санкт-Петербург, ул. Калинина, дом 2, корпус 4, литера А.