

---

## PWM/VFM Step-down DC/DC Controller

---

NO.EA-097-181004

### OUTLINE

The R1225N is a CMOS-based PWM step-down DC/DC converter controller with low supply current. It consists of an oscillator, a PWM control circuit, a reference voltage unit, an error amplifier, a soft-start circuit, a latch-type protection circuit, a PWM/VFM alternative circuit, a chip enable circuit, a phase compensation circuit, and an input voltage detect circuit. Further, protection circuit delay time adjuster circuit, and resistors for voltage detection are included. A low ripple, high efficiency step-down DC/DC converter can be easily composed of this IC with some external components, or a power-transistor, an inductor, a diode and capacitors. With a PWM/VFM alternative circuit, when the load current is small, the operation is automatically switching into the VFM oscillator from PWM oscillator, therefore the efficiency at small load current is improved. The R1225NxxxC/D/K types, which are without a PWM/VFM alternative circuit, are also available.

If the term of maximum duty cycle keeps on a certain time, the embedded protection circuit works. It is latch-type protection circuit, and it works to latch an external Power MOSFET with keeping it off. To release the condition of protection, after disable this IC with a chip enable circuit, enable it again, or restart this IC with power-on. Delay Time for protection circuit is adjustable with an external capacitor. With a built-in UVLO function, when the input voltage is UVLO threshold or less, this IC keeps standby state, and saves its consumption current and avoids miss-operation. Further, if the set output voltage is equal or more than 2.1 V, with a built-in start-up function, at the power-on moment until the input voltage becomes more than the set output voltage, DC/DC operation is halted and avoids miss-operation.

### FEATURES

- Wide Range of Input Voltage ..... 2.3 V to 18.5 V
- Built-in Soft-start and Latch-type Protection
- Three Options of Oscillator Frequency ..... 180 kHz, 300 kHz, 500 kHz
- High Efficiency ..... Typ. 90%
- Output Voltage ..... 1.2 V to 6.0 V, 0.1 V step
- Standby Current ..... Typ. 0.0  $\mu$ A
- High Accuracy Output Voltage .....  $\pm 2.0\%$
- Low Temperature-Drift Coefficient of Output Voltage ..... Typ.  $\pm 100$  ppm/ $^{\circ}$ C

### APPLICATIONS

- Hand-held Communication Equipment, Cameras, VCRs, Camcorders
- Battery-powered Equipment
- Household Electrical Appliances

# R1225N

NO.EA-097-181004

## BLOCK DIAGRAM

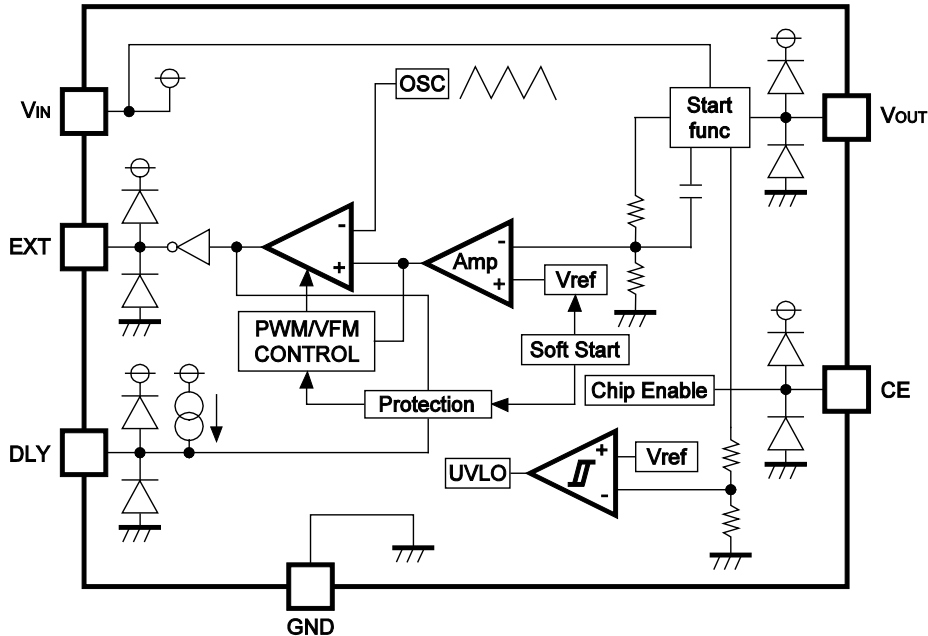

R1225N Block Diagram

## SELECTION GUIDE

The output voltage, the oscillator frequency and the PWM/VFM alternative circuit are user-selectable options.

### Selection Guide

Product Name	Package	Quantity per Reel	Pb Free	Halogen Free
R1225Nxx2*-TR-FE	SOT-23-6W	3,000 pcs	Yes	Yes

xx: The output voltage can be designed in the range from 1.2 V (12) to 6.0 V (60) in 0.1 V steps.

\*: The oscillator frequency and the modulation method are options as follows.

*	Oscillator Frequency	PWM/VFM Alternative Circuit
A	300 kHz	Yes
B	500 kHz	Yes
C	300 kHz	No
D	500 kHz	No
J	180 kHz	Yes
K	180 kHz	No

## PIN DESCRIPTIONS



**R1225N (SOT-23-6W) Pin Configuration**

### Pin Description

Pin No.	Symbol	Description
1	EXT	External Transistor Drive Pin, CMOS Output Type
2	VIN	Power Supply Pin
3	DLY	Pin for Setting External Capacitor for Protection Circuit Delay Time
4	CE	Chip Enable Pin, Active-high
5	GND	Ground Pin
6	VOUT	Pin for Monitoring Output Voltage

---

**R1225N**

---

NO.EA-097-181004

**ABSOLUTE MAXIMUM RATINGS****Absolute Maximum Ratings**

(GND = 0 V)

Symbol	Item	Rating	Unit
V <sub>IN</sub>	VIN Supply Voltage	20	V
V <sub>EXT</sub>	EXT Pin Output Voltage	-0.3 to V <sub>IN</sub> +0.3	V
V <sub>CE</sub>	CE Pin Input Voltage	-0.3 to V <sub>IN</sub> +0.3	V
V <sub>OUT</sub>	VOUT Pin Input Voltage	-0.3 to V <sub>IN</sub> +0.3	V
V <sub>DLY</sub>	VDLY Pin Input Voltage	-0.3 to 1.0	V
I <sub>EXT</sub>	EXT Pin Inductor Drive Output Current	±50	mA
I <sub>DLY</sub>	DLY Pin Output Current	±15	mA
P <sub>D</sub>	Power Dissipation	430	mW
T <sub>j</sub>	Junction Temperature Range	-40 to 125	°C
T <sub>stg</sub>	Storage Temperature Range	-55 to 125	°C

**ABSOLUTE MAXIMUM RATINGS**

Electronic and mechanical stress momentarily exceeded absolute maximum ratings may cause the permanent damages and may degrade the lifetime and safety for both device and system using the device in the field. The functional operation at or over these absolute maximum ratings is not assured.

**RECOMMENDED OPERATING CONDITIONS****Recommended Operating Conditions**

Symbol	Item	Rating	Unit
V <sub>IN</sub>	Input Voltage	2.3 to 18.5	V
T <sub>a</sub>	Operating Temperature Range	-40 to 85	°C

**RECOMMENDED OPERATING CONDITIONS**

All of electronic equipment should be designed that the mounted semiconductor devices operate within the recommended operating conditions. The semiconductor devices cannot operate normally over the recommended operating conditions, even if when they are used over such conditions by momentary electronic noise or surge. And the semiconductor devices may receive serious damage when they continue to operate over the recommended operating conditions.

## ELECTRICAL CHARACTERISTICS

R1225Nxx2X Electrical Characteristics (X = A/ B/ C/ D/ J/ K)

(Ta = 25°C)

Symbol	Item	Conditions	Min.	Typ.	Max.	Unit
V <sub>OUT</sub>	Step-down Output Voltage	V <sub>IN</sub> = V <sub>CE</sub> = V <sub>SET</sub> + 1.5 V, I <sub>OUT</sub> = -100 mA When V <sub>SET</sub> ≤ 1.5 V, V <sub>IN</sub> = V <sub>CE</sub> = 3.0 V	V <sub>SET</sub> ×0.98	V <sub>SET</sub>	V <sub>SET</sub> ×1.02	V
ΔV <sub>OUT</sub> / ΔTa	Step-down Output Voltage Temperature Coefficient	-40°C ≤ Ta ≤ 85°C		±100		ppm/ °C
f <sub>OSC</sub>	Oscillator Frequency	V <sub>IN</sub> = V <sub>CE</sub> = V <sub>SET</sub> + 1.5 V, I <sub>OUT</sub> = -100 mA When V <sub>SET</sub> ≤ 1.5 V, V <sub>IN</sub> = V <sub>CE</sub> = 3.0 V J/ K version A/ C version B/ D version	144 240 400	180 300 500	216 360 600	kHz
Δf <sub>OSC</sub> / ΔTa	Oscillator Frequency Temperature Coefficient	-40°C ≤ Ta ≤ 85°C		±0.2		%/ °C
I <sub>DD1</sub>	Supply Current 1	V <sub>IN</sub> = V <sub>CE</sub> = V <sub>OUT</sub> = 18.5 V A/ B/ J/ K version C version D version		20 30 40	50 60 80	μA
I <sub>STANDBY</sub>	Standby Current	V <sub>IN</sub> = 18.5 V, V <sub>CE</sub> = 0 V, V <sub>OUT</sub> = 0 V		0.0	0.5	μA
I <sub>EXTH</sub>	EXT "H" Output Current	V <sub>IN</sub> = 8 V, V <sub>EXT</sub> = 7.9 V, V <sub>OUT</sub> = 8 V, V <sub>CE</sub> = 8 V		-17	-10	mA
I <sub>EXTL</sub>	EXT "L" Output Current	V <sub>IN</sub> = 8 V, V <sub>EXT</sub> = 0.1 V, V <sub>OUT</sub> = 0 V, V <sub>CE</sub> = 8 V	20	30		mA
I <sub>SW</sub>	DLY switch current	V <sub>IN</sub> = 2.3 V, V <sub>CE</sub> = 0 V, V <sub>DLY</sub> = 0.1 V	1.0	2.0		mA
I <sub>CEH</sub>	CE "H" Input Current	V <sub>IN</sub> = V <sub>CE</sub> = V <sub>OUT</sub> = 18.5 V		0.0	0.5	μA
I <sub>CEL</sub>	CE "L" Input Current	V <sub>IN</sub> = V <sub>OUT</sub> = 18.5 V, V <sub>CE</sub> = 0 V	-0.5	0.0		μA
V <sub>CEH</sub>	CE "H" Input Voltage	V <sub>IN</sub> = 8 V, V <sub>OUT</sub> = 0 V	1.5			V
V <sub>CEL</sub>	CE "L" Input Voltage	V <sub>IN</sub> = 8 V, V <sub>OUT</sub> = 0 V			0.3	V
D <sub>MAX</sub>	Oscillator Maximum Duty Cycle		100			%
D <sub>VFM</sub>	VFM Duty Cycle	A/ B/ J version		35		%
V <sub>UVLO1</sub>	UVLO Voltage	V <sub>OUT</sub> = 0 V, V <sub>IN</sub> = V <sub>CE</sub> = 2.5 V → 1.5 V	1.8	2.0	2.2	V
V <sub>UVLO2</sub>	UVLO Release Voltage	V <sub>OUT</sub> = 0 V, V <sub>IN</sub> = V <sub>CE</sub> = 1.5 V → 2.5 V		V <sub>UVLO1</sub> +0.1	2.3	V
t <sub>START</sub>	Soft-start Time	V <sub>IN</sub> = V <sub>SET</sub> + 1.5 V, I <sub>OUT</sub> = -10 mA V <sub>CE</sub> = 0 V → V <sub>SET</sub> + 1.5 V	5	10	20	ms
t <sub>PROT</sub>	Protection Delay Time	V <sub>IN</sub> = V <sub>CE</sub> = V <sub>SET</sub> + 1.5 V V <sub>OUT</sub> = V <sub>SET</sub> + 1.5 V → 0 V	10	20	35	ms

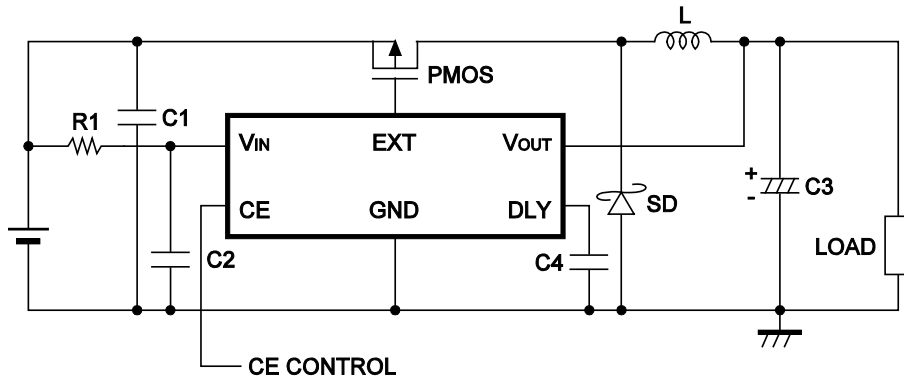
**TYPICAL APPLICATION AND APPLICATION HINTS****Typical Application****External Components**

Symbol	Description
PMOS	uPA1914, Renesas
L	CR105NP-270MC, Sumida
SD	CMS06, Toshiba
C1	10 $\mu$ F, Ceramic Type
C2	0.1 $\mu$ F, Ceramic Type
C3	47 $\mu$ F, Tantalum Type
C4	0.02 $\mu$ F, Ceramic Type
R1	10 $\Omega$

## TECHNICAL NOTES

- As shown in the block diagram, a parasitic diode is formed in each terminal, each of these diodes is not formed for load current, therefore do not use it in such a way. When you control the CE pin by another power supply, do not make its "H" level more than the voltage level of VIN pin.
- The operation of Latch-type protection circuit is as follows;  
When the maximum duty cycle continues longer than the delay time for protection circuit, (Refer to the Electrical Characteristics) the protection circuit works to shutdown Power MOSFET with latching operation. Therefore when an input/output voltage difference is small, the protection circuit may work with small load current.  
To release the protection of latch status, after disable this IC with a chip enable circuit, enable it again, or restart this IC with power-on. However, in the case of restarting this IC with power-on, after the power supply is turned off, if a certain amount of charge remains in C<sub>IN</sub>, or some voltage is forced to V<sub>IN</sub> from C<sub>IN</sub>, this IC might not be restarted even after power-on.
- Set external components as close as possible to the IC and minimize the connection between the components and the IC. In particular, a capacitor should be connected to V<sub>OUT</sub> pin with the minimum connection. Make grounding sufficient and reinforce supplying. Large switching current flows through the connection of power line, an inductor and the connection of V<sub>OUT</sub>. If the impedance of the connection of power supply is high, the voltage level of power supply of the IC fluctuates with the switching current. This may cause unstable operation of the IC.
- Use capacitors with a capacity of 22 μF or more for V<sub>OUT</sub> pin, and with good high frequency characteristics such as tantalum capacitors. We recommend to use capacitors with an allowable voltage which is at least twice as much as setting output voltage, in terms of the input capacitors, its voltage rating is twice or more than input voltage. This is because there may be a case where a spike-shaped high voltage is generated by an inductor when an external transistor is on and off.
- Choose an inductor that has sufficiently small D.C. resistance and large allowable current and is hard to reach magnetic saturation. If the value of inductance of an inductor is extremely small, the I<sub>LX</sub> may exceed the absolute maximum rating at the maximum loading. Use an inductor with appropriate inductance.
- Use a diode of a Schottky type with high switching speed, and also pay attention to its current capacity.
- Do not use this IC under the condition with V<sub>IN</sub> voltage at equal or less than minimum operating voltage.
- When the threshold level of an external power MOSFET is rather low and the drive-ability of voltage supplier is small, if the output pin is short circuit, input voltage may be equal or less than UVLO detector threshold. In this case, the device is reset with UVLO function that is not the latch-protection function.
- With the PWM/VFM alternative circuit, when the on duty cycle of switching is 35% or less, the R1225N alters from PWM mode to VFM mode (Pulse skip mode). The purpose of this circuit is raising the efficiency with a light load by skipping the frequency and suppressing the consumption current. However, the ratio of output voltage against input voltage is 35% or less, (ex. V<sub>IN</sub> > 8.6 V and V<sub>OUT</sub> = 3.0 V) even if the large current may be loaded, the IC keeps its VFM mode. As a result, frequency might be decreased, and oscillation waveform might be unstable. These phenomena are the typical characteristics of the IC with PWM/VFM alternative circuit.
- ★ The performance of a power source circuit using this device is highly dependent on a peripheral circuit. A peripheral component or the device mounted on PCB should not exceed its rated voltage, rated current or rated power. When designing a peripheral circuit, please be fully aware of the following points.

## HOW TO SET THE DELAY TIME FOR PROTECTION CIRCUIT

The equation describes how to calculate the delay time of protection circuit from the value of an external capacitor C4.

$$t_{DLY} = C4 \times 10^6 \text{sec (in this equation, } 1 \mu\text{F} \geq C4 \geq 1000 \text{ pF)}$$

Without the external capacitor, a certain delay time exists, therefore, if the external capacitor is less than 1000 pF, the error will increase. Further, if the external capacitor value is beyond 1  $\mu\text{F}$ , the time required to discharge the C4 will be long, and this may cause the miss-operation. For example, if the protection circuit may work and released, soon after that the protection may work. In that case, C4 has not discharged completely yet, therefore, the delay time may be shorter than expected.

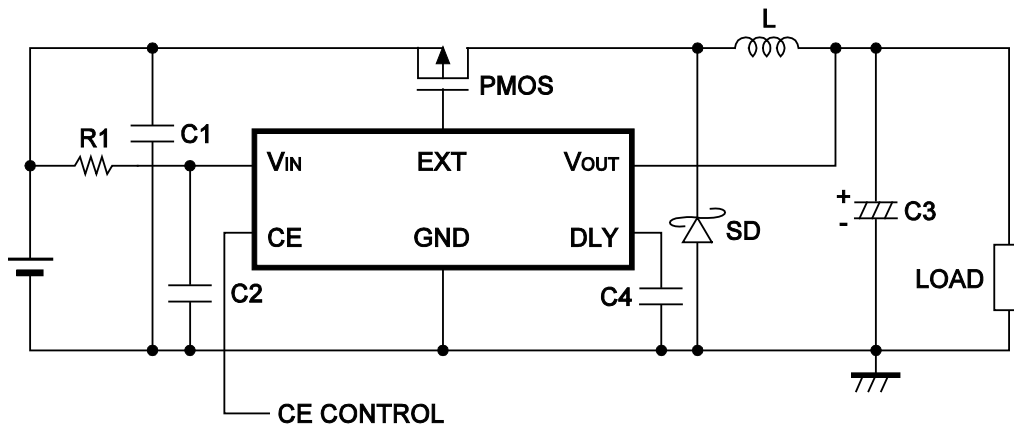



## OPERATION OF STEO-DOWN DC/DC CONVERTER AND OUTPUT CURRENT

The step-down DC/DC converter charges energy in the inductor when Lx transistor is ON, and discharges the energy from the inductor when Lx transistor is OFF and controls with less energy loss, so that a lower output voltage than the input voltage is obtained. The operation will be explained with reference to the following diagrams:

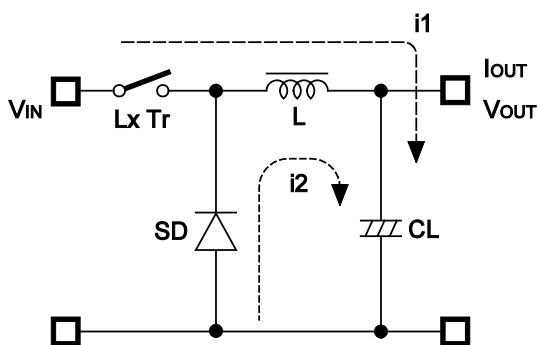

Basic Circuits

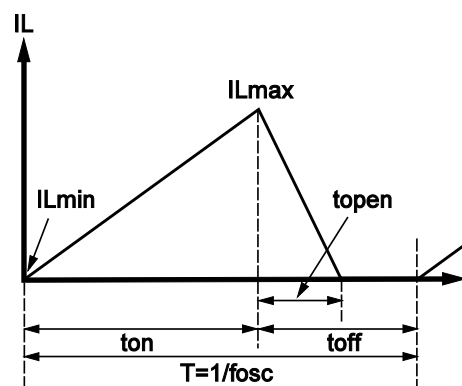

Current through L

- Step 1: Lx Tr. turns on and current  $I_L (= i_1)$  flows, and energy is charged into CL. At this moment,  $I_L$  increases from  $I_{Lmin} (= 0)$  to reach  $I_{Lmax}$  in proportion to the on-time period ( $t_{on}$ ) of LX Tr.
- Step 2: When Lx Tr. turns off, Schottky diode (SD) turns on in order that L maintains  $I_L$  at  $I_{Lmax}$ , and current  $I_L (= i_2)$  flows.
- Step 3:  $I_L$  decreases gradually and reaches  $I_{Lmin}$  after a time period of  $t_{open}$ , and SD turns off, provided that in the continuous mode, next cycle starts before  $I_L$  becomes to 0 because  $t_{off}$  time is not enough. In this case,  $I_L$  value is from this  $I_{Lmin} (> 0)$ .

In the case of PWM control system, the output voltage is maintained by controlling the on-time period ( $t_{on}$ ), with the oscillator frequency ( $f_{osc}$ ) being maintained constant.

**Discontinuous Conduction Mode and Continuous Conduction Mode**

The maximum value ( $I_{Lmax}$ ) and the minimum value ( $I_{Lmin}$ ) current which flow through the inductor is the same as those when  $Lx Tr.$  turns on and when it turns off.

The difference between  $I_{Lmax}$  and  $I_{Lmin}$ , which is represented by  $\Delta I$ ;

$$\Delta I = I_{Lmax} - I_{Lmin} = V_{OUT} \times t_{open} / L = (V_{IN} - V_{OUT}) \times t_{on} / L \dots\dots\dots \text{Equation 1}$$

Where,  $T = 1 / f_{OSC} = t_{on} + t_{off}$

$$\text{Duty (\%)} = t_{on} / T \times 100 = t_{on} \times f_{OSC} \times 100$$

$$t_{open} \leq t_{off}$$

In Equation 1,  $V_{OUT} \times t_{open} / L$  and  $(V_{IN} - V_{OUT}) \times t_{on} / L$  are respectively shown the change of the current at ON, and the change of the current at OFF.

When the output current ( $I_{OUT}$ ) is relatively small,  $t_{open} < t_{off}$  as illustrated in the above diagram. In this case, the energy is charged in the inductor during the time period of  $t_{on}$  and is discharged in its entirety during the time period of  $t_{off}$ , therefore  $I_{Lmin}$  becomes to zero ( $I_{Lmin} = 0$ ). When  $I_{OUT}$  is gradually increased, eventually,  $t_{open}$  becomes to  $t_{off}$  ( $t_{open} = t_{off}$ ), and when  $I_{OUT}$  is further increased,  $I_{Lmin}$  becomes larger than zero ( $I_{Lmin} > 0$ ). The former mode is referred to as the discontinuous mode and the latter mode is referred to as continuous mode.

In the continuous mode, when Equation 1 is solved for  $t_{on}$  and assumed that the solution is  $t_{onc}$ ,

$$t_{onc} = T \times V_{OUT} / V_{IN} \dots\dots\dots \text{Equation 2}$$

When  $t_{on} < t_{onc}$ , the mode is the discontinuous mode, and when  $t_{on} = t_{onc}$ , the mode is the continuous mode.

## OUTPUT CURRENT AND SELECTION OF EXTERNAL COMPONENTS

When Lx Tr. is "ON":

(Wherein, Ripple Current P-P value is described as  $I_{RP}$ , ON resistance of LX Tr. is described as  $R_P$  the direct current of the inductor is described as  $R_L$ .)

$$V_{IN} = V_{OUT} + (R_P + R_L) \times I_{OUT} + L \times I_{RP} / t_{on} \dots \dots \dots \text{Equation 3}$$

When Lx Tr. is "OFF":

$$L \times I_{RP} / t_{off} = V_F + V_{OUT} + R_L \times I_{OUT} \dots \dots \dots \text{Equation 4}$$

Put Equation 4 to Equation 3 and solve for ON duty,  $t_{on} / (t_{off} + t_{on}) = D_{ON}$ ,

$$D_{ON} = (V_{OUT} + V_F + R_L \times I_{OUT}) / (V_{IN} + V_F - R_P \times I_{OUT}) \dots \dots \dots \text{Equation 5}$$

Ripple Current is as follows;

$$I_{RP} = (V_{IN} - V_{OUT} - R_P \times I_{OUT} - R_L \times I_{OUT}) \times D_{ON} / f / L \dots \dots \dots \text{Equation 6}$$

Wherein, peak current that flows through L, Lx Tr., and SD is as follows;

$$I_{Lmax} = I_{OUT} + I_{RP} / 2 \dots \dots \dots \text{Equation 7}$$

Consider  $I_{Lmax}$ , condition of input and output and select external components.

★The above explanation is directed to the calculation in an ideal case in continuous mode.

## EXTERNAL COMPONENTS

### 1. Inductor

Select an inductor that peak current does not exceed  $I_{Lmax}$ . If larger current than allowable current flows, magnetic saturation occurs and make transform efficiency worse. When the load current is definite, the smaller value of L, the larger the ripple current. Provided that the allowable current is large in that case and DC current is small, therefore, for large output current, efficiency is better than using an inductor with a large value of L and vice versa.

### 2. Diode

Use a diode with low  $V_F$  (Schottky type is recommended.) and high switching speed. Reverse voltage rating should be more than  $V_{IN}$  and current rating should be equal or more than  $I_{Lmax}$ .

### 3. Capacitors

As for  $C_{IN}$ , use a capacitor with low ESR (Equivalent Series Resistance) and a capacity of at least 10  $\mu F$  for stable operation.  $C_{OUT}$  can reduce ripple of Output Voltage, therefore 47  $\mu F$  or more value of tantalum type capacitor is recommended.

### 4. Lx Transistor

Pch Power MOSFET is required for this IC. Its breakdown voltage between gate and source should be a few V higher than Input Voltage. In the case of Input Voltage is low, to turn on MOSFET completely, to use a MOSFET with low threshold voltage is effective. If a large load current is necessary for your application and important, choose a MOSFET with low ON resistance for good efficiency. If a small load current is mainly necessary for your application, choose a MOSFET with low gate capacity for good efficiency. Maximum continuous drain current of MOSFET should be larger than peak current,  $I_{Lmax}$ .

## TIMING CHART

Case 1. Set  $V_{OUT}$  Voltage > 2.1 V (Set  $V_{OUT}$  Voltage > UVLO Voltage)

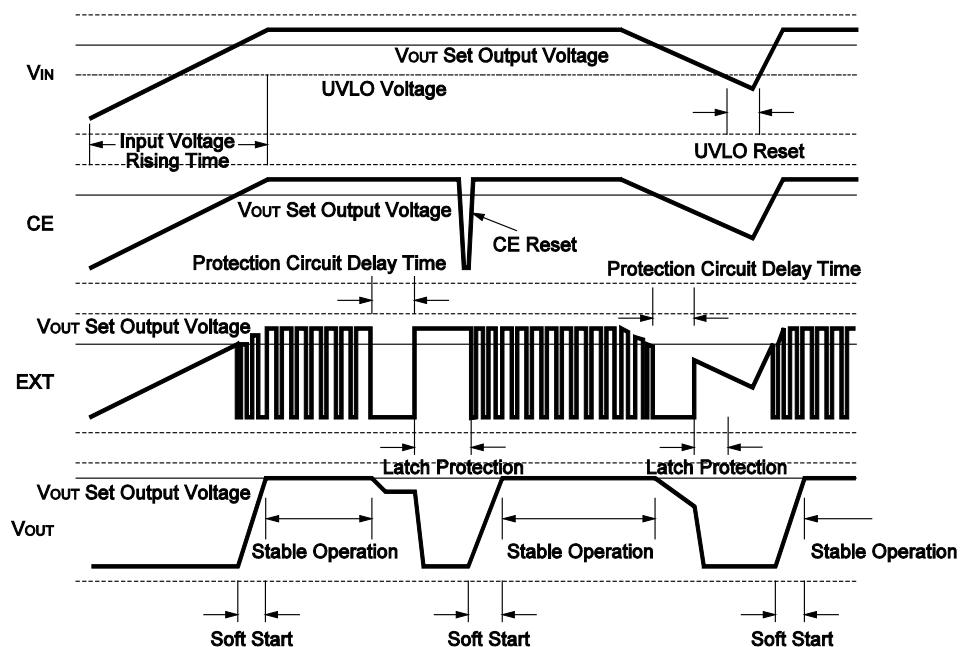

The timing chart shown above describes the changing process of input voltage rising, stable operating, operating with large current, reset with CE pin, stable operating, input voltage falling, input voltage recovering, and stable operating.

First, until when the input voltage ( $V_{IN}$ ) reaches the set output voltage, the circuit inside keeps the condition of pre-standby.

Second, after  $V_{IN}$  becomes beyond the set output voltage, soft-start operation starts, when the soft-start operation finishes, the operation becomes stable.

If too large current flows through the circuit because of short or other reasons, EXT signal ignores that during the delay time of protection circuit. (The current value depends on the circuit.)

After the delay time passes, the latch protection works, or EXT signal will be "H", then output will turn off. To release the latch protection, input voltage should be equal or lower than UVLO level, or restart with CE (Once turn off the circuit with CE and turn it on again). In the timing charge above, release the latch function is realized with CE signal from "L" to "H". After removing the cause of large current and the reset with CE, soft-start operation starts and after the soft-start time, the operation will be back to stable.

If the  $V_{IN}$  becomes lower than the set  $V_{OUT}$ , that situation is same as large current condition, so protection circuit may be ready to work, therefore, after the delay time of protection circuit, EXT will be "H" and the output turns off.

Further, if the  $V_{IN}$  is lower than UVLO voltage, the circuit inside will be stopped by UVLO function. After that, if  $V_{IN}$  rises, until when the  $V_{IN}$  reaches the set output voltage, the circuit inside keeps the condition of pre-standby. Then after  $V_{IN}$  becomes beyond the set output voltage, soft-start operation starts, when the soft-start operation finishes, the operation becomes stable.

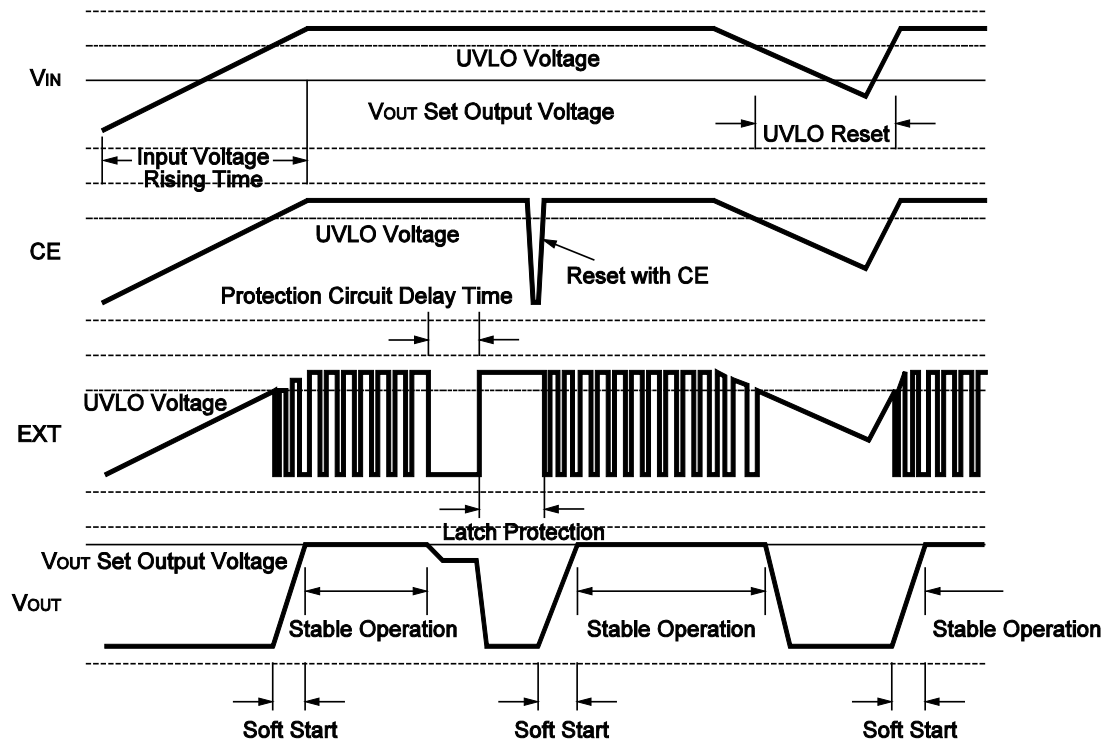
Case 2. Set  $V_{OUT}$  Voltage  $\leq 2.0$  V (Set  $V_{OUT}$  Voltage  $<$  UVLO Voltage)

The timing chart shown above describes the changing process of input voltage rising, stable operating, operating with large current, reset with CE pin, stable operating, input voltage falling, input voltage recovering, and stable operating.

First, until when the input voltage ( $V_{IN}$ ) reaches the UVLO voltage, the circuit inside keeps the condition of pre-standby. Second, after  $V_{IN}$  becomes beyond the UVLO voltage, soft-start operation starts, when the soft-start operation finishes, the operation becomes stable. If too large current flows through the circuit because of short or other reasons, EXT signal ignores that during the delay time of protection circuit. (The current value depends on the circuit.) After the delay time passes, the latch protection works, or EXT signal will be "H", then output will turn off. To release the latch protection, input voltage should be equal or lower than UVLO level, or restart with CE (Once turn off the circuit with CE and turn it on again). In the timing charge above, release the latch function is realized with CE signal from "L" to "H". After removing the cause of large current and the reset with CE, soft-start operation starts and after the soft-start time, the operation will be back to stable. Further, if the  $V_{IN}$  is lower than UVLO voltage, the circuit inside will be stopped by UVLO function. After that, if  $V_{IN}$  rises, until when the  $V_{IN}$  reaches UVLO voltage, the circuit inside keeps the condition of pre-standby. Then after  $V_{IN}$  becomes beyond the UVLO voltage, soft-start operation starts, when the soft-start operation finishes, the operation becomes stable.

## TEST CIRCUITS

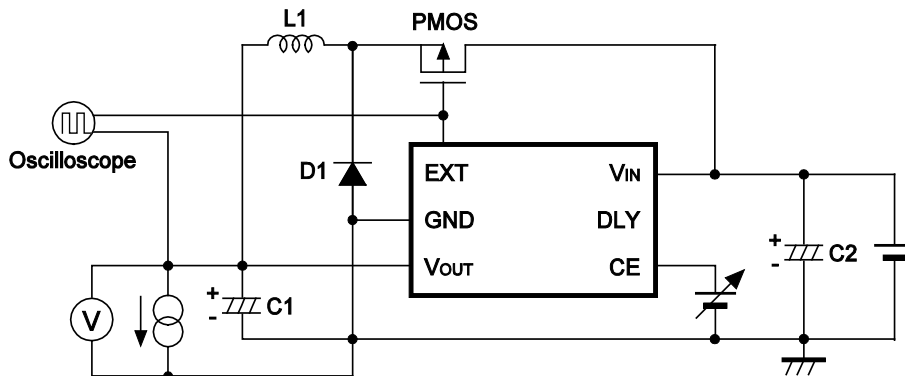

A) Output Voltage, Oscillator Frequency, CE "H" Input Voltage, CE "L" Input Voltage, Soft-start time

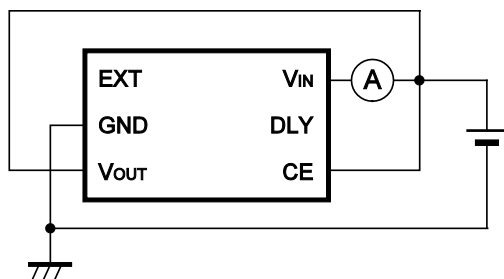

B) Supply Current 1

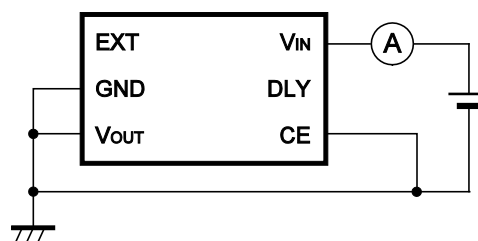

C) Standby Current

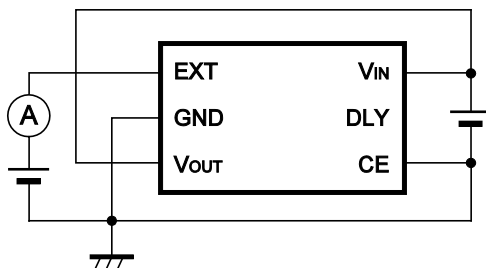

D) EXT "H" Output Current

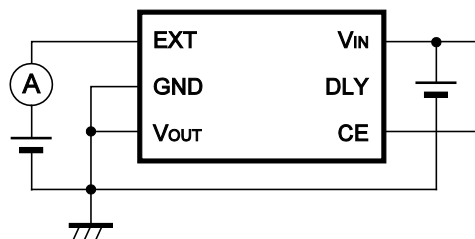

E) EXT "L" Output Current

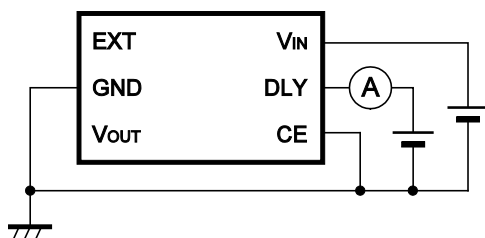

F) DLY Switching Current

---

**R1225N**

---

NO.EA-097-181004

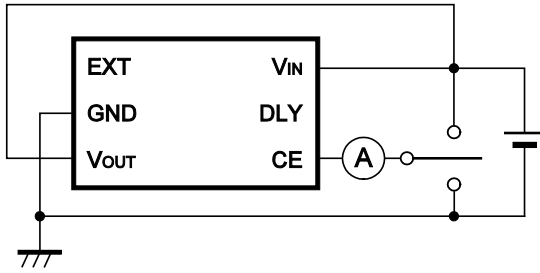
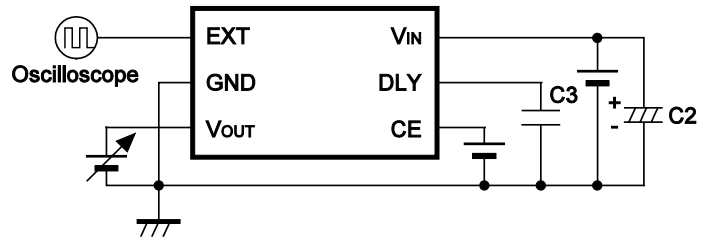
**G) CE "H" Input Current, CE "L" Input Current****H) Output Delay Time for Protection Circuit****External Components**

Symbol	Description
PMOS	Pch Power MOS, Hitachi: HAT1020R
L1	27 $\mu$ H, Sumida: CD104NP-270MC
D1	Schottky Type, ROHM: RB491D
C1	47 $\mu$ F, Tantalum Type
C2	47 $\mu$ F, Tantalum Type
C3	0.02 $\mu$ F, Ceramic Type



## TYPICAL CHARACTERISTICS

### 1) Efficiency vs. Output Current

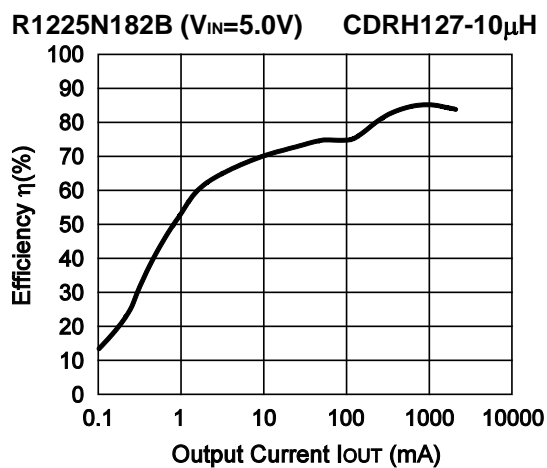
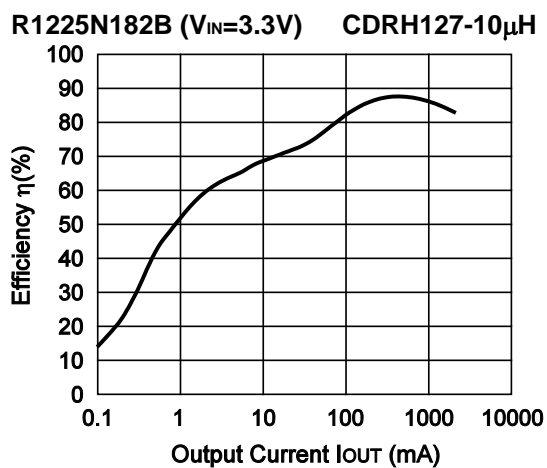

---

# R1225N

---

NO.EA-097-181004

R1225N182C ( $V_{IN}=3.3V$ ) CDRH127-10 $\mu$ H



R1225N182C ( $V_{IN}=5.0V$ ) CDRH127-10 $\mu$ H



R1225N182C ( $V_{IN}=12V$ ) CDRH127-10 $\mu$ H



R1225N182D ( $V_{IN}=3.3V$ ) CDRH127-10 $\mu$ H



R1225N182D ( $V_{IN}=5.0V$ ) CDRH127-10 $\mu$ H

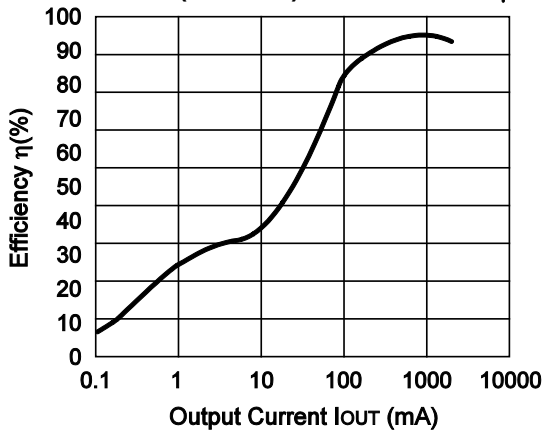

R1225N182D ( $V_{IN}=12V$ ) CDRH127-10 $\mu$ H

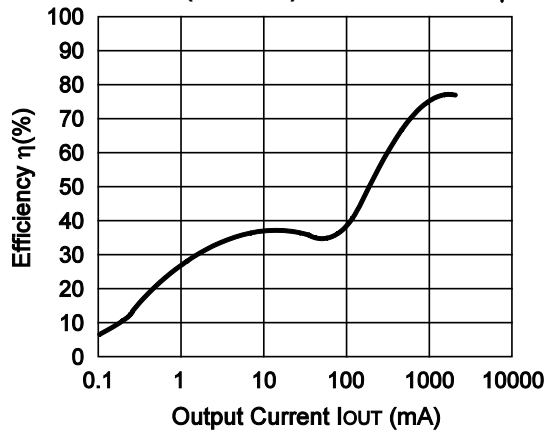

R1225N182J ( $V_{IN}=3.3V$ ) CDRH127-27 $\mu$ H

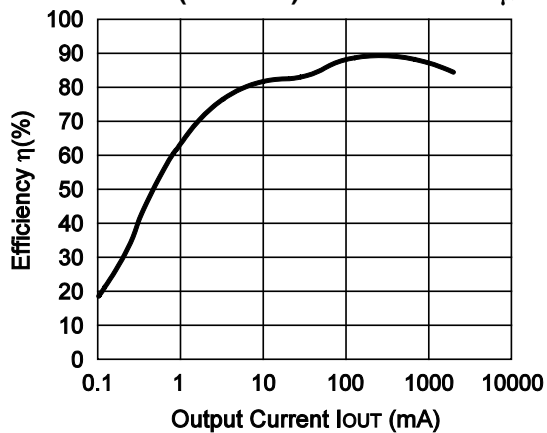

R1225N182J ( $V_{IN}=5.0V$ ) CDRH127-27 $\mu$ H

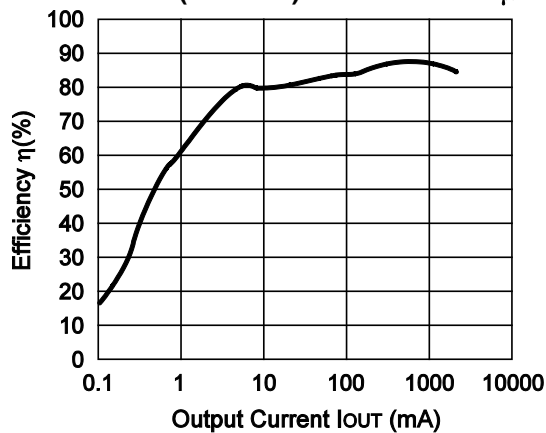

R1225N182K ( $V_{IN}=3.3V$ ) CDRH127-27 $\mu$ H

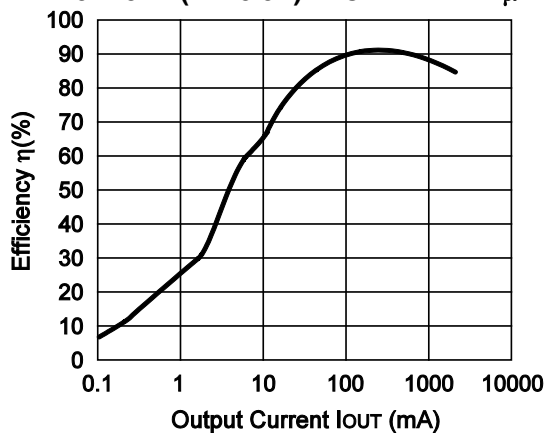

R1225N182K ( $V_{IN}=5.0V$ ) CDRH127-27 $\mu$ H

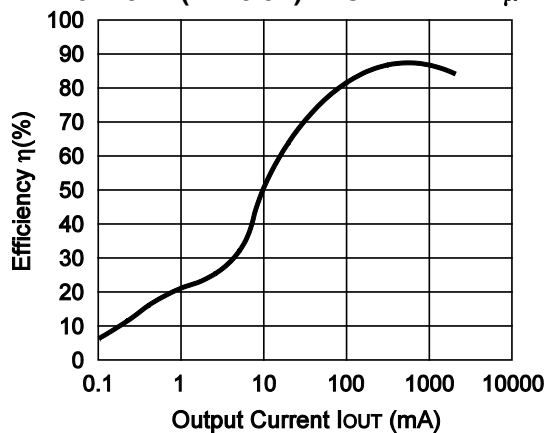

R1225N182K ( $V_{IN}=12V$ ) CDRH127-27 $\mu$ H

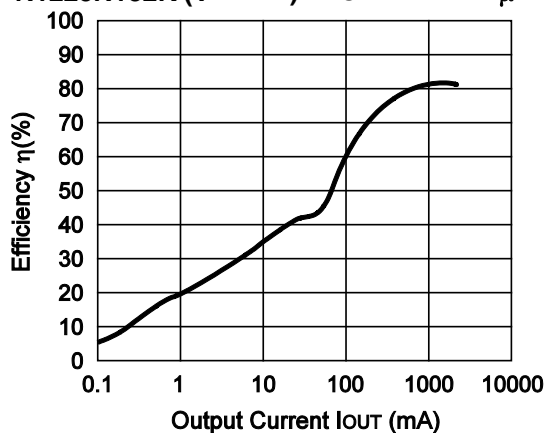

R1225N332A ( $V_{IN}=4.8V$ ) CDRH127-10 $\mu$ H

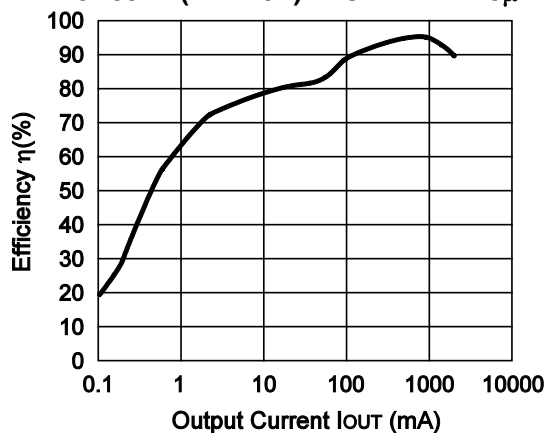

---

# R1225N

---

NO.EA-097-181004

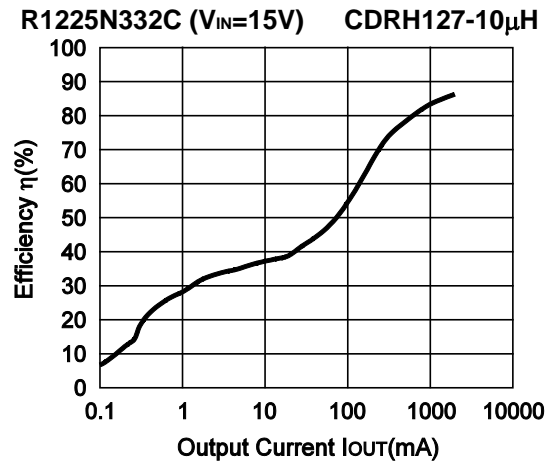
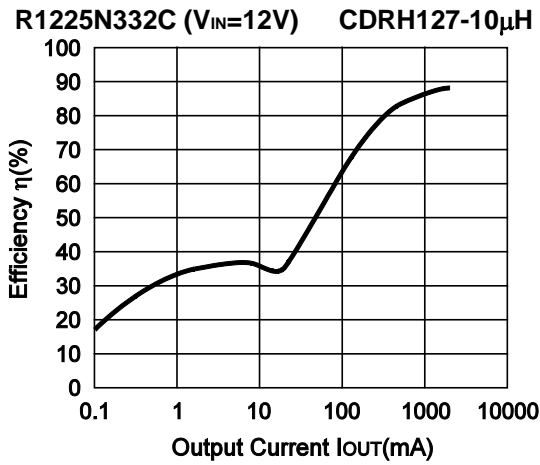
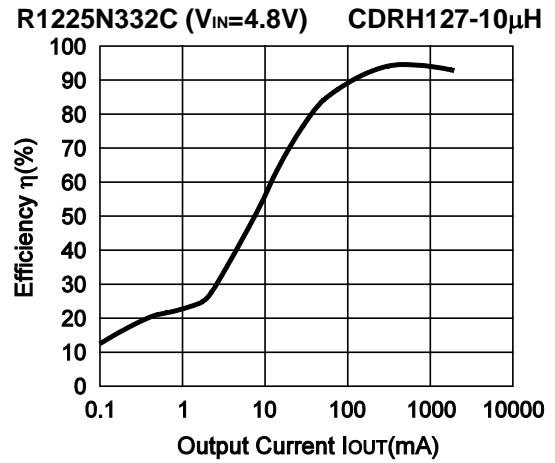
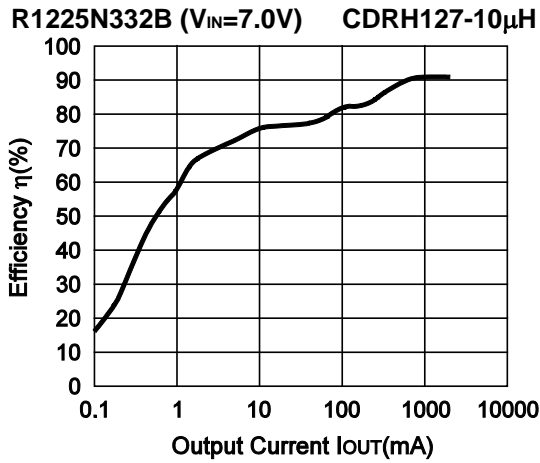
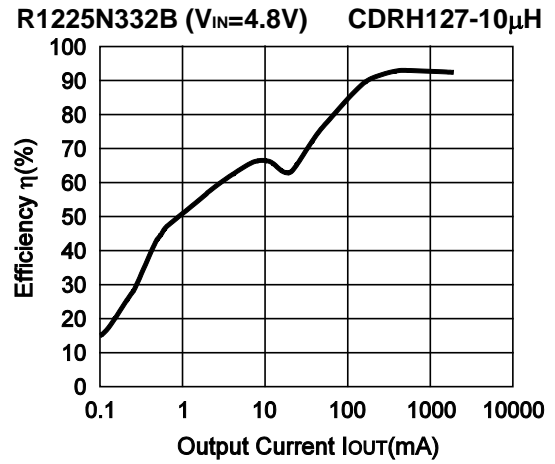
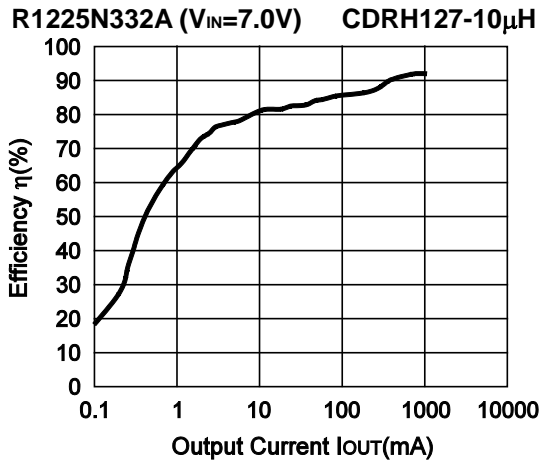

R1225N332D (V<sub>IN</sub>=4.8V) CDRH127-10μH



R1225N332D (V<sub>IN</sub>=12V) CDRH127-10μH



R1225N332D (V<sub>IN</sub>=15V) CDRH127-10μH

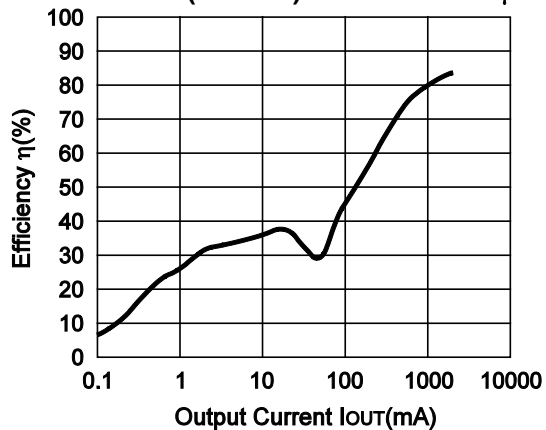

R1225N332K (V<sub>IN</sub>=4.8V) CDRH127-27μH



R1225N332K (V<sub>IN</sub>=12V) CDRH127-27μH

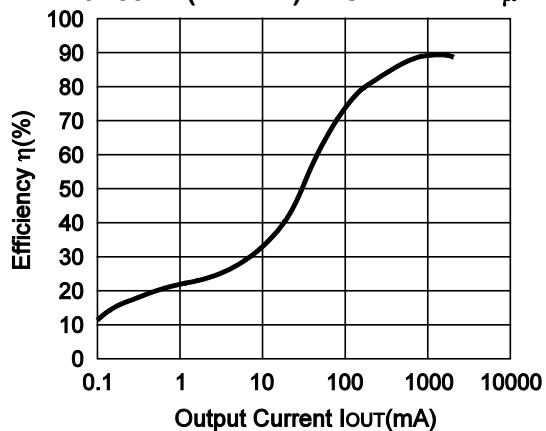

R1225N332K (V<sub>IN</sub>=15V) CDRH127-27μH



---

# R1225N

---

NO.EA-097-181004

R1225N502A ( $V_{IN}=6.5V$ ) CDRH127-10 $\mu$ H

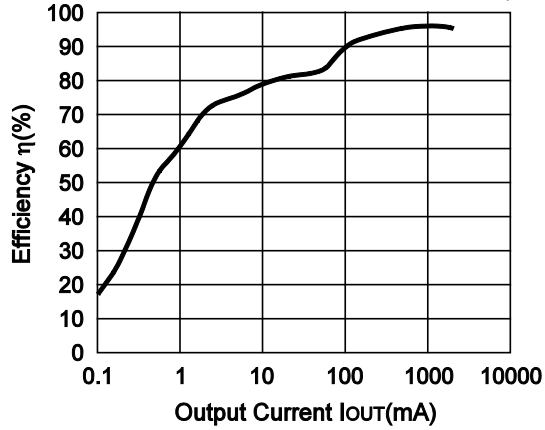

R1225N502A ( $V_{IN}=10V$ ) CDRH127-10 $\mu$ H



R1225N502B ( $V_{IN}=6.5V$ ) CDRH127-10 $\mu$ H

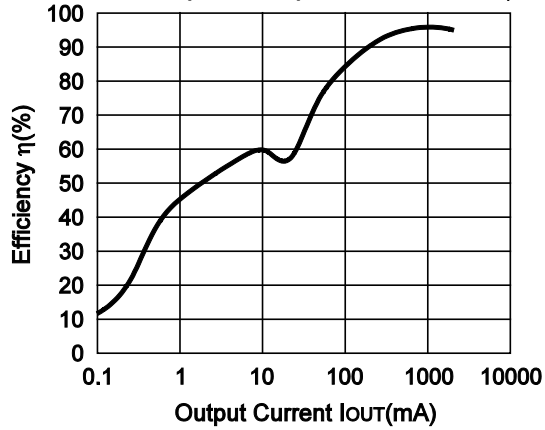

R1225N502B ( $V_{IN}=10V$ ) CDRH127-10 $\mu$ H



R1225N502C ( $V_{IN}=6.5V$ ) CDRH127-10 $\mu$ H

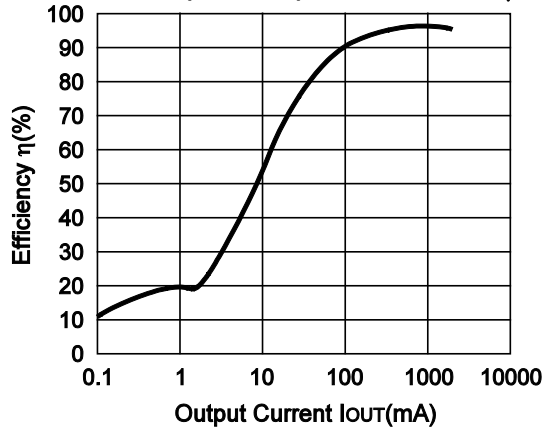

R1225N502C ( $V_{IN}=12V$ ) CDRH127-10 $\mu$ H



R1225N502C (V<sub>IN</sub>=15V) CDRH127-10μH

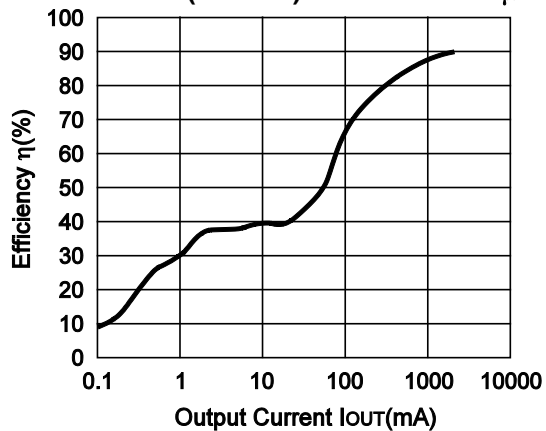

R1225N502D (V<sub>IN</sub>=6.5V) CDRH127-10μH

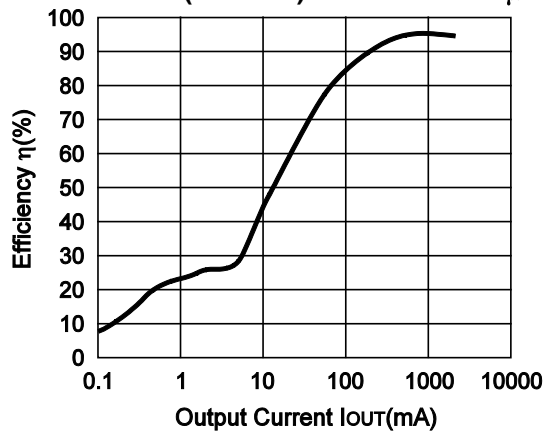

R1225N502D (V<sub>IN</sub>=12V) CDRH127-10μH



R1225N502D (V<sub>IN</sub>=15V) CDRH127-10μH



R1225N502J (V<sub>IN</sub>=6.5V) CDRH127-27μH



R1225N502J (V<sub>IN</sub>=10V) CDRH127-27μH



# R1225N

NO.EA-097-181004

R1225N502K ( $V_{IN}=6.5V$ ) CDRH127-27 $\mu$ H

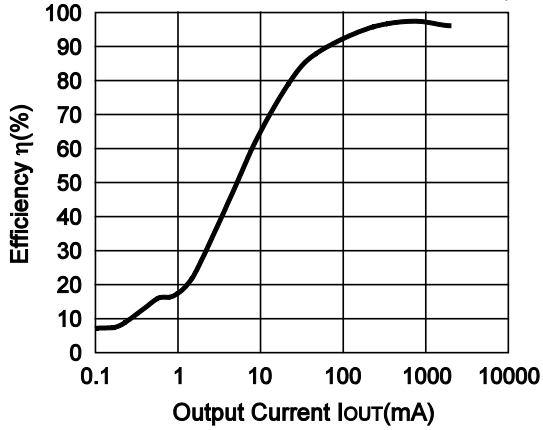

R1225N502K ( $V_{IN}=12V$ ) CDRH127-27 $\mu$ H

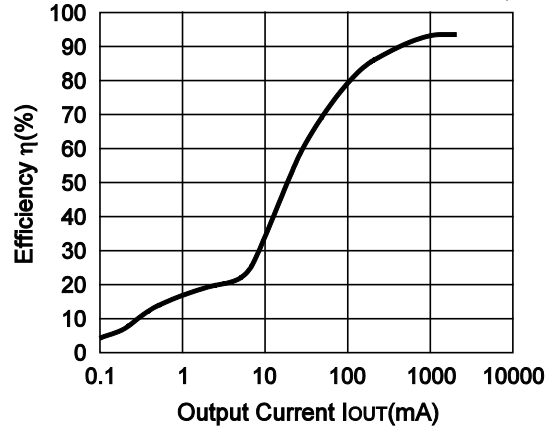

R1225N502K ( $V_{IN}=15V$ ) CDRH127-27 $\mu$ H

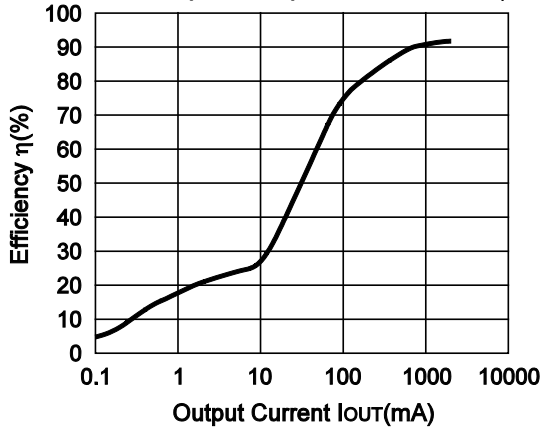

## 2) Ripple Voltage vs. Output Current

R1225N182A L=10 $\mu$ H

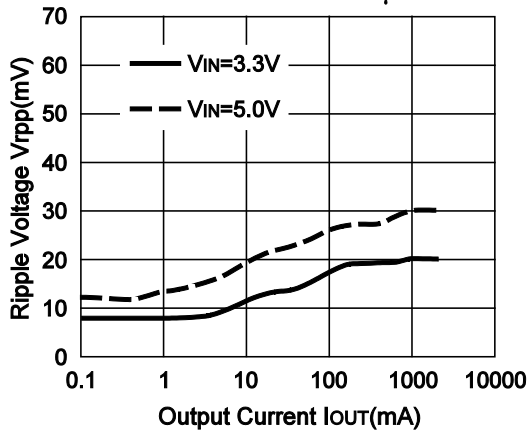

R1225N182B L=10 $\mu$ H

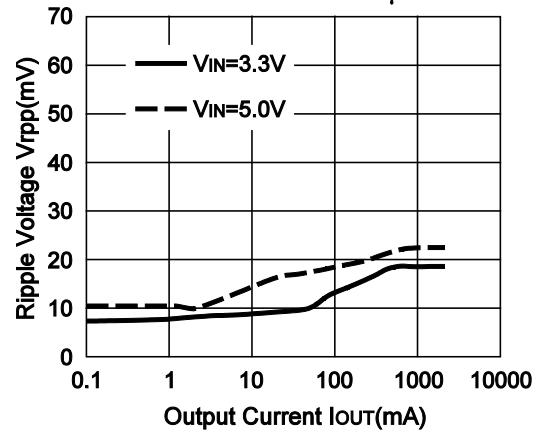





# R1225N

NO.EA-097-181004



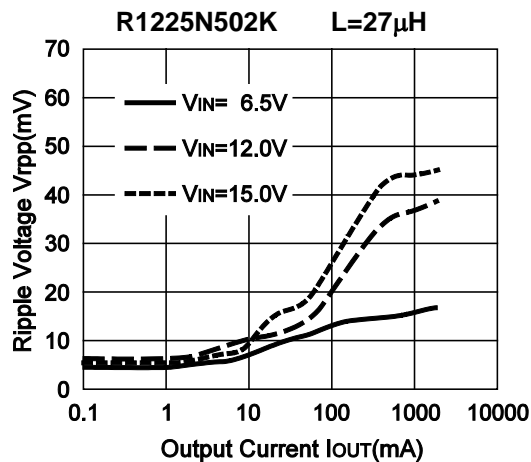
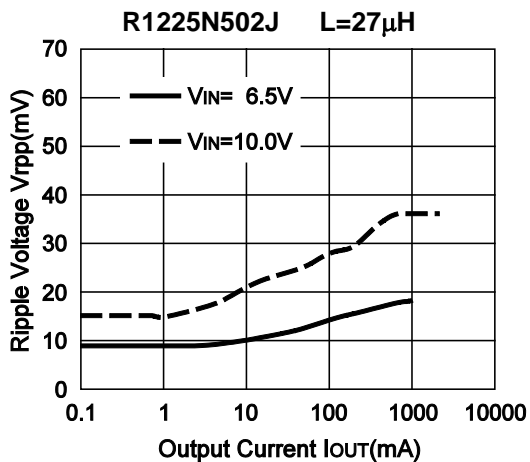
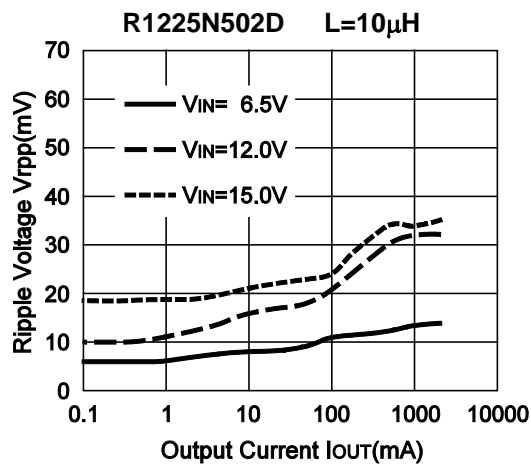
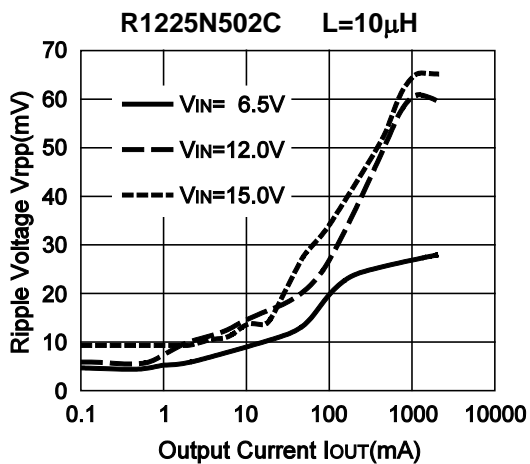

3) Input Voltage vs. Output Voltage

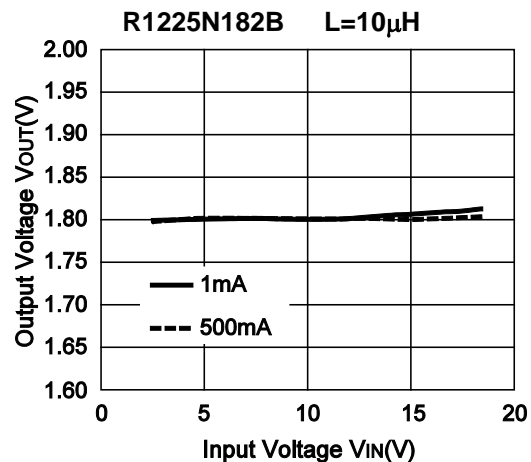
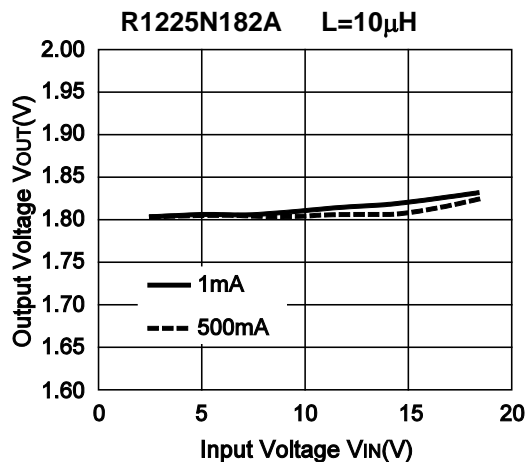

# R1225N

NO.EA-097-181004





4) Output Voltage vs. Output Current

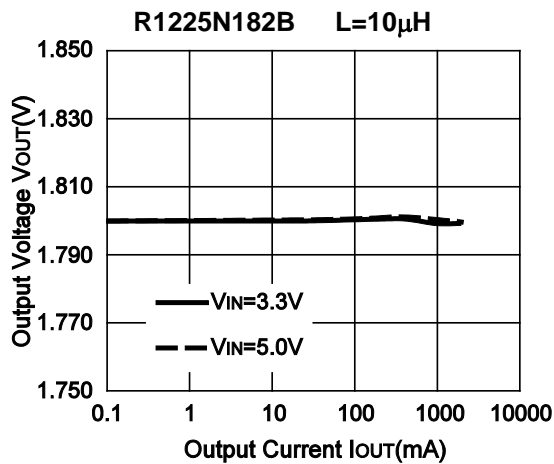
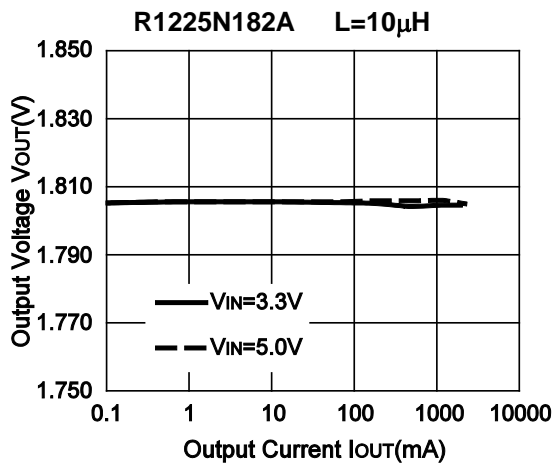

# R1225N

NO.EA-097-181004



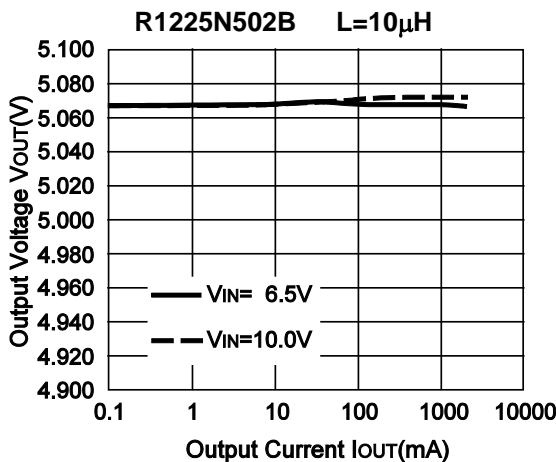
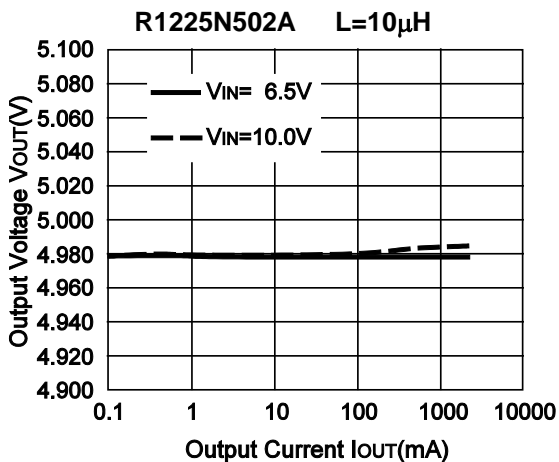
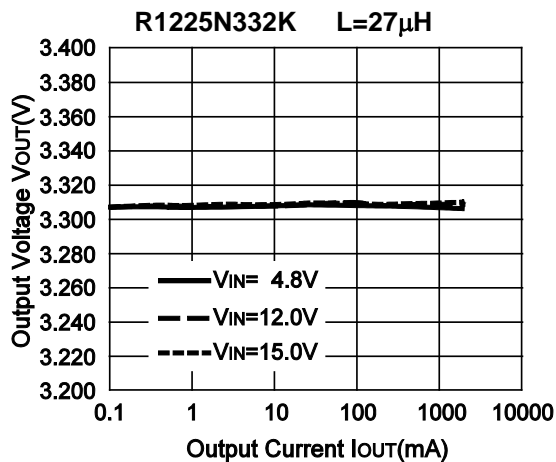
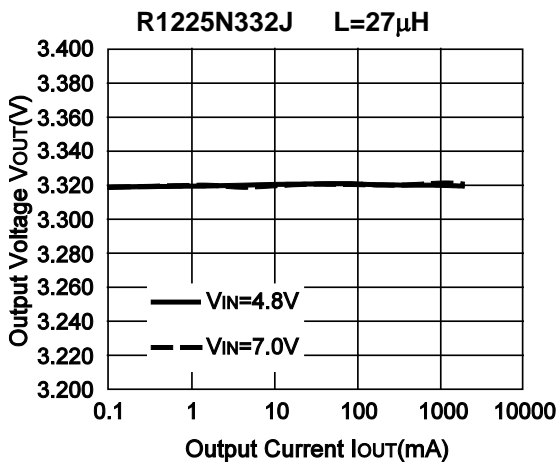
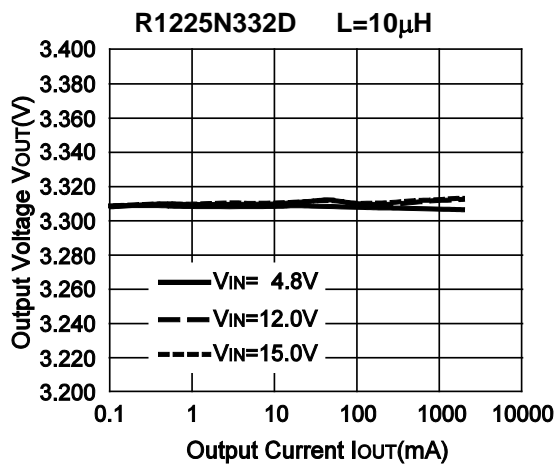
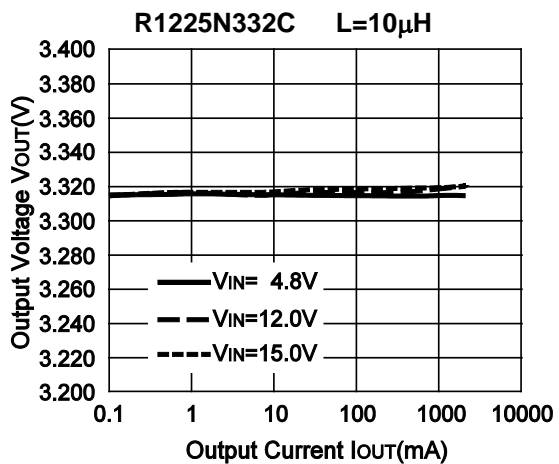

# R1225N

NO.EA-097-181004

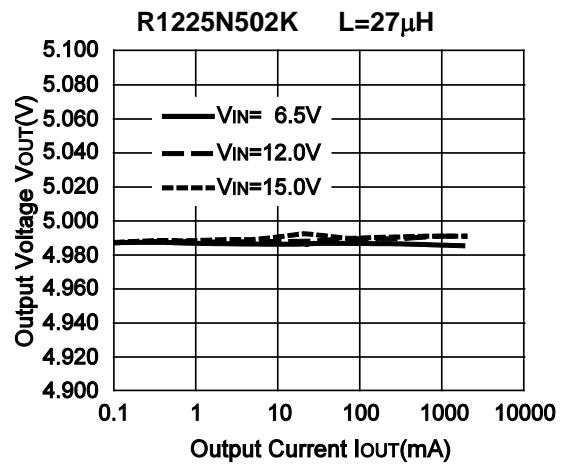
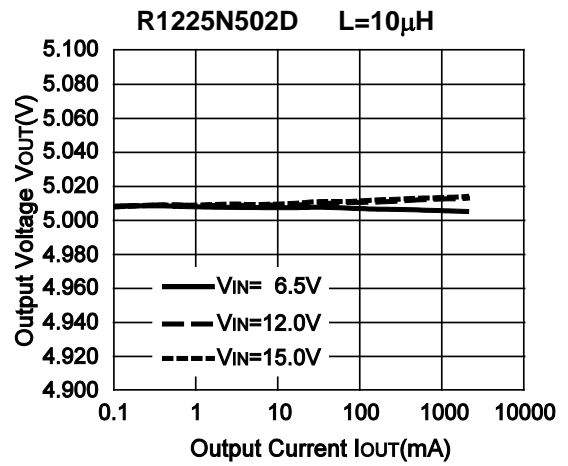

## 5) Load Transient Response

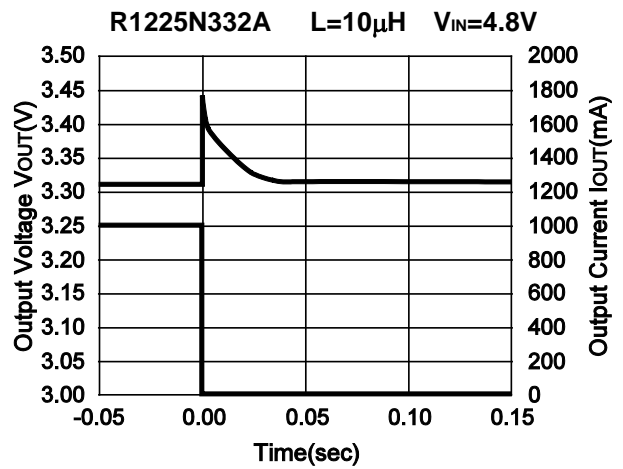



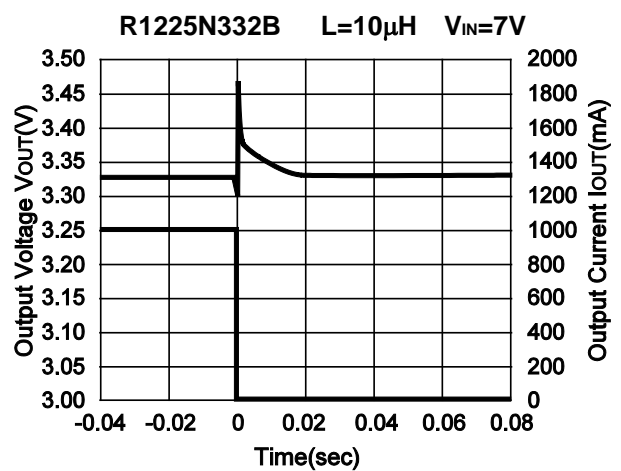
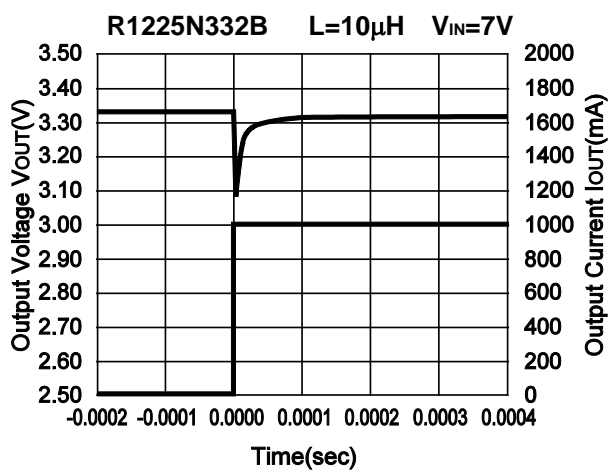
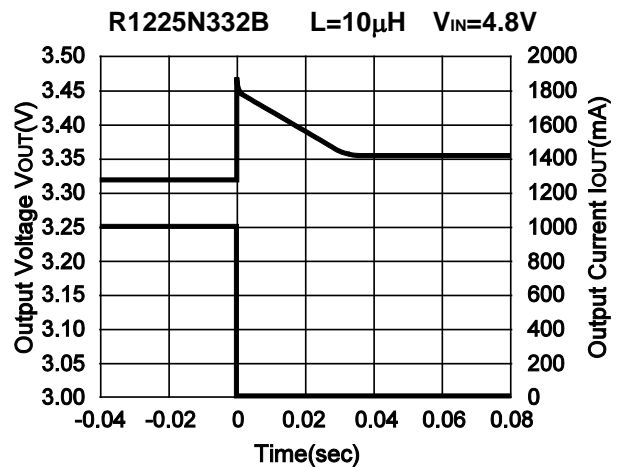
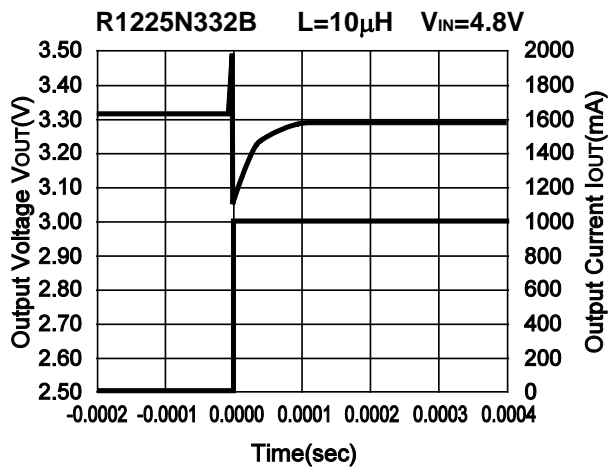
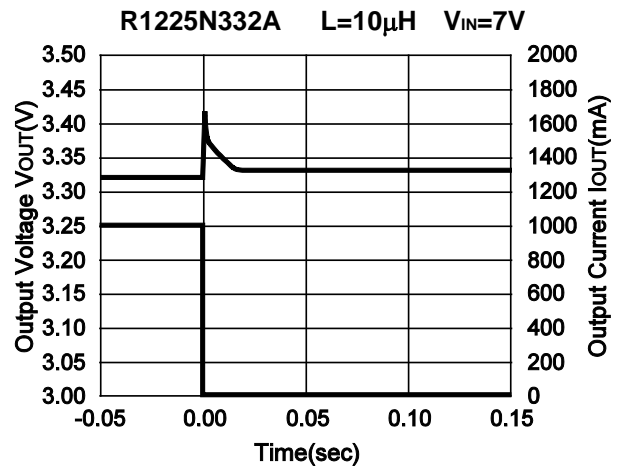
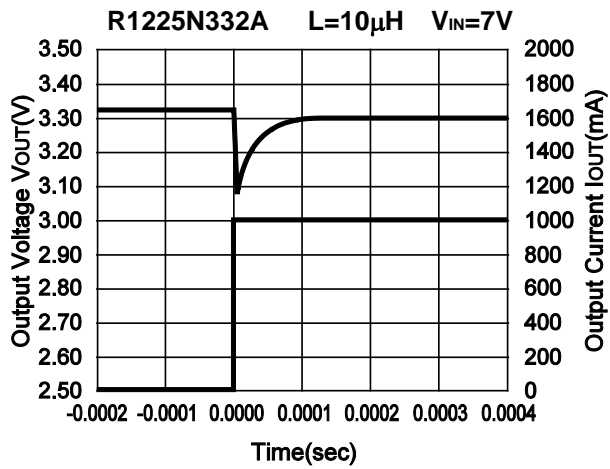

---

# R1225N

---

NO.EA-097-181004

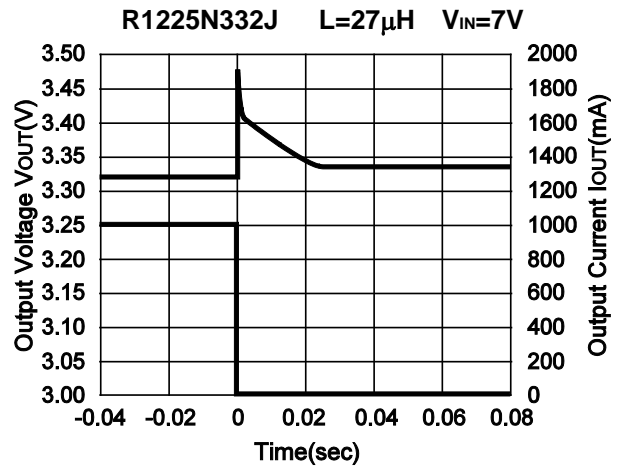
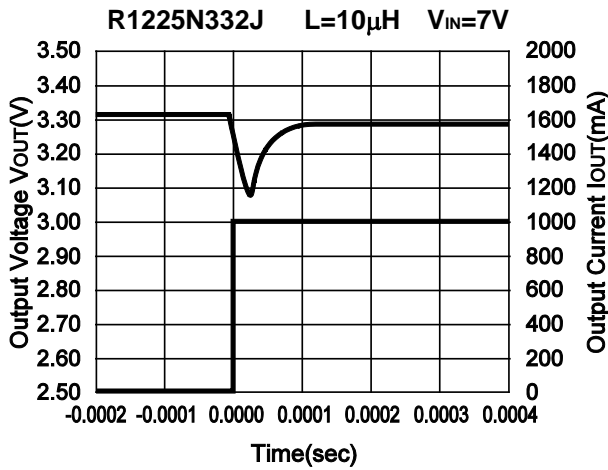
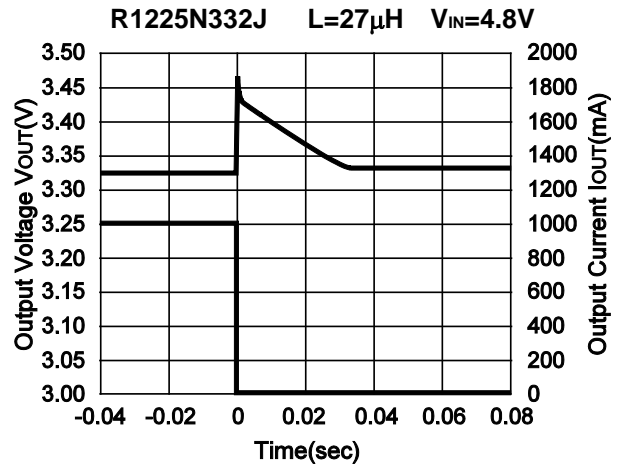
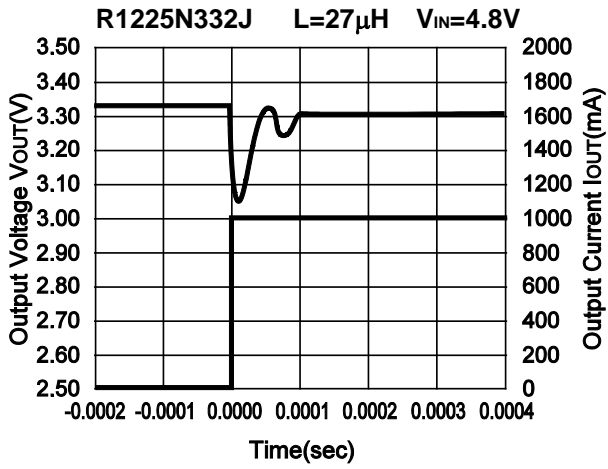



1. The products and the product specifications described in this document are subject to change or discontinuation of production without notice for reasons such as improvement. Therefore, before deciding to use the products, please refer to Ricoh sales representatives for the latest information thereon.
2. The materials in this document may not be copied or otherwise reproduced in whole or in part without prior written consent of Ricoh.
3. Please be sure to take any necessary formalities under relevant laws or regulations before exporting or otherwise taking out of your country the products or the technical information described herein.
4. The technical information described in this document shows typical characteristics of and example application circuits for the products. The release of such information is not to be construed as a warranty of or a grant of license under Ricoh's or any third party's intellectual property rights or any other rights.
5. The products listed in this document are intended and designed for use as general electronic components in standard applications (office equipment, telecommunication equipment, measuring instruments, consumer electronic products, amusement equipment etc.). Those customers intending to use a product in an application requiring extreme quality and reliability, for example, in a highly specific application where the failure or misoperation of the product could result in human injury or death (aircraft, spacevehicle, nuclear reactor control system, traffic control system, automotive and transportation equipment, combustion equipment, safety devices, life support system etc.) should first contact us.
6. We are making our continuous effort to improve the quality and reliability of our products, but semiconductor products are likely to fail with certain probability. In order to prevent any injury to persons or damages to property resulting from such failure, customers should be careful enough to incorporate safety measures in their design, such as redundancy feature, fire containment feature and fail-safe feature. We do not assume any liability or responsibility for any loss or damage arising from misuse or inappropriate use of the products.
7. Anti-radiation design is not implemented in the products described in this document.
8. The X-ray exposure can influence functions and characteristics of the products. Confirm the product functions and characteristics in the evaluation stage.
9. WLCSP products should be used in light shielded environments. The light exposure can influence functions and characteristics of the products under operation or storage.
10. There can be variation in the marking when different AOI (Automated Optical Inspection) equipment is used. In the case of recognizing the marking characteristic with AOI, please contact Ricoh sales or our distributor before attempting to use AOI.
11. Please contact Ricoh sales representatives should you have any questions or comments concerning the products or the technical information.



**Ricoh is committed to reducing the environmental loading materials in electrical devices with a view to contributing to the protection of human health and the environment.**

Ricoh has been providing RoHS compliant products since April 1, 2006 and Halogen-free products since April 1, 2012.

**RICOH** RICOH ELECTRONIC DEVICES CO., LTD.

<https://www.e-devices.ricoh.co.jp/en/>

#### Sales & Support Offices

##### **Ricoh Electronic Devices Co., Ltd.**

##### **Shin-Yokohama Office (International Sales)**

2-3, Shin-Yokohama 3-chome, Kohoku-ku, Yokohama-shi, Kanagawa, 222-8530, Japan  
Phone: +81-50-3814-7687 Fax: +81-45-474-0074

##### **Ricoh Americas Holdings, Inc.**

675 Campbell Technology Parkway, Suite 200 Campbell, CA 95008, U.S.A.  
Phone: +1-408-610-3105

##### **Ricoh Europe (Netherlands) B.V.**

##### **Semiconductor Support Centre**

Prof. W.H. Keesomlaan 1, 1183 DJ Amstelveen, The Netherlands  
Phone: +31-20-5474-309

##### **Ricoh International B.V. - German Branch**

##### **Semiconductor Sales and Support Centre**

Oberrather Strasse 6, 40472 Düsseldorf, Germany  
Phone: +49-211-6546-0

##### **Ricoh Electronic Devices Korea Co., Ltd.**

3F, Haesung Bldg, 504, Teheran-ro, Gangnam-gu, Seoul, 135-725, Korea  
Phone: +82-2-2135-5700 Fax: +82-2-2051-5713

##### **Ricoh Electronic Devices Shanghai Co., Ltd.**

Room 403, No.2 Building, No.690 Bibo Road, Pu Dong New District, Shanghai 201203,  
People's Republic of China  
Phone: +86-21-5027-3200 Fax: +86-21-5027-3299

##### **Ricoh Electronic Devices Shanghai Co., Ltd.**

##### **Shenzhen Branch**

1205, Block D (Jinlong Building), Kingkey 100, Hongbao Road, Luohu District,  
Shenzhen, China  
Phone: +86-755-8348-7600 Ext 225

##### **Ricoh Electronic Devices Co., Ltd.**

##### **Taipei office**

Room 109, 10F-1, No.51, Hengyang Rd., Taipei City, Taiwan  
Phone: +886-2-2313-1621/1622 Fax: +886-2-2313-1623

# Mouser Electronics

Authorized Distributor

Click to View Pricing, Inventory, Delivery & Lifecycle Information:

## Ricoh Electronics:

[R1225N122A-TR-FE](#) [R1225N122B-TR-FE](#) [R1225N122D-TR-FE](#) [R1225N122J-TR-FE](#) [R1225N122K-TR-FE](#)  
[R1225N152A-TR-FE](#) [R1225N602K-TR-FE](#) [R1225N502J-TR-FE](#) [R1225N502K-TR-FE](#) [R1225N542A-TR-FE](#)  
[R1225N552K-TR-FE](#) [R1225N602C-TR-FE](#) [R1225N602D-TR-FE](#) [R1225N332K-TR-FE](#) [R1225N362B-TR-FE](#)  
[R1225N502A-TR-FE](#) [R1225N502B-TR-FE](#) [R1225N502C-TR-FE](#) [R1225N502D-TR-FE](#) [R1225N302K-TR-FE](#)  
[R1225N332A-TR-FE](#) [R1225N332B-TR-FE](#) [R1225N332C-TR-FE](#) [R1225N332D-TR-FE](#) [R1225N332J-TR-FE](#)  
[R1225N252K-TR-FE](#) [R1225N302A-TR-FE](#) [R1225N302B-TR-FE](#) [R1225N302C-TR-FE](#) [R1225N302D-TR-FE](#)  
[R1225N302J-TR-FE](#) [R1225N182D-TR-FE](#) [R1225N182J-TR-FE](#) [R1225N182K-TR-FE](#) [R1225N252B-TR-FE](#)  
[R1225N252C-TR-FE](#) [R1225N252D-TR-FE](#) [R1225N162D-TR-FE](#) [R1225N172B-TR-FE](#) [R1225N172D-TR-FE](#)  
[R1225N182A-TR-FE](#) [R1225N182B-TR-FE](#) [R1225N182C-TR-FE](#) [R1225N152B-TR-FE](#) [R1225N152C-TR-FE](#)  
[R1225N152D-TR-FE](#) [R1225N152J-TR-FE](#) [R1225N152K-TR-FE](#) [R1225N162B-TR-FE](#)



Компания «ЭлектроПласт» предлагает заключение долгосрочных отношений при поставках импортных электронных компонентов на взаимовыгодных условиях!

Наши преимущества:

- Оперативные поставки широкого спектра электронных компонентов отечественного и импортного производства напрямую от производителей и с крупнейших мировых складов;
- Поставка более 17-ти миллионов наименований электронных компонентов;
- Поставка сложных, дефицитных, либо снятых с производства позиций;
- Оперативные сроки поставки под заказ (от 5 рабочих дней);
- Экспресс доставка в любую точку России;
- Техническая поддержка проекта, помощь в подборе аналогов, поставка прототипов;
- Система менеджмента качества сертифицирована по Международному стандарту ISO 9001;
- Лицензия ФСБ на осуществление работ с использованием сведений, составляющих государственную тайну;
- Поставка специализированных компонентов (Xilinx, Altera, Analog Devices, Intersil, Interpoint, Microsemi, Aeroflex, Peregrine, Syfer, Eurofarad, Texas Instrument, Miteq, Cobham, E2V, MA-COM, Hittite, Mini-Circuits, General Dynamics и др.);

Помимо этого, одним из направлений компании «ЭлектроПласт» является направление «Источники питания». Мы предлагаем Вам помощь Конструкторского отдела:

- Подбор оптимального решения, техническое обоснование при выборе компонента;
- Подбор аналогов;
- Консультации по применению компонента;
- Поставка образцов и прототипов;
- Техническая поддержка проекта;
- Защита от снятия компонента с производства.



#### Как с нами связаться

**Телефон:** 8 (812) 309 58 32 (многоканальный)

**Факс:** 8 (812) 320-02-42

**Электронная почта:** [org@eplast1.ru](mailto:org@eplast1.ru)

**Адрес:** 198099, г. Санкт-Петербург, ул. Калинина, дом 2, корпус 4, литера А.