

DRQ

Dual winding, high power density, shielded drum core power inductors



Product features

- Dual winding inductors that can be used as either a single inductor, or in coupled inductor/transformer applications (1:1 turns ratio)
- Four sizes of shielded drum core inductors
- Windings can be connected in series or parallel, offering a broad range of inductance and current ratings
- Peak current ratings from 0.13 A to 56 A
- RMS current ratings from 0.128 A to 17.9 A
- Inductance ratings from 0.33 μ H to 4.02 mH
- 200 Vac Isolation between windings
- Ferrite core material

Applications

- Desktop and servers
- DVD and media players
- Portable and handheld devices
- LCD panels
- As a transformer: SEPIC, flyback
- As an inductor: buck, boost, coupled inductor
- DC-DC Converters
- VRM inductor for CPU and DDR power supplies
- Input and output filter chokes

Environmental data

- Storage temperature range (component): -40 °C to +125 °C
- Operating temperature range: -40 °C to +125 °C (ambient plus self-temperature rise)
- Solder reflow temperature: J-STD-020 (latest revision) compliant



Product specifications

Part Number	Rated Inductance (μH)	Parallel Ratings					Series Ratings				
		OCL ¹ ±20% (μH)	I _{rms} ² (A)	I _{sat} ³ (A) Peak	DCR Ω ⁴ typ.	Volt ⁵ μ-sec	OCL ¹ ±20% (μH)	I _{rms} ² (A)	I _{sat} ³ (A) Peak	DCR Ω ⁴ typ.	Volt ⁵ μ-sec
DRQ73-R33-R	0.33	0.306	6.19	14.4	0.0074	1.98	1.224	3.10	7.18	0.0296	3.96
DRQ73-1R0-R	1.00	0.992	5.25	7.97	0.0103	3.56	3.968	2.63	3.99	0.0411	7.12
DRQ73-1R5-R	1.50	1.482	4.64	6.52	0.0132	4.36	5.928	2.32	3.26	0.0527	8.72
DRQ73-2R2-R	2.20	2.070	4.11	5.52	0.0167	5.15	8.280	2.06	2.76	0.0669	10.3
DRQ73-3R3-R	3.30	3.540	3.31	4.22	0.0259	6.73	14.16	1.66	2.11	0.1035	13.5
DRQ73-4R7-R	4.70	4.422	3.09	3.78	0.0297	7.52	17.69	1.55	1.89	0.1188	15.0
DRQ73-6R8-R	6.80	6.480	2.55	3.12	0.0435	9.11	25.92	1.28	1.56	0.1742	18.2
DRQ73-8R2-R	8.20	8.930	2.19	2.66	0.0592	10.7	35.72	1.10	1.33	0.2368	21.4
DRQ73-100-R	10.0	10.30	2.08	2.47	0.0656	11.5	41.20	1.04	1.24	0.2623	23.0
DRQ73-150-R	15.0	15.01	1.83	2.05	0.0844	13.9	60.04	0.916	1.03	0.339	27.8
DRQ73-220-R	22.0	22.65	1.62	1.67	0.107	17.0	90.60	0.811	0.83	0.429	34.0
DRQ73-330-R	33.0	34.41	1.31	1.35	0.166	21.0	137.6	0.653	0.68	0.665	42.0
DRQ73-470-R	47.0	48.62	1.08	1.14	0.241	24.9	194.5	0.542	0.57	0.965	49.8
DRQ73-680-R	68.0	68.91	0.89	0.96	0.358	29.7	275.6	0.444	0.48	1.43	59.4
DRQ73-820-R	82.0	80.37	0.86	0.89	0.384	32.1	321.5	0.430	0.44	1.54	64.2
DRQ73-101-R	100	101.4	0.73	0.79	0.527	36.0	405.6	0.367	0.39	2.11	72.0
DRQ73-151-R	150	150.9	0.58	0.65	0.851	44.0	603.6	0.289	0.32	3.41	88.0
DRQ73-221-R	220	223.3	0.52	0.53	1.05	53.5	893.2	0.260	0.27	4.20	107
DRQ73-331-R	330	325.5	0.42	0.44	1.59	64.5	1302	0.211	0.22	6.36	129
DRQ73-471-R	470	465.8	0.35	0.37	2.36	77.2	1863	0.173	0.18	9.44	154
DRQ73-681-R	680	676.5	0.29	0.31	3.47	93.1	2706	0.143	0.15	13.88	186
DRQ73-821-R	820	821.7	0.27	0.28	3.93	103	3287	0.134	0.14	15.72	206
DRQ73-102-R	1000	995.0	0.26	0.25	4.34	113	3980	0.128	0.13	17.36	226

- Open Circuit Inductance Test Parameters: 100 kHz, 0.25 V_{rms}, 0.0 Adc
Parallel: (1,2 -4,3) Series: (1-4) tie (2-3)
- RMS current for an approximate DT of 40 °C without core loss.
It is recommended that the temperature of the part not exceed +125 °C.
- Peak current for approximately 30% roll-off at +20 °C
- DCR limits @ +20 °C
- Applied Volt-Time product (V-μs) across the inductor. This value represents the applied V-μs at 100 kHz necessary to generate a core loss equal to 10% of the total losses for a 40 °C temperature rise.

- Turns Ratio (1:3):(2-4) 1:1
- Part number definition: DRQxxx-yyy-
- DRQxxx = product code and size,
- yyy = inductance value in μH,
- R = decimal point. If no R is present, third character = # of zeros
- "-R" suffix = RoHS compliant

Product specifications

Part Number	Rated Inductance (μH)	Parallel Ratings					Series Ratings				
		OCL ¹ ±20% (μH)	I _{rms} ² (A)	I _{sat} ³ (A) Peak	DCR Ω ⁴ Typ.	Volt ⁵ μ-sec	OCL ¹ ±20% (μH)	I _{rms} ² (A)	I _{sat} ³ (A) Peak	DCR Ω ⁴ Typ.	Volt ⁵ μ-sec
DRQ74-R33-R	0.33	0.294	6.20	18.4	0.0074	1.71	1.176	3.10	9.18	0.0295	3.42
DRQ74-1R0-R	1.00	0.952	5.33	10.2	0.0100	3.08	3.808	2.66	5.10	0.0400	6.16
DRQ74-1R5-R	1.50	1.422	4.96	8.35	0.0115	3.76	5.688	2.48	4.17	0.0461	7.52
DRQ74-2R2-R	2.20	1.986	4.66	7.06	0.0130	4.45	7.944	2.33	3.53	0.0521	8.9
DRQ74-3R3-R	3.30	3.396	3.94	5.40	0.0183	5.81	13.58	1.97	2.70	0.0732	11.6
DRQ74-4R7-R	4.70	5.182	3.34	4.37	0.0254	7.18	20.73	1.67	2.19	0.102	14.4
DRQ74-6R8-R	6.80	7.344	2.60	3.67	0.0418	8.55	29.38	1.30	1.84	0.167	17.1
DRQ74-8R2-R	8.20	8.566	2.53	3.40	0.0441	9.23	34.26	1.27	1.70	0.177	18.5
DRQ74-100-R	10.0	9.882	2.41	3.17	0.0489	9.92	39.53	1.20	1.58	0.196	19.8
DRQ74-150-R	15.0	16.09	2.11	2.48	0.0637	12.7	64.36	1.05	1.24	0.255	25.4
DRQ74-220-R	22.0	21.73	1.75	2.13	0.0925	14.7	86.92	0.874	1.07	0.371	29.4
DRQ74-330-R	33.0	33.01	1.41	1.73	0.143	18.1	132.0	0.702	0.87	0.574	36.2
DRQ74-470-R	47.0	49.64	1.15	1.41	0.216	22.2	198.6	0.573	0.71	0.865	44.4
DRQ74-680-R	68.0	69.67	1.03	1.19	0.265	26.3	278.7	0.517	0.60	1.06	52.6
DRQ74-820-R	82.0	80.95	0.91	1.11	0.345	28.4	323.8	0.453	0.55	1.38	56.8
DRQ74-101-R	100	101.6	0.86	0.99	0.383	31.8	406.4	0.430	0.49	1.53	63.6
DRQ74-151-R	150	150.0	0.69	0.81	0.591	38.6	600.0	0.346	0.41	2.37	77.2
DRQ74-221-R	220	227.0	0.56	0.66	0.907	47.5	908.0	0.279	0.33	3.63	95
DRQ74-331-R	330	335.6	0.45	0.54	1.41	57.8	1342	0.224	0.27	5.66	116
DRQ74-471-R	470	465.3	0.40	0.46	1.74	68.1	1861	0.202	0.23	6.97	136
DRQ74-681-R	680	671.2	0.33	0.38	2.58	81.7	2685	0.166	0.19	10.3	163
DRQ74-821-R	820	812.7	0.31	0.35	2.93	89.9	3251	0.156	0.17	11.7	180
DRQ74-102-R	1000	1009	0.27	0.31	3.89	100	4036	0.135	0.16	15.6	200

- Open Circuit Inductance Test Parameters: 100 kHz, 0.25 V_{rms}, 0.0 Adc
Parallel: (1,2 -4,3) Series: (1-4) tie (2-3)
- RMS current for an approximate DT of 40 °C without core loss.
It is recommended that the temperature of the part not exceed +125 °C.
- Peak current for approximately 30% roll-off at +20 °C
- DCR limits @ +20 °C
- Applied Volt-Time product (V-μs) across the inductor. This value represents the applied V-μs at 100 kHz necessary to generate a core loss equal to 10% of the total losses for a 40 °C temperature rise.

- Turns Ratio (1:3):(2-4) 1:1
- Part number definition: DRQxxx-yyy-
- DRQxxx = product code and size,
- yyy = inductance value in μH,
- R = decimal point. If no R is present, third character = # of zeros
- "-R" suffix = RoHS compliant

Product specifications

Part Number	Rated Inductance (μH)	Parallel Ratings					Series Ratings				
		OCL ¹ ±20% (μH)	I _{rms} ² (A)	I _{sat} ³ (A) Peak	DCR Ω ⁴ typ.	Volt ⁵ μ-sec	OCL ¹ ±20% (μH)	I _{rms} ² (A)	I _{sat} ³ (A) Peak	DCR Ω ⁴ typ.	Volt ⁵ μ-sec
DRQ125-R47-R	0.47	0.456	17.6	33.0	0.0018	3.17	1.824	8.80	16.5	0.0078	6.34
DRQ125-1R0-R	1.00	0.894	15.0	23.6	0.0024	4.43	3.576	7.51	11.8	0.0096	8.86
DRQ125-1R5-R	1.50	1.478	13.8	18.3	0.0029	5.70	5.912	6.89	9.15	0.0114	11.40
DRQ125-2R2-R	2.20	2.208	10.9	15.0	0.0045	6.97	8.832	5.46	7.50	0.0182	13.9
DRQ125-3R3-R	3.30	3.084	9.26	12.7	0.0063	8.23	12.34	4.63	6.35	0.0253	16.5
DRQ125-4R7-R	4.70	5.274	7.18	9.71	0.0105	10.8	21.10	3.59	4.86	0.0420	21.6
DRQ125-6R8-R	6.80	6.588	6.64	8.68	0.0123	12.0	26.35	3.32	4.34	0.0492	24.0
DRQ125-8R2-R	8.20	8.048	5.54	7.86	0.0176	13.3	32.19	2.77	3.93	0.0705	26.6
DRQ125-100-R	10.0	9.654	5.35	7.17	0.0189	14.6	38.62	2.67	3.59	0.0757	29.2
DRQ125-150-R	15.0	15.35	4.27	5.69	0.0298	18.4	61.40	2.13	2.85	0.120	36.8
DRQ125-220-R	22.0	22.36	3.70	4.71	0.0396	22.2	89.44	1.84	2.36	0.159	44.4
DRQ125-330-R	33.0	33.74	3.28	3.84	0.0505	27.2	135.0	1.64	1.92	0.203	54.4
DRQ125-470-R	47.0	47.47	2.71	3.24	0.0740	32.3	189.9	1.35	1.62	0.297	64.6
DRQ125-680-R	68.0	67.91	2.22	2.70	0.101	38.6	271.6	1.11	1.35	0.440	77.2
DRQ125-820-R	82.0	86.89	2.05	2.39	0.128	43.7	347.6	1.03	1.20	0.515	87.4
DRQ125-101-R	100	102.7	1.78	2.20	0.170	47.5	410.8	0.892	1.10	0.682	95.0
DRQ125-151-R	150	151.1	1.48	1.81	0.248	57.6	604.4	0.739	0.905	0.991	115.2
DRQ125-221-R	220	216.8	1.19	1.51	0.384	69.0	867.2	0.594	0.755	1.54	138
DRQ125-331-R	330	332.6	1.06	1.22	0.482	85.5	1330	0.530	0.610	1.93	171
DRQ125-471-R	470	473.1	0.87	1.02	0.718	102	1892	0.434	0.510	2.87	204
DRQ125-681-R	680	679.8	0.70	0.85	1.10	122	2719	0.350	0.425	4.42	244
DRQ125-821-R	820	828.0	0.60	0.77	1.49	135	3312	0.301	0.385	5.96	270
DRQ125-102-R	1000	1008	0.57	0.70	1.69	149	4032	0.283	0.350	6.76	298

- Open Circuit Inductance Test Parameters: 100 kHz, 0.25 V_{rms}, 0.0 Adc
Parallel: (1,2 -4,3) Series: (1-4) tie (2-3)
- RMS current for an approximate DT of 40 °C without core loss.
It is recommended that the temperature of the part not exceed +125 °C.
- Peak current for approximately 30% roll-off at +20 °C
- DCR limits @ +20 °C
- Applied Volt-Time product (V-μs) across the inductor. This value represents the applied V-μs at 100 kHz necessary to generate a core loss equal to 10% of the total losses for a 40 °C temperature rise.

- Turns Ratio (1:3):(2-4) 1:1
- Part number definition: DRQxxx-yyy-
- DRQxxx = product code and size,
- yyy = inductance value in μH,
- R = decimal point. If no R is present, third character = # of zeros
- "-R" suffix = RoHS compliant

Product specifications

Part Number	Rated Inductance (μH)	Parallel Ratings					Series Ratings				
		OCL ¹ ±20% (μH)	I _{rms} ² (A)	I _{sat} ³ (A) Peak	DCR Ω ⁴ typ.	Volt ⁵ μ-sec	OCL ¹ ±20% (μH)	I _{rms} ² (A)	I _{sat} ³ (A) Peak	DCR Ω ⁴ typ.	Volt ⁵ μ-sec
DRQ127-R47-R	0.47	0.419	17.9	56.0	0.00195	3.50	1.676	8.94	28	0.0078	7.00
DRQ127-1R0-R	1.00	0.821	15.5	40.0	0.00261	4.90	3.284	7.74	20	0.0104	9.80
DRQ127-1R5-R	1.50	1.357	13.5	31.1	0.00341	6.30	5.428	6.77	15.6	0.0137	12.60
DRQ127-2R2-R	2.20	2.027	12.5	25.5	0.00373	7.70	8.108	6.23	12.7	0.0161	15.4
DRQ127-3R3-R	3.30	2.831	10.4	21.5	0.00567	9.10	11.32	5.23	10.8	0.0229	18.2
DRQ127-4R7-R	4.70	4.841	8.25	16.5	0.00917	11.9	19.36	4.13	8.24	0.0367	23.8
DRQ127-6R8-R	6.80	7.387	7.34	13.3	0.0116	14.7	29.55	3.67	6.67	0.0465	29.4
DRQ127-8R2-R	8.20	8.861	6.32	12.2	0.0157	16.1	35.44	3.16	6.09	0.0627	32.2
DRQ127-100-R	10.0	10.47	6.04	11.2	0.0172	17.5	41.88	3.02	5.60	0.0686	35.0
DRQ127-150-R	15.0	14.09	5.03	9.66	0.0247	20.3	56.36	2.51	4.83	0.0990	40.6
DRQ127-220-R	22.0	22.93	4.00	7.57	0.0391	25.9	91.72	2.00	3.78	0.157	51.8
DRQ127-330-R	33.0	33.92	3.23	6.22	0.0600	31.5	135.7	1.61	3.11	0.241	63.0
DRQ127-470-R	47.0	47.05	2.95	5.28	0.0719	37.1	188.2	1.47	2.64	0.288	74.2
DRQ127-680-R	68.0	66.48	2.44	4.44	0.105	44.1	265.9	1.22	2.22	0.421	88.2
DRQ127-820-R	82.0	79.75	2.09	4.06	0.143	48.3	319.0	1.04	2.03	0.573	96.6
DRQ127-101-R	100	99.31	1.96	3.64	0.163	53.9	397.2	0.980	1.82	0.653	107.8
DRQ127-151-R	150	144.9	1.59	3.01	0.247	65.1	579.6	0.796	1.51	0.989	130.2
DRQ127-221-R	220	221.5	1.29	2.43	0.376	80.5	886.0	0.645	1.22	1.50	161
DRQ127-331-R	330	323.6	1.04	2.01	0.574	97.3	1294	0.522	1.01	2.30	195
DRQ127-471-R	470	467.1	0.85	1.68	0.861	117	1868	0.427	0.838	3.44	234
DRQ127-681-R	680	676.7	0.76	1.39	1.08	141	2707	0.380	0.697	4.32	282
DRQ127-821-R	820	818.1	0.65	1.27	1.47	155	3272	0.325	0.633	5.88	310
DRQ127-102-R	1000	1005	0.61	1.14	1.66	172	4020	0.307	0.571	6.64	344

1. Open Circuit Inductance Test Parameters: 100 kHz, 0.25 V_{rms}, 0.0 Adc
Parallel: (1,2 -4,3) Series: (1-4) tie (2-3)
2. RMS current for an approximate DT of 40 °C without core loss.
It is recommended that the temperature of the part not exceed +125 °C.
3. Peak current for approximately 30% roll-off at 20°C
4. DCR limits @ +20 °C
5. Applied Volt-Time product (V-μs) across the inductor. This value represents the applied V-μs at 100 kHz necessary to generate a core loss equal to 10% of the total losses for a 40 °C temperature rise.

6. Turns Ratio (1:3):(2-4) 1:1
7. Part number definition: DRQxxx-yyy-
- DRQxxx = product code and size,
- yyy = inductance value in μH,
- R = decimal point. If no R is present, third character = # of zeros
- "-R" suffix = RoHS compliant

Dimensions - mm

DRQ73

Top View



Side View

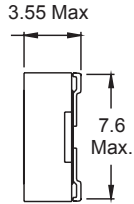

Recommended Pad Layout

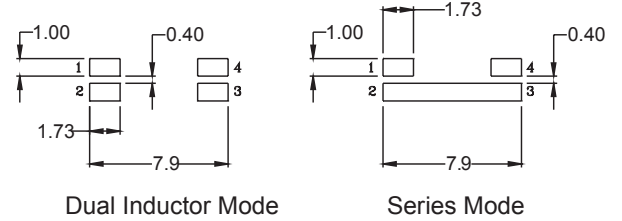

Bottom View

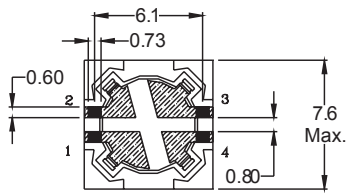

Schematic

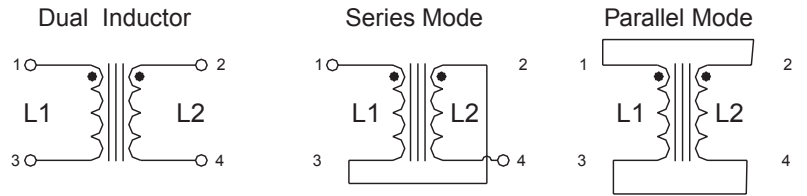

DRQ74

Top View



Side View

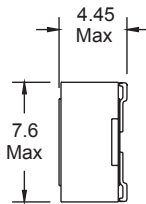

Recommended Pad Layout

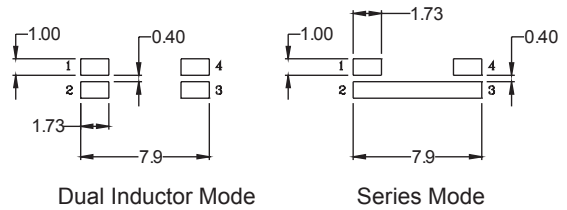

Bottom View

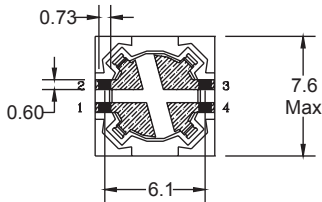

Schematic

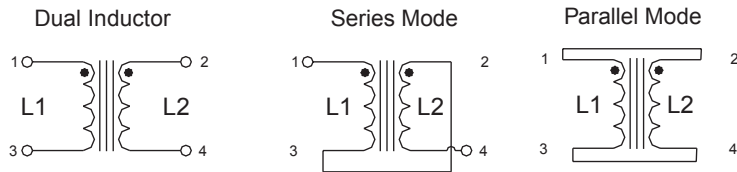

= Inductance value per family chart
wlyy = Date code
R = Revision level
Dot indicates pin #1
Do not route traces or vias underneath the inductor

Dimensions - mm

DRQ125

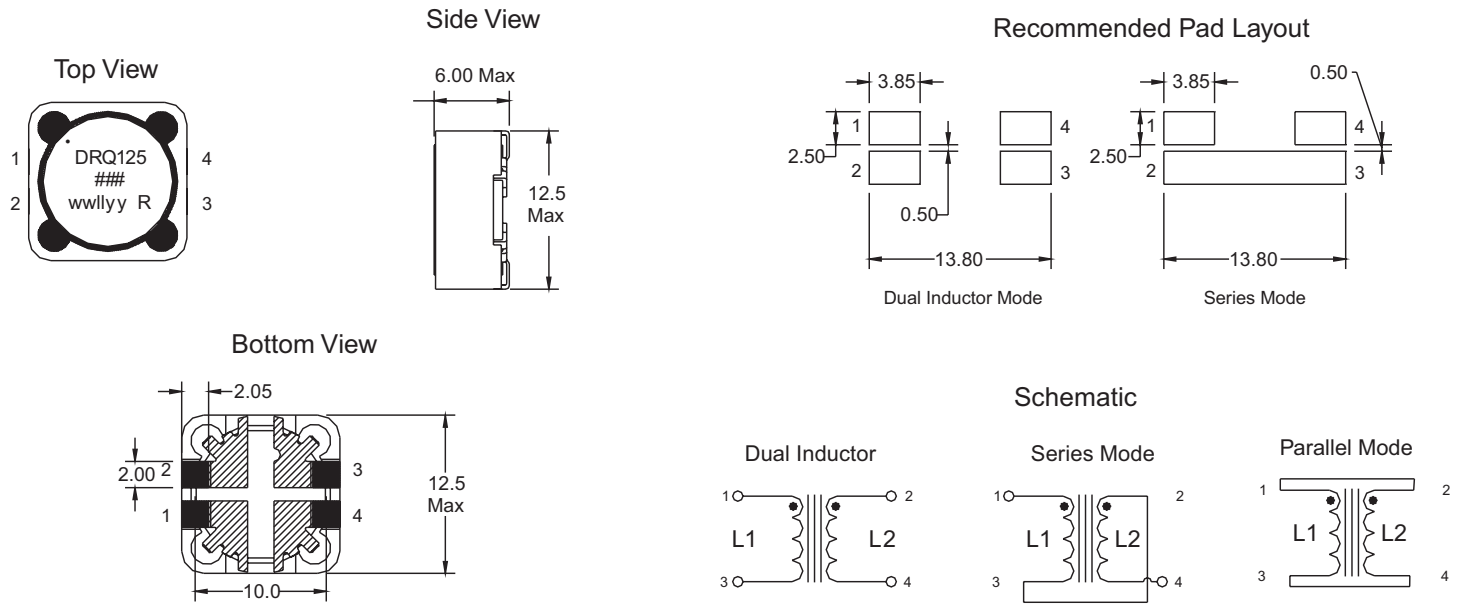

DRQ127

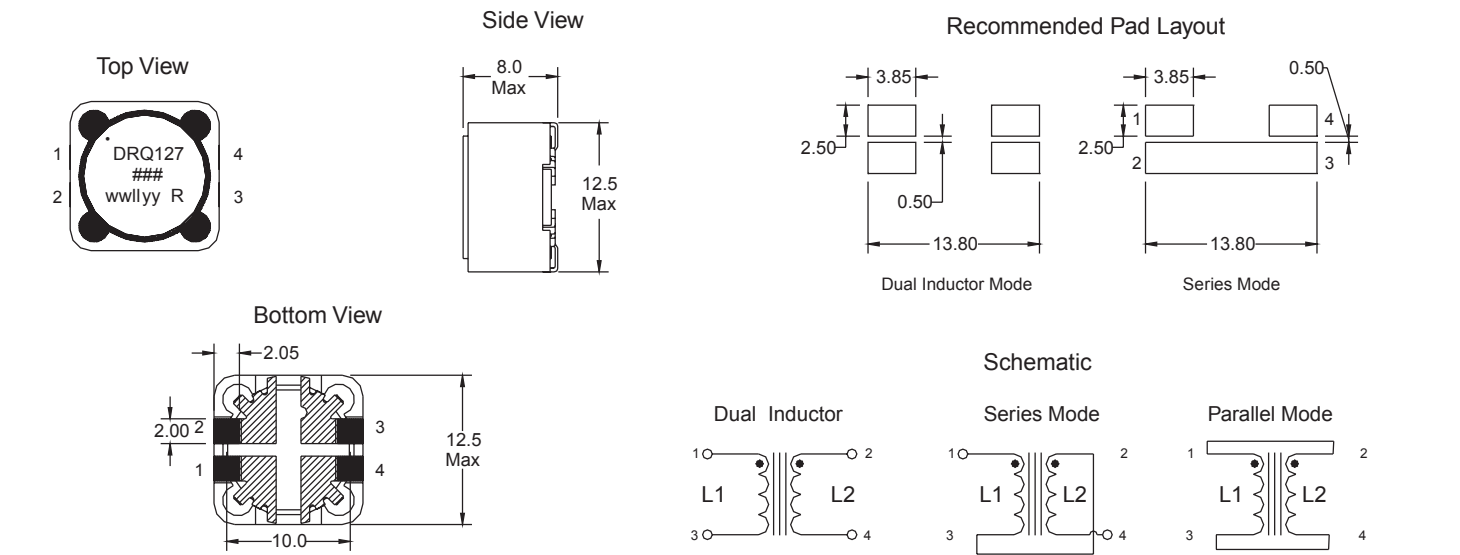

= Inductance value per family chart
wwllyy = (date code)
R = revision level
Dot indicates pin #1
Do not route traces or vias underneath the inductor

Dual winding, high power density, shielded drum core power inductors

Packaging information- mm

DRQ73

Supplied in tape and reel packaging,
1350 parts per reel, 13" diameter reel.

Ao=7.90mm
Bo=7.90mm
Ko=3.80mm

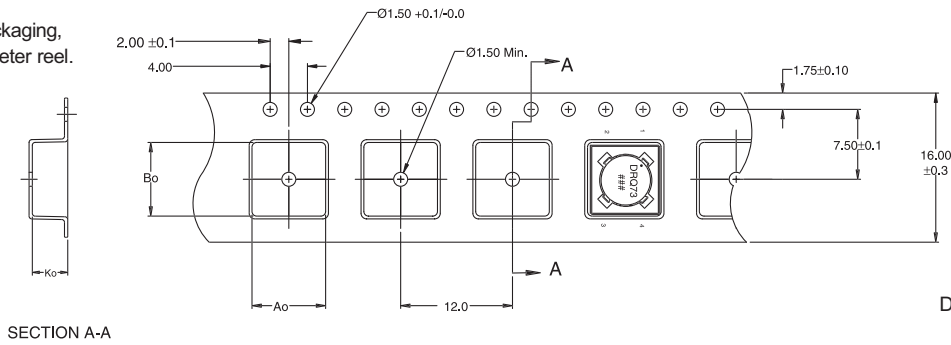

Direction of Feed →

DRQ74

Supplied in tape and reel packaging,
1100 parts per reel, 13" diameter reel.

Ao=7.90mm
Bo=7.90mm
Ko=4.70mm

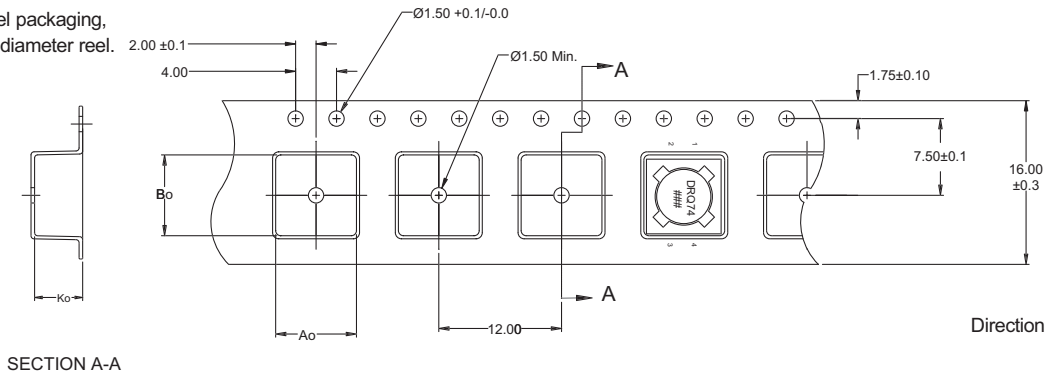

Direction of Feed →

DRQ125

Supplied in tape and reel packaging,
600 parts per reel, 13" diameter reel.

Ao=13.00mm
Bo=13.00mm
Ko=6.30mm

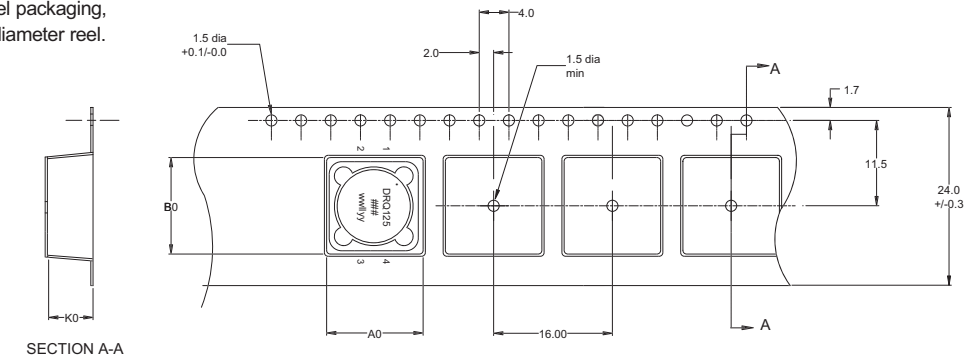

Direction of Feed →

DRQ127

Supplied in tape and reel packaging,
350 parts per reel, 13" diameter reel.

Ao=13.00mm
Bo=13.00mm
Ko=8.30mm

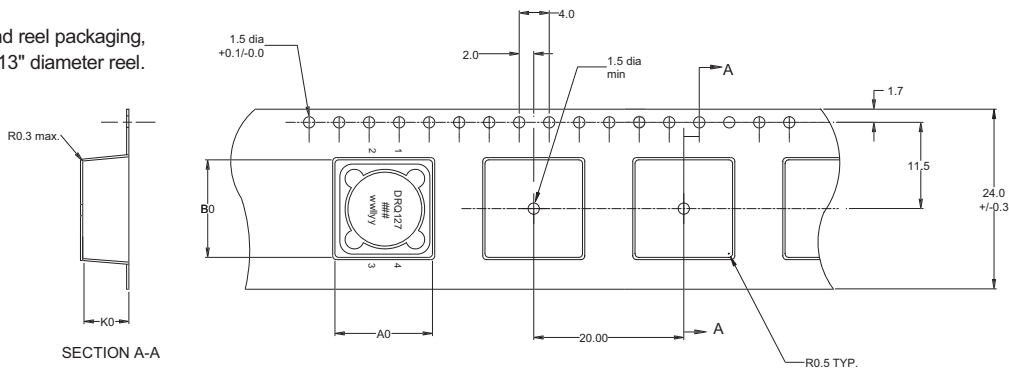

Direction of Feed →

Dimensions are in millimeters.

Core loss

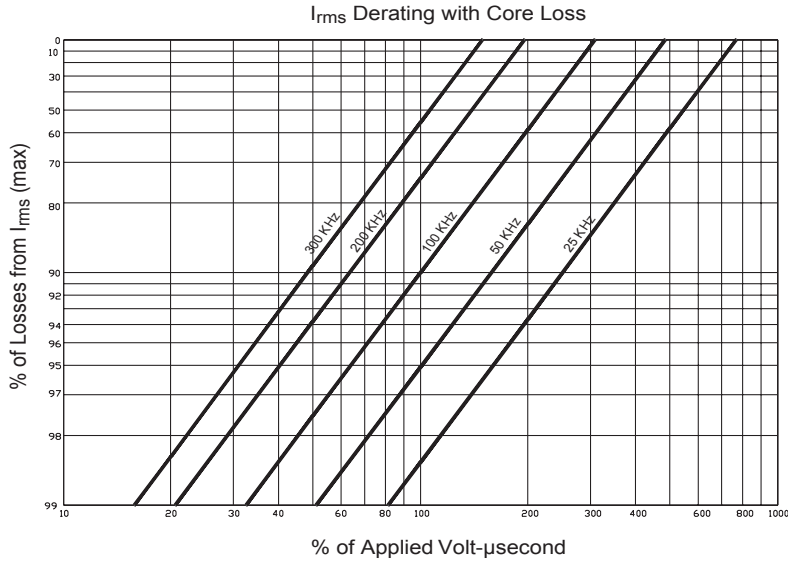

Inductance characteristics

DRQ73

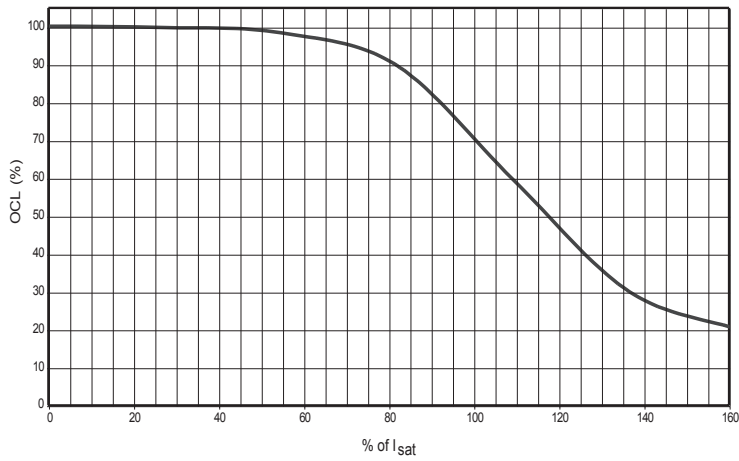

DRQ74

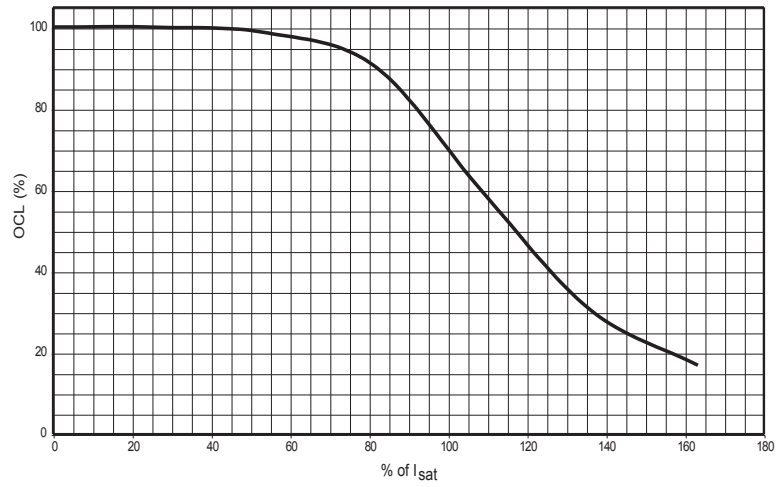

DRQ125

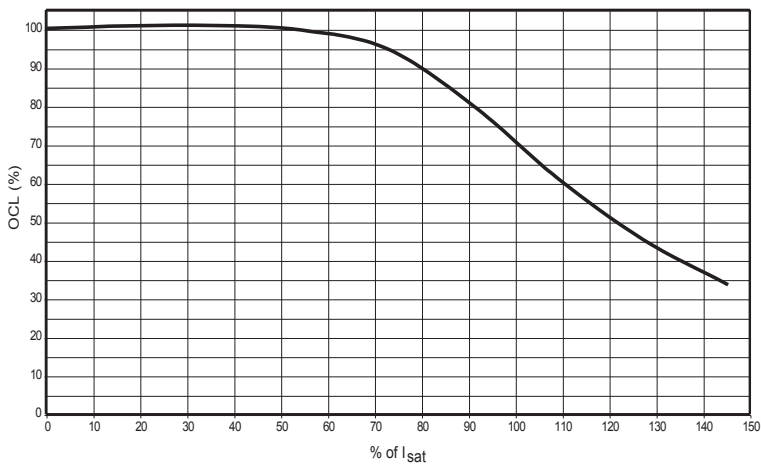

DRQ127

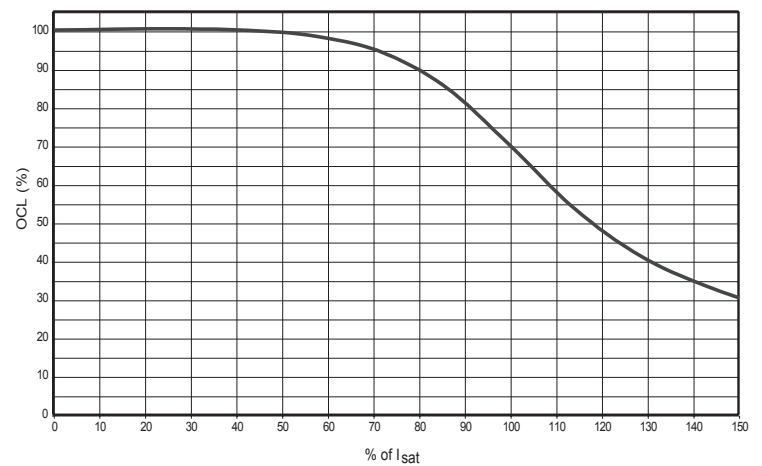

Solder Reflow Profile

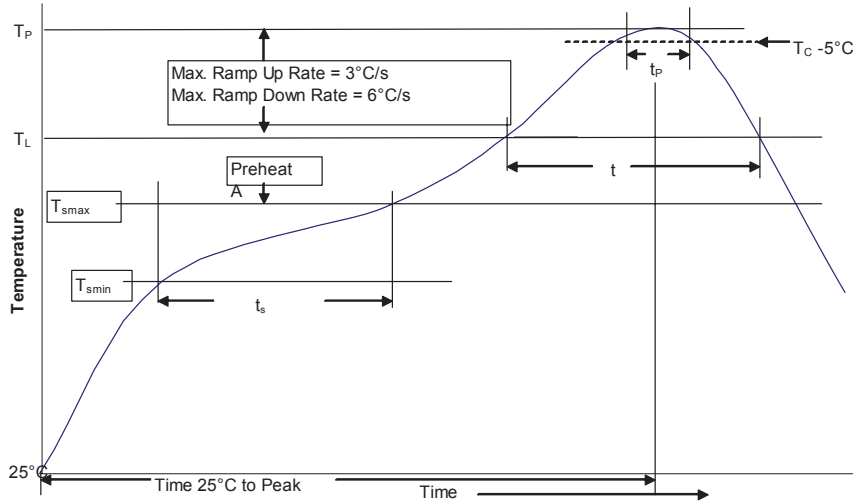

Table 1 - Standard SnPb Solder (T_c)

Package Thickness	Volume ≤ 350 mm ³	Volume ≥ 350 mm ³
<2.5mm	235°C	220°C
≥ 2.5 mm	220°C	220°C

Table 2 - Lead (Pb) Free Solder (T_c)

Package Thickness	Volume ≤ 350 mm ³	Volume 350 - 2000 mm ³	Volume > 2000 mm ³
<1.6mm	260°C	260°C	260°C
1.6 - 2.5mm	260°C	250°C	245°C
>2.5mm	250°C	245°C	245°C

Reference JDEC J-STD-020

Profile Feature	Standard SnPb Solder	Lead (Pb) Free Solder
Preheat and Soak		
• Temperature min. (T_{smin})	100°C	150°C
• Temperature max. (T_{smax})	150°C	200°C
• Time (T_{smin} to T_{smax}) (t_s)	60-120 Seconds	60-120 Seconds
Average ramp up rate T_{smax} to T_p	3°C/ Second Max.	3°C/ Second Max.
Liquidous temperature (T_L)	183°C	217°C
Time at liquidous (t_L)	60-150 Seconds	60-150 Seconds
Peak package body temperature (T_p)*	Table 1	Table 2
Time (t_p)** within 5 °C of the specified classification temperature (T_c)	20 Seconds**	30 Seconds**
Average ramp-down rate (T_p to T_{smax})	6°C/ Second Max.	6°C/ Second Max.
Time 25°C to Peak Temperature	6 Minutes Max.	8 Minutes Max.

* Tolerance for peak profile temperature (T_p) is defined as a supplier minimum and a user maximum.

** Tolerance for time at peak profile temperature (t_p) is defined as a supplier minimum and a user maximum.

Life Support Policy: Eaton does not authorize the use of any of its products for use in life support devices or systems without the express written approval of an officer of the Company. Life support systems are devices which support or sustain life, and whose failure to perform, when properly used in accordance with instructions for use provided in the labeling, can be reasonably expected to result in significant injury to the user.

Eaton reserves the right, without notice, to change design or construction of any products and to discontinue or limit distribution of any products. Eaton also reserves the right to change or update, without notice, any technical information contained in this bulletin.

Eaton
Electronics Division
1000 Eaton Boulevard
Cleveland, OH 44122
United States
www.eaton.com/electronics

© 2017 Eaton
All Rights Reserved Printed in USA
Publication No. DS4311 BU-SB14113
September 2017

Eaton is a registered trademark.

All other trademarks are property of their respective owners.



Компания «ЭлектроПласт» предлагает заключение долгосрочных отношений при поставках импортных электронных компонентов на взаимовыгодных условиях!

Наши преимущества:

- Оперативные поставки широкого спектра электронных компонентов отечественного и импортного производства напрямую от производителей и с крупнейших мировых складов;
- Поставка более 17-ти миллионов наименований электронных компонентов;
- Поставка сложных, дефицитных, либо снятых с производства позиций;
- Оперативные сроки поставки под заказ (от 5 рабочих дней);
- Экспресс доставка в любую точку России;
- Техническая поддержка проекта, помощь в подборе аналогов, поставка прототипов;
- Система менеджмента качества сертифицирована по Международному стандарту ISO 9001;
- Лицензия ФСБ на осуществление работ с использованием сведений, составляющих государственную тайну;
- Поставка специализированных компонентов (Xilinx, Altera, Analog Devices, Intersil, Interpoint, Microsemi, Aeroflex, Peregrine, Syfer, Eurofarad, Texas Instrument, Miteq, Cobham, E2V, MA-COM, Hittite, Mini-Circuits, General Dynamics и др.);

Помимо этого, одним из направлений компании «ЭлектроПласт» является направление «Источники питания». Мы предлагаем Вам помощь Конструкторского отдела:

- Подбор оптимального решения, техническое обоснование при выборе компонента;
- Подбор аналогов;
- Консультации по применению компонента;
- Поставка образцов и прототипов;
- Техническая поддержка проекта;
- Защита от снятия компонента с производства.



Как с нами связаться

Телефон: 8 (812) 309 58 32 (многоканальный)

Факс: 8 (812) 320-02-42

Электронная почта: org@eplast1.ru

Адрес: 198099, г. Санкт-Петербург, ул. Калинина, дом 2, корпус 4, литера А.