

Features

- ◆ Compact design in SMD or DIP package
- ◆ Ultra wide 4:1 input voltage range
- ◆ Fully regulated outputs
- ◆ Low ripple and noise 30mV pk-pk
- ◆ No minimum load required
- ◆ Temperature range -40°C to $+85^{\circ}\text{C}$ without derating
- ◆ I/O isolation 1500 VDC
- ◆ Continuous short-circuit protection
- ◆ Remote On/Off control
- ◆ Fully RoHS compliant
- ◆ 3-year product warranty

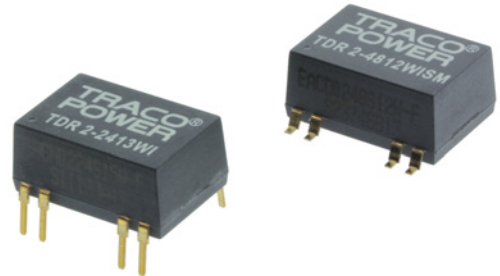

The TDR-2WI series is a family of compact 2 W dc/dc-converters with 4:1 input voltage ranges and tightly regulated output voltages even under no load conditions. The product is available in SMD-package or in DIP-package. They work with high efficiency over the full load range and come with a remote On/Off input. The usability in temperature ranges of up to 85°C without power derating, continuous short circuit protection and excellent immunity against environmental influences make these converters very reliable.

A TDR-2WI converter is the ideal solution for space critical high end applications in communication equipment, instrumentation and industrial electronics.

Models

Order code DIP models	Order code SMD models	Input voltage range	Output voltage	Output current max.	Efficiency typ.
TDR 2-1211WI	TDR 2-1211WISM	4.5 – 18 VDC (12 VDC nominal)	5.0 VDC	400 mA	79 %
TDR 2-1212WI	TDR 2-1212WISM		12 VDC	167 mA	80 %
TDR 2-1213WI	TDR 2-1213WISM		15 VDC	134 mA	81 %
TDR 2-1222WI	TDR 2-1222WISM		± 12 VDC	± 83 mA	81 %
TDR 2-1223WI	TDR 2-1223WISM		± 15 VDC	± 67 mA	81 %
TDR 2-2411WI	TDR 2-2411WISM	9 – 36 VDC (24 VDC nominal)	5.0 VDC	400 mA	79 %
TDR 2-2412WI	TDR 2-2412WISM		12 VDC	167 mA	80 %
TDR 2-2413WI	TDR 2-2413WISM		15 VDC	134 mA	82 %
TDR 2-2422WI	TDR 2-2422WISM		± 12 VDC	± 83 mA	80 %
TDR 2-2423WI	TDR 2-2423WISM		± 15 VDC	± 67 mA	81 %
TDR 2-4811WI	TDR 2-4811WISM	18 – 75 VDC (48 VDC nominal)	5.0 VDC	400 mA	78 %
TDR 2-4812WI	TDR 2-4812WISM		12 VDC	167 mA	81 %
TDR 2-4813WI	TDR 2-4813WISM		15 VDC	134 mA	82 %
TDR 2-4822WI	TDR 2-4822WISM		± 12 VDC	± 83 mA	81 %
TDR 2-4823WI	TDR 2-4823WISM		± 15 VDC	± 67 mA	81 %

Input Specifications

Input current at no load (nominal input voltage)	12 Vin models: 35 mA typ. 24 Vin models: 20 mA typ. 48 Vin models: 10 mA typ.
Input current at full load (nominal input voltage)	12 Vin models: 215 mA typ. 24 Vin models: 110 mA typ. 48 Vin models: 55 mA typ.
Surge voltage (1 sec. max.)	12 Vin models: 25 V max. 24 Vin models: 50 V max. 48 Vin models: 100 V max.
Input filter	capacitor type (see EMC considerations page 3 for compliance to EN 55022 class A/B)
ESD (electrostatic discharge)	EN 61000-4-2, air ± 8 kV, contact ± 6 kV, perf. criteria A
Radiated immunity	EN 61000-4-3 10 V/m, perf. criteriy A
Fast transient / Surge	EN 61000-4-4, ± 2 kV, perf. criteria A EN 61000-4-5, ± 1 kV perf. criteria A with external input capacitor e.g. Nippon chemi-con KY 220 μ F, 100 V, ESR 48 mOhm
Conducted immunity	EN 61000-4-6, 10 Vrms, perf. criteria A
Reflected ripple current (measured with input filter according class A)	12 Vin models: 80 mA _{p-p} typ. 24 Vin models: 40 mA _{p-p} typ. 48 Vin models: 30 mA _{p-p} typ.

Output Specifications

Voltage set accuracy	± 1 % max
Regulation	<ul style="list-style-type: none"> - Input variation Vin min. to Vin max. 0.2 % max. - Load variation 0 – 100 % single output models: 1.0 % max. <li style="padding-left: 150px;">dual output models: 1.0 % max. balanced load - Load variation 10 – 90 % single output models: 0.5 % max. <li style="padding-left: 150px;">dual output models: 0.8 % max. balanced load - Load cross regulation 25/100 % 5.0 % max. (dual output models)
Minimum load	0 % of rated max. load
Temperature coefficient	± 0.02 %/K
Ripple and noise (20 MHz bandwidth)	30 mV pk-pk typ.
Start up time (constant resistive load)	<ul style="list-style-type: none"> - Power On 5 ms typ. - Remote On 5 ms typ.
Transient response setting time (25 % load step change)	250 μ s typ.
Short circuit protection	indefinite, automatic recovery
Capacitive load	<ul style="list-style-type: none"> 5 VDC models: 1680 μF max. 12 VDC models: 820 μF max. 15 VDC models: 680 μF max. ± 12 VDC models: ± 470 μF max. ± 15 VDC models: ± 330 μF max.

General Specifications

Temperature ranges	<ul style="list-style-type: none"> - Operating -40°C to +85°C (with no derating) - Storage -55°C to +125°C - Case temperature max. +100°C
Humidity (non condensing)	5 % to 90 % rel. H max.

All specifications valid at nominal input voltage, full load and +25°C after warm-up time unless otherwise stated.

General Specifications

Thermal shock, mechanical shock & vibration – Test conditions	EN 61373, MIL-STD-810F www.tracopower.com/products/mil810.pdf
Reliability, calculated MTBF (MIL-HDBK-217F, at+25°C, ground benign)	>6.6 Mio h
Isolation voltage (60 sec.) – Input/Output	1500 VDC
Isolation capacitance – Input/Output	50 pF max.
Isolation resistance – Input/Output (500 VDC)	>10 GOhm
Altitude during operation	tba.
Safety standard (designed to meet)	IEC/EN 60950-1, UL 60950-1
Safety approvals – UL/cUL – engineering considerations/conditions of acceptability	www.ul.com -> certifications -> File e188913 on request: mailto:TRACO (enter series)
Switching frequency	100 kHz (PWM)
Remote On/Off – On: – Off: – Off stand by input current	open or high impedance 2...4 mA current applied via 1KOhm resistor 2.5 mA max.
Environmental compliance – Reach – RoHS	www.tracopower.com/products/tdr2wi-reach.pdf RoHS directive 2011/65/EU

EMC Consideration

Recommended filter for
EN 55022 class A compliance

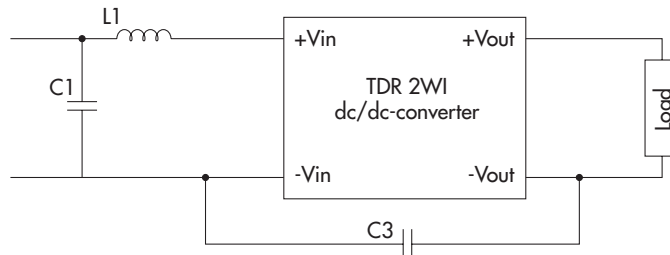

Input models	C1	C3	L1 value	order code (SMD type)	datasheet:
12 VDC	10 µF / 25 V 1812 MLCC	220pF / 3 kV 1808 MLCC	2.2 µH	TCK-059	www.tracopower.com/products/tck059.pdf
24 VDC	6.8 µF / 50 V 1812 MLCC		18 µH	TCK-046	www.tracopower.com/products/tck046.pdf
48 VDC	4.7 µF / 100 V 1812 MLCC				

Recommended filter for
EN 55022 class B compliance

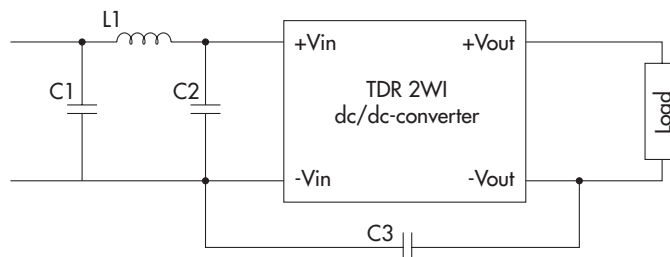

Input models	C1 & C2	C3	L1 value	order code (SMD type)	datasheet
12 VDC	10 µF / 25 V 1812 MLCC	220pF / 3 kV 1808 MLCC	2.2 µH	TCK-059	www.tracopower.com/products/tck059.pdf
24 VDC	2.2 µF / 50 V 1812 MLCC		18 µH	TCK-046	www.tracopower.com/products/tck046.pdf
48 VDC	2.2 µF / 100 V 1812 MLCC		27 µH	TCK-063	www.tracopower.com/products/tck063.pdf

All specifications valid at nominal input voltage, full load and +25°C after warm-up time unless otherwise stated.

Physical Specifications

Casing material		non-conductive plastic (UL94V-0 rated)
Package weight		4.5 g (0.16oz)
Soldering profile for DIP-package models		max. 265°C / 10 sec. (wave soldering)
Lead-free reflow solder process for SMD-package models		as per J-STD-020D.01 (to find at: www.jedec.org - free registration required)
Moisture sensivity level (for SMD-package models)		level 2a as per J-STD-033B.01 (to find at: www.jedec.org - free registration required)
Packaging	- Tube - Tape & Reel (only SMD models, add suffix -TR)	10 pcs packing unit 200 pcs packing unit

Outline Dimensions

DIP-Models

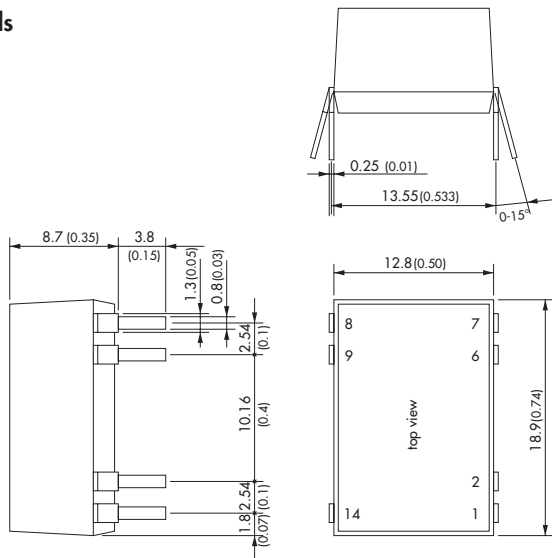

Pin-Out		
Pin	Single	Dual
1	-Vin (GND)	-Vin (GND)
2	Remote On/Off	Remote On/Off
6	NC	Common
7	NC	-Vout
8	+Vout	+Vout
9	-Vout	Common
14	+Vin (Vcc)	+Vin (Vcc)

NC = not to connect

SMD-Models

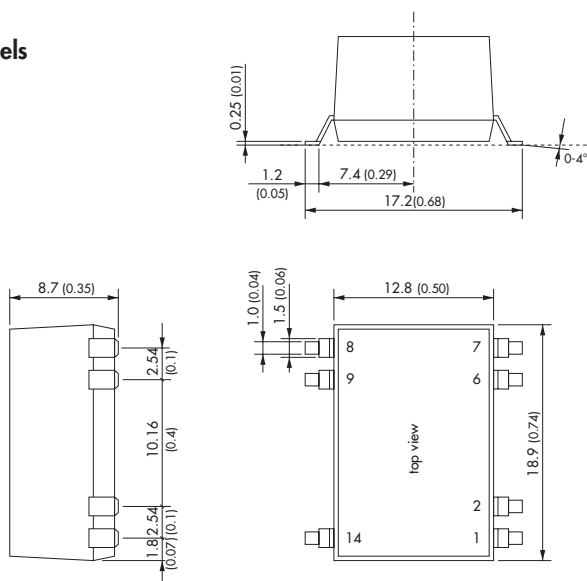

Recommended Solder Pad Dimension:

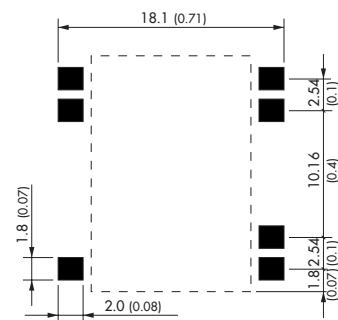

Dimensions in [mm], () = Inch
Tolerances: ±0.5 (±0.02)
Pin pitch tolerances: ±0.25 (±0.01)

Specifications can be changed without notice! Make sure you are using the latest documentation, downloadable at www.tracopower.com



Компания «ЭлектроПласт» предлагает заключение долгосрочных отношений при поставках импортных электронных компонентов на взаимовыгодных условиях!

Наши преимущества:

- Оперативные поставки широкого спектра электронных компонентов отечественного и импортного производства напрямую от производителей и с крупнейших мировых складов;
- Поставка более 17-ти миллионов наименований электронных компонентов;
- Поставка сложных, дефицитных, либо снятых с производства позиций;
- Оперативные сроки поставки под заказ (от 5 рабочих дней);
- Экспресс доставка в любую точку России;
- Техническая поддержка проекта, помощь в подборе аналогов, поставка прототипов;
- Система менеджмента качества сертифицирована по Международному стандарту ISO 9001;
- Лицензия ФСБ на осуществление работ с использованием сведений, составляющих государственную тайну;
- Поставка специализированных компонентов (Xilinx, Altera, Analog Devices, Intersil, Interpoint, Microsemi, Aeroflex, Peregrine, Syfer, Eurofarad, Texas Instrument, Miteq, Cobham, E2V, MA-COM, Hittite, Mini-Circuits, General Dynamics и др.);

Помимо этого, одним из направлений компании «ЭлектроПласт» является направление «Источники питания». Мы предлагаем Вам помощь Конструкторского отдела:

- Подбор оптимального решения, техническое обоснование при выборе компонента;
- Подбор аналогов;
- Консультации по применению компонента;
- Поставка образцов и прототипов;
- Техническая поддержка проекта;
- Защита от снятия компонента с производства.



Как с нами связаться

Телефон: 8 (812) 309 58 32 (многоканальный)

Факс: 8 (812) 320-02-42

Электронная почта: org@eplast1.ru

Адрес: 198099, г. Санкт-Петербург, ул. Калинина, дом 2, корпус 4, литера А.