

## 50 mA, 100 mA, 150 mA CMOS LDOs with Shutdown and Reference Bypass

### Features

- Low Supply Current: 80  $\mu$ A (Max)
- Low Dropout Voltage: 140 mV (Typ.) @ 150 mA
- High-Output Voltage Accuracy:  $\pm 0.4\%$  (Typ.)
- Standard or Custom Output Voltages
- Power-Saving Shutdown Mode
- Reference Bypass Input for Ultra Low-Noise Operation
- Fast Shutdown Response Time: 60  $\mu$ sec (Typ.)
- Overcurrent and Overtemperature Protection
- Space-Saving 5-Pin SOT-23A Package
- Pin-Compatible Upgrades for Bipolar Regulators
- Wide Operating Temperature Range: -40°C to +125°C
- Standard Output Voltage Options:
  - 1.8V, 2.5V, 2.6V, 2.7V, 2.8V, 2.85V, 3.0V, 3.3V, 5.0V

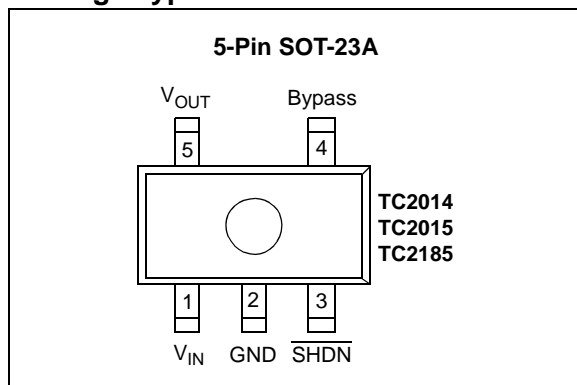
### Applications

- Battery-Operated Systems
- Portable Computers
- Medical Instruments
- Instrumentation
- Cellular/GSM/PHS Phones
- Linear Post-Regulator for SMPS
- Pagers

### Related Literature

- Application Notes: AN765, AN766, AN776 and AN792

### Package Type



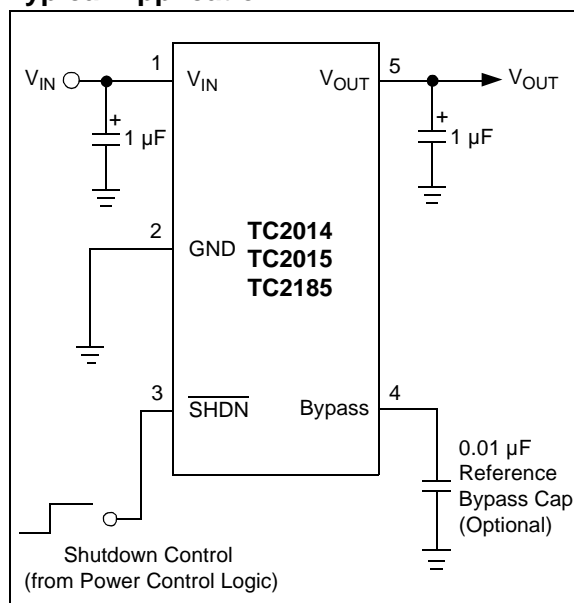
### General Description

The TC2014, TC2015 and TC2185 are high-accuracy (typically  $\pm 0.4\%$ ) CMOS upgrades for bipolar Low Drop-out Regulators (LDOs), such as the LP2980. Total supply current is typically 55  $\mu$ A; 20 to 60 times lower than in bipolar regulators.

The key features of the device include low noise operation (plus bypass reference), low dropout voltage – typically 45 mV for the TC2014, 90 mV for the TC2015, and 140 mV for the TC2185, at full load – and fast response to step changes in load. Supply current is reduced to 0.5  $\mu$ A (max) and  $V_{OUT}$  falls to zero when the shutdown input is low. These devices also incorporate overcurrent and overtemperature protection.

The TC2014, TC2015 and TC2185 are stable with an output capacitor of 1  $\mu$ F and have maximum output currents of 50 mA, 100 mA and 150 mA, respectively. For higher-output current versions, see the TC1107 (DS21356), TC1108 (DS21357) and TC1173 (DS21362) ( $I_{OUT} = 300$  mA) data sheets.

### Typical Application



# TC2014/2015/2185

## 1.0 ELECTRICAL CHARACTERISTICS

### Absolute Maximum Ratings †

Input Voltage .....	7.0V
Output Voltage .....	(- 0.3) to (V <sub>IN</sub> + 0.3)
Operating Temperature .....	- 40°C < T <sub>J</sub> < 125°C
Storage Temperature.....	- 65°C to +150°C
Maximum Voltage on Any Pin .....	V <sub>IN</sub> +0.3V to - 0.3V
Maximum Junction Temperature .....	150°C

† **Notice:** Stresses above those listed under "Absolute Maximum Ratings" may cause permanent damage to the device. These are stress ratings only and functional operation of the device at these or any other conditions above those indicated in the operation sections of the specifications is not implied. Exposure to Absolute Maximum Rating conditions for extended periods may affect device reliability.

### ELECTRICAL CHARACTERISTICS

<b>Electrical Specifications:</b> Unless otherwise specified, V <sub>IN</sub> = V <sub>R</sub> + 1V, I <sub>L</sub> = 100 μA, C <sub>OUT</sub> = 3.3 μF, $\overline{\text{SHDN}} > V_{IH}$ , T <sub>A</sub> = +25°C. <b>BOLDFACE</b> type specifications apply for junction temperature of -40°C to +125°C.						
Parameters	Sym	Min	Typ	Max	Units	Conditions
Input Operating Voltage	V <sub>IN</sub>	<b>2.7</b>	—	<b>6.0</b>	V	<b>Note 1</b>
Maximum Output Current	I <sub>OUTMAX</sub>	<b>50</b>	—	—	mA	<b>TC2014</b>
		<b>100</b>	—	—		<b>TC2015</b>
		<b>150</b>	—	—		<b>TC2185</b>
Output Voltage	V <sub>OUT</sub>	<b>V<sub>R</sub> - 2.0%</b>	V <sub>R</sub> ± 0.4%	<b>V<sub>R</sub> + 2.0%</b>	V	<b>Note 2</b>
V <sub>OUT</sub> Temperature Coefficient	TCV <sub>OUT</sub>	—	20	—	ppm/°C	<b>Note 3</b>
		—	<b>40</b>	—		
Line Regulation	ΔV <sub>OUT</sub> /ΔV <sub>IN</sub>	—	0.05	<b>0.5</b>	%	(V <sub>R</sub> + 1V) ≤ V <sub>IN</sub> ≤ 6V
Load Regulation ( <b>Note 4</b> )	ΔV <sub>OUT</sub> /V <sub>OUT</sub>	<b>-1.0</b>	0.33	<b>+1.0</b>	%	<b>TC2014; TC2015:</b> I <sub>L</sub> = 0.1 mA to I <sub>OUTMAX</sub>
		<b>-2.0</b>	0.43	<b>+2.0</b>		<b>TC2185:</b> I <sub>L</sub> = 0.1 mA to I <sub>OUTMAX</sub> ( <b>Note 4</b> )
Dropout Voltage	V <sub>IN</sub> - V <sub>OUT</sub>	—	2	—	mV	<b>Note 5</b> I <sub>L</sub> = 100 μA
		—	45	<b>70</b>		I <sub>L</sub> = 50 mA
		—	90	<b>140</b>		<b>TC2015; TC2185</b> I <sub>L</sub> = 100 mA
		—	140	<b>210</b>		<b>TC2185</b> I <sub>L</sub> = 150 mA
Supply Current	I <sub>IN</sub>	—	55	<b>80</b>	μA	$\overline{\text{SHDN}} = V_{IH}$ , I <sub>L</sub> = 0
Shutdown Supply Current	I <sub>INSD</sub>	—	0.05	0.5	μA	$\overline{\text{SHDN}} = 0V$
Power Supply Rejection Ratio	PSRR	—	55	—	dB	F ≤ 1 kHz, C <sub>bypass</sub> = 0.01 μF
Output Short Circuit Current	I <sub>OUTSC</sub>	—	160	300	mA	V <sub>OUT</sub> = 0V

- Note 1:** The minimum V<sub>IN</sub> has to meet two conditions: V<sub>IN</sub> = 2.7V and V<sub>IN</sub> = V<sub>R</sub> + V<sub>DROPOUT</sub>.  
**2:** V<sub>R</sub> is the regulator output voltage setting. For example: V<sub>R</sub> = 1.8V, 2.7V, 2.8V, 2.85V, 3.0V, 3.3V.  
**3:**

$$TCV_{OUT} = \frac{(V_{OUTMAX} - V_{OUTMIN}) \times 10^{-6}}{V_{OUT} \times \Delta T}$$

- 4:** Regulation is measured at a constant junction temperature using low duty cycle pulse testing. Load regulation is tested over a load range from 1.0 mA to the maximum specified output current. Changes in output voltage due to heating effects are covered by the Thermal Regulation specification.  
**5:** Dropout Voltage is defined as the input-to-output differential at which the output voltage drops 2% below its nominal value.  
**6:** Thermal Regulation is defined as the change in output voltage at a time T after a change in power dissipation is applied, excluding load or line regulation effects. Specifications are for a current pulse equal to I<sub>MAX</sub> at V<sub>IN</sub> = 6V for T = 10 ms.  
**7:** The maximum allowable power dissipation is a function of ambient temperature, the maximum allowable junction temperature and the thermal resistance from junction-to-air (i.e. T<sub>A</sub>, T<sub>J</sub>, θ<sub>JA</sub>).  
**8:** Time required for V<sub>OUT</sub> to reach 95% of V<sub>R</sub> (output voltage setting), after V<sub>SHDN</sub> is switched from 0 to V<sub>IN</sub>.

## ELECTRICAL CHARACTERISTICS (CONTINUED)

<b>Electrical Specifications:</b> Unless otherwise specified, $V_{IN} = V_R + 1V$ , $I_L = 100 \mu A$ , $C_{OUT} = 3.3 \mu F$ , $\overline{SHDN} > V_{IH}$ , $T_A = +25^\circ C$ . <b>BOLDFACE</b> type specifications apply for junction temperature of $-40^\circ C$ to $+125^\circ C$ .						
Parameters	Sym	Min	Typ	Max	Units	Conditions
Thermal Regulation	$\Delta V_{OUT}/\Delta P_D$	—	0.04	—	V/W	<b>Note 6, Note 7</b>
Thermal Shutdown Die Temperature	$T_{SD}$	—	160	—	$^\circ C$	
Output Noise	eN	—	200	—	nV/ $\sqrt{Hz}$	$I_L = I_{OUTMAX}$ , $F = 10 \text{ kHz}$ 470 pF from Bypass to GND
Response Time (from Shutdown Mode) <b>(Note 8)</b>	$T_R$	—	60	—	$\mu s$	$V_{IN} = 4V$ , $I_L = 30 \text{ mA}$ , $C_{IN} = 1 \mu F$ , $C_{OUT} = 10 \mu F$
<b>SHDN Input</b>						
SHDN Input High Threshold	$V_{IH}$	<b>60</b>	—	—	% $V_{IN}$	$V_{IN} = 2.5V$ to $6.0V$
SHDN Input Low Threshold	$V_{IL}$	—	—	<b>15</b>	% $V_{IN}$	$V_{IN} = 2.5V$ to $6.0V$

- Note** 1: The minimum  $V_{IN}$  has to meet two conditions:  $V_{IN} = 2.7V$  and  $V_{IN} = V_R + V_{DROPOUT}$   
 2:  $V_R$  is the regulator output voltage setting. For example:  $V_R = 1.8V, 2.7V, 2.8V, 2.85V, 3.0V, 3.3V$ .  
 3:

$$TCV_{OUT} = \frac{(V_{OUTMAX} - V_{OUTMIN}) \times 10^{-6}}{V_{OUT} \times \Delta T}$$

- 4: Regulation is measured at a constant junction temperature using low duty cycle pulse testing. Load regulation is tested over a load range from 1.0 mA to the maximum specified output current. Changes in output voltage due to heating effects are covered by the Thermal Regulation specification.  
 5: Dropout Voltage is defined as the input-to-output differential at which the output voltage drops 2% below its nominal value.  
 6: Thermal Regulation is defined as the change in output voltage at a time T after a change in power dissipation is applied, excluding load or line regulation effects. Specifications are for a current pulse equal to  $I_{MAX}$  at  $V_{IN} = 6V$  for  $T = 10 \text{ ms}$ .  
 7: The maximum allowable power dissipation is a function of ambient temperature, the maximum allowable junction temperature and the thermal resistance from junction-to-air (i.e.  $T_A$ ,  $T_J$ ,  $\theta_{JA}$ ).  
 8: Time required for  $V_{OUT}$  to reach 95% of  $V_R$  (output voltage setting), after  $V_{SHDN}$  is switched from 0 to  $V_{IN}$ .

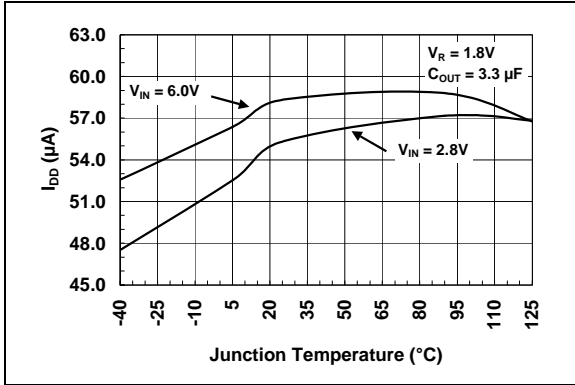
## TEMPERATURE CHARACTERISTICS

<b>Electrical Specifications:</b> Unless otherwise noted, $V_{DD} = +2.7V$ to $+6.0V$ and $V_{SS} = GND$ .						
Parameters	Sym	Min	Typ	Max	Units	Conditions
<b>Temperature Ranges:</b>						
Extended Temperature Range	$T_A$	-40	—	+125	$^\circ C$	
Operating Temperature Range	$T_A$	-40	—	+125	$^\circ C$	
Storage Temperature Range	$T_A$	-65	—	+150	$^\circ C$	
<b>Thermal Package Resistances:</b>						
Thermal Resistance, 5L-SOT-23	$\theta_{JA}$	—	255	—	$^\circ C/W$	

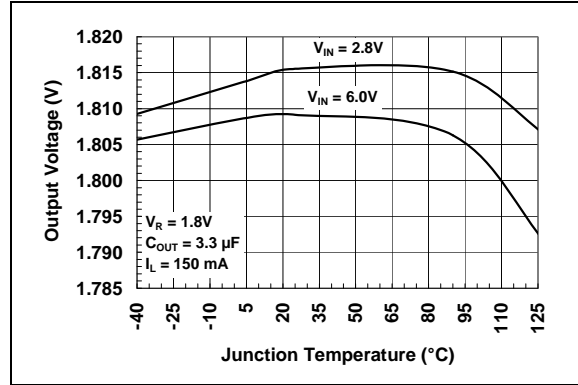
## 2.0 TYPICAL PERFORMANCE CURVES

**Note:** The graphs and tables provided following this note are a statistical summary based on a limited number of samples and are provided for informational purposes only. The performance characteristics listed herein are not tested or guaranteed. In some graphs or tables, the data presented may be outside the specified operating range (e.g., outside specified power supply range) and therefore outside the warranted range.

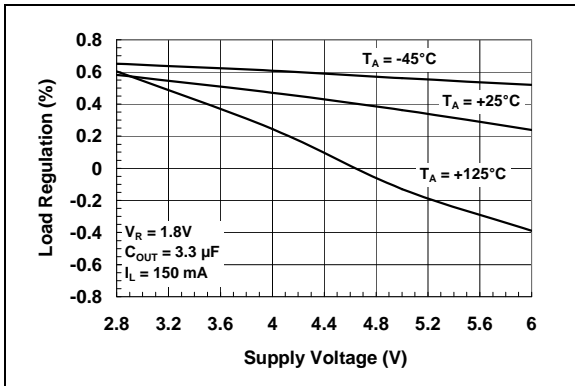
**Note:** Unless otherwise indicated,  $V_{IN} = V_R + 1V$ ,  $I_L = 100 \mu A$ ,  $C_{OUT} = 3.3 \mu F$ ,  $SHDN > V_{IH}$ ,  $T_A = +25^\circ C$ .



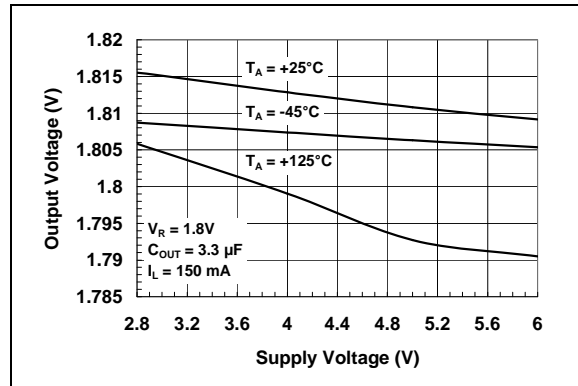
**FIGURE 2-1:** Supply Current vs. Junction Temperature.



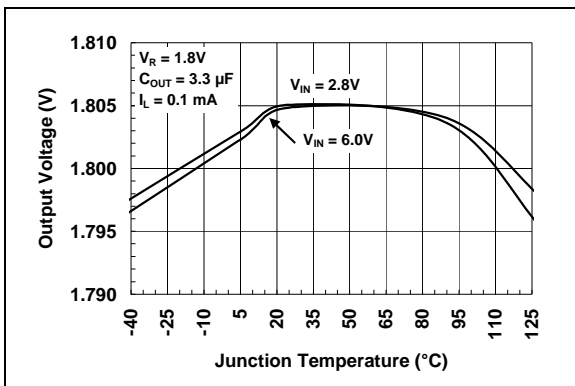
**FIGURE 2-4:** Output Voltage vs. Junction Temperature.



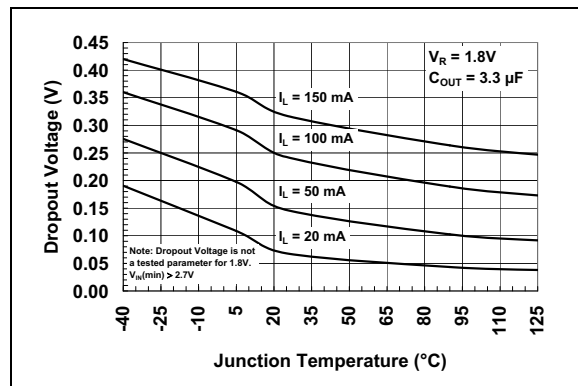
**FIGURE 2-2:** Load Regulation vs. Supply Voltage.



**FIGURE 2-5:** Output Voltage vs. Supply Voltage.

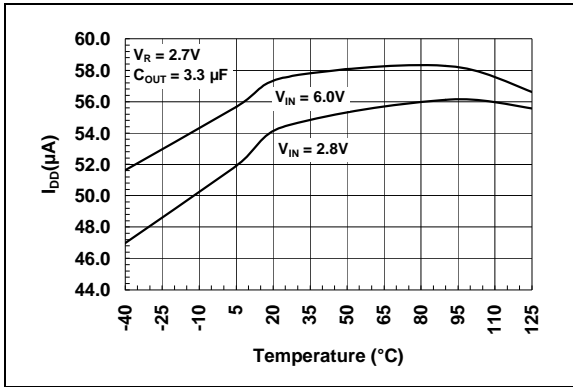


**FIGURE 2-3:** Output Voltage vs. Junction Temperature.

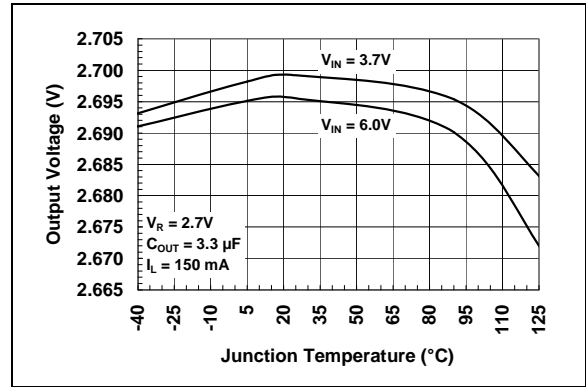


**FIGURE 2-6:** Dropout Voltage vs. Junction Temperature.

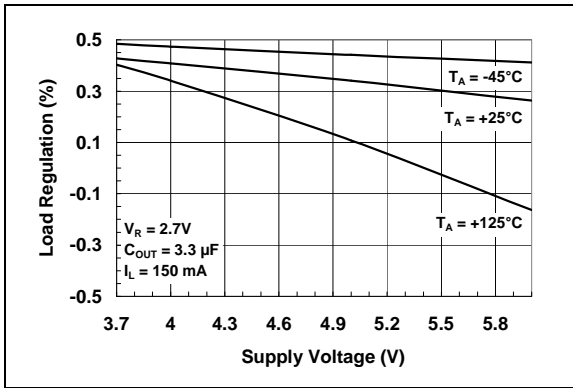
**Note:** Unless otherwise indicated,  $V_{IN} = V_R + 1V$ ,  $I_L = 100 \mu A$ ,  $C_{OUT} = 3.3 \mu F$ ,  $\overline{SHDN} > V_{IH}$ ,  $T_A = +25^\circ C$ .



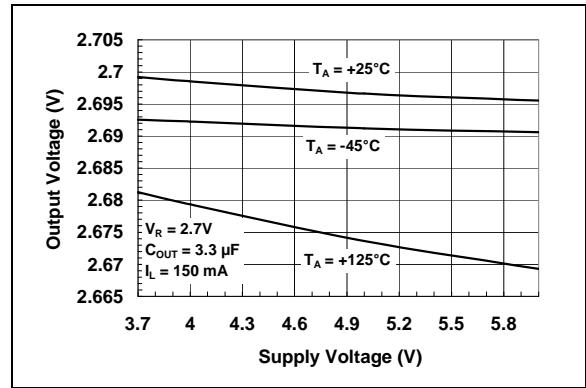
**FIGURE 2-7:** Supply Current vs. Junction Temperature.



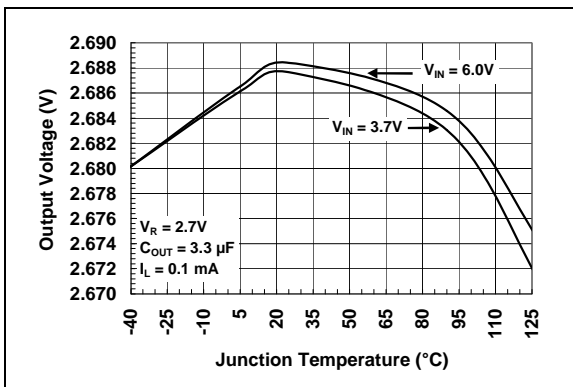
**FIGURE 2-10:** Output Voltage vs. Junction Temperature.



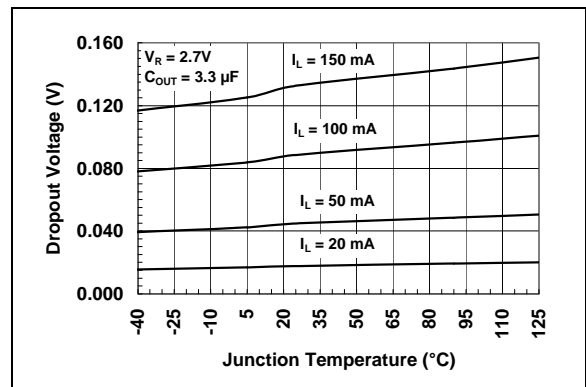
**FIGURE 2-8:** Load Regulation vs. Supply Voltage.



**FIGURE 2-11:** Output Voltage vs. Supply Voltage.



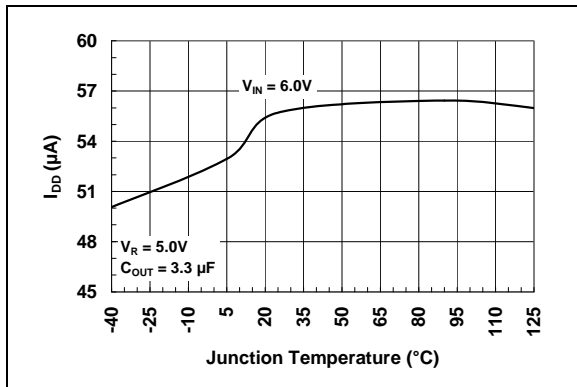
**FIGURE 2-9:** Output Voltage vs. Junction Temperature.



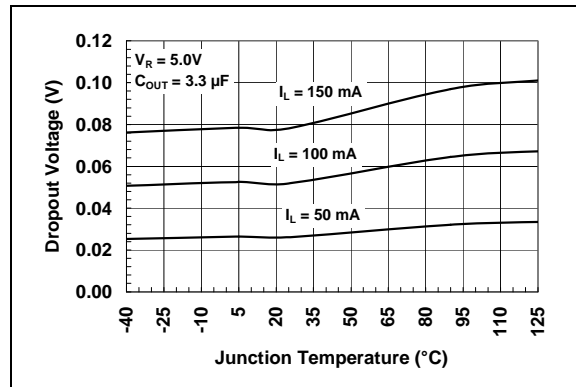
**FIGURE 2-12:** Dropout Voltage vs. Junction Temperature.

# TC2014/2015/2185

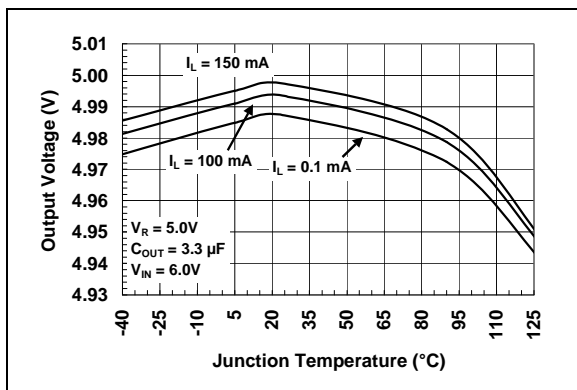
**Note:** Unless otherwise indicated,  $V_{IN} = V_R + 1V$ ,  $I_L = 100 \mu A$ ,  $C_{OUT} = 3.3 \mu F$ ,  $\overline{SHDN} > V_{IH}$ ,  $T_A = +25^\circ C$ .



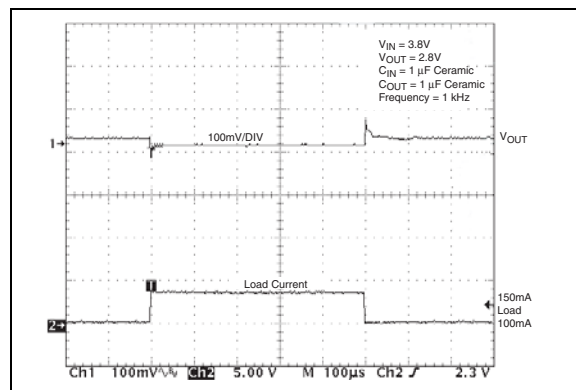
**FIGURE 2-13:** Supply Current vs. Junction Temperature.



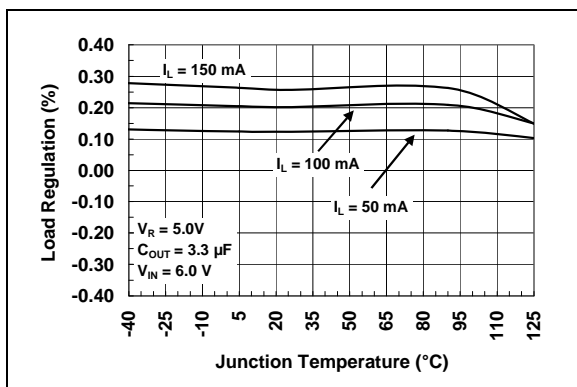
**FIGURE 2-16:** Dropout Voltage vs. Junction Temperature.



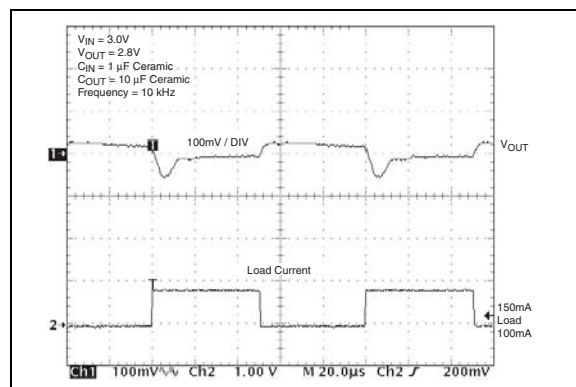
**FIGURE 2-14:** Output Voltage vs. Junction Temperature.



**FIGURE 2-17:** Load Transient Response. ( $C_{OUT} = 1 \mu F$ ).

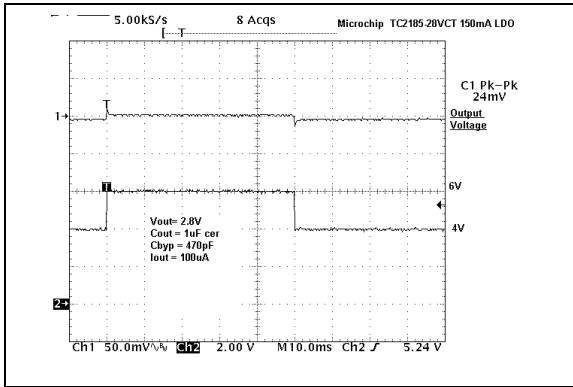


**FIGURE 2-15:** Load Regulation vs. Junction Temperature.

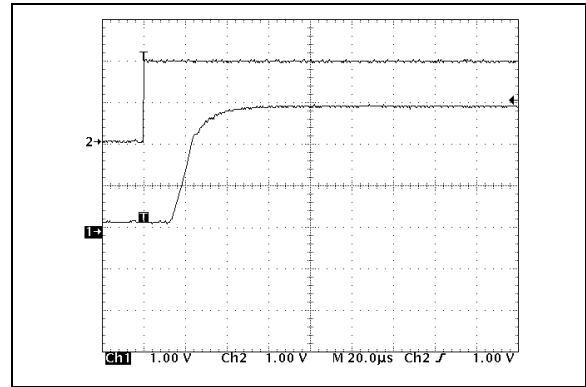


**FIGURE 2-18:** Load Transient Response. ( $C_{OUT} = 10 \mu F$ ).

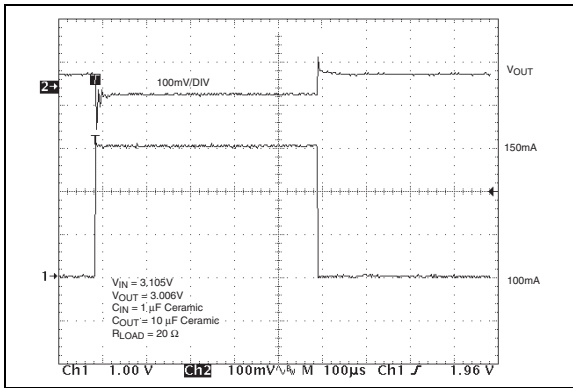
**Note:** Unless otherwise indicated,  $V_{IN} = V_R + 1V$ ,  $I_L = 100 \mu A$ ,  $C_{OUT} = 3.3 \mu F$ ,  $\overline{SHDN} > V_{IH}$ ,  $T_A = +25^\circ C$ .



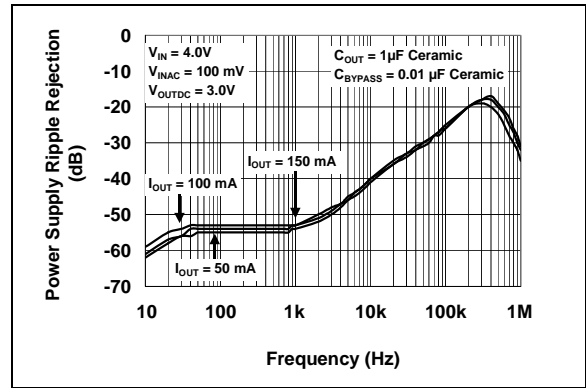
**FIGURE 2-19:** Line Transient Response. ( $C_{OUT} = 1 \mu F$ ).



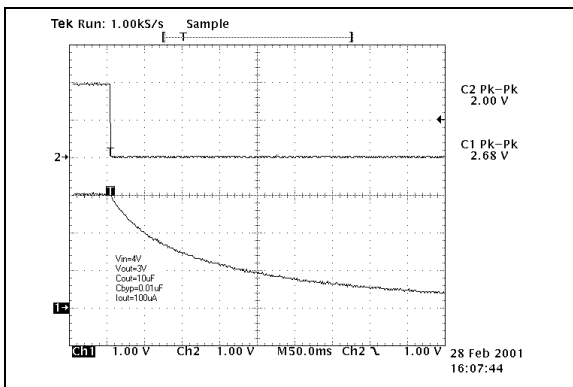
**FIGURE 2-22:** Wake-Up Response.



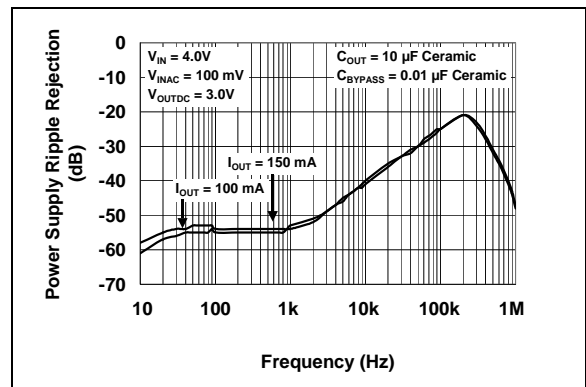
**FIGURE 2-20:** Load Transient Response in Dropout. ( $C_{OUT} = 10 \mu F$ ).



**FIGURE 2-23:** PSRR vs. Frequency ( $C_{OUT} = 1 \mu F$  Ceramic).



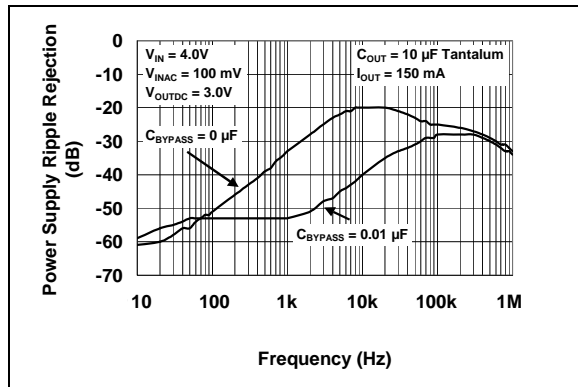
**FIGURE 2-21:** Shutdown Delay Time.



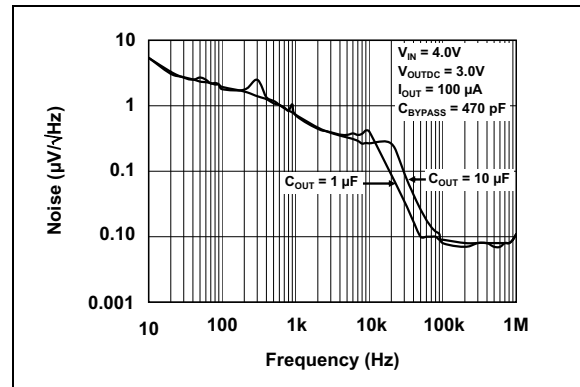
**FIGURE 2-24:** PSRR vs. Frequency ( $C_{OUT} = 10 \mu F$  Ceramic).

# TC2014/2015/2185

Note: Unless otherwise indicated,  $V_{IN} = V_R + 1V$ ,  $I_L = 100 \mu A$ ,  $C_{OUT} = 3.3 \mu F$ ,  $\overline{SHDN} > V_{IH}$ ,  $T_A = +25^\circ C$ .



**FIGURE 2-25:** PSRR vs. Frequency ( $C_{OUT} = 10 \mu F$  Tantalum).



**FIGURE 2-26:** Output Noise vs. Frequency.



## 3.0 PIN DESCRIPTIONS

The descriptions of the pins are described in Table 3-1.

**TABLE 3-1: PIN FUNCTION TABLE**

Pin No.	Symbol	Description
1	$V_{IN}$	Unregulated supply input
2	GND	Ground terminal
3	$\overline{\text{SHDN}}$	Shutdown control input
4	Bypass	Reference bypass input
5	$V_{OUT}$	Regulated voltage output

### 3.1 Unregulated Supply Input ( $V_{IN}$ )

Connect the unregulated input supply to the  $V_{IN}$  pin. If there is a large distance between the input supply and the LDO regulator, some input capacitance is necessary for proper operation. A 1  $\mu\text{F}$  capacitor, connected from  $V_{IN}$  to ground, is recommended for most applications.

### 3.2 Ground Terminal (GND)

Connect the unregulated input supply ground return to GND. Also connect one side of the 1  $\mu\text{F}$  typical input decoupling capacitor close to this pin and one side of the output capacitor  $C_{OUT}$  to this pin.

### 3.3 Shutdown Control Input ( $\overline{\text{SHDN}}$ )

The regulator is fully enabled when a logic-high is applied to  $\overline{\text{SHDN}}$ . The regulator enters shutdown when a logic-low is applied to this input. During shutdown, the output voltage falls to zero and the supply current is reduced to 0.5  $\mu\text{A}$  (max).

### 3.4 Reference Bypass Input (Bypass)

Connecting a low-value ceramic capacitor to Bypass will further reduce output voltage noise and improve the Power Supply Ripple Rejection (PSRR) performance of the LDO. Typical values from 470 pF to 0.01  $\mu\text{F}$  are suggested. While smaller and larger values can be used, these affect the speed at which the LDO output voltage rises when input power is applied. The larger the bypass capacitor, the slower the output voltage will rise.

### 3.5 Regulated Voltage Output ( $V_{OUT}$ )

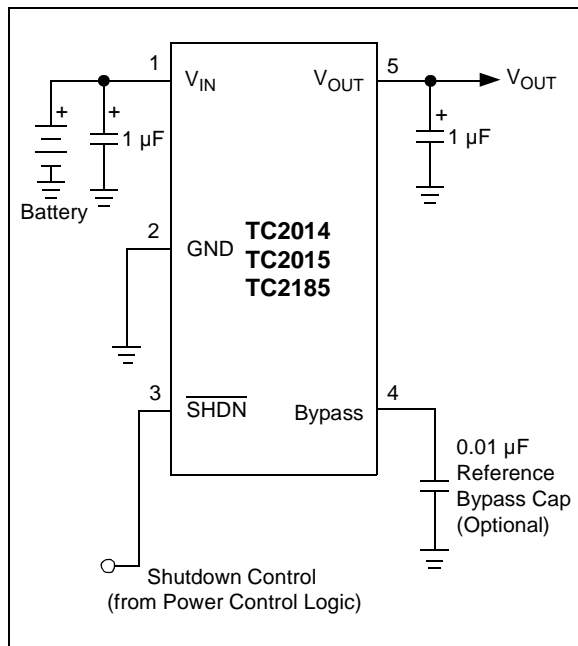
Connect the output load to  $V_{OUT}$  of the LDO. Also connect one side of the LDO output de-coupling capacitor as close as possible to the  $V_{OUT}$  pin.

# TC2014/2015/2185

## 4.0 DETAILED DESCRIPTION

The TC2014, TC2015 and TC2185 are precision fixed-output voltage regulators (if an adjustable version is needed, see the TC1070, TC1071 and TC1187 (DS21353) data sheet). Unlike bipolar regulators, the TC2014, TC2015 and TC2185 supply current does not increase with load current. In addition, the LDO's output voltage is stable using 1  $\mu\text{F}$  of ceramic or tantalum capacitance over the entire specified input voltage range and output current range.

Figure 4-1 shows a typical application circuit. The regulator is enabled anytime the shutdown input (SHDN) is at or above  $V_{IH}$ , and disabled (shutdown) when SHDN is at or below  $V_{IL}$ . SHDN may be controlled by a CMOS logic gate or I/O port of a microcontroller. If the SHDN input is not required, it should be connected directly to the input supply. While in shutdown, the supply current decreases to 0.05  $\mu\text{A}$  (typical) and  $V_{OUT}$  falls to zero volts.



**FIGURE 4-1:** Typical Application Circuit.

## 4.1 Bypass Input

A 0.01  $\mu\text{F}$  ceramic capacitor, connected from the Bypass input to ground, reduces noise present on the internal reference, which, in turn, significantly reduces output noise. If output noise is not a concern, this input may be left unconnected. Larger capacitor values may be used, but the result is a longer time period to rated output voltage when power is initially applied.

## 4.2 Output Capacitor

A 1  $\mu\text{F}$  (min) capacitor from  $V_{OUT}$  to ground is required. The output capacitor should have an Effective Series Resistance (ESR) of 0.01  $\Omega$  to 5  $\Omega$  for  $V_{OUT} \geq 2.5\text{V}$ , and 0.05  $\Omega$  to 5  $\Omega$  for  $V_{OUT} < 2.5\text{V}$ . Ceramic, tantalum or aluminum electrolytic capacitors can be used. When using ceramic capacitors, X5R and X7R dielectric material are recommended due to their stable tolerance over temperature. However, other dielectrics can be used as long as the minimum output capacitance is maintained.

## 4.3 Input Capacitor

A 1  $\mu\text{F}$  capacitor should be connected from  $V_{IN}$  to GND if there is more than 10 inches of wire between the regulator and this AC filter capacitor, or if a battery is used as the power source. Aluminum electrolytic or tantalum capacitors can be used (since many aluminum electrolytic capacitors freeze at approximately  $-30^\circ\text{C}$ , solid tantalum are recommended for applications operating below  $-25^\circ\text{C}$ ). When operating from sources other than batteries, supply-noise rejection and transient response can be improved by increasing the value of the input and output capacitors and employing passive filtering techniques.

## 5.0 THERMAL CONSIDERATIONS

### 5.1 Thermal Shutdown

Integrated thermal protection circuitry shuts the regulator off when the die temperature exceeds approximately 160°C. The regulator remains off until the die temperature cools to approximately 150°C.

### 5.2 Power Dissipation

The amount of power the regulator dissipates is primarily a function of input voltage, output voltage and output current.

The following equation is used to calculate worst-case power dissipation.

#### EQUATION 5-1:

$$P_D \approx (V_{INMAX} - V_{OUTMIN})I_{LMAX}$$

Where:

$P_D$	=	Worst-case actual power dissipation
$V_{INMAX}$	=	Maximum voltage on $V_{IN}$
$V_{OUTMIN}$	=	Minimum regulator output voltage
$I_{LMAX}$	=	Maximum output (load) current

The maximum allowable power dissipation ( $P_{DMAX}$ ) is a function of the maximum ambient temperature ( $T_{AMAX}$ ), the maximum allowable die temperature ( $T_{JMAX}$ ) (+125°C) and the thermal resistance from junction-to-air ( $\theta_{JA}$ ). The 5-Pin SOT-23A package has a  $\theta_{JA}$  of approximately 220°C/Watt when mounted on a typical two-layer FR4 dielectric copper-clad PC board.

#### EQUATION 5-2:

$$P_{DMAX} = \frac{T_{JMAX} - T_{AMAX}}{\theta_{JA}}$$

Where all terms are previously defined.

The  $P_D$  equation can be used in conjunction with the  $P_{DMAX}$  equation to ensure that regulator thermal operation is within limits. For example:

Given:

$$\begin{aligned} V_{INMAX} &= 3.0V + 10\% \\ V_{OUTMIN} &= 2.7V - 2.5\% \\ I_{LOADMAX} &= 40 \text{ mA} \\ T_{JMAX} &= +125^\circ\text{C} \\ T_{AMAX} &= +55^\circ\text{C} \end{aligned}$$

Find:

1. Actual power dissipation
2. Maximum allowable dissipation

Actual power dissipation:

$$\begin{aligned} P_D &= (V_{INMAX} - V_{OUTMIN})I_{LMAX} \\ &= [(3.0 \times 1.1) - (2.7 \times 0.975)]40 \times 10^{-3} \\ &= 26.7 \text{ mW} \end{aligned}$$

Maximum allowable power dissipation:

$$\begin{aligned} P_{DMAX} &= \frac{T_{JMAX} - T_{AMAX}}{\theta_{JA}} \\ &= \frac{125 - 55}{220} \\ &= 318 \text{ mW} \end{aligned}$$

In this example, the TC2014 dissipates a maximum of only 26.7 mW; far below the allowable limit of 318 mW. In a similar manner, the  $P_D$  and  $P_{DMAX}$  equations can be used to calculate maximum current and/or input voltage limits.

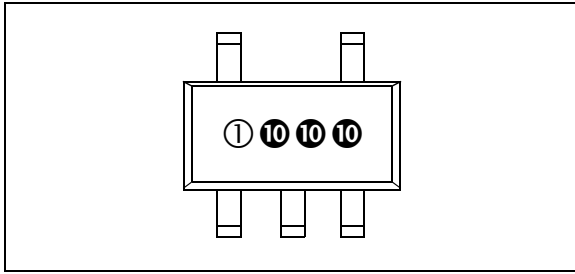
### 5.3 Layout Considerations

The primary path of heat conduction out of the package is via the package leads. Therefore, layouts having a ground plane, wide traces at the pads and wide power supply bus lines combine to lower  $\theta_{JA}$  and, therefore, increase the maximum allowable power dissipation limit.

# TC2014/2015/2185

## 6.0 PACKAGING INFORMATION

### 6.1 Package Marking Information



- ① & ⑩ represents part number code + temperature range and voltage
- ⑩ represents year and 2-month period code
- ⑩ represents lot ID number

**TABLE 6-1: PART NUMBER CODE AND TEMPERATURE RANGE**

(V)	TC2014	TC2015	TC2185
1.8	PA	RA	UA
2.5	PB	RB	UB
2.6	PH	RH	UH
2.7	PC	RC	UC
2.8	PD	RD	UD
2.85	PE	RE	UE
3.0	PF	RF	UF
3.3	PG	RG	UG
5.0	PJ	RJ	UJ

### 6.2 Taping Form

**Component Taping Orientation for 5-Pin SOT-23A (EIAJ SC-74A) Devices**

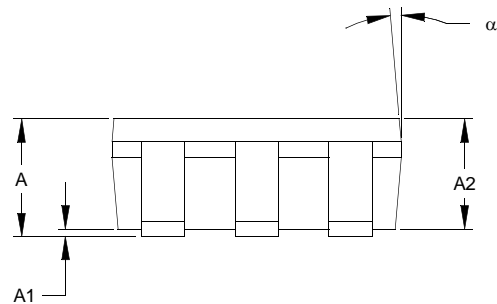
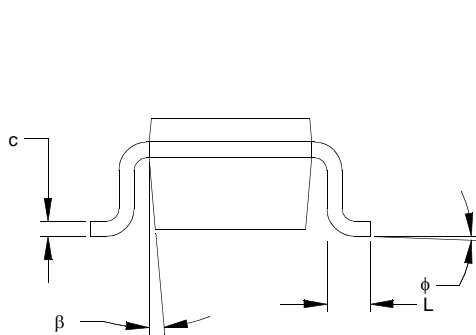
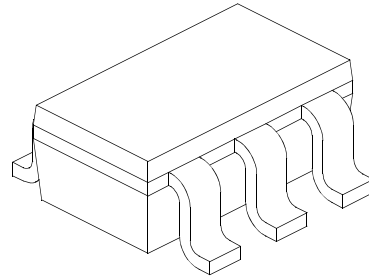
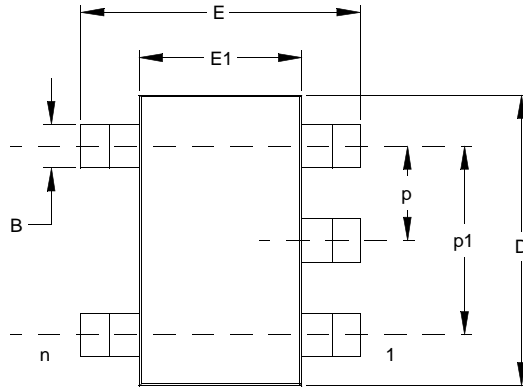
Standard Reel Component Orientation  
for 713 Suffix Device  
(Mark Right Side Up)

**Carrier Tape, Number of Components Per Reel and Reel Size:**

Package	Carrier Width (W)	Pitch (P)	Part Per Full Reel	Reel Size
5-Pin SOT-23A	8 mm	4 mm	3000	7 in.

## 5-Lead Plastic Small Outline Transistor (OT) (SOT23)

**Note:** For the most current package drawings, please see the Microchip Packaging Specification located at <http://www.microchip.com/packaging>



Units		INCHES*			MILLIMETERS		
Dimension Limits		MIN	NOM	MAX	MIN	NOM	MAX
Number of Pins	n		5			5	
Pitch	p		.038			0.95	
Outside lead pitch (basic)	p1		.075			1.90	
Overall Height	A	.035	.046	.057	0.90	1.18	1.45
Molded Package Thickness	A2	.035	.043	.051	0.90	1.10	1.30
Standoff	A1	.000	.003	.006	0.00	0.08	0.15
Overall Width	E	.102	.110	.118	2.60	2.80	3.00
Molded Package Width	E1	.059	.064	.069	1.50	1.63	1.75
Overall Length	D	.110	.116	.122	2.80	2.95	3.10
Foot Length	L	.014	.018	.022	0.35	0.45	0.55
Foot Angle	f	0	5	10	0	5	10
Lead Thickness	c	.004	.006	.008	0.09	0.15	0.20
Lead Width	B	.014	.017	.020	0.35	0.43	0.50
Mold Draft Angle Top	a	0	5	10	0	5	10
Mold Draft Angle Bottom	b	0	5	10	0	5	10

\* Controlling Parameter

**Notes:**

Dimensions D and E1 do not include mold flash or protrusions. Mold flash or protrusions shall not exceed .005" (0.127mm) per side.

EIAJ Equivalent: SC-74A

Drawing No. C04-091

Revised 09-12-05

NOTES:

## **APPENDIX A: REVISION HISTORY**

### **Revision F (December 2012)**

- Added a note to each package outline drawing.

### **Revision E (May 2006)**

- Page 1: Added overtemperature to bullet for over-current protection in features and general description verbiage.
- Page 3: Added Thermal Shutdown die Temperature to electrical characteristics table.
- Page 3: Added Thermal Characteristics Table.
- Page 5: Added new section 5.1 and new verbiage.
- Page 13: Updated package outline drawing.

### **Revision D (November 2004)**

- Page 2: Changed Absolute Maximum Ratings from 6.5V to 7.0V.
- Packaging Information: Added package codes for 2.6V and 5.0V options.
- Product Identification System: Added 2.6V and 5.0V to Output voltage options.

### **Revision C (December 2002)**

- Numerous changes

### **Revision B (May 2002)**

- Numerous changes

### **Revision A (May 2001)**

- Original Release of this Document.

NOTES:



## PRODUCT IDENTIFICATION SYSTEM

To order or obtain information, e.g., on pricing or delivery, refer to the factory or the listed sales office.

<u>PART NO.</u>	<u>-XX</u>	<u>X</u>	<u>XXXX</u>	<b>Examples:</b>
<b>Device</b>	<b>Output Voltage</b>	<b>Temperature Range</b>	<b>Package</b>	
Device: TC2014: 50 mA LDO with Shutdown and $V_{REF}$ Bypass TC2015: 100 mA LDO with Shutdown and $V_{REF}$ Bypass TC2185: 150 mA LDO with Shutdown and $V_{REF}$ Bypass	Output Voltage: XX = 1.8V XX = 2.5V XX = 2.6V XX = 2.7V XX = 2.8V XX = 2.85V XX = 3.0V XX = 3.3V XX = 5.0V	Temperature Range: V = -40°C to +125°C	Package: CTTR = Plastic Small Outline Transistor (SOT-23), 5-lead, Tape and Reel	a) TC2014-1.8VCTTR: 5LD SOT-23-A, 1.8V, Tape and Reel. b) TC2014-2.85VCTTR: 5LD SOT-23-A, 2.85V, Tape and Reel. c) TC2014-3.3VCTTR: 5LD SOT-23-A, 3.3V, Tape and Reel. a) TC2015-1.8VCTTR: 5LD SOT-23-A, 1.8V, Tape and Reel. b) TC2015-2.85VCTTR: 5LD SOT-23-A, 2.85V, Tape and Reel. c) TC2015-3.0VCTTR: 5LD SOT-23-A, 3.0V, Tape and Reel. a) TC2185-1.8VCTTR: 5LD SOT-23-A, 1.8V, Tape and Reel. b) TC2185-2.8VCTTR: 5LD SOT-23-A, 2.8V, Tape and Reel.

NOTES:

---

**Note the following details of the code protection feature on Microchip devices:**

- Microchip products meet the specification contained in their particular Microchip Data Sheet.
- Microchip believes that its family of products is one of the most secure families of its kind on the market today, when used in the intended manner and under normal conditions.
- There are dishonest and possibly illegal methods used to breach the code protection feature. All of these methods, to our knowledge, require using the Microchip products in a manner outside the operating specifications contained in Microchip's Data Sheets. Most likely, the person doing so is engaged in theft of intellectual property.
- Microchip is willing to work with the customer who is concerned about the integrity of their code.
- Neither Microchip nor any other semiconductor manufacturer can guarantee the security of their code. Code protection does not mean that we are guaranteeing the product as “unbreakable.”

Code protection is constantly evolving. We at Microchip are committed to continuously improving the code protection features of our products. Attempts to break Microchip's code protection feature may be a violation of the Digital Millennium Copyright Act. If such acts allow unauthorized access to your software or other copyrighted work, you may have a right to sue for relief under that Act.

---

Information contained in this publication regarding device applications and the like is provided only for your convenience and may be superseded by updates. It is your responsibility to ensure that your application meets with your specifications. MICROCHIP MAKES NO REPRESENTATIONS OR WARRANTIES OF ANY KIND WHETHER EXPRESS OR IMPLIED, WRITTEN OR ORAL, STATUTORY OR OTHERWISE, RELATED TO THE INFORMATION, INCLUDING BUT NOT LIMITED TO ITS CONDITION, QUALITY, PERFORMANCE, MERCHANTABILITY OR FITNESS FOR PURPOSE. Microchip disclaims all liability arising from this information and its use. Use of Microchip devices in life support and/or safety applications is entirely at the buyer's risk, and the buyer agrees to defend, indemnify and hold harmless Microchip from any and all damages, claims, suits, or expenses resulting from such use. No licenses are conveyed, implicitly or otherwise, under any Microchip intellectual property rights.

**Trademarks**

The Microchip name and logo, the Microchip logo, dsPIC, FlashFlex, KEELOQ, KEELOQ logo, MPLAB, PIC, PICmicro, PICSTART, PIC<sup>32</sup> logo, rPIC, SST, SST Logo, SuperFlash and UNI/O are registered trademarks of Microchip Technology Incorporated in the U.S.A. and other countries.

FilterLab, Hampshire, HI-TECH C, Linear Active Thermistor, MTP, SEEVAL and The Embedded Control Solutions Company are registered trademarks of Microchip Technology Incorporated in the U.S.A.

Silicon Storage Technology is a registered trademark of Microchip Technology Inc. in other countries.

Analog-for-the-Digital Age, Application Maestro, BodyCom, chipKIT, chipKIT logo, CodeGuard, dsPICDEM, dsPICDEM.net, dsPICworks, dsSPEAK, ECAN, ECONOMONITOR, FanSense, HI-TIDE, In-Circuit Serial Programming, ICSP, Mindi, MiWi, MPASM, MPF, MPLAB Certified logo, MPLIB, MPLINK, mTouch, Omniclient Code Generation, PICC, PICC-18, PICDEM, PICDEM.net, PICkit, PICtail, REAL ICE, rLAB, Select Mode, SQI, Serial Quad I/O, Total Endurance, TSHARC, UniWinDriver, WiperLock, ZENA and Z-Scale are trademarks of Microchip Technology Incorporated in the U.S.A. and other countries.

SQTP is a service mark of Microchip Technology Incorporated in the U.S.A.

GestIC and ULPP are registered trademarks of Microchip Technology Germany II GmbH & Co. & KG, a subsidiary of Microchip Technology Inc., in other countries.

All other trademarks mentioned herein are property of their respective companies.

© 2001-2012, Microchip Technology Incorporated, Printed in the U.S.A., All Rights Reserved.

 Printed on recycled paper.

ISBN: 9781620768884

**QUALITY MANAGEMENT SYSTEM**  
**CERTIFIED BY DNV**  
**== ISO/TS 16949 ==**

*Microchip received ISO/TS-16949:2009 certification for its worldwide headquarters, design and wafer fabrication facilities in Chandler and Tempe, Arizona; Gresham, Oregon and design centers in California and India. The Company's quality system processes and procedures are for its PIC<sup>®</sup> MCUs and dsPIC<sup>®</sup> DSCs, KEELOQ<sup>®</sup> code hopping devices, Serial EEPROMs, microperipherals, nonvolatile memory and analog products. In addition, Microchip's quality system for the design and manufacture of development systems is ISO 9001:2000 certified.*



# MICROCHIP

## Worldwide Sales and Service

### AMERICAS

**Corporate Office**  
2355 West Chandler Blvd.  
Chandler, AZ 85224-6199  
Tel: 480-792-7200  
Fax: 480-792-7277  
Technical Support:  
<http://www.microchip.com/support>  
Web Address:  
[www.microchip.com](http://www.microchip.com)

**Atlanta**  
Duluth, GA  
Tel: 678-957-9614  
Fax: 678-957-1455

**Boston**  
Westborough, MA  
Tel: 774-760-0087  
Fax: 774-760-0088

**Chicago**  
Itasca, IL  
Tel: 630-285-0071  
Fax: 630-285-0075

**Cleveland**  
Independence, OH  
Tel: 216-447-0464  
Fax: 216-447-0643

**Dallas**  
Addison, TX  
Tel: 972-818-7423  
Fax: 972-818-2924

**Detroit**  
Farmington Hills, MI  
Tel: 248-538-2250  
Fax: 248-538-2260

**Indianapolis**  
Noblesville, IN  
Tel: 317-773-8323  
Fax: 317-773-5453

**Los Angeles**  
Mission Viejo, CA  
Tel: 949-462-9523  
Fax: 949-462-9608

**Santa Clara**  
Santa Clara, CA  
Tel: 408-961-6444  
Fax: 408-961-6445

**Toronto**  
Mississauga, Ontario,  
Canada  
Tel: 905-673-0699  
Fax: 905-673-6509

### ASIA/PACIFIC

**Asia Pacific Office**  
Suites 3707-14, 37th Floor  
Tower 6, The Gateway  
Harbour City, Kowloon  
Hong Kong  
Tel: 852-2401-1200  
Fax: 852-2401-3431

**Australia - Sydney**  
Tel: 61-2-9868-6733  
Fax: 61-2-9868-6755

**China - Beijing**  
Tel: 86-10-8569-7000  
Fax: 86-10-8528-2104

**China - Chengdu**  
Tel: 86-28-8665-5511  
Fax: 86-28-8665-7889

**China - Chongqing**  
Tel: 86-23-8980-9588  
Fax: 86-23-8980-9500

**China - Hangzhou**  
Tel: 86-571-2819-3187  
Fax: 86-571-2819-3189

**China - Hong Kong SAR**  
Tel: 852-2943-5100  
Fax: 852-2401-3431

**China - Nanjing**  
Tel: 86-25-8473-2460  
Fax: 86-25-8473-2470

**China - Qingdao**  
Tel: 86-532-8502-7355  
Fax: 86-532-8502-7205

**China - Shanghai**  
Tel: 86-21-5407-5533  
Fax: 86-21-5407-5066

**China - Shenyang**  
Tel: 86-24-2334-2829  
Fax: 86-24-2334-2393

**China - Shenzhen**  
Tel: 86-755-8864-2200  
Fax: 86-755-8203-1760

**China - Wuhan**  
Tel: 86-27-5980-5300  
Fax: 86-27-5980-5118

**China - Xian**  
Tel: 86-29-8833-7252  
Fax: 86-29-8833-7256

**China - Xiamen**  
Tel: 86-592-2388138  
Fax: 86-592-2388130

**China - Zhuhai**  
Tel: 86-756-3210040  
Fax: 86-756-3210049

### ASIA/PACIFIC

**India - Bangalore**  
Tel: 91-80-3090-4444  
Fax: 91-80-3090-4123

**India - New Delhi**  
Tel: 91-11-4160-8631  
Fax: 91-11-4160-8632

**India - Pune**  
Tel: 91-20-2566-1512  
Fax: 91-20-2566-1513

**Japan - Osaka**  
Tel: 81-6-6152-7160  
Fax: 81-6-6152-9310

**Japan - Tokyo**  
Tel: 81-3-6880-3770  
Fax: 81-3-6880-3771

**Korea - Daegu**  
Tel: 82-53-744-4301  
Fax: 82-53-744-4302

**Korea - Seoul**  
Tel: 82-2-554-7200  
Fax: 82-2-558-5932 or  
82-2-558-5934

**Malaysia - Kuala Lumpur**  
Tel: 60-3-6201-9857  
Fax: 60-3-6201-9859

**Malaysia - Penang**  
Tel: 60-4-227-8870  
Fax: 60-4-227-4068

**Philippines - Manila**  
Tel: 63-2-634-9065  
Fax: 63-2-634-9069

**Singapore**  
Tel: 65-6334-8870  
Fax: 65-6334-8850

**Taiwan - Hsin Chu**  
Tel: 886-3-5778-366  
Fax: 886-3-5770-955

**Taiwan - Kaohsiung**  
Tel: 886-7-213-7828  
Fax: 886-7-330-9305

**Taiwan - Taipei**  
Tel: 886-2-2508-8600  
Fax: 886-2-2508-0102

**Thailand - Bangkok**  
Tel: 66-2-694-1351  
Fax: 66-2-694-1350

### EUROPE

**Austria - Wels**  
Tel: 43-7242-2244-39  
Fax: 43-7242-2244-393

**Denmark - Copenhagen**  
Tel: 45-4450-2828  
Fax: 45-4485-2829

**France - Paris**  
Tel: 33-1-69-53-63-20  
Fax: 33-1-69-30-90-79

**Germany - Munich**  
Tel: 49-89-627-144-0  
Fax: 49-89-627-144-44

**Italy - Milan**  
Tel: 39-0331-742611  
Fax: 39-0331-466781

**Netherlands - Drunen**  
Tel: 31-416-690399  
Fax: 31-416-690340

**Spain - Madrid**  
Tel: 34-91-708-08-90  
Fax: 34-91-708-08-91

**UK - Wokingham**  
Tel: 44-118-921-5869  
Fax: 44-118-921-5820

11/29/12



Компания «ЭлектроПласт» предлагает заключение долгосрочных отношений при поставках импортных электронных компонентов на взаимовыгодных условиях!

Наши преимущества:

- Оперативные поставки широкого спектра электронных компонентов отечественного и импортного производства напрямую от производителей и с крупнейших мировых складов;
- Поставка более 17-ти миллионов наименований электронных компонентов;
- Поставка сложных, дефицитных, либо снятых с производства позиций;
- Оперативные сроки поставки под заказ (от 5 рабочих дней);
- Экспресс доставка в любую точку России;
- Техническая поддержка проекта, помощь в подборе аналогов, поставка прототипов;
- Система менеджмента качества сертифицирована по Международному стандарту ISO 9001;
- Лицензия ФСБ на осуществление работ с использованием сведений, составляющих государственную тайну;
- Поставка специализированных компонентов (Xilinx, Altera, Analog Devices, Intersil, Interpoint, Microsemi, Aeroflex, Peregrine, Syfer, Eurofarad, Texas Instrument, Miteq, Cobham, E2V, MA-COM, Hittite, Mini-Circuits, General Dynamics и др.);

Помимо этого, одним из направлений компании «ЭлектроПласт» является направление «Источники питания». Мы предлагаем Вам помощь Конструкторского отдела:

- Подбор оптимального решения, техническое обоснование при выборе компонента;
- Подбор аналогов;
- Консультации по применению компонента;
- Поставка образцов и прототипов;
- Техническая поддержка проекта;
- Защита от снятия компонента с производства.



#### Как с нами связаться

**Телефон:** 8 (812) 309 58 32 (многоканальный)

**Факс:** 8 (812) 320-02-42

**Электронная почта:** [org@eplast1.ru](mailto:org@eplast1.ru)

**Адрес:** 198099, г. Санкт-Петербург, ул. Калинина, дом 2, корпус 4, литера А.