

**SERIES:** CFM-80V | **DESCRIPTION:** DC AXIAL FAN**FEATURES**

- omniCOOL™ bearing system
- 80 x 80 mm frame
- multiple speed options for different cooling needs
- tachometer signal and rotation detect options available
- auto restart protection standard on all models



MODEL	input voltage		input current <sup>1</sup>	input power <sup>1</sup>	rated speed <sup>1</sup>	air flow <sup>2</sup>	static pressure <sup>3</sup>	noise <sup>4</sup>
	rated (Vdc)	range (Vdc)	max (mA)	max (W)	typ (RPM±10%)	(CFM)	(inch H <sub>2</sub> O)	max (dBA)
CFM-8015V-124-308	12	4.5~13.8	104	1.25	2400	30.0	0.09	30.8
CFM-8015V-127-320	12	4.5~13.8	149	1.79	2700	33.6	0.11	32.0
CFM-8015V-130-347	12	4.5~13.8	188	2.26	3000	37.0	0.14	34.7
CFM-8015V-224-308	24	8~27.6	65	1.56	2400	30.0	0.09	30.8
CFM-8015V-227-320	24	8~27.6	75	1.80	2700	33.6	0.11	32.0
CFM-8015V-230-347	24	8~27.6	106	2.55	3000	37.0	0.14	34.7
CFM-8020V-126-300	12	6~13.8	86	1.04	2600	29.0	0.12	30.0
CFM-8020V-130-350	12	6~13.8	110	1.32	3000	33.0	0.16	35.0
CFM-8020V-133-380	12	6~13.8	150	1.80	3300	36.0	0.18	38.0
CFM-8020V-139-430*	12	6~13.8	225	2.70	3900	45.0	0.26	43.0
CFM-8020V-142-450*	12	6~13.8	265	3.18	4200	49.0	0.31	45.0
CFM-8020V-146-480*	12	6~12.6	328	3.94	4600	53.0	0.36	48.0
CFM-8020V-226-300	24	8~27.6	49	1.18	2600	29.0	0.12	30.0
CFM-8020V-230-350	24	8~27.6	59	1.42	3000	33.0	0.16	35.0
CFM-8020V-233-380	24	8~27.6	74	1.78	3300	36.0	0.18	38.0
CFM-8025V-120-204	12	4.5~13.8	48	0.58	2000	23.9	0.07	20.4
CFM-8025V-126-280	12	4.5~13.8	75	0.90	2600	33.0	0.11	28.0
CFM-8025V-129-300	12	4.5~13.8	106	1.28	2900	37.0	0.15	30.0
CFM-8025V-132-330	12	4.5~13.8	138	1.66	3200	41.0	0.18	33.0
CFM-8025V-142-415	12	6~13.8	230	2.76	4200	53.0	0.30	41.5
CFM-8025V-145-431	12	6~13.8	276	3.32	4500	57.0	0.35	43.1
CFM-8025V-148-447	12	6~13.8	357	4.29	4800	60.0	0.41	44.7
CFM-8025V-226-280	24	8~27.6	48	1.16	2600	33.0	0.11	28.0
CFM-8025V-229-300	24	8~27.6	58	1.40	2900	37.0	0.15	30.0

- Notes:
1. At rated voltage, 25°C, 0 inch H<sub>2</sub>O static pressure, after 10 minutes
  2. As per AMCA 210 or DIN 24163, at rated voltage, stabilized RPM, 0 inch H<sub>2</sub>O static pressure
  3. As per AMCA 210 or DIN 24163, at rated voltage, stabilized RPM, 0 CFM airflow.
  4. Measured in a semi-anechoic chamber with background noise < 15 dBA at 1 m from the fan intake.
  5. All specifications are measured at 25°C, 65% relative humidity unless otherwise specified.
- \*. Discontinued models

## MODEL

MODEL	input voltage		input current <sup>1</sup>	input power <sup>1</sup>	rated speed <sup>1</sup>	air flow <sup>2</sup>	static pressure <sup>3</sup>	noise <sup>4</sup>
	rated (Vdc)	range (Vdc)	max (mA)	max (W)	typ (RPM±10%)	(CFM)	(inch H <sub>2</sub> O)	max (dBA)
CFM-8025V-232-330	24	8~27.6	75	1.80	3200	41.0	0.18	33.0
CFM-8025V-242-435*	24	10~27.6	158	3.80	4200	53.0	0.30	43.5
CFM-8025V-245-450*	24	10~27.6	191	4.59	4500	57.0	0.35	45.0
CFM-8025V-442-435*	48	24~56.0	106	5.09	4200	53.0	0.30	43.5
CFM-8025V-445-450*	48	24~56.0	115	5.52	4500	57.0	0.35	45.0

- Notes:
1. At rated voltage, 25°C, 0 inch H<sub>2</sub>O static pressure, after 10 minutes
  2. As per AMCA 210 or DIN 24163, at rated voltage, stabilized RPM, 0 inch H<sub>2</sub>O static pressure
  3. As per AMCA 210 or DIN 24163, at rated voltage, stabilized RPM, 0 CFM airflow.
  4. Measured in a semi-anechoic chamber with background noise < 15 dBA at 1 m from the fan intake.
  5. All specifications are measured at 25°C, 65% relative humidity unless otherwise specified.
- \*. Discontinued models

## PART NUMBER KEY

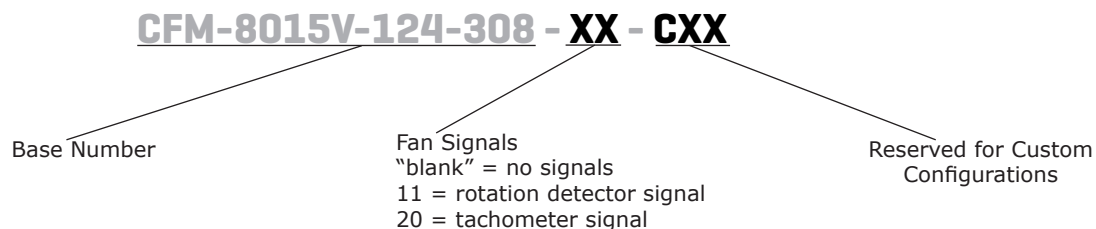

## INPUT

parameter	conditions/description	min	typ	max	units
operating input voltage <sup>1</sup>	12 Vdc input models	4.5	12	13.8	Vdc
	24 Vdc input models	8	24	27.6	Vdc
	48 Vdc input models	24	48	56.0	Vdc
starting voltage <sup>2</sup>	12 Vdc input models		4.5		Vdc
	24 Vdc input models		8		Vdc
	48 Vdc input models		24		Vdc

Note: 1. See Model section on page 1 for specific input voltage ranges.  
 2. Starting voltage for models CFM-8020V-126-300, CFM-8020V-130-350, CFM-8020V-133-380, CFM-8020V-139-430, CFM-8020V-142-450, CFM-8020V-146-480, CFM-8025V-142-415, CFM-8025V-145-431, and CFM-8025V-148-447 is 6 Vdc. Starting voltage for models CFM-8025V-242-435 and CFM-8025V-245-450 is 10 Vdc.

## PERFORMANCE<sup>3</sup>

parameter	conditions/description	min	typ	max	units
rated speed	at rated voltage, 25°C, after 10 minutes	2400		4800	RPM
air flow	at 0 inch H <sub>2</sub> O, see performance curves	23.9		60.0	CFM
static pressure	at 0 CFM, see performance curves	0.07		0.41	inch H <sub>2</sub> O
noise	at 1 m	20.4		48.0	dBA

Note: 3. See Model section on page 1 for specific values.

## PROTECTIONS / FEATURES<sup>4</sup>

parameter	conditions/description	min	typ	max	units
auto restart	on all models				
rotation detector signal	available on "11" models				
tachometer signal	available on "20" models				

Notes: 4. See Application Notes for details.

## SAFETY & COMPLIANCE

parameter	conditions/description	min	typ	max	units
insulation resistance of frame	at 500 Vdc between internal stator and positive lead wire	10			MΩ
dielectric strength	apply 500 Vac for 1 minute between housing and positive lead wire				
safety approvals	UL/cUL 507, TUV (EN 60950-1)				
EMI/EMC	EN 61000-6-1:2007, EN 61000-6-3:2007+A1				
life expectancy	at 40°C, 65% RH		70,000		hours
RoHS	yes				

## ENVIRONMENTAL

parameter	conditions/description	min	typ	max	units
operating temperature		-10		70	°C
storage temperature		-40		70	°C

## PERFORMANCE CURVES

**CFM-8015V-124-308**

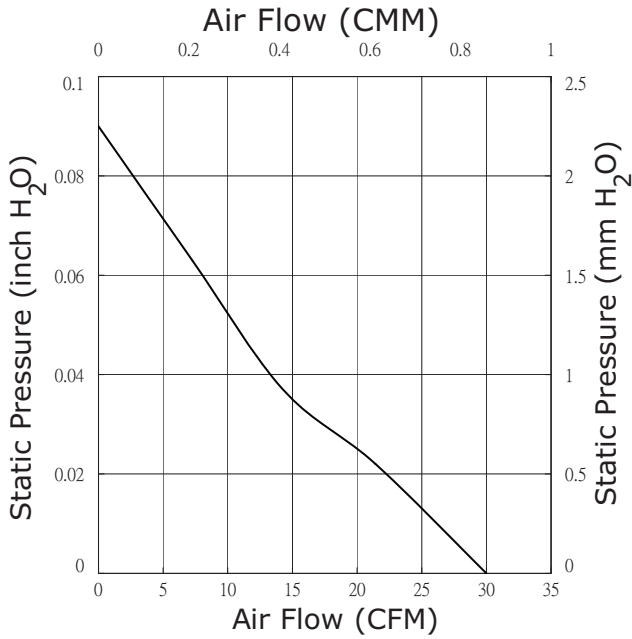

**CFM-8015V-127-320**

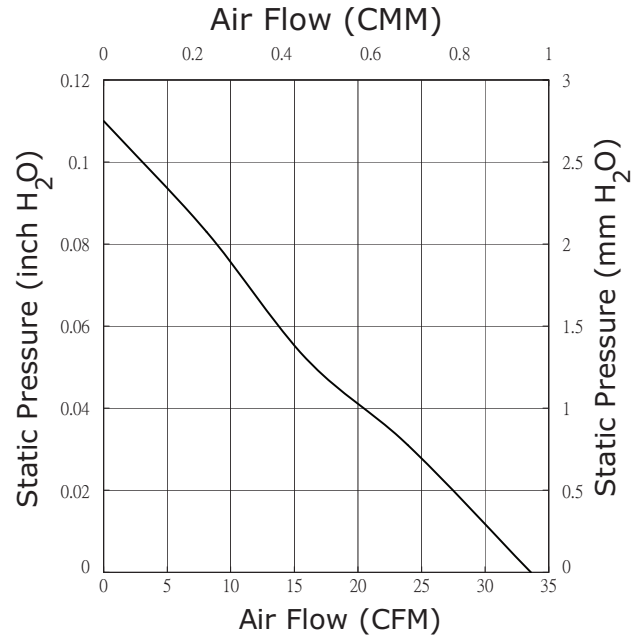

**CFM-8015V-130-347**

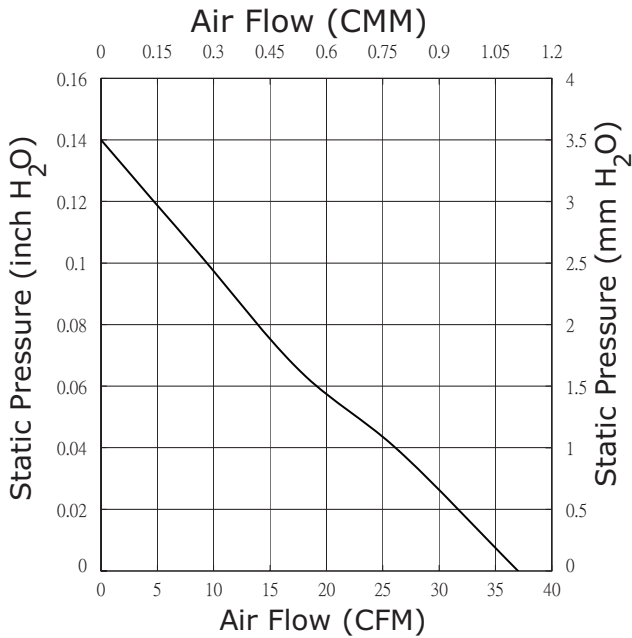

**CFM-8015V-224-308**

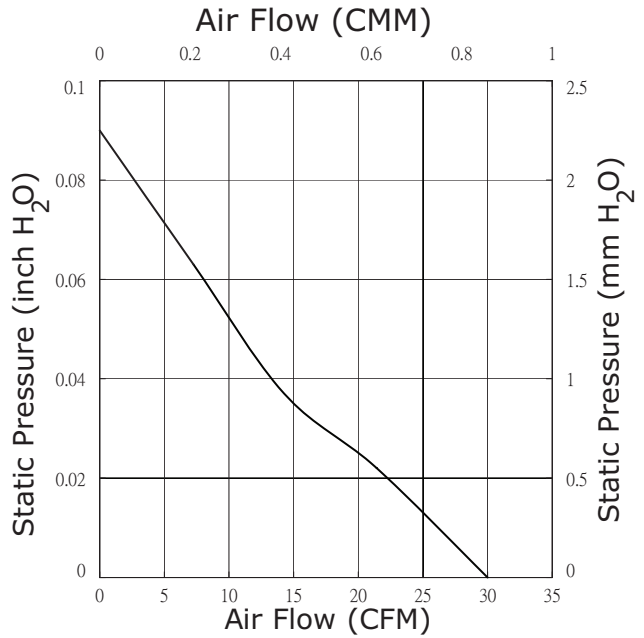

## PERFORMANCE CURVES (CONTINUED)

**CFM-8015V-227-320**

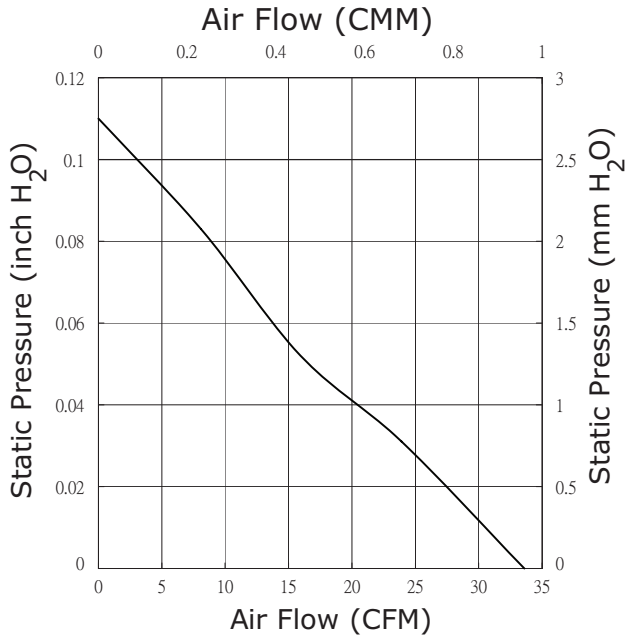

**CFM-8015V-230-347**

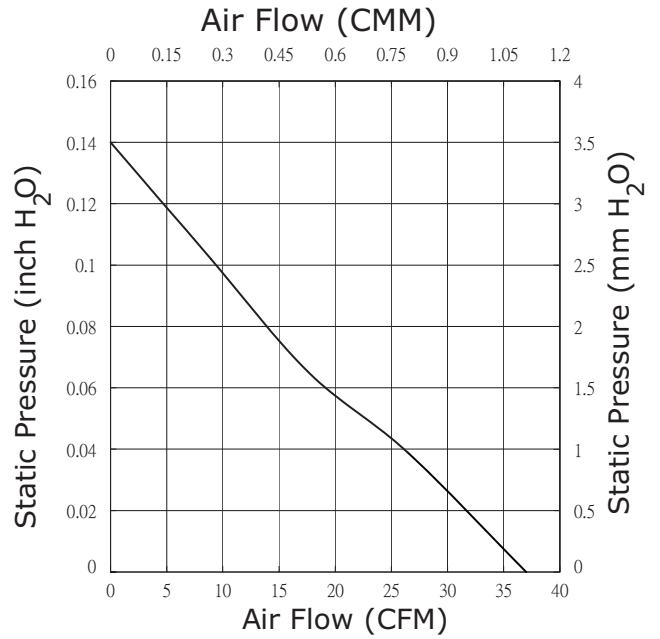

**CFM-8020V-126-300**

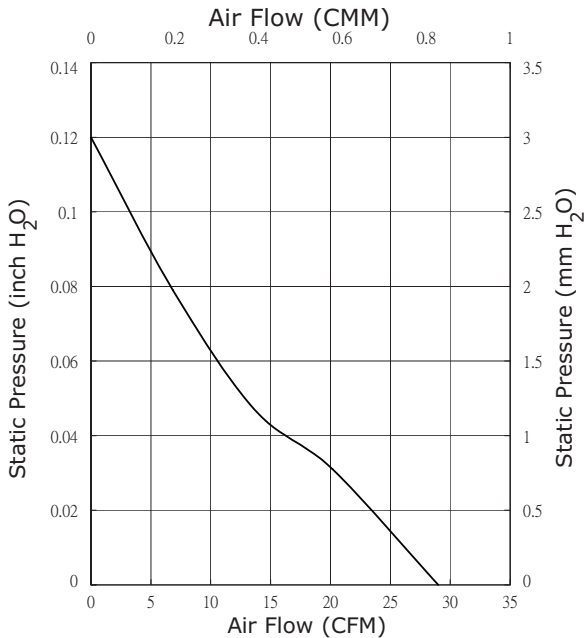

**CFM-8020V-130-350**

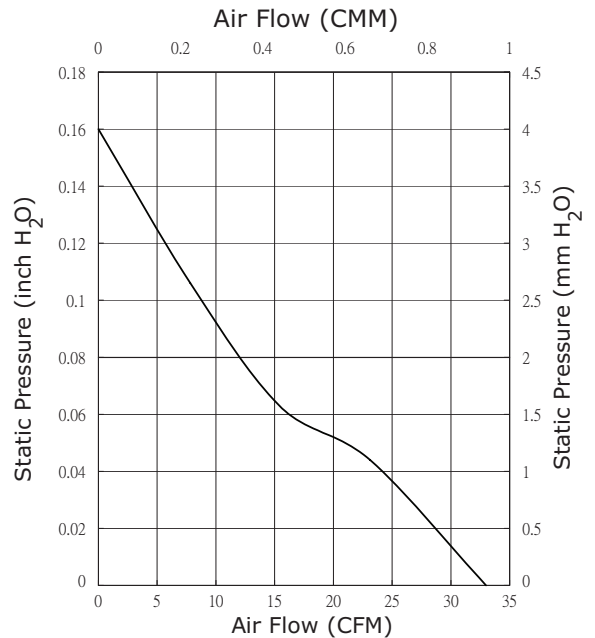

## PERFORMANCE CURVES (CONTINUED)

**CFM-8020V-133-380**

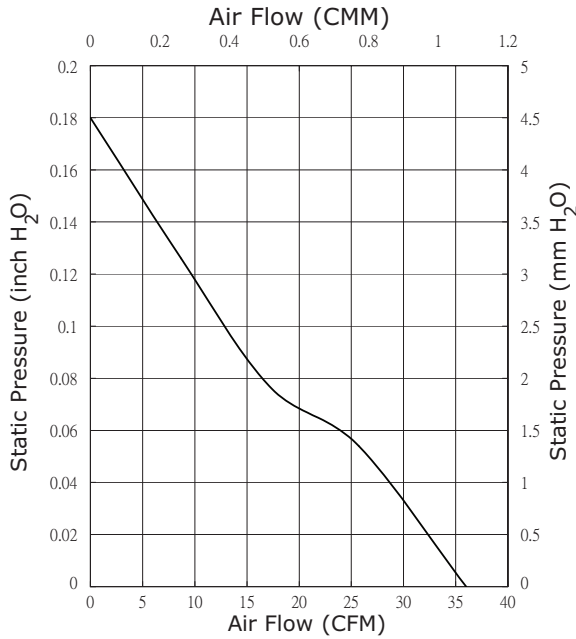

**CFM-8020V-139-430**

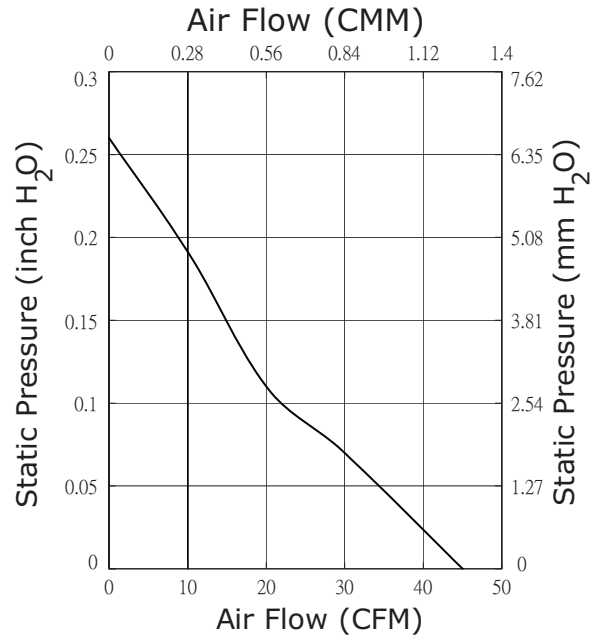

**CFM-8020V-142-450**

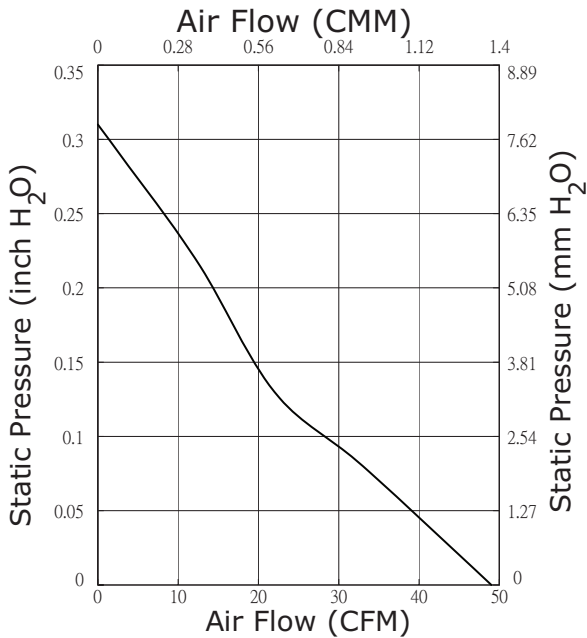

**CFM-8020V-146-480**

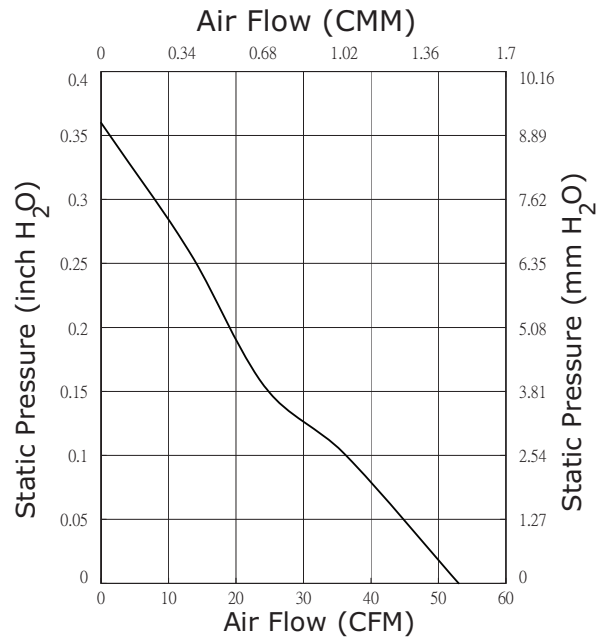

## PERFORMANCE CURVES (CONTINUED)

**CFM-8020V-226-300**

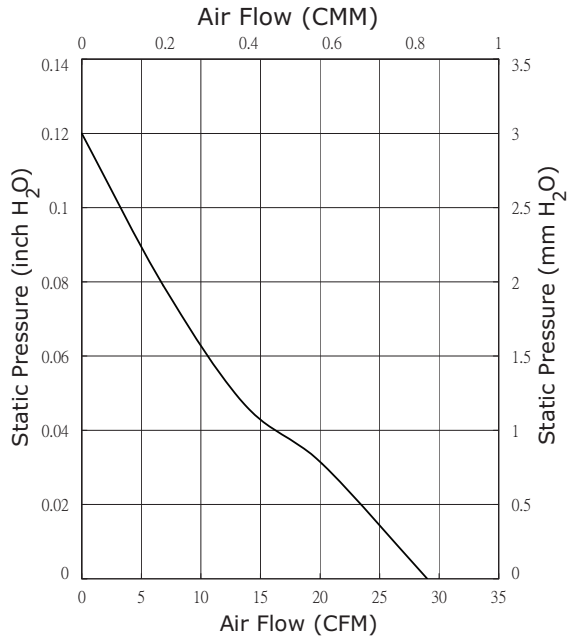

**CFM-8020V-230-350**

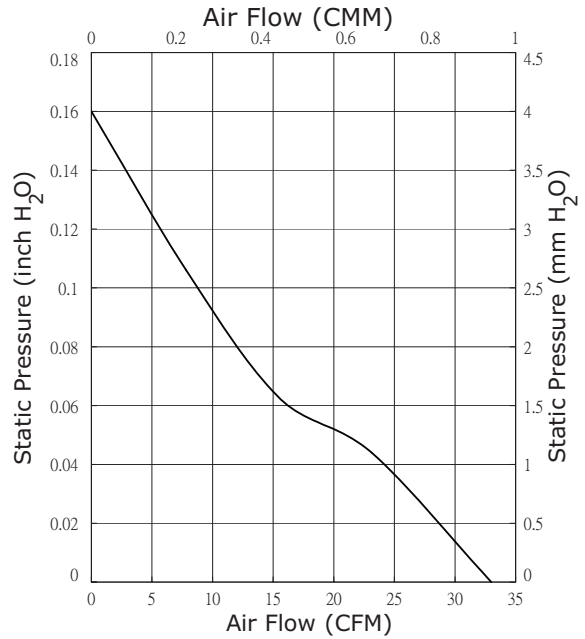

**CFM-8020V-233-380**

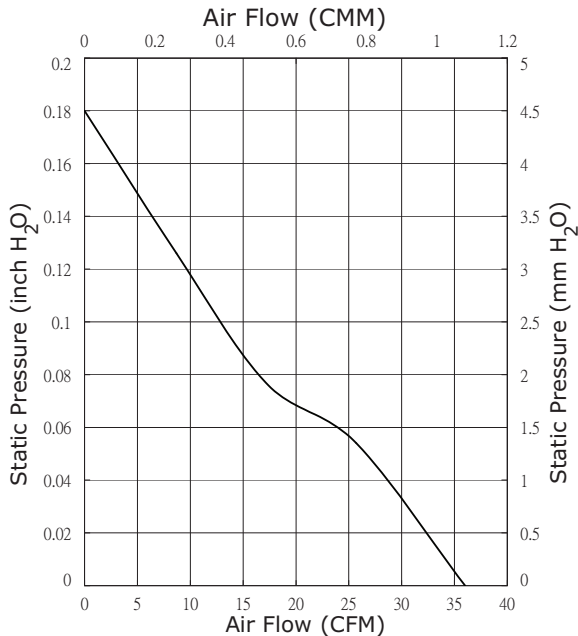

**CFM-8025V-120-204**

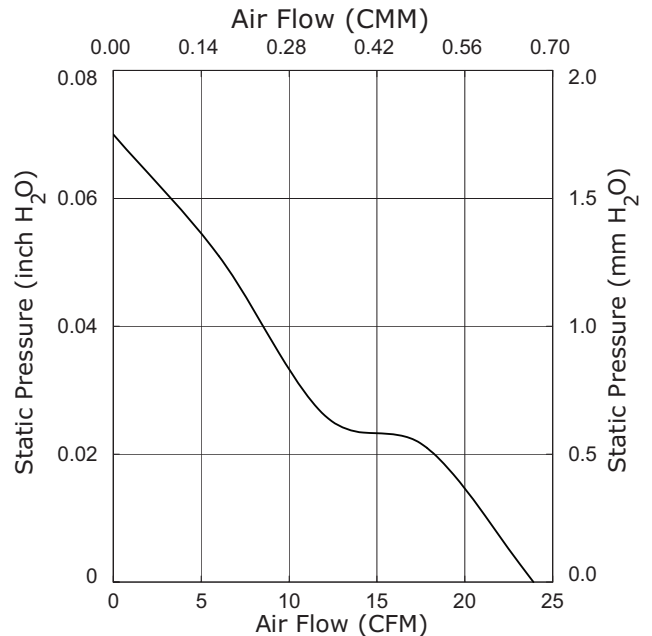

## PERFORMANCE CURVES (CONTINUED)

**CFM-8025V-126-280**

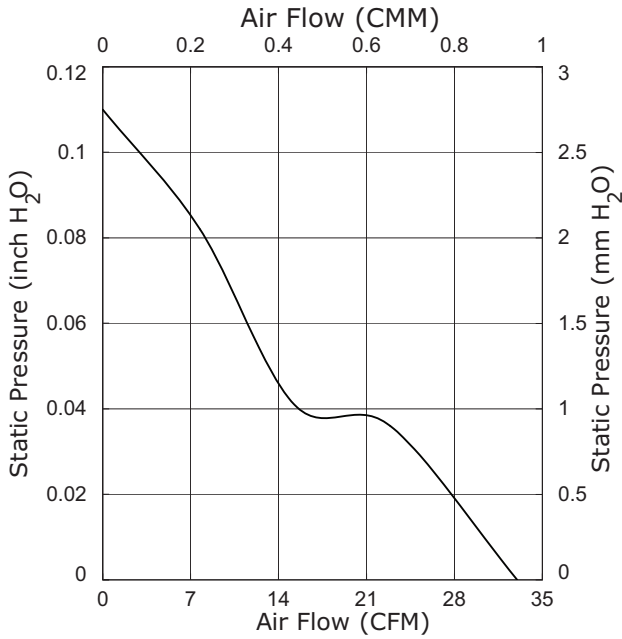

**CFM-8025V-129-300**

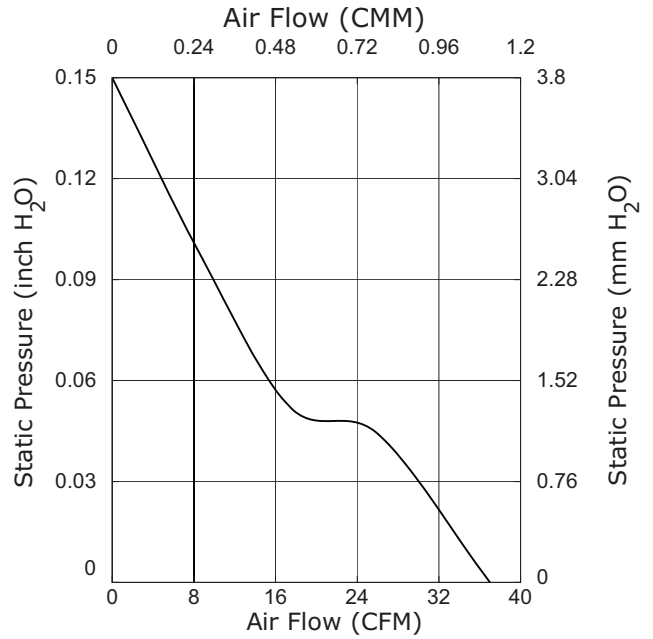

**CFM-8025V-132-330**

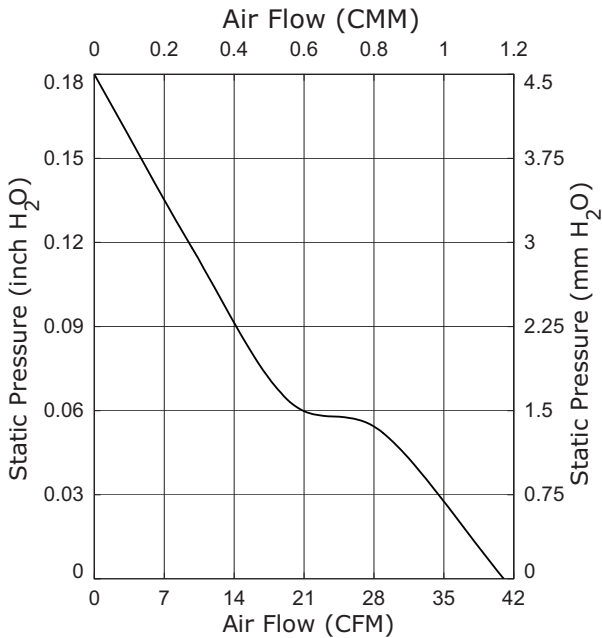

**CFM-8025V-142-415**

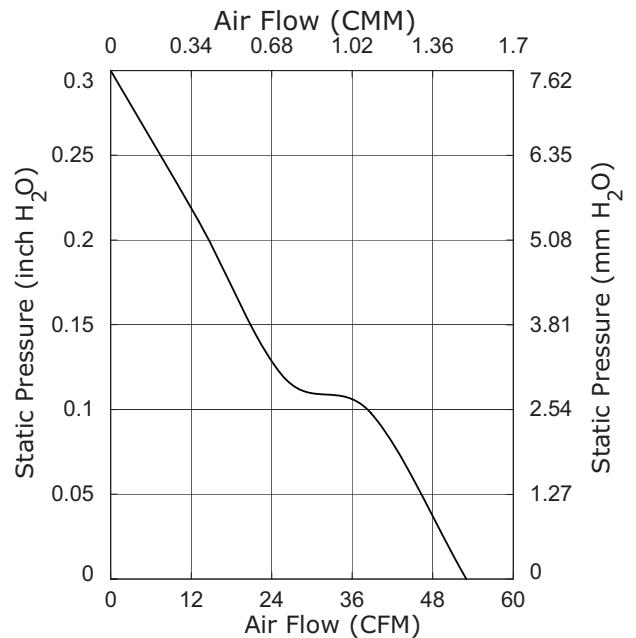



## PERFORMANCE CURVES (CONTINUED)

**CFM-8025V-145-431**

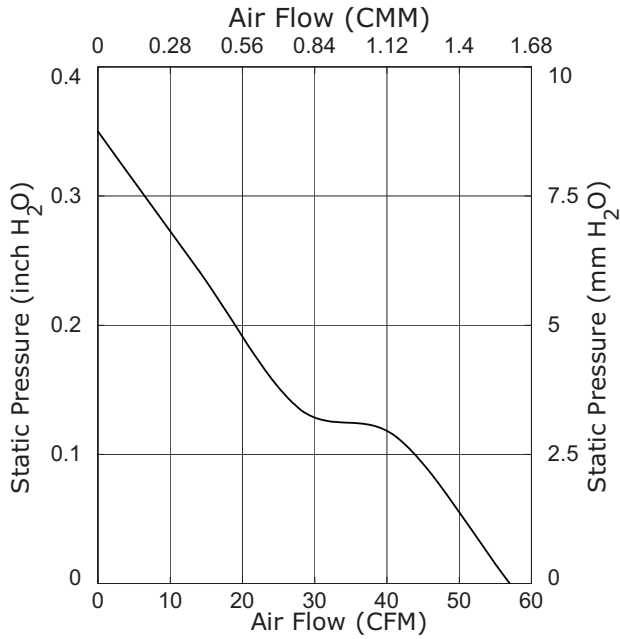

**CFM-8025V-148-447**

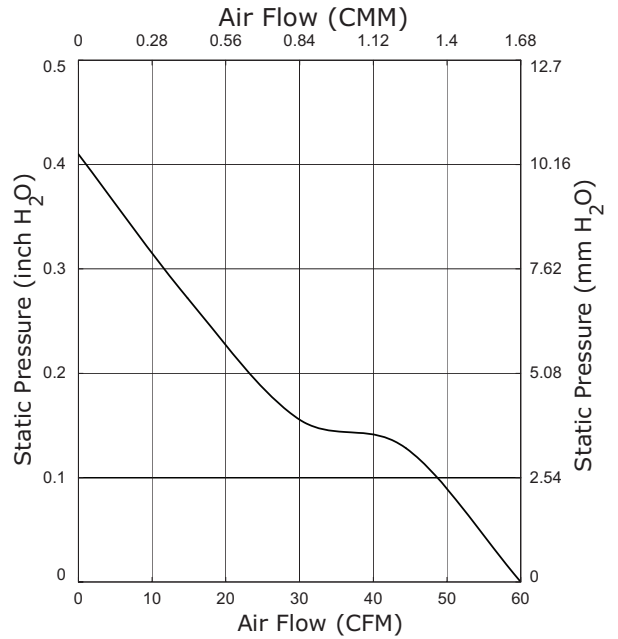

**CFM-8025V-226-280**

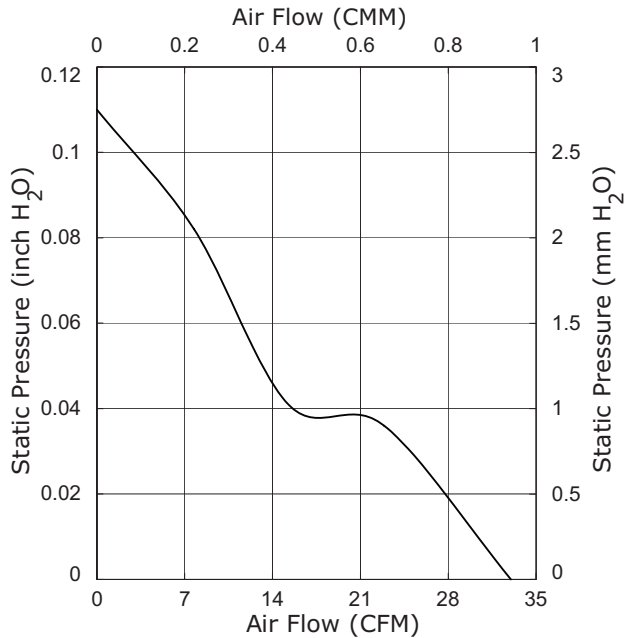

**CFM-8025V-229-300**

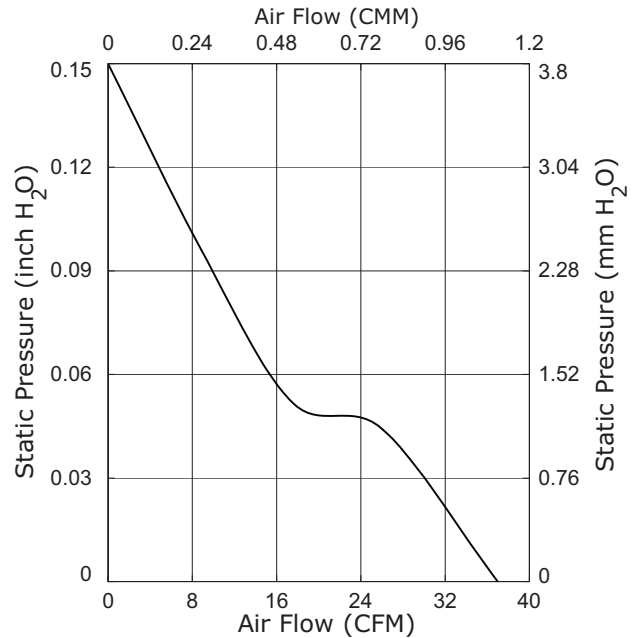

## PERFORMANCE CURVES (CONTINUED)

**CFM-8025V-232-330**

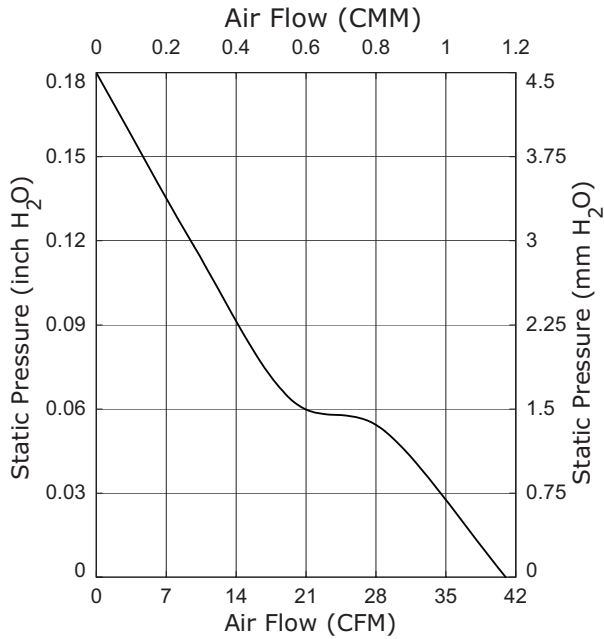

**CFM-8025V-242-435**

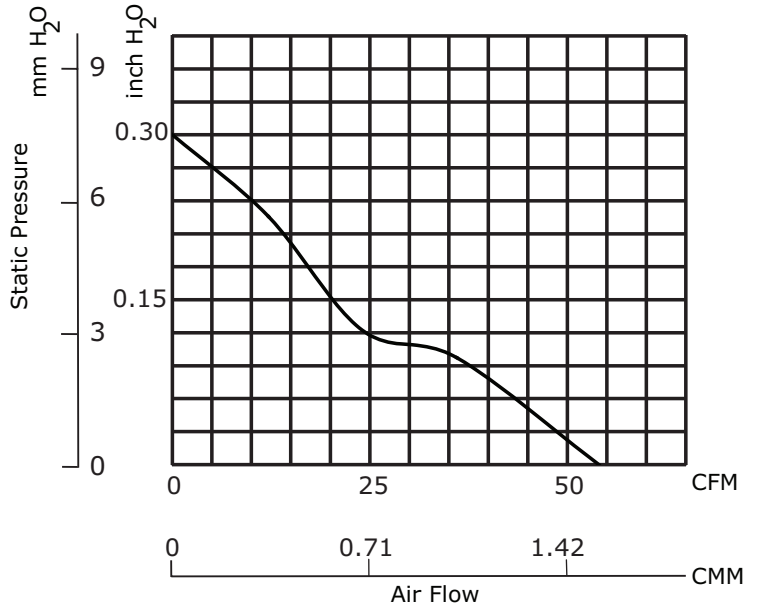

**CFM-8025V-245-450**

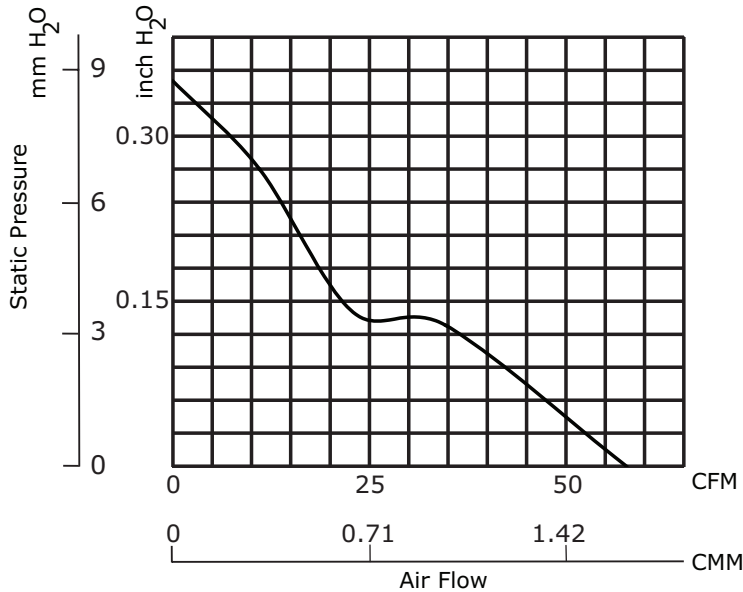

**CFM-8025V-442-435**

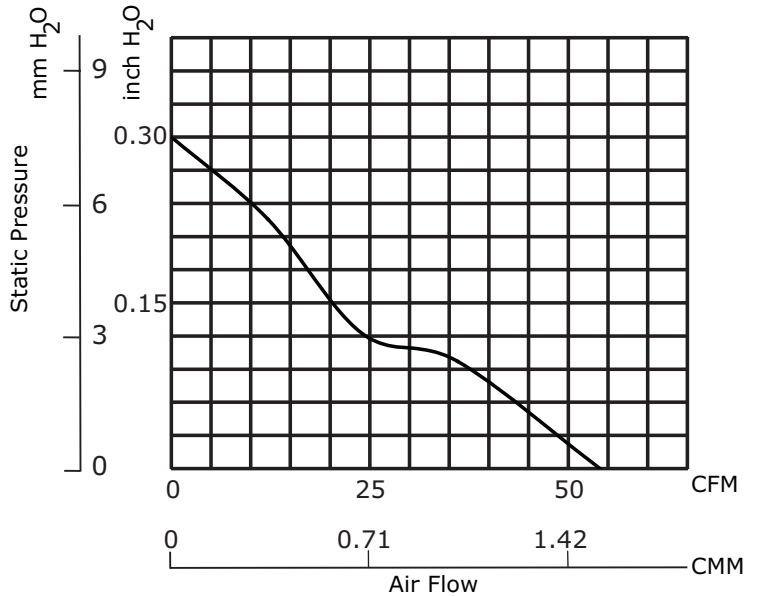

## PERFORMANCE CURVES (CONTINUED)

### CFM-8025V-445-450

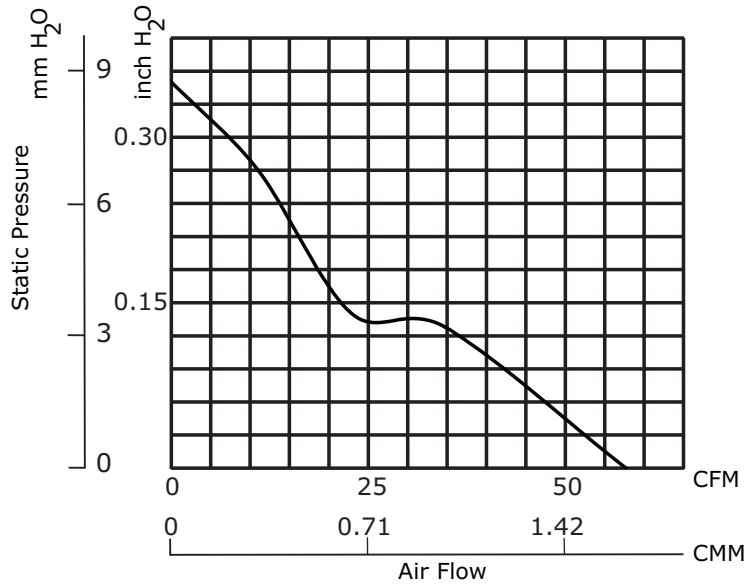

## MECHANICAL

parameter	conditions/description	min	typ	max	units
motor	4 pole DC brushless				
bearing system	omniCOOL™				
direction of rotation	counter-clockwise viewed from front of fan blade				
dimensions	CFM-8015V models: 80 x 80 x 15 CFM-8020V models: 80 x 80 x 20 CFM-8025V models: 80 x 80 x 25				mm mm mm
material	PBT (UL94V-0)				
weight	CFM-8015V models		68		g
	CFM-8020V, 3900~4600 RPM models		85		g
	CFM-8020V, all other models		66		g
	CFM-8025V, 4200~4600 RPM models		91		g
	CFM-8025V, all other models		75		g

## MECHANICAL DRAWINGS

units: mm

wire: UL 1007, 24 AWG

MOUNTING SCREW (Pan Head)			
Screw Type	Size	Standard	Torque
Machine Screw	M4	JIS B1111-1974	3~4 kgf-cm
Self-tapping Screw	M5	JIS B1122 Type 2	6~8 kgf-cm

### CFM-8015V

WIRE CONNECTIONS	
Wire Color	Function
Red	+Vin
Black	-Vin
White <sup>1</sup>	RD Signal
Yellow <sup>1</sup>	Tach Signal

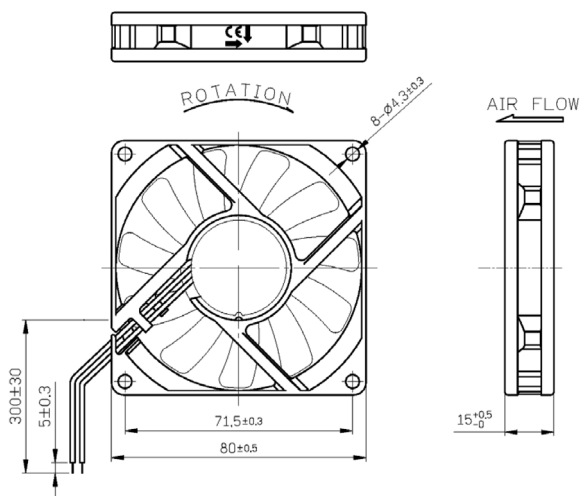

### CFM-8020V

WIRE CONNECTIONS	
Wire Color	Function
Red	+Vin
Black	-Vin
White <sup>1</sup>	RD Signal
Yellow <sup>1</sup>	Tach Signal

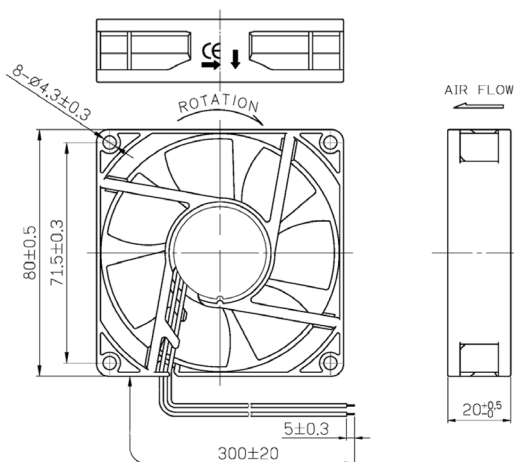

Notes: 1. Wires only present on versions with output signals.

## MECHANICAL DRAWINGS (CONTINUED)

units: mm

wire: UL 1007, 24 AWG

MOUNTING SCREW (Pan Head)			
Screw Type	Size	Standard	Torque
Machine Screw	M4	JIS B1111-1974	3~4 kgf-cm
Self-tapping Screw	M5	JIS B1122 Type 2	6~8 kgf-cm

### CFM-8025V

WIRE CONNECTIONS	
Wire Color	Function
Red	+Vin
Black	-Vin
White <sup>1</sup>	RD Signal
Yellow <sup>1</sup>	Tach Signal

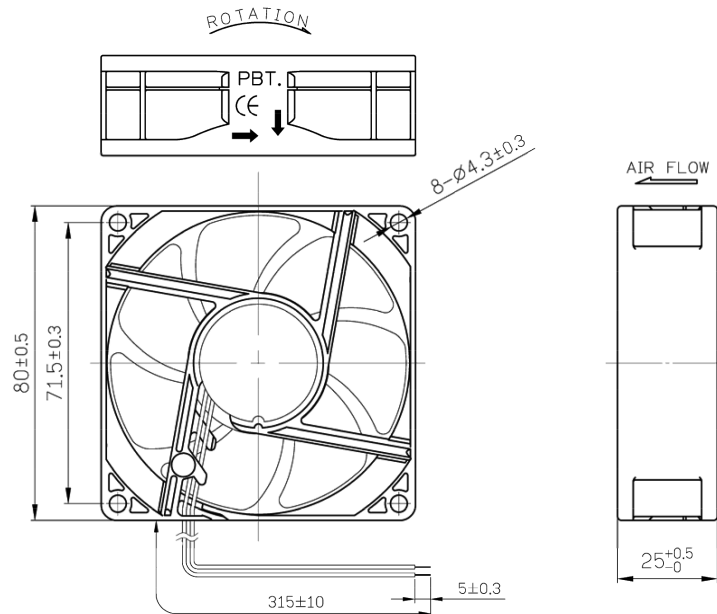

Notes: 1. Wires only present on versions with output signals.  
 2. CFM-8025V-242-435, CFM-8025V-245-450, CFM-8025V-442-435, & CFM-8025V-445-450 have 300 ± 20 mm lead wires.

## APPLICATION NOTES

### Auto Restart Protection

When the fan motor is locked by an external force, the device will temporarily turn off electrical power to the motor and restart automatically when the locked rotor condition is released.

**Figure 1: Auto Start Protection**

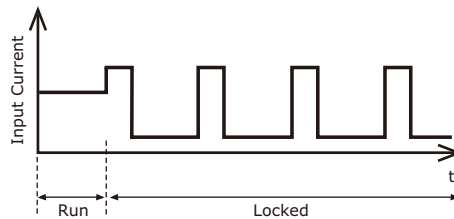

### Rotation Detector Signal (White Wire)

The rotation detector signal is used to detect if the fan motor is operating or stopped. The output will be logical low (VL) when fan is operating and be logical high (Vcc) when fan motor is locked. (See Figures 2~3 below).

**Figure 2: Rotation Detector Output Waveform**

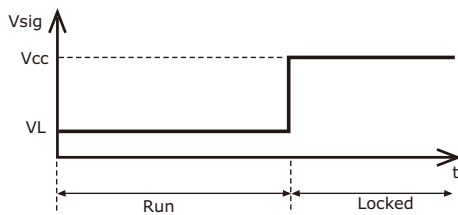

**Figure 3: Rotation Detector Output Circuit**

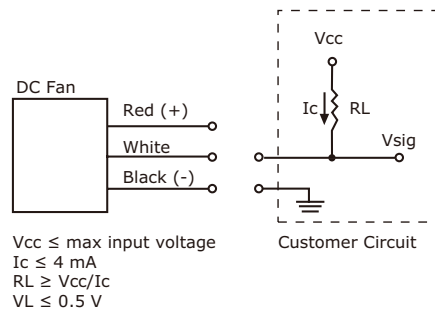

### Tachometer Signal (Yellow Wire)

The tachometer signal is for detecting the rotational speed of the fan motor. The output will be a square wave when fan is operating and logical high (Vcc) when fan motor is locked (See Figures 4~5 below). The relationship between RPM & output pulses from the signal wire is as follows.

$$1 \text{ RPM} = 2 \text{ Pulses}$$

**Figure 4: Tachometer Output Waveform**

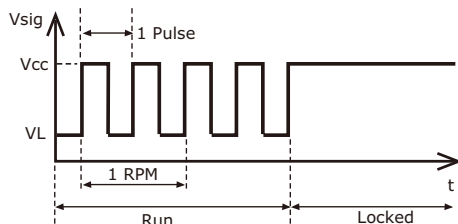

**Figure 5: Tachometer Output Circuit**

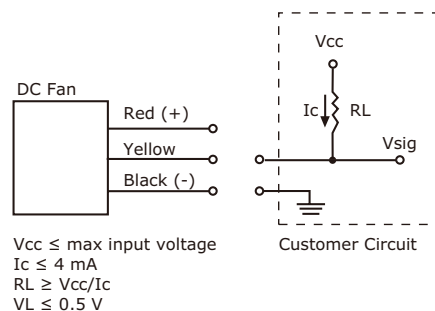

## SAFETY CONSIDERATIONS

---

1. Do not use or operate this fan in excess of the limitations set forth in this specification. CUI is not responsible for the non-performance of this fan and/or any damages resulting from its use, if it is not used or operated in accordance with the specifications.
2. CUI recommends adding a protection circuit to the product or application in which this fan is installed, such as a thermo-fuse, or current fuse or thermo-protector. The failure to use such a device may result in smoke, fire, electric shock by insulation degradation in cases of motor lead short circuit, overload, or over voltage, and/or other failure.
3. CUI recommends installing a protection device to the product or application in which this fan is installed if there is a possibility of reverse connection between Vdc (+) and GND (-). The failure to install such a device may result in smoke, fire, and/or destruction, although these conditions may not manifest immediately.
4. This fan must be installed and used in compliance with all applicable safety standards and regulations.
5. Use proper care when handling and/or installing this fan. Improper handling of installation of this fan may cause damage that could result in unsafe conditions.
6. Use proper care during installation and/or wiring. Failure to use proper care may cause damage to certain components of the fan including, but not limited to, the coil and lead wires, which could result in smoke and/or fire.
7. Do not use power or ground PWM to control the fan speed. If the fan speed needs to be adjusted, please contact CUI to customize the product design for your application.
8. For critical or extreme environments, including non-stop operation, please contact CUI and we will gladly provide assistance with your product selection to ensure an appropriate cooling product for your application.
9. When building your device, please examine thoroughly any variation of EMC, temperature rise, life data, quality, etc. of this product by shock/drop/vibration testing, etc. If there are any problems or accidents in connection with this product, it should be mutually discussed and examined.
10. Use proper care when handling these fans. Components such as fan holders or bearings may be damaged, if touched with fingers or other objects. Additionally, static electricity (ESD) may damage internal circuits of the fan.
11. Do not operate these fans in proximity to hazardous materials such as organic silicon, cyanogens, formalin, phenol, or corrosive gas environments including, but not limited to,  $H_2S$ ,  $SO_2$ ,  $NO_2$ , or  $Cl_2$ .
12. CUI recommends that you protect these fans from exposure to outside elements such as dust, condensation, humidity, or insects. Exposure of this fan to such elements may affect its performance and may cause safety hazards. CUI does not warrant against damage to the product caused by outside elements.
13. The fans must be installed properly and securely. Improper mounting may cause harsh resonance, vibration, and noise.
14. Do not store these fans in an environment with high humidity. These fans must be stored in accordance with the specified storage temperature.
15. CUI reserves the right to use components from multiple sources at its discretion. The use of components from other sources will not affect the specifications as described herein.
16. The life expectancy of these fans has not been evaluated for use in combination with any end application. Therefore, the life expectancy that relate to these fans are only for reference.

## REVISION HISTORY

---

rev.	description	date
1.0	initial release	07/26/2017
1.01	discontinued CFM-8020V-139-430, CFM-8020V-142-450, CFM-8020V-146-480, CFM-8025V-442-435, CFM-8025V-445-450 models	09/12/2018
1.02	discontinued CFM-8025V-242-435, CFM-8025V-245-450 models	03/18/2019
1.03	brand update	02/10/2020

The revision history provided is for informational purposes only and is believed to be accurate.

---

# CUI DEVICES

CUI Devices offers a one (1) year limited warranty. Complete warranty information is listed on our website.

CUI Devices reserves the right to make changes to the product at any time without notice. Information provided by CUI Devices is believed to be accurate and reliable. However, no responsibility is assumed by CUI Devices for its use, nor for any infringements of patents or other rights of third parties which may result from its use.

CUI Devices products are not authorized or warranted for use as critical components in equipment that requires an extremely high level of reliability. A critical component is any component of a life support device or system whose failure to perform can be reasonably expected to cause the failure of the life support device or system, or to affect its safety or effectiveness.





Компания «ЭлектроПласт» предлагает заключение долгосрочных отношений при поставках импортных электронных компонентов на взаимовыгодных условиях!

Наши преимущества:

- Оперативные поставки широкого спектра электронных компонентов отечественного и импортного производства напрямую от производителей и с крупнейших мировых складов;
- Поставка более 17-ти миллионов наименований электронных компонентов;
- Поставка сложных, дефицитных, либо снятых с производства позиций;
- Оперативные сроки поставки под заказ (от 5 рабочих дней);
- Экспресс доставка в любую точку России;
- Техническая поддержка проекта, помощь в подборе аналогов, поставка прототипов;
- Система менеджмента качества сертифицирована по Международному стандарту ISO 9001;
- Лицензия ФСБ на осуществление работ с использованием сведений, составляющих государственную тайну;
- Поставка специализированных компонентов (Xilinx, Altera, Analog Devices, Intersil, Interpoint, Microsemi, Aeroflex, Peregrine, Syfer, Eurofarad, Texas Instrument, Miteq, Cobham, E2V, MA-COM, Hittite, Mini-Circuits, General Dynamics и др.);

Помимо этого, одним из направлений компании «ЭлектроПласт» является направление «Источники питания». Мы предлагаем Вам помощь Конструкторского отдела:

- Подбор оптимального решения, техническое обоснование при выборе компонента;
- Подбор аналогов;
- Консультации по применению компонента;
- Поставка образцов и прототипов;
- Техническая поддержка проекта;
- Защита от снятия компонента с производства.



#### Как с нами связаться

**Телефон:** 8 (812) 309 58 32 (многоканальный)

**Факс:** 8 (812) 320-02-42

**Электронная почта:** [org@eplast1.ru](mailto:org@eplast1.ru)

**Адрес:** 198099, г. Санкт-Петербург, ул. Калинина, дом 2, корпус 4, литера А.