

EFM[®]32

... the world's most energy friendly microcontrollers

EFM32ZG222 DATASHEET

F32/F16/F8/F4

Preliminary

- **ARM Cortex-M0+ CPU platform**
 - High Performance 32-bit processor @ up to 24 MHz
 - Wake-up Interrupt Controller
- **Flexible Energy Management System**
 - 20 nA @ 3 V Shutoff Mode
 - 0.5 μ A @ 3 V Stop Mode, including Power-on Reset, Brown-out Detector, RAM and CPU retention
 - 0.9 μ A @ 3 V Deep Sleep Mode, including RTC with 32.768 kHz oscillator, Power-on Reset, Brown-out Detector, RAM and CPU retention
 - 46 μ A/MHz @ 3 V Sleep Mode
 - 114 μ A/MHz @ 3 V Run Mode, with code executed from flash
- **32/16/8/4 KB Flash**
- **4/4/2/2 KB RAM**
- **37 General Purpose I/O pins**
 - Configurable push-pull, open-drain, pull-up/down, input filter, drive strength
 - Configurable peripheral I/O locations
 - 16 asynchronous external interrupts
 - Output state retention and wake-up from Shutoff Mode
- **4 Channel DMA Controller**
- **4 Channel Peripheral Reflex System (PRS) for autonomous inter-peripheral signaling**
- **Hardware AES with 128-bit keys in 54 cycles**
- **Timers/Counters**
 - 2x 16-bit Timer/Counter
 - 2x3 Compare/Capture/PWM channels
 - 1x 24-bit Real-Time Counter
 - 1x 16-bit Pulse Counter
 - Watchdog Timer with dedicated RC oscillator @ 50 nA
- **Communication interfaces**
 - 1x Universal Synchronous/Asynchronous Receiver/Transmitter
 - UART/SPI/SmartCard (ISO 7816)/IrDA/I2S
 - Triple buffered full/half-duplex operation
 - Low Energy UART
 - Autonomous operation with DMA in Deep Sleep Mode
 - I²C Interface with SMBus support
 - Address recognition in Stop Mode
- **Ultra low power precision analog peripherals**
 - 12-bit 1 Msamples/s Analog to Digital Converter
 - 4 single ended channels/ differential channels
 - On-chip temperature sensor
 - Current Digital to Analog Converter
 - Selectable current range between 0.05 and 64 μ A
 - 1x Analog Comparator
 - Capacitive sensing with up to 5 inputs
 - Supply Voltage Comparator
- **Ultra efficient Power-on Reset and Brown-Out Detector**
- **2-pin Serial Wire Debug interface**
- **Pre-Programmed UART Bootloader**
- **Temperature range -40 to 85 °C**
- **Single power supply 1.85 to 3.8 V**
- **TQFP48 package**

32-bit ARM Cortex-M0+, Cortex-M3 and Cortex-M4 microcontrollers for:

- Energy, gas, water and smart metering
- Health and fitness applications
- Smart accessories
- Alarm and security systems
- Industrial and home automation
- www.silabs.com



1 Ordering Information

Table 1.1 (p. 2) shows the available EFM32ZG222 devices.

Table 1.1. Ordering Information

Ordering Code	Flash (kB)	RAM (kB)	Max Speed (MHz)	Supply Voltage (V)	Temperature (°C)	Package
EFM32ZG222F4-QFP48	4	2	24	1.85 - 3.8	-40 - 85	TQFP48
EFM32ZG222F8-QFP48	8	2	24	1.85 - 3.8	-40 - 85	TQFP48
EFM32ZG222F16-QFP48	16	4	24	1.85 - 3.8	-40 - 85	TQFP48
EFM32ZG222F32-QFP48	32	4	24	1.85 - 3.8	-40 - 85	TQFP48

Visit www.silabs.com for information on global distributors and representatives.

2 System Summary

2.1 System Introduction

The EFM32 MCUs are the world's most energy friendly microcontrollers. With a unique combination of the powerful 32-bit ARM Cortex-M0+, innovative low energy techniques, short wake-up time from energy saving modes, and a wide selection of peripherals, the EFM32ZG microcontroller is well suited for any battery operated application as well as other systems requiring high performance and low-energy consumption. This section gives a short introduction to each of the modules in general terms and also shows a summary of the configuration for the EFM32ZG222 devices. For a complete feature set and in-depth information on the modules, the reader is referred to the *EFM32ZG Reference Manual*.

A block diagram of the EFM32ZG222 is shown in Figure 2.1 (p. 3) .

Figure 2.1. Block Diagram

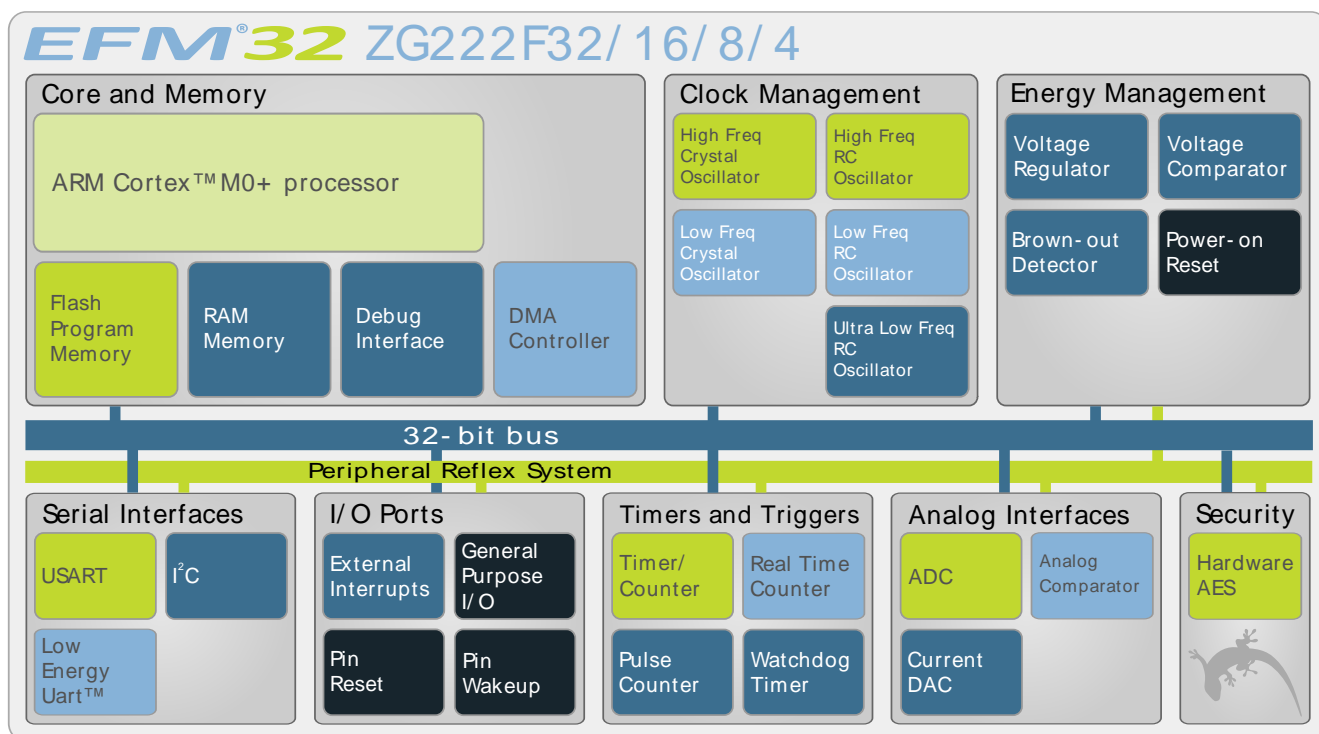

2.1.1 ARM Cortex-M0+ Core

The ARM Cortex-M0+ includes a 32-bit RISC processor which can achieve as much as 0.9 Dhrystone MIPS/MHz. A Wake-up Interrupt Controller handling interrupts triggered while the CPU is asleep is included as well. The EFM32 implementation of the Cortex-M0+ is described in detail in *ARM Cortex-M0+ Devices Generic User Guide*.

2.1.2 Debug Interface (DBG)

This device includes hardware debug support through a 2-pin serial-wire debug interface.

2.1.3 Memory System Controller (MSC)

The Memory System Controller (MSC) is the program memory unit of the EFM32ZG microcontroller. The flash memory is readable and writable from both the Cortex-M0+ and DMA. The flash memory is divided into two blocks; the main block and the information block. Program code is normally written to the main block. Additionally, the information block is available for special user data and flash lock bits. There is also a read-only page in the information block containing system and device calibration data. Read and write operations are supported in the energy modes EM0 and EM1.

2.1.4 Direct Memory Access Controller (DMA)

The Direct Memory Access (DMA) controller performs memory operations independently of the CPU. This has the benefit of reducing the energy consumption and the workload of the CPU, and enables the system to stay in low energy modes when moving for instance data from the USART to RAM or from the External Bus Interface to a PWM-generating timer. The DMA controller uses the PL230 μ DMA controller licensed from ARM.

2.1.5 Reset Management Unit (RMU)

The RMU is responsible for handling the reset functionality of the EFM32ZG.

2.1.6 Energy Management Unit (EMU)

The Energy Management Unit (EMU) manage all the low energy modes (EM) in EFM32ZG microcontrollers. Each energy mode manages if the CPU and the various peripherals are available. The EMU can also be used to turn off the power to unused SRAM blocks.

2.1.7 Clock Management Unit (CMU)

The Clock Management Unit (CMU) is responsible for controlling the oscillators and clocks on-board the EFM32ZG. The CMU provides the capability to turn on and off the clock on an individual basis to all peripheral modules in addition to enable/disable and configure the available oscillators. The high degree of flexibility enables software to minimize energy consumption in any specific application by not wasting power on peripherals and oscillators that are inactive.

2.1.8 Watchdog (WDOG)

The purpose of the watchdog timer is to generate a reset in case of a system failure, to increase application reliability. The failure may e.g. be caused by an external event, such as an ESD pulse, or by a software failure.

2.1.9 Peripheral Reflex System (PRS)

The Peripheral Reflex System (PRS) system is a network which lets the different peripheral module communicate directly with each other without involving the CPU. Peripheral modules which send out Reflex signals are called producers. The PRS routes these reflex signals to consumer peripherals which apply actions depending on the data received. The format for the Reflex signals is not given, but edge triggers and other functionality can be applied by the PRS.

2.1.10 Inter-Integrated Circuit Interface (I2C)

The I²C module provides an interface between the MCU and a serial I²C-bus. It is capable of acting as both a master and a slave, and supports multi-master buses. Both standard-mode, fast-mode and fast-mode plus speeds are supported, allowing transmission rates all the way from 10 kbit/s up to 1 Mbit/s. Slave arbitration and timeouts are also provided to allow implementation of an SMBus compliant system. The interface provided to software by the I²C module, allows both fine-grained control of the transmission process and close to automatic transfers. Automatic recognition of slave addresses is provided in all energy modes.

2.1.11 Universal Synchronous/Asynchronous Receiver/Transmitter (USART)

The Universal Synchronous Asynchronous serial Receiver and Transmitter (USART) is a very flexible serial I/O module. It supports full duplex asynchronous UART communication as well as RS-485, SPI, MicroWire and 3-wire. It can also interface with ISO7816 SmartCards, IrDA and I2S devices.

2.1.12 Pre-Programmed UART Bootloader

The bootloader presented in application note AN0003 is pre-programmed in the device at factory. Auto-baud and destructive write are supported. The autobaud feature, interface and commands are described further in the application note.

2.1.13 Low Energy Universal Asynchronous Receiver/Transmitter (LEUART)

The unique LEUART[™], the Low Energy UART, is a UART that allows two-way UART communication on a strict power budget. Only a 32.768 kHz clock is needed to allow UART communication up to 9600 baud/s. The LEUART includes all necessary hardware support to make asynchronous serial communication possible with minimum of software intervention and energy consumption.

2.1.14 Timer/Counter (TIMER)

The 16-bit general purpose Timer has 3 compare/capture channels for input capture and compare/Pulse-Width Modulation (PWM) output.

2.1.15 Real Time Counter (RTC)

The Real Time Counter (RTC) contains a 24-bit counter and is clocked either by a 32.768 kHz crystal oscillator, or a 32.768 kHz RC oscillator. In addition to energy modes EM0 and EM1, the RTC is also available in EM2. This makes it ideal for keeping track of time since the RTC is enabled in EM2 where most of the device is powered down.

2.1.16 Pulse Counter (PCNT)

The Pulse Counter (PCNT) can be used for counting pulses on a single input or to decode quadrature encoded inputs. It runs off either the internal LFACLK or the PCNTn_S0IN pin as external clock source. The module may operate in energy mode EM0 – EM3.

2.1.17 Analog Comparator (ACMP)

The Analog Comparator is used to compare the voltage of two analog inputs, with a digital output indicating which input voltage is higher. Inputs can either be one of the selectable internal references or from external pins. Response time and thereby also the current consumption can be configured by altering the current supply to the comparator.

2.1.18 Voltage Comparator (VCMP)

The Voltage Supply Comparator is used to monitor the supply voltage from software. An interrupt can be generated when the supply falls below or rises above a programmable threshold. Response time and thereby also the current consumption can be configured by altering the current supply to the comparator.

2.1.19 Analog to Digital Converter (ADC)

The ADC is a Successive Approximation Register (SAR) architecture, with a resolution of up to 12 bits at up to one million samples per second. The integrated input mux can select inputs from 4 external pins and 6 internal signals.

2.1.20 Current Digital to Analog Converter (IDAC)

The current digital to analog converter can source or sink a configurable constant current, which can be output on, or sinked from pin or ADC. The current is configurable with several ranges of various step sizes.

2.1.21 Advanced Encryption Standard Accelerator (AES)

The AES accelerator performs AES encryption and decryption with 128-bit. Encrypting or decrypting one 128-bit data block takes 52 HFCORECLK cycles with 128-bit keys. The AES module is an AHB slave which enables efficient access to the data and key registers. All write accesses to the AES module must be 32-bit operations, i.e. 8- or 16-bit operations are not supported.

2.1.22 General Purpose Input/Output (GPIO)

In the EFM32ZG222, there are 37 General Purpose Input/Output (GPIO) pins, which are divided into ports with up to 16 pins each. These pins can individually be configured as either an output or input. More advanced configurations like open-drain, filtering and drive strength can also be configured individually for the pins. The GPIO pins can also be overridden by peripheral pin connections, like Timer PWM outputs or USART communication, which can be routed to several locations on the device. The GPIO supports up to 16 asynchronous external pin interrupts, which enables interrupts from any pin on the device. Also, the input value of a pin can be routed through the Peripheral Reflex System to other peripherals.

2.2 Configuration Summary

The features of the EFM32ZG222 is a subset of the feature set described in the EFM32ZG Reference Manual. Table 2.1 (p. 6) describes device specific implementation of the features.

Table 2.1. Configuration Summary

Module	Configuration	Pin Connections
Cortex-M0+	Full configuration	NA
DBG	Full configuration	DBG_SWCLK, DBG_SWDIO,
MSC	Full configuration	NA
DMA	Full configuration	NA
RMU	Full configuration	NA
EMU	Full configuration	NA
CMU	Full configuration	CMU_OUT0, CMU_OUT1
WDOG	Full configuration	NA
PRS	Full configuration	NA
I2C0	Full configuration	I2C0_SDA, I2C0_SCL
USART0	Full configuration with IrDA and I2S	US0_TX, US0_RX, US0_CLK, US0_CS
LEUART0	Full configuration	LEU0_TX, LEU0_RX
TIMER0	Full configuration	TIM0_CC[2:0]
TIMER1	Full configuration	TIM1_CC[2:0]
RTC	Full configuration	NA
PCNT0	Full configuration, 16-bit count register	PCNT0_S[1:0]
ACMP0	Full configuration	ACMP0_CH[4:0], ACMP0_O
VCMP	Full configuration	NA
ADC0	Full configuration	ADC0_CH[3:0]
IDAC0	Full configuration	IDAC0_OUT
AES	Full configuration	NA

Module	Configuration	Pin Connections
GPIO	37 pins	Available pins are shown in Table 4.3 (p. 52)

2.3 Memory Map

The EFM32ZG222 memory map is shown in Figure 2.2 (p. 7), with RAM and Flash sizes for the largest memory configuration.

Figure 2.2. EFM32ZG222 Memory Map with largest RAM and Flash sizes

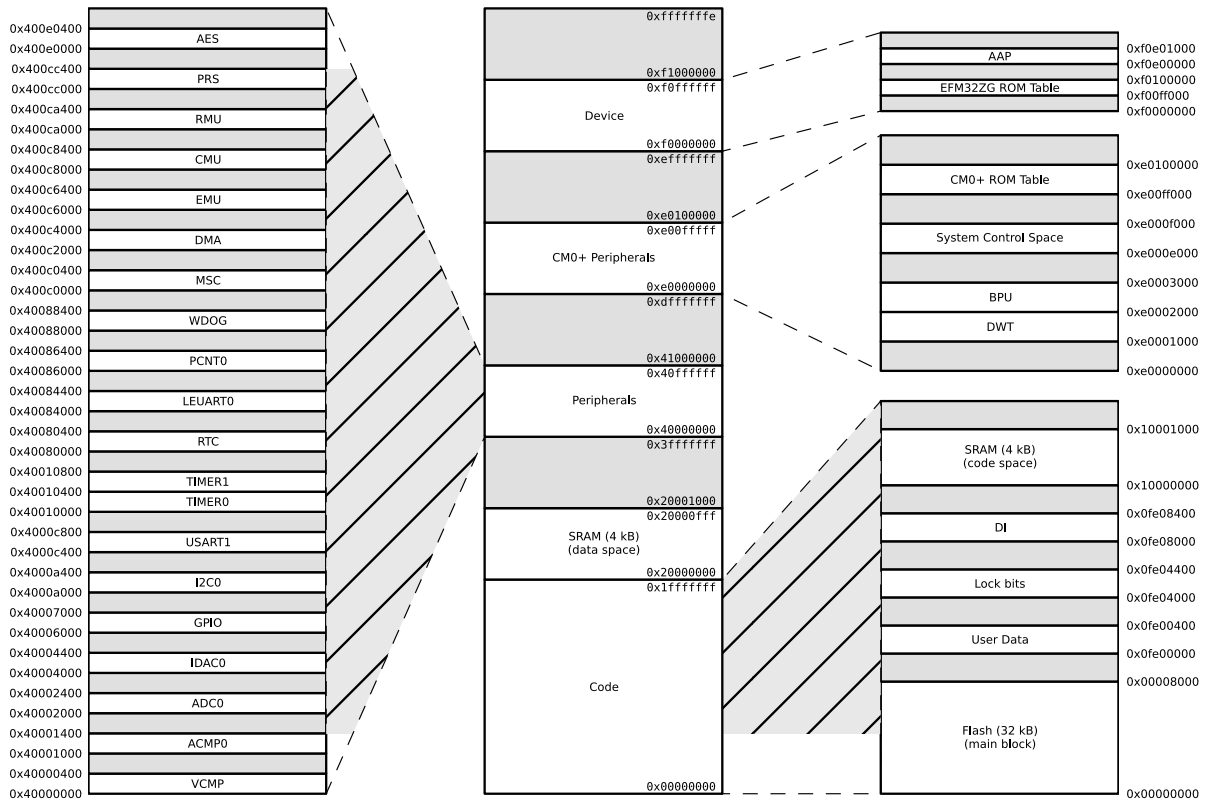

3 Electrical Characteristics

3.1 Test Conditions

3.1.1 Typical Values

The typical data are based on $T_{AMB}=25^{\circ}\text{C}$ and $V_{DD}=3.0\text{ V}$, as defined in Table 3.2 (p. 8), by simulation and/or technology characterisation unless otherwise specified.

3.1.2 Minimum and Maximum Values

The minimum and maximum values represent the worst conditions of ambient temperature, supply voltage and frequencies, as defined in Table 3.2 (p. 8), by simulation and/or technology characterisation unless otherwise specified.

3.2 Absolute Maximum Ratings

The absolute maximum ratings are stress ratings, and functional operation under such conditions are not guaranteed. Stress beyond the limits specified in Table 3.1 (p. 8) may affect the device reliability or cause permanent damage to the device. Functional operating conditions are given in Table 3.2 (p. 8).

Table 3.1. Absolute Maximum Ratings

Symbol	Parameter	Condition	Min	Typ	Max	Unit
T_{STG}	Storage temperature range		-40		150 ¹	$^{\circ}\text{C}$
T_S	Maximum soldering temperature	Latest IPC/JEDEC J-STD-020 Standard			260	$^{\circ}\text{C}$
V_{DDMAX}	External main supply voltage		0		3.8	V
V_{IOPIN}	Voltage on any I/O pin		-0.3		$V_{DD}+0.3$	V

¹Based on programmed devices tested for 10000 hours at 150 $^{\circ}\text{C}$. Storage temperature affects retention of preprogrammed calibration values stored in flash. Please refer to the Flash section in the Electrical Characteristics for information on flash data retention for different temperatures.

3.3 General Operating Conditions

3.3.1 General Operating Conditions

Table 3.2. General Operating Conditions

Symbol	Parameter	Min	Typ	Max	Unit
T_{AMB}	Ambient temperature range	-40		85	$^{\circ}\text{C}$
V_{DDOP}	Operating supply voltage	1.85		3.8	V
f_{APB}	Internal APB clock frequency			24	MHz
f_{AHB}	Internal AHB clock frequency			24	MHz

3.4 Current Consumption

Table 3.3. Current Consumption

Symbol	Parameter	Condition	Min	Typ	Max	Unit
I_{EM0}	EM0 current. No prescaling. Running prime number calculation code from Flash.	24 MHz HFXO, all peripheral clocks disabled, $V_{DD}= 3.0\text{ V}$		114.9		$\mu\text{A}/\text{MHz}$
		21 MHz HFRCO, all peripheral clocks disabled, $V_{DD}= 3.0\text{ V}$		114.4		$\mu\text{A}/\text{MHz}$
		14 MHz HFRCO, all peripheral clocks disabled, $V_{DD}= 3.0\text{ V}$		116.6		$\mu\text{A}/\text{MHz}$
		11 MHz HFRCO, all peripheral clocks disabled, $V_{DD}= 3.0\text{ V}$		118.2		$\mu\text{A}/\text{MHz}$
		6.6 MHz HFRCO, all peripheral clocks disabled, $V_{DD}= 3.0\text{ V}$		123.5		$\mu\text{A}/\text{MHz}$
		1.2 MHz HFRCO, all peripheral clocks disabled, $V_{DD}= 3.0\text{ V}$		155.1		$\mu\text{A}/\text{MHz}$
I_{EM1}	EM1 current	24 MHz HFXO, all peripheral clocks disabled, $V_{DD}= 3.0\text{ V}$		48.0		$\mu\text{A}/\text{MHz}$
		21 MHz HFRCO, all peripheral clocks disabled, $V_{DD}= 3.0\text{ V}$		48.1		$\mu\text{A}/\text{MHz}$
		14 MHz HFRCO, all peripheral clocks disabled, $V_{DD}= 3.0\text{ V}$		50.1		$\mu\text{A}/\text{MHz}$
		11 MHz HFRCO, all peripheral clocks disabled, $V_{DD}= 3.0\text{ V}$		51.8		$\mu\text{A}/\text{MHz}$
		6.6 MHz HFRCO, all peripheral clocks disabled, $V_{DD}= 3.0\text{ V}$		57.1		$\mu\text{A}/\text{MHz}$
		1.2 MHz HFRCO. all peripheral clocks disabled, $V_{DD}= 3.0\text{ V}$		89.1		$\mu\text{A}/\text{MHz}$
I_{EM2}	EM2 current	EM2 current with RTC at 1 Hz, RTC prescaled to 1kHz, 32.768 kHz LFRCO, $V_{DD}= 3.0\text{ V}$, $T_{AMB}=25^{\circ}\text{C}$		0.86		μA
		EM2 current with RTC at 1 Hz, RTC prescaled to 1kHz, 32.768 kHz LFRCO, $V_{DD}= 3.0\text{ V}$, $T_{AMB}=85^{\circ}\text{C}$		1.66		μA
I_{EM3}	EM3 current	$V_{DD}= 3.0\text{ V}$, $T_{AMB}=25^{\circ}\text{C}$		0.49		μA
		$V_{DD}= 3.0\text{ V}$, $T_{AMB}=85^{\circ}\text{C}$		1.26		μA
I_{EM4}	EM4 current	$V_{DD}= 3.0\text{ V}$, $T_{AMB}=25^{\circ}\text{C}$		0.02		μA
		$V_{DD}= 3.0\text{ V}$, $T_{AMB}=85^{\circ}\text{C}$		0.29		μA

3.4.1 EM0 Current Consumption

Figure 3.1. EM0 Current consumption while executing prime number calculation code from flash with HFRCO running at 24MHz

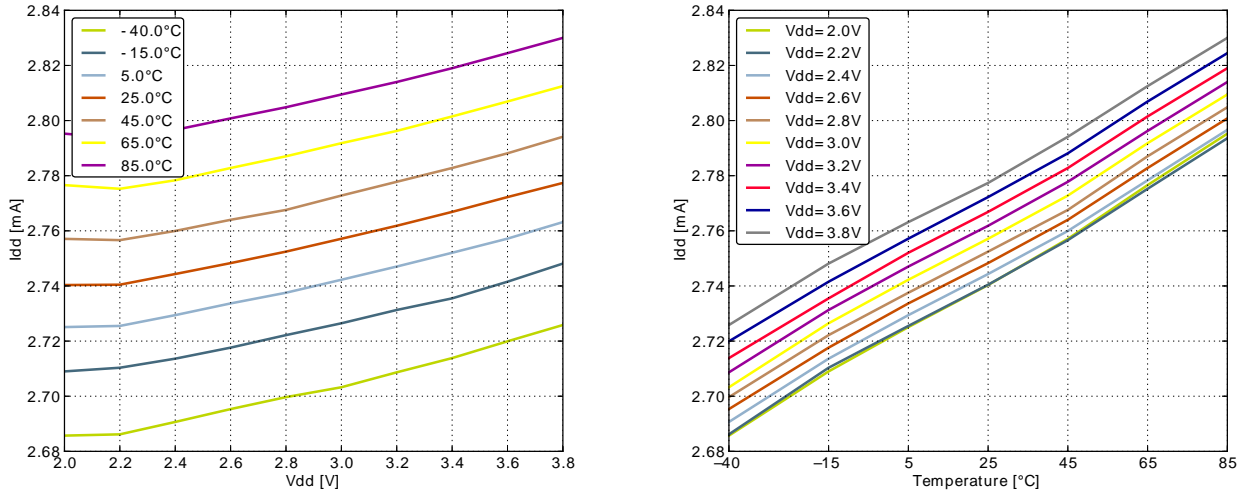

Figure 3.2. EM0 Current consumption while executing prime number calculation code from flash with HFRCO running at 21MHz

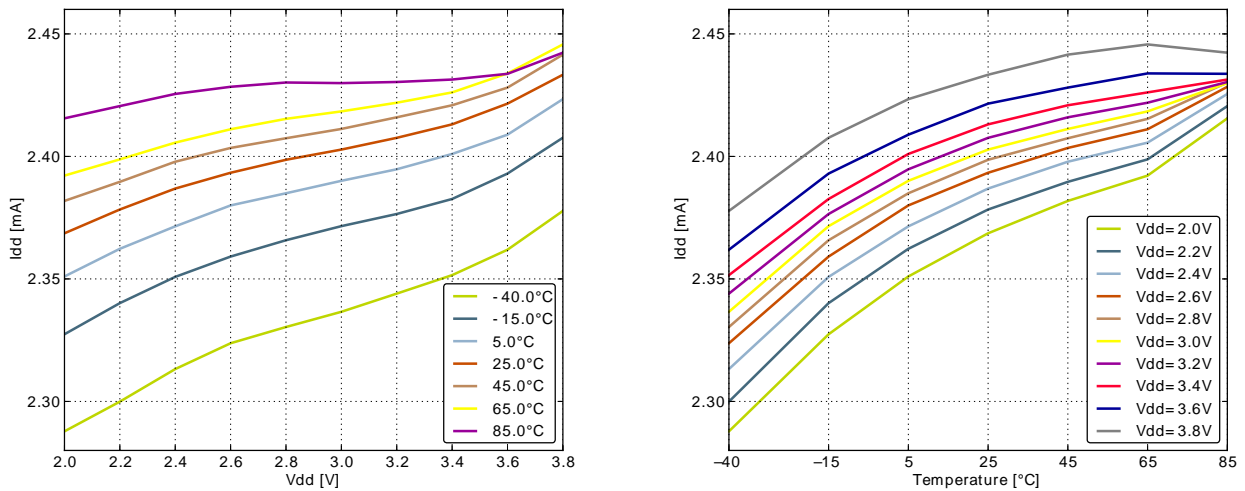

Figure 3.3. EM0 Current consumption while executing prime number calculation code from flash with HFRCO running at 14MHz

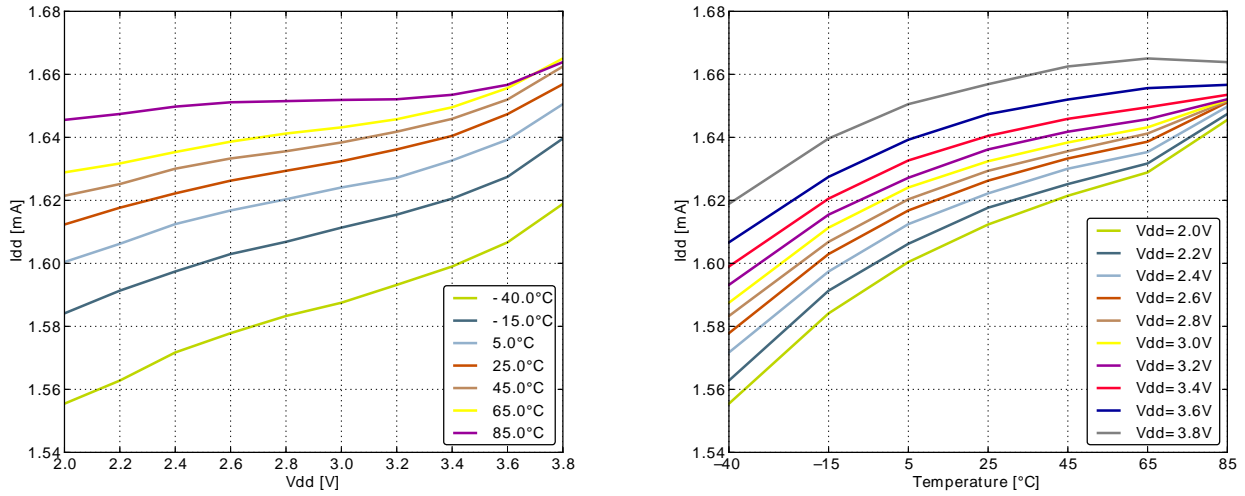

Figure 3.4. EM0 Current consumption while executing prime number calculation code from flash with HFRCO running at 11MHz

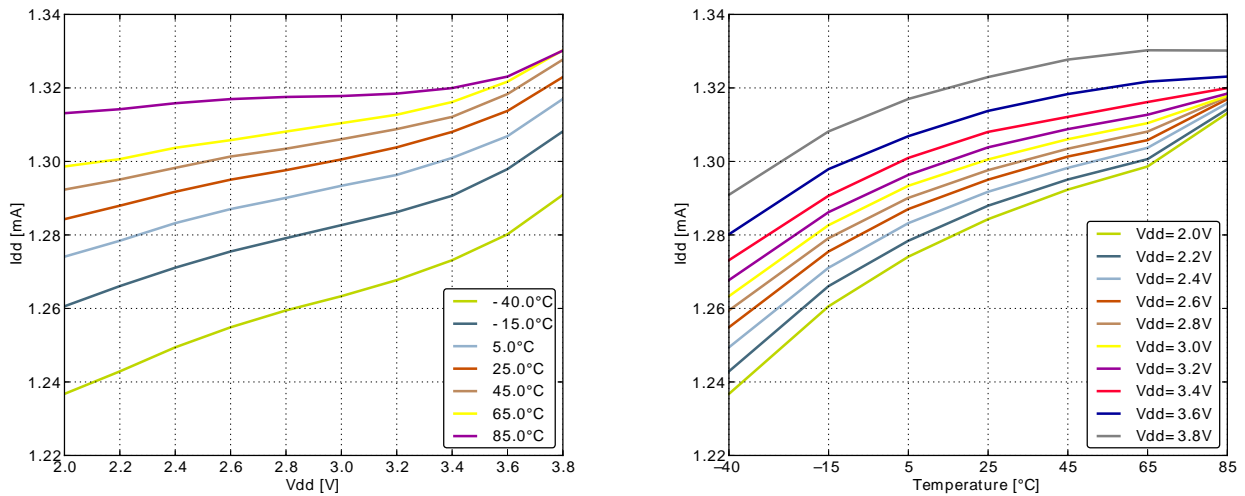
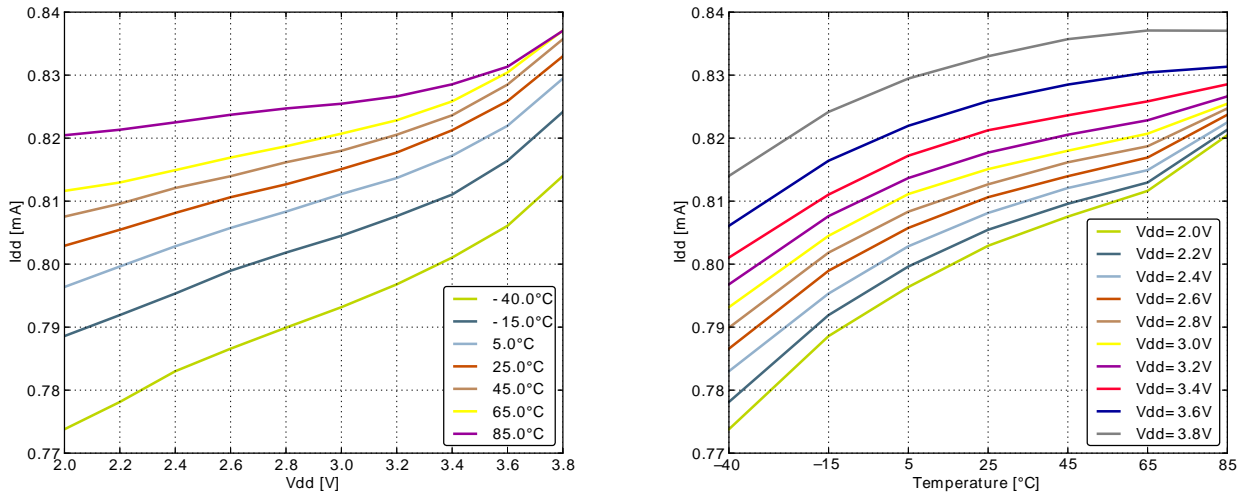

Figure 3.5.



3.4.2 EM1 Current Consumption

Figure 3.6. EM1 Current consumption with all peripheral clocks disabled and HFRCO running at 24MHz

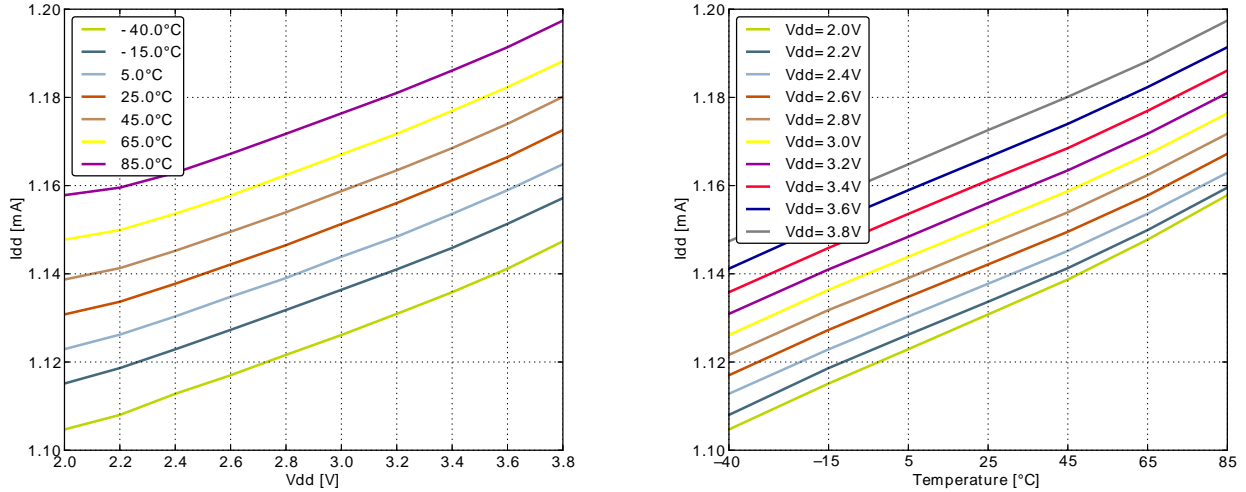

Figure 3.7. EM1 Current consumption with all peripheral clocks disabled and HFRCO running at 21MHz

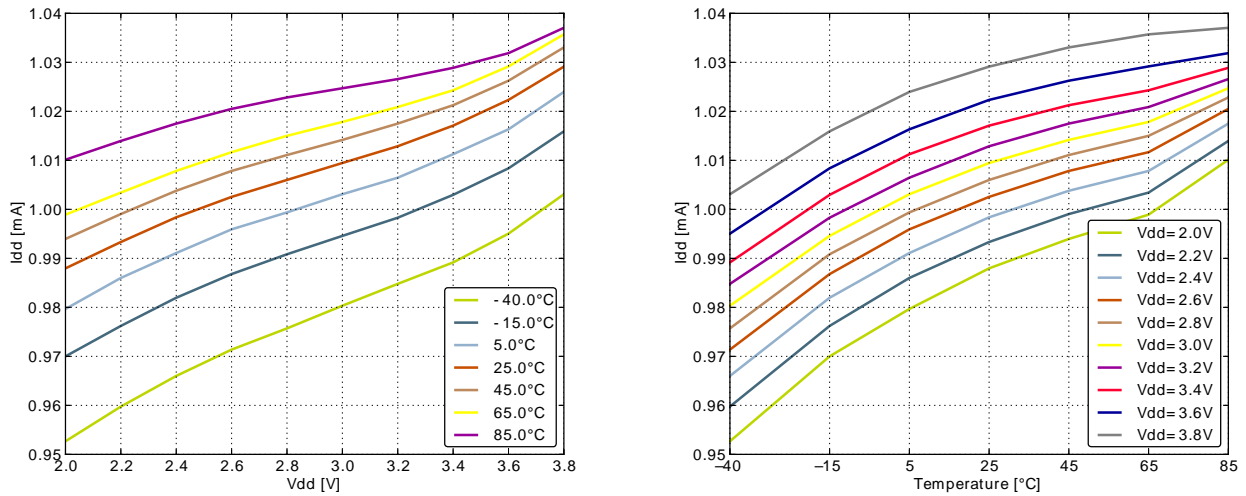

Figure 3.8. EM1 Current consumption with all peripheral clocks disabled and HFRCO running at 14MHz

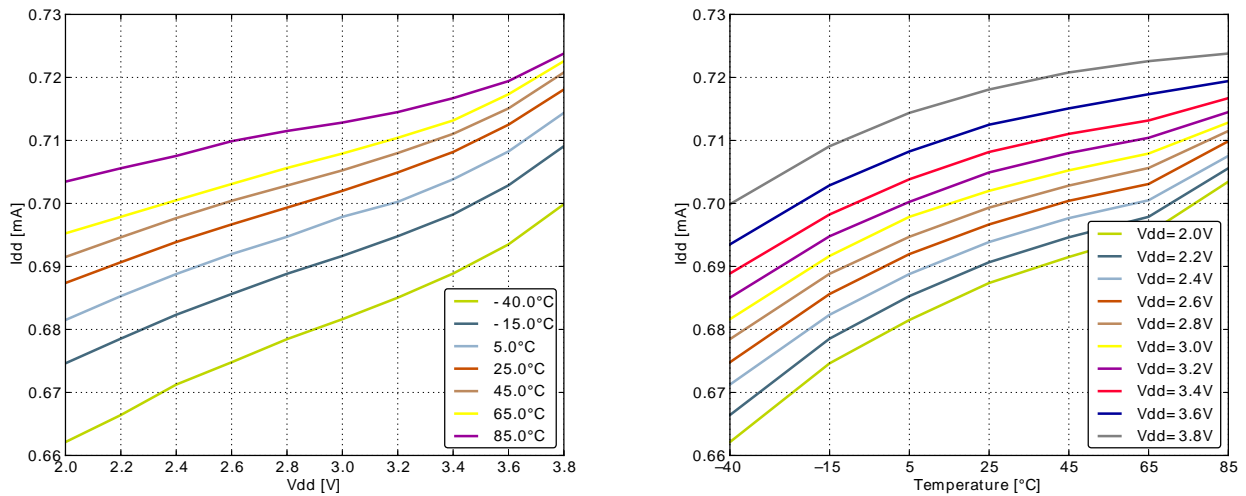

Figure 3.9. EM1 Current consumption with all peripheral clocks disabled and HFRCO running at 11MHz

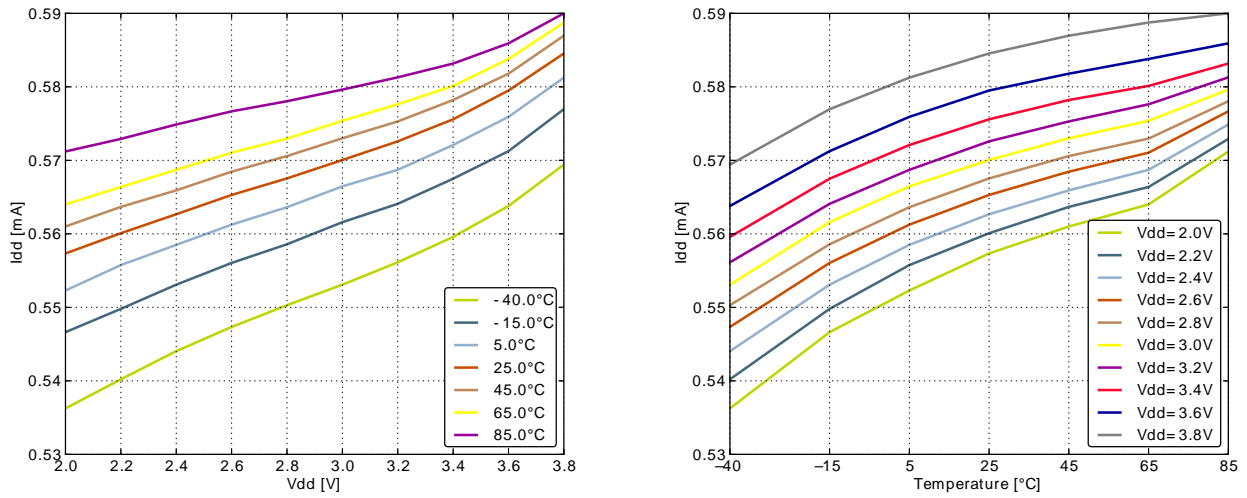
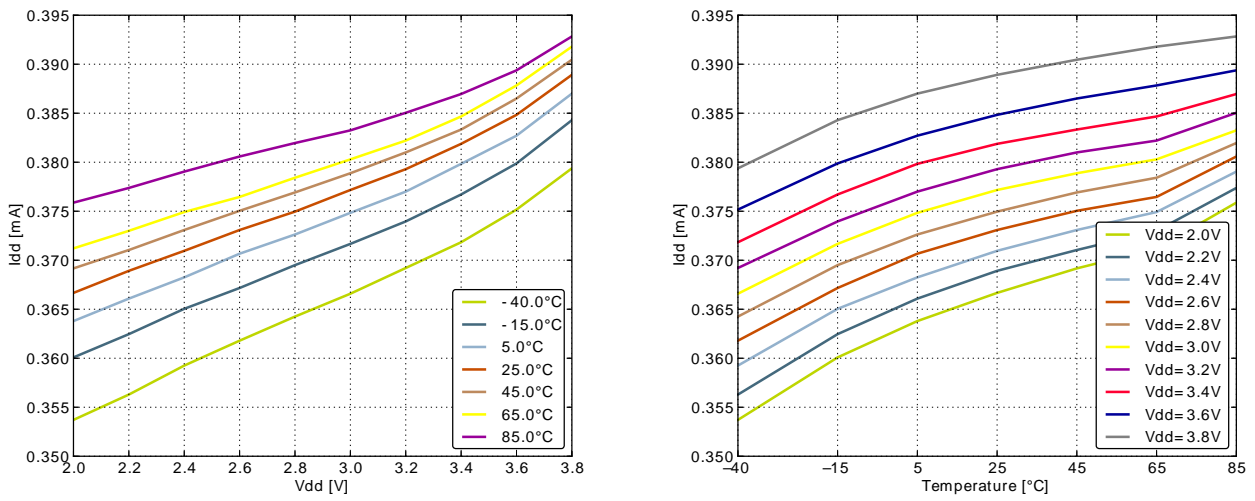
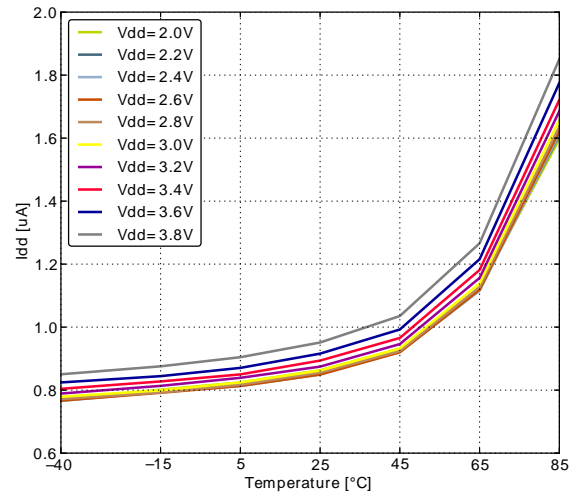
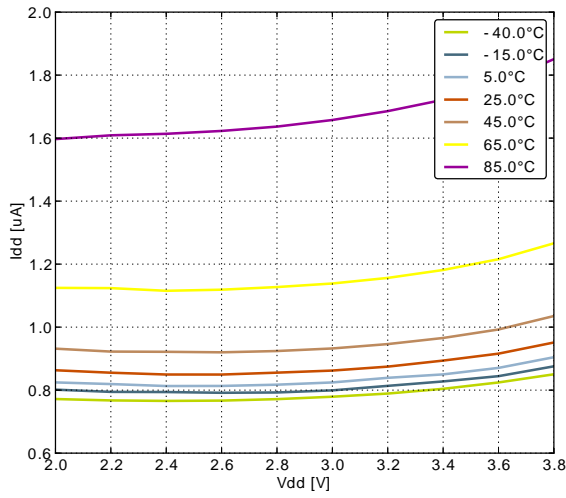

Figure 3.10.



3.4.3 EM2 Current Consumption

Figure 3.11. EM2 current consumption. RTC prescaled to 1kHz, 32.768 kHz LFRCO.



3.4.4 EM3 Current Consumption

Figure 3.12. EM3 current consumption.

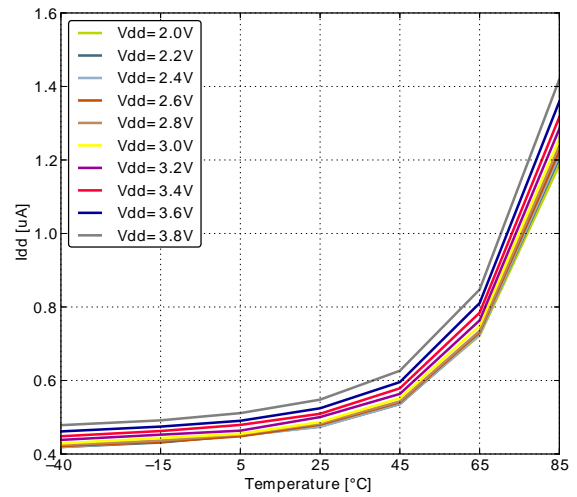
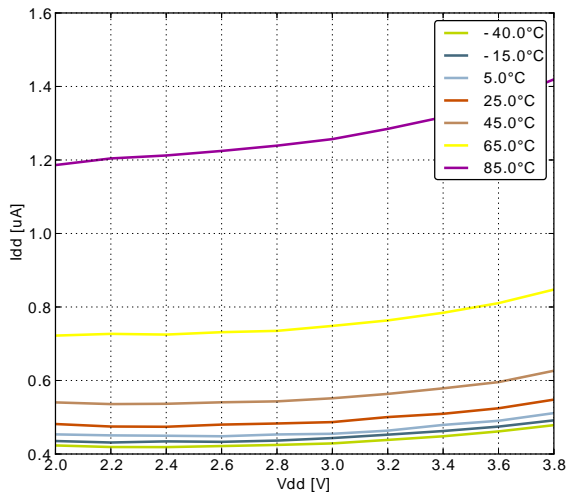

3.4.5 EM4 Current Consumption

Figure 3.13. EM4 current consumption.

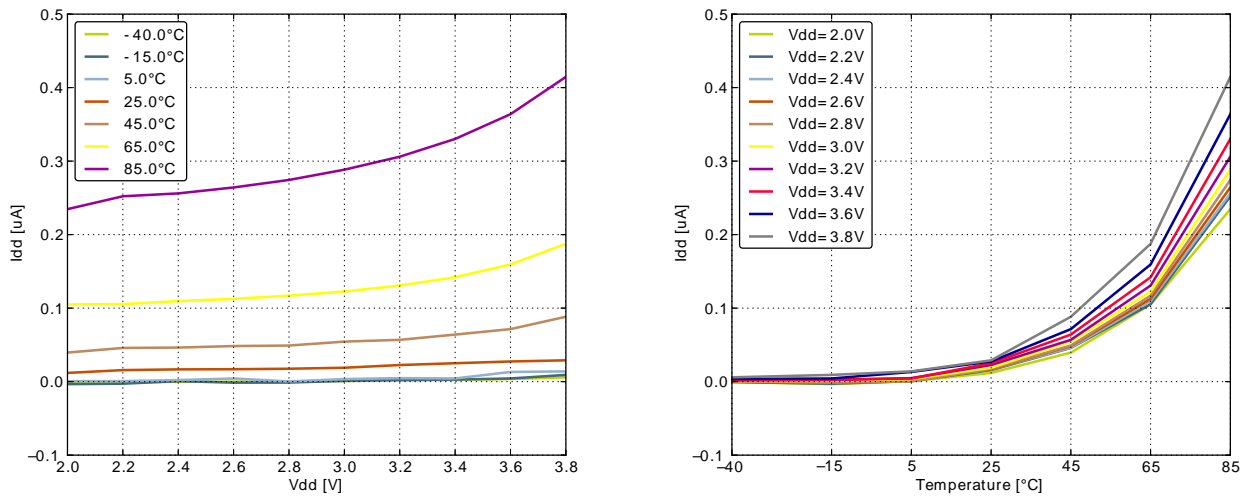

3.5 Transition between Energy Modes

Table 3.4. Energy Modes Transitions

Symbol	Parameter	Min	Typ	Max	Unit
t_{EM10}	Transition time from EM1 to EM0		0 ¹		HF core CLK cycles
t_{EM20}	Transition time from EM2 to EM0		2		μ s
t_{EM30}	Transition time from EM3 to EM0		2		μ s
t_{EM40}	Transition time from EM4 to EM0		163		μ s

¹Core wakeup time only.

3.6 Power Management

The EFM32ZG requires the AVDD_x, VDD_DREG and IOVDD_x pins to be connected together (with optional filter) at the PCB level. For practical schematic recommendations, please see the application note, "AN0002 EFM32 Hardware Design Considerations".

Table 3.5. Power Management

Symbol	Parameter	Condition	Min	Typ	Max	Unit
V _{BODextthr-}	BOD threshold on falling external supply voltage		1.82		1.85	V
V _{BODintthr-}	BOD threshold on falling internally regulated supply voltage		1.62		1.68	V
V _{BODextthr+}	BOD threshold on rising external supply voltage			1.85		V
t _{RESET}	Delay from reset is released until program execution starts	Applies to Power-on Reset, Brown-out Reset and pin reset.		163		μs
C _{DECOUPLE}	Voltage regulator decoupling capacitor.	X5R capacitor recommended. Apply between DECOUPLE pin and GROUND		1		μF

3.7 Flash

Table 3.6. Flash

Symbol	Parameter	Condition	Min	Typ	Max	Unit
EC _{FLASH}	Flash erase cycles before failure		20000			cycles
RET _{FLASH}	Flash data retention	T _{AMB} <150°C	10000			h
		T _{AMB} <85°C	10			years
		T _{AMB} <70°C	20			years
t _{W_PROG}	Word (32-bit) programming time		20			μs
t _{P_ERASE}	Page erase time		20	20.4	20.8	ms
t _{D_ERASE}	Device erase time		40	40.8	41.6	ms
I _{ERASE}	Erase current				7 ¹	mA
I _{WRITE}	Write current				7 ¹	mA
V _{FLASH}	Supply voltage during flash erase and write		1.8		3.8	V

¹Measured at 25°C

3.8 General Purpose Input Output

Table 3.7. GPIO

Symbol	Parameter	Condition	Min	Typ	Max	Unit
V _{IOIL}	Input low voltage				0.3V _{DD}	V
V _{IOIH}	Input high voltage		0.7V _{DD}			V
V _{IOOH}	Output high voltage	Sourcing 6 mA, V _{DD} =1.85 V, GPIO_Px_CTRL DRIVEMODE = STANDARD	0.75V _{DD}			V
		Sourcing 6 mA, V _{DD} =3.0 V, GPIO_Px_CTRL DRIVEMODE = STANDARD	0.95V _{DD}			V
		Sourcing 20 mA, V _{DD} =1.85 V, GPIO_Px_CTRL DRIVEMODE = HIGH	0.7V _{DD}			V
		Sourcing 20 mA, V _{DD} =3.0 V, GPIO_Px_CTRL DRIVEMODE = HIGH	0.9V _{DD}			V
V _{IOOL}	Output low voltage	Sinking 6 mA, V _{DD} =1.85 V, GPIO_Px_CTRL DRIVEMODE = STANDARD			0.25V _{DD}	V
		Sinking 6 mA, V _{DD} =3.0 V, GPIO_Px_CTRL DRIVEMODE = STANDARD			0.05V _{DD}	V
		Sinking 20 mA, V _{DD} =1.85 V, GPIO_Px_CTRL DRIVEMODE = HIGH			0.3V _{DD}	V
		Sinking 20 mA, V _{DD} =3.0 V, GPIO_Px_CTRL DRIVEMODE = HIGH			0.1V _{DD}	V
I _{IOLEAK}	Input leakage current	High Impedance IO connected to GROUND or V _{DD}			+/-25	nA
R _{PU}	I/O pin pull-up resistor			40		kOhm
R _{PD}	I/O pin pull-down resistor			40		kOhm
R _{IOESD}	Internal ESD series resistor			200		Ohm
t _{IOGLITCH}	Pulse width of pulses to be removed by the glitch suppression filter		10		50	ns
t _{IOOF}	Output fall time	0.5 mA drive strength and load capacitance C _L =12.5-25pF.	20+0.1C _L		250	ns
		2mA drive strength and load capacitance C _L =350-600pF	20+0.1C _L		250	ns
V _{IOHYST}	I/O pin hysteresis (V _{IOTHR+} - V _{IOTHR-})	V _{DD} = 1.85 - 3.8 V	0.1V _{DD}			V

Figure 3.14. Typical Low-Level Output Current, 2V Supply Voltage

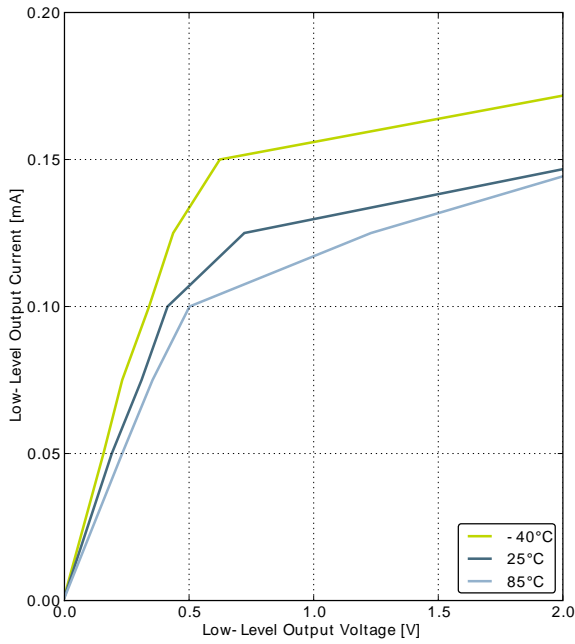

GPIO_Px_CTRL DRIVEMODE = LOWEST

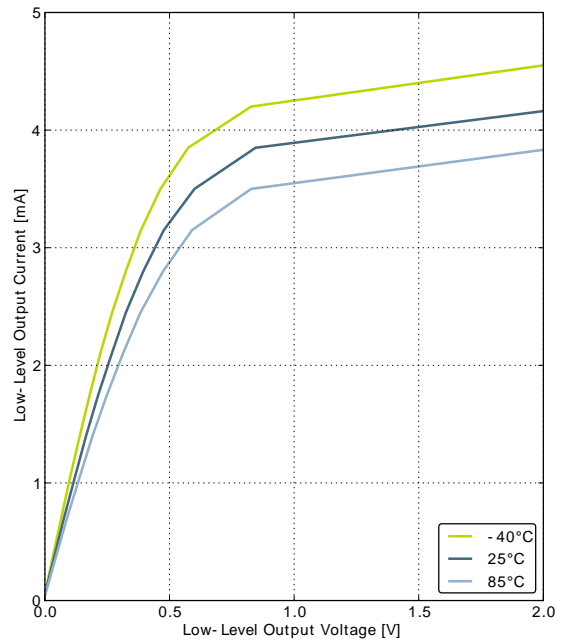

GPIO_Px_CTRL DRIVEMODE = LOW

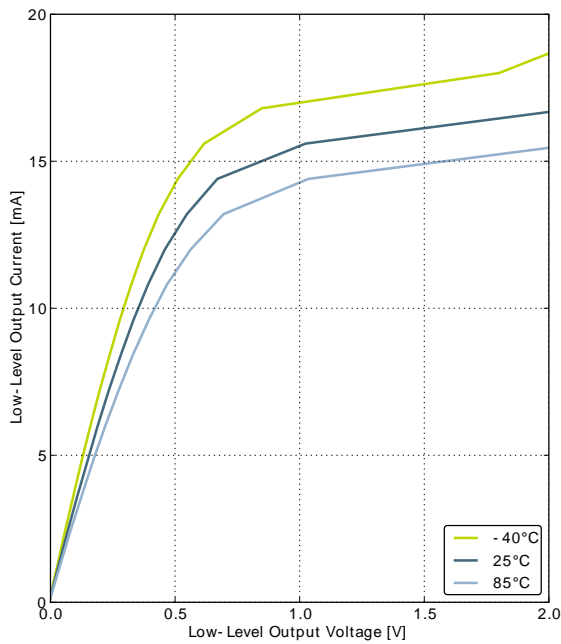

GPIO_Px_CTRL DRIVEMODE = STANDARD

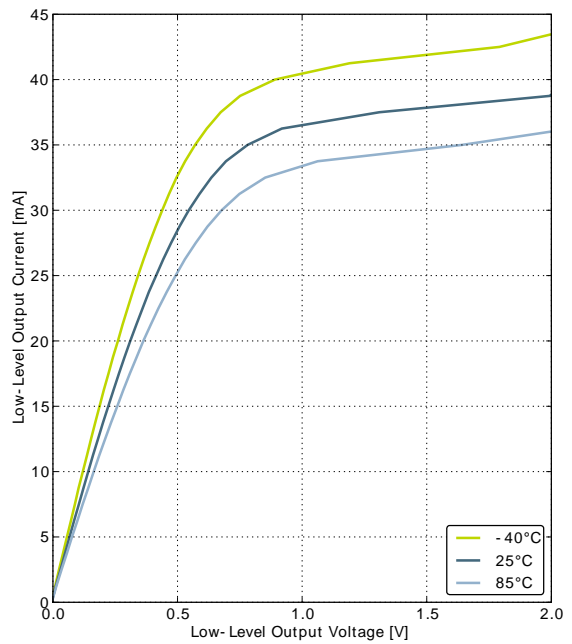

GPIO_Px_CTRL DRIVEMODE = HIGH

Figure 3.15. Typical High-Level Output Current, 2V Supply Voltage

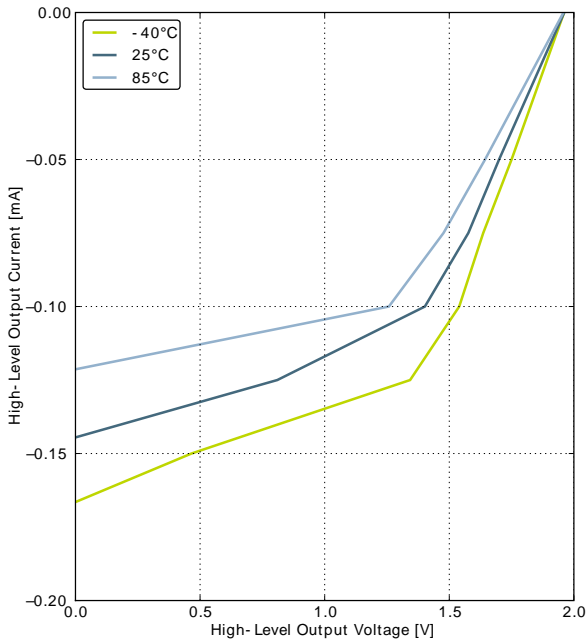

GPIO_Px_CTRL DRIVEMODE = LOWEST

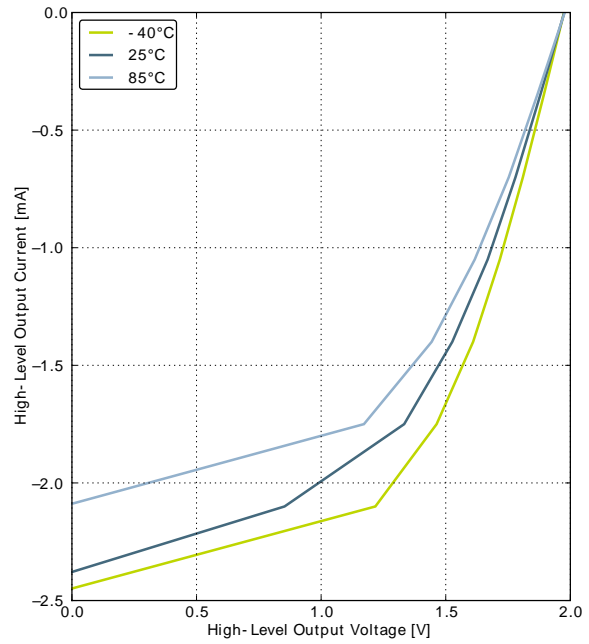

GPIO_Px_CTRL DRIVEMODE = LOW

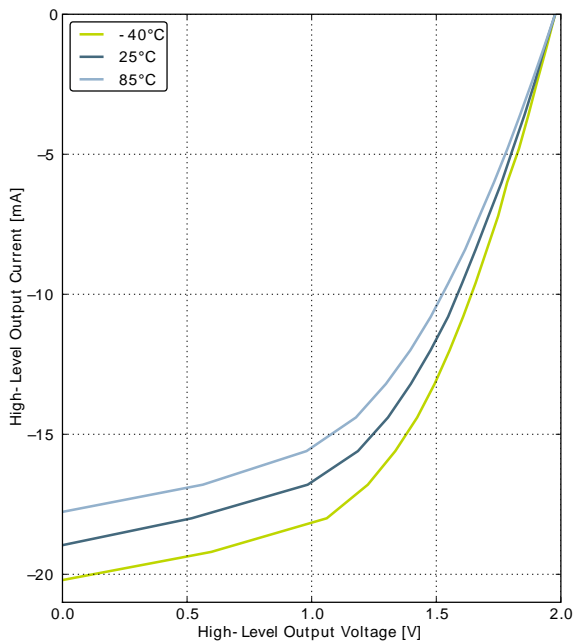

GPIO_Px_CTRL DRIVEMODE = STANDARD

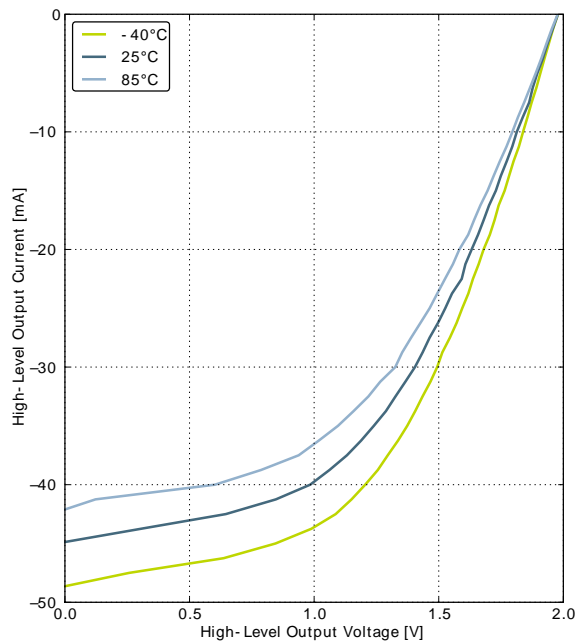

GPIO_Px_CTRL DRIVEMODE = HIGH

Figure 3.16. Typical Low-Level Output Current, 3V Supply Voltage

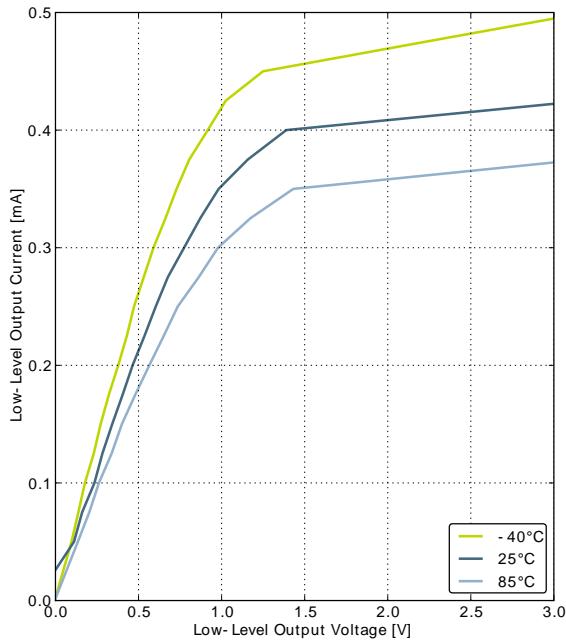

GPIO_Px_CTRL DRIVEMODE = LOWEST

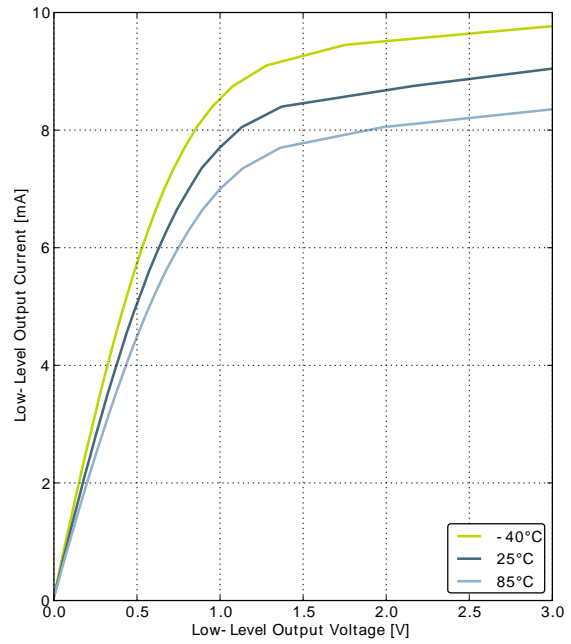

GPIO_Px_CTRL DRIVEMODE = LOW

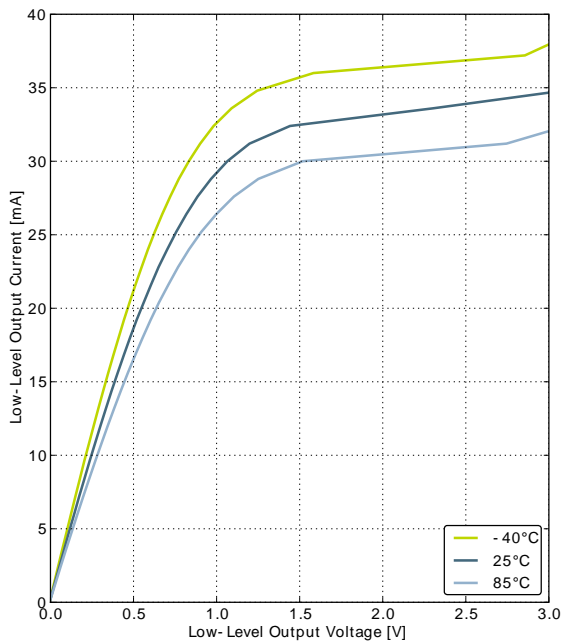

GPIO_Px_CTRL DRIVEMODE = STANDARD

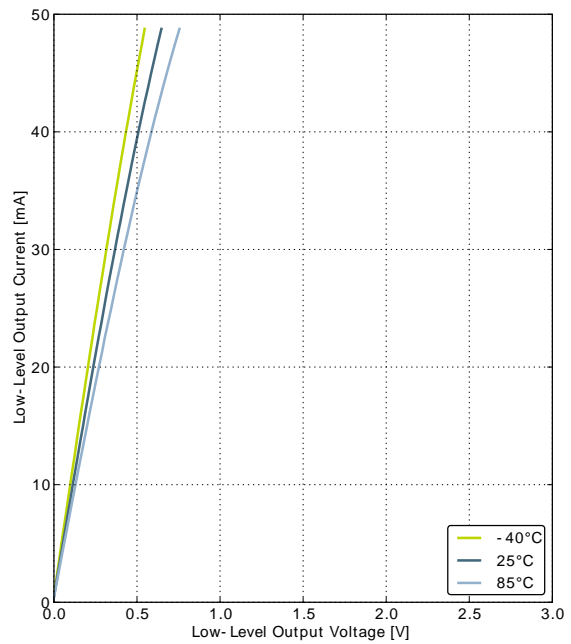

GPIO_Px_CTRL DRIVEMODE = HIGH

Figure 3.17. Typical High-Level Output Current, 3V Supply Voltage

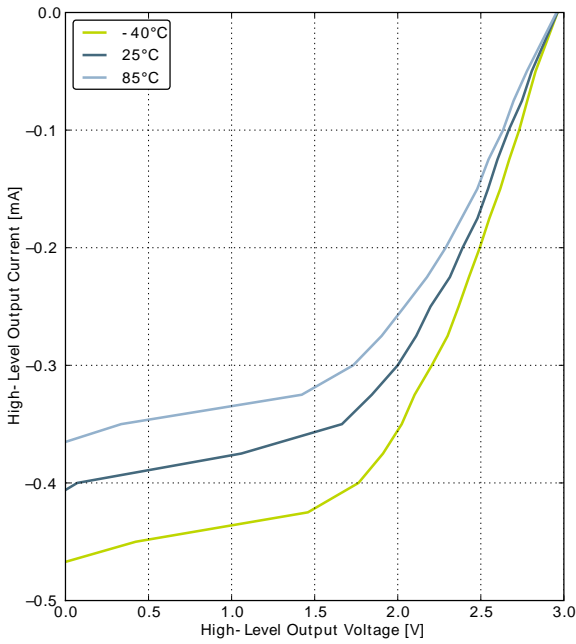

GPIO_Px_CTRL DRIVEMODE = LOWEST

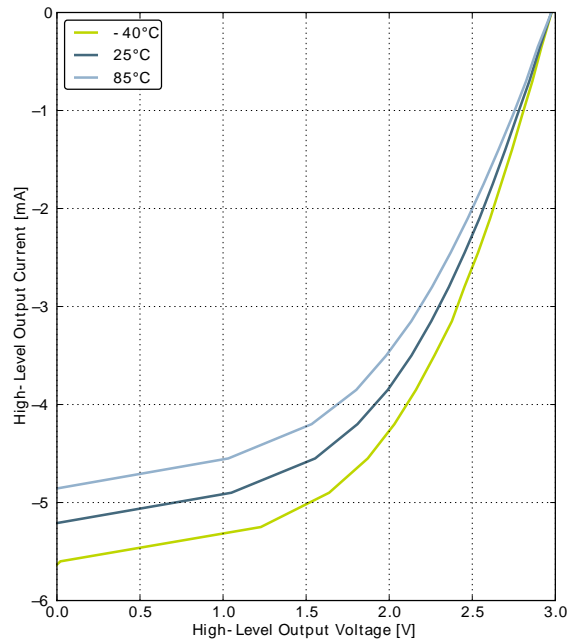

GPIO_Px_CTRL DRIVEMODE = LOW

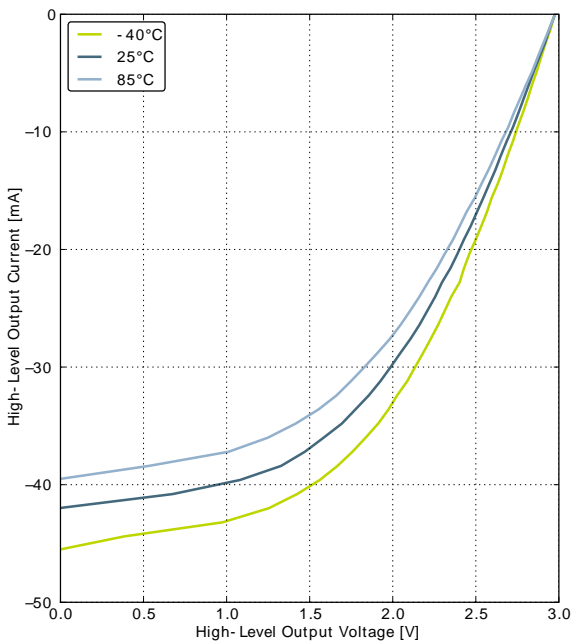

GPIO_Px_CTRL DRIVEMODE = STANDARD

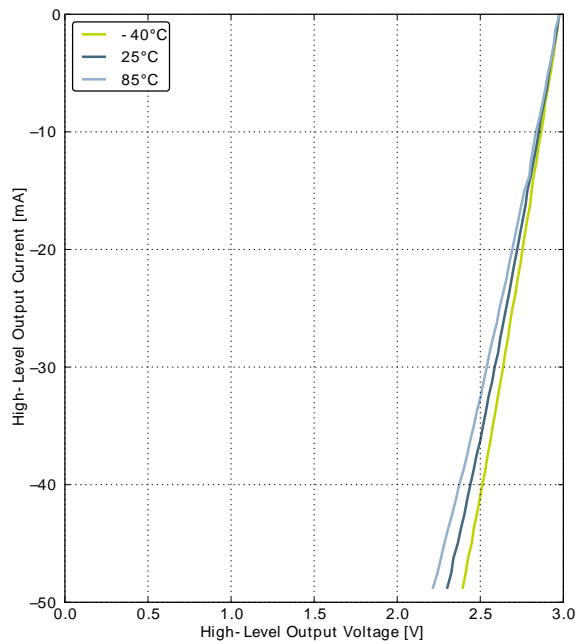

GPIO_Px_CTRL DRIVEMODE = HIGH

Figure 3.18. Typical Low-Level Output Current, 3.8V Supply Voltage

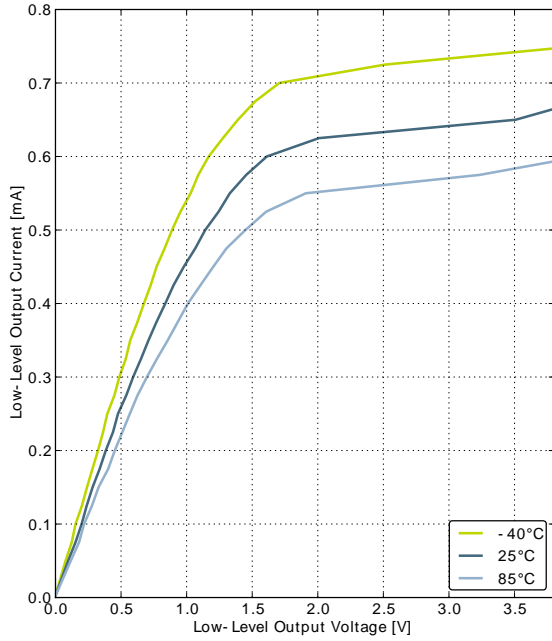

GPIO_Px_CTRL DRIVEMODE = LOWEST

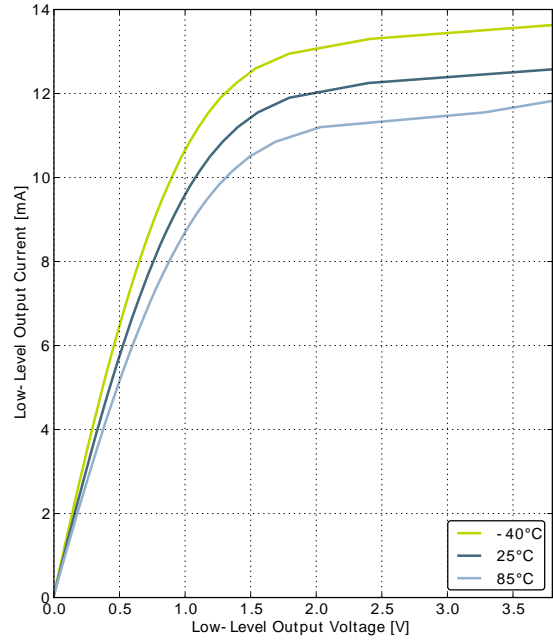

GPIO_Px_CTRL DRIVEMODE = LOW

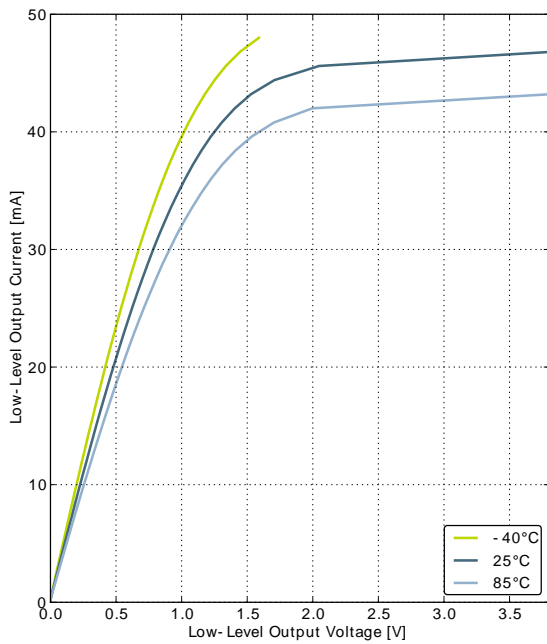

GPIO_Px_CTRL DRIVEMODE = STANDARD

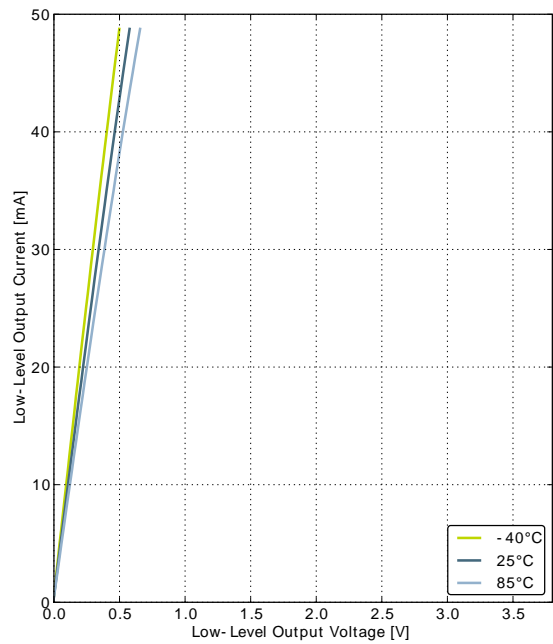

GPIO_Px_CTRL DRIVEMODE = HIGH

Figure 3.19. Typical High-Level Output Current, 3.8V Supply Voltage

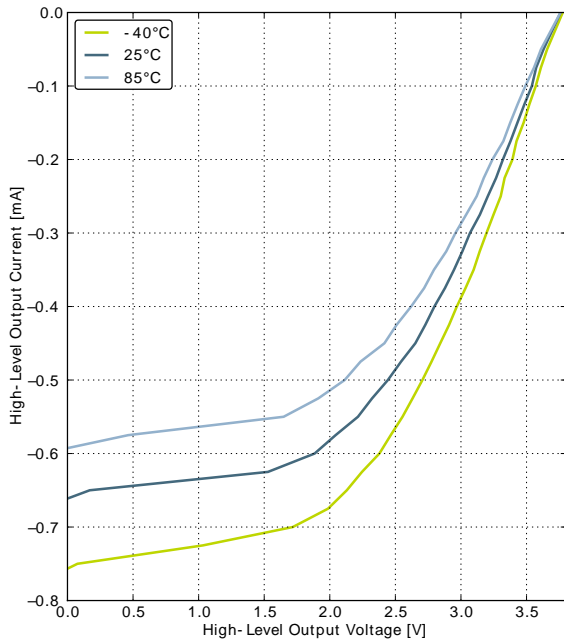

GPIO_Px_CTRL DRIVEMODE = LOWEST

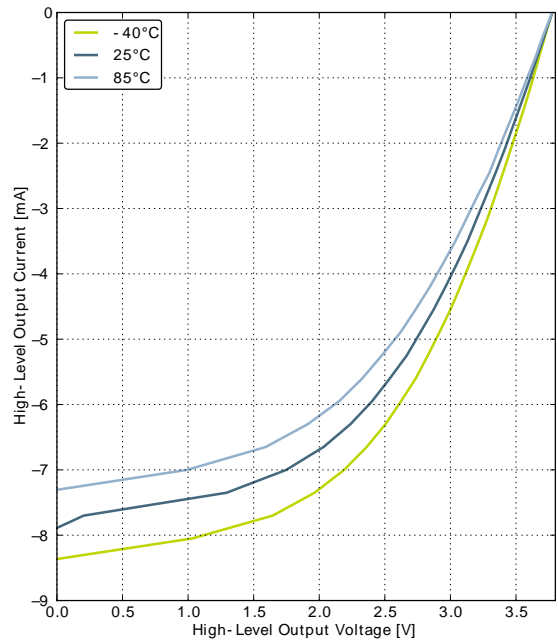

GPIO_Px_CTRL DRIVEMODE = LOW

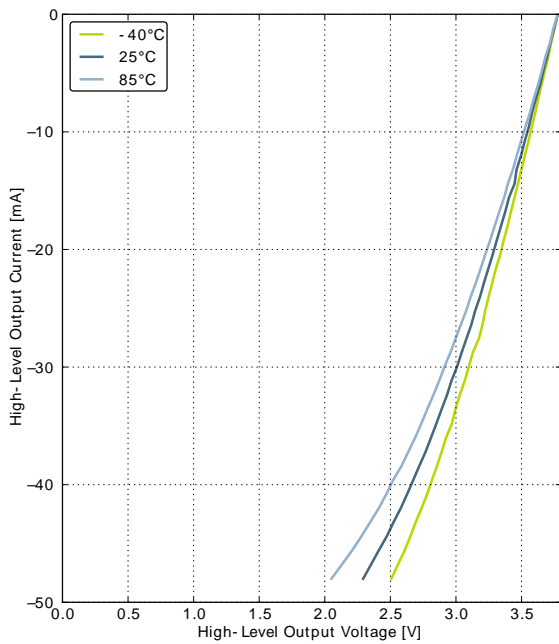

GPIO_Px_CTRL DRIVEMODE = STANDARD

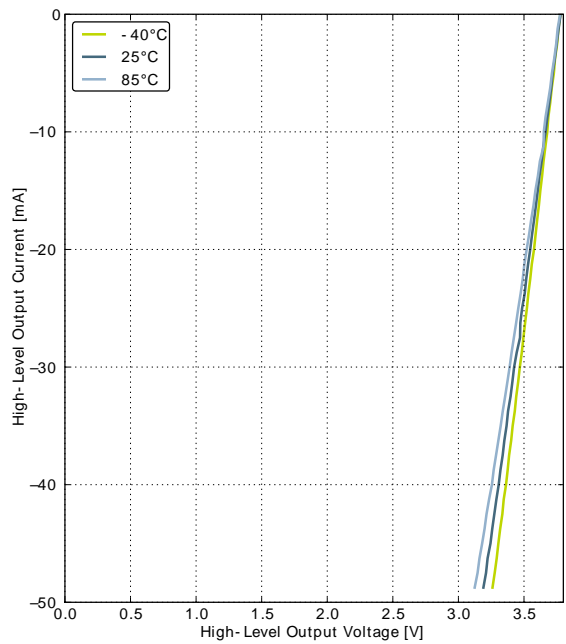

GPIO_Px_CTRL DRIVEMODE = HIGH

3.9 Oscillators

3.9.1 LFXO

Table 3.8. LFXO

Symbol	Parameter	Condition	Min	Typ	Max	Unit
f_{LFXO}	Supported nominal crystal frequency			32.768		kHz
ESR_{LFXO}	Supported crystal equivalent series resistance (ESR)			30	120	kOhm
C_{LFXOL}	Supported crystal external load range		5		25	pF
DC_{LFXO}	Duty cycle		48	50	53.5	%
I_{LFXO}	Current consumption for core and buffer after startup.	ESR=30 kOhm, $C_L=10$ pF, LFXOBOOST in CMU_CTRL is 1		190		nA
t_{LFXO}	Start- up time.	ESR=30 kOhm, $C_L=10$ pF, 40% - 60% duty cycle has been reached, LFXOBOOST in CMU_CTRL is 1		400		ms

For safe startup of a given crystal, the energyAware Designer in Simplicity Studio contains a tool to help users configure both load capacitance and software settings for using the LFXO. For details regarding the crystal configuration, the reader is referred to application note "AN0016 EFM32 Oscillator Design Consideration".

3.9.2 HFXO

Table 3.9. HFXO

Symbol	Parameter	Condition	Min	Typ	Max	Unit
f_{HFXO}	Supported nominal crystal Frequency		4		24	MHz
ESR_{HFXO}	Supported crystal equivalent series resistance (ESR)	Crystal frequency 24 MHz		30	60	Ohm
		Crystal frequency 4 MHz		400	1500	Ohm
g_{mHFXO}	The transconductance of the HFXO input transistor at crystal startup	HFXOBOOST in CMU_CTRL equals 0b11	20			mS
C_{HFXOL}	Supported crystal external load range		5		25	pF
DC_{HFXO}	Duty cycle		46	50	54	%
I_{HFXO}	Current consumption for HFXO after startup	4 MHz: ESR=400 Ohm, $C_L=20$ pF, HFXOBOOST in CMU_CTRL equals 0b11		85		μ A
		24 MHz: ESR=30 Ohm, $C_L=10$ pF, HFXOBOOST in CMU_CTRL equals 0b11		165		μ A
t_{HFXO}	Startup time	24 MHz: ESR=30 Ohm, $C_L=10$ pF, HFXOBOOST in CMU_CTRL equals 0b11		400		μ s

3.9.3 LFRCO

Table 3.10. LFRCO

Symbol	Parameter	Condition	Min	Typ	Max	Unit
f_{LFRCO}	Oscillation frequency, $V_{DD}=3.0\text{ V}$, $T_{AMB}=25^{\circ}\text{C}$			32.768		kHz
t_{LFRCO}	Startup time not including software calibration			150		μs
I_{LFRCO}	Current consumption			190		nA
TUNESTEP _{LFRCO}	Frequency step for LSB change in TUNING value			1.5		%

Figure 3.20. Calibrated LFRCO Frequency vs Temperature and Supply Voltage

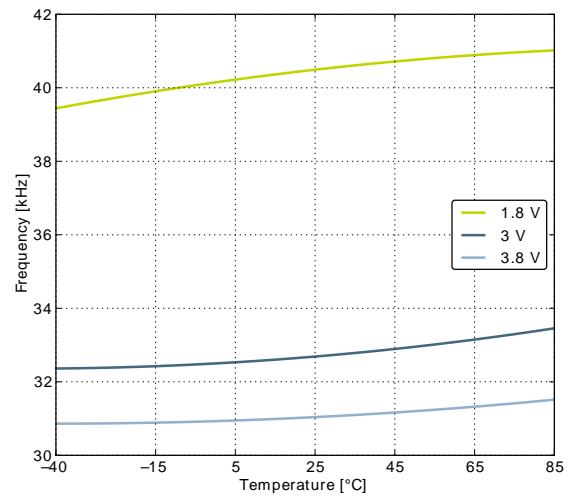
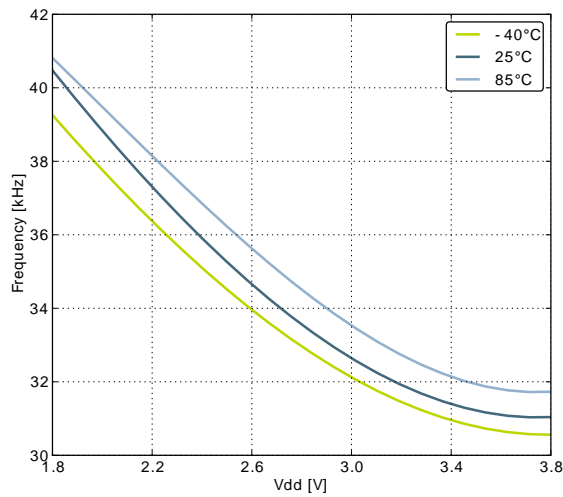

3.9.4 HFRCO

Table 3.11. HFRCO

Symbol	Parameter	Condition	Min	Typ	Max	Unit
f_{HFRCO}	Oscillation frequency, $V_{\text{DD}}=3.0\text{ V}$, $T_{\text{AMB}}=25^{\circ}\text{C}$	21 MHz frequency band		21		MHz
		14 MHz frequency band		14		MHz
		11 MHz frequency band		11		MHz
		7 MHz frequency band		6.6		MHz
		1 MHz frequency band		1.2		MHz
$t_{\text{HFRCO_settling}}$	Settling time after start-up	$f_{\text{HFRCO}} = 14\text{ MHz}$		0.6		Cycles
I_{HFRCO}	Current consumption	$f_{\text{HFRCO}} = 21\text{ MHz}$		93		μA
		$f_{\text{HFRCO}} = 14\text{ MHz}$		77		μA
		$f_{\text{HFRCO}} = 11\text{ MHz}$		72		μA
		$f_{\text{HFRCO}} = 6.6\text{ MHz}$		63		μA
		$f_{\text{HFRCO}} = 1.2\text{ MHz}$		22		μA
DC_{HFRCO}	Duty cycle	$f_{\text{HFRCO}} = 14\text{ MHz}$	48.5	50	51	%
$\text{TUNESTEP}_{\text{HFRCO}}$	Frequency step for LSB change in TUNING value			0.3		%

Figure 3.21. Calibrated HFRCO 11 MHz Band Frequency vs Supply Voltage and Temperature

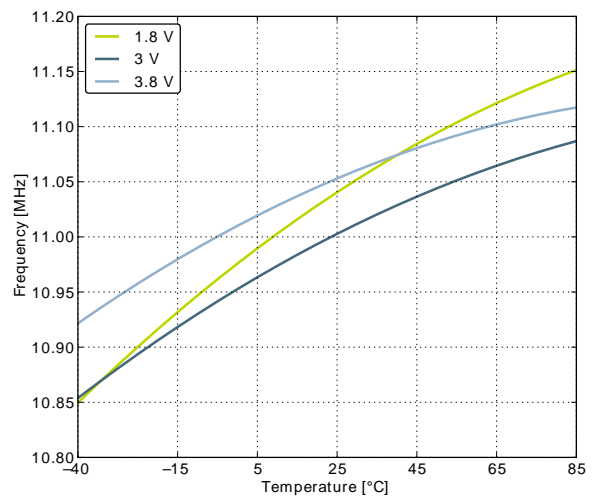
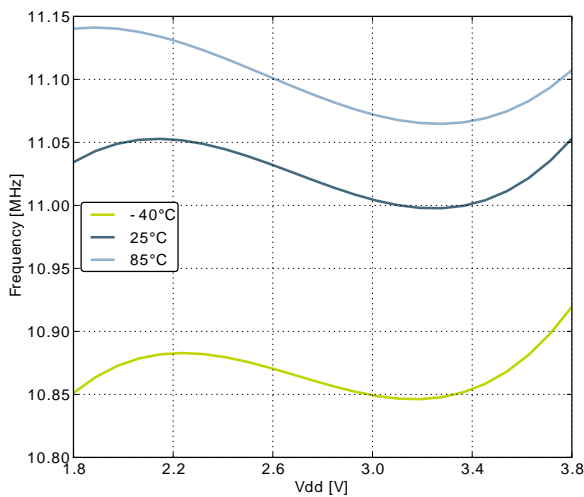

Figure 3.22. Calibrated HFRCO 14 MHz Band Frequency vs Supply Voltage and Temperature

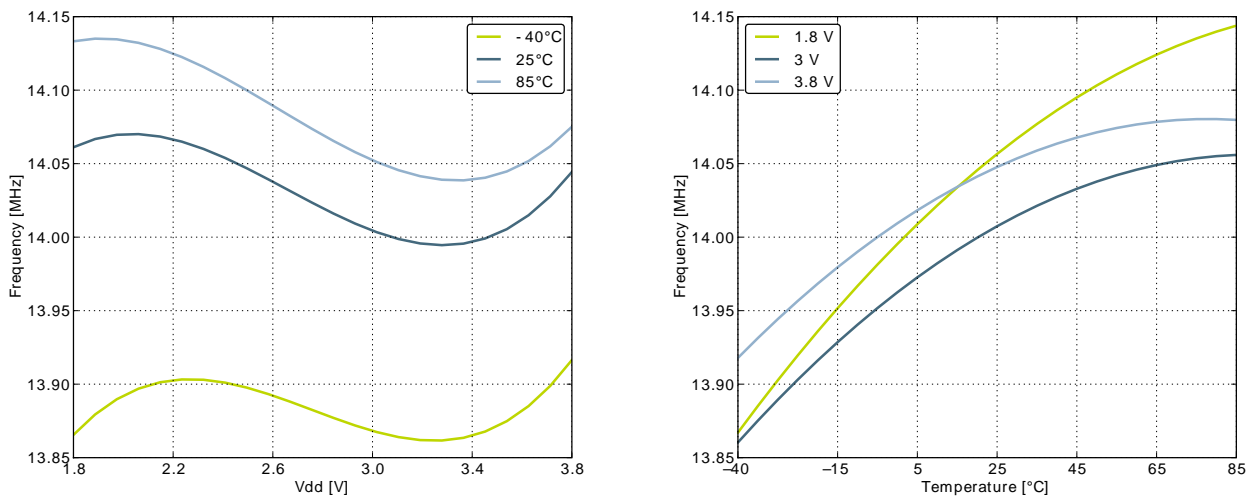
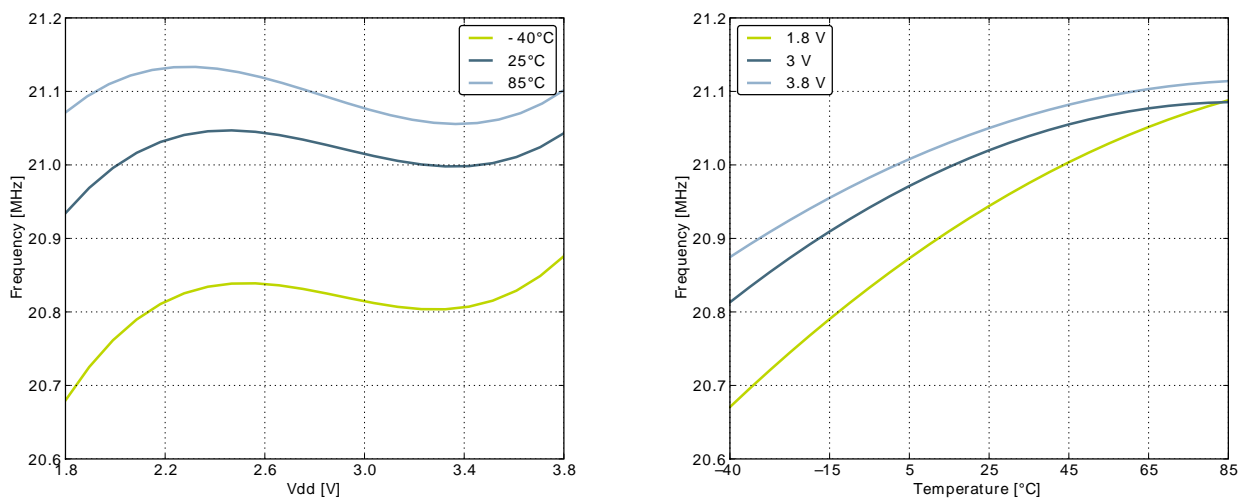

Figure 3.23. Calibrated HFRCO 21 MHz Band Frequency vs Supply Voltage and Temperature



3.9.5 ULFRCO

Table 3.12. ULFRCO

Symbol	Parameter	Condition	Min	Typ	Max	Unit
f_{ULFRCO}	Oscillation frequency	25°C, 3V	0.8		1.5	kHz
TC_{ULFRCO}	Temperature coefficient			0.05		%/°C
VC_{ULFRCO}	Supply voltage coefficient			-18.2		%/V

3.10 Analog Digital Converter (ADC)

Table 3.13. ADC

Symbol	Parameter	Condition	Min	Typ	Max	Unit
V_{ADCIN}	Input voltage range	Single ended	0		V_{REF}	V

Symbol	Parameter	Condition	Min	Typ	Max	Unit
		Differential	$-V_{REF}/2$		$V_{REF}/2$	V
$V_{ADCREFIN}$	Input range of external reference voltage, single ended and differential		1.25		V_{DD}	V
$V_{ADCREFIN_CH7}$	Input range of external negative reference voltage on channel 7	See $V_{ADCREFIN}$	0		$V_{DD} - 1.1$	V
$V_{ADCREFIN_CH6}$	Input range of external positive reference voltage on channel 6	See $V_{ADCREFIN}$	0.625		V_{DD}	V
$V_{ADCCMIN}$	Common mode input range		0		V_{DD}	V
I_{ADCIN}	Input current	2pF sampling capacitors		<100		nA
$CMRR_{ADC}$	Analog input common mode rejection ratio			65		dB
I_{ADC}	Average active current	1 MSamples/s, 12 bit, external reference		351		μ A
		10 kSamples/s 12 bit, internal 1.25 V reference, WARMUP-MODE in ADCn_CTRL set to 0b00		67		μ A
		10 kSamples/s 12 bit, internal 1.25 V reference, WARMUP-MODE in ADCn_CTRL set to 0b01		63		μ A
		10 kSamples/s 12 bit, internal 1.25 V reference, WARMUP-MODE in ADCn_CTRL set to 0b10		64		μ A
I_{ADCREF}	Current consumption of internal voltage reference	Internal voltage reference		65		μ A
C_{ADCIN}	Input capacitance			2		pF
R_{ADCIN}	Input ON resistance		1			MOhm
$R_{ADCFILT}$	Input RC filter resistance			10		kOhm
$C_{ADCFILT}$	Input RC filter/decoupling capacitance			250		fF
f_{ADCCLK}	ADC Clock Frequency				13	MHz
$t_{ADCCONV}$	Conversion time	6 bit		7		ADC-CLK Cycles
		8 bit		11		ADC-CLK Cycles

Symbol	Parameter	Condition	Min	Typ	Max	Unit
		12 bit		13		ADC-CLK Cycles
t _{ADCACQ}	Acquisition time	Programmable		1	256	ADC-CLK Cycles
t _{ADCACQVDD3}	Required acquisition time for VDD/3 reference			2		µs
t _{ADCSTART}	Startup time of reference generator and ADC core in NORMAL mode				5	µs
	Startup time of reference generator and ADC core in KEEPADCWARM mode				1	µs
SNR _{ADC}	Signal to Noise Ratio (SNR)	1 MSamples/s, 12 bit, single ended, internal 1.25V reference			59	dB
		1 MSamples/s, 12 bit, single ended, internal 2.5V reference			63	dB
		1 MSamples/s, 12 bit, single ended, V _{DD} reference			65	dB
		1 MSamples/s, 12 bit, differential, internal 1.25V reference			60	dB
		1 MSamples/s, 12 bit, differential, internal 2.5V reference			65	dB
		1 MSamples/s, 12 bit, differential, 5V reference			54	dB
		1 MSamples/s, 12 bit, differential, V _{DD} reference			67	dB
		1 MSamples/s, 12 bit, differential, 2xV _{DD} reference			69	dB
		200 kSamples/s, 12 bit, single ended, internal 1.25V reference			62	dB
		200 kSamples/s, 12 bit, single ended, internal 2.5V reference			63	dB
		200 kSamples/s, 12 bit, single ended, V _{DD} reference			67	dB
		200 kSamples/s, 12 bit, differential, internal 1.25V reference			63	dB
		200 kSamples/s, 12 bit, differential, internal 2.5V reference			66	dB
		200 kSamples/s, 12 bit, differential, 5V reference			66	dB
200 kSamples/s, 12 bit, differential, V _{DD} reference			69	dB		

Symbol	Parameter	Condition	Min	Typ	Max	Unit
		200 kSamples/s, 12 bit, differential, 2xV _{DD} reference		70		dB
SINAD _{ADC}	Signal-to-Noise And Distortion-ratio (SINAD)	1 MSamples/s, 12 bit, single ended, internal 1.25V reference		58		dB
		1 MSamples/s, 12 bit, single ended, internal 2.5V reference		62		dB
		1 MSamples/s, 12 bit, single ended, V _{DD} reference		64		dB
		1 MSamples/s, 12 bit, differential, internal 1.25V reference		60		dB
		1 MSamples/s, 12 bit, differential, internal 2.5V reference		64		dB
		1 MSamples/s, 12 bit, differential, 5V reference		54		dB
		1 MSamples/s, 12 bit, differential, V _{DD} reference		66		dB
		1 MSamples/s, 12 bit, differential, 2xV _{DD} reference		68		dB
		200 kSamples/s, 12 bit, single ended, internal 1.25V reference		61		dB
		200 kSamples/s, 12 bit, single ended, internal 2.5V reference		65		dB
		200 kSamples/s, 12 bit, single ended, V _{DD} reference		66		dB
		200 kSamples/s, 12 bit, differential, internal 1.25V reference		63		dB
		200 kSamples/s, 12 bit, differential, internal 2.5V reference		66		dB
		200 kSamples/s, 12 bit, differential, 5V reference		66		dB
		200 kSamples/s, 12 bit, differential, V _{DD} reference		68		dB
		200 kSamples/s, 12 bit, differential, 2xV _{DD} reference		69		dB
SFDR _{ADC}	Spurious-Free Dynamic Range (SFDR)	1 MSamples/s, 12 bit, single ended, internal 1.25V reference		64		dBc
		1 MSamples/s, 12 bit, single ended, internal 2.5V reference		76		dBc
		1 MSamples/s, 12 bit, single ended, V _{DD} reference		73		dBc
		1 MSamples/s, 12 bit, differential, internal 1.25V reference		66		dBc
		1 MSamples/s, 12 bit, differential, internal 2.5V reference		77		dBc
		1 MSamples/s, 12 bit, differential, V _{DD} reference		76		dBc

Symbol	Parameter	Condition	Min	Typ	Max	Unit
		1 MSamples/s, 12 bit, differential, 2xV _{DD} reference		75		dBc
		1 MSamples/s, 12 bit, differential, 5V reference		69		dBc
		200 kSamples/s, 12 bit, single ended, internal 1.25V reference		75		dBc
		200 kSamples/s, 12 bit, single ended, internal 2.5V reference		75		dBc
		200 kSamples/s, 12 bit, single ended, V _{DD} reference		76		dBc
		200 kSamples/s, 12 bit, differential, internal 1.25V reference		79		dBc
		200 kSamples/s, 12 bit, differential, internal 2.5V reference		79		dBc
		200 kSamples/s, 12 bit, differential, 5V reference		78		dBc
		200 kSamples/s, 12 bit, differential, V _{DD} reference		79		dBc
		200 kSamples/s, 12 bit, differential, 2xV _{DD} reference		79		dBc
V _{ADCOFFSET}	Offset voltage	After calibration, single ended		0.3		mV
		After calibration, differential		0.3		mV
TGRAD _{ADCTH}	Thermometer output gradient			-1.92		mV/°C
				-6.3		ADC Codes/°C
DNL _{ADC}	Differential non-linearity (DNL)			±0.7		LSB
INL _{ADC}	Integral non-linearity (INL), End point method			±1.2		LSB
MC _{ADC}	No missing codes		11.999 ¹	12		bits

¹On the average every ADC will have one missing code, most likely to appear around 2048 +/- n*512 where n can be a value in the set {-3, -2, -1, 1, 2, 3}. There will be no missing code around 2048, and in spite of the missing code the ADC will be monotonic at all times so that a response to a slowly increasing input will always be a slowly increasing output. Around the one code that is missing, the neighbour codes will look wider in the DNL plot. The spectra will show spurs on the level of -78dBc for a full scale input for chips that have the missing code issue.

The integral non-linearity (INL) and differential non-linearity parameters are explained in Figure 3.24 (p. 33) and Figure 3.25 (p. 33) , respectively.

Figure 3.24. Integral Non-Linearity (INL)

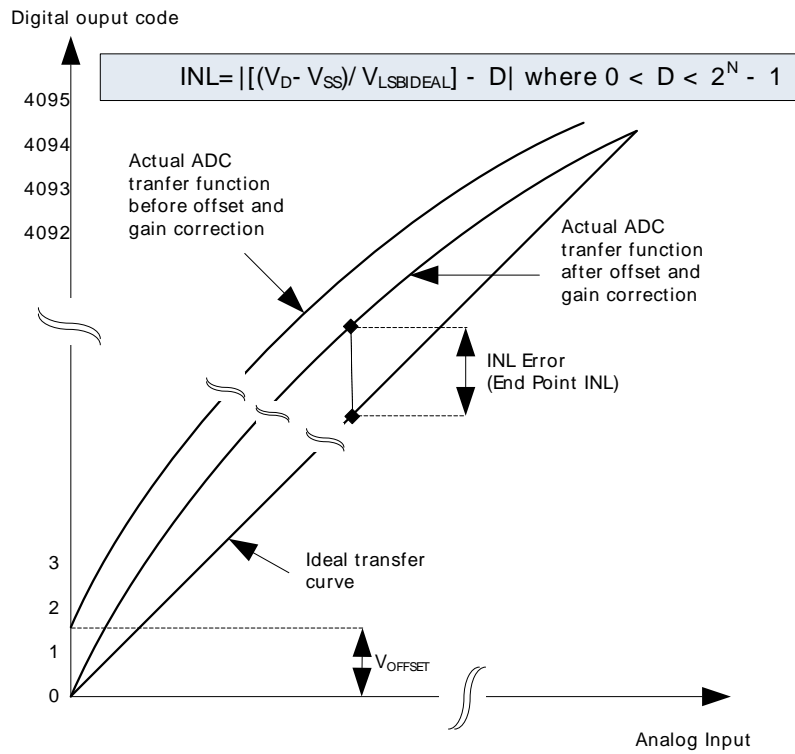
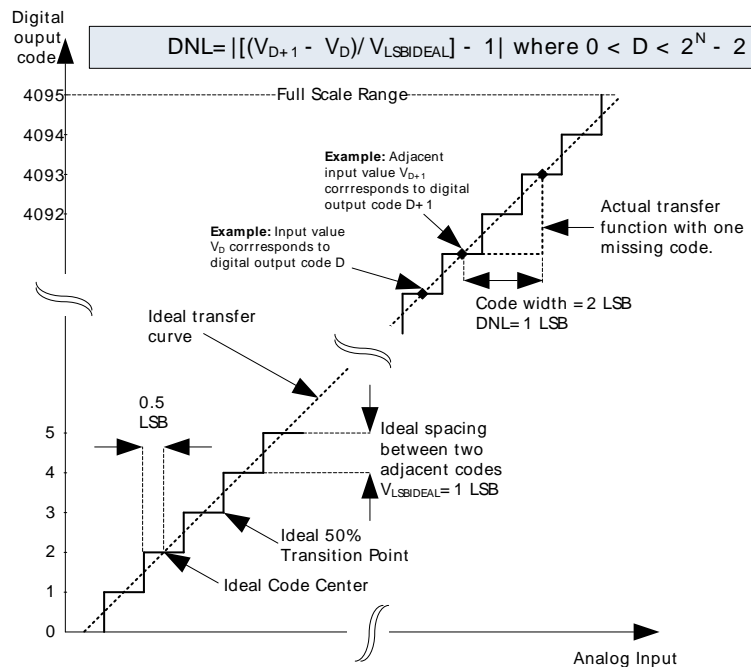
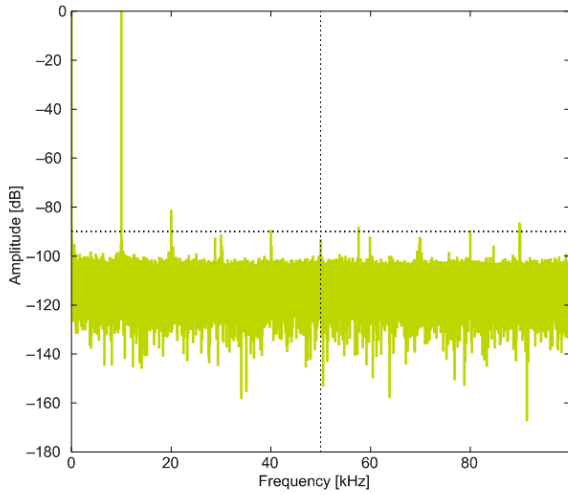

Figure 3.25. Differential Non-Linearity (DNL)



3.10.1 Typical performance

Figure 3.26. ADC Frequency Spectrum, Vdd = 3V, Temp = 25°C



1.25V Reference

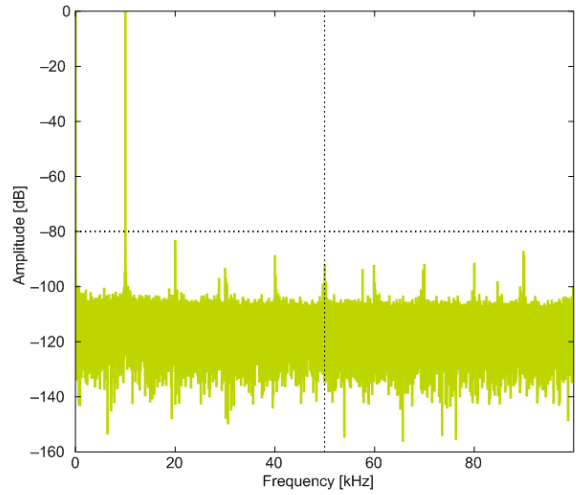

2.5V Reference

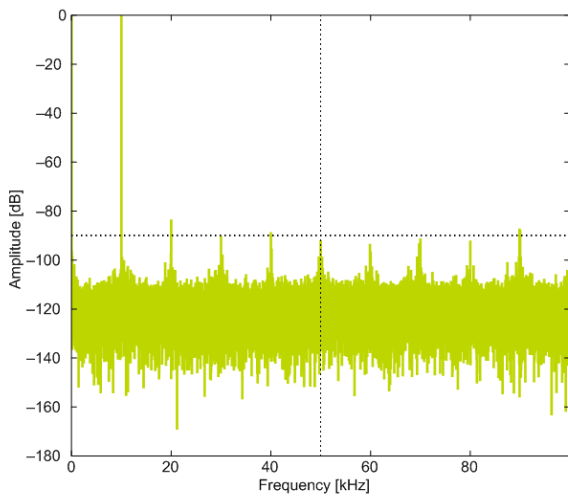

2XVDDVSS Reference

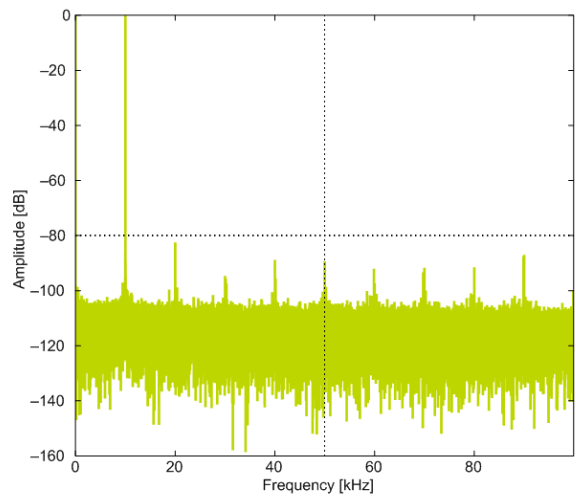

5VDIFF Reference

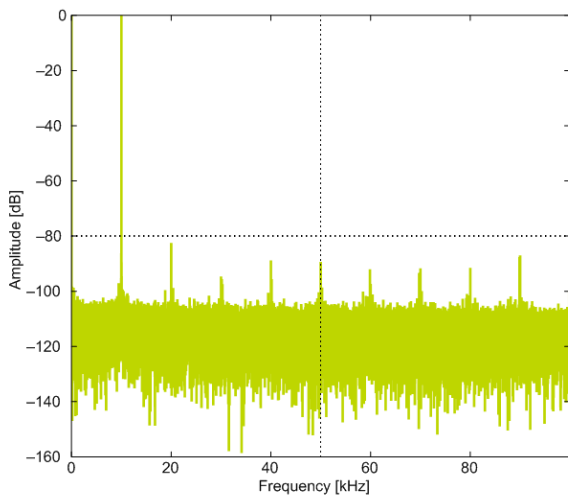

VDD Reference

Figure 3.27. ADC Integral Linearity Error vs Code, Vdd = 3V, Temp = 25°C

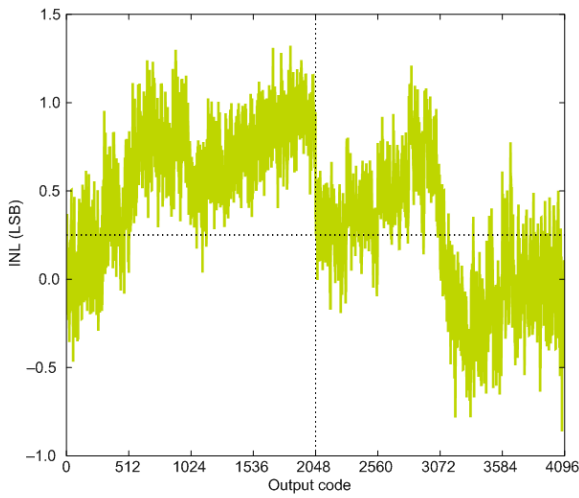

1.25V Reference

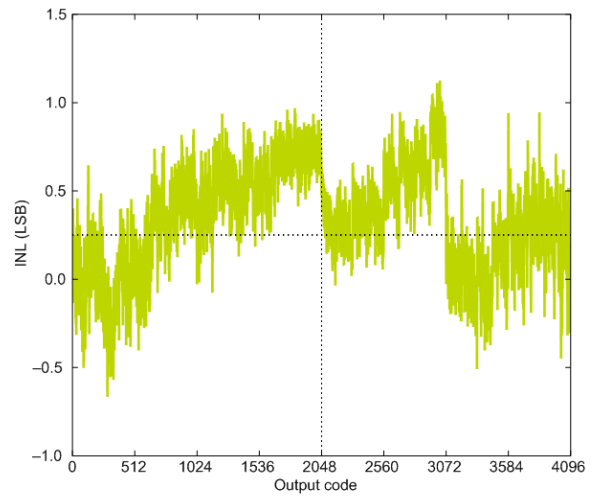

2.5V Reference

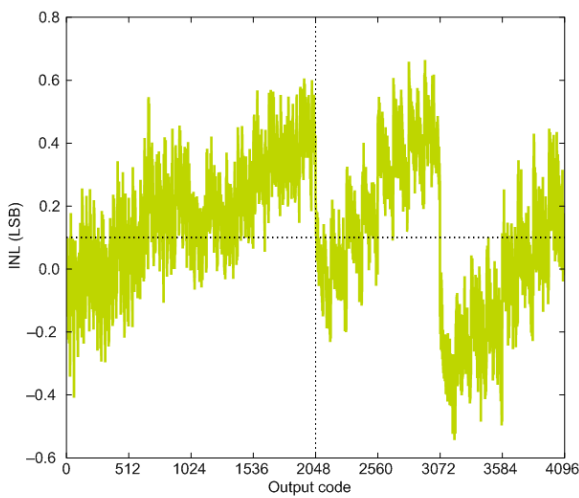

2XVDDVSS Reference

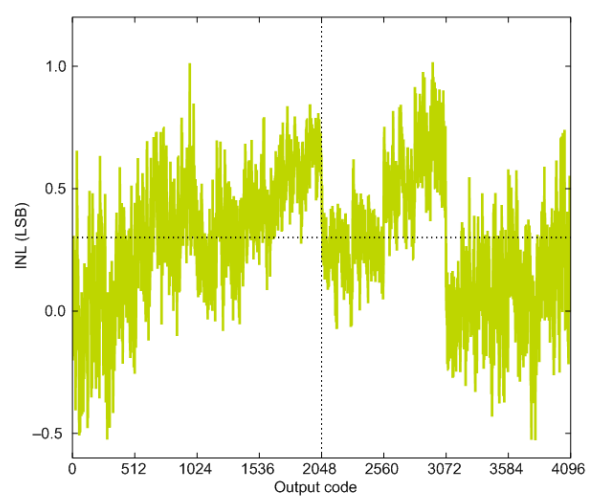

5VDIFF Reference

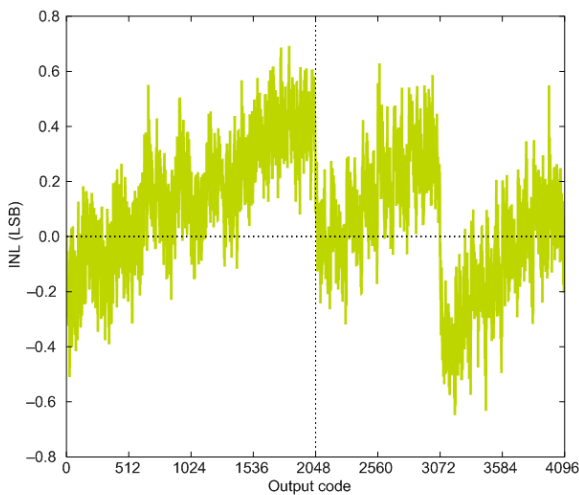

VDD Reference

Figure 3.28. ADC Differential Linearity Error vs Code, Vdd = 3V, Temp = 25°C

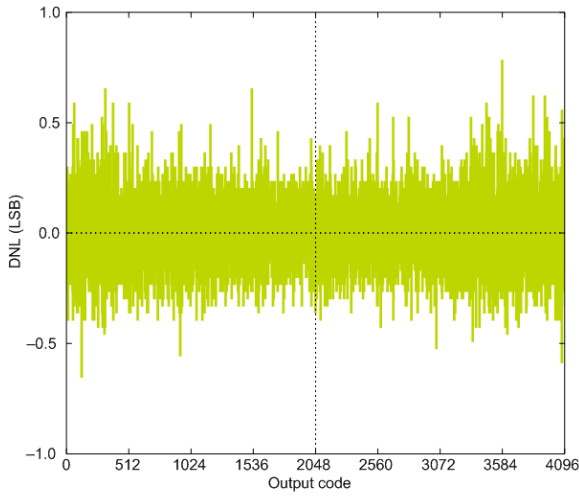

1.25V Reference

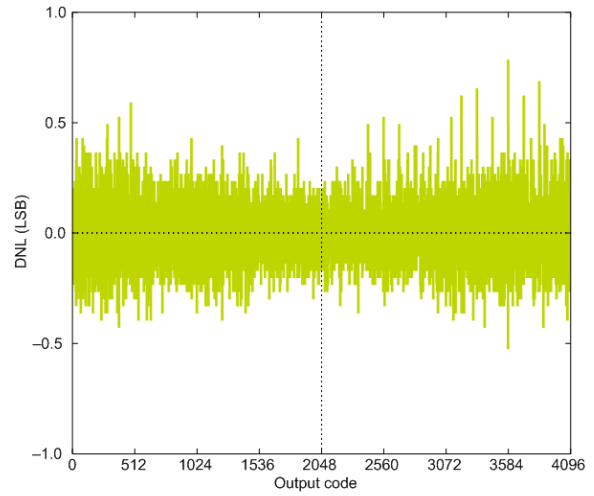

2.5V Reference

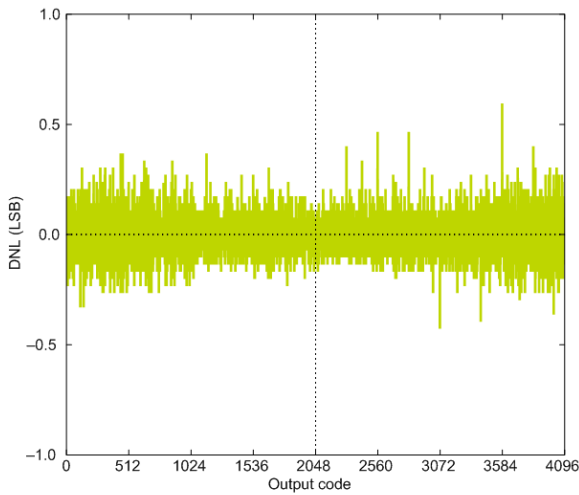

2XVDDVSS Reference

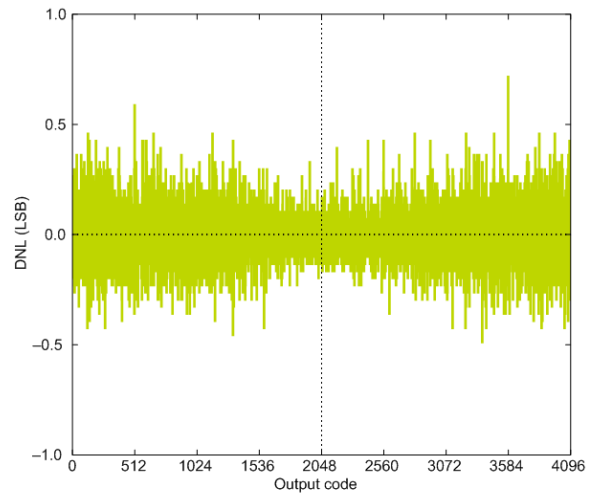

5VDIFF Reference

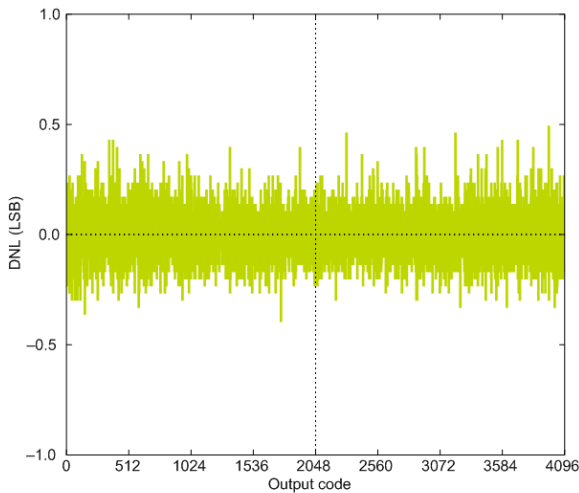

VDD Reference

Figure 3.29. ADC Absolute Offset, Common Mode = Vdd / 2

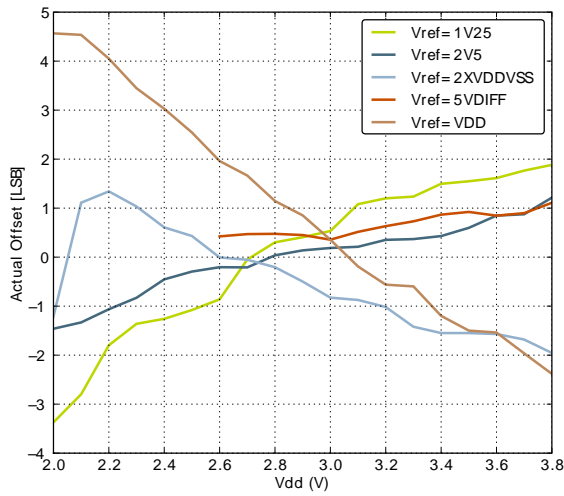

Offset vs Supply Voltage, Temp = 25°C

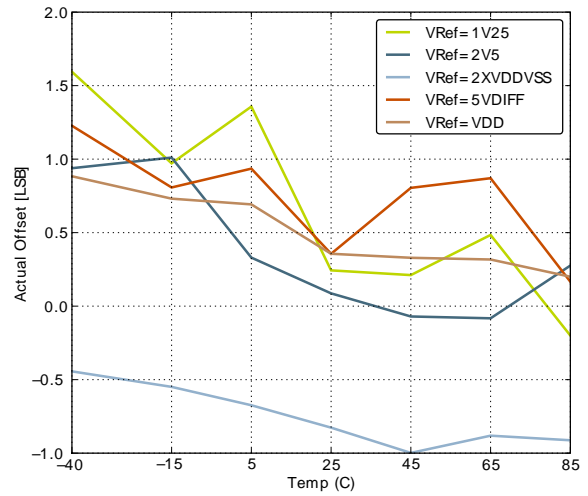

Offset vs Temperature, Vdd = 3V

Figure 3.30. ADC Dynamic Performance vs Temperature for all ADC References, Vdd = 3V

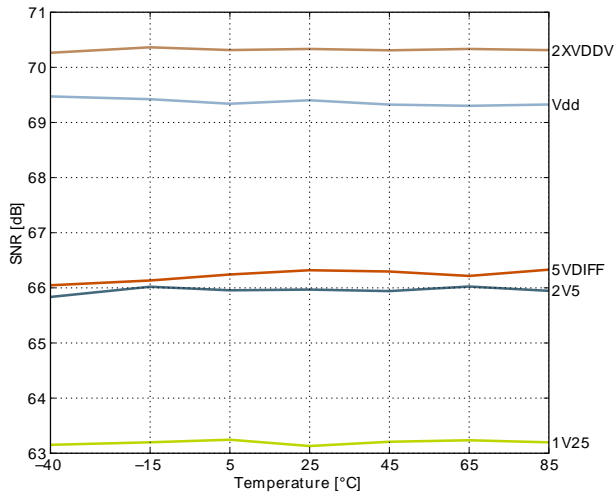

Signal to Noise Ratio (SNR)

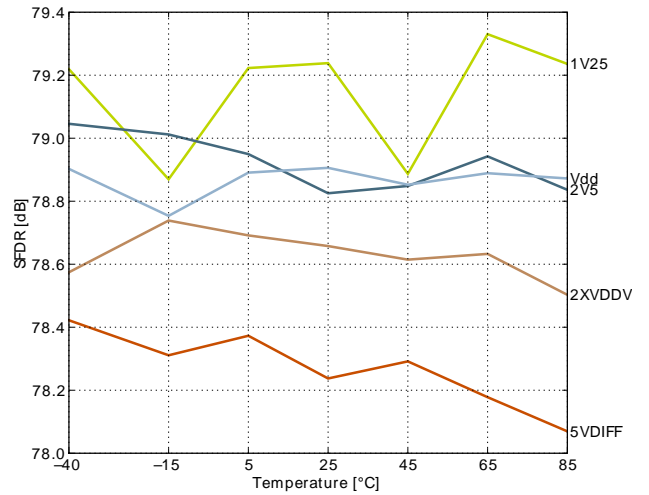

Spurious-Free Dynamic Range (SFDR)

Figure 3.31. ADC Temperature sensor readout

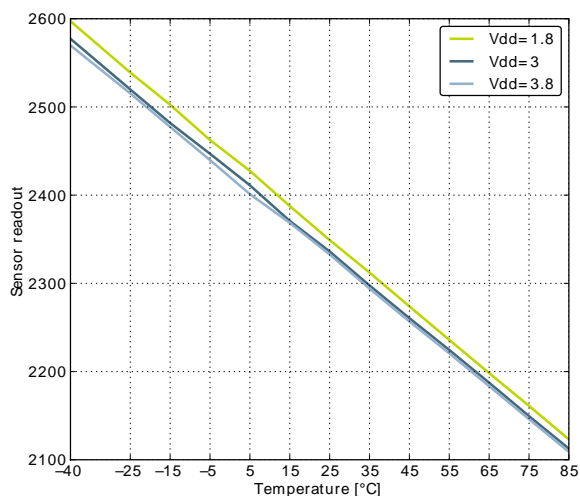

3.11 Current Digital Analog Converter (IDAC)

Table 3.14. IDAC Range 0 Source

Symbol	Parameter	Condition	Min	Typ	Max	Unit
I _{IDAC}	Active current with STEPSEL=0x10	EM0, default settings		11.7		μA
		Duty-cycled		10		nA
I _{0x10}	Nominal IDAC output current with STEPSEL=0x10			0.84		μA
I _{STEP}	Step size			0.049		μA
I _D	Current drop at high impedance load	V _{IDAC_OUT} = V _{DD} - 100mV		0.73		%
TC _{IDAC}	Temperature coefficient	V=3.0V, STEPSEL=0x10		0.3		nA/°C
VC _{IDAC}	Voltage coefficient	V _{DD} = 3.0 V, STEPSEL=0x10		11.7		nA/V

Table 3.15. IDAC Range 0 Sink

Symbol	Parameter	Condition	Min	Typ	Max	Unit
I _{IDAC}	Active current with STEPSEL=0x10	EM0, default settings		13.7		μA
I _{0x10}	Nominal IDAC output current with STEPSEL=0x10			0.84		μA
I _{STEP}	Step size			0.050		μA
I _D	Current drop at high impedance load	V _{IDAC_OUT} = 200 mV		0.16		%
TC _{IDAC}	Temperature coefficient	V _{DD} = 3.0 V, STEPSEL=0x10		0.2		nA/°C
VC _{IDAC}	Voltage coefficient	T = 25 °C, STEPSEL=0x10		12.5		nA/V

Table 3.16. IDAC Range 1 Source

Symbol	Parameter	Condition	Min	Typ	Max	Unit
I _{IDAC}	Active current with STEPSEL=0x10	EM0, default settings		13.0		μA
		Duty-cycled		10		nA
I _{0x10}	Nominal IDAC output current with STEPSEL=0x10			3.17		μA
I _{STEP}	Step size			0.097		μA
I _D	Current drop at high impedance load	V _{IDAC_OUT} = V _{DD} - 100mV		0.79		%
TC _{IDAC}	Temperature coefficient	V _{DD} = 3.0 V, STEPSEL=0x10		0.7		nA/°C
VC _{IDAC}	Voltage coefficient	T = 25 °C, STEPSEL=0x10		38.4		nA/V

Table 3.17. IDAC Range 1 Sink

Symbol	Parameter	Condition	Min	Typ	Max	Unit
I _{IDAC}	Active current with STEPSEL=0x10	EM0, default settings		17.9		μA
I _{0x10}	Nominal IDAC output current with STEPSEL=0x10			3.18		μA
I _{STEP}	Step size			0.098		μA
I _D	Current drop at high impedance load	V _{IDAC_OUT} = 200 mV		0.20		%
TC _{IDAC}	Temperature coefficient	V _{DD} = 3.0 V, STEPSEL=0x10		0.7		nA/°C
VC _{IDAC}	Voltage coefficient	T = 25 °C, STEPSEL=0x10		40.9		nA/V

Table 3.18. IDAC Range 2 Source

Symbol	Parameter	Condition	Min	Typ	Max	Unit
I _{IDAC}	Active current with STEPSEL=0x10	EM0, default settings		16.2		μA
		Duty-cycled		TBD		nA
I _{0x10}	Nominal IDAC output current with STEPSEL=0x10			TBD		μA
I _{STEP}	Step size			0.493		μA
I _D	Current drop at high impedance load	V _{IDAC_OUT} = V _{DD} - 100mV		1.26		%
TC _{IDAC}	Temperature coefficient	V _{DD} = 3.0 V, STEPSEL=0x10		2.8		nA/°C
VC _{IDAC}	Voltage coefficient	T = 25 °C, STEPSEL=0x10		96.6		nA/V

Table 3.19. IDAC Range 2 Sink

Symbol	Parameter	Condition	Min	Typ	Max	Unit
I _{IDAC}	Active current with STEPSEL=0x10	EM0, default settings		28.4		μA

Symbol	Parameter	Condition	Min	Typ	Max	Unit
I_{0x10}	Nominal IDAC output current with STEPSEL=0x10			8.44		μA
I_{STEP}	Step size			0.495		μA
I_{D}	Current drop at high impedance load	$V_{\text{IDAC_OUT}} = 200 \text{ mV}$		0.55		%
TC_{IDAC}	Temperature coefficient	$V_{\text{DD}} = 3.0 \text{ V}$, STEPSEL=0x10		2.8		$\text{nA}/^\circ\text{C}$
VC_{IDAC}	Voltage coefficient	$T = 25 \text{ }^\circ\text{C}$, STEPSEL=0x10		94.4		nA/V

Table 3.20. IDAC Range 3 Source

Symbol	Parameter	Condition	Min	Typ	Max	Unit
I_{IDAC}	Active current with STEPSEL=0x10	EM0, default settings		18.3		μA
		Duty-cycled		10		nA
I_{0x10}	Nominal IDAC output current with STEPSEL=0x10			34.03		μA
I_{STEP}	Step size			1.996		μA
I_{D}	Current drop at high impedance load	$V_{\text{IDAC_OUT}} = V_{\text{DD}} - 100 \text{ mV}$		3.18		%
TC_{IDAC}	Temperature coefficient	$V_{\text{DD}} = 3.0 \text{ V}$, STEPSEL=0x10		10.9		$\text{nA}/^\circ\text{C}$
VC_{IDAC}	Voltage coefficient	$T = 25 \text{ }^\circ\text{C}$, STEPSEL=0x10		159.5		nA/V

Table 3.21. IDAC Range 3 Sink

Symbol	Parameter	Condition	Min	Typ	Max	Unit
I_{IDAC}	Active current with STEPSEL=0x10	EM0, default settings		62.9		μA
I_{0x10}	Nominal IDAC output current with STEPSEL=0x10			34.16		μA
I_{STEP}	Step size			2.003		μA
I_{D}	Current drop at high impedance load	$V_{\text{IDAC_OUT}} = 200 \text{ mV}$		1.65		%
TC_{IDAC}	Temperature coefficient	$V_{\text{DD}} = 3.0 \text{ V}$, STEPSEL=0x10		10.9		$\text{nA}/^\circ\text{C}$
VC_{IDAC}	Voltage coefficient	$T = 25 \text{ }^\circ\text{C}$, STEPSEL=0x10		148.6		nA/V

Table 3.22. IDAC

Symbol	Parameter	Min	Typ	Max	Unit
$t_{\text{IDACSTART}}$	Start-up time, from enabled to output settled		40		μs

Figure 3.32. IDAC Source Current as a function of voltage on IDAC_OUT

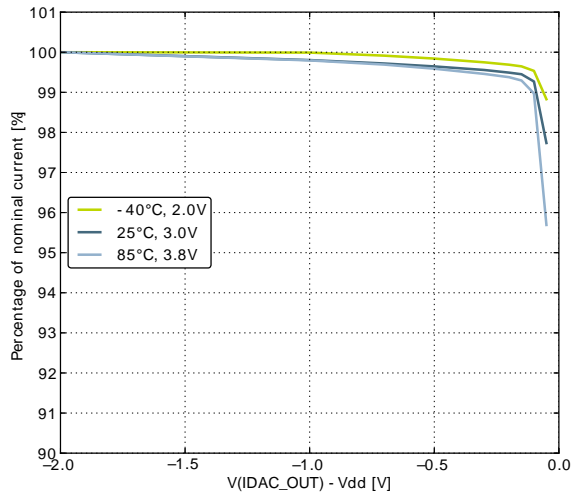

Range 0

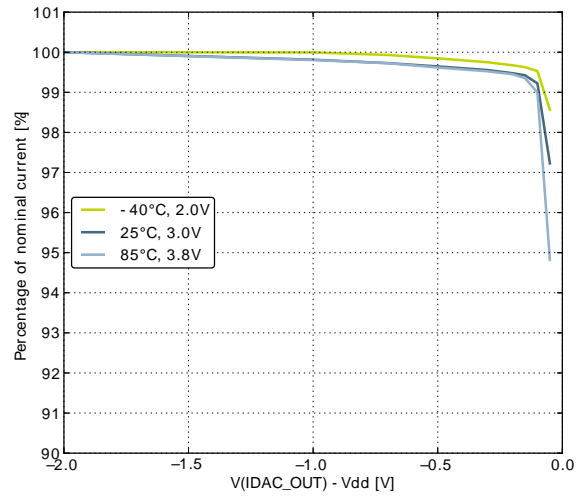

Range 1

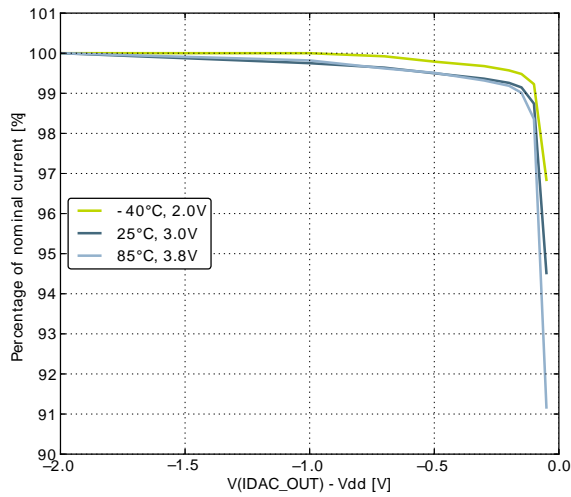

Range 2

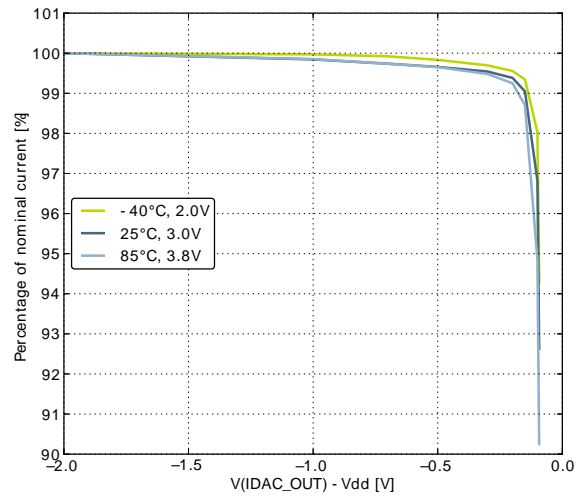

Range 3

Figure 3.33. IDAC Sink Current as a function of voltage from IDAC_OUT

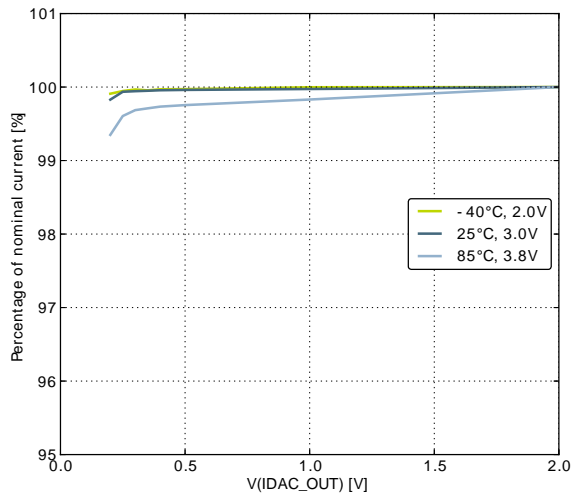

Range 0

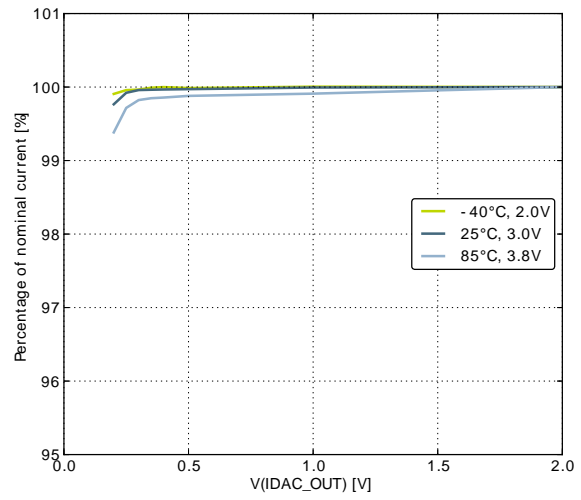

Range 1

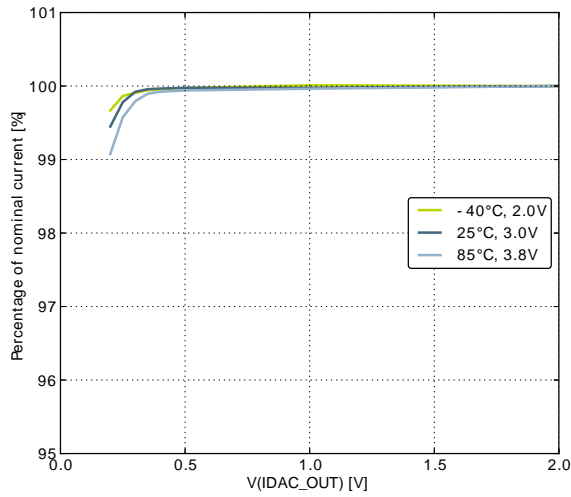

Range 2

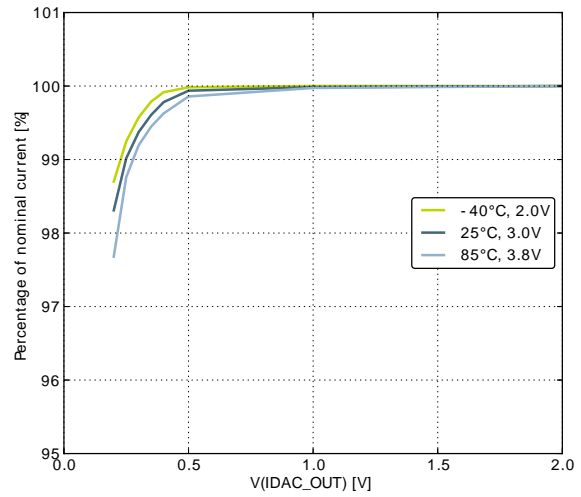

Range 3

Figure 3.34. IDAC linearity

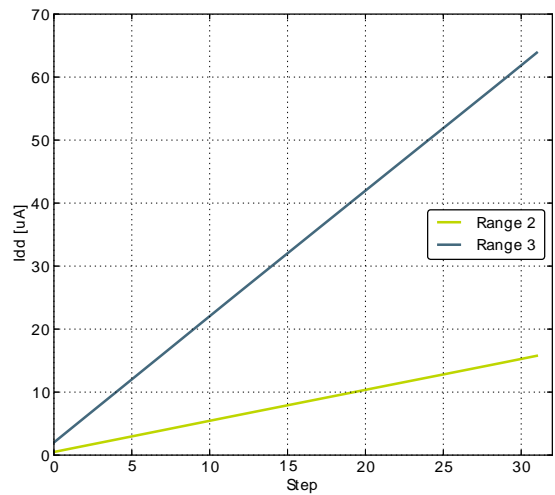
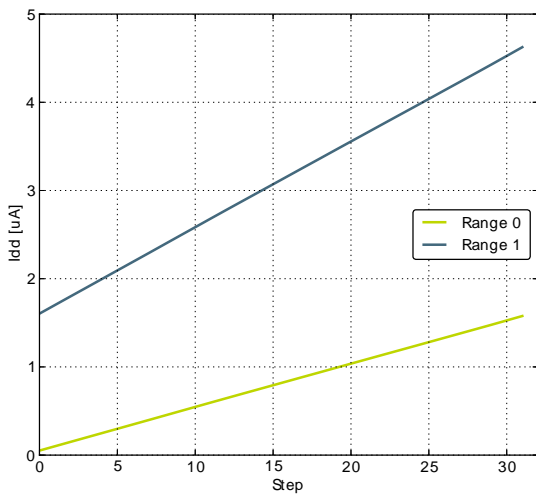

3.12 Analog Comparator (ACMP)

Table 3.23. ACMP

Symbol	Parameter	Condition	Min	Typ	Max	Unit
V _{ACMPIN}	Input voltage range		0		V _{DD}	V
V _{ACMPCM}	ACMP Common Mode voltage range		0		V _{DD}	V
I _{ACMP}	Active current	BIASPROG=0b0000, FULL-BIAS=0 and HALFBIAS=1 in ACMPn_CTRL register		0.1		μA
		BIASPROG=0b1111, FULL-BIAS=0 and HALFBIAS=0 in ACMPn_CTRL register		2.87		μA
		BIASPROG=0b1111, FULL-BIAS=1 and HALFBIAS=0 in ACMPn_CTRL register		195		μA
I _{ACMPREF}	Current consumption of internal voltage reference	Internal voltage reference off. Using external voltage reference		0		μA
		Internal voltage reference		5		μA
V _{ACMPOFFSET}	Offset voltage	Single ended		10		mV
		Differential		10		mV
V _{ACMPHYST}	ACMP hysteresis	Programmable		17		mV
R _{CSRES}	Capacitive Sense Internal Resistance	CSRESSEL=0b00 in ACMPn_INPUTSEL		39		kOhm
		CSRESSEL=0b01 in ACMPn_INPUTSEL		71		kOhm
		CSRESSEL=0b10 in ACMPn_INPUTSEL		104		kOhm
		CSRESSEL=0b11 in ACMPn_INPUTSEL		136		kOhm
t _{ACMPSTART}	Startup time				10	μs

The total ACMP current is the sum of the contributions from the ACMP and its internal voltage reference as given in Equation 3.1 (p. 43) . I_{ACMPREF} is zero if an external voltage reference is used.

Total ACMP Active Current

$$I_{ACMPTOTAL} = I_{ACMP} + I_{ACMPREF} \quad (3.1)$$

Figure 3.35. ACMP Characteristics, Vdd = 3V, Temp = 25°C, FULLBIAS = 0, HALFBIAS = 1

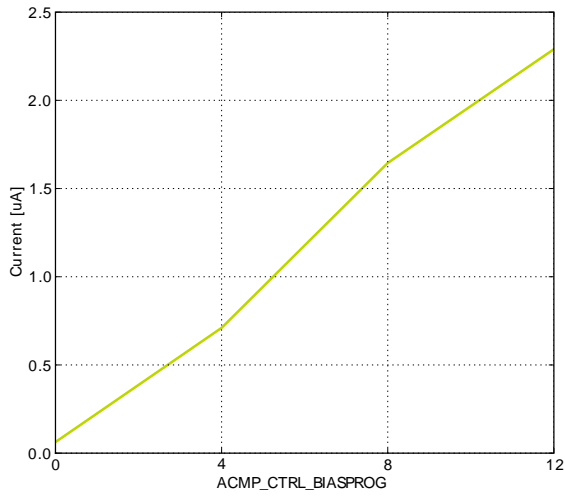

Current consumption, HYSTSEL = 4

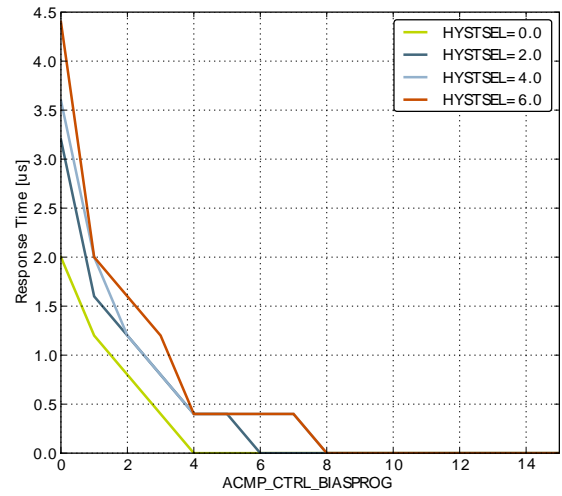

Response time

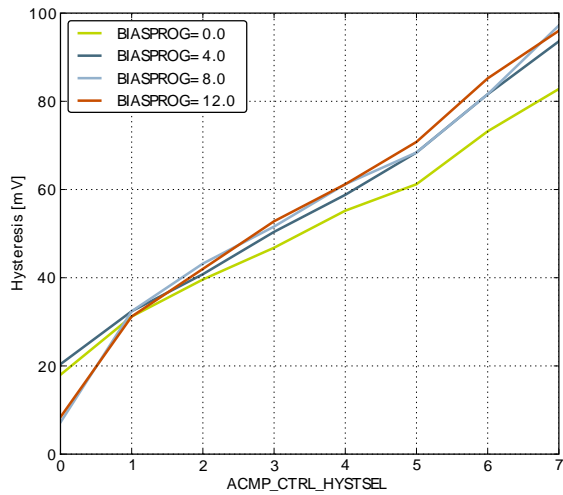

Hysteresis

3.13 Voltage Comparator (VCMP)

Table 3.24. VCMP

Symbol	Parameter	Condition	Min	Typ	Max	Unit
V _{VCMPIN}	Input voltage range			V _{DD}		V
V _{VCMP_{CM}}	VCMP Common Mode voltage range			V _{DD}		V
I _{VCMP}	Active current	BIASPROG=0b0000 and HALFBIAS=1 in VCMPn_CTRL register		0.1		μA
		BIASPROG=0b1111 and HALFBIAS=0 in VCMPn_CTRL register. LPREF=0.		14.7		μA
t _{VCMPREF}	Startup time reference generator	NORMAL		10		μs
V _{VCMP_{OFFSET}}	Offset voltage	Single ended		10		mV
		Differential		10		mV
V _{VCMPHYST}	VCMP hysteresis			17		mV
t _{VCMPSTART}	Startup time				10	μs

The V_{DD} trigger level can be configured by setting the TRIGLEVEL field of the VCMP_CTRL register in accordance with the following equation:

VCMP Trigger Level as a Function of Level Setting

$$V_{DD \text{ Trigger Level}} = 1.667V + 0.034 \times \text{TRIGLEVEL} \quad (3.2)$$

3.14 I2C

Table 3.25. I2C Standard-mode (Sm)

Symbol	Parameter	Min	Typ	Max	Unit
f _{SCL}	SCL clock frequency	0		100 ¹	kHz
t _{LOW}	SCL clock low time	4.7			μs
t _{HIGH}	SCL clock high time	4.0			μs
t _{SU,DAT}	SDA set-up time	250			ns
t _{HD,DAT}	SDA hold time	8		3450 ^{2,3}	ns
t _{SU,STA}	Repeated START condition set-up time	4.7			μs
t _{HD,STA}	(Repeated) START condition hold time	4.0			μs
t _{SU,STO}	STOP condition set-up time	4.0			μs
t _{BUF}	Bus free time between a STOP and START condition	4.7			μs

¹For the minimum HPPERCLK frequency required in Standard-mode, see the I2C chapter in the EFM32ZG Reference Manual.

²The maximum SDA hold time (t_{HD,DAT}) needs to be met only when the device does not stretch the low time of SCL (t_{LOW}).

³When transmitting data, this number is guaranteed only when I2Cn_CLKDIV < ((3450*10⁻⁹ [s] * f_{HPPERCLK} [Hz]) - 5).

Table 3.26. I2C Fast-mode (Fm)

Symbol	Parameter	Min	Typ	Max	Unit
f _{SCL}	SCL clock frequency	0		400 ¹	kHz
t _{LOW}	SCL clock low time	1.3			μs
t _{HIGH}	SCL clock high time	0.6			μs
t _{SU,DAT}	SDA set-up time	100			ns
t _{HD,DAT}	SDA hold time	8		900 ^{2,3}	ns
t _{SU,STA}	Repeated START condition set-up time	0.6			μs
t _{HD,STA}	(Repeated) START condition hold time	0.6			μs
t _{SU,STO}	STOP condition set-up time	0.6			μs
t _{BUF}	Bus free time between a STOP and START condition	1.3			μs

¹For the minimum HFPERCLK frequency required in Fast-mode, see the I2C chapter in the EFM32ZG Reference Manual.

²The maximum SDA hold time (t_{HD,DAT}) needs to be met only when the device does not stretch the low time of SCL (t_{LOW}).

³When transmitting data, this number is guaranteed only when I2Cn_CLKDIV < ((900*10⁻⁹ [s] * f_{HFPERCLK} [Hz]) - 5).

Table 3.27. I2C Fast-mode Plus (Fm+)

Symbol	Parameter	Min	Typ	Max	Unit
f _{SCL}	SCL clock frequency	0		1000 ¹	kHz
t _{LOW}	SCL clock low time	0.5			μs
t _{HIGH}	SCL clock high time	0.26			μs
t _{SU,DAT}	SDA set-up time	50			ns
t _{HD,DAT}	SDA hold time	8			ns
t _{SU,STA}	Repeated START condition set-up time	0.26			μs
t _{HD,STA}	(Repeated) START condition hold time	0.26			μs
t _{SU,STO}	STOP condition set-up time	0.26			μs
t _{BUF}	Bus free time between a STOP and START condition	0.5			μs

¹For the minimum HFPERCLK frequency required in Fast-mode Plus, see the I2C chapter in the EFM32ZG Reference Manual.

3.15 Digital Peripherals

Table 3.28. Digital Peripherals

Symbol	Parameter	Condition	Min	Typ	Max	Unit
I _{USART}	USART current	USART idle current, clock enabled		7.5		μA/ MHz
I _{I2C}	I2C current	I2C idle current, clock enabled		6.25		μA/ MHz
I _{TIMER}	TIMER current	TIMER_0 idle current, clock enabled		8.75		μA/ MHz
I _{PCNT}	PCNT current	PCNT idle current, clock enabled		100		nA
I _{RTC}	RTC current	RTC idle current, clock enabled		100		nA
I _{AES}	AES current	AES idle current, clock enabled		2.5		μA/ MHz

Symbol	Parameter	Condition	Min	Typ	Max	Unit
I _{GPIO}	GPIO current	GPIO idle current, clock enabled		5.31		μA/ MHz
I _{PRS}	PRS current	PRS idle current		2,81		μA/ MHz

4 Pinout and Package

Note

Please refer to the application note "AN0002 EFM32 Hardware Design Considerations" for guidelines on designing Printed Circuit Boards (PCB's) for the EFM32ZG222.

4.1 Pinout

The EFM32ZG222 pinout is shown in Figure 4.1 (p. 48) and Table 4.1 (p. 48). Alternate locations are denoted by "#" followed by the location number (Multiple locations on the same pin are split with "/"). Alternate locations can be configured in the LOCATION bitfield in the *_ROUTE register in the module in question.

Figure 4.1. EFM32ZG222 Pinout (top view, not to scale)

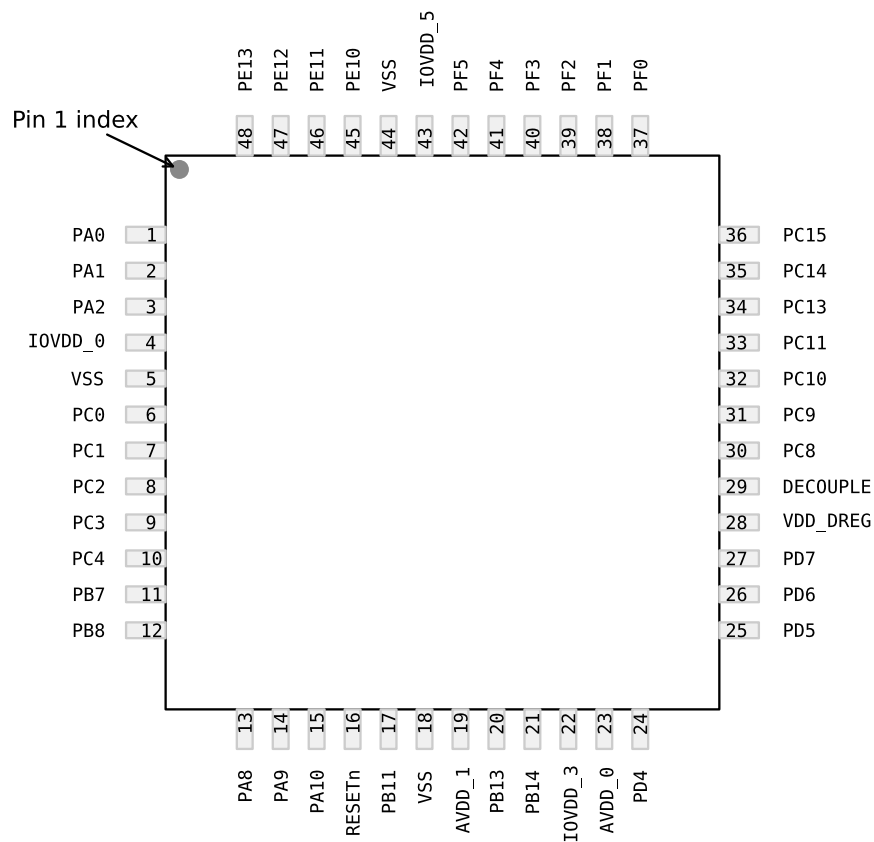

Table 4.1. Device Pinout

QFP48 Pin# and Name		Pin Alternate Functionality / Description			
Pin #	Pin Name	Analog	Timers	Communication	Other
1	PA0		TIM0_CC0 #0/1/4	LEU0_RX #4 I2C0_SDA #0	PRS_CH0 #0 GPIO_EM4WU0
2	PA1		TIM0_CC1 #0/1	I2C0_SCL #0	CMU_CLK1 #0 PRS_CH1 #0

QFP48 Pin# and Name		Pin Alternate Functionality / Description			
Pin #	Pin Name	Analog	Timers	Communication	Other
3	PA2		TIM0_CC2 #0/1		CMU_CLK0 #0
4	IOVDD_0	Digital IO power supply 0.			
5	VSS	Ground			
6	PC0	ACMP0_CH0	TIM0_CC1 #4 PCNT0_S0IN #2	US1_TX #0 I2C0_SDA #4	PRS_CH2 #0
7	PC1	ACMP0_CH1	TIM0_CC2 #4 PCNT0_S1IN #2	US1_RX #0 I2C0_SCL #4	PRS_CH3 #0
8	PC2	ACMP0_CH2			
9	PC3	ACMP0_CH3			
10	PC4	ACMP0_CH4			
11	PB7	LFXTAL_P	TIM1_CC0 #3	US1_CLK #0	
12	PB8	LFXTAL_N	TIM1_CC1 #3	US1_CS #0	
13	PA8				
14	PA9				
15	PA10				
16	RESETn	Reset input, active low. To apply an external reset source to this pin, it is required to only drive this pin low during reset, and let the internal pull-up ensure that reset is released.			
17	PB11	IDAC0_OUT	TIM1_CC2 #3		
18	VSS	Ground			
19	AVDD_1	Analog power supply 1.			
20	PB13	HFXTAL_P		LEU0_TX #1	
21	PB14	HFXTAL_N		LEU0_RX #1	
22	IOVDD_3	Digital IO power supply 3.			
23	AVDD_0	Analog power supply 0.			
24	PD4	ADC0_CH4		LEU0_TX #0	
25	PD5	ADC0_CH5		LEU0_RX #0	
26	PD6	ADC0_CH6	TIM1_CC0 #4 PCNT0_S0IN #3	US1_RX #2/3 I2C0_SDA #1	ACMP0_O #2
27	PD7	ADC0_CH7	TIM1_CC1 #4 PCNT0_S1IN #3	US1_TX #2/3 I2C0_SCL #1	CMU_CLK0 #2
28	VDD_DREG	Power supply for on-chip voltage regulator.			
29	DECOUPLE	Decouple output for on-chip voltage regulator. An external capacitance of size C _{DECOUPLE} is required at this pin.			
30	PC8				
31	PC9				GPIO_EM4WU2
32	PC10				
33	PC11				
34	PC13		TIM1_CC0 #0 TIM1_CC2 #4 PCNT0_S0IN #0		
35	PC14		TIM1_CC1 #0 PCNT0_S1IN #0	US1_CS #3	PRS_CH0 #2
36	PC15		TIM1_CC2 #0	US1_CLK #3	PRS_CH1 #2
37	PF0		TIM0_CC0 #5	US1_CLK #2	DBG_SWCLK #0

QFP48 Pin# and Name		Pin Alternate Functionality / Description			
Pin #	Pin Name	Analog	Timers	Communication	Other
				LEU0_TX #3 I2C0_SDA #5	BOOT_TX
38	PF1		TIM0_CC1 #5	US1_CS #2 LEU0_RX #3 I2C0_SCL #5	DBG_SWDIO #0 GPIO_EM4WU3 BOOT_RX
39	PF2		TIM0_CC2 #5	LEU0_TX #4	GPIO_EM4WU4
40	PF3				PRS_CH0 #1
41	PF4				PRS_CH1 #1
42	PF5				PRS_CH2 #1
43	IOVDD_5	Digital IO power supply 5.			
44	VSS	Ground			
45	PE10		TIM1_CC0 #1		PRS_CH2 #2
46	PE11		TIM1_CC1 #1		PRS_CH3 #2
47	PE12		TIM1_CC2 #1	I2C0_SDA #6	CMU_CLK1 #2
48	PE13			I2C0_SCL #6	ACMP0_O #0 GPIO_EM4WU5

4.2 Alternate Functionality Pinout

A wide selection of alternate functionality is available for multiplexing to various pins. This is shown in Table 4.2 (p. 50). The table shows the name of the alternate functionality in the first column, followed by columns showing the possible LOCATION bitfield settings.

Note

Some functionality, such as analog interfaces, do not have alternate settings or a LOCATION bitfield. In these cases, the pinout is shown in the column corresponding to LOCATION 0.

Table 4.2. Alternate functionality overview

Alternate Functionality	LOCATION							Description
	0	1	2	3	4	5	6	
ACMP0_CH0	PC0							Analog comparator ACMP0, channel 0.
ACMP0_CH1	PC1							Analog comparator ACMP0, channel 1.
ACMP0_CH2	PC2							Analog comparator ACMP0, channel 2.
ACMP0_CH3	PC3							Analog comparator ACMP0, channel 3.
ACMP0_CH4	PC4							Analog comparator ACMP0, channel 4.
ACMP0_O	PE13		PD6					Analog comparator ACMP0, digital output.
ADC0_CH4	PD4							Analog to digital converter ADC0, input channel number 4.
ADC0_CH5	PD5							Analog to digital converter ADC0, input channel number 5.
ADC0_CH6	PD6							Analog to digital converter ADC0, input channel number 6.
ADC0_CH7	PD7							Analog to digital converter ADC0, input channel number 7.
BOOT_RX	PF1							Bootloader RX
BOOT_TX	PF0							Bootloader TX
CMU_CLK0	PA2		PD7					Clock Management Unit, clock output number 0.

Alternate	LOCATION							Description
	0	1	2	3	4	5	6	
CMU_CLK1	PA1		PE12					Clock Management Unit, clock output number 1.
DBG_SWCLK	PF0							Debug-interface Serial Wire clock input. Note that this function is enabled to pin out of reset, and has a built-in pull down.
DBG_SWDIO	PF1							Debug-interface Serial Wire data input / output. Note that this function is enabled to pin out of reset, and has a built-in pull up.
GPIO_EM4WU0	PA0							Pin can be used to wake the system up from EM4
GPIO_EM4WU2	PC9							Pin can be used to wake the system up from EM4
GPIO_EM4WU3	PF1							Pin can be used to wake the system up from EM4
GPIO_EM4WU4	PF2							Pin can be used to wake the system up from EM4
GPIO_EM4WU5	PE13							Pin can be used to wake the system up from EM4
HFX TAL_N	PB14							High Frequency Crystal negative pin. Also used as external optional clock input pin.
HFX TAL_P	PB13							High Frequency Crystal positive pin.
I2C0_SCL	PA1	PD7			PC1	PF1	PE13	I2C0 Serial Clock Line input / output.
I2C0_SDA	PA0	PD6			PC0	PF0	PE12	I2C0 Serial Data input / output.
IDAC0_OUT	PB11							IDAC0 output
LEU0_RX	PD5	PB14		PF1	PA0			LEUART0 Receive input.
LEU0_TX	PD4	PB13		PF0	PF2			LEUART0 Transmit output. Also used as receive input in half duplex communication.
LFXTAL_N	PB8							Low Frequency Crystal (typically 32.768 kHz) negative pin. Also used as an optional external clock input pin.
LFXTAL_P	PB7							Low Frequency Crystal (typically 32.768 kHz) positive pin.
PCNT0_S0IN	PC13		PC0	PD6				Pulse Counter PCNT0 input number 0.
PCNT0_S1IN	PC14		PC1	PD7				Pulse Counter PCNT0 input number 1.
PRS_CH0	PA0	PF3	PC14					Peripheral Reflex System PRS, channel 0.
PRS_CH1	PA1	PF4	PC15					Peripheral Reflex System PRS, channel 1.
PRS_CH2	PC0	PF5	PE10					Peripheral Reflex System PRS, channel 2.
PRS_CH3	PC1		PE11					Peripheral Reflex System PRS, channel 3.
TIM0_CC0	PA0	PA0			PA0	PF0		Timer 0 Capture Compare input / output channel 0.
TIM0_CC1	PA1	PA1			PC0	PF1		Timer 0 Capture Compare input / output channel 1.
TIM0_CC2	PA2	PA2			PC1	PF2		Timer 0 Capture Compare input / output channel 2.
TIM1_CC0	PC13	PE10		PB7	PD6			Timer 1 Capture Compare input / output channel 0.
TIM1_CC1	PC14	PE11		PB8	PD7			Timer 1 Capture Compare input / output channel 1.
TIM1_CC2	PC15	PE12		PB11	PC13			Timer 1 Capture Compare input / output channel 2.
US1_CLK	PB7		PF0	PC15				USART1 clock input / output.
US1_CS	PB8		PF1	PC14				USART1 chip select input / output.
US1_RX	PC1		PD6	PD6				USART1 Asynchronous Receive. USART1 Synchronous mode Master Input / Slave Output (MISO).
US1_TX	PC0		PD7	PD7				USART1 Asynchronous Transmit. Also used as receive input in half duplex communication. USART1 Synchronous mode Master Output / Slave Input (MOSI).

4.3 GPIO Pinout Overview

The specific GPIO pins available in *EFM32ZG222* is shown in Table 4.3 (p. 52). Each GPIO port is organized as 16-bit ports indicated by letters A through F, and the individual pin on this port is indicated by a number from 15 down to 0.

Table 4.3. GPIO Pinout

Port	Pin 15	Pin 14	Pin 13	Pin 12	Pin 11	Pin 10	Pin 9	Pin 8	Pin 7	Pin 6	Pin 5	Pin 4	Pin 3	Pin 2	Pin 1	Pin 0
Port A	-	-	-	-	-	PA10	PA9	PA8	-	-	-	-	-	PA2	PA1	PA0
Port B	-	PB14	PB13	-	PB11	-	-	PB8	PB7	-	-	-	-	-	-	-
Port C	PC15	PC14	PC13	-	PC11	PC10	PC9	PC8	-	-	-	PC4	PC3	PC2	PC1	PC0
Port D	-	-	-	-	-	-	-	-	PD7	PD6	PD5	PD4	-	-	-	-
Port E	-	-	PE13	PE12	PE11	PE10	-	-	-	-	-	-	-	-	-	-
Port F	-	-	-	-	-	-	-	-	-	-	PF5	PF4	PF3	PF2	PF1	PF0

4.4 TQFP48 Package

Figure 4.2. TQFP48

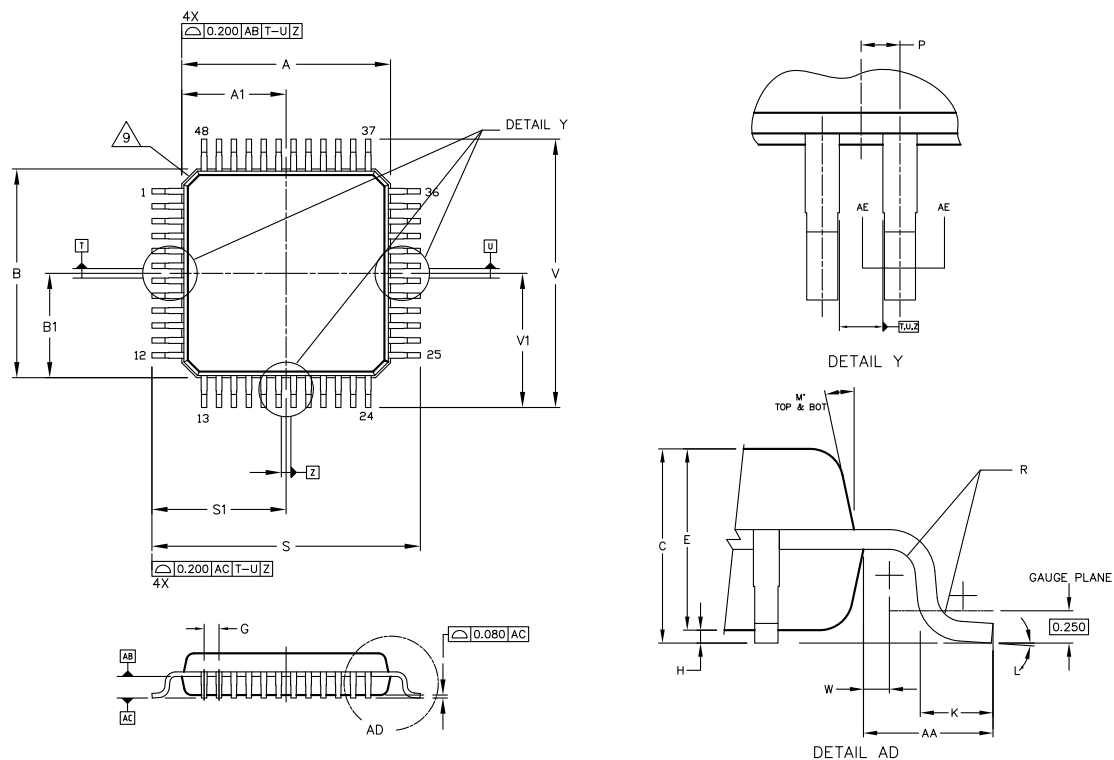

Rev: 98SP46097A_XO_30Mar11

Note:

1. Dimensions and tolerance per ASME Y14.5M-1994
2. Control dimension: Millimeter.
3. Datum plane AB is located at bottom of lead and is coincident with the lead where the lead exists from the plastic body at the bottom of the parting line.
4. Datums T, U and Z to be determined at datum plane AB.

5. Dimensions S and V to be determined at seating plane AC.
6. Dimensions A and B do not include mold protrusion. Allowable protrusion is 0.250 per side. Dimensions A and B do include mold mismatch and are determined at datum AB.
7. Dimension D does not include dambar protrusion. Dambar protrusion shall not cause the D dimension to exceed 0.350.
8. Minimum solder plate thickness shall be 0.0076.
9. Exact shape of each corner is optional.

Table 4.4. QFP48 (Dimensions in mm)

DIM	MIN	NOM	MAX	DIM	MIN	NOM	MAX
A	-	7.000 BSC	-	M	-	12DEG REF	-
A1	-	3.500 BSC	-	N	0.090	-	0.160
B	-	7.000 BSC	-	P	-	0.250 BSC	-
B1	-	3.500 BSC	-	R	0.150	-	0.250
C	1.000	-	1.200	S	-	9.000 BSC	-
D	0.170	-	0.270	S1	-	4.500 BSC	-
E	0.950	-	1.050	V	-	9.000 BSC	-
F	0.170	-	0.230	V1	-	4.500 BSC	-
G	-	0.500 BSC	-	W	-	0.200 BSC	-
H	0.050	-	0.150	AA	-	1.000 BSC	-
J	0.090	-	0.200				
K	0.500	-	0.700				
L	0DEG	-	7DEG				

The TQFP48 Package is 7 by 7 mm in size and has a 0.5 mm pin pitch.

The TQFP48 Package uses Nickel-Palladium-Gold preplated leadframe.

All EFM32 packages are RoHS compliant and free of Bromine (Br) and Antimony (Sb).

5 PCB Layout and Soldering

5.1 Recommended PCB Layout

Figure 5.1. TQFP48 PCB Land Pattern

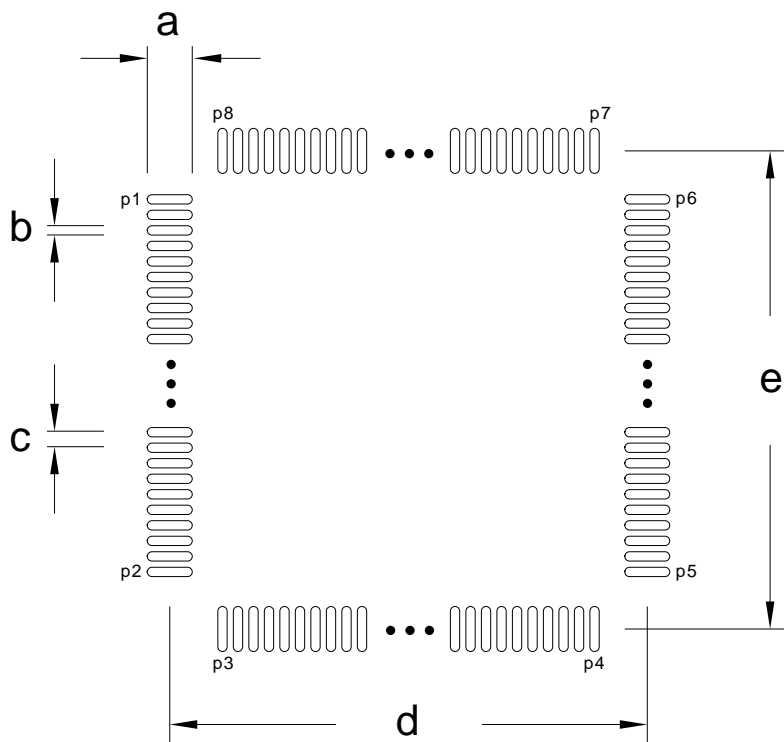

Table 5.1. QFP48 PCB Land Pattern Dimensions (Dimensions in mm)

Symbol	Dim. (mm)	Symbol	Pin number	Symbol	Pin number
a	1.60	P1	1	P6	36
b	0.30	P2	12	P7	37
c	0.50	P3	13	P8	48
d	8.50	P4	24	-	-
e	8.50	P5	25	-	-

Figure 5.2. TQFP48 PCB Solder Mask

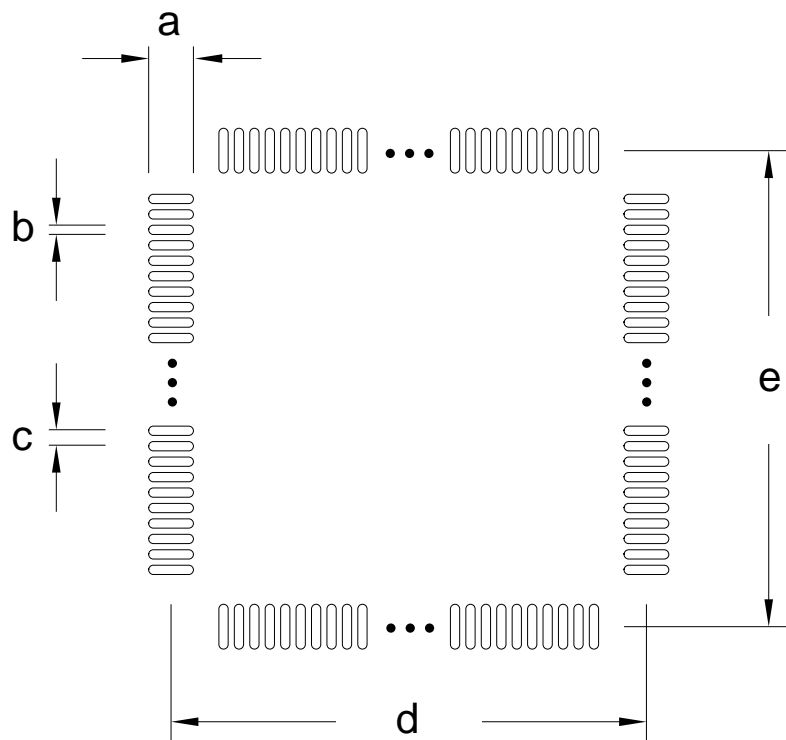

Table 5.2. QFP48 PCB Solder Mask Dimensions (Dimensions in mm)

Symbol	Dim. (mm)
a	1.72
b	0.42
c	0.50
d	8.50
e	8.50

Figure 5.3. TQFP48 PCB Stencil Design

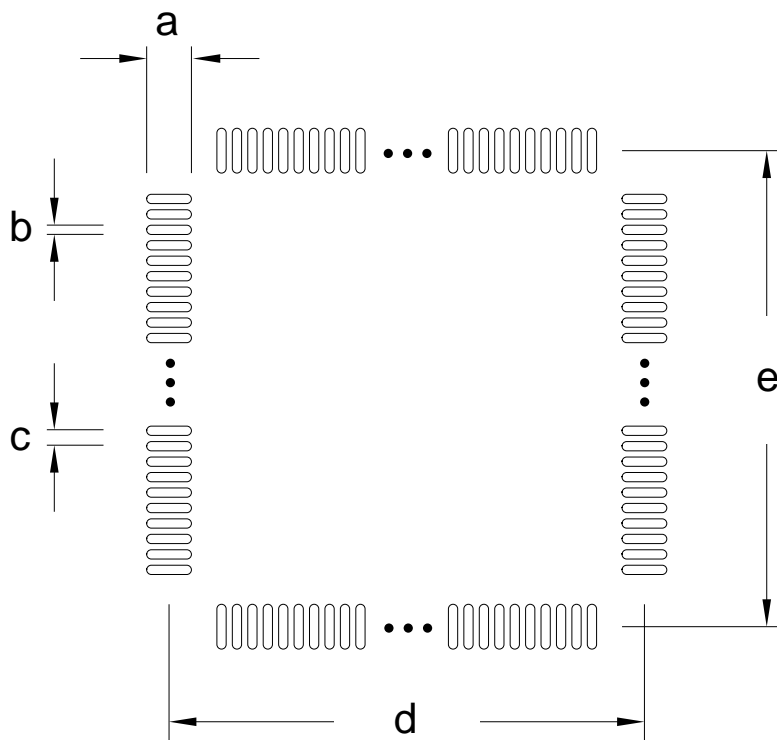

Table 5.3. QFP48 PCB Stencil Design Dimensions (Dimensions in mm)

Symbol	Dim. (mm)
a	1.50
b	0.20
c	0.50
d	8.50
e	8.50

1. The drawings are not to scale.
2. All dimensions are in millimeters.
3. All drawings are subject to change without notice.
4. The PCB Land Pattern drawing is in compliance with IPC-7351B.
5. Stencil thickness 0.125 mm.
6. For detailed pin-positioning, see Figure 4.2 (p. 52) .

5.2 Soldering Information

The latest IPC/JEDEC J-STD-020 recommendations for Pb-Free reflow soldering should be followed.

The packages have a Moisture Sensitivity Level rating of 3, please see the latest IPC/JEDEC J-STD-033 standard for MSL description and level 3 bake conditions.

6 Chip Marking, Revision and Errata

6.1 Chip Marking

In the illustration below package fields and position are shown.

Figure 6.1. Example Chip Marking

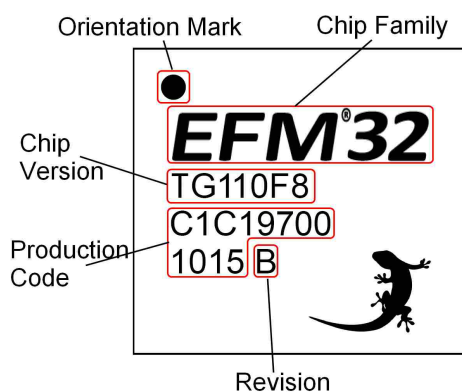

6.2 Revision

The revision of a chip can be determined from the "Revision" field in Figure 6.1 (p. 57). If the revision says "ES" (Engineering Sample), the revision must be read out electronically as specified in the reference manual.

6.3 Errata

No known errata for EFM32ZG222.

7 Revision History

7.1 Revision 0.60

October 9th, 2013

Added I2C characterization data.

Added IDAC characterization data.

Updated current consumption table and figures in Electrical characteristics section.

Corrected the ADC resolution from 12, 10 and 6 bit to 12, 8 and 6 bit.

Removed Environmental information.

Updated trademark, disclaimer and contact information.

Other minor corrections.

7.2 Revision 0.50

April 22nd, 2013

Updated HFCORE max frequency from 32 MHz to 24 MHz.

Updated pinout.

Other minor corrections.

7.3 Revision 0.40

September 11th, 2012

Updated CPU core from Cortex M0 to Cortex M0+.

Updated the HFRCO 1 MHz band typical value to 1.2 MHz.

Updated the HFRCO 7 MHz band typical value to 6.6 MHz.

Corrected operating voltage from 1.8 V to 1.85 V.

Other minor corrections.

7.4 Revision 0.30

July 16th, 2011

Updated the Electrical Characteristics section.

7.5 Revision 0.20

June 8th, 2011

Corrected all current values in Electrical Characteristics section.

Updated Cortex M0 related items in the memory map.

7.6 Revision 0.10

June 7th, 2011

Initial preliminary release.

A Disclaimer and Trademarks

A.1 Disclaimer

Silicon Laboratories intends to provide customers with the latest, accurate, and in-depth documentation of all peripherals and modules available for system and software implementers using or intending to use the Silicon Laboratories products. Characterization data, available modules and peripherals, memory sizes and memory addresses refer to each specific device, and "Typical" parameters provided can and do vary in different applications. Application examples described herein are for illustrative purposes only. Silicon Laboratories reserves the right to make changes without further notice and limitation to product information, specifications, and descriptions herein, and does not give warranties as to the accuracy or completeness of the included information. Silicon Laboratories shall have no liability for the consequences of use of the information supplied herein. This document does not imply or express copyright licenses granted hereunder to design or fabricate any integrated circuits. The products must not be used within any Life Support System without the specific written consent of Silicon Laboratories. A "Life Support System" is any product or system intended to support or sustain life and/or health, which, if it fails, can be reasonably expected to result in significant personal injury or death. Silicon Laboratories products are generally not intended for military applications. Silicon Laboratories products shall under no circumstances be used in weapons of mass destruction including (but not limited to) nuclear, biological or chemical weapons, or missiles capable of delivering such weapons.

A.2 Trademark Information

Silicon Laboratories Inc., Silicon Laboratories, Silicon Labs, SiLabs and the Silicon Labs logo, CMEMS[®], EFM, EFM32, EFR, Energy Micro, Energy Micro logo and combinations thereof, "the world's most energy friendly microcontrollers", Ember[®], EZLink[®], EZMac[®], EZRadio[®], EZRadioPRO[®], DSPLL[®], ISO-modem[®], Precision32[®], ProSLIC[®], SiPHY[®], USBXpress[®] and others are trademarks or registered trademarks of Silicon Laboratories Inc. ARM, CORTEX, Cortex-M3 and THUMB are trademarks or registered trademarks of ARM Holdings. Keil is a registered trademark of ARM Limited. All other products or brand names mentioned herein are trademarks of their respective holders.

B Contact Information

Silicon Laboratories Inc.

400 West Cesar Chavez

Austin, TX 78701

Please visit the Silicon Labs Technical Support web page:

<http://www.silabs.com/support/pages/contacttechnicalsupport.aspx>

and register to submit a technical support request.

Table of Contents

1. Ordering Information	2
2. System Summary	3
2.1. System Introduction	3
2.2. Configuration Summary	6
2.3. Memory Map	7
3. Electrical Characteristics	8
3.1. Test Conditions	8
3.2. Absolute Maximum Ratings	8
3.3. General Operating Conditions	8
3.4. Current Consumption	9
3.5. Transition between Energy Modes	16
3.6. Power Management	16
3.7. Flash	17
3.8. General Purpose Input Output	18
3.9. Oscillators	25
3.10. Analog Digital Converter (ADC)	28
3.11. Current Digital Analog Converter (IDAC)	38
3.12. Analog Comparator (ACMP)	43
3.13. Voltage Comparator (VCMP)	45
3.14. I2C	45
3.15. Digital Peripherals	46
4. Pinout and Package	48
4.1. Pinout	48
4.2. Alternate Functionality Pinout	50
4.3. GPIO Pinout Overview	52
4.4. TQFP48 Package	52
5. PCB Layout and Soldering	54
5.1. Recommended PCB Layout	54
5.2. Soldering Information	56
6. Chip Marking, Revision and Errata	57
6.1. Chip Marking	57
6.2. Revision	57
6.3. Errata	57
7. Revision History	58
7.1. Revision 0.60	58
7.2. Revision 0.50	58
7.3. Revision 0.40	58
7.4. Revision 0.30	58
7.5. Revision 0.20	58
7.6. Revision 0.10	59
A. Disclaimer and Trademarks	60
A.1. Disclaimer	60
A.2. Trademark Information	60
B. Contact Information	61
B.1.	61

List of Figures

2.1. Block Diagram	3
2.2. EFM32ZG222 Memory Map with largest RAM and Flash sizes	7
3.1. EM0 Current consumption while executing prime number calculation code from flash with HFRCO running at 24MHz	10
3.2. EM0 Current consumption while executing prime number calculation code from flash with HFRCO running at 21MHz	10
3.3. EM0 Current consumption while executing prime number calculation code from flash with HFRCO running at 14MHz	11
3.4. EM0 Current consumption while executing prime number calculation code from flash with HFRCO running at 11MHz	11
3.5.	12
3.6. EM1 Current consumption with all peripheral clocks disabled and HFRCO running at 24MHz	12
3.7. EM1 Current consumption with all peripheral clocks disabled and HFRCO running at 21MHz	13
3.8. EM1 Current consumption with all peripheral clocks disabled and HFRCO running at 14MHz	13
3.9. EM1 Current consumption with all peripheral clocks disabled and HFRCO running at 11MHz	14
3.10.	14
3.11. EM2 current consumption. RTC prescaled to 1kHz, 32.768 kHz LFRCO.	15
3.12. EM3 current consumption.	15
3.13. EM4 current consumption.	16
3.14. Typical Low-Level Output Current, 2V Supply Voltage	19
3.15. Typical High-Level Output Current, 2V Supply Voltage	20
3.16. Typical Low-Level Output Current, 3V Supply Voltage	21
3.17. Typical High-Level Output Current, 3V Supply Voltage	22
3.18. Typical Low-Level Output Current, 3.8V Supply Voltage	23
3.19. Typical High-Level Output Current, 3.8V Supply Voltage	24
3.20. Calibrated LFRCO Frequency vs Temperature and Supply Voltage	26
3.21. Calibrated HFRCO 11 MHz Band Frequency vs Supply Voltage and Temperature	27
3.22. Calibrated HFRCO 14 MHz Band Frequency vs Supply Voltage and Temperature	28
3.23. Calibrated HFRCO 21 MHz Band Frequency vs Supply Voltage and Temperature	28
3.24. Integral Non-Linearity (INL)	33
3.25. Differential Non-Linearity (DNL)	33
3.26. ADC Frequency Spectrum, Vdd = 3V, Temp = 25°C	34
3.27. ADC Integral Linearity Error vs Code, Vdd = 3V, Temp = 25°C	35
3.28. ADC Differential Linearity Error vs Code, Vdd = 3V, Temp = 25°C	36
3.29. ADC Absolute Offset, Common Mode = Vdd /2	37
3.30. ADC Dynamic Performance vs Temperature for all ADC References, Vdd = 3V	37
3.31. ADC Temperature sensor readout	38
3.32. IDAC Source Current as a function of voltage on IDAC_OUT	41
3.33. IDAC Sink Current as a function of voltage from IDAC_OUT	42
3.34. IDAC linearity	42
3.35. ACMP Characteristics, Vdd = 3V, Temp = 25°C, FULLBIAS = 0, HALFBIAS = 1	44
4.1. EFM32ZG222 Pinout (top view, not to scale)	48
4.2. TQFP48	52
5.1. TQFP48 PCB Land Pattern	54
5.2. TQFP48 PCB Solder Mask	55
5.3. TQFP48 PCB Stencil Design	56
6.1. Example Chip Marking	57

List of Tables

1.1. Ordering Information	2
2.1. Configuration Summary	6
3.1. Absolute Maximum Ratings	8
3.2. General Operating Conditions	8
3.3. Current Consumption	9
3.4. Energy Modes Transitions	16
3.5. Power Management	17
3.6. Flash	17
3.7. GPIO	18
3.8. LFXO	25
3.9. HFXO	25
3.10. LFRCO	26
3.11. HFRCO	27
3.12. ULFRCO	28
3.13. ADC	28
3.14. IDAC Range 0 Source	38
3.15. IDAC Range 0 Sink	38
3.16. IDAC Range 1 Source	39
3.17. IDAC Range 1 Sink	39
3.18. IDAC Range 2 Source	39
3.19. IDAC Range 2 Sink	39
3.20. IDAC Range 3 Source	40
3.21. IDAC Range 3 Sink	40
3.22. IDAC	40
3.23. ACMP	43
3.24. VCMP	45
3.25. I2C Standard-mode (Sm)	45
3.26. I2C Fast-mode (Fm)	46
3.27. I2C Fast-mode Plus (Fm+)	46
3.28. Digital Peripherals	46
4.1. Device Pinout	48
4.2. Alternate functionality overview	50
4.3. GPIO Pinout	52
4.4. QFP48 (Dimensions in mm)	53
5.1. QFP48 PCB Land Pattern Dimensions (Dimensions in mm)	54
5.2. QFP48 PCB Solder Mask Dimensions (Dimensions in mm)	55
5.3. QFP48 PCB Stencil Design Dimensions (Dimensions in mm)	56

List of Equations

3.1. Total ACMP Active Current	43
3.2. VCMP Trigger Level as a Function of Level Setting	45

silabs.com

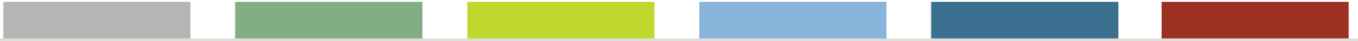

ZERO
ARM Cortex-M0+

TINY
ARM Cortex-M3

GECKO
ARM Cortex-M3

LEOPARD
ARM Cortex-M3

GIANT
ARM Cortex-M3

WONDER
ARM Cortex-M4



Компания «ЭлектроПласт» предлагает заключение долгосрочных отношений при поставках импортных электронных компонентов на взаимовыгодных условиях!

Наши преимущества:

- Оперативные поставки широкого спектра электронных компонентов отечественного и импортного производства напрямую от производителей и с крупнейших мировых складов;
- Поставка более 17-ти миллионов наименований электронных компонентов;
- Поставка сложных, дефицитных, либо снятых с производства позиций;
- Оперативные сроки поставки под заказ (от 5 рабочих дней);
- Экспресс доставка в любую точку России;
- Техническая поддержка проекта, помощь в подборе аналогов, поставка прототипов;
- Система менеджмента качества сертифицирована по Международному стандарту ISO 9001;
- Лицензия ФСБ на осуществление работ с использованием сведений, составляющих государственную тайну;
- Поставка специализированных компонентов (Xilinx, Altera, Analog Devices, Intersil, Interpoint, Microsemi, Aeroflex, Peregrine, Syfer, Eurofarad, Texas Instrument, Miteq, Cobham, E2V, MA-COM, Hittite, Mini-Circuits, General Dynamics и др.);

Помимо этого, одним из направлений компании «ЭлектроПласт» является направление «Источники питания». Мы предлагаем Вам помощь Конструкторского отдела:

- Подбор оптимального решения, техническое обоснование при выборе компонента;
- Подбор аналогов;
- Консультации по применению компонента;
- Поставка образцов и прототипов;
- Техническая поддержка проекта;
- Защита от снятия компонента с производства.



Как с нами связаться

Телефон: 8 (812) 309 58 32 (многоканальный)

Факс: 8 (812) 320-02-42

Электронная почта: org@eplast1.ru

Адрес: 198099, г. Санкт-Петербург, ул. Калинина, дом 2, корпус 4, литера А.