

260-Pin BGA  
Com & Ind Temp  
HSTL I/O

144Mb SigmaDDR-IIIe™  
Burst of 2 ECCRAM™

Up to 833 MHz  
1.25V ~ 1.3V V<sub>DD</sub>  
1.5V V<sub>DDQ</sub>

## Features

- 4Mb x 36 and 8Mb x 18 organizations available
- 833 MHz maximum operating frequency
- 833 MT/s peak transaction rate (in millions per second)
- 60 Gb/s peak data bandwidth (in x36 devices)
- Common I/O DDR Data Bus
- Non-multiplexed SDR Address Bus
- One operation - Read or Write - per clock cycle
- Burst of 2 Read and Write operations
- 3 cycle Read Latency
- On-chip ECC with virtually zero SER
- 1.25V ~ 1.3V core voltage
- 1.5V HSTL I/O interface
- Configurable ODT (on-die termination)
- ZQ pin for programmable driver impedance
- ZT pin for programmable ODT impedance
- IEEE 1149.1 JTAG-compliant Boundary Scan
- 260-pin, 14 mm x 22 mm, 1 mm ball pitch, 6/6 RoHS-compliant BGA package

## SigmaDDR-IIIe™ Family Overview

SigmaDDR-IIIe ECCRAMs are the Common I/O half of the SigmaQuad-IIIe/SigmaDDR-IIIe family of high performance ECCRAMs. Although very similar to GSI's second generation of networking SRAMs (the SigmaQuad-II/SigmaDDR-II family), these third generation devices offer several new features that help enable significantly higher performance.

## Clocking and Addressing Schemes

The GS81313HT18/36GK SigmaDDR-IIIe ECCRAMs are synchronous devices. They employ three pairs of positive and negative input clocks; one pair of master clocks,  $\overline{CK}$  and  $\overline{CK}$ , and two pairs of write data clocks,  $\overline{KD}[1:0]$  and  $\overline{KD}[1:0]$ . All six input clocks are single-ended; that is, each is received by a dedicated input buffer.

$\overline{CK}$  and  $\overline{CK}$  are used to latch address and control inputs, and to control all output timing.  $\overline{KD}[1:0]$  and  $\overline{KD}[1:0]$  are used solely to latch data inputs.

Each internal read and write operation in a SigmaDDR-IIIe B2 ECCRAM is two times wider than the device I/O bus. An input data bus de-multiplexer is used to accumulate incoming data before it is simultaneously written to the memory array. An output data multiplexer is used to capture the data produced from a single memory array read and then route it to the appropriate output drivers as needed. Therefore, the address field of a SigmaDDR-IIIe B2 ECCRAM is always one address pin less than the advertised index depth (e.g. the 8M x 18 has 4M addressable index).

## On-Chip Error Correction Code

GSI's ECCRAMs implement an ECC algorithm that detects and corrects all single-bit memory errors, including those induced by SER events such as cosmic rays, alpha particles, etc. The resulting Soft Error Rate of these devices is anticipated to be <0.002 FITs/Mb — a 5-order-of-magnitude improvement over comparable SRAMs with no on-chip ECC, which typically have an SER of 200 FITs/Mb or more.

All quoted SER values are at sea level in New York City.

## Parameter Synopsis

Speed Grade	Max Operating Frequency	Read Latency	V <sub>DD</sub>
-833	833 MHz	3 cycles	1.2V to 1.35V
-714	714 MHz	3 cycles	1.2V to 1.35V
-625	625 MHz	3 cycles	1.2V to 1.35V

## 8M x 18 Pinout (Top View)

	1	2	3	4	5	6	7	8	9	10	11	12	13
A	V <sub>DD</sub>	V <sub>DDQ</sub>	V <sub>DD</sub>	V <sub>DDQ</sub>	NC (RSVD)	MCH (CFG)	MCL	ZQ	PZT1	V <sub>DDQ</sub>	V <sub>DD</sub>	V <sub>DDQ</sub>	V <sub>DD</sub>
B	V <sub>SS</sub>	NU <sub>IO</sub>	V <sub>SS</sub>	NU <sub>I</sub>	MCH	MCL	NC (RSVD)	MCL (SIOM)	PZT0	NU <sub>I</sub>	V <sub>SS</sub>	DQ0	V <sub>SS</sub>
C	DQ17	V <sub>DDQ</sub>	NU <sub>I</sub>	V <sub>DDQ</sub>	V <sub>SS</sub>	SA	V <sub>DD</sub>	SA	V <sub>SS</sub>	V <sub>DDQ</sub>	NU <sub>I</sub>	V <sub>DDQ</sub>	NU <sub>IO</sub>
D	V <sub>SS</sub>	NU <sub>IO</sub>	V <sub>SS</sub>	NU <sub>I</sub>	SA	V <sub>DDQ</sub>	NC (288 Mb)	V <sub>DDQ</sub>	SA	NU <sub>I</sub>	V <sub>SS</sub>	DQ1	V <sub>SS</sub>
E	DQ16	V <sub>DDQ</sub>	NU <sub>I</sub>	V <sub>DD</sub>	V <sub>SS</sub>	SA	V <sub>SS</sub>	SA	V <sub>SS</sub>	V <sub>DD</sub>	NU <sub>I</sub>	V <sub>DDQ</sub>	NU <sub>IO</sub>
F	V <sub>SS</sub>	NU <sub>IO</sub>	V <sub>SS</sub>	NU <sub>I</sub>	SA	V <sub>DD</sub>	V <sub>DDQ</sub>	V <sub>DD</sub>	SA	NU <sub>I</sub>	V <sub>SS</sub>	DQ2	V <sub>SS</sub>
G	DQ15	NU <sub>IO</sub>	NU <sub>I</sub>	NU <sub>I</sub>	V <sub>SS</sub>	SA	MZT1	SA	V <sub>SS</sub>	NU <sub>I</sub>	NU <sub>I</sub>	DQ3	NU <sub>IO</sub>
H	DQ14	V <sub>DDQ</sub>	NU <sub>I</sub>	V <sub>DDQ</sub>	SA	V <sub>DDQ</sub>	R $\overline{W}$	V <sub>DDQ</sub>	SA	V <sub>DDQ</sub>	NU <sub>I</sub>	V <sub>DDQ</sub>	NU <sub>IO</sub>
J	V <sub>SS</sub>	NU <sub>IO</sub>	V <sub>SS</sub>	NU <sub>I</sub>	V <sub>SS</sub>	SA	V <sub>SS</sub>	SA	V <sub>SS</sub>	NU <sub>I</sub>	V <sub>SS</sub>	DQ4	V <sub>SS</sub>
K	CQ1	V <sub>DDQ</sub>	V <sub>REF</sub>	V <sub>DD</sub>	KD1	V <sub>DD</sub>	CK	V <sub>DD</sub>	KD0	V <sub>DD</sub>	V <sub>REF</sub>	V <sub>DDQ</sub>	CQ0
L	$\overline{CQ1}$	V <sub>SS</sub>	QVLD1	V <sub>SS</sub>	$\overline{KD1}$	V <sub>DDQ</sub>	$\overline{CK}$	V <sub>DDQ</sub>	$\overline{KD0}$	V <sub>SS</sub>	QVLD0	V <sub>SS</sub>	$\overline{CQ0}$
M	V <sub>SS</sub>	DQ13	V <sub>SS</sub>	NU <sub>I</sub>	V <sub>SS</sub>	SA	V <sub>SS</sub>	SA	V <sub>SS</sub>	NU <sub>I</sub>	V <sub>SS</sub>	NU <sub>IO</sub>	V <sub>SS</sub>
N	NU <sub>IO</sub>	V <sub>DDQ</sub>	NU <sub>I</sub>	V <sub>DDQ</sub>	PLL	V <sub>DDQ</sub>	$\overline{LD}$	V <sub>DDQ</sub>	MCH	V <sub>DDQ</sub>	NU <sub>I</sub>	V <sub>DDQ</sub>	DQ5
P	NU <sub>IO</sub>	DQ12	NU <sub>I</sub>	NU <sub>I</sub>	V <sub>SS</sub>	SA	MZT0	SA	V <sub>SS</sub>	NU <sub>I</sub>	NU <sub>I</sub>	NU <sub>IO</sub>	DQ6
R	V <sub>SS</sub>	DQ11	V <sub>SS</sub>	NU <sub>I</sub>	MCH	V <sub>DD</sub>	V <sub>DDQ</sub>	V <sub>DD</sub>	RST	NU <sub>I</sub>	V <sub>SS</sub>	NU <sub>IO</sub>	V <sub>SS</sub>
T	NU <sub>IO</sub>	V <sub>DDQ</sub>	NU <sub>I</sub>	V <sub>DD</sub>	V <sub>SS</sub>	SA	V <sub>SS</sub>	SA	V <sub>SS</sub>	V <sub>DD</sub>	NU <sub>I</sub>	V <sub>DDQ</sub>	DQ7
U	V <sub>SS</sub>	DQ10	V <sub>SS</sub>	NU <sub>I</sub>	NC (576 Mb)	V <sub>DDQ</sub>	NC (RSVD)	V <sub>DDQ</sub>	NC (1152 Mb)	NU <sub>I</sub>	V <sub>SS</sub>	NU <sub>IO</sub>	V <sub>SS</sub>
V	NU <sub>IO</sub>	V <sub>DDQ</sub>	NU <sub>I</sub>	V <sub>DDQ</sub>	V <sub>SS</sub>	SA (x18)	V <sub>DD</sub>	SA (B2)	V <sub>SS</sub>	V <sub>DDQ</sub>	NU <sub>I</sub>	V <sub>DDQ</sub>	DQ8
W	V <sub>SS</sub>	DQ9	V <sub>SS</sub>	NU <sub>I</sub>	TCK	MCL	RCS	MCL	TMS	NU <sub>I</sub>	V <sub>SS</sub>	NU <sub>IO</sub>	V <sub>SS</sub>
Y	V <sub>DD</sub>	V <sub>DDQ</sub>	V <sub>DD</sub>	V <sub>DDQ</sub>	TDO	ZT	NC (RSVD)	MCL	TDI	V <sub>DDQ</sub>	V <sub>DD</sub>	V <sub>DDQ</sub>	V <sub>DD</sub>

## Notes:

1. Pins 6B, 6W, 7A, 8W, and 8Y must be tied Low in this device.
2. Pins 5B, 5R, and 9N must be tied High in this device.
3. Pin 6A is defined as mode pin CFG in the pinout standard. It must be tied High in this device to select x18 configuration.
4. Pin 8B is defined as mode pin SIOM in the pinout standard. It must be tied Low in this device to select Common I/O configuration.
5. Pin 6V is defined as address pin SA for x18 devices. It is used in this device.
6. Pin 8V is defined as address pin SA for B2 devices. It is used in this device.
7. Pin 7D is reserved as address pin SA for 288Mb devices. It is a true no-connect in this device.
8. Pin 5U is reserved as address pin SA for 576 Mb devices. It is a true no connect in this device.
9. Pin 9U is reserved as address pin SA for 1152 Mb devices. It is a true no connect in this device.

## 4M x 36 Pinout (Top View)

	1	2	3	4	5	6	7	8	9	10	11	12	13
A	V <sub>DD</sub>	V <sub>DDQ</sub>	V <sub>DD</sub>	V <sub>DDQ</sub>	NC (RSVD)	MCL (CFG)	MCL	ZQ	PZT1	V <sub>DDQ</sub>	V <sub>DD</sub>	V <sub>DDQ</sub>	V <sub>DD</sub>
B	V <sub>SS</sub>	DQ35	V <sub>SS</sub>	NU <sub>I</sub>	MCH	MCL	NC (RSVD)	MCL (SIOM)	PZT0	NU <sub>I</sub>	V <sub>SS</sub>	DQ0	V <sub>SS</sub>
C	DQ26	V <sub>DDQ</sub>	NU <sub>I</sub>	V <sub>DDQ</sub>	V <sub>SS</sub>	SA	V <sub>DD</sub>	SA	V <sub>SS</sub>	V <sub>DDQ</sub>	NU <sub>I</sub>	V <sub>DDQ</sub>	DQ9
D	V <sub>SS</sub>	DQ34	V <sub>SS</sub>	NU <sub>I</sub>	SA	V <sub>DDQ</sub>	NC (288 Mb)	V <sub>DDQ</sub>	SA	NU <sub>I</sub>	V <sub>SS</sub>	DQ1	V <sub>SS</sub>
E	DQ25	V <sub>DDQ</sub>	NU <sub>I</sub>	V <sub>DD</sub>	V <sub>SS</sub>	SA	V <sub>SS</sub>	SA	V <sub>SS</sub>	V <sub>DD</sub>	NU <sub>I</sub>	V <sub>DDQ</sub>	DQ10
F	V <sub>SS</sub>	DQ33	V <sub>SS</sub>	NU <sub>I</sub>	SA	V <sub>DD</sub>	V <sub>DDQ</sub>	V <sub>DD</sub>	SA	NU <sub>I</sub>	V <sub>SS</sub>	DQ2	V <sub>SS</sub>
G	DQ24	DQ32	NU <sub>I</sub>	NU <sub>I</sub>	V <sub>SS</sub>	SA	MZT1	SA	V <sub>SS</sub>	NU <sub>I</sub>	NU <sub>I</sub>	DQ3	DQ11
H	DQ23	V <sub>DDQ</sub>	NU <sub>I</sub>	V <sub>DDQ</sub>	SA	V <sub>DDQ</sub>	R $\overline{W}$	V <sub>DDQ</sub>	SA	V <sub>DDQ</sub>	NU <sub>I</sub>	V <sub>DDQ</sub>	DQ12
J	V <sub>SS</sub>	DQ31	V <sub>SS</sub>	NU <sub>I</sub>	V <sub>SS</sub>	SA	V <sub>SS</sub>	SA	V <sub>SS</sub>	NU <sub>I</sub>	V <sub>SS</sub>	DQ4	V <sub>SS</sub>
K	CQ1	V <sub>DDQ</sub>	V <sub>REF</sub>	V <sub>DD</sub>	KD1	V <sub>DD</sub>	CK	V <sub>DD</sub>	KD0	V <sub>DD</sub>	V <sub>REF</sub>	V <sub>DDQ</sub>	CQ0
L	$\overline{CQ1}$	V <sub>SS</sub>	QVLD1	V <sub>SS</sub>	$\overline{KD1}$	V <sub>DDQ</sub>	$\overline{CK}$	V <sub>DDQ</sub>	$\overline{KD0}$	V <sub>SS</sub>	QVLD0	V <sub>SS</sub>	$\overline{CQ0}$
M	V <sub>SS</sub>	DQ22	V <sub>SS</sub>	NU <sub>I</sub>	V <sub>SS</sub>	SA	V <sub>SS</sub>	SA	V <sub>SS</sub>	NU <sub>I</sub>	V <sub>SS</sub>	DQ13	V <sub>SS</sub>
N	DQ30	V <sub>DDQ</sub>	NU <sub>I</sub>	V <sub>DDQ</sub>	PLL	V <sub>DDQ</sub>	$\overline{LD}$	V <sub>DDQ</sub>	MCH	V <sub>DDQ</sub>	NU <sub>I</sub>	V <sub>DDQ</sub>	DQ5
P	DQ29	DQ21	NU <sub>I</sub>	NU <sub>I</sub>	V <sub>SS</sub>	SA	MZT0	SA	V <sub>SS</sub>	NU <sub>I</sub>	NU <sub>I</sub>	DQ14	DQ6
R	V <sub>SS</sub>	DQ20	V <sub>SS</sub>	NU <sub>I</sub>	MCH	V <sub>DD</sub>	V <sub>DDQ</sub>	V <sub>DD</sub>	RST	NU <sub>I</sub>	V <sub>SS</sub>	DQ15	V <sub>SS</sub>
T	DQ28	V <sub>DDQ</sub>	NU <sub>I</sub>	V <sub>DD</sub>	V <sub>SS</sub>	SA	V <sub>SS</sub>	SA	V <sub>SS</sub>	V <sub>DD</sub>	NU <sub>I</sub>	V <sub>DDQ</sub>	DQ7
U	V <sub>SS</sub>	DQ19	V <sub>SS</sub>	NU <sub>I</sub>	NC (576 Mb)	V <sub>DDQ</sub>	NC (RSVD)	V <sub>DDQ</sub>	NC (1152 Mb)	NU <sub>I</sub>	V <sub>SS</sub>	DQ16	V <sub>SS</sub>
V	DQ27	V <sub>DDQ</sub>	NU <sub>I</sub>	V <sub>DDQ</sub>	V <sub>SS</sub>	NU <sub>I</sub> (x18)	V <sub>DD</sub>	SA (B2)	V <sub>SS</sub>	V <sub>DDQ</sub>	NU <sub>I</sub>	V <sub>DDQ</sub>	DQ8
W	V <sub>SS</sub>	DQ18	V <sub>SS</sub>	NU <sub>I</sub>	TCK	MCL	RCS	MCL	TMS	NU <sub>I</sub>	V <sub>SS</sub>	DQ17	V <sub>SS</sub>
Y	V <sub>DD</sub>	V <sub>DDQ</sub>	V <sub>DD</sub>	V <sub>DDQ</sub>	TDO	ZT	NC (RSVD)	MCL	TDI	V <sub>DDQ</sub>	V <sub>DD</sub>	V <sub>DDQ</sub>	V <sub>DD</sub>

## Notes:

1. Pins 6B, 6W, 7A, 8W, and 8Y must be tied Low in this device.
2. Pins 5B, 5R, and 9N must be tied High in this device.
3. Pin 6A is defined as mode pin CFG in the pinout standard. It must be tied Low in this device to select x36 configuration.
4. Pin 8B is defined as mode pin SIOM in the pinout standard. It must be tied Low in this device to select Common I/O configuration.
5. Pin 6V is defined as address pin SA for x18 devices. It is unused in this device, and must be left unconnected or driven Low.
6. Pin 8V is defined as address pin SA for B2 devices. It is used in this device.
7. Pin 7D is reserved as address pin SA for 288Mb devices. It is a true no-connect in this device.
8. Pin 5U is reserved as address pin SA for 576 Mb devices. It is a true no connect in this device.
9. Pin 9U is reserved as address pin SA for 1152 Mb devices. It is a true no connect in this device.

## Pin Description

Symbol	Description	Type
SA	<b>Address</b> — Read or Write Address is registered on $\uparrow\text{CK}$ .	Input
DQ[35:0]	<b>Write/Read Data</b> — Registered on $\uparrow\text{KD}$ and $\uparrow\overline{\text{KD}}$ during Write operations; aligned with $\uparrow\text{CQ}$ and $\uparrow\overline{\text{CQ}}$ during Read operations. DQ[17:0] - x18 and x36. DQ[35:18] - x36 only.	I/O
QVLD[1:0]	<b>Read Data Valid</b> — Driven high one half cycle before valid Read Data.	Output
CK, $\overline{\text{CK}}$	<b>Primary Input Clocks</b> — Dual single-ended. Used for latching address and control inputs, for internal timing control, and for output timing control.	Input
$\overline{\text{KD}}[1:0]$ , $\overline{\text{KD}}[1:0]$	<b>Write Data Input Clocks</b> — Dual single-ended. Used for latching write data inputs. KD0, $\overline{\text{KD}}0$ : latch Write Data (DQ[17:0] in x36, DQ[8:0] in x18). KD1, $\overline{\text{KD}}1$ : latch Write Data (DQ[35:18] in x36, DQ[17:9] in x18).	Input
$\overline{\text{CQ}}[1:0]$ , $\overline{\text{CQ}}[1:0]$	<b>Read Data Output Clocks</b> — Free-running output (echo) clocks, tightly aligned with read data outputs. Facilitate source-synchronous operation. CQ0, $\overline{\text{CQ}}0$ : align with DQ[17:0] in x36, and DQ[8:0] in x18. CQ1, $\overline{\text{CQ}}1$ : align with DQ[35:18] in x36, and DQ[17:9] in x18.	Output
$\overline{\text{LD}}$	<b>Load Enable</b> — Registered on $\uparrow\text{CK}$ . $\overline{\text{LD}} = 0$ : Loads a new address and initiates a Read or Write operation. $\overline{\text{LD}} = 1$ : Initiates a NOP operation.	Input
R $\overline{\text{W}}$	<b>Read / Write Enable</b> — Registered on $\uparrow\text{CK}$ . R $\overline{\text{W}} = 0$ : initiates a Write operation when $\overline{\text{LD}} = 0$ . R $\overline{\text{W}} = 1$ : initiates a Read operation when $\overline{\text{LD}} = 0$ .	Input
PLL	<b>PLL Enable</b> — Weakly pulled High internally. PLL = 0: disables internal PLL. PLL = 1: enables internal PLL.	Input
RST	<b>Reset</b> — Holds the device inactive and resets the device to its initial power-on state when asserted High. Weakly pulled Low internally.	Input
ZQ	<b>Driver Impedance Control Resistor Input</b> — Must be connected to $V_{SS}$ through an external resistor RQ to program driver impedance.	Input
ZT	<b>ODT Impedance Control Resistor Input</b> — Must be connected to $V_{SS}$ through an external resistor RT to program ODT impedance.	Input
RCS	<b>Current Source Resistor Input</b> — Preferably, should be connected to $V_{SS}$ through an external 2K $\Omega$ resistor to provide an accurate current source for the PLL. Alternately, it may be left unconnected, in which case a less accurate current source for the PLL is derived internally. The less accurate current source results in a narrower operating range for a given speed grade device, vs. connecting the RCS resistor.	Input
MZT[1:0]	<b>ODT Mode Select</b> — Set the ODT state globally for all input groups. Must be tied High or Low. MZT[1:0] = 00: disables ODT on all input groups, regardless of PZT[1:0]. MZT[1:0] = 01: enables strong ODT on select input groups, as specified by PZT[1:0]. MZT[1:0] = 10: enables weak ODT on select input groups, as specified by PZT[1:0]. MZT[1:0] = 11: reserved.	Input

Symbol	Description	Type
PZT[1:0]	<b>ODT Configuration Select</b> — Set the ODT state for various combinations of input groups when MZT[1:0] = 01 or 10. Must be tied High or Low. PZT[1:0] = 00: enables ODT on write data only. PZT[1:0] = 01: enables ODT on write data and input clocks. PZT[1:0] = 10: enables ODT on write data, address, and control. PZT[1:0] = 11: enables ODT on write data, input clocks, address, and control.	Input
V <sub>DD</sub>	<b>Core Power Supply</b>	—
V <sub>DDQ</sub>	<b>I/O Power Supply</b>	—
V <sub>REF</sub>	<b>Input Reference Voltage</b> — Input buffer reference voltage.	—
V <sub>SS</sub>	<b>Ground</b>	—
TCK	<b>JTAG Clock</b> — Weakly pulled Low internally.	Input
TMS	<b>JTAG Mode Select</b> — Weakly pulled High internally.	Input
TDI	<b>JTAG Data Input</b> — Weakly pulled High internally.	Input
TDO	<b>JTAG Data Output</b>	Output
MCH	<b>Must Connect High</b> — May be tied to V <sub>DDQ</sub> directly or via a 1kΩ resistor.	Input
MCL	<b>Must Connect Low</b> — May be tied to V <sub>SS</sub> directly or via a 1kΩ resistor.	Input
NC	<b>No Connect</b> — There is no internal chip connection to these pins. They may be left unconnected, or tied/driven High or Low.	—
NU <sub>I</sub>	<b>Not Used Input</b> — There is an internal chip connection to these input pins, but they are unused by the device. They are pulled Low internally. They may be left unconnected or tied/driven Low. They should not be tied/driven High.	Input
NU <sub>IO</sub>	<b>Not Used Input/Output</b> — There is an internal chip connection to these I/O pins, but they are unused by the device. The drivers are tri-stated internally. They are pulled Low internally. They may be left unconnected or tied/driven Low. They should not be tied/driven High.	I/O

## Power-Up and Reset Requirements

For reliability purposes, power supplies must power up simultaneously, or in the following sequence:

$V_{SS}$ ,  $V_{DD}$ ,  $V_{DDQ}$ ,  $V_{REF}$  and inputs.

Power supplies must power down simultaneously, or in the reverse sequence.

After power supplies power up, the following start-up sequence must be followed.

**Step 1 (Recommended, but not required):** Assert RST High for at least 1ms.

While RST is asserted high:

- The PLL is disabled.
- The states of  $\overline{LD}$ , and  $R/\overline{W}$  control inputs are ignored.

**Note:** If possible, RST should be asserted High before input clocks begin toggling, and remain asserted High until input clocks are stable and toggling within specification, in order to prevent unstable, out-of-spec input clocks from causing trouble in the SRAM.

**Step 2:** Begin toggling input clocks.

After input clocks begin toggling, but not necessarily within specification:

- DQ are placed in the non-Read state, and remain so until the first Read operation.
- QVLD are driven Low, and remain so until the first Read operation.
- CQ,  $\overline{CQ}$  begin toggling, but not necessarily within specification.

**Step 3:** Wait until input clocks are stable and toggling within specification.

**Step 4:** De-assert RST Low (if asserted High).

**Step 5:** Wait at least 224K (229,376) cycles.

During this time:

- Driver and ODT impedances are calibrated. Can take up to 160K cycles.
- The current source for the PLL is calibrated (based on RCS pin). Can take up to 64K cycles.

**Note:** The PLL pin may be asserted High or de-asserted Low during this time. If asserted High, PLL synchronization begins immediately after the current source for the PLL is calibrated. If de-asserted Low, PLL synchronization begins after the PLL pin is asserted High (see Step 6). In either case, Step 7 must follow thereafter.

**Step 6:** Assert PLL pin High (if de-asserted Low).

**Step 7:** Wait at least 64K (65,536) cycles for the PLL to lock.

After the PLL has locked:

- CQ,  $\overline{CQ}$  begin toggling within specification.

**Step 8:** Begin initiating Read and Write operations.

### Reset Usage

Although not generally recommended, RST may be asserted High at any time after completion of the initial power-up sequence described above, to reset the SRAM control logic to its initial power-on state. However, whenever RST is subsequently de-asserted Low (as in Step 4 above), Steps 5~7 above must be followed before Read and Write operations are initiated.

**Note:** Memory array content may be perturbed/corrupted when RST is asserted High.

## PLL Operation

A PLL is implemented in these devices to control all output timing. It uses the CK input clock as a source, and is enabled when all of the following conditions are met:

1. RST is de-asserted Low, and
2. The PLL pin is asserted High, and
3. CK cycle time  $\leq t_{\text{KHKH}}$  (max), as specified in the AC Timing Specifications section.

Once enabled, the PLL requires 64K stable clock cycles in order to lock/synchronize properly.

When the PLL is enabled, it aligns output clocks and read data to input clocks (with some fixed delay), and it generates all mid-cycle output timing. See the Output Timing section for more information.

The PLL can tolerate changes in input clock frequency due to clock jitter (i.e. such jitter will not cause the PLL to lose lock/synchronization), provided the cycle-to-cycle jitter does not exceed 200ps (see “ $t_{\text{KJITcc}}$ ” in the AC Timing Specifications section for more information). However, the PLL must be resynchronized (i.e. disabled and then re-enabled) whenever the nominal input clock frequency is changed.

The PLL is disabled when any of the following conditions are met:

1. RST is asserted High, or
2. The PLL pin is de-asserted Low, or
3. CK is stopped for at least 30ns, or CK cycle time  $\geq 30\text{ns}$ .

## On-Chip Error Correction

These devices implement a single-error correct, single-error detect (SEC-SED) ECC algorithm (specifically, a Hamming Code) on each 18-bit data word transmitted in DDR fashion on each 9-bit data bus (i.e., transmitted on D/Q[8:0], D/Q[17:9], D/Q[26:18], and D/Q[35:27]). To accomplish this, 5 ECC parity bits (invisible to the user) are utilized per every 18 data bits (visible to the user). As such, these devices actually comprise 184Mb of memory, of which 144Mb are visible to the user.

The ECC algorithm cannot detect multi-bit errors. However, these devices are architected in such a way that a single SER event very rarely causes a multi-bit error across any given “transmitted data unit”, where a “transmitted data unit” represents the data transmitted as the result of a single read or write operation to a particular address. The extreme rarity of multi-bit errors results in the SER mentioned previously (i.e.,  $<0.002$  FITs/Mb, measured at sea level).

Not only does the on-chip ECC significantly improve SER performance, but it can also free up the entire memory array for data storage. Very often SRAM applications allocate 1/9th of the memory array (i.e., one “error bit” per eight “data bits”, in any 9-bit “data byte”) for error detection (either simple parity error detection, or system-level ECC error detection and correction). Depending on the application, such error-bit allocation may be unnecessary in these devices, in which case the entire memory array can be utilized for data storage, effectively providing 12.5% greater storage capacity compared to SRAMs of the same density not equipped with on-chip ECC.



## Clock Truth Table

SA	$\overline{\text{LD}}$	R/ $\overline{\text{W}}$	Current Operation ( $t_n$ )	DQ (D)		DQ (Q)	
				$\uparrow\text{KD}$ ( $t_n$ )	$\uparrow\overline{\text{KD}}$ ( $t_{n+1/2}$ )	$\uparrow\text{CQ}$ ( $t_{n+3}$ )	$\uparrow\overline{\text{CQ}}$ ( $t_{n+3 1/2}$ )
V	1	X	NOP	X	X	Hi-Z / other	
V	0	0	Write	D1	D2	Hi-Z / other	
V	0	1	Read	X	X	Q1	Q2

## Notes:

- 1 = High 0 = Low; V = Valid; X = don't care.
- D1 and D2 indicate the first and second pieces of Write Data transferred during Write operations.
- Q1 and Q2 indicate the first and second pieces of Read Data transferred during Read operations.
- When DQ ODT is disabled, DQ pins are tri-stated for one cycle in response to NOP and Write commands, 3 cycles after the command is sampled. See the DQ ODT Control section below for how the state of the DQ pins is controlled when DQ ODT is enabled.



## DQ ODT Control

A robust methodology has been developed for these devices for controlling when DQ ODT is enabled and disabled during Write-to-Read and Read-to-Write transitions. Specifically, the methodology can ensure that the DQ bus is never pulled to  $V_{DDQ}/2$  by the SRAM ODT and/or by the controller ODT during the transitions (or at any other time). Such a condition is best avoided, because if an input signal is pulled to  $V_{DDQ}/2$  (i.e. to  $V_{REF}$  - the switch point of the diff-amp receiver), it could cause the receiver to enter a meta-stable state and consume more power than it normally would otherwise. This could result in the device's operating currents being higher than specified.

The fundamental concept of the methodology is - both the SRAM and the controller drive the DQ bus Low (with DQ ODT disabled) at all times except:

1. When a particular device is driving the DQ bus with valid data, and
2. From shortly before to shortly after a particular device is receiving valid data on the DQ bus, during which time the receiving device enables its DQ ODT.

And, during Write-to-Read and Read-to-Write transitions, each device enables and disables its DQ ODT while the other device is driving DQ Low, thereby ensuring that the DQ bus is never pulled to  $V_{DDQ}/2$ .

**Note:** This methodology also reduces power consumption, since there will be no DC current through either device's DQs when both devices are driving Low.

In order for this methodology to work as described, the controller must have the ability to:

1. Place the SRAM into "DQ Drive Low Mode" at the appropriate times (i.e. before and after the SRAM drives read data), and
2. Place the SRAM into "DQ ODT Mode" at the appropriate times (i.e. before, during, and after the SRAM receives write data).

That ability is provided via the existing  $R/\overline{W}$  control pin.

When the SRAM samples  $R/\overline{W}$  High (regardless of the state of  $\overline{LD}$ ), it disables its DQ ODT, and drives the DQ bus Low except while driving valid read data in response to Read operations.

When the SRAM samples  $R/\overline{W}$  Low (regardless of the state of  $\overline{LD}$ ), it disables its DQ drivers, and enables its DQ ODT.

Note that NOPs initiated with  $R/\overline{W}$  High and  $\overline{LD}$  High are referred to as "NOPr" operations.

Note that NOPs initiated with  $R/\overline{W}$  Low and  $\overline{LD}$  High are referred to as "NOPw" operations.

This extended definition of the  $R/\overline{W}$  control pin allows the controller to:

- Place the SRAM in DQ ODT Mode, via NOPw operations, before initiating Write operations.
- Keep the SRAM in DQ ODT Mode, via NOPw operations, after initiating Write operations.
- Place the SRAM in DQ Drive Low Mode, via NOPr operations, before initiating Read operations.
- Keep the SRAM in DQ Drive Low Mode, via NOPr operations, after initiating Read operations.

### Operation Sequence Rule

Because of how  $R/\overline{W}$  is used to control the state of the DQs, when a Read operation is initiated in cycle "n",  $R/\overline{W}$  must be driven "high" in cycle "n+1" (i.e. a Read operation must always be followed by a Read or NOPr operation) in order to ensure that the DQ state in cycle "n+3" is "Read Data".

**DQ Clock Truth Table**

In the Truth Table below, gray shading indicates invalid operation sequences; they violate the Operation Sequence Rule.

$\overline{\text{LD}}$	$\text{R}/\overline{\text{W}}$	Prior Operation	Current Operation	Future Operation	DQ State	
					$\uparrow\text{CK}$ ( $t_{n+2}$ )	$\uparrow\text{CK}$ ( $t_{n+3}$ )
$\uparrow\text{CK}$ ( $t_n$ )	$\uparrow\text{CK}$ ( $t_n$ )	( $t_{n-1}$ )	( $t_n$ )	( $t_{n+1}$ )		
1	0	Read	NOPw	Write or NOPw	Undefined	Terminated
				Read or NOPr		0
		NOPw, NOPr, or Write	NOPw	Write or NOPw	Terminated	Terminated
				Read or NOPr		0
1	1	Read	NOPr	Write or NOPw	Read Data	Terminated
				Read or NOPr		0
		NOPw, NOPr, or Write	NOPr	Write or NOPw	0	Terminated
				Read or NOPr		0
0	0	Read	Write	Write or NOPw	Undefined	Terminated
				Read or NOPr		0
		NOPw, NOPr, or Write	Write	Write or NOPw	Terminated	Terminated
				Read or NOPr		0
0	1	Read	Read	Write or NOPw	Read Data	Undefined
			Read	Read or NOPr		Read Data
		NOPw, NOPr, or Write	Read	Write or NOPw	0	Undefined
			Read	Read or NOPr		Read Data

Note: 1 = High; 0 = Low; X = don't care.

## NOPr and NOPw Requirements

The number of NOPw and NOPr needed during Write -> Read transitions, and the number of NOPr and NOPw needed during Read -> Write transitions, are as follows:

Write -> Read Transition				Read -> Write Transition			
NOPw (after Write)		NOPr (before Read)		NOPr (after Read)		NOPw (before Write)	
min	typ	min	typ	min	typ	min	typ
0	0	0	1-2	2	3-4	3	4-5

### Notes:

1. Min NOPw after Write (0) ensures that the SRAM disables DQ ODT 2.5 cycles after it latches the last piece of write data. Typ NOPw is the same as Min NOPw because it is sufficient to ensure that the controller stops driving the last piece of write data before SRAM DQ ODT disable reaches it (as the result of a subsequent NOPr or Read), regardless of SRAM tKQ, prop delay between SRAM and controller, and operating frequency.
2. Min NOPr before Read (0) ensures that the SRAM drives Low 1 cycle before it begins driving the first piece of read data. Typ NOPr is greater than Min NOPr in order to ensure that the controller enables DQ ODT after SRAM Low drive reaches it (and before the SRAM drives the first piece of read data), accounting for SRAM tKQ, prop delay between SRAM and controller, and operating frequency.
3. Min NOPr after Read (2) ensures that the SRAM drives Low for 1 cycle after it stops driving the last piece of read data and before it enables DQ ODT (as the result of a subsequent NOPw). Typ NOPr is greater than Min NOPr in order to ensure that the controller disables DQ ODT after SRAM Low drive reaches is (and before the SRAM enables DQ ODT), accounting for SRAM tKQ, prop delay between SRAM and controller, and operating frequency.
4. Min NOPw before Write (3) ensures that the SRAM enables DQ ODT 1 cycle before it latches the first piece of write data. Typ NOPw is greater than Min NOPw in order to ensure that the controller begins driving the first piece of write data after SRAM DQ ODT enable reaches it, accounting for SRAM tKQ, prop delay between SRAM and controller, and operating frequency.

### DQ ODT Control Timing Diagram

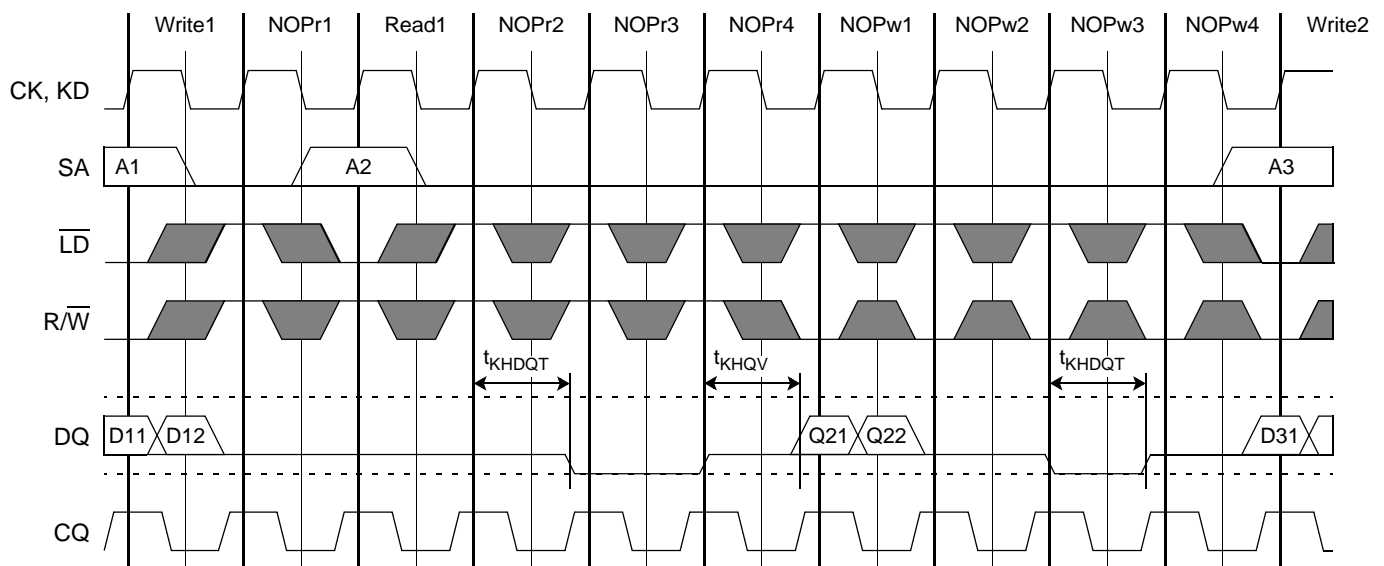

**Note:** In the diagram above, the controller is disabling its DQ ODT except from the beginning of NOPr4 to the beginning of NOPw3. And while it is disabling its DQ ODT, the controller is driving DQ Low when it isn't driving write data. Whereas, the SRAM is enabling its DQ ODT except from the beginning of NOPr2 to the beginning of NOPw3. And while it is disabling its DQ ODT, the SRAM is driving DQ Low when it isn't driving read data.

## Input Timing

These devices utilize three pairs of positive and negative input clocks, CK &  $\overline{\text{CK}}$  and KD[1:0] &  $\overline{\text{KD}}$ [1:0], to latch the various synchronous inputs. Specifically:

$\uparrow\text{CK}$  latches all address (SA) inputs.

$\uparrow\text{CK}$  latches all control ( $\overline{\text{LD}}$ , R/ $\overline{\text{W}}$ ) inputs.

$\uparrow\text{KD}$ [1:0] and  $\uparrow\overline{\text{KD}}$ [1:0] latch particular write data (DQ) inputs, as follows:

- $\uparrow\text{KD0}$  and  $\uparrow\overline{\text{KD0}}$  latch DQ[17:0] in x36, and DQ[8:0] in x18.
- $\uparrow\text{KD1}$  and  $\uparrow\overline{\text{KD1}}$  latch DQ[35:18] in x36, and DQ[17:9] in x18.

## Output Timing

These devices provide two pairs of positive and negative output clocks (aka “echo clocks”), CQ[1:0] &  $\overline{\text{CQ}}$ [1:0], whose timing is tightly aligned with read data in order to enable reliable source-synchronous data transmission.

These devices utilize a PLL to control output timing. When the PLL is enabled, it generates 0° and 180° phase clocks from  $\uparrow\text{CK}$  that control read data output clock (CQ,  $\overline{\text{CQ}}$ ), read data (DQ), and read data valid (QVLD) output timing, as follows:

- $\uparrow\text{CK}+0^\circ$  generates  $\uparrow\text{CQ}$ [1:0],  $\downarrow\overline{\text{CQ}}$ [1:0], Q1 active, and Q2 inactive.
- $\uparrow\text{CK}+180^\circ$  generates  $\uparrow\overline{\text{CQ}}$ [1:0],  $\downarrow\text{CQ}$ [1:0], Q1 inactive, Q2 active, and QVLD active/inactive.

**Note:** Q1 and Q2 indicate the first and second pieces of read data transferred in any given clock cycle during Read operations.

When the PLL is enabled,  $\uparrow\text{CQ}$  is aligned to an internally-delayed version of  $\uparrow\text{CK}$ . See the AC Timing Specifications for more information.

$\uparrow\text{CQ}$ [1:0] and  $\uparrow\overline{\text{CQ}}$ [1:0] align with particular DQ and QVLD outputs, as follows:

- $\uparrow\text{CQ0}$  and  $\uparrow\overline{\text{CQ0}}$  align with DQ[17:0], QVLD0 in x36 devices, and DQ[8:0], QVLD0 in x18 devices.
- $\uparrow\text{CQ1}$  and  $\uparrow\overline{\text{CQ1}}$  align with DQ[35:18], QVLD1 in x36 devices, and DQ[17:9], QVLD0 in x18 devices.

## Driver Impedance Control

**Programmable Driver Impedance** is implemented on the following output signals:

- CQ,  $\overline{\text{CQ}}$ , DQ, QVLD.

Driver impedance is programmed by connecting an external resistor RQ between the ZQ pin and V<sub>SS</sub>.

Driver impedance is set to the programmed value within 160K cycles after input clocks are operating within specification and RST is de-asserted Low. It is updated periodically thereafter to compensate for temperature and voltage fluctuations in the system.

Output Signal	Pull-Down Impedance (R <sub>OUTL</sub> )	Pull-Up Impedance (R <sub>OUTH</sub> )
CQ, $\overline{\text{CQ}}$ , DQ, QVLD	RQ*0.2 ± 15%	RQ*0.2 ± 15%

Notes:

1. R<sub>OUTL</sub> and R<sub>OUTH</sub> apply when 175Ω ≤ RQ ≤ 225Ω..
2. The mismatch between R<sub>OUTL</sub> and R<sub>OUTH</sub> is less than 10%, guaranteed by design.

## ODT Impedance Control

**Programmable ODT Impedance** is implemented on the following input signals:

- CK,  $\overline{\text{CK}}$ , KD,  $\overline{\text{KD}}$ , SA,  $\overline{\text{LD}}$ , R/ $\overline{\text{W}}$ , DQ.

ODT impedance is programmed by connecting an external resistor RT between the ZT pin and V<sub>SS</sub>.

ODT impedance is set to the programmed value within 160K cycles after input clocks are operating within specification and RST is de-asserted Low. It is updated periodically thereafter to compensate for temperature and voltage fluctuations in the system

Input Signal	PZT[1:0]	MZT[1:0]	Pull-Down Impedance (R <sub>INL</sub> )	Pull-Up Impedance (R <sub>INH</sub> )
CK, $\overline{\text{CK}}$ , KD, $\overline{\text{KD}}$	X0	XX	disabled	disabled
	X1	01	RT ± 15%	RT ± 15%
		10	RT*2 ± 20%	RT*2 ± 20%
SA, $\overline{\text{LD}}$ , R/ $\overline{\text{W}}$	0X	XX	disabled	disabled
	1X	01	RT ± 15%	RT ± 15%
		10	RT*2 ± 20%	RT*2 ± 20%
DQ	XX	01	RT ± 15%	RT ± 15%
		10	RT*2 ± 20%	RT*2 ± 20%

Notes:

1. When MZT[1:0] = 00, ODT is disabled on all inputs. MZT[1:0] = 11 is reserved for future use.
2. R<sub>INL</sub> and R<sub>INH</sub> apply when 105Ω ≤ RT ≤ 135Ω.
3. The mismatch between R<sub>INL</sub> and R<sub>INH</sub> is less than 10%, guaranteed by design.
4. All ODT is disabled during JTAG EXTEST and SAMPLE-Z instructions.

**Note:** When ODT impedance is enabled on a particular input, that input should always be driven High or Low; it should never be tri-stated (i.e., in a High- Z state). If the input is tri-stated, the ODT will pull the signal to V<sub>DDQ</sub> / 2 (i.e., to the switch point of the diff-amp receiver), which could cause the receiver to enter a meta-stable state and consume more power than it normally would. This could result in the device's operating currents being higher.

### Absolute Maximum Ratings

Parameter	Symbol	Rating	Units	Notes
Core Supply Voltage	$V_{DD}$	-0.3 to +1.4	V	
I/O Supply Voltage	$V_{DDQ}$	-0.3 to +1.8	V	
Input Voltage (HS)	$V_{IN1}$	-0.3 to $V_{DDQ} + 0.3$	V	2
	$V_{IN2}$	$V_{DDQ} - 1.5$ to +1.7		
Input Voltage (LS)	$V_{IN3}$	-0.3 to $V_{DDQ} + 0.3$	V	3
Junction Temperature	$T_J$	0 to 125	°C	
Storage Temperature	$T_{STG}$	-55 to 125	°C	

#### Notes:

- Permanent damage to the device may occur if the Absolute Maximum Ratings are exceeded. Operation should be restricted to Recommended Operating Conditions. Exposure to conditions exceeding the Recommended Operating Conditions for an extended period of time may affect reliability of this component.
- Parameters apply to High Speed Inputs: CK,  $\overline{CK}$ , KD,  $\overline{KD}$ , SA, DQ,  $\overline{LD}$ , R $\overline{W}$ .  $V_{IN1}$  and  $V_{IN2}$  must both be met.
- Parameters apply to Low Speed Inputs: RST, PLL, MZT, PZT.

### Recommended Operating Conditions

Parameter	Symbol	Min	Typ	Max	Units	Notes
Core Supply Voltage	$V_{DD}$	1.2	1.25	1.35	V	
I/O Supply Voltage	$V_{DDQ}$	1.45	1.5	1.55	V	
Commercial Junction Temperature	$T_{JC}$	0	—	85	°C	
Industrial Junction Temperature	$T_{JI}$	-40	—	100	°C	

Note: For reliability purposes, power supplies must power up simultaneously, or in the following sequence:

$V_{SS}$ ,  $V_{DD}$ ,  $V_{DDQ}$ ,  $V_{REF}$ , and Inputs.

Power supplies must power down simultaneously, or in the reverse sequence.

### Thermal Impedances

Package	$\theta_{JA}$ (C°/W) Airflow = 0 m/s	$\theta_{JA}$ (C°/W) Airflow = 1 m/s	$\theta_{JA}$ (C°/W) Airflow = 2 m/s	$\theta_{JB}$ (C°/W)	$\theta_{JC}$ (C°/W)
FBGA	13.67	10.28	9.31	3.08	0.13

### I/O Capacitance

Parameter	Symbol	Min	Max	Units	Notes
Input Capacitance	$C_{IN}$	—	5.0	pF	1, 3

Parameter	Symbol	Min	Max	Units	Notes
Output Capacitance	$C_{OUT}$	—	5.5	pF	2, 3

**Notes:**

- $V_{IN} = V_{DDQ}/2$ .
- $V_{OUT} = V_{DDQ}/2$ .
- $T_A = 25^\circ\text{C}$ ,  $f = 1\text{ MHz}$ .

**Input Electrical Characteristics**

Parameter	Symbol	Min	Typ	Max	Units	Notes
DC Input Reference Voltage	$V_{REFdc}$	$0.48 * V_{DDQ}$	$0.50 * V_{DDQ}$	$0.52 * V_{DDQ}$	V	—
DC Input High Voltage (HS)	$V_{IH1dc}$	$V_{REF} + 0.1$	$0.80 * V_{DDQ}$	$V_{DDQ} + 0.15$	V	1, 6, 7
	$V_{IH2dc}$			1.6		
DC Input Low Voltage (HS)	$V_{IL1dc}$	-0.15	$0.20 * V_{DDQ}$	$V_{REF} - 0.1$	V	2, 6, 8
	$V_{IL2dc}$	$V_{DDQ} - 1.4$				
DC Input High Voltage (LS)	$V_{IH2dc}$	$0.75 * V_{DDQ}$	$V_{DDQ}$	$V_{DDQ} + 0.15$	V	9
DC Input Low Voltage (LS)	$V_{IL2dc}$	-0.15	0	$0.25 * V_{DDQ}$	V	9
AC Input Reference Voltage	$V_{REFac}$	$0.47 * V_{DDQ}$	$0.50 * V_{DDQ}$	$0.53 * V_{DDQ}$	V	3
AC Input High Voltage (HS)	$V_{IH1ac}$	$V_{REF} + 0.2$	$0.80 * V_{DDQ}$	$V_{DDQ} + 0.25$	V	1, 4-6, 7
	$V_{IH2ac}$			1.65		
AC Input Low Voltage (HS)	$V_{IL1ac}$	-0.25	$0.20 * V_{DDQ}$	$V_{REF} - 0.2$	V	2, 4-6, 8
	$V_{IL2ac}$	$V_{DDQ} - 1.45$				
AC Input High Voltage (LS)	$V_{IH2ac}$	$V_{DDQ} - 0.2$	$V_{DDQ}$	$V_{DDQ} + 0.25$	V	4, 9
AC Input Low Voltage (LS)	$V_{IL2ac}$	-0.25	0	0.2	V	4, 9

**Notes:**

- "Typ" parameter applies when Controller  $R_{OUTH} = 40\Omega$  and SRAM  $R_{INH} = R_{INL} = 120\Omega$ .
- "Typ" parameter applies when Controller  $R_{OUTL} = 40\Omega$  and SRAM  $R_{INH} = R_{INL} = 120\Omega$ .
- $V_{REFac}$  is equal to  $V_{REFdc}$  plus noise.
- $V_{IH}$  max and  $V_{IL}$  min apply for pulse widths less than one-quarter of the cycle time.
- Input rise and fall times must be a minimum of  $1V/ns$ , and within 10% of each other.
- Parameters apply to High Speed Inputs: CK,  $\overline{CK}$ , KD,  $\overline{KD}$ , SA, DQ,  $\overline{LD}$ , R/W.
- $V_{IH1}$  max and  $V_{IH2}$  max (DC & AC) must both be met.
- $V_{IL1}$  min and  $V_{IL2}$  min (DC & AC) must both be met. Note that when  $V_{DDQ} = 1.5V$  nominal, these specs can only be met with input termination enabled. This, in fact, a requirement for using 1.5V I/O in these devices.
- Parameters apply to Low Speed Inputs: RST, PLL, MZT, PZT.



### Output Electrical Characteristics

Parameter	Symbol	Min	Typ	Max	Units	Notes
DC Output High Voltage	$V_{OHdc}$	—	$0.80 * V_{DDQ}$	$V_{DDQ} + 0.15$	V	1, 3
DC Output Low Voltage	$V_{OLdc}$	-0.15	$0.20 * V_{DDQ}$	—	V	2, 3
AC Output High Voltage	$V_{OHac}$	—	$0.80 * V_{DDQ}$	$V_{DDQ} + 0.25$	V	1, 3
AC Output Low Voltage	$V_{OLac}$	-0.25	$0.20 * V_{DDQ}$	—	V	2, 3

**Note:**

1. "Typ" parameter applies when SRAM  $R_{OUTH} = 40\Omega$  and Controller  $R_{INH} = R_{INL} = 120\Omega$ .
2. "Typ" parameter applies when SRAM  $R_{OUTL} = 40\Omega$  and Controller  $R_{INH} = R_{INL} = 120\Omega$ .
3. Parameters apply to: CQ,  $\overline{CQ}$ , DQ, QVLD.

### Leakage Currents

Parameter	Symbol	Min	Max	Units	Notes
Input Leakage Current	$I_{L11}$	-2	2	$\mu A$	1, 2
	$I_{L12}$	-20	2	$\mu A$	1, 3
	$I_{L13}$	-2	20	$\mu A$	1, 4
Output Leakage Current	$I_{LO}$	-2	2	$\mu A$	5, 6

**Notes:**

1.  $V_{IN} = V_{SS}$  to  $V_{DDQ}$ .
2. Parameters apply to CK,  $\overline{CK}$ , KD,  $\overline{KD}$ , SA, DQ,  $\overline{LD}$ ,  $\overline{R/W}$  when ODT is disabled.  
Parameters apply to MZT, PZT.
3. Parameters apply to PLL, TMS, TDI (weakly pulled up).
4. Parameters apply to RST, TCK (weakly pulled down).
5.  $V_{OUT} = V_{SS}$  to  $V_{DDQ}$ .
6. Parameters apply to CQ,  $\overline{CQ}$ , DQ, QVLD, TDO.

## Operating Currents

Parameter	Symbol	V <sub>DD</sub> (nom)	625 MHz	714 MHz	833 MHz	Units
x18 Operating Current	I <sub>DD</sub>	1.25V	1200	1300	1400	mA
x36 Operating Current	I <sub>DD</sub>	1.25V	1500	1650	1800	mA

### Notes:

1. I<sub>OUT</sub> = 0 mA; V<sub>IN</sub> = V<sub>IH</sub> or V<sub>IL</sub>.
2. Applies at 50% Reads + 50% Writes.

## AC Test Conditions

Parameter	Symbol	Conditions	Units
Core Supply Voltage	V <sub>DD</sub>	1.2 to 1.35	V
I/O Supply Voltage	V <sub>DDQ</sub>	1.45 to 1.55	V
Input Reference Voltage	V <sub>REF</sub>	0.75	V
Input High Level	V <sub>IH</sub>	1.25	V
Input Low Level	V <sub>IL</sub>	0.25	V
Input Rise and Fall Time	—	2.0	V/ns
Input and Output Reference Level	—	0.75	V

Note: Output Load Conditions R<sub>Q</sub> = 200Ω. Refer to figure below.

### AC Test Output Load

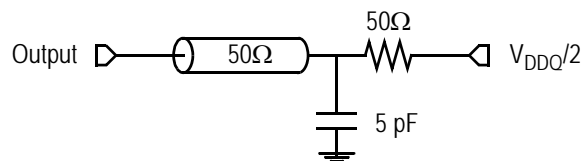

## AC Timing Specifications (independent of device speed grade)

Parameter	Symbol	Min	Max	Units	Notes
<b>Input Clock Timing</b>					
Clk High Pulse Width	$t_{KHKL}$	0.45	—	cycles	1
Clk Low Pulse Width	$t_{KLKH}$	0.45	—	cycles	1
Clk High to $\overline{\text{Clk}}$ High	$t_{KH\overline{KH}}$	0.45	0.55	cycles	2
Clk High to Write Data Clk High	$t_{KHKD H}$	-250	+250	ps	3
Clk Cycle-to-Cycle Jitter	$t_{KJITcc}$	—	60	ps	1,4,5
PLL Lock Time	$t_{Klock}$	65,536	—	cycles	6
Clk Static to PLL Reset	$t_{Kreset}$	30	—	ns	7,12
<b>Output Timing</b>					
Clk High to Output Valid / Hold	$t_{KHQV/X}$	+0.4	+1.2	ns	8
Clk High to Output State Transition	$t_{KHDQT}$	+0.4	+1.2	ns	8
Clk High to Echo Clock High	$t_{KHCQH}$	+0.4	+1.2	ns	9
Echo Clk High to Output Valid / Hold	$t_{CQHQV/X}$	-120	+120	ps	10,12
Echo Clk High to $\overline{\text{Echo Clock}}$ High	$t_{CQH\overline{CQH}}$	$0.5 \cdot t_{KHKH} (\text{nom}) - 50$	$0.5 \cdot t_{KHKH} (\text{nom}) + 50$	ps	11,12

## Notes:

All parameters are measured from the mid-point of the object signal to the mid-point of the reference signal.

- Parameters apply to CK,  $\overline{\text{CK}}$ , KD,  $\overline{\text{KD}}$ .
- Parameter specifies  $\uparrow\text{CK} \rightarrow \uparrow\overline{\text{CK}}$  and  $\uparrow\text{KD} \rightarrow \uparrow\overline{\text{KD}}$  requirements.
- Parameter specifies  $\uparrow\text{CK} \rightarrow \uparrow\text{KD}$  and  $\uparrow\overline{\text{CK}} \rightarrow \uparrow\overline{\text{KD}}$  requirements.
- Parameter specifies *Cycle-to-Cycle (C2C) Jitter* (i.e. the maximum variation from clock rising edge to the next clock rising edge). As such, it limits *Period Jitter* (i.e. the maximum variation in clock cycle time from nominal) to  $\pm 30\text{ps}$ . And as such, it limits *Absolute Jitter* (i.e. the maximum variation in clock rising edge from its nominal position) to  $\pm 15\text{ps}$ .
- The device can tolerate C2C Jitter greater than 60ps, up to a maximum of 200ps. However, when using a device from a particular speed grade,  $t_{KHKH}$  (min) of that speed grade must be derated (increased) by half the difference between the actual C2C Jitter and 60ps. For example, if the actual C2C Jitter is 100ps, then  $t_{KHKH}$  (min) for the -714 speed grade is derated to 1.42ns ( $1.4\text{ns} + 0.5 \cdot (100\text{ps} - 60\text{ps})$ ).
- $V_{DD}$  slew rate must be  $< 0.1\text{V DC per } 50\text{ns}$  for PLL lock retention. PLL lock time begins once  $V_{DD}$  and input clock are stable.
- Parameter applies to CK.
- Parameters apply to DQ, and are referenced to  $\uparrow\text{CK}$ .
- Parameter specifies  $\uparrow\text{CK} \rightarrow \uparrow\text{CQ}$  timing.
- Parameters apply to DQ, QVLD and are referenced to  $\uparrow\text{CQ}$  &  $\uparrow\overline{\text{CQ}}$ .
- Parameter specifies  $\uparrow\text{CQ} \rightarrow \uparrow\overline{\text{CQ}}$  timing.  $t_{KHKH} (\text{nom})$  is the nominal input clock cycle time applied to the device.
- Parameters are not tested. They are guaranteed by design, and verified through extensive corner-lot characterization.

## AC Timing Specifications (variable with device speed grade)

Parameter	Symbol	-833		-714		-625		Units	Notes
		Min	Max	Min	Max	Min	Max		
<b>Input Clock Timing</b>									
Clk Cycle Time	$t_{KHKH}$	1.2	6.0	1.4	6.0	1.6	6.0	ns	1
<b>Input Setup, Hold, and Pulse Width Timing</b>									
Input Valid to Clk High	$t_{IVKH}$	150	—	150	—	160	—	ps	2
Clk High to Input Hold	$t_{KHIX}$	150	—	150	—	160	—	ps	2
Input Pulse Width	$t_{IPW}$	200	—	200	—	200	—	ps	2,3

**Notes:**

All parameters are measured from the mid-point of the object signal to the mid-point of the reference signal.

- Parameters apply to  $\overline{CK}$ ,  $\overline{KD}$ ,  $\overline{KD}$ .
- Parameters apply to  $\overline{SA}$ , and are referenced to  $\uparrow\overline{CK}$ .  
Parameters apply to  $\overline{LD}$ ,  $\overline{R/W}$ , and are referenced to  $\uparrow\overline{CK}$ .  
Parameters apply to  $\overline{DQ}$ , and are referenced to  $\uparrow\overline{KD}$  &  $\uparrow\overline{KD}$ .
- Parameter specifies input pulse width requirements for each individual address, control, and data input. Per-pin deskew must be performed, to center the valid window of each individual input around the clock edge that latches it, in order for these parameters to be relevant to the application. The parameter is not tested; it is guaranteed by design and verified through extensive corner-lot characterization.

## Read and Write Timing Diagram

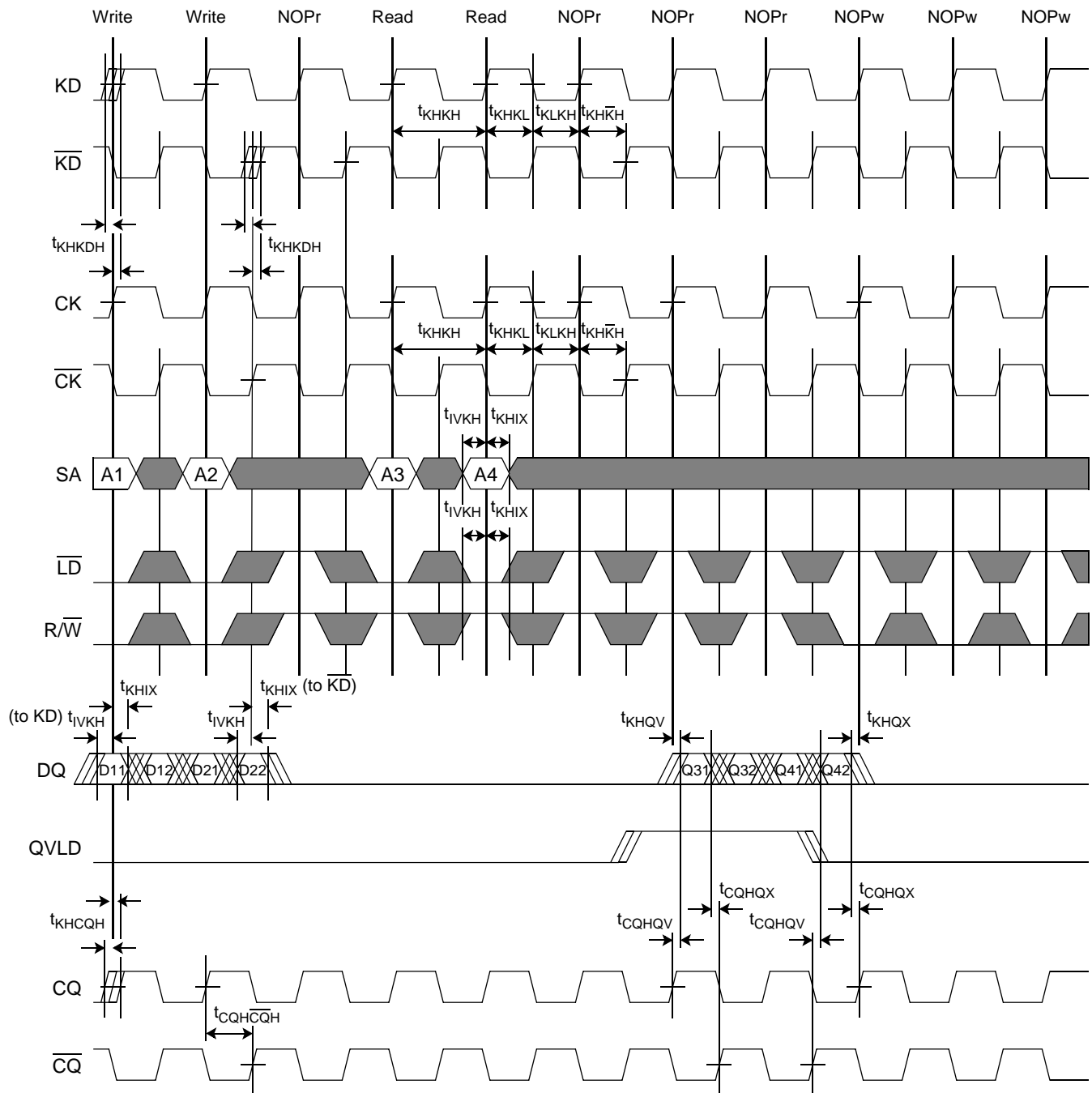

## JTAG Test Mode Description

These devices provide a JTAG Test Access Port (TAP) and Boundary Scan interface using a limited set of IEEE std. 1149.1 functions. This test mode is intended to provide a mechanism for testing the interconnect between master (processor, controller, etc.), ECCRAM, other components, and the printed circuit board. In conformance with a subset of IEEE std. 1149.1, these devices contain a TAP Controller and multiple TAP Registers. The TAP Registers consist of one Instruction Register and multiple Data Registers.

The TAP consists of the following four signals:

Pin	Pin Name	I/O	Description
TCK	Test Clock	I	Induces (clocks) TAP Controller state transitions.
TMS	Test Mode Select	I	Inputs commands to the TAP Controller. Sampled on the rising edge of TCK.
TDI	Test Data In	I	Inputs data serially to the TAP Registers. Sampled on the rising edge of TCK.
TDO	Test Data Out	O	Outputs data serially from the TAP Registers. Driven from the falling edge of TCK.

### Concurrent TAP and Normal ECCRAM Operation

According to IEEE std. 1149.1, most public TAP Instructions do not disrupt normal device operation. In these devices, the only exceptions are EXTEST and SAMPLE-Z. See the Tap Registers section for more information.

### Disabling the TAP

When JTAG is not used, TCK should be tied Low to prevent clocking the ECCRAM. TMS and TDI should either be tied High through a pull-up resistor or left unconnected. TDO should be left unconnected.

### JTAG DC Operating Conditions

Parameter	Symbol	Min	Max	Units	Notes
JTAG Input High Voltage	$V_{TIH}$	$0.75 * V_{DDQ}$	$V_{DDQ} + 0.15$	V	1
JTAG Input Low Voltage	$V_{TIL}$	-0.15	$0.25 * V_{DDQ}$	V	1
JTAG Output High Voltage	$V_{TOH}$	$V_{DDQ} - 0.2$	—	V	2, 3
JTAG Output Low Voltage	$V_{TOL}$	—	0.2	V	2, 4

#### Notes:

- Parameters apply to TCK, TMS, and TDI.
- Parameters apply to TDO.
- $I_{TOH} = -2.0$  mA.
- $I_{TOL} = 2.0$  mA.

## JTAG AC Timing Specifications

Parameter	Symbol	Min	Max	Units
TCK Cycle Time	$t_{THTH}$	50	—	ns
TCK High Pulse Width	$t_{THTL}$	20	—	ns
TCK Low Pulse Width	$t_{TLTH}$	20	—	ns
TMS Setup Time	$t_{MVTH}$	10	—	ns
TMS Hold Time	$t_{THMX}$	10	—	ns
TDI Setup Time	$t_{DVTH}$	10	—	ns
TDI Hold Time	$t_{THDX}$	10	—	ns
Capture Setup Time (Address, Control, Data, Clock)	$t_{CS}$	10	—	ns
Capture Hold Time (Address, Control, Data, Clock)	$t_{CH}$	10	—	ns
TCK Low to TDO Valid	$t_{TLOV}$	—	10	ns
TCK Low to TDO Hold	$t_{TLOX}$	0	—	ns

JTAG Timing Diagram

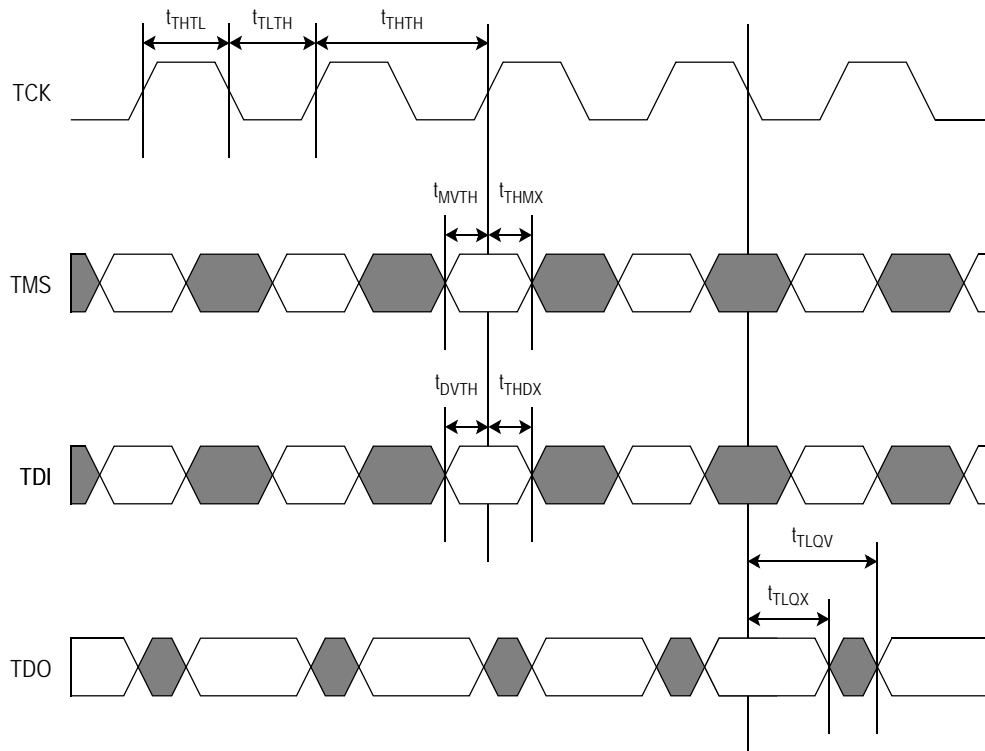



## TAP Controller

The TAP Controller is a 16-state state machine that controls access to the various TAP Registers and executes the operations associated with each TAP Instruction. State transitions are controlled by TMS and occur on the rising edge of TCK.

The TAP Controller enters the Test-Logic Reset state in one of two ways:

1. At power up.
2. When a logic 1 is applied to TMS for at least 5 consecutive rising edges of TCK.

The TDI input receiver is sampled only when the TAP Controller is in either the Shift-IR state or the Shift-DR state.

The TDO output driver is enabled only when the TAP Controller is in either the Shift-IR state or the Shift-DR state.

### TAP Controller State Diagram

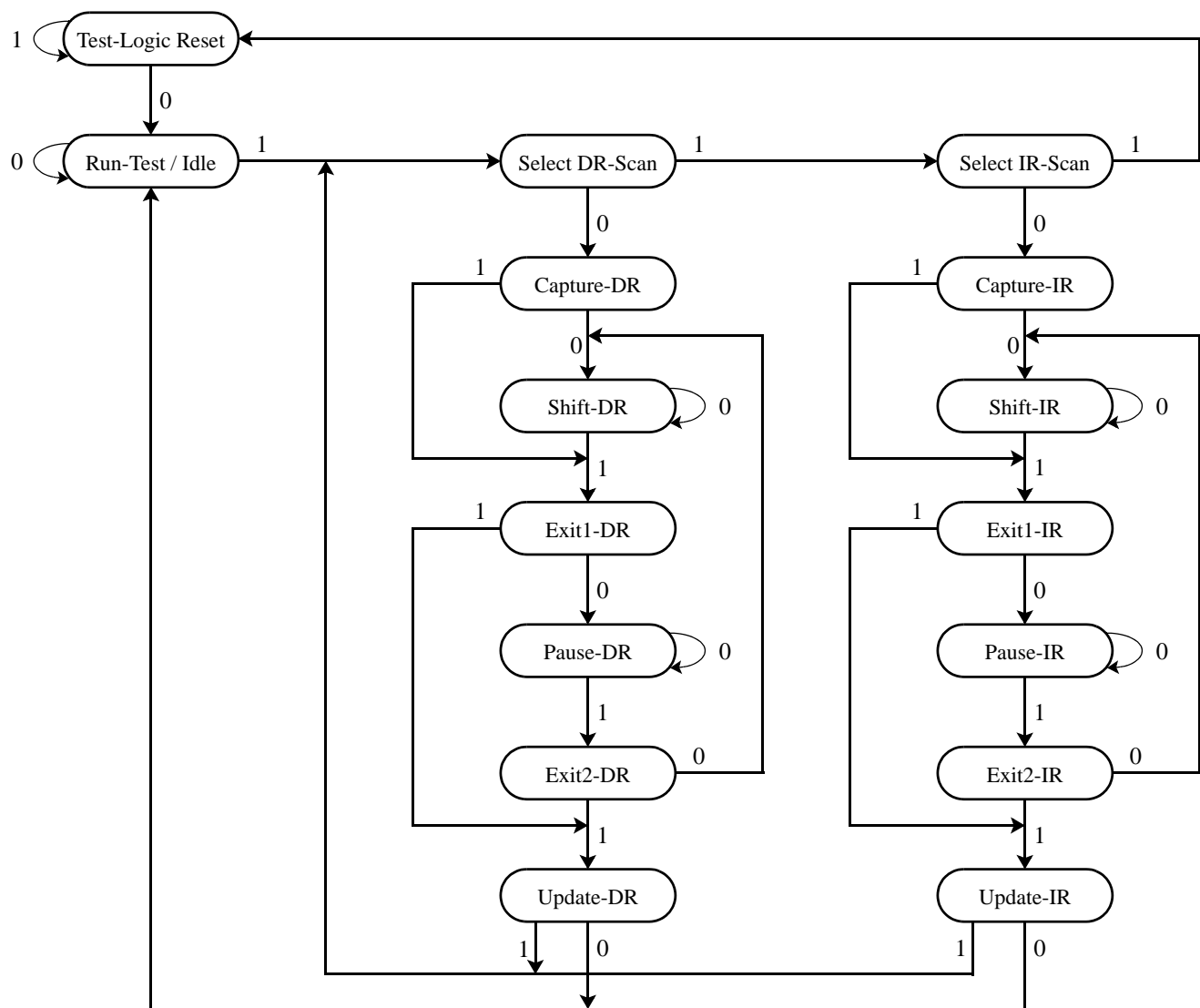

## TAP Registers

TAP Registers are serial shift registers that capture serial input data (from TDI) on the rising edge of TCK, and drive serial output data (to TDO) on the subsequent falling edge of TCK. They are divided into two groups: Instruction Registers (IR), which are manipulated via the IR states in the TAP Controller, and Data Registers (DR), which are manipulated via the DR states in the TAP Controller.

### Instruction Register (IR - 3 bits)

The Instruction Register stores the various TAP Instructions supported by ECCRAM. It is loaded with the IDCODE instruction (logic 001) at power-up, and when the TAP Controller is in the Test-Logic Reset and Capture-IR states. It is inserted between TDI and TDO when the TAP Controller is in the Shift-IR state, at which time it can be loaded with a new instruction. However, newly loaded instructions are not executed until the TAP Controller has reached the Update-IR state.

The Instruction Register is 3 bits wide, and is encoded as follows:

Code (2:0)	Instruction	Description
000	EXTEST	Loads the logic states of all signals composing the ECCRAM I/O ring into the Boundary Scan Register when the TAP Controller is in the Capture-DR state, and inserts the Boundary Scan Register between TDI and TDO when the TAP Controller is in the Shift-DR state. Also transfers the contents of the Boundary Scan Register associated with output signals (DQ, QVLD, CQ, $\overline{CQ}$ ) directly to their corresponding output pins. However, newly loaded Boundary Scan Register contents do not appear at the output pins until the TAP Controller has reached the Update-DR state. Also disables all ODT. See the Boundary Scan Register description for more information.
001	IDCODE	Loads a predefined device- and manufacturer-specific identification code into the ID Register when the TAP Controller is in the Capture-DR state, and inserts the ID Register between TDI and TDO when the TAP Controller is in the Shift-DR state. See the ID Register description for more information.
010	SAMPLE-Z	Loads the logic states of all signals composing the ECCRAM I/O ring into the Boundary Scan Register when the TAP Controller is in the Capture-DR state, and inserts the Boundary Scan Register between TDI and TDO when the TAP Controller is in the Shift-DR state. Also disables all ODT. Also forces DQ output drivers to a High-Z state. See the Boundary Scan Register description for more information.
011	PRIVATE	Reserved for manufacturer use only.
100	SAMPLE	Loads the logic states of all signals composing the ECCRAM I/O ring into the Boundary Scan Register when the TAP Controller is in the Capture-DR state, and inserts the Boundary Scan Register between TDI and TDO when the TAP Controller is in the Shift-DR state. See the Boundary Scan Register description for more information.
101	PRIVATE	Reserved for manufacturer use only.
110	PRIVATE	Reserved for manufacturer use only.
111	BYPASS	Loads a logic 0 into the Bypass Register when the TAP Controller is in the Capture-DR state, and inserts the Bypass Register between TDI and TDO when the TAP Controller is in the Shift-DR state. See the Bypass Register description for more information.

### Bypass Register (DR - 1 bit)

The Bypass Register is one bit wide, and provides the minimum length serial path between TDI and TDO. It is loaded with a logic 0 when the BYPASS instruction has been loaded in the Instruction Register and the TAP Controller is in the Capture-DR state. It is inserted between TDI and TDO when the BYPASS instruction has been loaded into the Instruction Register and the TAP Controller is in the Shift-DR state.

### ID Register (DR - 32 bits)

The ID Register is loaded with a predetermined device- and manufacturer-specific identification code when the IDCODE instruction has been loaded into the Instruction Register and the TAP Controller is in the Capture-DR state. It is inserted between TDI and TDO when the IDCODE instruction has been loaded into the Instruction Register and the TAP Controller is in the Shift-DR state.

The ID Register is 32 bits wide, and is encoded as follows:

See BSDL Model (31:12)	GSI ID (11:1)	Start Bit (0)
XXXX XXXX XXXX XXXX XXXX	0001 1011 001	1

Bit 0 is the LSB of the ID Register, and Bit 31 is the MSB. When the ID Register is selected, TDI serially shifts data into the MSB, and the LSB serially shifts data out through TDO.

### Boundary Scan Register (DR - 129 bits)

The Boundary Scan Register is equal in length to the number of active signal connections to the ECCRAM (excluding the TAP pins) plus a number of place holder locations reserved for functional and/or density upgrades. It is loaded with the logic states of all signals composing the ECCRAM's I/O ring when the EXTEST, SAMPLE, or SAMPLE-Z instruction has been loaded into the Instruction Register and the TAP Controller is in the Capture-DR state. It is inserted between TDI and TDO when the EXTEST, SAMPLE, or SAMPLE-Z instruction has been loaded into the Instruction Register and the TAP Controller is in the Shift-DR state.

Additionally, the contents of the Boundary Scan Register associated with the ECCRAM outputs (DQ, QVLD, CQ,  $\overline{CQ}$ ) are driven directly to the corresponding ECCRAM output pins when the EXTEST instruction is selected. However, after the EXTEST instruction has been selected, any new data loaded into Boundary Scan Register when the TAP Controller is in the Shift-DR state does not appear at the output pins until the TAP Controller has reached the Update-DR state.

The value captured in the boundary scan register for NU pins is determined by the external pin state. The value captured in the boundary scan register for NC pins is 0 regardless of the external pin state. The value captured in the Internal Cell (Bit 129) is 1.

### Output Driver State During EXTEST

EXTEST allows the Internal Cell (Bit 129) in the Boundary Scan Register to control the state of DQ drivers. That is, when Bit 129 = 1, DQ drivers are enabled (i.e., driving High or Low), and when Bit 129 = 0, DQ drivers are disabled (i.e., forced to High-Z state). See the Boundary Scan Register section for more information.

### ODT State During EXTEST and SAMPLE-Z

ODT on all inputs is disabled during EXTEST and SAMPLE-Z.

**Boundary Scan Register Bit Order Assignment**

The table below depicts the order in which the bits are arranged in the Boundary Scan Register. Bit 1 is the LSB and Bit 129 is the MSB. When the Boundary Scan Register is selected, TDI serially shifts data into the MSB, and the LSB serially shifts data out through TDO.

Bit	Pad	Bit	Pad	Bit	Pad	Bit	Pad	Bit	Pad
1	7L	29	12F	57	12W	85	1T	113	1C
2	7K	30	11G	58	10W	86	4R	114	3C
3	9L	31	13G	59	8V	87	2R	115	2B
4	9K	32	10G	60	9U	88	3P	116	4B
5	8J	33	12G	61	8T	89	1P	117	5A
6	7H	34	11H	62	9R	90	4P	118	6A
7	9H	35	13H	63	8P	91	2P	119	6B
8	7G	36	10J	64	9N	92	3N	120	6C
9	8G	37	12J	65	8M	93	1N	121	5D
10	9F	38	13K	66	6M	94	4M	122	6E
11	8E	39	13L	67	7N	95	2M	123	5F
12	7D	40	11L	68	5N	96	3L	124	6G
13	9D	41	12M	69	7P	97	1L	125	5H
14	8C	42	10M	70	6P	98	1K	126	6J
15	7B	43	13N	71	5R	99	2J	127	5K
16	8B	44	11N	72	6T	100	4J	128	5L
17	9B	45	12P	73	7U	101	1H	129	Internal
18	7A	46	10P	74	5U	102	3H		
19	9A	47	13P	75	6V	103	2G		
20	10B	48	11P	76	6W	104	4G		
21	12B	49	12R	77	7Y	105	1G		
22	11C	50	10R	78	4W	106	3G		
23	13C	51	13T	79	2W	107	2F		
24	10D	52	11T	80	3V	108	4F		
25	12D	53	12U	81	1V	109	1E		
26	11E	54	10U	82	4U	110	3E		
27	13E	55	13V	83	2U	111	2D		
28	10F	56	11V	84	3T	112	4D		

260-Pin BGA Package Drawing (Package GK)

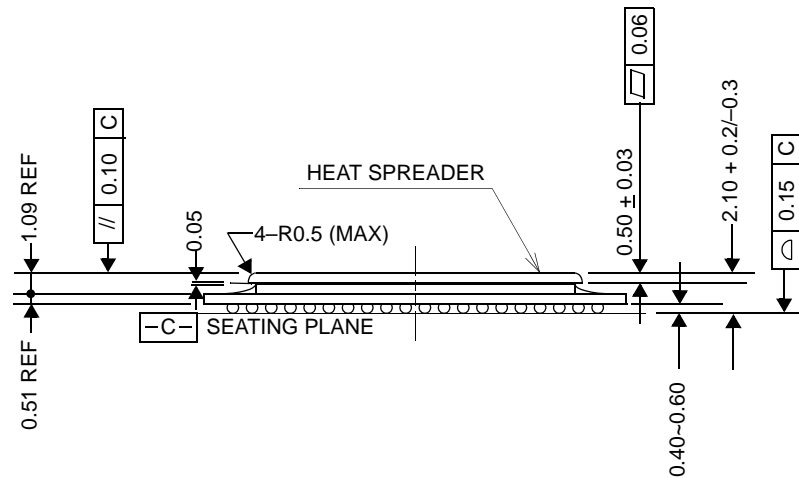
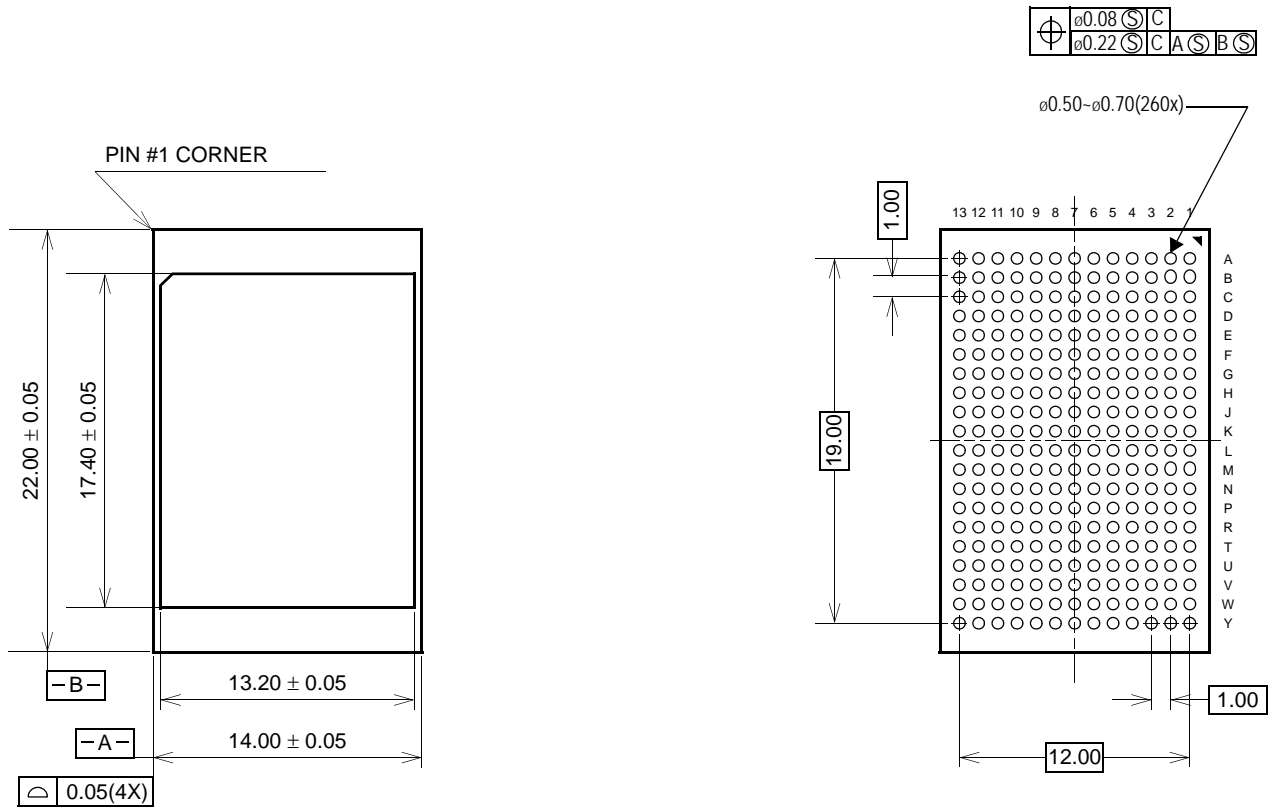

Ball Pitch:	1.00	Substrate Thickness:	0.51
Ball Diameter:	0.60	Mold Thickness:	—

Ordering Information — GSI SigmaDDR-IIIe ECCRAM

Org	Part Number	Type	Package	Speed (MHz)	T <sub>A</sub>
8M x 18	GS81313HT18GK-833	SigmaDDR-IIIe B2	ROHS-Compliant 260-Pin BGA	833	C
8M x 18	GS81313HT18GK-714	SigmaDDR-IIIe B2	ROHS-Compliant 260-Pin BGA	714	C
8M x 18	GS81313HT18GK-625	SigmaDDR-IIIe B2	ROHS-Compliant 260-Pin BGA	625	C
8M x 18	GS81313HT18GK-833I	SigmaDDR-IIIe B2	ROHS-Compliant 260-Pin BGA	833	I
8M x 18	GS81313HT18GK-714I	SigmaDDR-IIIe B2	ROHS-Compliant 260-Pin BGA	714	I
8M x 18	GS81313HT18GK-625I	SigmaDDR-IIIe B2	ROHS-Compliant 260-Pin BGA	625	I
4M x 36	GS81313HT36GK-833	SigmaDDR-IIIe B2	ROHS-Compliant 260-Pin BGA	833	C
4M x 36	GS81313HT36GK-714	SigmaDDR-IIIe B2	ROHS-Compliant 260-Pin BGA	714	C
4M x 36	GS81313HT36GK-625	SigmaDDR-IIIe B2	ROHS-Compliant 260-Pin BGA	625	C
4M x 36	GS81313HT36GK-833I	SigmaDDR-IIIe B2	ROHS-Compliant 260-Pin BGA	833	I
4M x 36	GS81313HT36GK-714I	SigmaDDR-IIIe B2	ROHS-Compliant 260-Pin BGA	714	I
4M x 36	GS81313HT36GK-625I	SigmaDDR-IIIe B2	ROHS-Compliant 260-Pin BGA	625	I

Note: C = Commercial Temperature Range. I = Industrial Temperature Range.

## Revision History

Rev. Code	Types of Changes Format or Content	Revisions
GS81313HT1836GK_r1.05	—	<ul style="list-style-type: none"> <li>Initial public release.</li> </ul>
GS81313HT1836GK_r1.06	Content	<ul style="list-style-type: none"> <li>Removed leaded BGA package support.</li> </ul>
GS81313HT1836GK_r1.07	Content	<ul style="list-style-type: none"> <li>Miscellaneous cleanup.</li> </ul>
GS81313HT1836GK_r1.08	Content	<ul style="list-style-type: none"> <li>Increased <math>V_{DD}</math> (max) to 1.35V.</li> <li>Added package thermal impedances.</li> <li>Added <math>t_{KHKH}</math> (max) specs.</li> <li>Revised <math>t_{KHKDH}</math> specs.</li> <li>Revised <math>t_{KHQV}</math>, <math>t_{KHQX}</math>, and <math>t_{KHCOH}</math> specs.</li> <li>Revised <math>t_{COHQV}</math> and <math>t_{COHQX}</math> specs.</li> <li>Banner changed to "Preliminary", to reflect ES status.</li> </ul>
GS81313HT1836GK_r1.09	Content	<ul style="list-style-type: none"> <li>Added input pulse width specs.</li> </ul>
GS81313HT1836GK_r1.09a	Content	<ul style="list-style-type: none"> <li>Updated speed bins to -833, -714, and -625.</li> <li>Changed write latency from 1 to 0 cycles (late write to early write).</li> </ul>
GS81313HT1836GK_r1.11	Content	<ul style="list-style-type: none"> <li>Removed "Preliminary" from data sheets.</li> <li>Added <math>I_{DD}</math> specifications.</li> </ul>
GS81313HT1836GK_r1.12	Content	<ul style="list-style-type: none"> <li>Increased <math>V_{DD}</math> (min) to 1.2V for 625 MHz speed bin. <math>V_{DD}</math> (min) is now the same value for all speed bins.</li> </ul>





Компания «ЭлектроПласт» предлагает заключение долгосрочных отношений при поставках импортных электронных компонентов на взаимовыгодных условиях!

Наши преимущества:

- Оперативные поставки широкого спектра электронных компонентов отечественного и импортного производства напрямую от производителей и с крупнейших мировых складов;
- Поставка более 17-ти миллионов наименований электронных компонентов;
- Поставка сложных, дефицитных, либо снятых с производства позиций;
- Оперативные сроки поставки под заказ (от 5 рабочих дней);
- Экспресс доставка в любую точку России;
- Техническая поддержка проекта, помощь в подборе аналогов, поставка прототипов;
- Система менеджмента качества сертифицирована по Международному стандарту ISO 9001;
- Лицензия ФСБ на осуществление работ с использованием сведений, составляющих государственную тайну;
- Поставка специализированных компонентов (Xilinx, Altera, Analog Devices, Intersil, Interpoint, Microsemi, Aeroflex, Peregrine, Syfer, Eurofarad, Texas Instrument, Miteq, Cobham, E2V, MA-COM, Hittite, Mini-Circuits, General Dynamics и др.);

Помимо этого, одним из направлений компании «ЭлектроПласт» является направление «Источники питания». Мы предлагаем Вам помощь Конструкторского отдела:

- Подбор оптимального решения, техническое обоснование при выборе компонента;
- Подбор аналогов;
- Консультации по применению компонента;
- Поставка образцов и прототипов;
- Техническая поддержка проекта;
- Защита от снятия компонента с производства.



#### Как с нами связаться

**Телефон:** 8 (812) 309 58 32 (многоканальный)

**Факс:** 8 (812) 320-02-42

**Электронная почта:** [org@eplast1.ru](mailto:org@eplast1.ru)

**Адрес:** 198099, г. Санкт-Петербург, ул. Калинина, дом 2, корпус 4, литера А.