

RONDA-WWW

~90° very wide beam with holder A compatible with 3rd party connectors from TE, Bender+Wirth and IDEAL

TECHNICAL SPECIFICATIONS:

Dimensions	Ø 69.9 mm
Height	14.6 mm
Fastening	socket
ROHS compliant	yes ⓘ

MATERIAL SPECIFICATIONS:

Component	Type	Material	Colour	Finish
RONDA-WWW	Single lens	PMMA	clear	
RONDA-HLD-A	Holder	PC	white	



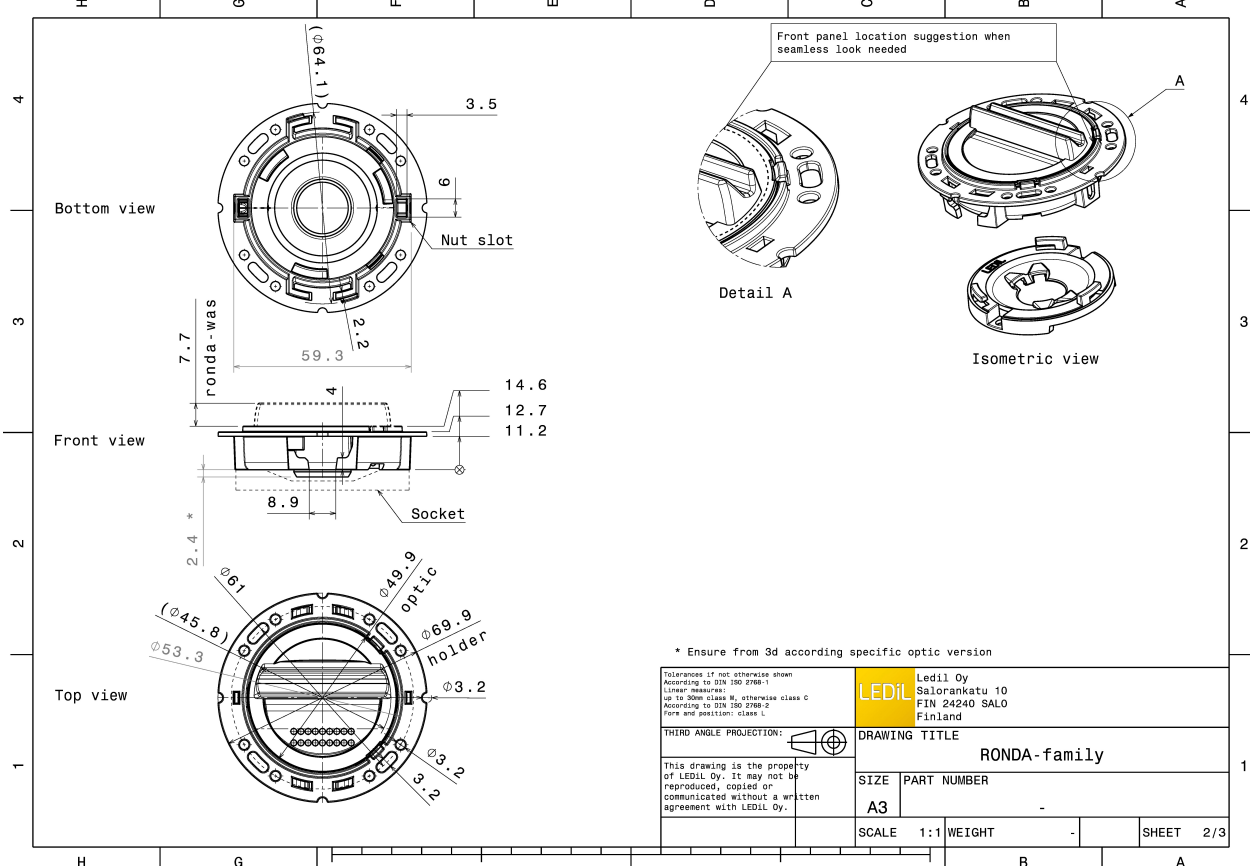
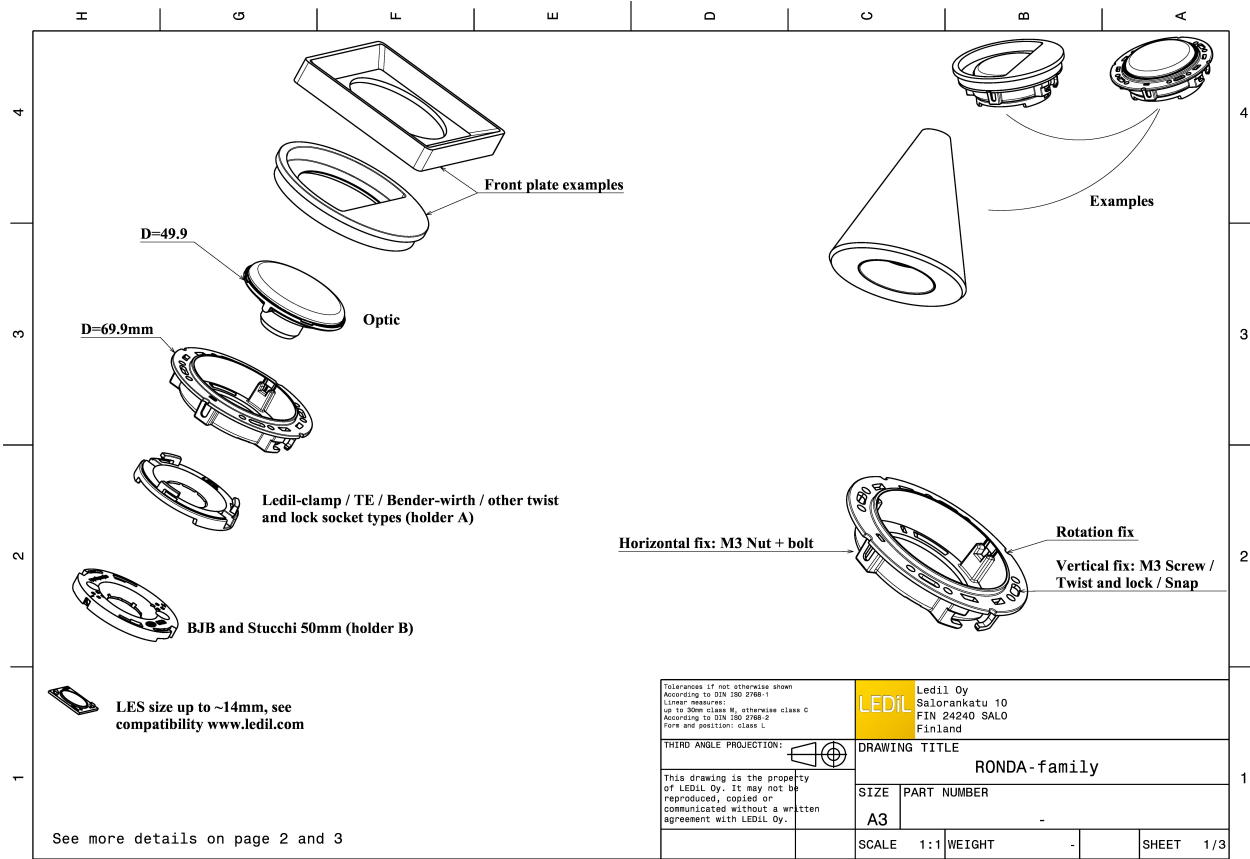

ORDERING INFORMATION:

Component		Qty in box	MOQ	MPQ	Box weight (kg)
FN15381_RONDA-WWW	Single lens	420	120	30	0.0
» Box size:					

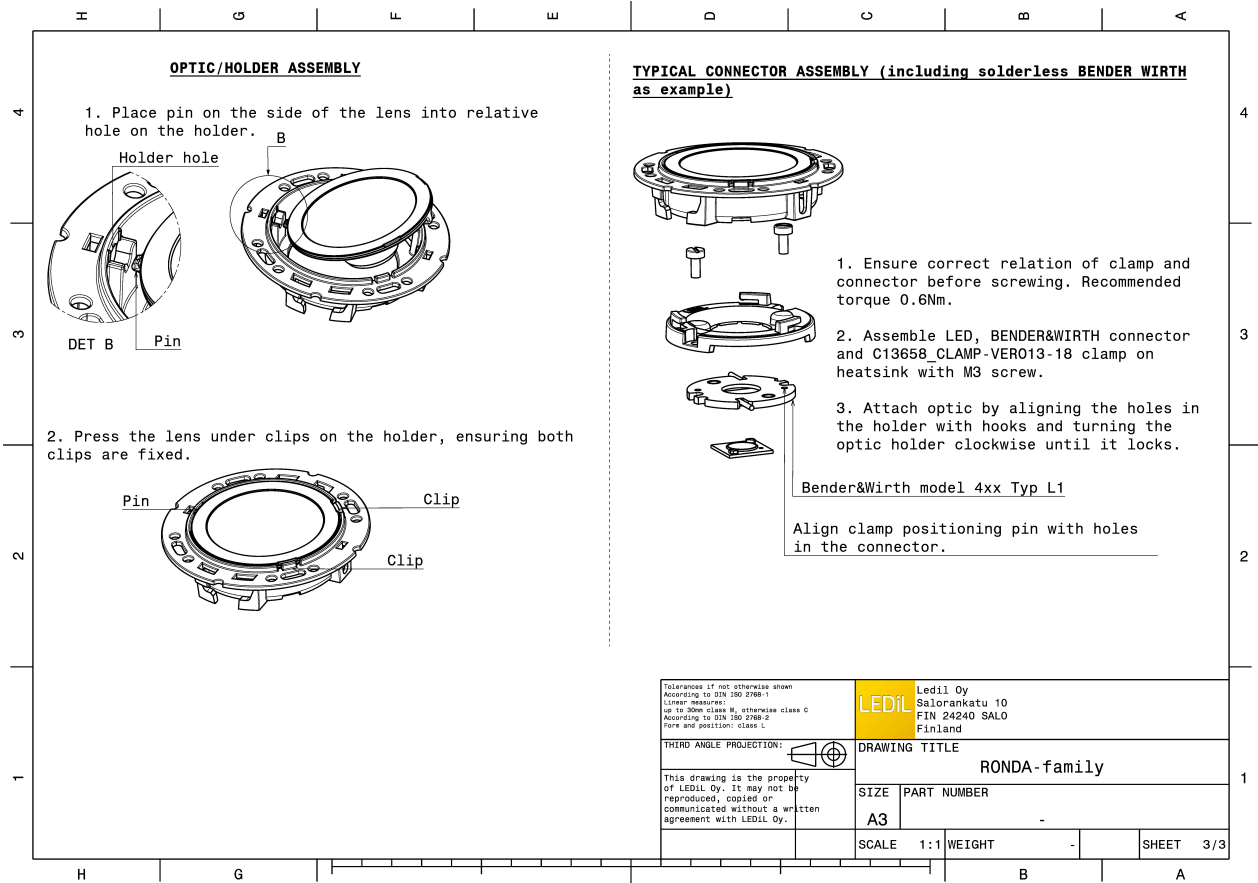

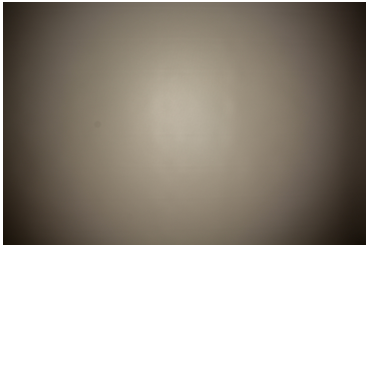
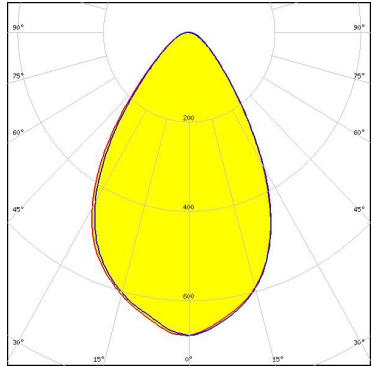
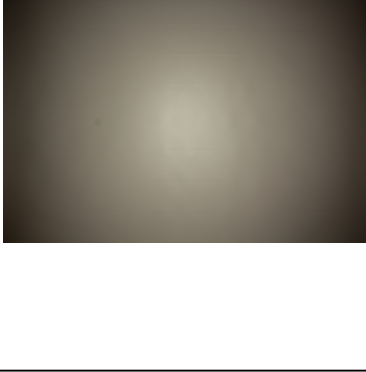
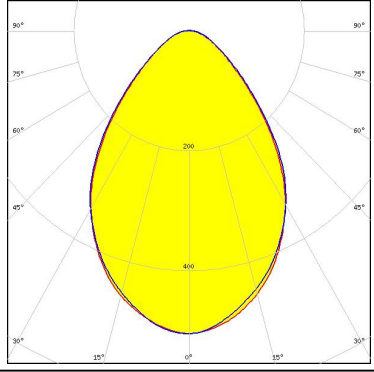
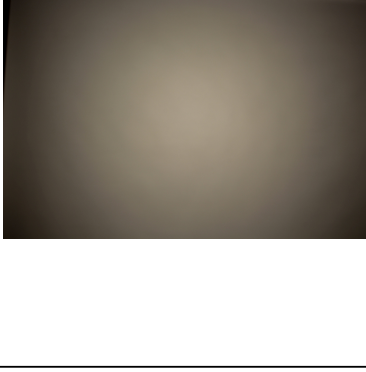
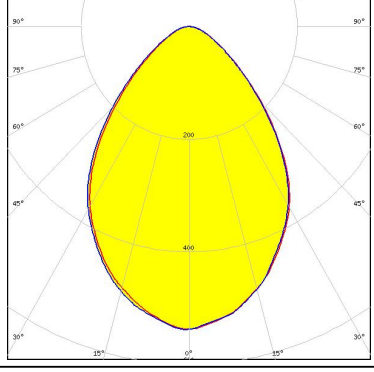

PHOTOMETRIC DATA (MEASURED):

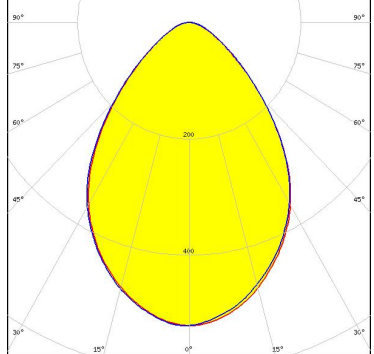
<p>bridgelux.</p> <p>LED V10 Gen7 FWHM 66.0° Efficiency 87 % Peak intensity 0.7 cd/lm LEDs/each optic 1 Light colour White Required components: C13658_CLAMP-VERO13-18 Bender Wirth: 486 Typ L1</p>		
<p>bridgelux.</p> <p>LED V13 Gen7 FWHM 76.0° Efficiency 82 % Peak intensity 0.5 cd/lm LEDs/each optic 1 Light colour White Required components: TE: 2213254-2 + OPTIC CLIP Z50 TYPE1 2213194-1</p>		
<p>bridgelux.</p> <p>LED Vero SE 13 FWHM 78.0° Efficiency 88 % Peak intensity 0.5 cd/lm LEDs/each optic 1 Light colour White Required components: C16402_CLAMP-VEROSE-13-18</p>		
<p>bridgelux.</p> <p>LED VERO13 FWHM 78.0° Efficiency 87 % Peak intensity 0.5 cd/lm LEDs/each optic 1 Light colour White Required components: C13658_CLAMP-VERO13-18</p>		

PHOTOMETRIC DATA (MEASURED):

CITIZEN

LED CLL03x/CLU03x
FWHM 75.0°
Efficiency 87 %
Peak intensity 0.5 cd/lm
LEDs/each optic 1
Light colour White
Required components:
C16791_CLAMP-Z45-A
TE: 2325807-3

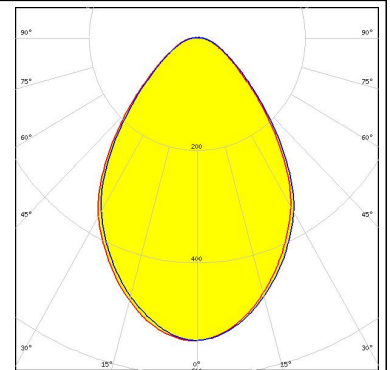

CITIZEN

LED CLL03x/CLU03x
FWHM 73.0°
Efficiency 82 %
Peak intensity 0.5 cd/lm
LEDs/each optic 1
Light colour White
Required components:
IDEAL: 50-2103CT + 50-2100AN

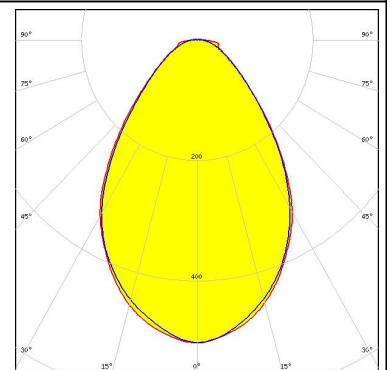
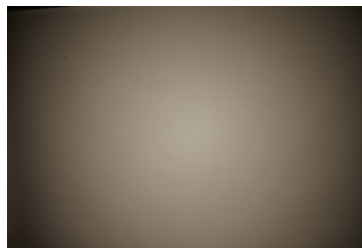

CITIZEN

LED CLL04x/CLU04x
FWHM 83.0°
Efficiency 82 %
Peak intensity 0.4 cd/lm
LEDs/each optic 1
Light colour White
Required components:
IDEAL: 50-2204-CT + 50-2100AN

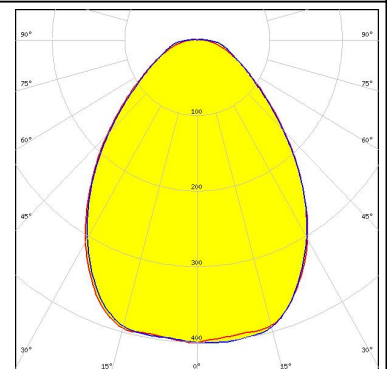
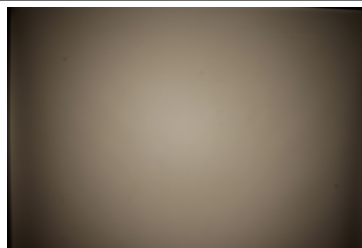

CITIZEN

LED CLU730/731
FWHM 71.0°
Efficiency 84 %
Peak intensity 0.5 cd/lm
LEDs/each optic 1
Light colour White
Required components:
IDEAL: 50-2204-CT + 50-2100AN

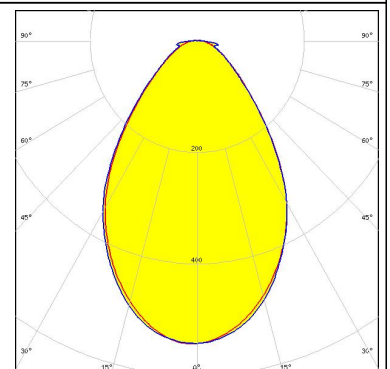
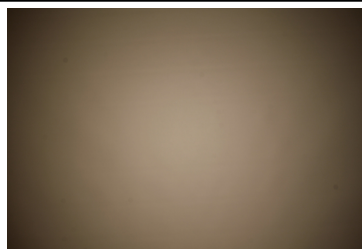

PHOTOMETRIC DATA (MEASURED):



LED CMA1840
 FWHM 78.0°
 Efficiency 86 %
 Peak intensity 0.5 cd/lm
 LEDs/each optic 1
 Light colour White
 Required components:
 C14123_CLAMP-CXA15-18

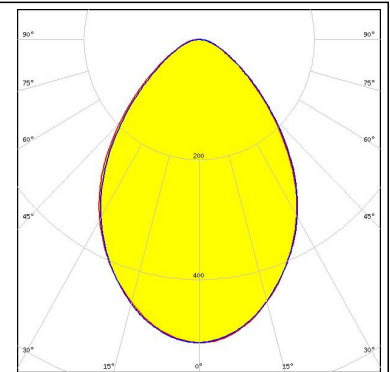

LED CXA/B 1816 & CXA/B 1820 & CXA 1850
 FWHM 75.0°
 Efficiency 85 %
 Peak intensity 0.5 cd/lm
 LEDs/each optic 1
 Light colour White
 Required components:
 TE: 2213401-2 + OPTIC CLIP Z50 TYPE1 2213194-1

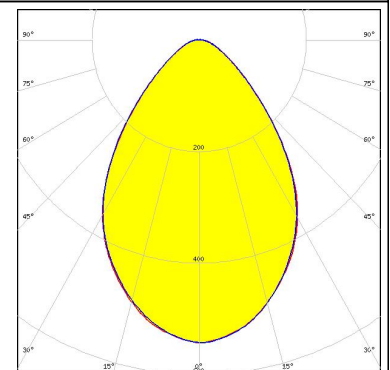
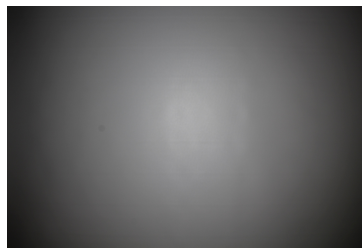

LED CXA/B 1816 & CXA/B 1820 & CXA 1850
 FWHM 80.0°
 Efficiency 90 %
 Peak intensity 0.5 cd/lm
 LEDs/each optic 1
 Light colour White
 Required components:
 C14123_CLAMP-CXA15-18

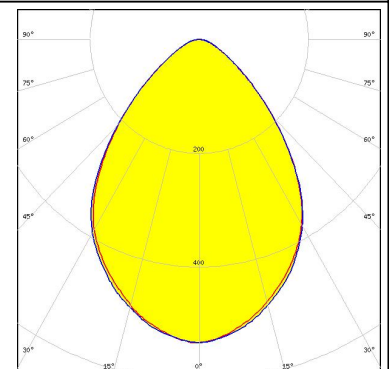
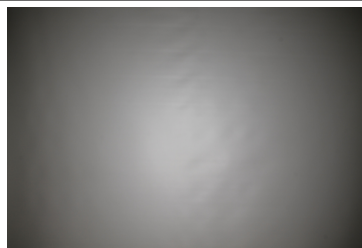

LED COB J-Type
 FWHM 74.0°
 Efficiency 82 %
 Peak intensity 0.5 cd/lm
 LEDs/each optic 1
 Light colour White
 Required components:
 IDEAL: 50-2103NC + 50-2100AN

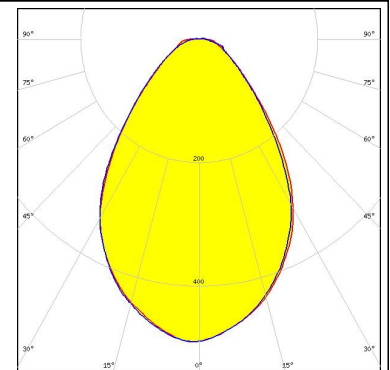
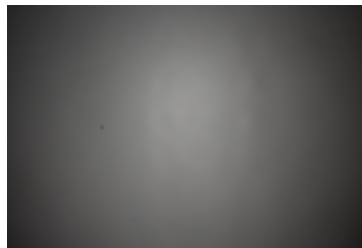

PHOTOMETRIC DATA (MEASURED):

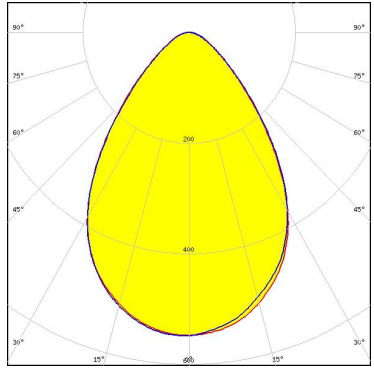
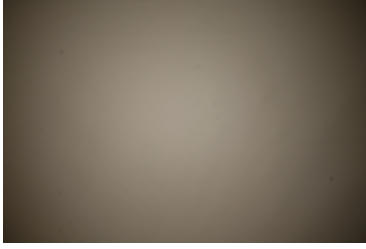
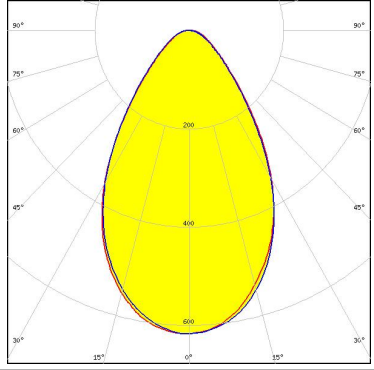
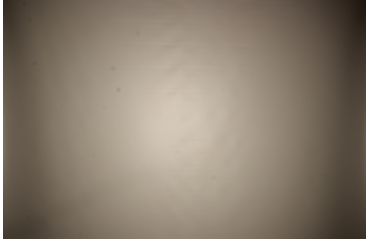
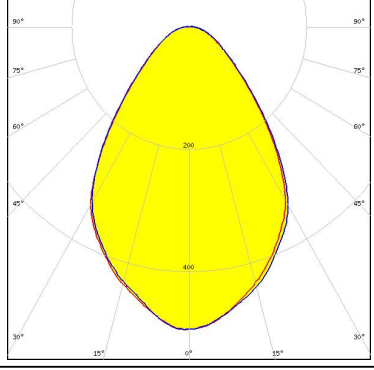
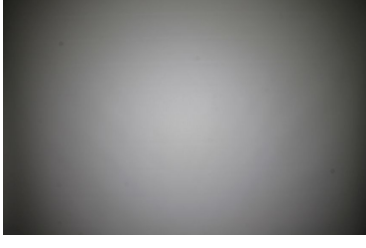
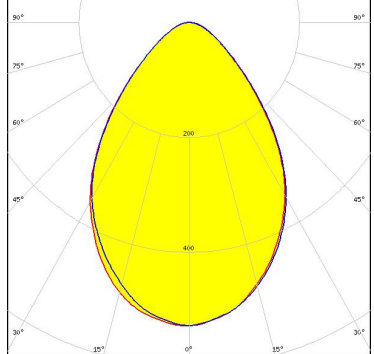
<p>NICHIA</p> <p>LED COB L-Type (LES 11) FWHM 74.0° Efficiency 85 % Peak intensity 0.6 cd/lm LEDs/each optic 1 Light colour White Required components: TE: 2213382-2 + OPTIC CLIP Z50 TYPE1 2213194-1</p>		
<p>NICHIA</p> <p>LED COB L-Type (LES 11) FWHM 65.0° Efficiency 83 % Peak intensity 0.6 cd/lm LEDs/each optic 1 Light colour White Required components: IDEAL: 50-2100NC + 50-2100AN</p>		
<p>OSRAM</p> <p>LED PrevaLED Core G7 L15 H1 FWHM 73.0° Efficiency 79 % Peak intensity 0.5 cd/lm LEDs/each optic 1 Light colour White Required components: C16685_CLAMP-PRV-A</p>		
<p>OSRAM <small>Opto Semiconductors</small></p> <p>LED Soleriq S13 19x19 FWHM 75.0° Efficiency 84 % Peak intensity 0.5 cd/lm LEDs/each optic 1 Light colour White Required components: TE: 2213254-2 + OPTIC CLIP Z50 TYPE1 2213194-1</p>		

PHOTOMETRIC DATA (MEASURED):

OSRAM

Opto Semiconductors

LED Soleriq S13 19x19
FWHM 72.0°
Efficiency 83 %
Peak intensity 0.5 cd/lm
LEDs/each optic 1
Light colour White
Required components:
IDEAL: 50-2103CT + 50-2100AN

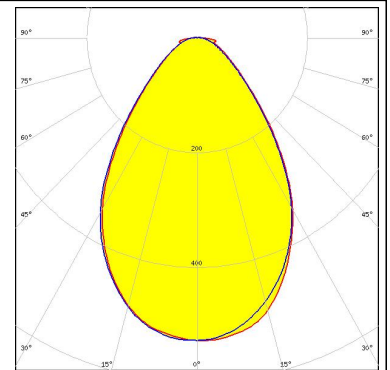

PHILIPS

LED Fortimo SLM L13 + SLM holder
FWHM 73.0°
Efficiency 82 %
Peak intensity 0.5 cd/lm
LEDs/each optic 1
Light colour White
Required components:
TE: OPTIC CLIP Z50 TYPE1 2213194-1

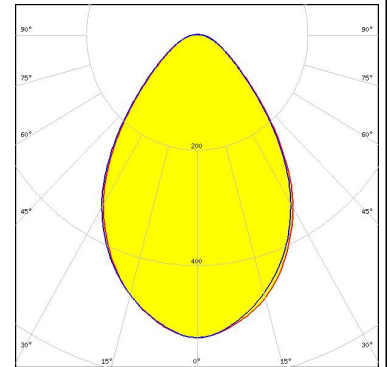

PHILIPS

LED Fortimo SLM L13 CoB
FWHM 78.0°
Efficiency 82 %
Peak intensity 0.5 cd/lm
LEDs/each optic 1
Light colour White
Required components:
TE: 2213130-2 + OPTIC CLIP Z50 TYPE1 2213194-1

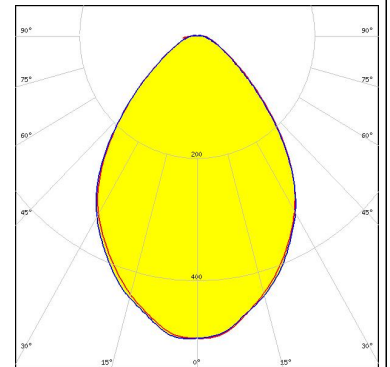

PHILIPS

LED Fortimo SLM L15 + SLM holder
FWHM 78.0°
Efficiency 80 %
Peak intensity 0.5 cd/lm
LEDs/each optic 1
Light colour White
Required components:
TE: OPTIC CLIP Z50 TYPE1 2213194-1

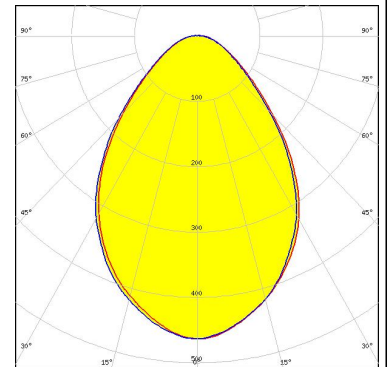
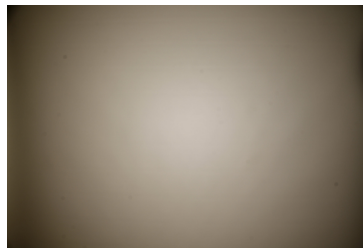

PHOTOMETRIC DATA (MEASURED):

SAMSUNG

LED LC040C
 FWHM 74.0°
 Efficiency 85 %
 Peak intensity 0.6 cd/lm
 LEDs/each optic 1
 Light colour White

Required components:

TE: 2213382-2 + OPTIC CLIP Z50 TYPE1 2213194-1

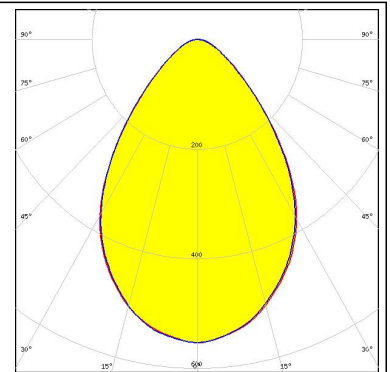

SEOUL SEMICONDUCTOR

LED AC Zhaga COB
 FWHM 78.0°
 Efficiency 83 %
 Peak intensity 0.5 cd/lm
 LEDs/each optic 1
 Light colour White

Required components:

Optosource: SEHSMJD-A

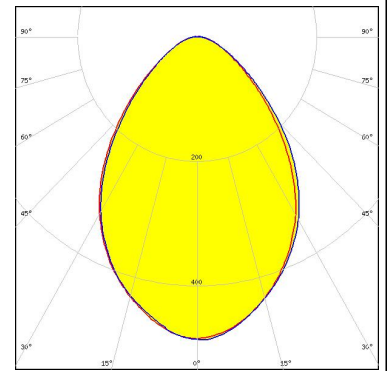

SEOUL SEMICONDUCTOR

LED MJT COB LES 14.5
 FWHM 79.0°
 Efficiency 80 %
 Peak intensity 0.5 cd/lm
 LEDs/each optic 1
 Light colour White

Required components:

TE: 2213254-2 + OPTIC CLIP Z50 TYPE1 2213194-1

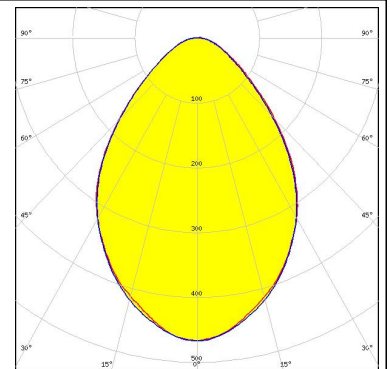
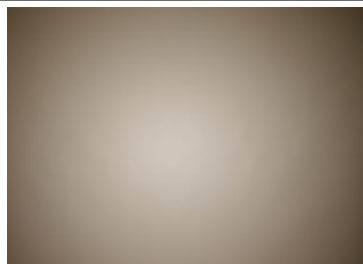

LED WU-M-484
 FWHM 79.0°
 Efficiency 82 %
 Peak intensity 0.5 cd/lm
 LEDs/each optic 1
 Light colour White

Required components:

TE: OPTIC CLIP Z50 TYPE1 2213194-1

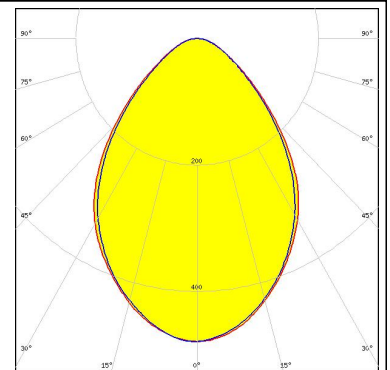
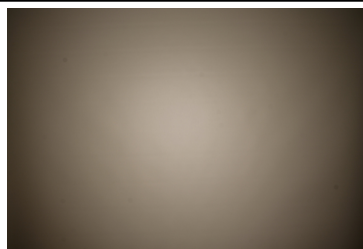

PHOTOMETRIC DATA (SIMULATED):

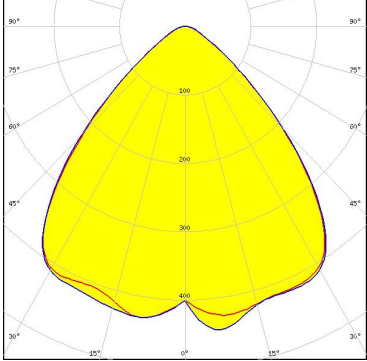
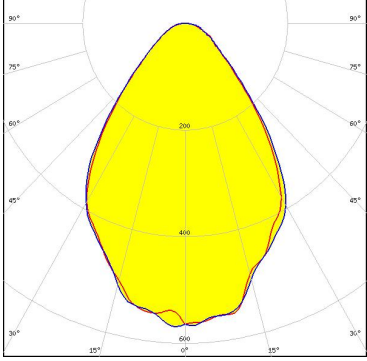
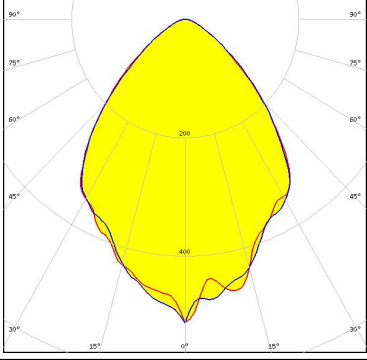
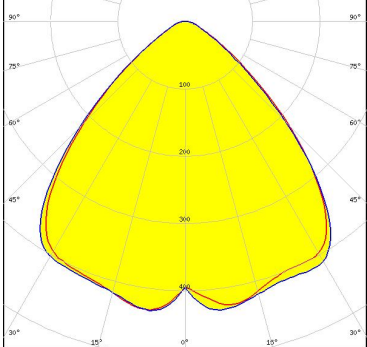
<p>bridgelux.</p> <p>LED V10 Gen6</p> <p>FWHM 89.0°</p> <p>Efficiency 86 %</p> <p>Peak intensity 0.5 cd/lm</p> <p>LEDs/each optic 1</p> <p>Light colour White</p> <p>Required components: C14123_CLAMP-CXA15-18</p>	
<p>bridgelux.</p> <p>LED V13 Gen7</p> <p>FWHM 72.0°</p> <p>Efficiency 86 %</p> <p>Peak intensity 0.6 cd/lm</p> <p>LEDs/each optic 1</p> <p>Light colour White</p> <p>Required components: IDEAL: 50-2103CT + 50-2100AN</p>	
<p>bridgelux.</p> <p>LED V13 Gen7</p> <p>FWHM 80.0°</p> <p>Efficiency 82 %</p> <p>Peak intensity 0.5 cd/lm</p> <p>LEDs/each optic 1</p> <p>Light colour White</p> <p>Required components: C13658_CLAMP-VERO13-18 Bender Wirth: 477 Typ L1</p>	
<p>CITIZEN</p> <p>LED CLL02x/CLU02x (LES10)</p> <p>FWHM 90.0°</p> <p>Efficiency 86 %</p> <p>Peak intensity 0.4 cd/lm</p> <p>LEDs/each optic 1</p> <p>Light colour White</p> <p>Required components: C13658_CLAMP-VERO13-18 Bender Wirth: 434 Typ L1</p>	

PHOTOMETRIC DATA (SIMULATED):

CITIZEN

LED CLU700/701/702
FWHM 90.0°
Efficiency 87 %
Peak intensity 0.5 cd/lm
LEDs/each optic 1
Light colour White
Required components:
C13658_CLAMP-VERO13-18
Bender Wirth: 434 Typ L1

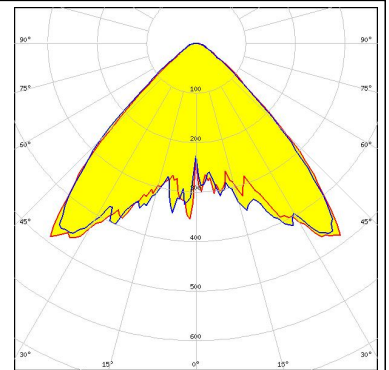

CITIZEN

LED CLU710/711
FWHM 88.0°
Efficiency 87 %
Peak intensity 0.5 cd/lm
LEDs/each optic 1
Light colour White
Required components:
C13658_CLAMP-VERO13-18
Bender Wirth: 470 Typ L1

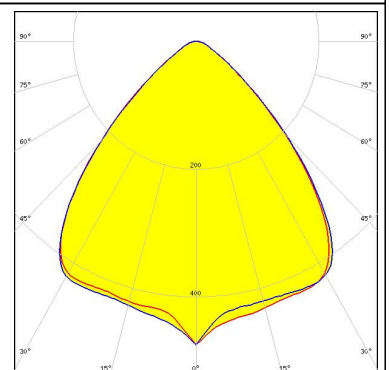

CREE

LED CXA/B 13xx
FWHM 90.0°
Efficiency 87 %
Peak intensity 0.5 cd/lm
LEDs/each optic 1
Light colour White
Required components:
C13658_CLAMP-VERO13-18
Bender Wirth: 448 Typ L1

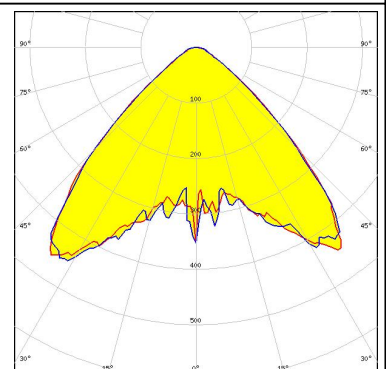

CREE

LED CXA/B 15xx
FWHM 90.0°
Efficiency 87 %
Peak intensity 0.4 cd/lm
LEDs/each optic 1
Light colour White
Required components:
C14123_CLAMP-CXA15-18

PHOTOMETRIC DATA (SIMULATED):

CREE

LED CXA/B 15xx
FWHM 90.0°
Efficiency 87 %
Peak intensity 0.4 cd/lm
LEDs/each optic 1
Light colour White
Required components:
C13658_CLAMP-VERO13-18
Bender Wirth: 441 Typ L1

CREE

LED CXA/B 1816 & CXA/B 1820 & CXA 1850
FWHM 90.0°
Efficiency 87 %
Peak intensity 0.4 cd/lm
LEDs/each optic 1
Light colour White
Required components:
C14123_CLAMP-CXA15-18

CREE

LED CXA/B 1816 & CXA/B 1820 & CXA 1850
FWHM 84.0°
Efficiency 84 %
LEDs/each optic 1
Light colour White
Required components:
TE: 2213401-2 + OPTIC CLIP Z50 TYPE1 2213194-1

CREE

LED CXA/B 1816 & CXA/B 1820 & CXA 1850
FWHM 90.0°
Efficiency 87 %
Peak intensity 0.4 cd/lm
LEDs/each optic 1
Light colour White
Required components:
C13658_CLAMP-VERO13-18
Bender Wirth: 437 Typ L1

PHOTOMETRIC DATA (SIMULATED):



LED CXA/B 1830
 FWHM 84.0°
 Efficiency 85 %
 LEDs/each optic 1
 Light colour White
 Required components:
 C14123_CLAMP-CXA15-18



LED LUXEON CoB 1202/1203
 FWHM 82.0°
 Efficiency 86 %
 Peak intensity 0.5 cd/lm
 LEDs/each optic 1
 Light colour White
 Required components:
 TE: 2213382-2 + OPTIC CLIP Z50 TYPE1 2213194-1

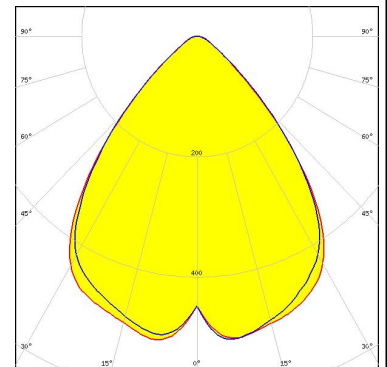

LED LUXEON CoB 1202s
 FWHM 90.0°
 Efficiency 87 %
 Peak intensity 0.4 cd/lm
 LEDs/each optic 1
 Light colour White
 Required components:
 C13658_CLAMP-VERO13-18
 Bender Wirth: 452 Typ L1

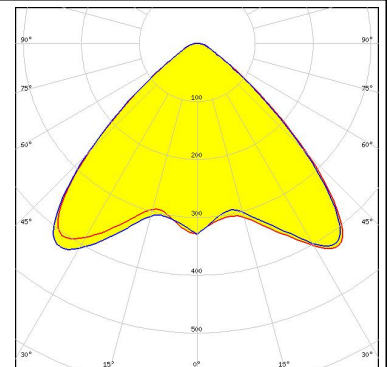

LED COB L-Type (LES 9)
 FWHM 83.0°
 Efficiency 86 %
 Peak intensity 0.5 cd/lm
 LEDs/each optic 1
 Light colour White
 Required components:
 TE: 2213382-2 + OPTIC CLIP Z50 TYPE1 2213194-1

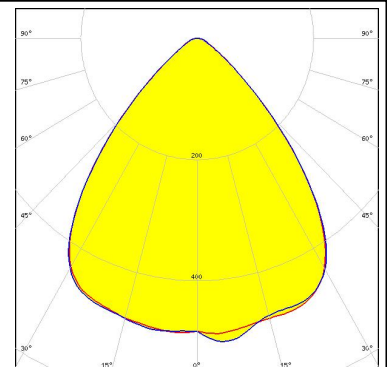

PHOTOMETRIC DATA (SIMULATED):



LED NSCxL036A
FWHM 85.0°
Efficiency 87 %
Peak intensity 0.5 cd/lm
LEDs/each optic 1
Light colour White
Required components:
TE: 2213382-2 + OPTIC CLIP Z50 TYPE1 2213194-1



LED Duris S10
FWHM 99.0°
Efficiency 86 %
Peak intensity 0.4 cd/lm
LEDs/each optic 1
Light colour White
Required components:
C13658_CLAMP-VERO13-18



LED Mini Zenigata (GW6BM)
FWHM 88.0°
Efficiency 86 %
Peak intensity 0.5 cd/lm
LEDs/each optic 1
Light colour White
Required components:
C13658_CLAMP-VERO13-18
Bender Wirth: 452 Typ L1

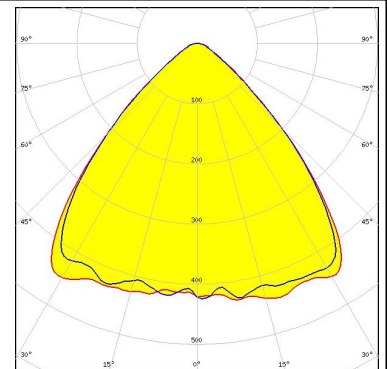

GENERAL INFORMATION:

NOTE: The typical beam angle will be changed by different color, chip size and chip position tolerance. The typical total beam angle is the full angle measured where the luminous intensity is half of the peak value.

Due to use of high power COB's with this product, special attention to proper thermal design is highly recommended. LEDiL has no liability for direct, indirect or consecutive damages arising from the LEDiL products being used outside of the recommended temperature range.

MATERIALS:

As part of our continuous research and improvement processes, and to ensure the best possible quality and availability of our products, LEDiL reserves the right to change material grades without notice.

PRODUCT DATA USER AGREEMENT AND DISCLAIMER:

The measured data in the provided downloadable LEDiL Product Datasheets and Mechanical 2D-Drawings is rounded and provided as reference for planning. LEDiL Oy's optical specifications have been verified by conducting performance testing of the products in accordance with the company's quality system. The reported data are averaged results of multiple measurements with typical variation. LEDiL Oy reserves the right to without prior notification make changes and improvements to its products.

LEDiL Oy assumes neither warranty, nor guarantee nor any other liability of any kind for the contents and correctness of the provided data. The provided data has been generated with highest diligence but the provided data may in reality not represent the complete possible variation range of all intrinsic parameters. Therefore, in certain cases a deviation from the provided data could occur.

LEDiL Oy reserves the right to undertake technical changes of its products without further notification which could lead to changes in the provided data. LEDiL Oy assumes no liability of any kind for the possible deviation from any provided data or any other damage resulting from the usage of the provided data.

The user agrees to this disclaimer and user agreement with the download or usage of the provided files.

LEDiL Oy

Joensuunkatu 13
FI-24240 SALO
Finland

LEDiL Inc.

228 West Page Street
Suite D
Sycamore IL 60178
USA

Local sales and technical support

www.ledil.com/where_to_buy

Shipping locations

Salo, Finland
Hong Kong, China

Distribution Partners

www.ledil.com/where_to_buy



Компания «ЭлектроПласт» предлагает заключение долгосрочных отношений при поставках импортных электронных компонентов на взаимовыгодных условиях!

Наши преимущества:

- Оперативные поставки широкого спектра электронных компонентов отечественного и импортного производства напрямую от производителей и с крупнейших мировых складов;
- Поставка более 17-ти миллионов наименований электронных компонентов;
- Поставка сложных, дефицитных, либо снятых с производства позиций;
- Оперативные сроки поставки под заказ (от 5 рабочих дней);
- Экспресс доставка в любую точку России;
- Техническая поддержка проекта, помощь в подборе аналогов, поставка прототипов;
- Система менеджмента качества сертифицирована по Международному стандарту ISO 9001;
- Лицензия ФСБ на осуществление работ с использованием сведений, составляющих государственную тайну;
- Поставка специализированных компонентов (Xilinx, Altera, Analog Devices, Intersil, Interpoint, Microsemi, Aeroflex, Peregrine, Syfer, Eurofarad, Texas Instrument, Miteq, Cobham, E2V, MA-COM, Hittite, Mini-Circuits, General Dynamics и др.);

Помимо этого, одним из направлений компании «ЭлектроПласт» является направление «Источники питания». Мы предлагаем Вам помощь Конструкторского отдела:

- Подбор оптимального решения, техническое обоснование при выборе компонента;
- Подбор аналогов;
- Консультации по применению компонента;
- Поставка образцов и прототипов;
- Техническая поддержка проекта;
- Защита от снятия компонента с производства.



Как с нами связаться

Телефон: 8 (812) 309 58 32 (многоканальный)

Факс: 8 (812) 320-02-42

Электронная почта: org@eplast1.ru

Адрес: 198099, г. Санкт-Петербург, ул. Калинина, дом 2, корпус 4, литера А.