

COMPACT POWER TWIN RELAY

1POLE X 2, H-BRIDGE— 25 A FOR AUTOMOTIVE APPLICATIONS

FTR-P4 Series

RoHS compliant

■ FEATURES

- Compact for high density packaging.
(60% volume of previous generation FBR512).
- High contact capacity with proven contact material.
(100,000 operations, 14 V, 25 A achieved, even with reduced size).
- Coil power savings
(600mW nominal achieved with state-of-the-art magnetic analysis/design).
- 125°C version is available.
- Ease of PCB layout
(all terminals on perimeter, coil and contact terminals separated).
- Pin compatible with low acoustic noise relay, FTR-P2.
- Optional over-voltage circuit breaking capability
(0.6mm gap, contact our representative).
- Packaging for auto-insertion
(tube packing, 30 relays/tube).
- RoHS compliant since date code: 0624
Please see page 8 for more information



■ ORDERING INFORMATION

[Example] FTR-P4 C N 012 W1 ***
 (a) (b) (c) (d) (e) (f)

(a)	Series Name	FTR-P4 Series
(b)	Contact Arrangement	C : 1 Form C x 2 (H-Bridge)
(c)	Contact Gap	N : 0.3mm gap P : 0.6mm gap
(d)	Nominal Coil Voltage	009 : 9VDC 010 : 10VDC 012 : 12VDC
(e)	Contact Material	W1 : Silver-tin oxide-indium
(f)	Custom Designation	Nil : Standard (85°C) -01 : High temperature (125°C)

Note: The part number stamped on the relay cover does not include "FTR".

Example: Ordering part number: FTR-P4CN012W1

Stamped on part number: P4CN012W1

■ TYPICAL APPLICATIONS

Power window	Power seat	Tilt steering
Door lock	Sun roof	Retractable antenna

FTR-P4 SERIES

■ SPECIFICATIONS

Item		Specification		
		Standard	High Temperature version	
Contact	Arrangement	1 form C x 2 (H-Bridge)		
	Material	Silver-tin oxide-indium		
	Voltage Drop (Resistance)	Maximum 100 mV (at 1 A 12 VDC)		
	Rating	25 A at 14 VDC (locked motor load)		
	Maximum Carrying Current	25 A / 1 hour (20° C, 100% rated coil voltage)		
	Maximum Inrush Current (Reference)	35 A		
	Maximum Switching Current (Reference)	35 A at 16 VDC		
	Minimum Switching Load*1 (Reference)	1 A, 6 VDC		
Coil	Operating Temperature Range	-40° C to +85° C (no frost)	-40° C to +125° C (no frost)	
	Storage Temperature Range	-40° C to +100° C (no frost)	-40° C to +125° C (no frost)	
Timing Values	Operate (at nominal voltage)	Maximum 10ms (not including bounce)		
	Release (at nominal voltage)	Maximum 5ms (not including bounce, no diode) Maximum 15ms (not including bounce, with diode)		
Life	Mechanical	10 x 10 ⁶ operations minimum		
	Electrical	100 x 10 ³ operations minimum 14 VDC, 25 A (locked motor load) (1 operation = 1 forward, 1 reverse)		
Other	Vibration Resistance	Operational	10-55Hz, 1.5mm double amplitude (=9.13G @ 55Hz) 55-100Hz, 45m/sec ² (4.6G)	
		Shock Resistance	Operational	100 m/s ² minimum (10G)
		Endurance	1, 000 m/s ² minimum (100G)	
	Insulation Resistance (initial)		100M ohms @500 VAC	
	Dielectric Withstanding Voltage (initial)		500 VAC	
	Weight		Approximately 9.0g	

*1 Values when switching a resistive load at normal room temperature and humidity and in a clean environment. The minimum switching load varies with the switching frequency and operating environment.

FTR-P4 SERIES

■ COIL DATA CHART

FTR-P4 Series (0.25mm contact gap)

Model	Nominal Coil Voltage	Coil Resistance (±10% at 20°C)	Must Operate Voltage	Must Release Voltage (at 20°C)	Coil Power at Nominal Voltage	Thermal Resistance (approx.)
FTR-P4-CN009W1 ()	9VDC	135Ω	5.5VDC (at 20°C) 6.9VDC (at 85°C)	0.75VDC	0.6W	73°C/W
FTR-P4-CN010W1 ()	10VDC	167Ω	6.3VDC (at 20°C) 7.9VDC (at 85°C)	0.9VDC	0.6W	73°C/W
FTR-P4-CN012W1 ()	12VDC	240Ω	7.3VDC (at 20°C) 9.2VDC (at 85°C)	1.0VDC	0.6W	73°C/W

Note: () is "Nil" or "-01"

FTR-P4 Series (0.6mm contact gap)

Model	Nominal Coil Voltage	Coil Resistance (±10% at 20°C)	Must Operate Voltage	Must Release Voltage (at 20°C)	Coil Power at Nominal Voltage	Thermal Resistance (approx.)
FTR-P4-CP009W1	9VDC	100Ω	5.5VDC (at 20°C) 6.9VDC (at 85°C)	0.75VDC	0.8W	73°C/W
FTR-P4-CP010W1	10VDC	125Ω	6.3VDC (at 20°C) 7.9VDC (at 85°C)	0.9VDC	0.8W	73°C/W
FTR-P4-CP012W1	12VDC	167Ω	7.3VDC (at 20°C) 9.2VDC (at 85°C)	1.0VDC	0.8W	73°C/W

CHARACTERISTIC DATA

1. LIFE TEST (EXAMPLES)

- Test item
14 V DC-25 A
locked motor
100K operations* minimum
0.25 seconds ON,
9.75 seconds OFF

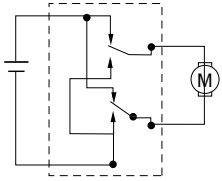

- Current wave form

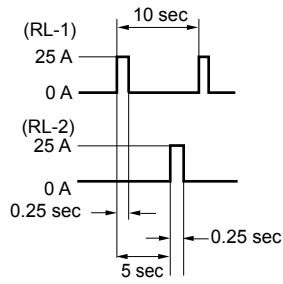

* 1 operation = 1 forward and 1 reverse

- Change of operate and release voltage

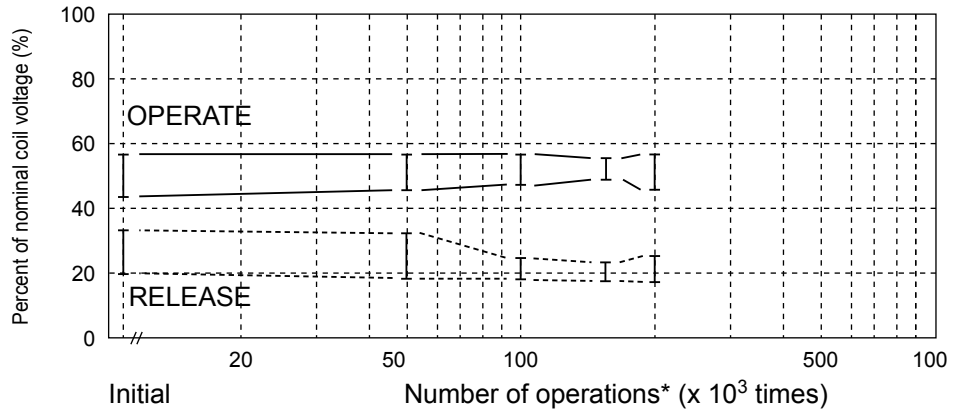

- Change in contact resistance

(Measured at 6 VDC, 1A wet)

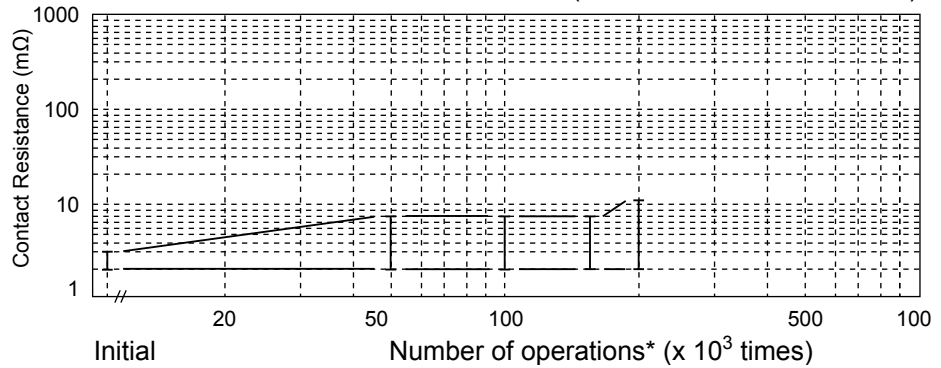

2. MAXIMUM BREAK CAPACITY

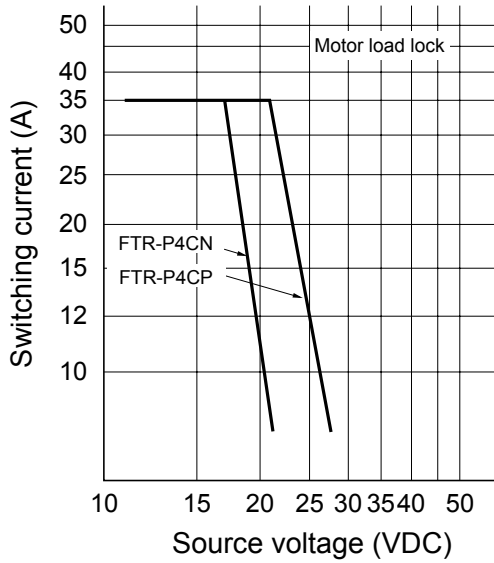

3. COIL TEMPERATURE RISE

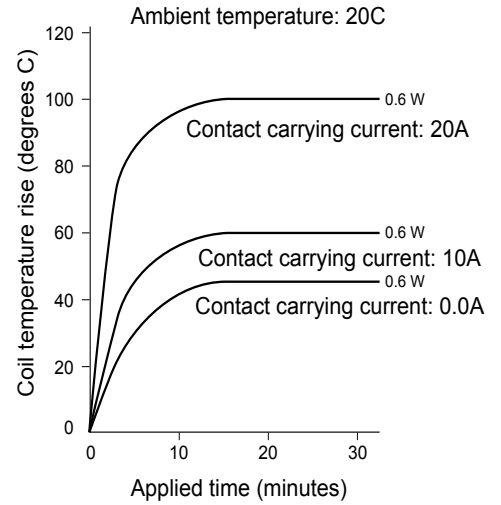

4. OPERATING COIL VOLTAGE RANGE

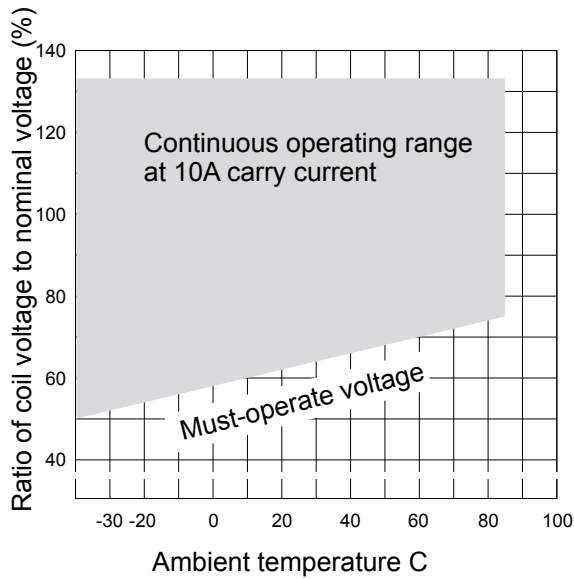

5. VIBRATION RESISTANCE CHARACTERISTIC

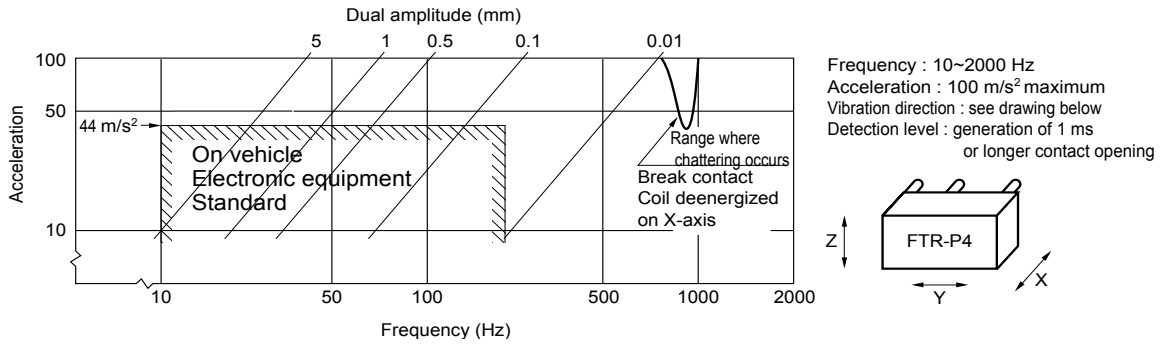

6. SHOCK RESISTANCE CHARACTERISTIC

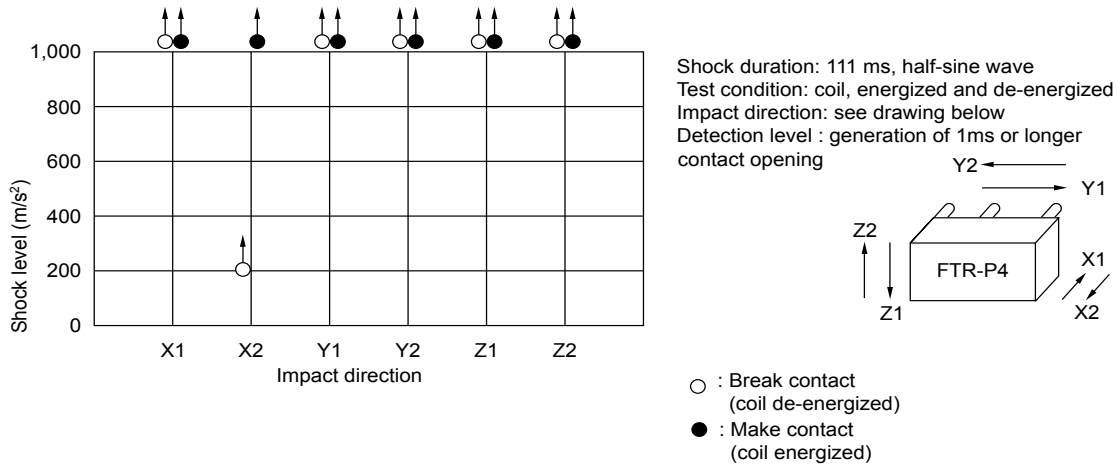

■ REFERENCE DATA

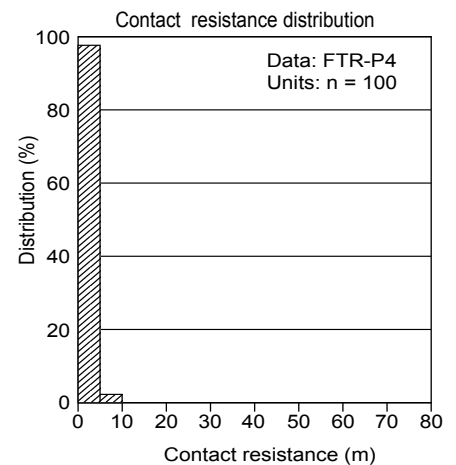
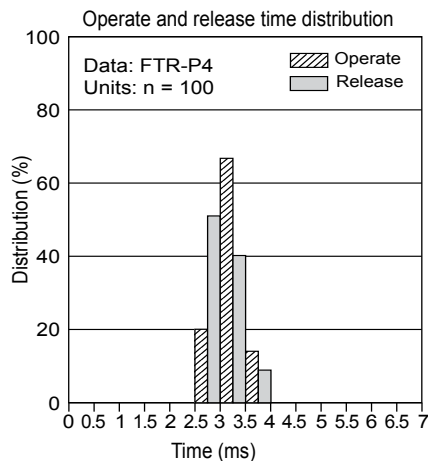
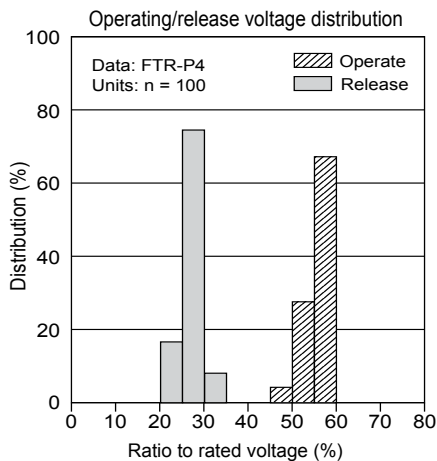

■ DIMENSIONS AND SCHEMATICS

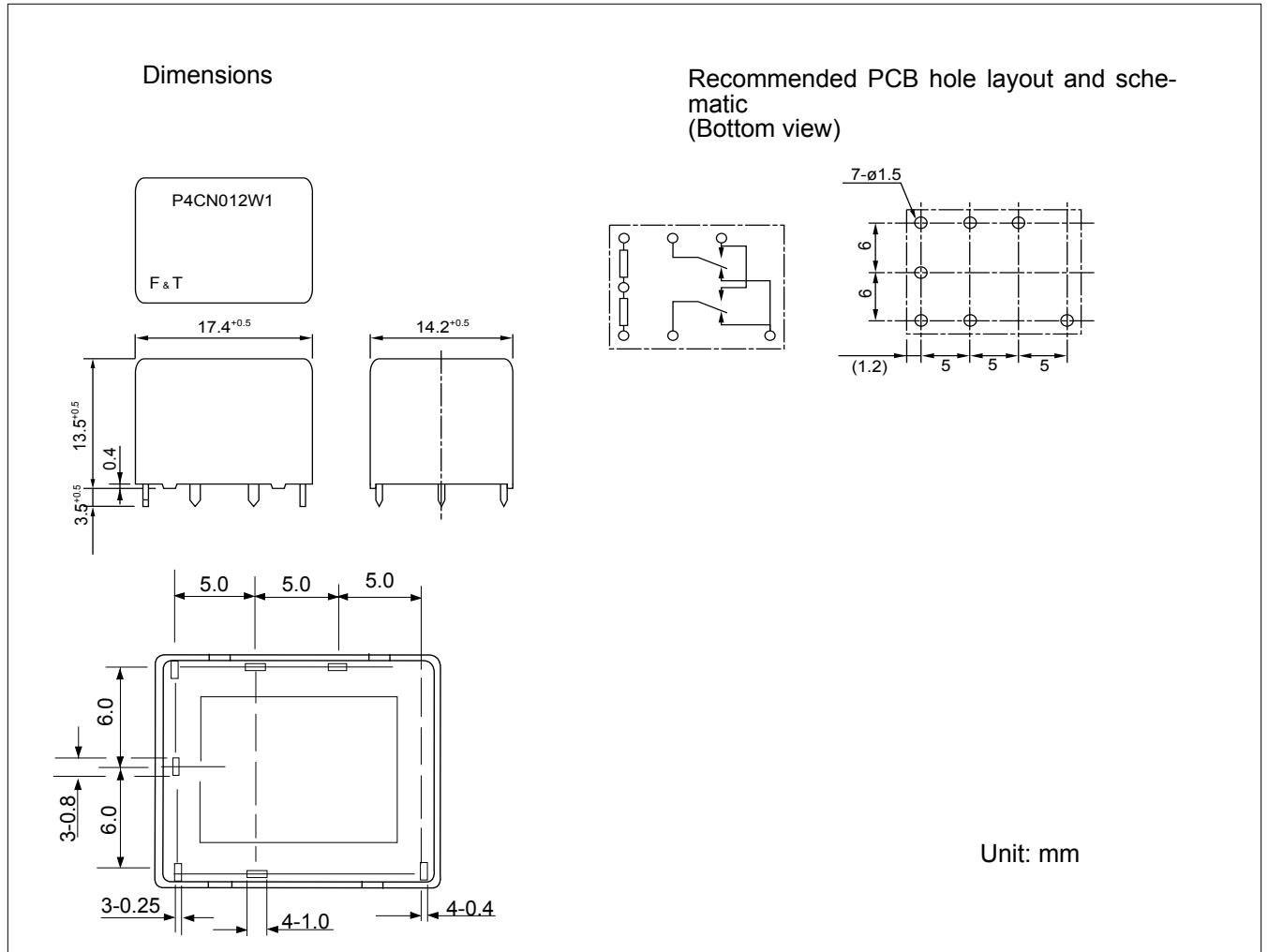

■ PRECAUTIONS

Please refer to the Engineering Reference in our relay databook for general precautions.

RoHS Compliance and Lead Free Relay Information

1. General Information

- Relays produced after the specific date code that is indicated on each data sheet are lead-free now. Most of our signal and power relays are lead-free. Please refer to Lead-Free Status Info. (<http://www.fujitsu.com/us/downloads/MICRO/fcai/relays/lead-free-letter.pdf>)
- Lead free solder paste currently used in relays is Sn-3.0Ag-0.5Cu.
- All signal and most power relays also comply with RoHS. Please refer to individual data sheets. Relays that are RoHS compliant do not contain the 5 hazardous materials that are restricted by RoHS directive (lead, mercury, chromium IV, PBB, PBDE).
- It has been verified that using lead-free relays in leaded assembly process will not cause any problems (compatible).
- "LF" is marked on each outer and inner carton. (No marking on individual relays).
- To avoid leaded relays (for lead-free sample, etc.) please consult with area sales office.
- We will ship leaded relays as long as the leaded relay inventory exists.

Note: Cadmium was exempted from RoHS on October 21, 2005. (Amendment to Directive 2002/95/EC)

2. Recommended Lead Free Solder Profile

- Recommended solder paste Sn-3.0Ag-0.5Cu.

Reflow Solder condition

Flow Solder condition:

Pre-heating: maximum 120°C
Soldering: dip within 5 sec. at
260°C solder bath

Solder by Soldering Iron:

Soldering Iron
Temperature: maximum 360°C
Duration: maximum 3 sec.

We highly recommend that you confirm your actual solder conditions

3. Moisture Sensitivity

- Moisture Sensitivity Level standard is not applicable to electromechanical relays.

4. Tin Whisker

- Dipped SnAgCu solder is known as low risk tin whisker. No considerable length whisker was found by our in house test.

Fujitsu Components International Headquarter Offices

Japan

Fujitsu Component Limited
Gotanda-Chuo Building
3-5, Higashigotanda 2-chome, Shinagawa-ku
Tokyo 141 8630, Japan
Tel: (81-3) 5449-7010
Fax: (81-3) 5449-2626
Email: promothq@fcl.fujitsu.com
Web: www.fcl.fujitsu.com

North and South America

Fujitsu Components America, Inc.
250 E. Caribbean Drive
Sunnyvale, CA 94089 U.S.A.
Tel: (1-408) 745-4900
Fax: (1-408) 745-4970
Email: components@us.fujitsu.com
Web: <http://www.fujitsu.com/us/services/edevices/components/>

Europe

Fujitsu Components Europe B.V.
Diamantlaan 25
2132 WV Hoofddorp
Netherlands
Tel: (31-23) 5560910
Fax: (31-23) 5560950
Email: info@fceu.fujitsu.com
Web: emea.fujitsu.com/components/

Asia Pacific

Fujitsu Components Asia Ltd.
102E Pasir Panjang Road
#01-01 Citilink Warehouse Complex
Singapore 118529
Tel: (65) 6375-8560
Fax: (65) 6273-3021
Email: fcal@fcal.fujitsu.com
Web: <http://www.fujitsu.com/sg/services/micro/components/>

©2009 Fujitsu Components America, Inc. All rights reserved. All trademarks or registered trademarks are the property of their respective owners.

Fujitsu Components America or its affiliates do not warrant that the content of datasheet is error free. In a continuing effort to improve our products Fujitsu Components America, Inc. or its affiliates reserve the right to change specifications/datasheets without prior notice.
Rev. March 4, 2009.



Компания «ЭлектроПласт» предлагает заключение долгосрочных отношений при поставках импортных электронных компонентов на взаимовыгодных условиях!

Наши преимущества:

- Оперативные поставки широкого спектра электронных компонентов отечественного и импортного производства напрямую от производителей и с крупнейших мировых складов;
- Поставка более 17-ти миллионов наименований электронных компонентов;
- Поставка сложных, дефицитных, либо снятых с производства позиций;
- Оперативные сроки поставки под заказ (от 5 рабочих дней);
- Экспресс доставка в любую точку России;
- Техническая поддержка проекта, помощь в подборе аналогов, поставка прототипов;
- Система менеджмента качества сертифицирована по Международному стандарту ISO 9001;
- Лицензия ФСБ на осуществление работ с использованием сведений, составляющих государственную тайну;
- Поставка специализированных компонентов (Xilinx, Altera, Analog Devices, Intersil, Interpoint, Microsemi, Aeroflex, Peregrine, Syfer, Eurofarad, Texas Instrument, Miteq, Cobham, E2V, MA-COM, Hittite, Mini-Circuits, General Dynamics и др.);

Помимо этого, одним из направлений компании «ЭлектроПласт» является направление «Источники питания». Мы предлагаем Вам помощь Конструкторского отдела:

- Подбор оптимального решения, техническое обоснование при выборе компонента;
- Подбор аналогов;
- Консультации по применению компонента;
- Поставка образцов и прототипов;
- Техническая поддержка проекта;
- Защита от снятия компонента с производства.



Как с нами связаться

Телефон: 8 (812) 309 58 32 (многоканальный)

Факс: 8 (812) 320-02-42

Электронная почта: org@eplast1.ru

Адрес: 198099, г. Санкт-Петербург, ул. Калинина, дом 2, корпус 4, литера А.