

IHM-B Modul mit soft schaltendem Trench-IGBT4  
IHM-B module with soft-switching Trench-IGBT4

**Vorläufige Daten / preliminary data**

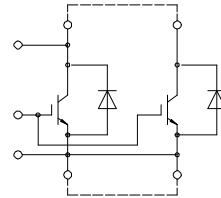

external connection  
(to be done)

**V<sub>CEs</sub> = 1700V**  
**I<sub>C nom</sub> = 2400A / I<sub>CRM</sub> = 4800A**

**Typische Anwendungen**

- Hochleistungsumrichter
- Motorantriebe

**Typical Applications**

- High Power Converters
- Motor Drives

**Elektrische Eigenschaften**

- Erweiterte Sperrschichttemperatur T<sub>vj op</sub>
- T<sub>vj op</sub> = 150°C
- Niedriges V<sub>CEsat</sub>

**Electrical Features**

- Extended Operation Temperature T<sub>vj op</sub>
- T<sub>vj op</sub> = 150°C
- Low V<sub>CEsat</sub>

**Mechanische Eigenschaften**

- 4 kV AC 1min Isolationsfestigkeit
- Gehäuse mit CTI > 400
- Große Luft- und Kriechstrecken
- Hohe Leistungsdichte
- Kupferbodenplatte
- IHM B Gehäuse

**Mechanical Features**

- 4 kV AC 1min Insulation
- Package with CTI > 400
- High Creepage and Clearance Distances
- High Power Density
- Copper Base Plate
- IHM B Housing

**Module Label Code**

Barcode Code 128



DMX - Code



**Content of the Code**

	Digit
Module Serial Number	1 - 5
Module Material Number	6 - 11
Production Order Number	12 - 19
Datecode (Production Year)	20 - 21
Datecode (Production Week)	22 - 23

prepared by: WB	date of publication: 2010-01-19	material no: 31353
approved by: IL	revision: 2.1	

**Vorläufige Daten**  
**preliminary data**

**IGBT-Wechselrichter / IGBT-inverter**

**Höchstzulässige Werte / maximum rated values**

Kollektor-Emitter-Sperrspannung collector-emitter voltage	$T_{vj} = 25^{\circ}\text{C}$	$V_{CES}$	1700	V
Kollektor-Dauergleichstrom DC-collector current	$T_C = 100^{\circ}\text{C}, T_{vj} = 175^{\circ}\text{C}$	$I_{C\text{ nom}}$	2400	A
Periodischer Kollektor Spitzenstrom repetitive peak collector current	$t_p = 1\text{ ms}$	$I_{CRM}$	4800	A
Gesamt-Verlustleistung total power dissipation	$T_C = 25^{\circ}\text{C}, T_{vj} = 175^{\circ}\text{C}$	$P_{\text{tot}}$	14,0	kW
Gate-Emitter-Spitzenspannung gate-emitter peak voltage		$V_{GES}$	+/-20	V

**Charakteristische Werte / characteristic values**

			min.	typ.	max.		
Kollektor-Emitter Sättigungsspannung collector-emitter saturation voltage	$I_C = 2400\text{ A}, V_{GE} = 15\text{ V}$ $I_C = 2400\text{ A}, V_{GE} = 15\text{ V}$ $I_C = 2400\text{ A}, V_{GE} = 15\text{ V}$	$T_{vj} = 25^{\circ}\text{C}$ $T_{vj} = 125^{\circ}\text{C}$ $T_{vj} = 150^{\circ}\text{C}$	$V_{CE\text{ sat}}$	1,90 2,30 2,40	2,25	V V V	
Gate-Schwellenspannung gate threshold voltage	$I_C = 96,0\text{ mA}, V_{CE} = V_{GE}, T_{vj} = 25^{\circ}\text{C}$		$V_{GEth}$	5,2	5,8	6,4	V
Gateladung gate charge	$V_{GE} = -15\text{ V} \dots +15\text{ V}$		$Q_G$	25,5			$\mu\text{C}$
Interner Gatewiderstand internal gate resistor	$T_{vj} = 25^{\circ}\text{C}$		$R_{Gint}$	0,81			$\Omega$
Eingangskapazität input capacitance	$f = 1\text{ MHz}, T_{vj} = 25^{\circ}\text{C}, V_{CE} = 25\text{ V}, V_{GE} = 0\text{ V}$		$C_{ies}$	195			nF
Rückwirkungskapazität reverse transfer capacitance	$f = 1\text{ MHz}, T_{vj} = 25^{\circ}\text{C}, V_{CE} = 25\text{ V}, V_{GE} = 0\text{ V}$		$C_{res}$	6,30			nF
Kollektor-Emitter Reststrom collector-emitter cut-off current	$V_{CE} = 1700\text{ V}, V_{GE} = 0\text{ V}, T_{vj} = 25^{\circ}\text{C}$		$I_{CES}$			5,0	mA
Gate-Emitter Reststrom gate-emitter leakage current	$V_{CE} = 0\text{ V}, V_{GE} = 20\text{ V}, T_{vj} = 25^{\circ}\text{C}$		$I_{GES}$			400	nA
Einschaltverzögerungszeit (ind. Last) turn-on delay time (inductive load)	$I_C = 2400\text{ A}, V_{CE} = 900\text{ V}$ $V_{GE} = \pm 15\text{ V}$ $R_{Gon} = 0,4\ \Omega$	$T_{vj} = 25^{\circ}\text{C}$ $T_{vj} = 125^{\circ}\text{C}$ $T_{vj} = 150^{\circ}\text{C}$	$t_{d\text{ on}}$	0,65 0,73 0,79			$\mu\text{s}$ $\mu\text{s}$ $\mu\text{s}$
Anstiegszeit (induktive Last) rise time (inductive load)	$I_C = 2400\text{ A}, V_{CE} = 900\text{ V}$ $V_{GE} = \pm 15\text{ V}$ $R_{Gon} = 0,4\ \Omega$	$T_{vj} = 25^{\circ}\text{C}$ $T_{vj} = 125^{\circ}\text{C}$ $T_{vj} = 150^{\circ}\text{C}$	$t_r$	0,20 0,21 0,22			$\mu\text{s}$ $\mu\text{s}$ $\mu\text{s}$
Abschaltverzögerungszeit (ind. Last) turn-off delay time (inductive load)	$I_C = 2400\text{ A}, V_{CE} = 900\text{ V}$ $V_{GE} = \pm 15\text{ V}$ $R_{Goff} = 0,5\ \Omega$	$T_{vj} = 25^{\circ}\text{C}$ $T_{vj} = 125^{\circ}\text{C}$ $T_{vj} = 150^{\circ}\text{C}$	$t_{d\text{ off}}$	1,30 1,40 1,45			$\mu\text{s}$ $\mu\text{s}$ $\mu\text{s}$
Fallzeit (induktive Last) fall time (inductive load)	$I_C = 2400\text{ A}, V_{CE} = 900\text{ V}$ $V_{GE} = \pm 15\text{ V}$ $R_{Goff} = 0,5\ \Omega$	$T_{vj} = 25^{\circ}\text{C}$ $T_{vj} = 125^{\circ}\text{C}$ $T_{vj} = 150^{\circ}\text{C}$	$t_f$	0,19 0,33 0,36			$\mu\text{s}$ $\mu\text{s}$ $\mu\text{s}$
Einschaltverlustenergie pro Puls turn-on energy loss per pulse	$I_C = 2400\text{ A}, V_{CE} = 900\text{ V}, L_s = 50\text{ nH}$ $V_{GE} = \pm 15\text{ V}, di/dt = 11000\text{ A}/\mu\text{s} (T_{vj}=150^{\circ}\text{C})$ $R_{Gon} = 0,4\ \Omega$	$T_{vj} = 25^{\circ}\text{C}$ $T_{vj} = 125^{\circ}\text{C}$ $T_{vj} = 150^{\circ}\text{C}$	$E_{on}$	405 570 625			mJ mJ mJ
Abschaltverlustenergie pro Puls turn-off energy loss per pulse	$I_C = 2400\text{ A}, V_{CE} = 900\text{ V}, L_s = 50\text{ nH}$ $V_{GE} = \pm 15\text{ V}, du/dt = 2800\text{ V}/\mu\text{s} (T_{vj}=150^{\circ}\text{C})$ $R_{Goff} = 0,5\ \Omega$	$T_{vj} = 25^{\circ}\text{C}$ $T_{vj} = 125^{\circ}\text{C}$ $T_{vj} = 150^{\circ}\text{C}$	$E_{off}$	660 830 880			mJ mJ mJ
Kurzschlussverhalten SC data	$V_{GE} \leq 15\text{ V}, V_{CC} = 1000\text{ V}$ $V_{CEmax} = V_{CES} - L_{sCE} \cdot di/dt$ $t_p \leq 10\ \mu\text{s}, T_{vj} = 150^{\circ}\text{C}$		$I_{SC}$	9500			A
Innerer Wärmewiderstand thermal resistance, junction to case	pro IGBT / per IGBT		$R_{thJC}$			11,0	K/kW
Übergangs-Wärmewiderstand thermal resistance, case to heatsink	pro IGBT / per IGBT $\lambda_{\text{Paste}} = 1\text{ W}/(\text{m}\cdot\text{K})$ / $\lambda_{\text{grease}} = 1\text{ W}/(\text{m}\cdot\text{K})$		$R_{thCH}$	9,45			K/kW

prepared by: WB	date of publication: 2010-01-19
approved by: IL	revision: 2.1

**Vorläufige Daten  
preliminary data**

**Diode-Wechselrichter / diode-inverter**

**Höchstzulässige Werte / maximum rated values**

Periodische Spitzensperrspannung repetitive peak reverse voltage	$T_{vj} = 25^{\circ}\text{C}$	$V_{RRM}$	1700	V
Dauergleichstrom DC forward current		$I_F$	2400	A
Periodischer Spitzenstrom repetitive peak forward current	$t_p = 1 \text{ ms}$	$I_{FRM}$	4800	A
Grenzlastintegral $I^2t$ - value	$V_R = 0 \text{ V}, t_p = 10 \text{ ms}, T_{vj} = 125^{\circ}\text{C}$ $V_R = 0 \text{ V}, t_p = 10 \text{ ms}, T_{vj} = 150^{\circ}\text{C}$	$I^2t$	835 790	$\text{kA}^2\text{s}$ $\text{kA}^2\text{s}$
Spitzenverlustleistung maximum power dissipation	$T_{vj} = 125^{\circ}\text{C}$	$P_{RQM}$	2400	kW
Mindesteinschaltzeit minimum turn-on time		$t_{on \text{ min}}$	10,0	$\mu\text{s}$

**Charakteristische Werte / characteristic values**

			min.	typ.	max.	
Durchlassspannung forward voltage	$I_F = 2400 \text{ A}, V_{GE} = 0 \text{ V}$	$T_{vj} = 25^{\circ}\text{C}$		1,80	2,20	V
	$I_F = 2400 \text{ A}, V_{GE} = 0 \text{ V}$	$T_{vj} = 125^{\circ}\text{C}$	$V_F$	1,90		V
	$I_F = 2400 \text{ A}, V_{GE} = 0 \text{ V}$	$T_{vj} = 150^{\circ}\text{C}$		1,95		V
Rückstromspitze peak reverse recovery current	$I_F = 2400 \text{ A}, -di_F/dt = 11000 \text{ A}/\mu\text{s} (T_{vj}=150^{\circ}\text{C})$ $V_R = 900 \text{ V}$ $V_{GE} = -15 \text{ V}$	$T_{vj} = 25^{\circ}\text{C}$		2250		A
		$T_{vj} = 125^{\circ}\text{C}$	$I_{RM}$	2600		A
		$T_{vj} = 150^{\circ}\text{C}$		2600		A
Sperrverzögerungsladung recovered charge	$I_F = 2400 \text{ A}, -di_F/dt = 11000 \text{ A}/\mu\text{s} (T_{vj}=150^{\circ}\text{C})$ $V_R = 900 \text{ V}$ $V_{GE} = -15 \text{ V}$	$T_{vj} = 25^{\circ}\text{C}$		570		$\mu\text{C}$
		$T_{vj} = 125^{\circ}\text{C}$	$Q_r$	970		$\mu\text{C}$
		$T_{vj} = 150^{\circ}\text{C}$		1100		$\mu\text{C}$
Abschaltenergie pro Puls reverse recovery energy	$I_F = 2400 \text{ A}, -di_F/dt = 11000 \text{ A}/\mu\text{s} (T_{vj}=150^{\circ}\text{C})$ $V_R = 900 \text{ V}$ $V_{GE} = -15 \text{ V}$	$T_{vj} = 25^{\circ}\text{C}$		390		mJ
		$T_{vj} = 125^{\circ}\text{C}$	$E_{rec}$	690		mJ
		$T_{vj} = 150^{\circ}\text{C}$		780		mJ
Innerer Wärmewiderstand thermal resistance, junction to case	pro Diode / per diode	$R_{thJC}$			20,0	K/kW
Übergangs-Wärmewiderstand thermal resistance, case to heatsink	pro Diode / per diode $\lambda_{\text{Paste}} = 1 \text{ W}/(\text{m}\cdot\text{K}) / \lambda_{\text{grease}} = 1 \text{ W}/(\text{m}\cdot\text{K})$	$R_{thCH}$		10,5		K/kW

prepared by: WB	date of publication: 2010-01-19
approved by: IL	revision: 2.1

# Technische Information / technical information

IGBT-Module  
IGBT-modules

## FZ2400R17HP4



### Vorläufige Daten preliminary data

#### Modul / module

Isolations-Prüfspannung insulation test voltage	RMS, f = 50 Hz, t = 1 min.	V <sub>ISO</sub>	4,0		kV
Material Modulgrundplatte material of module baseplate			Cu		
Material für innere Isolation material for internal insulation			Al <sub>2</sub> O <sub>3</sub>		
Kriechstrecke creepage distance	Kontakt - Kühlkörper / terminal to heatsink Kontakt - Kontakt / terminal to terminal		32,2 32,2		mm
Luftstrecke clearance distance	Kontakt - Kühlkörper / terminal to heatsink Kontakt - Kontakt / terminal to terminal		19,1 19,1		mm
Vergleichszahl der Kriechwegbildung comparative tracking index		CTI	> 400		
			min.	typ.	max.
Modulinduktivität stray inductance module		L <sub>sCE</sub>		9,0	nH
Modulleitungswiderstand, Anschlüsse - Chip module lead resistance, terminals - chip	T <sub>C</sub> = 25°C, pro Schalter / per switch	R <sub>CC'+EE'</sub>		0,13	mΩ
Höchstzulässige Sperrschichttemperatur maximum junction temperature	Wechselrichter, Brems-Chopper / Inverter, Brake-Chopper	T <sub>vj max</sub>			175 °C
Temperatur im Schaltbetrieb temperature under switching conditions	Wechselrichter, Brems-Chopper / Inverter, Brake-Chopper	T <sub>vj op</sub>	-40		150 °C
Lagertemperatur storage temperature		T <sub>stg</sub>	-40		150 °C
Anzugsdrehmoment f. mech. Befestigung mounting torque	Schraube M6 - Montage gem. gültiger Applikation Note screw M6 - mounting according to valid application note	M	4,25	-	5,75 Nm
Anzugsdrehmoment f. elektr. Anschlüsse terminal connection torque	Schraube M4 - Montage gem. gültiger Applikation Note Schraube M8 - Montage gem. gültiger Applikation Note screw M8 - mounting according to valid application note	M	1,8	-	2,1 Nm
			8,0	-	10 Nm
Gewicht weight		G		1300	g

prepared by: WB	date of publication: 2010-01-19
approved by: IL	revision: 2.1

**Vorläufige Daten**  
**preliminary data**

**Ausgangskennlinie IGBT-Wechselr. (typisch)**  
**output characteristic IGBT-inverter (typical)**  
 $I_c = f(V_{CE})$   
 $V_{GE} = 15\text{ V}$

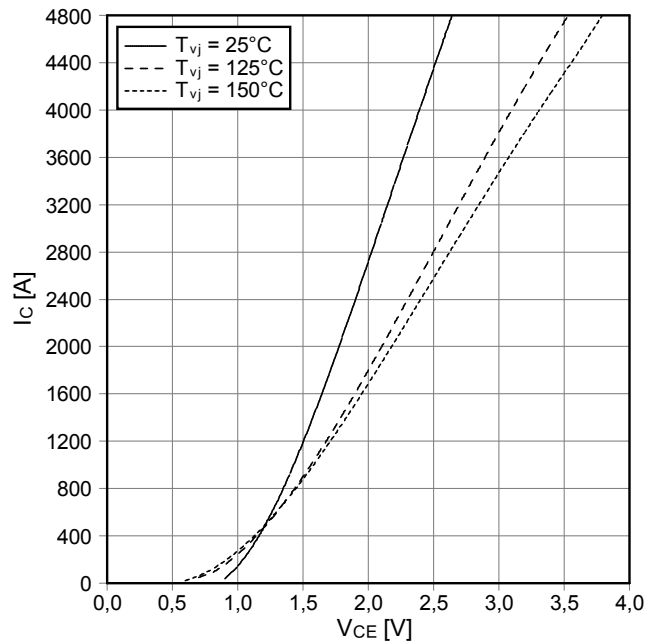

**Ausgangskennlinienfeld IGBT-Wechselr. (typisch)**  
**output characteristic IGBT-inverter (typical)**  
 $I_c = f(V_{CE})$   
 $T_{vj} = 150^\circ\text{C}$

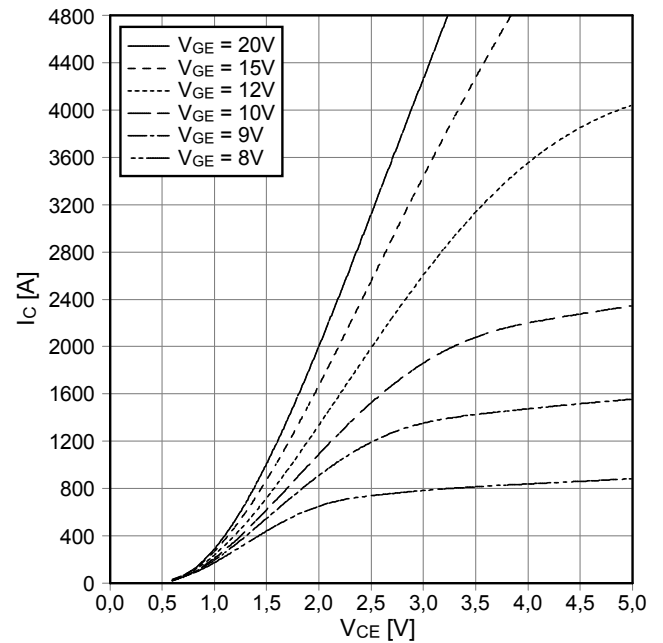

**Übertragungscharakteristik IGBT-Wechselr. (typisch)**  
**transfer characteristic IGBT-inverter (typical)**  
 $I_c = f(V_{GE})$   
 $V_{CE} = 20\text{ V}$

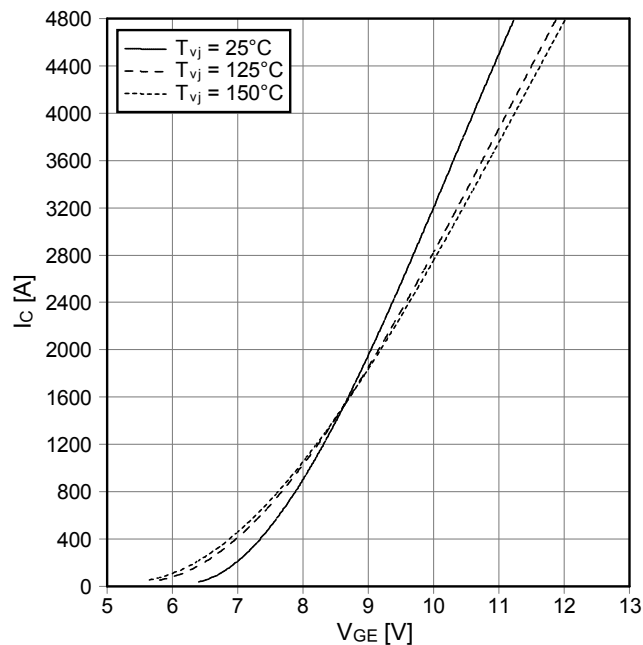

**Schaltverluste IGBT-Wechselr. (typisch)**  
**switching losses IGBT-inverter (typical)**  
 $E_{on} = f(I_c)$ ,  $E_{off} = f(I_c)$   
 $V_{GE} = \pm 15\text{ V}$ ,  $R_{Gon} = 0.4\ \Omega$ ,  $R_{Goff} = 0.5\ \Omega$ ,  $V_{CE} = 900\text{ V}$

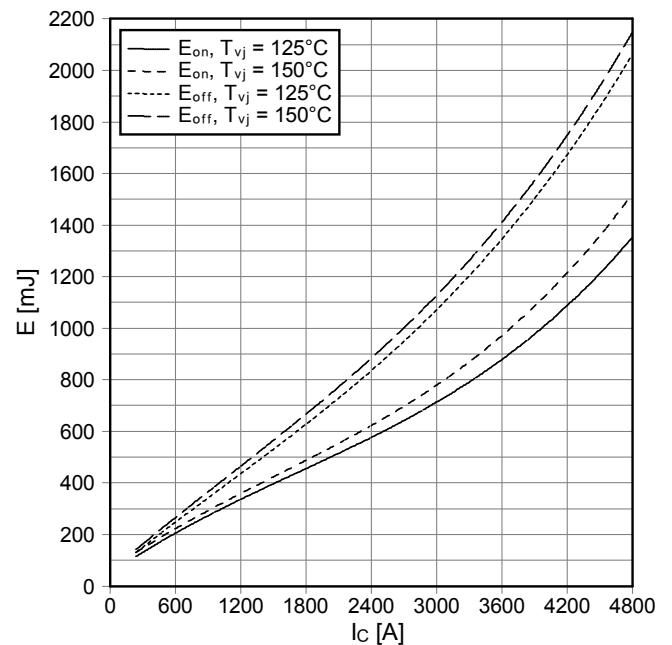

prepared by: WB	date of publication: 2010-01-19
approved by: IL	revision: 2.1

Vorläufige Daten  
preliminary data

Schaltverluste IGBT-Wechselr. (typisch)  
switching losses IGBT-inverter (typical)  
 $E_{on} = f(R_G)$ ,  $E_{off} = f(R_G)$   
 $V_{GE} = \pm 15\text{ V}$ ,  $I_C = 2400\text{ A}$ ,  $V_{CE} = 900\text{ V}$

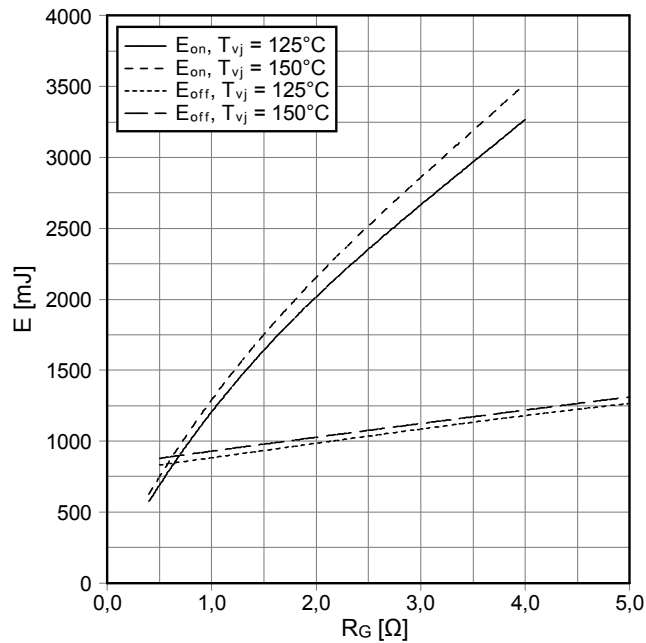

Transienter Wärmewiderstand IGBT-Wechselr.  
transient thermal impedance IGBT-inverter  
 $Z_{thJC} = f(t)$

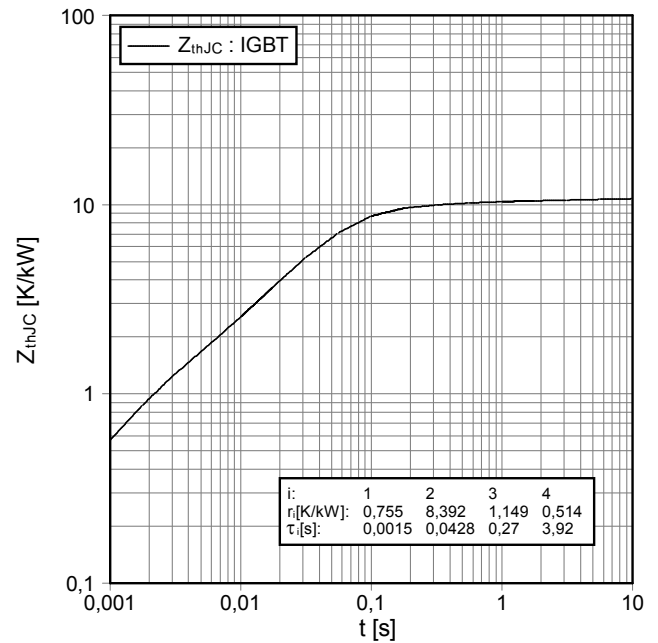

Sicherer Rückwärts-Arbeitsbereich IGBT-Wr. (RBSOA)  
reverse bias safe operating area IGBT-inv. (RBSOA)  
 $I_C = f(V_{CE})$   
 $V_{GE} = \pm 15\text{ V}$ ,  $R_{Goff} = 0.5\ \Omega$ ,  $T_{vj} = 150^\circ\text{C}$

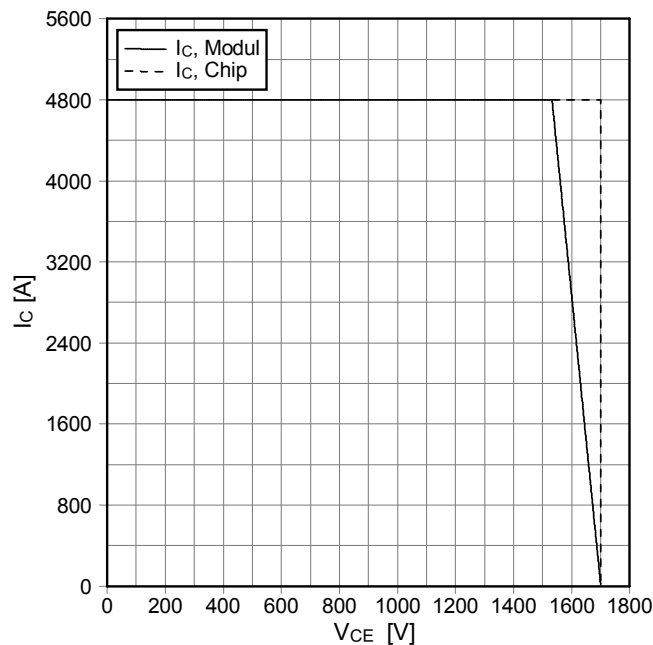

Durchlasskennlinie der Diode-Wechselr. (typisch)  
forward characteristic of diode-inverter (typical)  
 $I_F = f(V_F)$

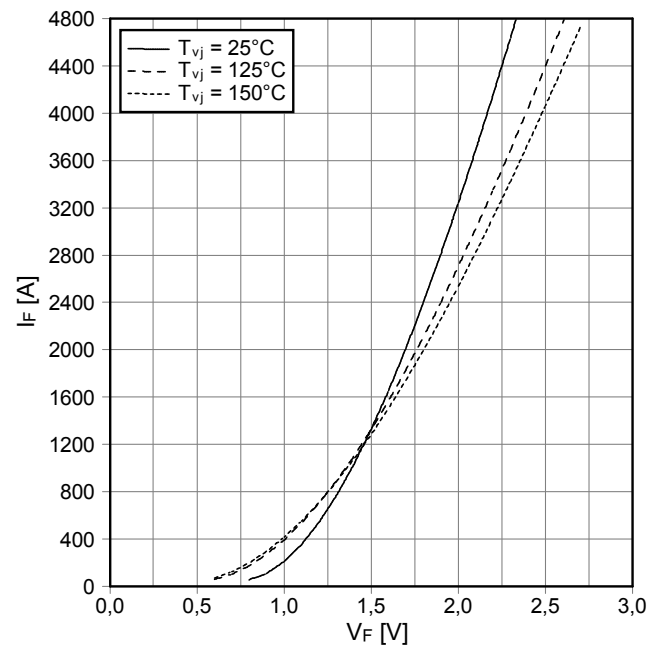

prepared by: WB	date of publication: 2010-01-19
approved by: IL	revision: 2.1

Vorläufige Daten  
preliminary data

Schaltverluste Diode-Wechselr. (typisch)  
switching losses diode-inverter (typical)

$E_{rec} = f(I_F)$   
 $R_{Gon} = 0.4 \Omega, V_{CE} = 900 V$

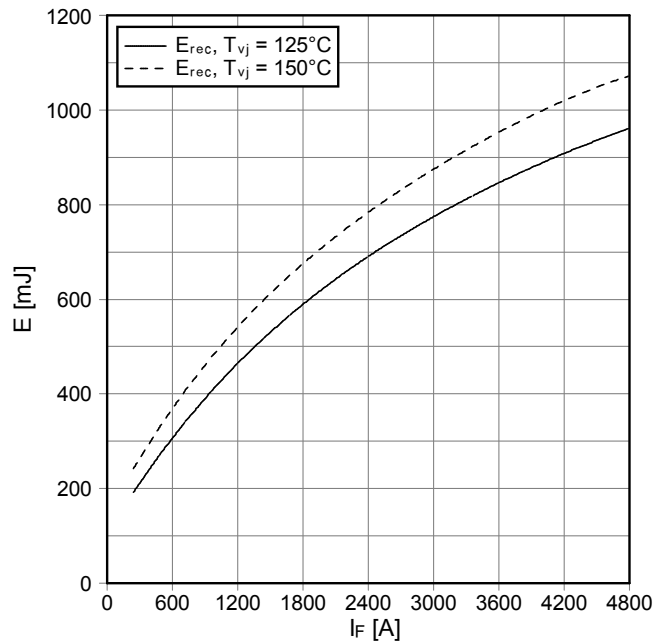

Schaltverluste Diode-Wechselr. (typisch)  
switching losses diode-inverter (typical)

$E_{rec} = f(R_G)$   
 $I_F = 2400 A, V_{CE} = 900 V$

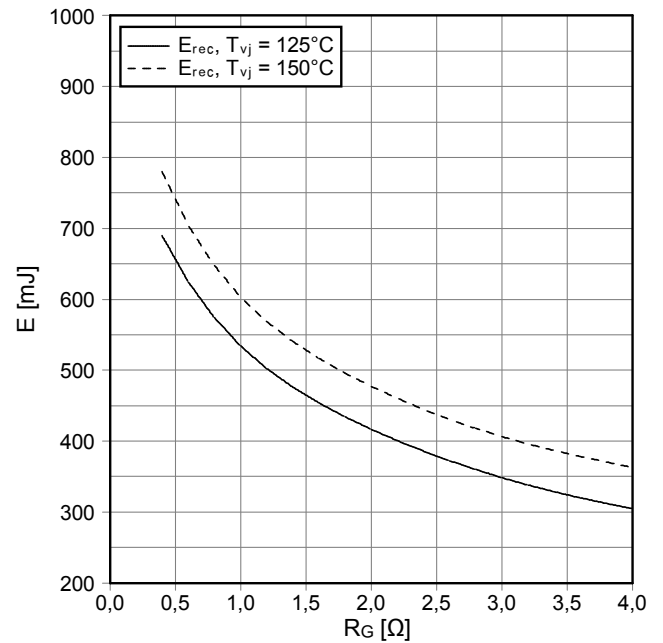

Transienter Wärmewiderstand Diode-Wechselr.  
transient thermal impedance diode-inverter

$Z_{thJC} = f(t)$

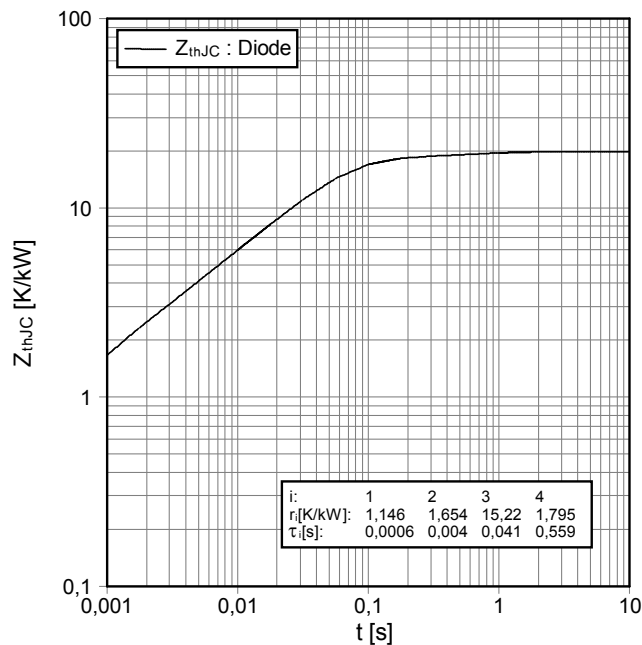

Sicherer Arbeitsbereich Diode-Wechselr. (SOA)  
safe operation area diode-inverter (SOA)

$I_R = f(V_R)$   
 $T_{vj} = 150^\circ C$

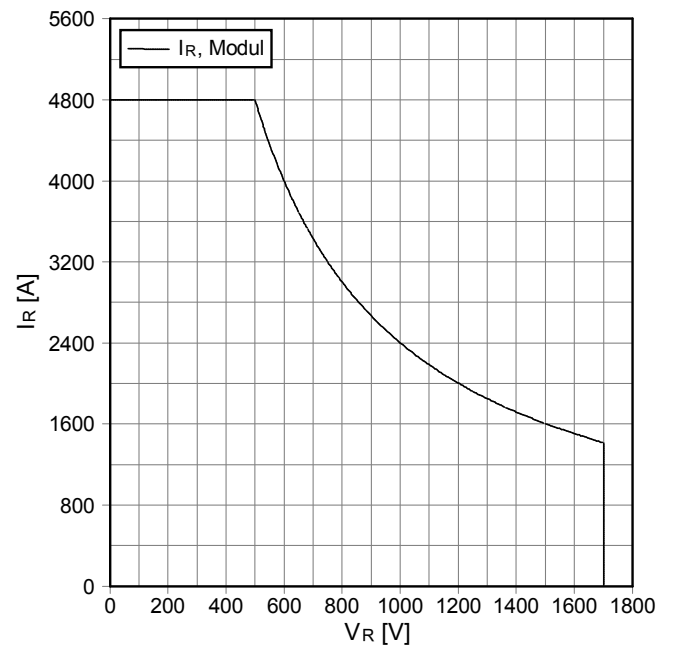

prepared by: WB	date of publication: 2010-01-19
approved by: IL	revision: 2.1

Schaltplan / circuit diagram

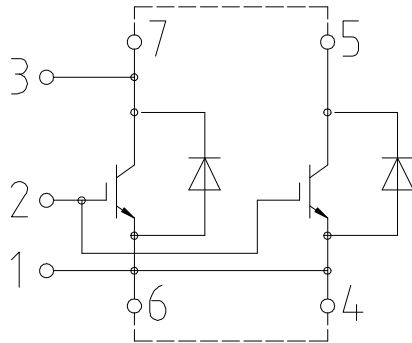

external connection  
(to be done)

Gehäuseabmessungen / package outlines

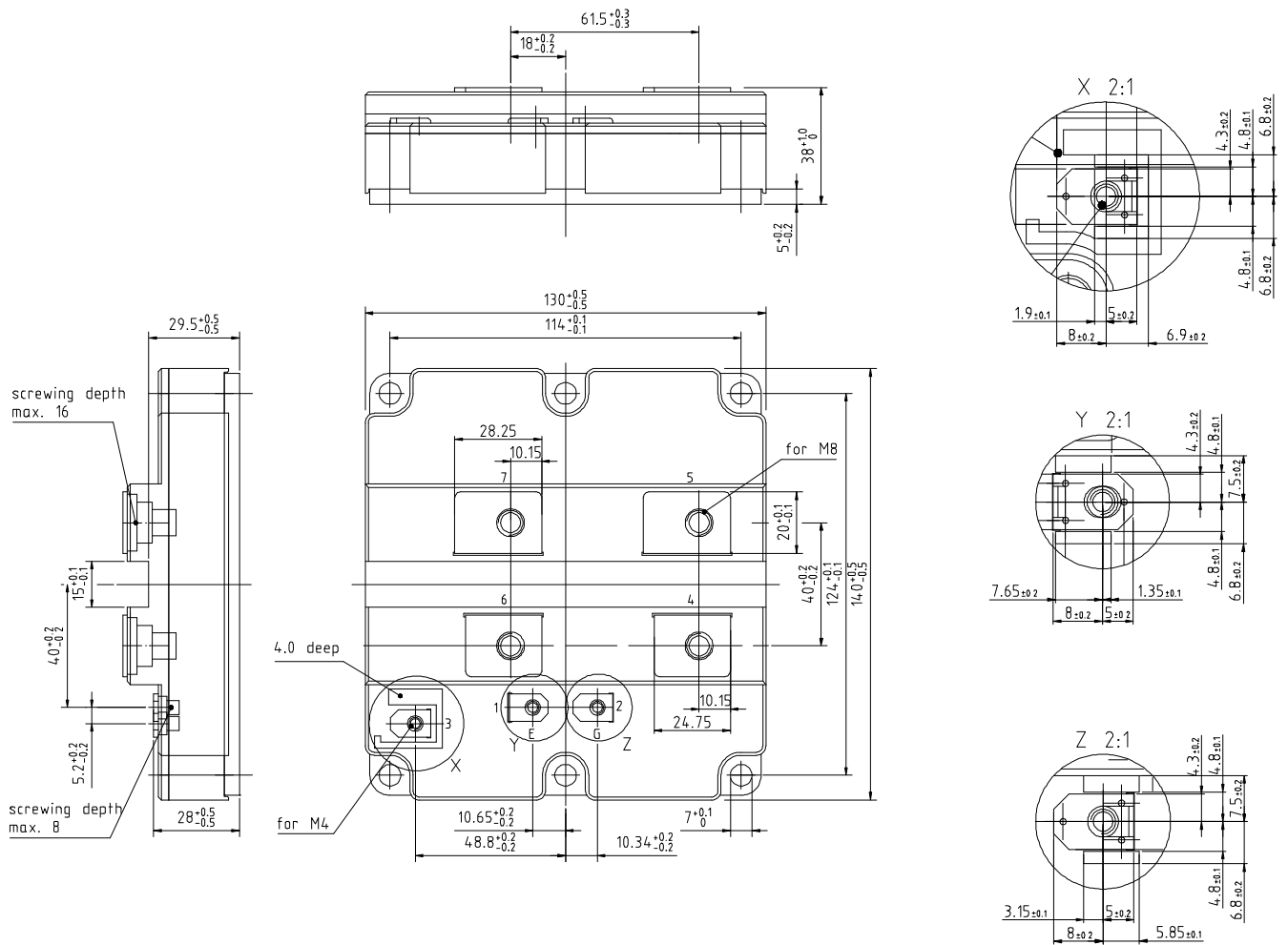

prepared by: WB	date of publication: 2010-01-19
approved by: IL	revision: 2.1





### **Nutzungsbedingungen**

Die in diesem Produktdatenblatt enthaltenen Daten sind ausschließlich für technisch geschultes Fachpersonal bestimmt. Die Beurteilung der Eignung dieses Produktes für Ihre Anwendung sowie die Beurteilung der Vollständigkeit der bereitgestellten Produktdaten für diese Anwendung obliegt Ihnen bzw. Ihren technischen Abteilungen.

In diesem Produktdatenblatt werden diejenigen Merkmale beschrieben, für die wir eine liefervertragliche Gewährleistung übernehmen. Eine solche Gewährleistung richtet sich ausschließlich nach Maßgabe der im jeweiligen Liefervertrag enthaltenen Bestimmungen. Garantien jeglicher Art werden für das Produkt und dessen Eigenschaften keinesfalls übernommen.

Sollten Sie von uns Produktinformationen benötigen, die über den Inhalt dieses Produktdatenblatts hinausgehen und insbesondere eine spezifische Verwendung und den Einsatz dieses Produktes betreffen, setzen Sie sich bitte mit dem für Sie zuständigen Vertriebsbüro in Verbindung (siehe [www.infineon.com](http://www.infineon.com), Vertrieb&Kontakt). Für Interessenten halten wir Application Notes bereit.

Aufgrund der technischen Anforderungen könnte unser Produkt gesundheitsgefährdende Substanzen enthalten. Bei Rückfragen zu den in diesem Produkt jeweils enthaltenen Substanzen setzen Sie sich bitte ebenfalls mit dem für Sie zuständigen Vertriebsbüro in Verbindung.

Sollten Sie beabsichtigen, das Produkt in Anwendungen der Luftfahrt, in gesundheits- oder lebensgefährdenden oder lebenserhaltenden Anwendungsbereichen einzusetzen, bitten wir um Mitteilung. Wir weisen darauf hin, dass wir für diese Fälle

- die gemeinsame Durchführung eines Risiko- und Qualitätsassessments;
- den Abschluss von speziellen Qualitätssicherungsvereinbarungen;
- die gemeinsame Einführung von Maßnahmen zu einer laufenden Produktbeobachtung dringend empfehlen und gegebenenfalls die Belieferung von der Umsetzung solcher Maßnahmen abhängig machen.

Soweit erforderlich, bitten wir Sie, entsprechende Hinweise an Ihre Kunden zu geben.

Inhaltliche Änderungen dieses Produktdatenblatts bleiben vorbehalten.

### **Terms & Conditions of usage**

The data contained in this product data sheet is exclusively intended for technically trained staff. You and your technical departments will have to evaluate the suitability of the product for the intended application and the completeness of the product data with respect to such application.

This product data sheet is describing the characteristics of this product for which a warranty is granted. Any such warranty is granted exclusively pursuant the terms and conditions of the supply agreement. There will be no guarantee of any kind for the product and its characteristics.

Should you require product information in excess of the data given in this product data sheet or which concerns the specific application of our product, please contact the sales office, which is responsible for you (see [www.infineon.com](http://www.infineon.com), sales&contact). For those that are specifically interested we may provide application notes.

Due to technical requirements our product may contain dangerous substances. For information on the types in question please contact the sales office, which is responsible for you.

Should you intend to use the Product in aviation applications, in health or live endangering or life support applications, please notify. Please note, that for any such applications we urgently recommend

- to perform joint Risk and Quality Assessments;
- the conclusion of Quality Agreements;
- to establish joint measures of an ongoing product survey, and that we may make delivery depended on the realization of any such measures.

If and to the extent necessary, please forward equivalent notices to your customers.

Changes of this product data sheet are reserved.

prepared by: WB	date of publication: 2010-01-19
approved by: IL	revision: 2.1



Компания «ЭлектроПласт» предлагает заключение долгосрочных отношений при поставках импортных электронных компонентов на взаимовыгодных условиях!

Наши преимущества:

- Оперативные поставки широкого спектра электронных компонентов отечественного и импортного производства напрямую от производителей и с крупнейших мировых складов;
- Поставка более 17-ти миллионов наименований электронных компонентов;
- Поставка сложных, дефицитных, либо снятых с производства позиций;
- Оперативные сроки поставки под заказ (от 5 рабочих дней);
- Экспресс доставка в любую точку России;
- Техническая поддержка проекта, помощь в подборе аналогов, поставка прототипов;
- Система менеджмента качества сертифицирована по Международному стандарту ISO 9001;
- Лицензия ФСБ на осуществление работ с использованием сведений, составляющих государственную тайну;
- Поставка специализированных компонентов (Xilinx, Altera, Analog Devices, Intersil, Interpoint, Microsemi, Aeroflex, Peregrine, Syfer, Eurofarad, Texas Instrument, Miteq, Cobham, E2V, MA-COM, Hittite, Mini-Circuits, General Dynamics и др.);

Помимо этого, одним из направлений компании «ЭлектроПласт» является направление «Источники питания». Мы предлагаем Вам помощь Конструкторского отдела:

- Подбор оптимального решения, техническое обоснование при выборе компонента;
- Подбор аналогов;
- Консультации по применению компонента;
- Поставка образцов и прототипов;
- Техническая поддержка проекта;
- Защита от снятия компонента с производства.



#### Как с нами связаться

**Телефон:** 8 (812) 309 58 32 (многоканальный)

**Факс:** 8 (812) 320-02-42

**Электронная почта:** [org@eplast1.ru](mailto:org@eplast1.ru)

**Адрес:** 198099, г. Санкт-Петербург, ул. Калинина, дом 2, корпус 4, литера А.