



## Features

- RoHS compliant\*
- Space saving design
- Wide range of resistance values
- PC pin or solder lug terminals
- Metric shaft and bushing option
- Mounting brackets available
- Linear or audio taper versions

## PC - "Slimline" 22 mm Square Single Turn Panel Control

### Electrical Characteristics

|   |                         |
|---|-------------------------|
| Standard Resistance Range   |                         |
| Linear Tapers   | 500 ohms to 1 megohm    |
| Audio Tapers  | 1 K ohms to 500 K ohms  |
| Total Resistance Tolerance  | ±20 %                   |
| Independent Linearity   | ±5 %                    |
| Absolute Minimum Resistance   | .5 ohms maximum         |
| Effective Electrical Angle  | 270° ± 5°               |
| Contact Resistance Variation  | 7 % of total resistance |
| Dielectric Withstanding Voltage (MIL-STD-202, Method 301)                                 |                         |
| Sea Level   | 1,000 VAC minimum       |
| 70,000 Feet   | 500 VAC minimum         |
| Insulation Resistance (500 V)   | 1,000 ohms minimum      |
| Power Rating @ 70 °C (Voltage Limited by Power Dissipation or 350 VAC, Whichever is Less) |                         |
| Linear  | .75 watt                |
| Audio   | .25 watt                |
| Theoretical Resolution  | Essentially infinite    |

### Environmental Characteristics

|  |   |
|--|---|
| Operating Temperature Range                            | +1 °C to +125 °C                          |
| Storage Temperature Range                              | -40 °C to +125 °C                         |
| Temperature Coefficient Over Storage Temperature Range | ±1000 ppm/°C                              |
| Vibration  | 20 G                                      |
| Total Resistance Shift                                 | ±1 % maximum                              |
| Voltage Ratio Shift                                    | ±20 % maximum                             |
| Shock  | 50 G                                      |
| Total Resistance Shift                                 | ±1 % maximum                              |
| Voltage Ratio Shift                                    | ±20 % maximum                             |
| Load Life  | 1,000 Hours @ Rated Power, 20 % RH, 70 °C |
| Total Resistance Shift                                 | ±10 % maximum                             |
| Rotational Life (No Load)                              | 50,000 cycles                             |
| Total Resistance Shift (Linear taper)                  | ±10 ohms or 12 %, whichever is greater    |
| Total Resistance Shift (Audio taper)                   | ±20 % maximum                             |
| Contact Resistance Variation                           | ±5 % maximum                              |
| Moisture Resistance                                    | MIL-STD-202, Method 103, Condition B      |
| Total Resistance Shift                                 | ±20 % maximum                             |
| IP Rating  | IP 40                                     |

### Mechanical Characteristics

|  |  |
|--|--|
| Stop Strength (1/4 " and 6 mm Shaft Diameters) | 79.09 N-cm (7 lb.-in.)   |
| Mechanical Angle                               | 300° ± 5°  |
| Torque   |  |
| Starting (Detented)                            | 0.5-1.5 N-cm (0.75-2.25 oz.-in.)   |
| Starting (Undetented)                          | 1.5 N-cm (2.25 oz.-in.) maximum  |
| Running (Undetented)                           | 0.18 to 1.06 N-cm (0.25 to 1.5 oz.-in.)  |
| Mounting                                       | 79.09 N-cm (7 lb.-in.) maximum   |
| Weight (Single Section)                        | .21 gm (0.75 oz.) maximum  |
| Terminals                                      | PC pin or solder lug   |
| Soldering Condition                            |  |
| Manual Soldering                               | 96.5Sn/3.0Ag/0.5Cu solid wire or no-clean rosin cored wire<br>370 °C (700 °F) max. for 3 seconds               |
| Wave Soldering                                 | 96.5Sn/3.0Ag/0.5Cu solder with no-clean flux<br>260 °C (500 °F) max. for 5 seconds                             |
| Wash processes                                 | Not recommended  |
| Marking  | Manufacturer's trademark, resistance value, part number, and date code   |
| Ganging  | 1 cup maximum  |
| Hardware                                       | One lockwasher and one mounting nut is shipped with each potentiometer, except where noted in the part number. |
| Detents  | Center, 10, 20, 30, none   |

For additional features or specifications not shown, consult factory.

FOR ORDERING INFORMATION SEE PAGE 4.

# PC - "Slimline" 22 mm Square Single Turn Panel Control

**BOURNS®**

## Product Dimensions

### Axial PC Pins

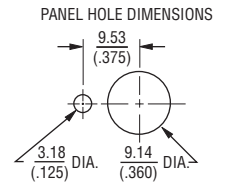
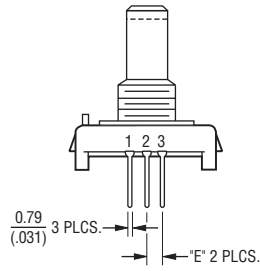

"F" =  $\frac{6.35}{(.250)}$  OR  $\frac{9.53}{(.375)}$       "E" =  $\frac{2.54}{(.100)}$  OR  $\frac{5.08}{(.200)}$

"L" = SEE SHAFT LENGTH TABLE

### Radial PC Pins

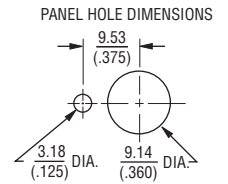

"F" =  $\frac{6.35}{(.250)}$  OR  $\frac{9.53}{(.375)}$       "E" =  $\frac{2.54}{(.100)}$  OR  $\frac{5.08}{(.200)}$

"L" = SEE SHAFT LENGTH TABLE



TOLERANCES EXCEPT WHERE NOTED:

.XX =  $\pm \frac{.25}{(.010)}$   
 .XXX =  $\pm \frac{.13}{(.005)}$

DIMENSIONS ARE:  $\frac{\text{MM}}{(\text{INCHES})}$

# PC - "Slimline" 22 mm Square Single Turn Panel Control

**BOURNS®**

## Product Dimensions

### SOLDER LUGS

(Dimensions not given are the same as Axial PC pins.)



### Axial PC PINS With Rear Mounting Bracket

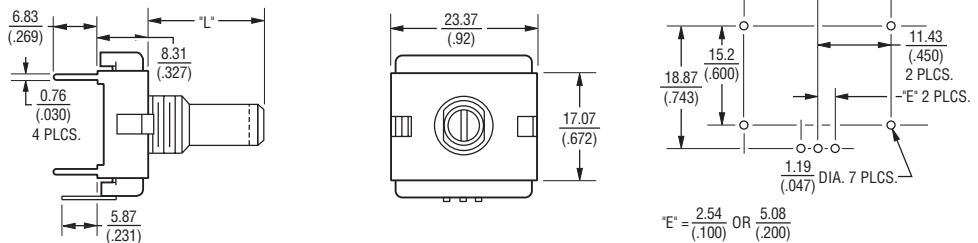

### Radial PC PINS With Side Mounting Bracket

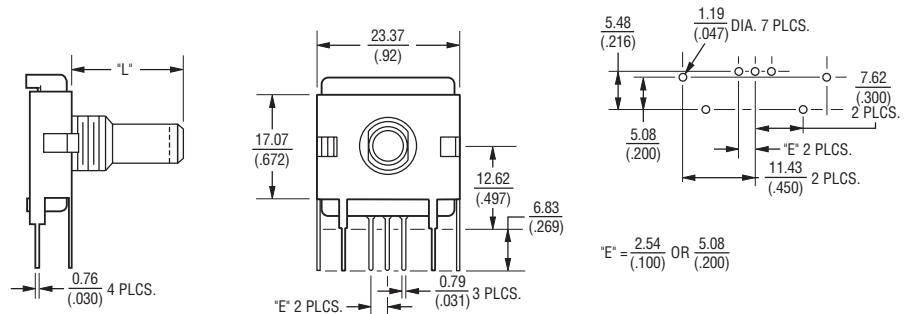

## SHAFT STYLES AND ORIENTATION (Full CCW Rotation)



### Shaft Orientations

#### Shaft Styles C, J



#### Shaft Styles B, R

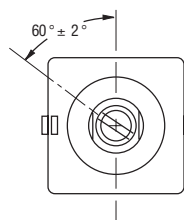

#### Shaft Style Y

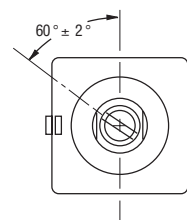

DIMENSIONS: MM (IN.)  
TOLERANCES EXCEPT WHERE NOTED:  
.XX =  $\pm \frac{.25}{(.010)}$   
.XXX =  $\pm \frac{.13}{(.005)}$

# How to Order PC "Slimline" Panel Controls

**BOURNS®**

P C W 1 J - B 2 4 - B A B 1 0 3 L

| RoHS IDENTIFIER |             |
|-----------------|-------------|
| Code            | Description |
| L               | Compliant   |

| SHAFT LENGTH (FMS) |                          |                        |
|--------------------|--------------------------|------------------------|
| Code               | Description              | Available Shaft Styles |
| 16                 | 1/2 " (12.7 mm) Length   | B                      |
| 20                 | 5/8 " (15.9 mm) Length   | J                      |
| 24                 | 3/4 " (19 mm) Length     | B, C, J, Y             |
| 28                 | 7/8 " (22.2 mm) Length   | B, C, J, Y             |
| 32                 | 1 " (25.4 mm) Length     | B, C, J, Y             |
| 36                 | 1-1/8 " (28.6 mm) Length | B, C, J, Y             |
| Metric             |                          |                        |
| 19                 | 19 mm Length             | R                      |
| 22                 | 22 mm Length             | R                      |
| 24                 | 24 mm Length             | R                      |

| RESISTANCE VALUES |        |      |       |      |        |
|-------------------|--------|------|-------|------|--------|
| Code              | TR     | Code | TR    | Code | TR     |
| 501               | 500 Ω  | 103  | 10 KΩ | 104  | 100 KΩ |
| 102               | 1 KΩ   | 203  | 20 KΩ | 254  | 250 KΩ |
| 252               | 2.5 KΩ | 253  | 25 KΩ | 504  | 500 KΩ |
| 502               | 5 KΩ   | 503  | 50 KΩ | 105  | 1 MΩ   |

| ELEMENT TAPER VERSIONS |                    |
|------------------------|--------------------|
| Code                   | Taper Description  |
| B                      | Lin. CP ±20 %      |
| D                      | CW Audio CP ±20 %  |
| G                      | CCW Audio CP ±20 % |

| SHAFT STYLES (See Outline Drawing) |   |
|------------------------------------|---|
| Code                               | Description                                 |
| B                                  | 1/4 " (6.35 mm) Dia. Slotted                |
| C                                  | 1/4 " (6.35 mm) Dia. Flatted                |
| J                                  | 3/16 " (4.76 mm) Dia. Flatted               |
| R                                  | 6 mm Dia. Slotted (Use Metric Lengths Only) |
| Y                                  | 3/16 " (4.76 mm) Dia. Split Shaft           |

| DETENT CONFIGURATIONS |                    |
|-----------------------|--------------------|
| Code                  | Taper Description  |
| A                     | No Detents         |
| B                     | 10 Detents         |
| C                     | Center Detent Only |
| D                     | 20 Detents         |
| E                     | 30 Detents         |
| F                     | CCW Detent Only    |

| ANTI-ROTATION LUG |               |
|-------------------|---------------|
| Code              | Description   |
| J                 | 9:00 Position |
| D                 | None          |

| NO. SECTIONS |             |
|--------------|-------------|
| Code         | Description |
| 1            | Single      |

| HOUSING TERMINAL CONFIGURATION           |      |   |   |   |   |   |   |   |   |   |   |   |   |
|--|------|---|---|---|---|---|---|---|---|---|---|---|---|
| Features                                 | Code |   |   |   |   |   |   |   |   |   |   |   |   |
|  | A    | B | C | D | E | F | G | H | J | K | L | M | N |
| Rear Mounting Bracket                    |      | X |   |   |   |   |   |   | X | X |   |   | X |
| Side Mounting Bracket                    |      |   |   |   | X |   | X |   |   |   | X | X |   |
| Axial Terminals .100" (2.54 mm) Centers  | X    | X |   |   |   |   |   |   |   | X |   |   |   |
| Radial Terminals .100" (2.54 mm) Centers |      |   |   | X | X |   |   |   |   |   | X |   |   |
| Radial Terminals .200" (5.08 mm) Centers |      |   |   |   |   | X | X |   |   |   |   | X |   |
| Solder Lugs .200" (5.08 mm) Centers      |      |   | X |   |   |   |   |   |   |   |   |   |   |
| Axial Terminals .200" (5.08 mm) Centers  |      |   |   |   |   |   |   | X | X |   |   |   | X |
| Hardware Included                        | X    |   | X | X |   | X |   | X |   | X | X | X | X |

| BUSHING CONFIGURATION |  |                        |
|-----------------------|--|------------------------|
| Code                  | Description  | Available Shaft Styles |
| W                     | 9 mm x .250" (6.35 mm) Length Threaded M9 x 0.75 6g 5 PI | All                    |
| L                     | 9 mm x .375" (9.53 mm) Length Threaded M9 x 0.75 6g 5 PI | B, C, R                |

Panel mount hardware not included as standard on bracketed versions. The sample part number demonstrates the identification code for Bourns Slimline Potentiometers. The part number shown is a commonly used model, typically available from stock.

Boldface features are Bourns standard options. All others are available with higher minimum order quantities.



**Asia-Pacific:**  
Tel: +886-2 2562-4117 • Fax: +886-2 2562-4116  
**Europe:**  
Tel: +41-41 768 5555 • Fax: +41-41 768 5510  
**The Americas:**  
Tel: +1-951 781-5500 • Fax: +1-951 781-5700  
[www.bourns.com](http://www.bourns.com)

REV. 08/09

Specifications are subject to change without notice. Customers should verify actual device performance in their specific applications.



Компания «ЭлектроПласт» предлагает заключение долгосрочных отношений при поставках импортных электронных компонентов на взаимовыгодных условиях!

Наши преимущества:

- Оперативные поставки широкого спектра электронных компонентов отечественного и импортного производства напрямую от производителей и с крупнейших мировых складов;
- Поставка более 17-ти миллионов наименований электронных компонентов;
- Поставка сложных, дефицитных, либо снятых с производства позиций;
- Оперативные сроки поставки под заказ (от 5 рабочих дней);
- Экспресс доставка в любую точку России;
- Техническая поддержка проекта, помощь в подборе аналогов, поставка прототипов;
- Система менеджмента качества сертифицирована по Международному стандарту ISO 9001;
- Лицензия ФСБ на осуществление работ с использованием сведений, составляющих государственную тайну;
- Поставка специализированных компонентов (Xilinx, Altera, Analog Devices, Intersil, Interpoint, Microsemi, Aeroflex, Peregrine, Syfer, Eurofarad, Texas Instrument, Miteq, Cobham, E2V, MA-COM, Hittite, Mini-Circuits, General Dynamics и др.);

Помимо этого, одним из направлений компании «ЭлектроПласт» является направление «Источники питания». Мы предлагаем Вам помощь Конструкторского отдела:

- Подбор оптимального решения, техническое обоснование при выборе компонента;
- Подбор аналогов;
- Консультации по применению компонента;
- Поставка образцов и прототипов;
- Техническая поддержка проекта;
- Защита от снятия компонента с производства.



#### Как с нами связаться

**Телефон:** 8 (812) 309 58 32 (многоканальный)

**Факс:** 8 (812) 320-02-42

**Электронная почта:** [org@eplast1.ru](mailto:org@eplast1.ru)

**Адрес:** 198099, г. Санкт-Петербург, ул. Калинина, дом 2, корпус 4, литера А.