

FEATURES

- Internal Hold Capacitors
- Low Droop Rate
- TTL/CMOS Compatible Logic Inputs
- Single or Dual Supply Operation
- Break-Before-Make Channel Addressing
- Compatible With CD4051 Pinout
- Low Cost

APPLICATIONS

- Multiple Path Timing Deskew for ATE
- Memory Programmers
- Mass Flow/Process Control Systems
- Multichannel Data Acquisition Systems
- Robotics and Control Systems
- Medical and Analytical Instrumentation
- Event Analysis
- Stage Lighting Control

GENERAL DESCRIPTION

The SMP08 is a monolithic octal sample-and-hold; it has eight internal buffer amplifiers, input multiplexer, and internal hold capacitors. It is manufactured in an advanced oxide isolated CMOS technology to obtain high accuracy, low droop rate, and fast acquisition time. The SMP08 has a typical linearity error of only 0.01% and can accurately acquire a 10-bit input signal to $\pm 1/2$ LSB in less than 7 microseconds. The SMP08's output swing includes the negative supply in both single and dual supply operation.

The SMP08 was specifically designed for systems that use a calibration cycle to adjust a multiple of system parameters. The low cost and high level of integration make the SMP08 ideal for calibration requirements that have previously required an ASIC, or high cost multiple D/A converters.

FUNCTIONAL BLOCK DIAGRAM

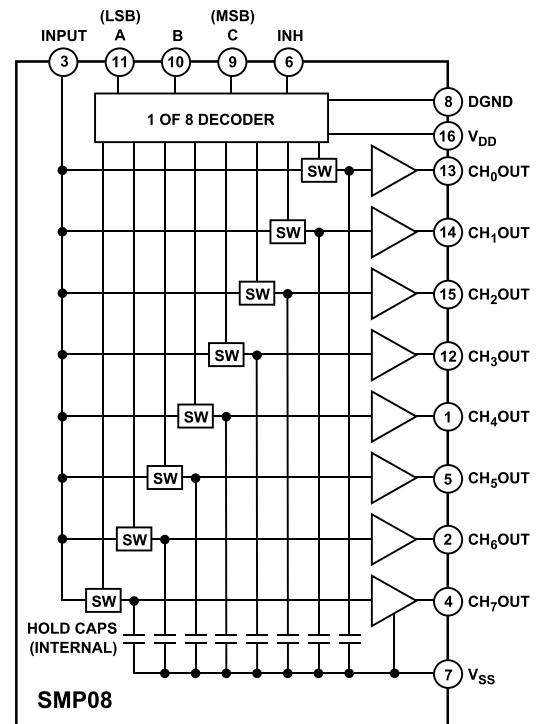

The SMP08 is also ideally suited for a wide variety of sample-and-hold applications including amplifier offset or VCA gain adjustments. One or more SMP08s can be used with single or multiple DACs to provide multiple set points within a system.

The SMP08 offers significant cost and size reduction over discrete designs. It is available in a 16-pin plastic DIP, or surface-mount SOIC package.

REV. D

Information furnished by Analog Devices is believed to be accurate and reliable. However, no responsibility is assumed by Analog Devices for its use, nor for any infringements of patents or other rights of third parties which may result from its use. No license is granted by implication or otherwise under any patent or patent rights of Analog Devices.

SMP08—SPECIFICATIONS

ELECTRICAL CHARACTERISTICS (@ $V_{DD} = +5\text{ V}$, $V_{SS} = -5\text{ V}$, $DGND = 0\text{ V}$, $R_L = \text{No Load}$, $T_A = -40^\circ\text{C}$ to $+85^\circ\text{C}$ for SMP08F, unless otherwise noted)

| Parameter | Symbol | Conditions | Min | Typ | Max | Units |
|--|--------------------------|---|------|------|------|------------------|
| Linearity Error | | $-3\text{ V} \leq V_{IN} \leq +3\text{ V}$ | | 0.01 | | % |
| Buffer Offset Voltage | V_{OS} | $T_A = +25^\circ\text{C}$, $V_{IN} = 0\text{ V}$ | | 2.5 | 10 | mV |
| Hold Step | V_{HS} | $-40^\circ\text{C} \leq T_A \leq +85^\circ\text{C}$, $V_{IN} = 0\text{ V}$ | | 3.5 | 20 | mV |
| | | $V_{IN} = 0\text{ V}$, $T_A = +25^\circ\text{C}$ to $+85^\circ\text{C}$ | | 2.5 | 4 | mV |
| Droop Rate | $\Delta V_{CH}/\Delta t$ | $V_{IN} = 0\text{ V}$, $T_A = -40^\circ\text{C}$ | | | 5 | mV |
| | | $T_A = +25^\circ\text{C}$, $V_{IN} = 0\text{ V}$ | | 2 | 20 | mV/s |
| Output Source Current | I_{SOURCE} | $V_{IN} = 0\text{ V}^1$ | 1.2 | | | mA |
| Output Sink Current | I_{SINK} | $V_{IN} = 0\text{ V}^1$ | 0.5 | | | mA |
| Output Voltage Range | | $R_L = 20\text{ k}\Omega$ | -3.0 | | +3.0 | V |
| LOGIC CHARACTERISTICS | | | | | | |
| Logic Input High Voltage | V_{INH} | | 2.4 | | | V |
| Logic Input Low Voltage | V_{INL} | | | | 0.8 | V |
| Logic Input Current | I_{IN} | $V_{IN} = 2.4\text{ V}$ | | 0.5 | 1 | μA |
| DYNAMIC PERFORMANCE² | | | | | | |
| Acquisition Time ³ | t_{AQ} | $T_A = +25^\circ\text{C}$, -3 V to $+3\text{ V}$ to 0.1% | | 3.6 | 7 | μs |
| Hold Mode Settling Time | t_H | To $\pm 1\text{ mV}$ of Final Value | | 1 | | μs |
| Channel Select Time | t_{CH} | | | 90 | | ns |
| Channel Deselect Time | t_{DCS} | | | 45 | | ns |
| Inhibit Recovery Time | t_{IR} | | | 90 | | ns |
| Slew Rate | SR | | | 3 | | V/ μs |
| Capacitive Load Stability | | <30% Overshoot | | 500 | | pF |
| Analog Crosstalk | | -3 V to $+3\text{ V}$ Step | | -72 | | dB |
| SUPPLY CHARACTERISTICS | | | | | | |
| Power Supply Rejection Ratio | PSRR | $V_S = \pm 5\text{ V}$ to $\pm 6\text{ V}$ | 60 | 75 | | dB |
| Supply Current | I_{DD} | $T_A = +25^\circ\text{C}$ | | 4 | 7.5 | mA |
| | | $-40^\circ\text{C} \leq T_A \leq +85^\circ\text{C}$ | | 5 | 9.5 | mA |

ELECTRICAL CHARACTERISTICS (@ $V_{DD} = +12\text{ V}$, $V_{SS} = 0\text{ V}$, $DGND = 0\text{ V}$, $R_L = \text{No Load}$, $T_A = -40^\circ\text{C}$ to $+85^\circ\text{C}$ for SMP08F, unless otherwise noted)

| Parameter | Symbol | Conditions | Min | Typ | Max | Units |
|--|--------------------------|---|------|------|------|------------------|
| Linearity Error | | $60\text{ mV} \leq V_{IN} \leq 10\text{ V}$ | | 0.01 | | % |
| Buffer Offset Voltage | V_{OS} | $T_A = +25^\circ\text{C}$, $V_{IN} = 6\text{ V}$ | | 2.5 | 10 | mV |
| Hold Step | V_{HS} | $-40^\circ\text{C} \leq T_A \leq +85^\circ\text{C}$, $V_{IN} = 6\text{ V}$ | | 3.5 | 20 | mV |
| | | $V_{IN} = 6\text{ V}$, $T_A = +25^\circ\text{C}$ to $+85^\circ\text{C}$ | | 2.5 | 4 | mV |
| Droop Rate | $\Delta V_{CH}/\Delta t$ | $V_{IN} = 6\text{ V}$, $T_A = -40^\circ\text{C}$ | | | 5 | mV |
| | | $T_A = +25^\circ\text{C}$, $V_{IN} = 6\text{ V}$ | | 2 | 20 | mV/s |
| Output Source Current | I_{SOURCE} | $V_{IN} = 6\text{ V}^1$ | 1.2 | | | mA |
| Output Sink Current | I_{SINK} | $V_{IN} = 6\text{ V}^1$ | 0.5 | | | mA |
| Output Voltage Range | | $R_L = 20\text{ k}\Omega$ | 0.06 | | 10.0 | V |
| | | $R_L = 10\text{ k}\Omega$ | 0.06 | | 9.5 | V |
| LOGIC CHARACTERISTICS | | | | | | |
| Logic Input High Voltage | V_{INH} | | 2.4 | | | V |
| Logic Input Low Voltage | V_{INL} | | | | 0.8 | V |
| Logic Input Current | I_{IN} | $V_{IN} = 2.4\text{ V}$ | | 0.5 | 1 | μA |
| DYNAMIC PERFORMANCE² | | | | | | |
| Acquisition Time ³ | t_{AQ} | $T_A = +25^\circ\text{C}$, 0 V to 10 V to 0.1% | | 3.5 | 4.25 | μs |
| Hold Mode Settling Time | t_H | $-40^\circ\text{C} \leq T_A \leq +85^\circ\text{C}$ | | 3.75 | 6.00 | μs |
| | | To $\pm 1\text{ mV}$ of Final Value | | 1 | | μs |
| Channel Select Time | t_{CH} | | | 90 | | ns |
| Channel Deselect Time | t_{DCS} | | | 45 | | ns |
| Inhibit Recovery Time | t_{IR} | | | 90 | | ns |
| Slew Rate | SR | | | 4 | | V/ μs |
| Capacitive Load Stability | | <30% Overshoot | | 500 | | pF |
| Analog Crosstalk | | 0 V to 10 V Step | | -72 | | dB |
| SUPPLY CHARACTERISTICS | | | | | | |
| Power Supply Rejection Ratio | PSRR | $10.8\text{ V} \leq V_{DD} \leq 13.2\text{ V}$ | 60 | 75 | | dB |
| Supply Current | I_{DD} | $T_A = +25^\circ\text{C}$ | | 6.0 | 8.0 | mA |
| | | $-40^\circ\text{C} \leq T_A \leq +85^\circ\text{C}$ | | 8.0 | 10.0 | mA |

NOTES

¹Outputs are capable of sinking and sourcing over 20 mA but offset is guaranteed at specified load levels.

²All input control signals are specified with $t_r = t_f = 5\text{ ns}$ (10% to 90% of +5 V) and timed from a voltage level of 1.6 V.

³This parameter is guaranteed without test.

⁴Slew rate is measured in the sample mode with 0 V to 10 V step from 20% to 80%.

Specifications subject to change without notice.

ABSOLUTE MAXIMUM RATINGS

| | | |
|-----------------------|-------|---------------------|
| V_{DD} to DGND | | -0.3 V, 17 V |
| V_{DD} to V_{SS} | | -0.3 V, 17 V |
| V_{LOGIC} to DGND | | -0.3 V, V_{DD} |
| V_{IN} to DGND | | V_{SS} , V_{DD} |
| V_{OUT} to DGND | | V_{SS} , V_{DD} |
| Analog Output Current | | ± 20 mA |

(Not Short-Circuit Protected)

Operating Temperature Range

| | | |
|--------------------------------------|-------|-----------------|
| FP, FS | | -40°C to +85°C |
| Junction Temperature | | +150°C |
| Storage Temperature | | -65°C to +150°C |
| Lead Temperature (Soldering, 60 sec) | | +300°C |

| Package Type | θ_{JA}^* | θ_{JC} | Units |
|------------------------|-----------------|---------------|-------|
| 16-Pin Plastic DIP (P) | 76 | 33 | °C/W |
| 16-Pin SOIC (S) | 92 | 27 | °C/W |

* θ_{JA} is specified for worst case mounting conditions, i.e., θ_{JA} is specified for device in socket for plastic DIP package; θ_{JA} is specified for device soldered to printed circuit board for SO package.

ORDERING GUIDE

| Model | Temperature Range | Package Description | Package Option |
|---------|-------------------|---------------------|----------------|
| SMP08FP | -40°C to +85°C | Plastic DIP | N-16 |
| SMP08FS | -40°C to +85°C | SO-16 | R-16A |

PIN CONNECTIONS

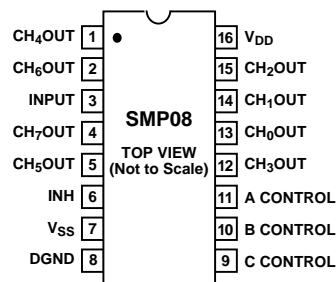

CAUTION

ESD (electrostatic discharge) sensitive device. Electrostatic charges as high as 4000 V readily accumulate on the human body and test equipment and can discharge without detection. Although the SMP08 features proprietary ESD protection circuitry, permanent damage may occur on devices subjected to high energy electrostatic discharges. Therefore, proper ESD precautions are recommended to avoid performance degradation or loss of functionality.



SMP08—Typical Performance Characteristics

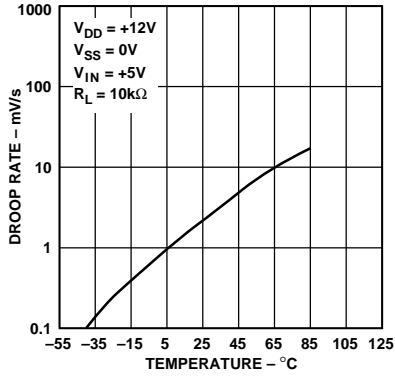

Figure 1. Droop Rate vs. Temperature

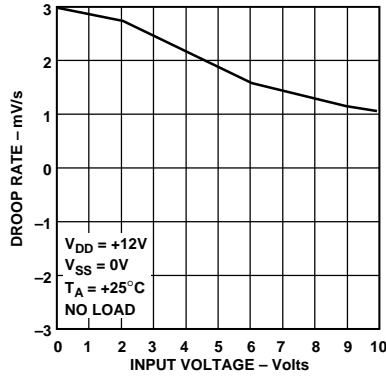

Figure 2. Droop Rate vs. Input Voltage

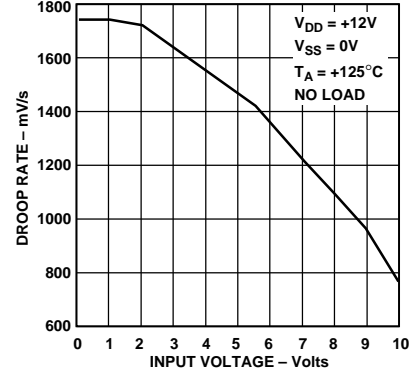

Figure 3. Droop Rate vs. Input Voltage

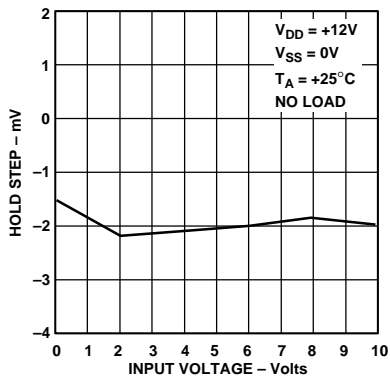

Figure 4. Hold Step vs. Input Voltage

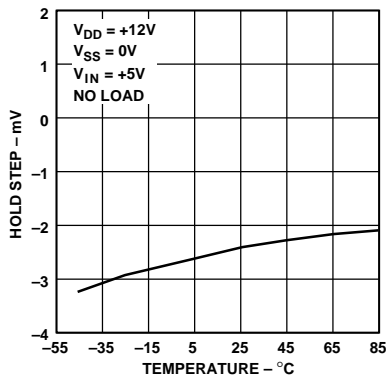

Figure 5. Hold Step vs. Temperature

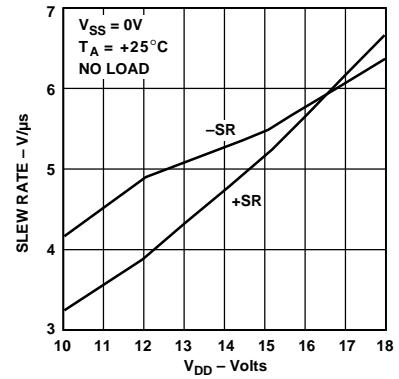

Figure 6. Slew Rate vs. V_{DD}

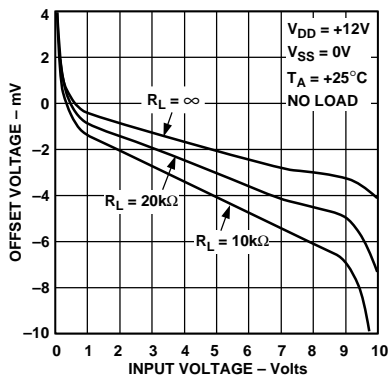

Figure 7. Offset Voltage vs. Input Voltage

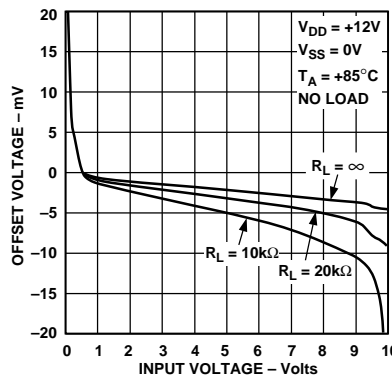

Figure 8. Offset Voltage vs. Input Voltage

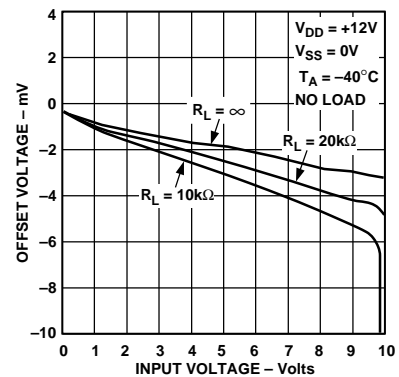

Figure 9. Offset Voltage vs. Input Voltage

Typical Performance Characteristics—SMP08

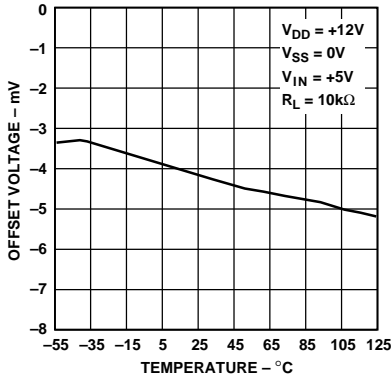

Figure 10. Offset Voltage vs. Temperature

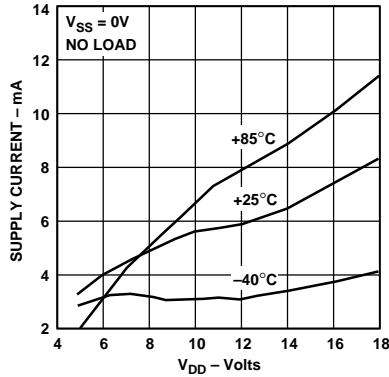

Figure 11. Supply Current vs. V_{DD}

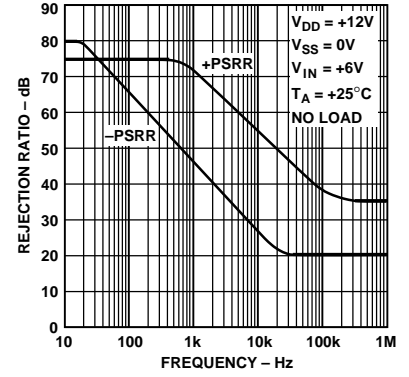

Figure 12. Sample Mode Power Supply Rejection

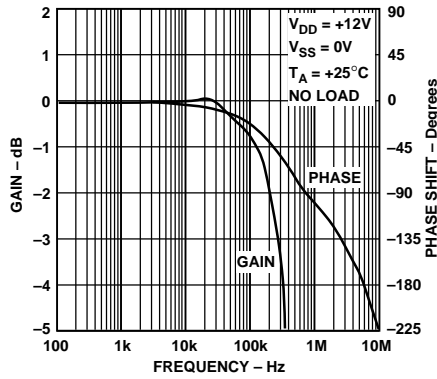

Figure 13. Gain, Phase Shift vs. Frequency

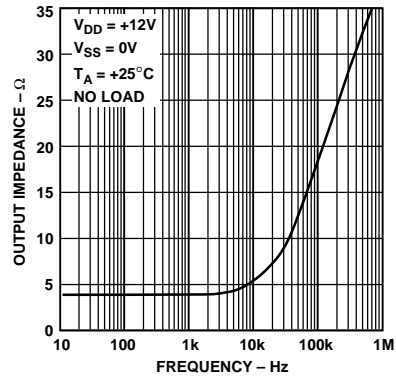

Figure 14. Output Impedance vs. Frequency

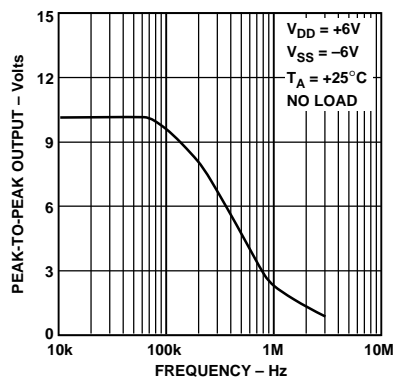

Figure 15. Maximum Output Voltage vs. Frequency

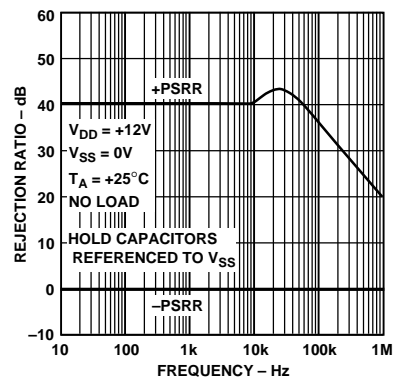

Figure 16. Hold Mode Power Supply Rejection

SMP08

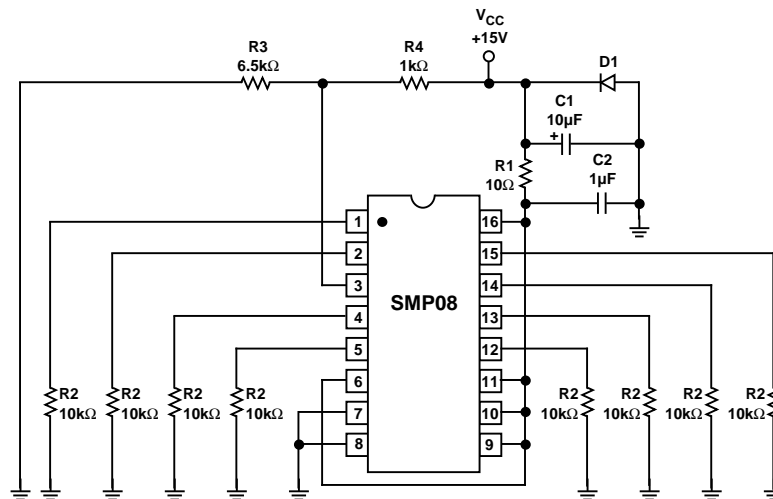

Figure 17. Burn-In Circuit

APPLICATIONS INFORMATION

The SMP08, a multiplexed octal S/H, minimizes board space in systems requiring cycled calibration or an array of control voltages. When used in conjunction with a low cost 16-bit D/A, the SMP08 can easily be integrated into microprocessor based systems. Since the SMP08 features break-before-make switching and an internal decoder, no external logic is required. The SMP08 has an internally regulated TTL supply so that TTL/CMOS compatibility is maintained over the full supply range. See Figure 18 for channel decode address information.

POWER SUPPLIES

The SMP08 is capable of operating with either single or dual supplies, over a voltage range of 7 volts to 15 volts. Based on the supply voltages chosen, V_{DD} and V_{SS} establish the input and output voltage range, which is:

$$(V_{SS} + 0.06 V) \leq V_{OUT/IN} \leq (V_{DD} - 2 V)$$

Note that several specifications, including acquisition time, offset and output voltage compliance, will degrade for supply voltages of less than 7 V.

If split supplies are used, the negative supply should be bypassed with a 0.1 μ F capacitor in parallel with a 10 μ F to ground. The internal hold capacitors are connected to this supply pin and any noise will appear at the outputs.

In single supply applications, it is extremely important that the V_{SS} (negative supply) pin is connected to a clean ground. The hold capacitors are internally tied to the V_{SS} (negative) rail. Any ground noise or disturbance will directly couple to the output of the sample-and-hold, degrading the signal-to-noise performance. The analog and digital ground traces on the circuit board should be physically separated to reduce digital switching noise from entering the analog circuitry.

POWER SUPPLY SEQUENCING

V_{DD} should be applied to the SMP08 before the logic input signals. The SMP08 has been designed to be immune to latchup, but standard precautions should still be taken.

OUTPUT BUFFERS (Pins 1, 2, 4, 5, 12, 13, 14, 15)

The buffer offset specification is 10 mV; this is less than 1/2 LSB of an 8-bit DAC with 10 V full scale. The hold step (magnitude of step caused in the output voltage when switching from sample-to-hold mode, also referred to as the pedestal error or sample-to-hold offset), is about 2.5 mV with little variation over the full output voltage range, $T_A = +25^\circ\text{C}$ to $+85^\circ\text{C}$. The droop rate of a held channel is 2 mV/s typical and 20 mV/s maximum.

The buffers are designed to drive loads connected to ground. The outputs can source more than 20 mA, over the full voltage range, but have limited current sinking capability near V_{SS} . In split supply operation, symmetrical output swings can be obtained by restricting the output range to 2 V from either supply.

On-chip SMP08 buffers eliminate potential stability problems associated with external buffers; outputs are stable with capacitive loads up to 500 pF. However, since the SMP08's buffer outputs are not short-circuit protected, care should be taken to avoid shorting any output to the supplies or ground.

SIGNAL INPUT (Pin 3)

The signal input should be driven from a low impedance voltage source such as the output of an op amp. The op amp should have a high slew rate and fast settling time if the SMP08's acquisition time characteristics are to be maintained. As with all CMOS devices, all input voltages should be kept within range of the supply rails ($V_{SS} \leq V_{IN} < V_{DD}$) to avoid the possibility of latchup. If single supply operation is desired, op amps such as the OP183 or AD820 that have input and output voltage compliances including ground, can be used to drive the inputs. Split supplies, such as ± 7.5 V, can be used with the SMP08.

APPLICATION TIPS

All unused digital inputs should be connected to logic LOW and unused analog inputs connected to analog ground. For connector-driven analog inputs that may become temporarily disconnected, a resistor to V_{DD} , V_{SS} or analog ground should be used with a value ranging from 200 k Ω to 1 M Ω .

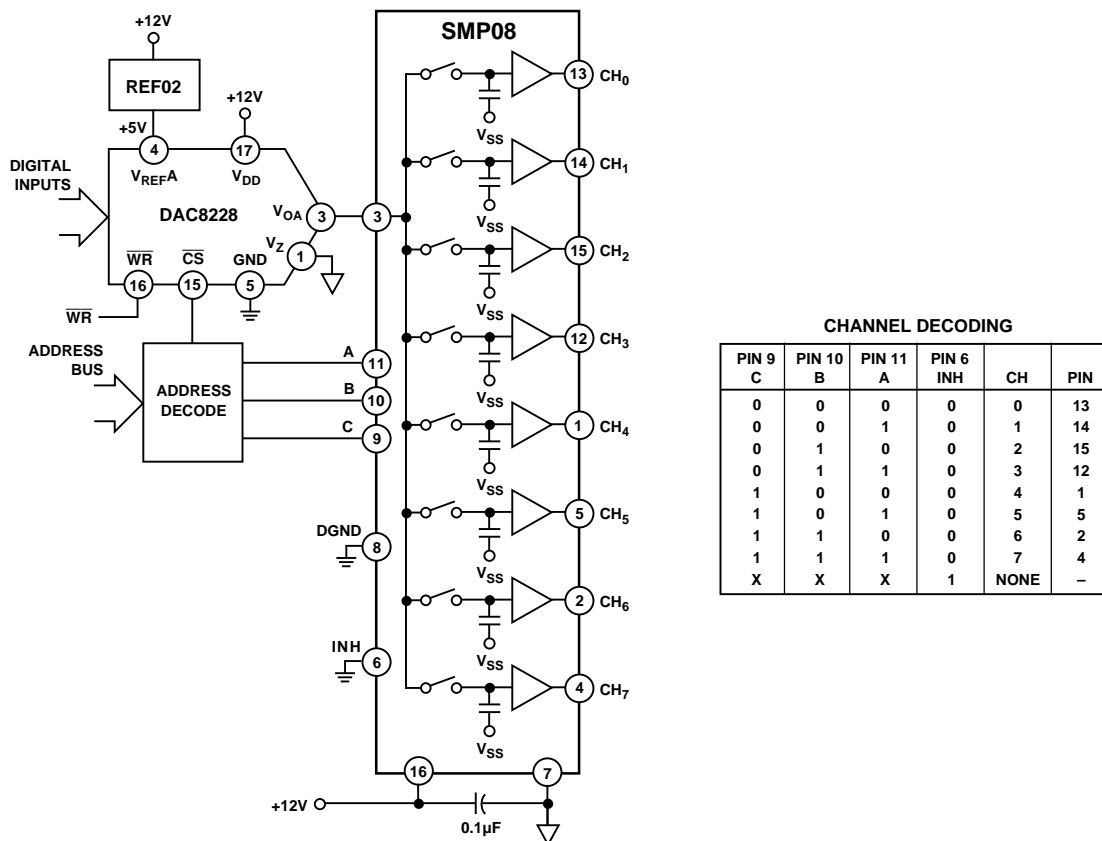

Figure 18. 8-Channel Multiplexed D/A Converter

Do not apply signals to the SMP08 with power off unless the input current is limited to less than 10 mA.

TYPICAL APPLICATIONS

AN 8-CHANNEL MULTIPLEXED D/A CONVERTER

Figure 18 illustrates a typical demultiplexing function of the SMP08. It is used to sample-and-hold eight different output voltages corresponding to eight different digital codes from a D/A converter. The SMP08's droop rate of 20 mV/s requires a refresh once every 500 ms, before the voltage drifts beyond

1/2 LSB accuracy (1 LSB of an 8-bit DAC is equivalent to 19.5 mV out of a full-scale voltage of 5 V). For a 10-bit DAC the refresh rate must be less than 120 ms, and, for a 12-bit system, 31 ms. This implementation is very cost effective compared to using multiple DACs as the number of output channels increases.

OUTLINE DIMENSIONS

Dimensions shown in inches and (mm).

**16-Lead Plastic DIP
(N-16)**

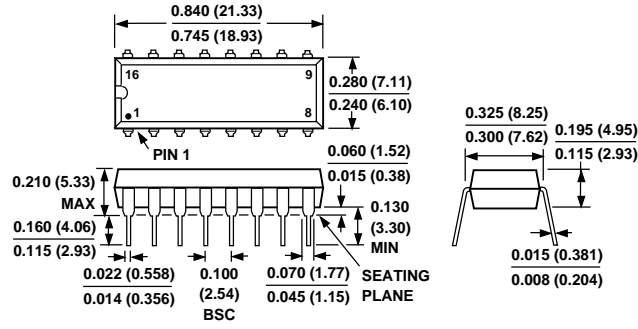

**16-Lead SOIC (Narrow Body)
(SO-16)**

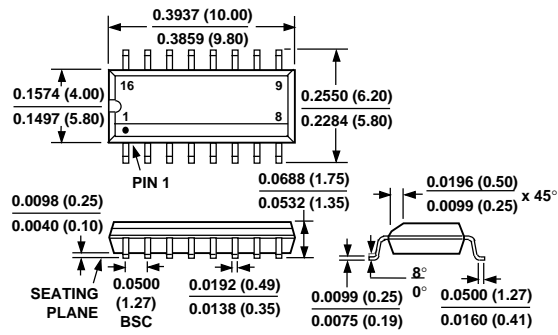



Компания «ЭлектроПласт» предлагает заключение долгосрочных отношений при поставках импортных электронных компонентов на взаимовыгодных условиях!

Наши преимущества:

- Оперативные поставки широкого спектра электронных компонентов отечественного и импортного производства напрямую от производителей и с крупнейших мировых складов;
- Поставка более 17-ти миллионов наименований электронных компонентов;
- Поставка сложных, дефицитных, либо снятых с производства позиций;
- Оперативные сроки поставки под заказ (от 5 рабочих дней);
- Экспресс доставка в любую точку России;
- Техническая поддержка проекта, помощь в подборе аналогов, поставка прототипов;
- Система менеджмента качества сертифицирована по Международному стандарту ISO 9001;
- Лицензия ФСБ на осуществление работ с использованием сведений, составляющих государственную тайну;
- Поставка специализированных компонентов (Xilinx, Altera, Analog Devices, Intersil, Interpoint, Microsemi, Aeroflex, Peregrine, Syfer, Eurofarad, Texas Instrument, Miteq, Cobham, E2V, MA-COM, Hittite, Mini-Circuits, General Dynamics и др.);

Помимо этого, одним из направлений компании «ЭлектроПласт» является направление «Источники питания». Мы предлагаем Вам помощь Конструкторского отдела:

- Подбор оптимального решения, техническое обоснование при выборе компонента;
- Подбор аналогов;
- Консультации по применению компонента;
- Поставка образцов и прототипов;
- Техническая поддержка проекта;
- Защита от снятия компонента с производства.



Как с нами связаться

Телефон: 8 (812) 309 58 32 (многоканальный)

Факс: 8 (812) 320-02-42

Электронная почта: org@eplast1.ru

Адрес: 198099, г. Санкт-Петербург, ул. Калинина, дом 2, корпус 4, литера А.