

Overview

The KEMET GT metal box filters cover single-phase requirements with a wide variety of characteristics. These filters are optimized for both common and normal mode noise. Their input/output terminals are screw type or Faston type.

Applications

- Industrial equipment
- Electronic equipment
- Vending machines

Benefits

- Single-phase
- Operating temperature range from -25°C to +55°C
- UL, CSA, or TÜV approved versions available
- RoHS compliant



Part Number System

GT-	2	20	01V
Series	Phase	Rated Current (A)	Specification
GT	2 = Single-phase	0x = 0x A xx = xx A	0 = Standard, no approvals 01 = High performance at low frequency 02 = High performance at low frequency 01V = High performance at low frequency J = Faston terminal with DC input support R = High performance to pulse noise U = UL, CSA, and/or TÜV approved

Dimensions – Millimeters cont.

GT-205J



Faston® is a registered trademark of Tyco Electronics AMP.

GT-210J, GT-215J

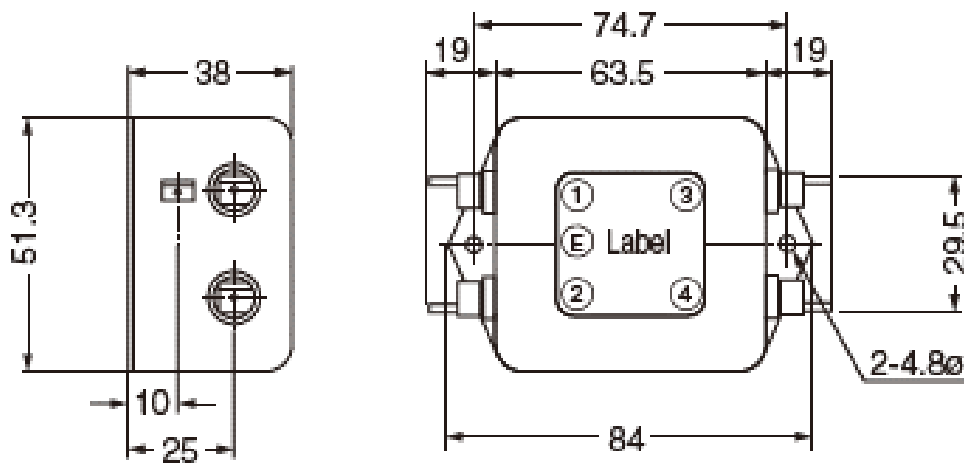

Dimensions – Millimeters cont.

GT-20301, GT-21001, GT-20302

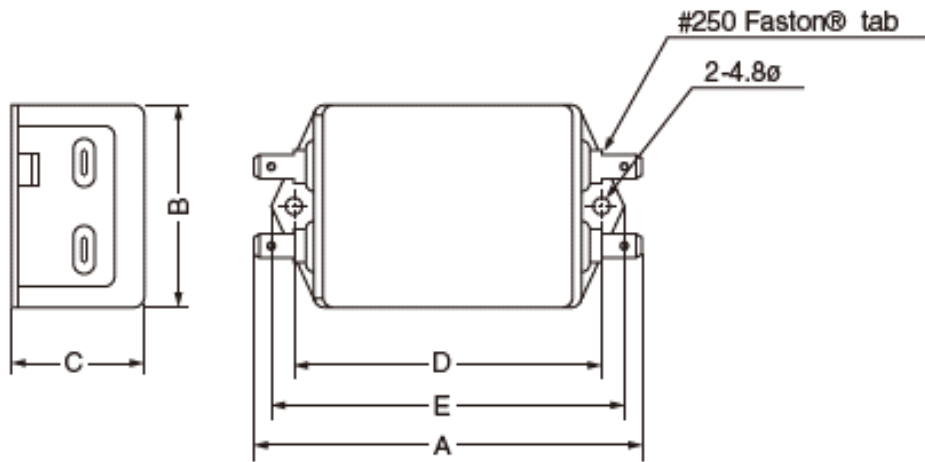

Faston® is a registered trademark of Tyco Electronics AMP.

Part Number	A	B	C	D	E
GT-20301	93.0	53.0	30.0	74.7	85.0
GT-21001	105.5	57.5	44.5	87.0	96.5
GT-20302	93.0	53.0	46.0	74.7	84.3

GT-20501V, GT-21001V, GT-22001V

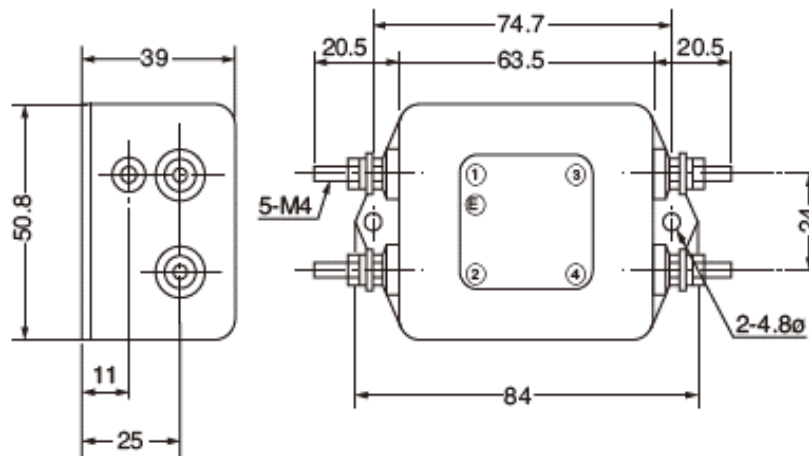

Recommended torque (N-m) maximum

- Line terminal (M4: 0.78)
- Earth terminal (M4: 1.18)

Environmental Compliance

All KEMET EMI-RFI Filters are RoHS compliant.



Performance Characteristics

Item	Performance Characteristics
Rated Voltage	250 V
Rated Current Range	3 – 20 A
Withstanding Voltage	1,500 VAC (1 minute, line to ground)
Insulation Resistance	300 MΩ minimum at 500 VDC (1 minute, line to ground)
Leakage Current Range	0.5 – 1.0 mA at 250 V/60 Hz maximum
Input/Output Terminal Type	Screw and Faston
Operating Temperature Range	-25°C to +55°C (not including self temperature rise)

Table 1 – Ratings & Part Number Reference

Part Number	Phase	Rated Voltage AC/DC (V)	Rated Current AC/DC (A)	Leakage Current at 250 V/60 Hz (mA) Maximum	Temperature Rise (K) Maximum	Operating Temperature Range	Terminal Type	Approval	Weight (g)
GT-205U	Single-phase	250	5	0.5	35	-25°C to +55°C	Screw	UL, CSA, and TÜV	170
GT-2050R	Single-phase	250	5	0.5	35	-25°C to +55°C	Screw		160
GT-2150R	Single-phase	250	15	0.5	35	-25°C to +55°C	Screw		280
GT-2100	Single-phase	250	10	0.5	35	-25°C to +55°C	Screw		260
GT-2150	Single-phase	250	15	0.5	35	-25°C to +55°C	Screw		270
GT-2200	Single-phase	250	20	0.5	35	-25°C to +55°C	Screw		270
GT-210U	Single-phase	250	10	0.5	35	-25°C to +55°C	Screw	UL, CSA, and TÜV	260
GT-215U	Single-phase	250	15	0.5	35	-25°C to +55°C	Screw	UL	270
GT-220U	Single-phase	250	20	0.5	35	-25°C to +55°C	Screw	UL and TÜV	270
GT-205J	Single-phase	250	5	0.5	35	-25°C to +55°C	Faston	UL, CSA, and TÜV	135
GT-210J	Single-phase	250	10	0.5	35	-25°C to +55°C	Faston	UL, CSA, and TÜV	240
GT-215J	Single-phase	250	15	0.5	35	-25°C to +55°C	Faston	UL, CSA, and TÜV	255
GT-20301	Single-phase	250	3	1.0	30	-25°C to +55°C	Faston	UL, CSA, and TÜV	160
GT-21001	Single-phase	250	10	1.0	30	-25°C to +55°C	Faston	UL, CSA, and TÜV	300
GT-20302	Single-phase	250	3	1.0	30	-25°C to +55°C	Faston	UL, CSA, and TÜV	215
GT-20501V	Single-phase	250	5	0.5	35	-25°C to +55°C	Screw		220
GT-21001V	Single-phase	250	10	0.5	35	-25°C to +55°C	Screw	UL, CSA, and TÜV	280
GT-22001V	Single-phase	250	20	0.5	35	-25°C to +55°C	Screw	UL and TÜV	285

Circuit Diagram

GT-2**0, GT-2**0R

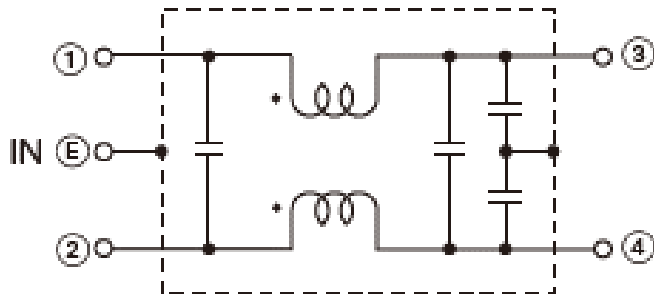

GT-2**U

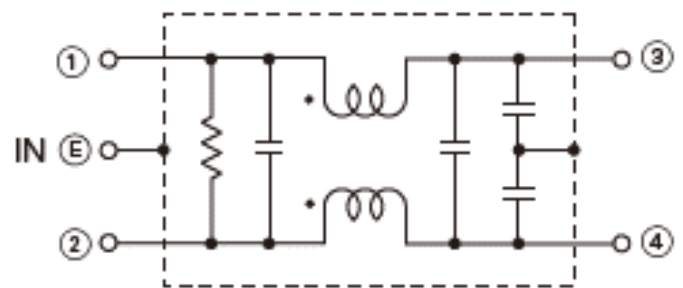

GT-2**J, GT-2**01

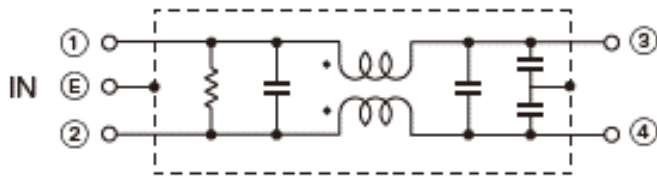

GT-2**02

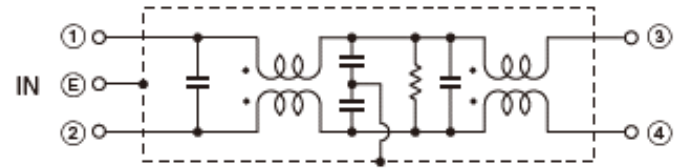

Circuit Diagram cont.

GT-2**01V

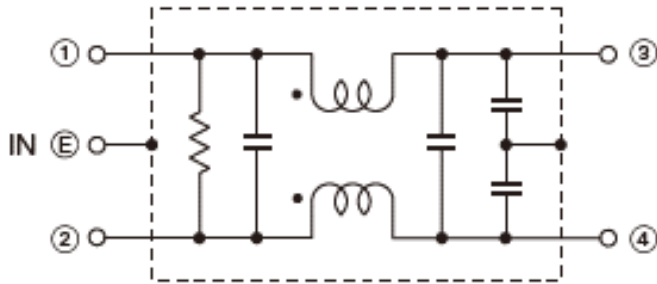

Measuring Circuit - Common Mode



P: Power divider $Z_0 : 50\Omega$

Measuring Circuit - Normal Mode

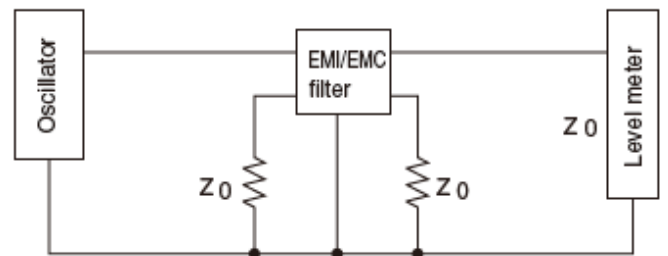

$Z_0 : 50\Omega$

Pulse Attenuation Characteristics



Pulse Characteristic Measuring Circuit



Attenuation (Static Characteristics)

GT-205U

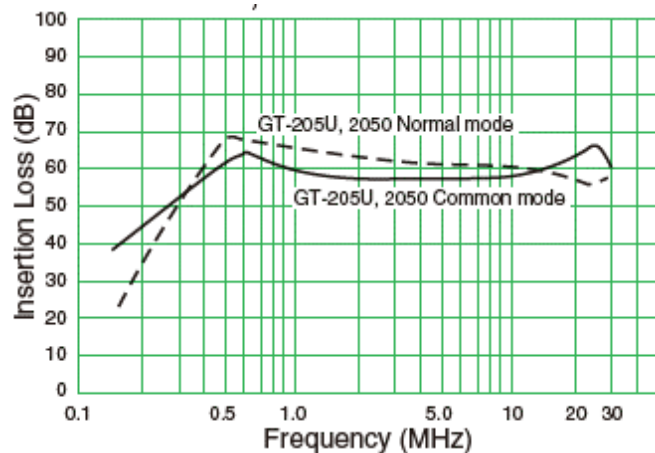

GT-2050R

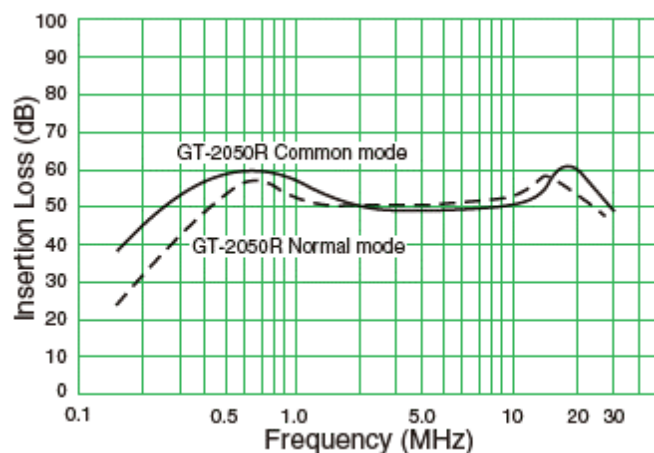

GT-2150R

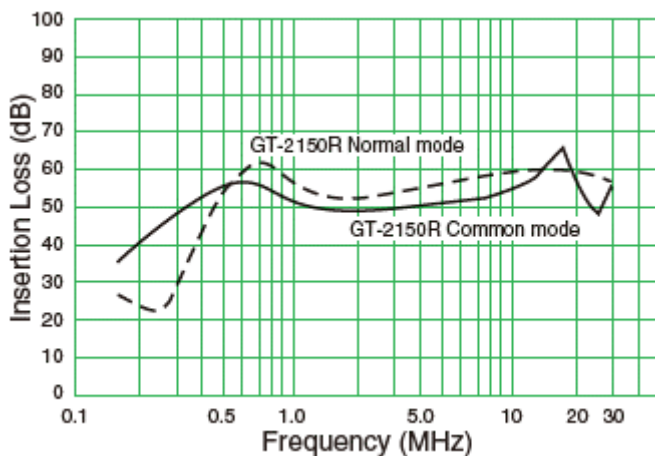

GT-2200, GT-220U

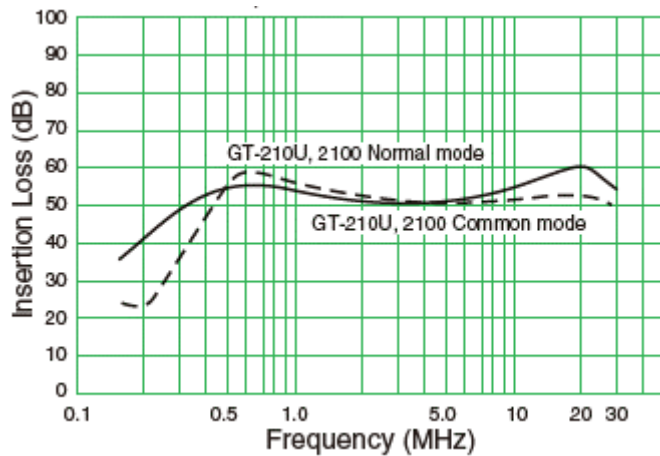

GT-205J, GT-210J, GT-215J

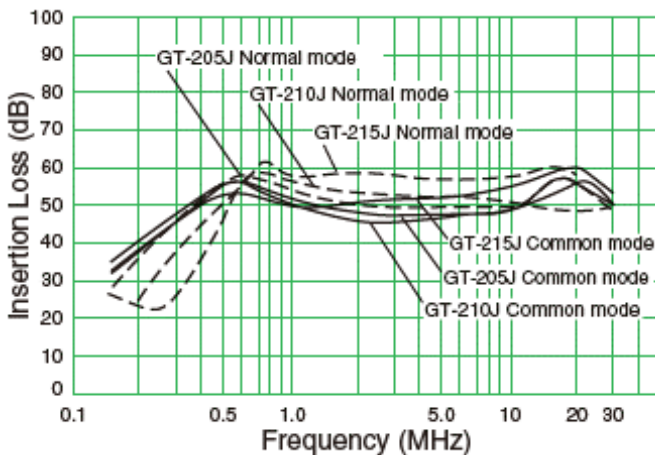

GT-20301, GT-21001, GT-20302

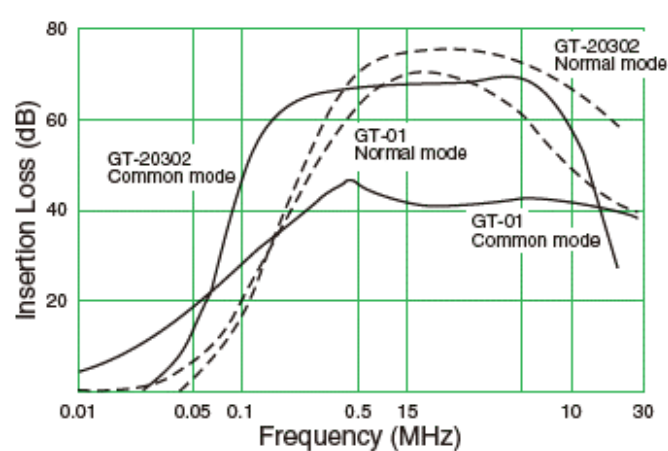

Attenuation (Static Characteristics) cont.

GT-20501V

Image coming soon

GT-21001V

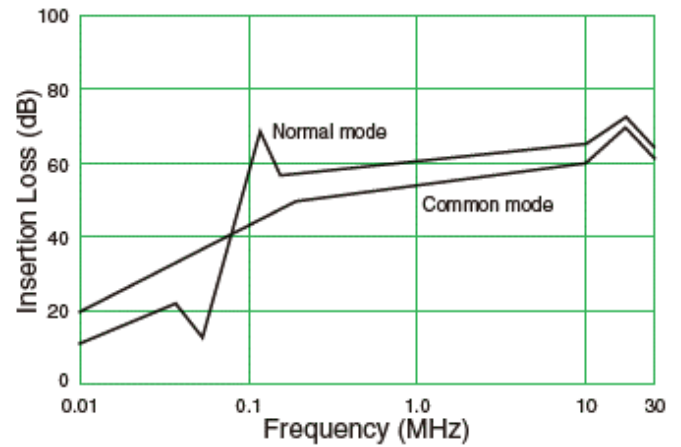

GT-22001V

Image coming soon

TÜV Rheinland Japan Ltd. Certification Numbers

Part Number	File Number
GT-205U	N° R50015833
GT-210U	N° R50015833
GT-220U	N° R9651191
GT-205J	N° R50014761
GT-210J	N° R50014761
GT-215J	N° R50014761
GT-20301	N° R50015833
GT-21001	N° R50015833
GT-20302	N° R50015833
GT-21001V	N° R2-50004761
GT-22001V	N° R50007113

Packaging

Part Type	Packaging Type	Pieces per Box
GT-205U	Tray	30
GT-2050R		20
GT-2150R		40
GT-2100		20
GT-2150		30
GT-2200		40
GT-210U		20
GT-215U		30
GT-220U		50
GT-205J		40
GT-210J		30
GT-215J		32
GT-20301		30
GT-21001		40
GT-20302		20
GT-20501V		40
GT-21001V		20
GT-22001V		40

Handling Precautions

Precautions for product storage

EMI-RFI Filters should be stored in normal working environments. While the filters themselves are quite robust in other environments, solderability will be degraded by exposure to high temperatures, high humidity, corrosive atmospheres, and long term storage.

KEMET recommends that maximum storage temperature not exceed 40°C and maximum storage humidity not exceed 70% relative humidity and atmospheres should be free of chlorine and sulfur bearing compounds. Temperature fluctuations should be minimized to avoid condensation on the parts. Also, avoid storage near strong magnetic fields as this might magnetize the product.

For optimized solderability, EMI-RFI Filters' stock should be used promptly, preferably within 6 months of receipt.

Export Control

For customers in Japan

For products which are controlled items subject to the "Foreign Exchange and Foreign Trade Law" of Japan, the export license specified by the law is required for export.

For customers outside Japan

EMI-RFI Filters should not be used or sold for use in the development, production, stockpiling, or utilization of any conventional weapons or mass-destructive weapons (nuclear weapons, chemical or biological weapons, or missiles), or any other weapons.

KEMET Electronics Corporation Sales Offices

For a complete list of our global sales offices, please visit www.kemet.com/sales.

Disclaimer

All product specifications, statements, information and data (collectively, the "Information") in this datasheet are subject to change. The customer is responsible for checking and verifying the extent to which the Information contained in this publication is applicable to an order at the time the order is placed. All Information given herein is believed to be accurate and reliable, but it is presented without guarantee, warranty, or responsibility of any kind, expressed or implied.

Statements of suitability for certain applications are based on KEMET Electronics Corporation's ("KEMET") knowledge of typical operating conditions for such applications, but are not intended to constitute – and KEMET specifically disclaims – any warranty concerning suitability for a specific customer application or use. The Information is intended for use only by customers who have the requisite experience and capability to determine the correct products for their application. Any technical advice inferred from this Information or otherwise provided by KEMET with reference to the use of KEMET's products is given gratis, and KEMET assumes no obligation or liability for the advice given or results obtained.

Although KEMET designs and manufactures its products to the most stringent quality and safety standards, given the current state of the art, isolated component failures may still occur. Accordingly, customer applications which require a high degree of reliability or safety should employ suitable designs or other safeguards (such as installation of protective circuitry or redundancies) in order to ensure that the failure of an electrical component does not result in a risk of personal injury or property damage.

Although all product-related warnings, cautions and notes must be observed, the customer should not assume that all safety measures are indicated or that other measures may not be required.

KEMET is a registered trademark of KEMET Electronics Corporation.



Компания «ЭлектроПласт» предлагает заключение долгосрочных отношений при поставках импортных электронных компонентов на взаимовыгодных условиях!

Наши преимущества:

- Оперативные поставки широкого спектра электронных компонентов отечественного и импортного производства напрямую от производителей и с крупнейших мировых складов;
- Поставка более 17-ти миллионов наименований электронных компонентов;
- Поставка сложных, дефицитных, либо снятых с производства позиций;
- Оперативные сроки поставки под заказ (от 5 рабочих дней);
- Экспресс доставка в любую точку России;
- Техническая поддержка проекта, помощь в подборе аналогов, поставка прототипов;
- Система менеджмента качества сертифицирована по Международному стандарту ISO 9001;
- Лицензия ФСБ на осуществление работ с использованием сведений, составляющих государственную тайну;
- Поставка специализированных компонентов (Xilinx, Altera, Analog Devices, Intersil, Interpoint, Microsemi, Aeroflex, Peregrine, Syfer, Eurofarad, Texas Instrument, Miteq, Cobham, E2V, MA-COM, Hittite, Mini-Circuits, General Dynamics и др.);

Помимо этого, одним из направлений компании «ЭлектроПласт» является направление «Источники питания». Мы предлагаем Вам помощь Конструкторского отдела:

- Подбор оптимального решения, техническое обоснование при выборе компонента;
- Подбор аналогов;
- Консультации по применению компонента;
- Поставка образцов и прототипов;
- Техническая поддержка проекта;
- Защита от снятия компонента с производства.



Как с нами связаться

Телефон: 8 (812) 309 58 32 (многоканальный)

Факс: 8 (812) 320-02-42

Электронная почта: org@eplast1.ru

Адрес: 198099, г. Санкт-Петербург, ул. Калинина, дом 2, корпус 4, литера А.