



TISP4070H3BJ THRU TISP4115H3BJ,  
TISP4125H3BJ THRU TISP4220H3BJ,  
TISP4240H3BJ THRU TISP4400H3BJ

## BIDIRECTIONAL THYRISTOR OVERVOLTAGE PROTECTORS

### TISP4xxxH3BJ Overvoltage Protector Series

#### TISP4xxxH3BJ Overview

This TISP<sup>®</sup> device series protects central office, access and customer premise equipment against overvoltages on the telecom line. The TISP4xxxH3BJ is available in a wide range of voltages and has a high current capability, allowing minimal series resistance to be used. These protectors have been specified mindful of the following standards and recommendations: GR-1089-CORE, FCC Part 68, UL1950, EN 60950, IEC 60950, ITU-T K.20, K.21 and K.45. The TISP4350H3BJ meets the FCC Part 68 "B" ringer voltage requirement and survives the Type A and B impulse tests. These devices are housed in a surface mount SMB (DO-214AA) package.

#### Summary Electrical Characteristics

| Part #     | V <sub>DRM</sub><br>V | V <sub>(BO)</sub><br>V | V <sub>T @ I<sub>T</sub></sub><br>V | I <sub>DRM</sub><br>μA | I <sub>(BO)</sub><br>mA | I <sub>T</sub><br>A | I <sub>H</sub><br>mA | C <sub>o @ -2 V</sub><br>pF | Functionally Replaces |
|------------|-----------------------|------------------------|-------------------------------------|------------------------|-------------------------|---------------------|----------------------|-----------------------------|-----------------------|
| TISP4070H3 | 58                    | 70                     | 3                                   | 5                      | 600                     | 5                   | 150                  | 120                         | P0640SC†              |
| TISP4080H3 | 65                    | 80                     | 3                                   | 5                      | 600                     | 5                   | 150                  | 120                         | P0720SC†              |
| TISP4095H3 | 75                    | 95                     | 3                                   | 5                      | 600                     | 5                   | 150                  | 120                         | P0900SC†              |
| TISP4115H3 | 90                    | 115                    | 3                                   | 5                      | 600                     | 5                   | 150                  | 120                         | P1100SC†              |
| TISP4125H3 | 100                   | 125                    | 3                                   | 5                      | 600                     | 5                   | 150                  | 65                          |                       |
| TISP4145H3 | 120                   | 145                    | 3                                   | 5                      | 600                     | 5                   | 150                  | 65                          | P1300SC†              |
| TISP4165H3 | 135                   | 165                    | 3                                   | 5                      | 600                     | 5                   | 150                  | 65                          |                       |
| TISP4180H3 | 145                   | 180                    | 3                                   | 5                      | 600                     | 5                   | 150                  | 65                          | P1500SC               |
| TISP4200H3 | 155                   | 200                    | 3                                   | 5                      | 600                     | 5                   | 150                  | 65                          |                       |
| TISP4220H3 | 160                   | 220                    | 3                                   | 5                      | 600                     | 5                   | 150                  | 65                          | P1800SC               |
| TISP4240H3 | 180                   | 240                    | 3                                   | 5                      | 600                     | 5                   | 150                  | 55                          |                       |
| TISP4250H3 | 190                   | 250                    | 3                                   | 5                      | 600                     | 5                   | 150                  | 55                          | P2300SC†              |
| TISP4265H3 | 200                   | 265                    | 3                                   | 5                      | 600                     | 5                   | 150                  | 55                          |                       |
| TISP4290H3 | 220                   | 290                    | 3                                   | 5                      | 600                     | 5                   | 150                  | 55                          | P2600SC†              |
| TISP4300H3 | 230                   | 300                    | 3                                   | 5                      | 600                     | 5                   | 150                  | 55                          |                       |
| TISP4350H3 | 275                   | 350                    | 3                                   | 5                      | 600                     | 5                   | 150                  | 55                          | P3100SC               |
| TISP4395H3 | 320                   | 395                    | 3                                   | 5                      | 600                     | 5                   | 150                  | 55                          | P3500SC               |
| TISP4400H3 | 300                   | 400                    | 3                                   | 5                      | 600                     | 5                   | 150                  | 55                          |                       |

† Bourns part has an improved protection voltage

#### Summary Current Ratings

| Parameter | I <sub>TSP</sub><br>A |              |        |       |        |         | I <sub>TSM</sub><br>A | di/dt<br>A/μs  |
|-----------|-----------------------|--------------|--------|-------|--------|---------|-----------------------|----------------|
|           | 2/10                  | 1.2/50, 8/20 | 10/160 | 5/320 | 10/560 | 10/1000 | 1 cycle 60 Hz         | 2/10 Wavefront |
| Value     | 500                   | 300          | 250    | 200   | 160    | 100     | 60                    | 400            |

\*RoHS Directive 2002/95/EC Jan 27 2003 including Annex  
NOVEMBER 1997 - REVISED JANUARY 2007

Specifications are subject to change without notice.  
Customers should verify actual device performance in their specific applications.

# TISP4xxxH3BJ Overvoltage Protector Series



ITU-T K.20/21 Rating . . . . . 8 kV 10/700, 200 A 5/310

Ion-Implanted Breakdown Region  
Precise and Stable Voltage  
Low Voltage Overshoot under Surge

| Device | V <sub>DRM</sub><br>V | V <sub>(BO)</sub><br>V |
|--------|-----------------------|------------------------|
| '4070  | 58                    | 70                     |
| '4080  | 65                    | 80                     |
| '4095  | 75                    | 95                     |
| '4115  | 90                    | 115                    |
| '4125  | 100                   | 125                    |
| '4145  | 120                   | 145                    |
| '4165  | 135                   | 165                    |
| '4180  | 145                   | 180                    |
| '4200  | 155                   | 200                    |
| '4220  | 160                   | 220                    |
| '4240  | 180                   | 240                    |
| '4250  | 190                   | 250                    |
| '4265  | 200                   | 265                    |
| '4290  | 220                   | 290                    |
| '4300  | 230                   | 300                    |
| '4350  | 275                   | 350                    |
| '4395  | 320                   | 395                    |
| '4400  | 300                   | 400                    |

Low Differential Capacitance .....67 pF max.

 ..... UL Recognized Component

## SMBJ Package (Top View)

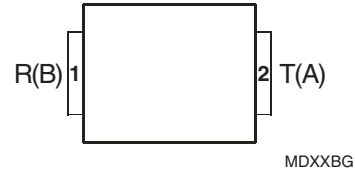

## Device Symbol



Terminals T and R correspond to the alternative line designators of A and B

## Rated for International Surge Wave Shapes

| Waveshape  | Standard      | I <sub>TSP</sub><br>A |
|------------|---------------|-----------------------|
| 2/10 μs    | GR-1089-CORE  | 500                   |
| 8/20 μs    | IEC 61000-4-5 | 300                   |
| 10/160 μs  | FCC Part 68   | 250                   |
| 10/700 μs  | ITU-T K.20/21 | 200                   |
| 10/560 μs  | FCC Part 68   | 160                   |
| 10/1000 μs | GR-1089-CORE  | 100                   |

## Description

These devices are designed to limit overvoltages on the telephone line. Overvoltages are normally caused by a.c. power system or lightning flash disturbances which are induced or conducted on to the telephone line. A single device provides 2-point protection and is typically used for the protection of 2-wire telecommunication equipment (e.g. between the Ring and Tip wires for telephones and modems). Combinations of devices can be used for multi-point protection (e.g. 3-point protection between Ring, Tip and Ground).

The protector consists of a symmetrical voltage-triggered bidirectional thyristor. Overvoltages are initially clipped by breakdown clamping until the voltage rises to the breakover level, which causes the device to crowbar into a low-voltage on state. This low-voltage on state causes the current resulting from the overvoltage to be safely diverted through the device. The high crowbar holding current helps prevent d.c. latchup as the diverted current subsides.

This TISP4xxxH3BJ range consists of eighteen voltage variants to meet various maximum system voltage levels (58 V to 320 V). They are guaranteed to voltage limit and withstand the listed international lightning surges in both polarities. These high (H) current protection devices are in a plastic package SMBJ (JEDEC DO-214AA with J-bend leads) and supplied in embossed carrier reel pack. For alternative voltage and holding current values, consult the factory. For lower rated impulse currents in the SMB package, the 50 A 10/1000 TISP4xxxM3BJ series is available.

## How To Order

| Device       | Package                  | Carrier              | Order As        |
|--------------|--------------------------|----------------------|-----------------|
| TISP4xxxH3BJ | BJ (J-Bend DO-214AA/SMB) | Embossed Tape Reeled | TISP4xxxH3BJR-S |
|              |                          | Bulk Pack            | TISP4xxxH3BJ-S  |

Insert xxx value corresponding to protection voltages of 070, 080, 095, 115 etc.

NOVEMBER 1997 - REVISED JANUARY 2007

Specifications are subject to change without notice.  
Customers should verify actual device performance in their specific applications.

# TISP4xxxH3BJ Overvoltage Protector Series

**BOURNS®**

## Absolute Maximum Ratings, $T_A = 25\text{ }^\circ\text{C}$ (Unless Otherwise Noted)

| Rating  | Symbol    | Value       | Unit             |
|---|-----------|-------------|------------------|
| Repetitive peak off-state voltage, (see Note 1)   | '4070     | $\pm 58$    | V                |
|   | '4080     | $\pm 65$    |                  |
|   | '4095     | $\pm 75$    |                  |
|   | '4115     | $\pm 90$    |                  |
|   | '4125     | $\pm 100$   |                  |
|   | '4145     | $\pm 120$   |                  |
|   | '4165     | $\pm 135$   |                  |
|   | '4180     | $\pm 145$   |                  |
|   | '4200     | $\pm 155$   |                  |
|   | '4220     | $\pm 160$   |                  |
|   | '4240     | $\pm 180$   |                  |
|   | '4250     | $\pm 190$   |                  |
|   | '4265     | $\pm 200$   |                  |
|   | '4290     | $\pm 220$   |                  |
|   | '4300     | $\pm 230$   |                  |
| '4350   | $\pm 275$ |             |                  |
| '4395   | $\pm 320$ |             |                  |
| '4400   | $\pm 300$ |             |                  |
| Non-repetitive peak on-state pulse current (see Notes 2, 3 and 4)   | $I_{TSP}$ | 500         | A                |
| 2/10 $\mu\text{s}$ (GR-1089-CORE, 2/10 $\mu\text{s}$ voltage wave shape)                                  |           | 300         |                  |
| 8/20 $\mu\text{s}$ (IEC 61000-4-5, 1.2/50 $\mu\text{s}$ voltage, 8/20 current combination wave generator) |           | 250         |                  |
| 10/160 $\mu\text{s}$ (FCC Part 68, 10/160 $\mu\text{s}$ voltage wave shape)                               |           | 220         |                  |
| 5/200 $\mu\text{s}$ (VDE 0433, 10/700 $\mu\text{s}$ voltage wave shape)                                   |           | 200         |                  |
| 0.2/310 $\mu\text{s}$ (I3124, 0.5/700 $\mu\text{s}$ voltage wave shape)                                   |           | 200         |                  |
| 5/310 $\mu\text{s}$ (ITU-T K.20/21, 10/700 $\mu\text{s}$ voltage wave shape)                              |           | 200         |                  |
| 5/310 $\mu\text{s}$ (FTZ R12, 10/700 $\mu\text{s}$ voltage wave shape)                                    |           | 160         |                  |
| 10/560 $\mu\text{s}$ (FCC Part 68, 10/560 $\mu\text{s}$ voltage wave shape)                               |           | 100         |                  |
| 10/1000 $\mu\text{s}$ (GR-1089-CORE, 10/1000 $\mu\text{s}$ voltage wave shape)                            |           |             |                  |
| Non-repetitive peak on-state current (see Notes 2, 3 and 5)   | $I_{TSM}$ | 55          | A                |
| 20 ms (50 Hz) full sine wave  |           | 60          |                  |
| 16.7 ms (60 Hz) full sine wave  |           | 2.1         |                  |
| 1000 s 50 Hz/60 Hz a.c.   |           |             |                  |
| Initial rate of rise of on-state current, Exponential current ramp, Maximum ramp value < 200 A            | $di_T/dt$ | 400         | A/ $\mu\text{s}$ |
| Junction temperature  | $T_J$     | -40 to +150 | $^\circ\text{C}$ |
| Storage temperature range   | $T_{stg}$ | -65 to +150 | $^\circ\text{C}$ |

- NOTES: 1. See Applications Information and Figure 10 for voltage values at lower temperatures.  
 2. Initially, the TISP4xxxH3BJ must be in thermal equilibrium with  $T_J = 25\text{ }^\circ\text{C}$ .  
 3. The surge may be repeated after the TISP4xxxH3BJ returns to its initial conditions.  
 4. See Applications Information and Figure 11 for current ratings at other temperatures.  
 5. EIA/JESD51-2 environment and EIA/JESD51-3 PCB with standard footprint dimensions connected with 5 A rated printed wiring track widths. See Figure 8 for the current ratings at other durations. Derate current values at  $-0.61\text{ }^\circ\text{C}$  for ambient temperatures above  $25\text{ }^\circ\text{C}$ .

# TISP4xxxH3BJ Overvoltage Protector Series

# BOURNS®

## Electrical Characteristics, $T_A = 25\text{ }^\circ\text{C}$ (Unless Otherwise Noted)

| Parameter  | Test Conditions  | Min.       | Typ. | Max.   | Unit                    |
|--|--|------------|------|--|-------------------------|
| $I_{\text{DRM}}$ Repetitive peak off-state current | $V_D = V_{\text{DRM}}$<br>$T_A = 25\text{ }^\circ\text{C}$<br>$T_A = 85\text{ }^\circ\text{C}$   |            |      | $\pm 5$<br>$\pm 10$  | $\mu\text{A}$           |
| $V_{(\text{BO})}$ Breakover voltage                | $dv/dt = \pm 750\text{ V/ms}$ , $R_{\text{SOURCE}} = 300\ \Omega$  |            |      | '4070 $\pm 70$<br>'4080 $\pm 80$<br>'4095 $\pm 95$<br>'4115 $\pm 115$<br>'4125 $\pm 125$<br>'4145 $\pm 145$<br>'4165 $\pm 165$<br>'4180 $\pm 180$<br>'4200 $\pm 200$<br>'4220 $\pm 220$<br>'4240 $\pm 240$<br>'4250 $\pm 250$<br>'4265 $\pm 265$<br>'4290 $\pm 290$<br>'4300 $\pm 300$<br>'4350 $\pm 350$<br>'4395 $\pm 395$<br>'4400 $\pm 400$  | V                       |
| $V_{(\text{BO})}$ Impulse breakover voltage        | $dv/dt \leq \pm 1000\text{ V}/\mu\text{s}$ , Linear voltage ramp,<br>Maximum ramp value = $\pm 500\text{ V}$<br>$di/dt = \pm 20\text{ A}/\mu\text{s}$ , Linear current ramp,<br>Maximum ramp value = $\pm 10\text{ A}$ |            |      | '4070 $\pm 78$<br>'4080 $\pm 88$<br>'4095 $\pm 103$<br>'4115 $\pm 124$<br>'4125 $\pm 134$<br>'4145 $\pm 154$<br>'4165 $\pm 174$<br>'4180 $\pm 189$<br>'4200 $\pm 210$<br>'4220 $\pm 230$<br>'4240 $\pm 250$<br>'4250 $\pm 261$<br>'4265 $\pm 276$<br>'4290 $\pm 301$<br>'4300 $\pm 311$<br>'4350 $\pm 362$<br>'4395 $\pm 408$<br>'4400 $\pm 413$ | V                       |
| $I_{(\text{BO})}$ Breakover current                | $dv/dt = \pm 750\text{ V/ms}$ , $R_{\text{SOURCE}} = 300\ \Omega$  | $\pm 0.15$ |      | $\pm 0.6$  | A                       |
| $V_T$ On-state voltage                             | $I_T = \pm 5\text{ A}$ , $t_W = 100\ \mu\text{s}$  |            |      | $\pm 3$  | V                       |
| $I_H$ Holding current                              | $I_T = \pm 5\text{ A}$ , $di/dt = -/+30\text{ mA/ms}$  | $\pm 0.15$ |      | $\pm 0.6$  | A                       |
| $dv/dt$ Critical rate of rise of off-state voltage | Linear voltage ramp, Maximum ramp value $< 0.85V_{\text{DRM}}$   | $\pm 5$    |      |  | $\text{kV}/\mu\text{s}$ |
| $I_D$ Off-state current                            | $V_D = \pm 50\text{ V}$<br>$T_A = 85\text{ }^\circ\text{C}$  |            |      | $\pm 10$   | $\mu\text{A}$           |

NOVEMBER 1997 - REVISED JANUARY 2007

Specifications are subject to change without notice.  
Customers should verify actual device performance in their specific applications.

# TISP4xxxH3BJ Overvoltage Protector Series

**BOURNS®**

## Electrical Characteristics, $T_A = 25\text{ }^\circ\text{C}$ (Unless Otherwise Noted) (continued)

| Parameter   | Test Conditions  | Min.             | Typ. | Max. | Unit |
|---|--|------------------|------|------|------|
| $C_{off}$ Off-state capacitance   | f = 100 kHz, $V_d = 1\text{ V rms}$ , $V_D = 0$ ,          | '4070 thru '4115 | 145  | 170  | pF   |
|   |  | '4125 thru '4220 | 80   | 90   |      |
|   |  | '4240 thru '4400 | 70   | 84   |      |
|   | f = 100 kHz, $V_d = 1\text{ V rms}$ , $V_D = -1\text{ V}$  | '4070 thru '4115 | 130  | 150  |      |
|   |  | '4125 thru '4220 | 71   | 79   |      |
|   |  | '4240 thru '4400 | 60   | 67   |      |
|   | f = 100 kHz, $V_d = 1\text{ V rms}$ , $V_D = -2\text{ V}$  | '4070 thru '4115 | 120  | 140  |      |
|   |  | '4125 thru '4220 | 65   | 74   |      |
|   |  | '4240 thru '4400 | 55   | 62   |      |
|   | f = 100 kHz, $V_d = 1\text{ V rms}$ , $V_D = -50\text{ V}$ | '4070 thru '4115 | 62   | 73   |      |
|   |  | '4125 thru '4220 | 30   | 35   |      |
|   |  | '4240 thru '4400 | 24   | 28   |      |
| f = 100 kHz, $V_d = 1\text{ V rms}$ , $V_D = -100\text{ V}$<br>(see Note 6) | '4125 thru '4220   | 28               | 33   |      |      |
|   | '4240 thru '4400   | 22               | 26   |      |      |

NOTE 6: To avoid possible voltage clipping, the '4125 is tested with  $V_D = -98\text{ V}$ .

## Thermal Characteristics

| Parameter   | Test Conditions   | Min. | Typ. | Max. | Unit               |
|---|---|------|------|------|--------------------|
| $R_{\theta JA}$ Junction to free air thermal resistance | EIA/JESD51-3 PCB, $I_T = I_{TSM(1000)}$ ,<br>$T_A = 25\text{ }^\circ\text{C}$ , (see Note 7)                  |      |      | 113  | $^\circ\text{C/W}$ |
|   | 265 mm x 210 mm populated line card,<br>4-layer PCB, $I_T = I_{TSM(1000)}$ , $T_A = 25\text{ }^\circ\text{C}$ |      | 50   |      |                    |

NOTE 7: EIA/JESD51-2 environment and PCB has standard footprint dimensions connected with 5 A rated printed wiring track widths.

Parameter Measurement Information

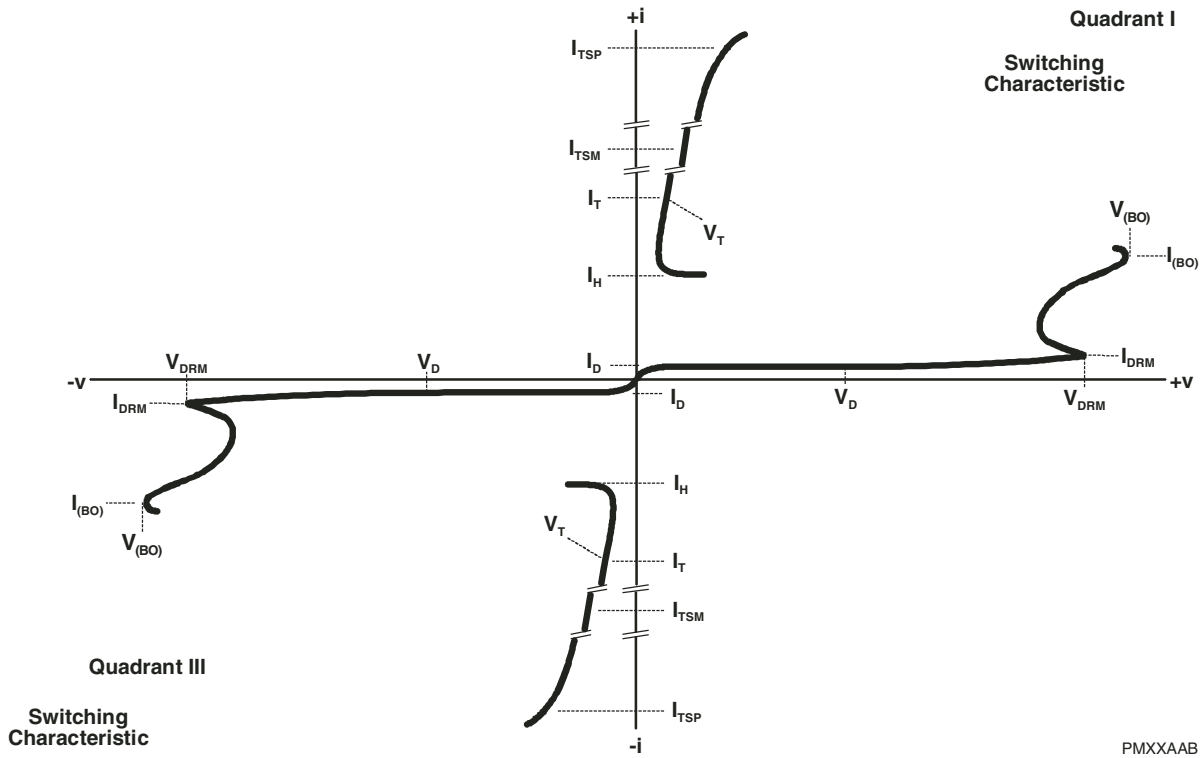

PMXXAAB

Figure 1. Voltage-current Characteristic for T and R Terminals  
All Measurements are Referenced to the R Terminal

## Typical Characteristics

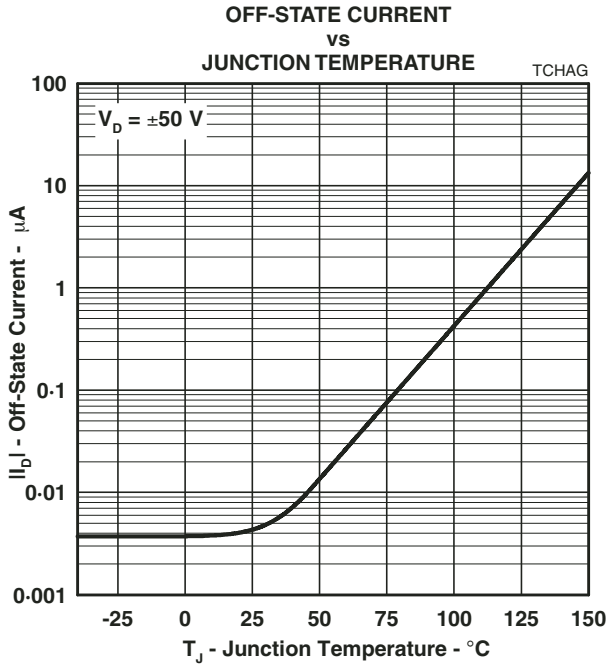

Figure 2.

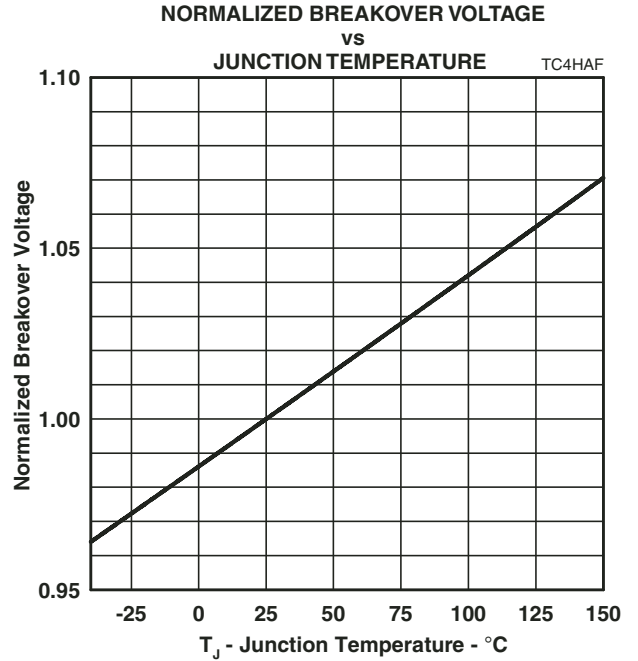

Figure 3.

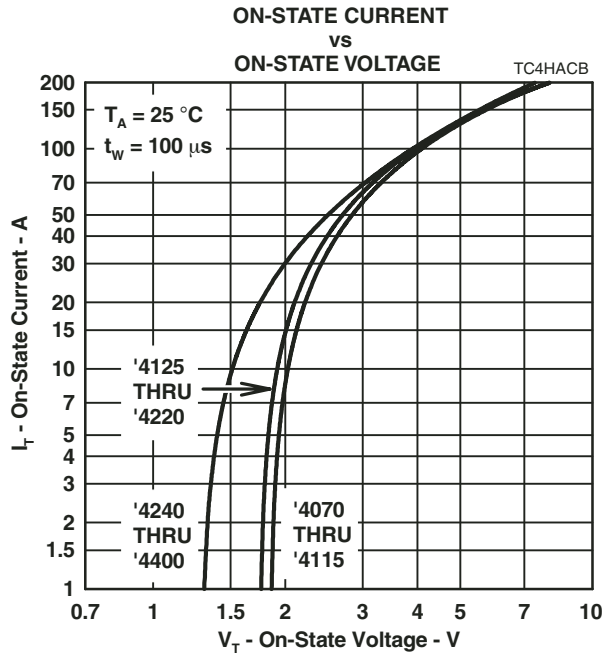

Figure 4.

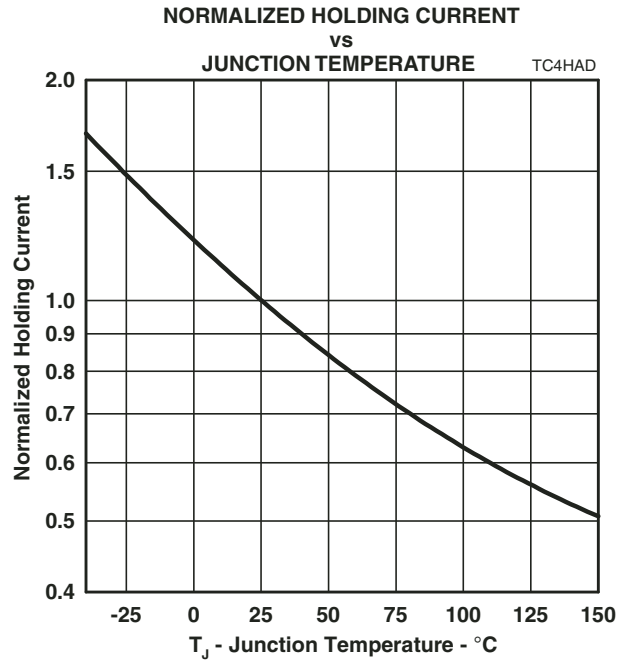

Figure 5.

## Typical Characteristics

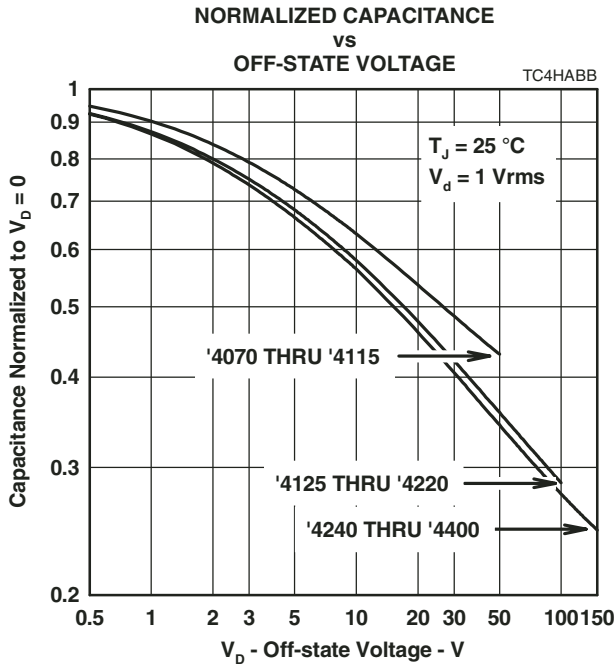

Figure 6.

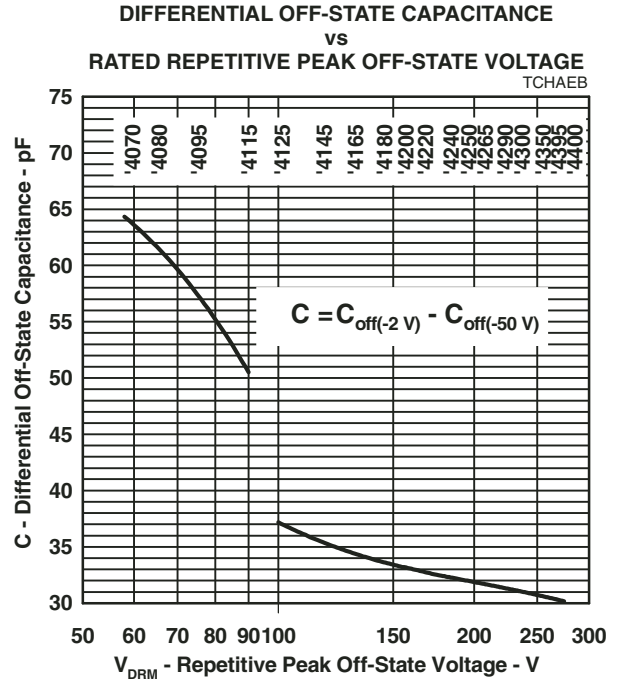
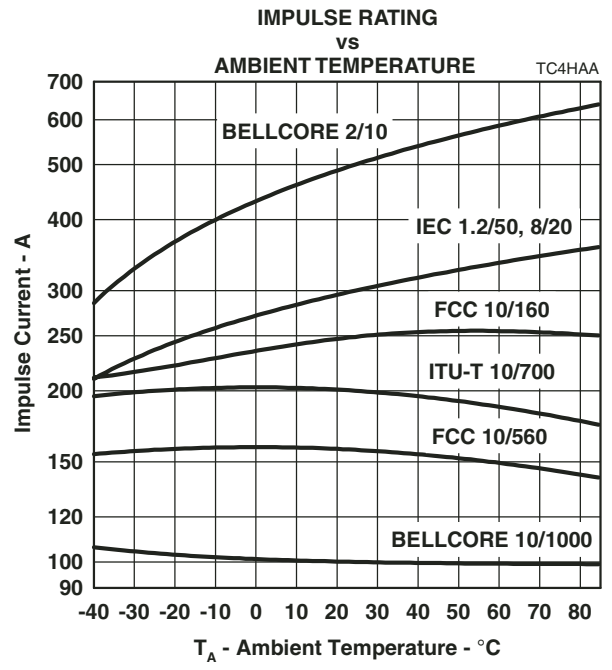
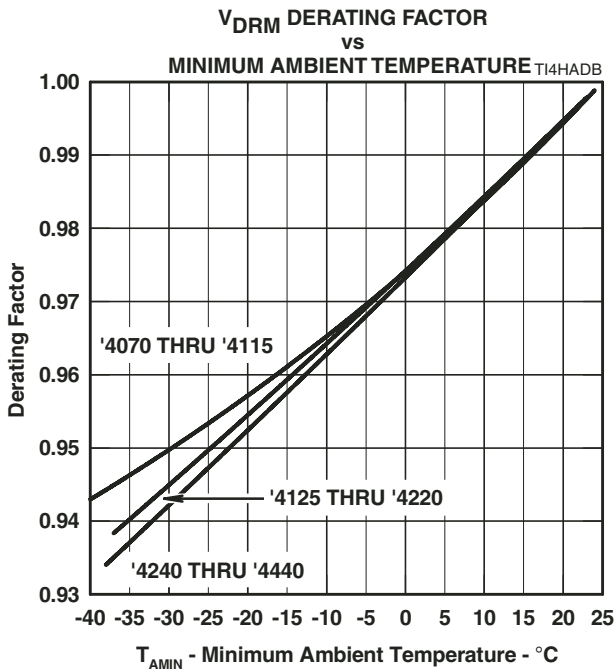
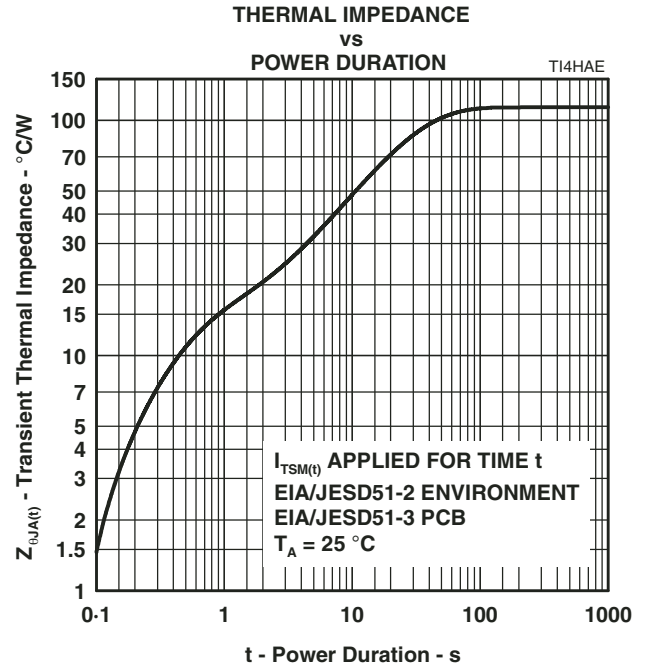
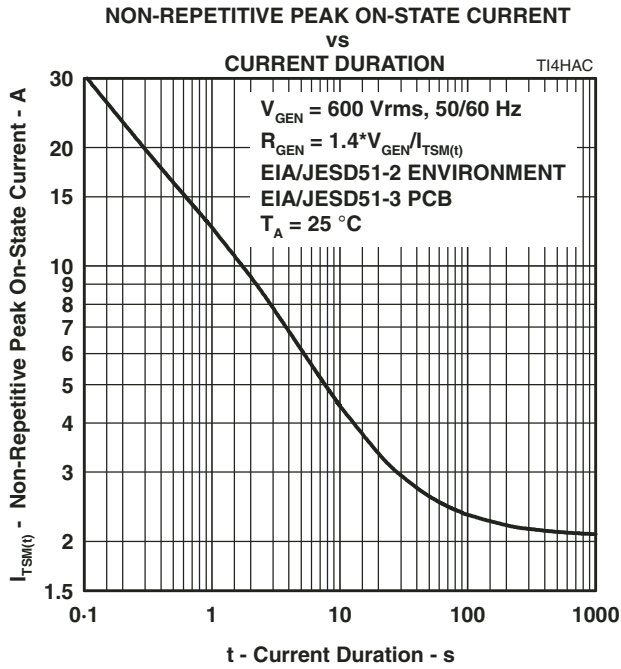

Figure 7.



## Rating and Thermal Information



## APPLICATIONS INFORMATION

### Deployment

These devices are two terminal overvoltage protectors. They may be used either singly to limit the voltage between two conductors (Figure 12) or in multiples to limit the voltage at several points in a circuit (Figure 13).

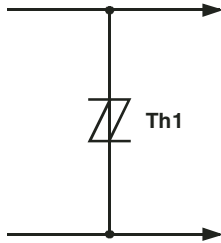

Figure 12. Two Point Protection

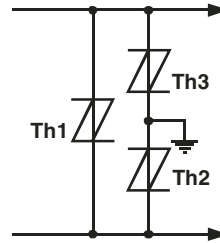

Figure 13. Multi-point Protection

In Figure 12, protector Th1 limits the maximum voltage between the two conductors to  $\pm V_{(BO)}$ . This configuration is normally used to protect circuits without a ground reference, such as modems. In Figure 13, protectors Th2 and Th3 limit the maximum voltage between each conductor and ground to the  $\pm V_{(BO)}$  of the individual protector. Protector Th1 limits the maximum voltage between the two conductors to its  $\pm V_{(BO)}$  value. If the equipment being protected has all its vulnerable components connected between the conductors and ground, then protector Th1 is not required.

### Impulse Testing

To verify the withstand capability and safety of the equipment, standards require that the equipment is tested with various impulse wave forms. The table below shows some common values.

| Standard                    | Peak Voltage Setting<br>V | Voltage Waveform<br>$\mu s$ | Peak Current Value<br>A | Current Waveform<br>$\mu s$ | TISP4xxxH3<br>25 °C Rating<br>A | Series Resistance<br>$\Omega$ |
|-----------------------------|---------------------------|-----------------------------|-------------------------|-----------------------------|---------------------------------|-------------------------------|
| GR-1089-CORE                | 2500                      | 2/10                        | 500                     | 2/10                        | 500                             | 0                             |
|                             | 1000                      | 10/1000                     | 100                     | 10/1000                     | 100                             |                               |
| FCC Part 68<br>(March 1998) | 1500                      | 10/160                      | 200                     | 10/160                      | 250                             | 0                             |
|                             | 800                       | 10/560                      | 100                     | 10/560                      | 160                             | 0                             |
|                             | 1500                      | 9/720 †                     | 37.5                    | 5/320 †                     | 200                             | 0                             |
|                             | 1000                      | 9/720 †                     | 25                      | 5/320 †                     | 200                             | 0                             |
| I3124                       | 1500                      | 0.5/700                     | 37.5                    | 0.2/310                     | 200                             | 0                             |
| ITU-T K.20/K.21             | 1500                      | 10/700                      | 37.5                    | 5/310                       | 200                             | 0                             |
|                             | 4000                      |                             | 100                     |                             |                                 |                               |

† FCC Part 68 terminology for the waveforms produced by the ITU-T recommendation K.21 10/700 impulse generator

If the impulse generator current exceeds the protector's current rating, then a series resistance can be used to reduce the current to the protector's rated value to prevent possible failure. The required value of series resistance for a given waveform is given by the following calculations. First, the minimum total circuit impedance is found by dividing the impulse generator's peak voltage by the protector's rated current. The impulse generator's fictive impedance (generators peak voltage divided by peak short circuit current) is then subtracted from the minimum total circuit impedance to give the required value of series resistance. In some cases, the equipment will require verification over a temperature range. By using the rated waveform values from Figure 11, the appropriate series resistor value can be calculated for ambient temperatures in the range of -40 °C to 85 °C.

## APPLICATIONS INFORMATION

### AC Power Testing

The protector can withstand currents applied for times not exceeding those shown in Figure 8. Currents that exceed these times must be terminated or reduced to avoid protector failure. Fuses, PTC (Positive Temperature Coefficient) resistors and fusible resistors are overcurrent protection devices which can be used to reduce the current flow. Protective fuses may range from a few hundred milliamperes to one ampere. In some cases, it may be necessary to add some extra series resistance to prevent the fuse opening during impulse testing. The current versus time characteristic of the overcurrent protector must be below the line shown in Figure 8. In some cases, there may be a further time limit imposed by the test standard (e.g. UL 1459 wiring simulator failure).

### Capacitance

The protector characteristic off-state capacitance values are given for d.c. bias voltage,  $V_D$ , values of 0, -1 V, -2 V and -50 V. Where possible, values are also given for -100 V. Values for other voltages may be calculated by multiplying the  $V_D = 0$  capacitance value by the factor given in Figure 6. Up to 10 MHz, the capacitance is essentially independent of frequency. Above 10 MHz, the effective capacitance is strongly dependent on connection inductance. In many applications, such as Figure 15 and Figure 17, the typical conductor bias voltages will be about -2 V and -50 V. Figure 7 shows the differential (line unbalance) capacitance caused by biasing one protector at -2 V and the other at -50 V.

### Normal System Voltage Levels

The protector should not clip or limit the voltages that occur in normal system operation. For unusual conditions, such as ringing without the line connected, some degree of clipping is permissible. Under this condition, about 10 V of clipping is normally possible without activating the ring trip circuit.

Figure 10 allows the calculation of the protector  $V_{DRM}$  value at temperatures below 25 °C. The calculated value should not be less than the maximum normal system voltages. The TISP4265H3BJ, with a  $V_{DRM}$  of 200 V, can be used for the protection of ring generators producing 100 V r.m.s. of ring on a battery voltage of -58 V (Th2 and Th3 in Figure 17). The peak ring voltage will be  $58 + 1.414 \times 100 = 199.4$  V. However, this is the open circuit voltage and the connection of the line, and its equipment will reduce the peak voltage. In the extreme case of an unconnected line, clipping the peak voltage to 190 V should not activate the ring trip. This level of clipping would occur at the temperature when the  $V_{DRM}$  has reduced to  $190/200 = 0.95$  of its 25 °C value. Figure 10 shows that this condition will occur at an ambient temperature of -22 °C. In this example, the TISP4265H3BJ will allow normal equipment operation provided that the minimum expected ambient temperature does not fall below -22 °C.

### JESD51 Thermal Measurement Method

To standardize thermal measurements, the EIA (Electronic Industries Alliance) has created the JESD51 standard. Part 2 of the standard (JESD51-2, 1995) describes the test environment. This is a  $0.0283 \text{ m}^3$  ( $1 \text{ ft}^3$ ) cube which contains the test PCB (Printed Circuit Board) horizontally mounted at the center. Part 3 of the standard (JESD51-3, 1996) defines two test PCBs for surface mount components; one for packages smaller than 27 mm (1.06 ") on a side and the other for packages up to 48 mm (1.89 "). The SMBJ measurements used the smaller 76.2 mm x 114.3 mm (3.0 " x 4.5 ") PCB. The JESD51-3 PCBs are designed to have low effective thermal conductivity (high thermal resistance) and represent a worse case condition. The PCBs used in the majority of applications will achieve lower values of thermal resistance and so can dissipate higher power levels than indicated by the JESD51 values.

## Typical Circuits

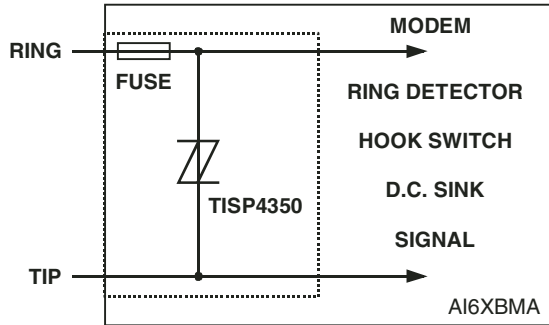

Figure 14. Modem Inter-wire Protection

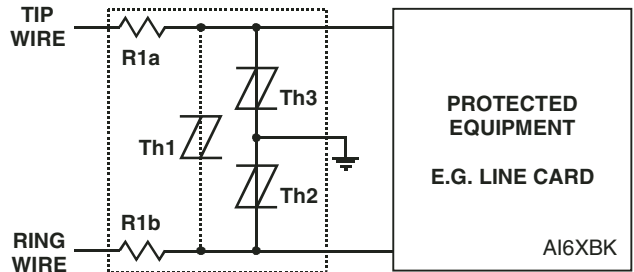

Figure 15. Protection Module

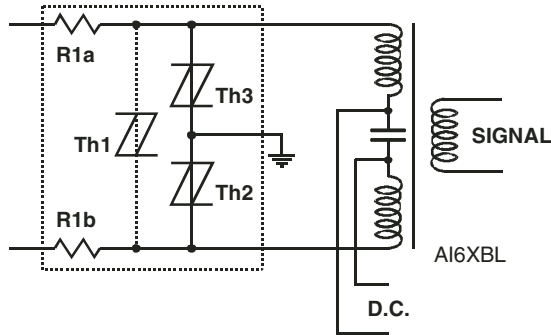

Figure 16. ISDN Protection

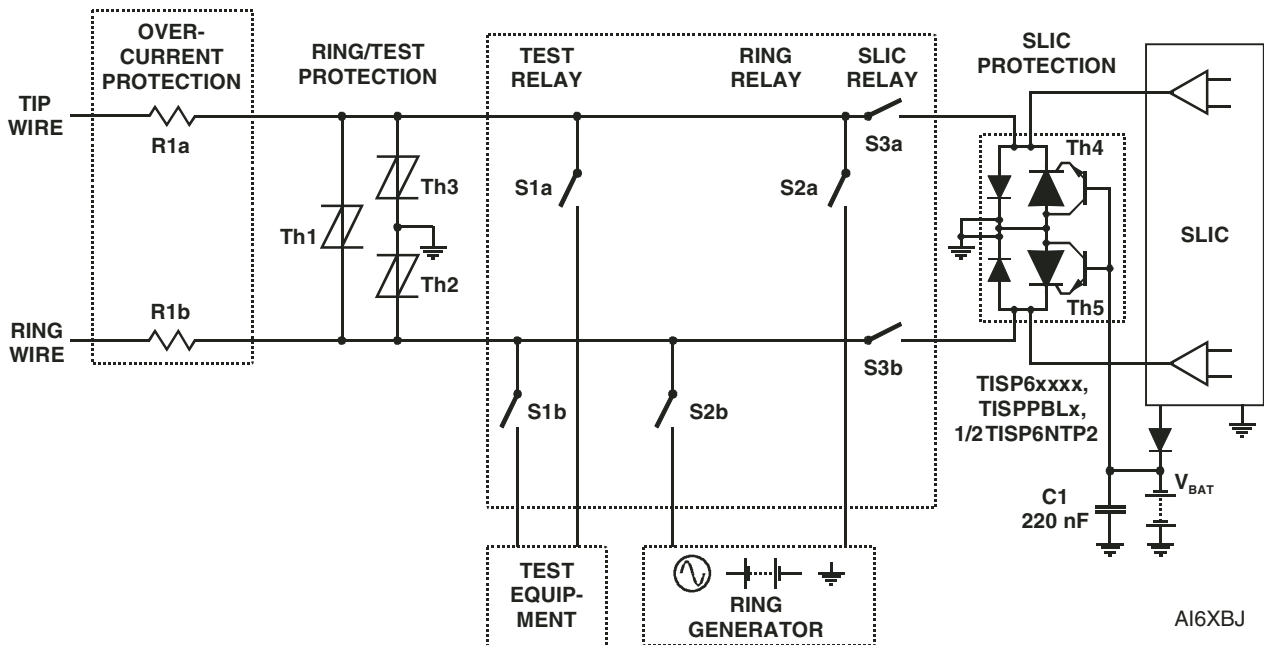

Figure 17. Line Card Ring/Test Protection

# TISP4xxxH3BJ Overvoltage Protector Series

**BOURNS®**

## MECHANICAL DATA

### Recommended Printed Wiring Footprint

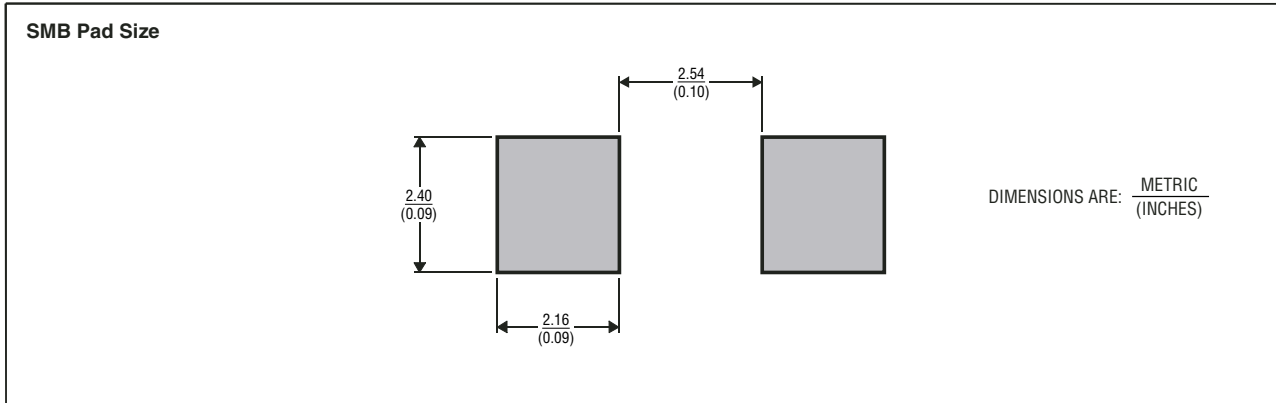

MDXXBI

### Device Symbolization Code

Devices will be coded as below. As the device parameters are symmetrical, terminal 1 is not identified.

| Device       | Symbolization Code |
|--------------|--------------------|
| TISP4070H3BJ | 4070H3             |
| TISP4080H3BJ | 4080H3             |
| TISP4095H3BJ | 4095H3             |
| TISP4115H3BJ | 4115H3             |
| TISP4125H3BJ | 4125H3             |
| TISP4145H3BJ | 4145H3             |
| TISP4165H3BJ | 4165H3             |
| TISP4180H3BJ | 4180H3             |
| TISP4200H3BJ | 4200H3             |
| TISP4220H3BJ | 4220H3             |
| TISP4240H3BJ | 4240H3             |
| TISP4250H3BJ | 4250H3             |
| TISP4265H3BJ | 4265H3             |
| TISP4290H3BJ | 4290H3             |
| TISP4300H3BJ | 4300H3             |
| TISP4350H3BJ | 4350H3             |
| TISP4395H3BJ | 4395H3             |
| TISP4400H3BJ | 4400H3             |

### Carrier Information

Devices are shipped in one of the carriers below. Unless a specific method of shipment is specified by the customer, devices will be shipped in the most practical carrier. For production quantities, the carrier will be embossed tape reel pack. Evaluation quantities may be shipped in bulk pack or embossed tape.

| Carrier              | Order As        |
|----------------------|-----------------|
| Embossed Tape Reeled | TISP4xxxH3BJR-S |
| Bulk Pack            | TISP4xxxH3BJ-S  |



Компания «ЭлектроПласт» предлагает заключение долгосрочных отношений при поставках импортных электронных компонентов на взаимовыгодных условиях!

Наши преимущества:

- Оперативные поставки широкого спектра электронных компонентов отечественного и импортного производства напрямую от производителей и с крупнейших мировых складов;
- Поставка более 17-ти миллионов наименований электронных компонентов;
- Поставка сложных, дефицитных, либо снятых с производства позиций;
- Оперативные сроки поставки под заказ (от 5 рабочих дней);
- Экспресс доставка в любую точку России;
- Техническая поддержка проекта, помощь в подборе аналогов, поставка прототипов;
- Система менеджмента качества сертифицирована по Международному стандарту ISO 9001;
- Лицензия ФСБ на осуществление работ с использованием сведений, составляющих государственную тайну;
- Поставка специализированных компонентов (Xilinx, Altera, Analog Devices, Intersil, Interpoint, Microsemi, Aeroflex, Peregrine, Syfer, Eurofarad, Texas Instrument, Miteq, Cobham, E2V, MA-COM, Hittite, Mini-Circuits, General Dynamics и др.);

Помимо этого, одним из направлений компании «ЭлектроПласт» является направление «Источники питания». Мы предлагаем Вам помощь Конструкторского отдела:

- Подбор оптимального решения, техническое обоснование при выборе компонента;
- Подбор аналогов;
- Консультации по применению компонента;
- Поставка образцов и прототипов;
- Техническая поддержка проекта;
- Защита от снятия компонента с производства.



#### Как с нами связаться

**Телефон:** 8 (812) 309 58 32 (многоканальный)

**Факс:** 8 (812) 320-02-42

**Электронная почта:** [org@eplast1.ru](mailto:org@eplast1.ru)

**Адрес:** 198099, г. Санкт-Петербург, ул. Калинина, дом 2, корпус 4, литера А.