

■ Features

- High Brightness Tri-Color LEDs
- Low height and improved color mixture made possible by flat frame structure.
- Epoxy Resin Type and Silicon Resin Type.

■ Size

3528(1411)
3.5 × 2.8mm (t=0.6mm)



■ Outline

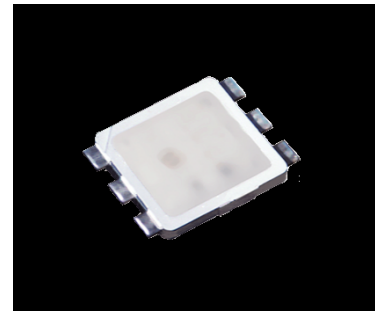

■ Dimensions

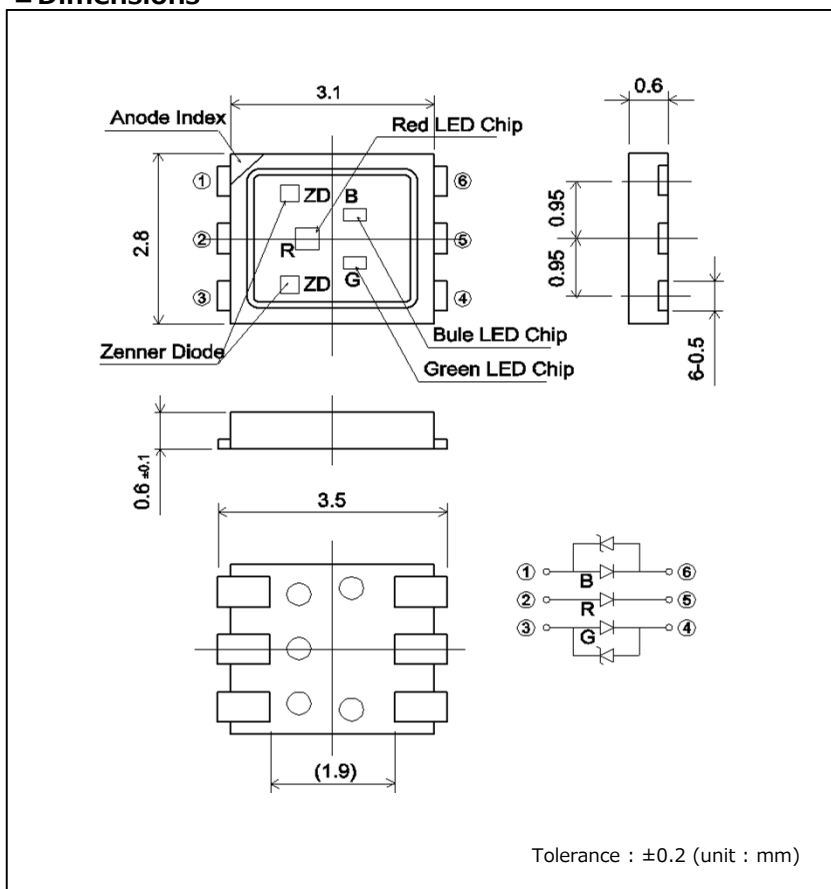

■ Recommended Solder Pattern

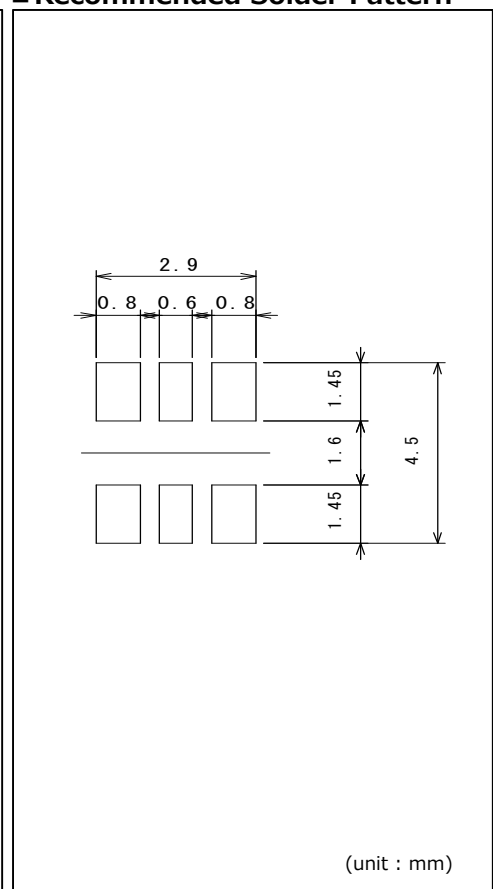

■ Specifications

Part No.	Chip Structure	Emitting Color	Absolute Maximum Ratings (Ta=25°C)					Electrical and Optical Characteristics (Ta=25°C)											
			Power Dissipation	Forward Current	Peak Forward Current	Reverse Voltage	Operating Temp.	Storage Temp.	Forward Voltage V _F		Reverse Current I _R		Dominant Wavelength λ _D			Luminous Intensity I _V			
			P _D (mW)	I _F (mA)	I _{FP} (mA)	V _R (V)	T _{opr} (°C)	T _{stg} (°C)	Typ.	I _F	Max.	V _R	Min.*2	Typ.	Max.*2	I _F	Min.	Typ.	I _F
SMLVN6RGB1U	AlGaInP	Red	400	50	100 ^{*1}	5	-40~+85	-40~+100	2.1	20	10	5	619	624	629	20	450	700	20
	InGaN	Green		40		-			3.3		-	-	520	527	535		710	1200	
	InGaN	Blue		40		-			3.3		-	-	465	470	475		220	400	
SMLVN6RGB1W	AlGaInP	Red	400	50	100 ^{*1}	5	-40~+85	-40~+100	2.1	20	10	5	619	624	629	20	450	700	20
	InGaN	Green		40		-			3.3		-	-	520	527	535		710	1200	
	InGaN	Blue		40		-			3.3		-	-	465	470	475		220	400	

*1 : Duty ≤1/20, Pulse width ≤1ms *2 : Measurement tolerance:±2nm

■ Electrical Characteristics Curves

Reference

Fig.1 Forward Current - Forward Voltages

*The dotted line is direct current driven, above absolute maximum rating.

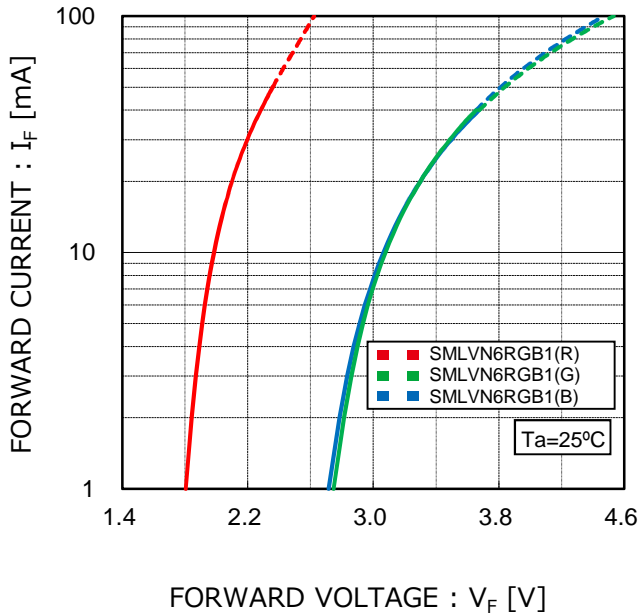

Fig.2 Luminous Intensity - Atmosphere Temperature

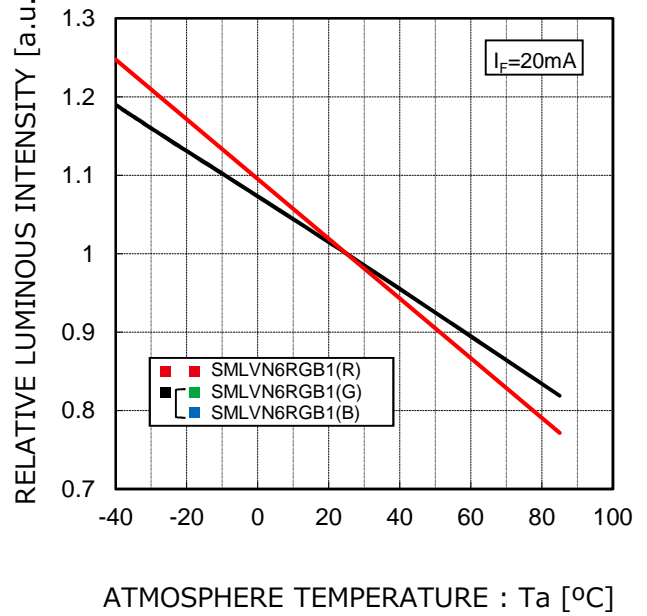

Fig.3 Luminous Intensity - Forward Current

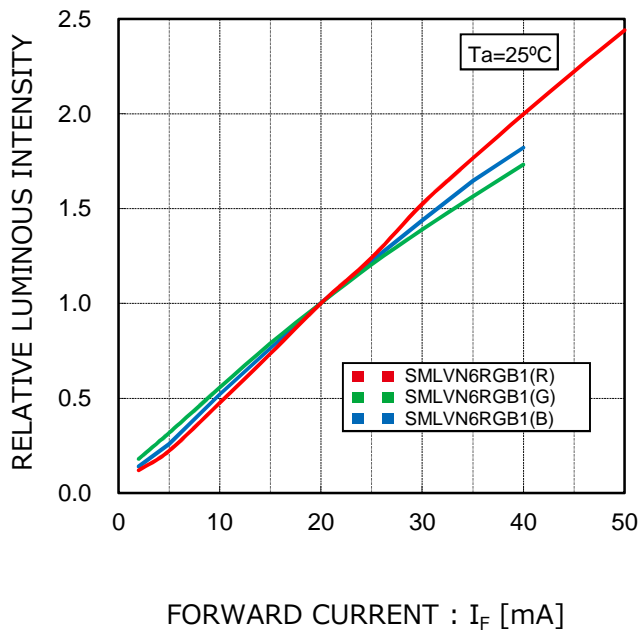
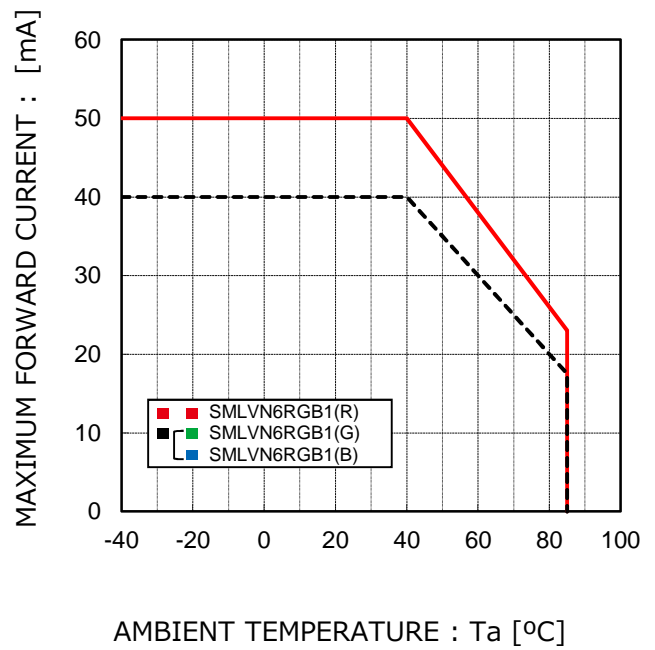
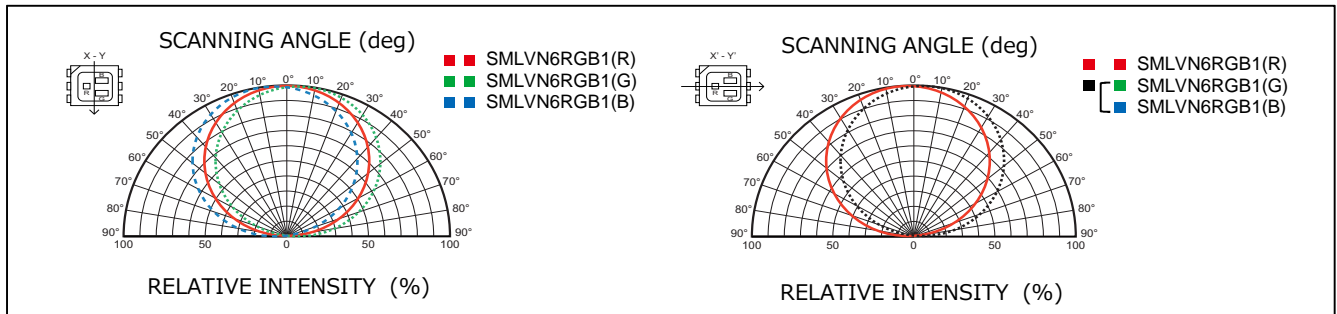

Fig.4 Derating



■ Viewing Angle

Reference



■ Rank Reference of Brightness*

*Measurement tolerance: ±10%

Triple Color

(Ta=25°C)

Emitting Color	Rank (mcd)	I _F (mA)	Y ^{*1}										
			220~280	280~360	360~450	450~560	560~710	710~900	900~1100	1100~1400	1400~1800	1800~2200	
SMLVN6RGB1U	Red	20											
	Green												
	Blue												
SMLVN6RGB1W	Red	20											
	Green												
	Blue												
	White	*3											

*1 : When lighting three colors simultaneously <to express white light>

*2 : Reference value of each colors

*3 : Rank of Mixing white color

Y Rank

$$\left(\begin{array}{l} I_F=12\text{mA (Red)} \\ I_F=15\text{mA (Green)} \\ I_F=12\text{mA (Blue)} \end{array} \right)$$

■ Chromaticity Diagram

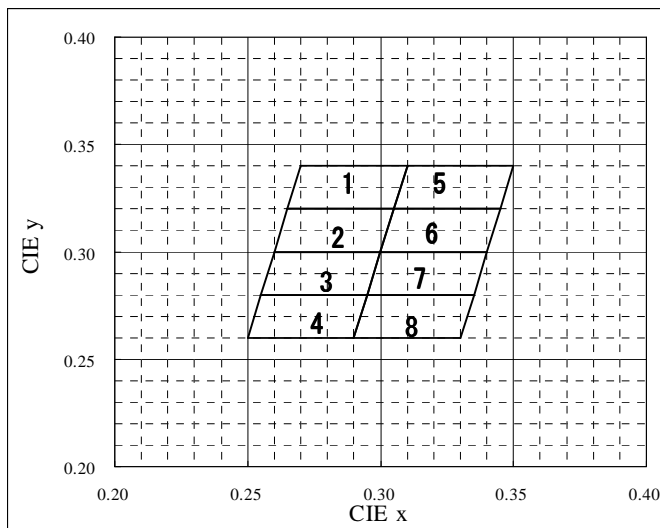

(T a = 25°C, I_f=12mA(Red) , I_f=15mA(Green) , I_f=12mA(Blue))

1		2		3		4	
X	y	X	y	X	y	X	y
0.270	0.340	0.265	0.320	0.260	0.300	0.255	0.280
0.265	0.320	0.260	0.300	0.255	0.280	0.250	0.260
0.305	0.320	0.300	0.300	0.295	0.280	0.290	0.260
0.310	0.340	0.305	0.320	0.300	0.300	0.295	0.280
5		6		7		8	
X	y	X	y	X	y	X	y
0.310	0.340	0.305	0.320	0.300	0.300	0.295	0.280
0.305	0.320	0.300	0.300	0.295	0.280	0.290	0.260
0.345	0.320	0.340	0.300	0.335	0.280	0.330	0.260
0.350	0.340	0.345	0.320	0.340	0.300	0.335	0.280

Measurement tolerance : ±0.02

■ Taping(1)

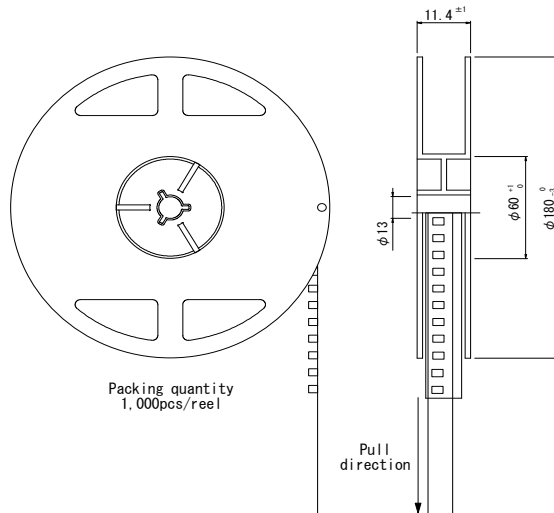
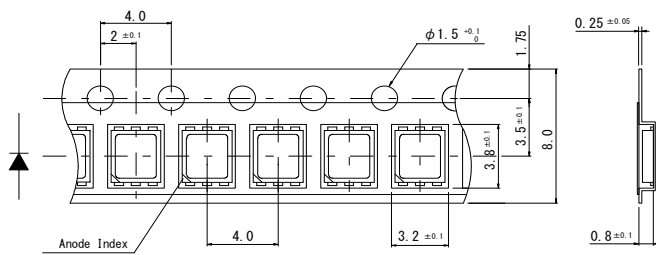

Packing quantity
1,000pcs/reel

Unit:mm

Note)Tolerance is within ±0.2mm unless otherwise specified.

■ Part No. Construction

*"-"-will be taken out for emitting color WB/B/E/RGB series.

Special Code will be applied for Emitting color WB/B/E/RGB series.

Chromaticity rank (for white LED)

Rank sign (Brightness Rank)*



Series name	Package Type	Chip type	Emitting Color	Resin	Taping Specification																																																																																															
SML Chip LED	<table border="1" style="border-collapse: collapse; width: 100%;"> <tr><td>P1</td><td>1.0x0.6 t=0.2mm</td></tr> <tr><td>E1</td><td>1.6x0.8 t=0.36mm</td></tr> <tr><td>D1</td><td>1.6x0.8 t=0.55mm</td></tr> <tr><td>H1</td><td>2.0x1.25 t=0.8mm</td></tr> <tr><td>M1</td><td>2.0x1.25 t=0.8mm</td></tr> <tr><td>O1</td><td>3.0x2.0 t=1.3mm</td></tr> <tr><td>Z1/ZN</td><td>3.5x2.8 t=1.9mm</td></tr> <tr><td>A1</td><td>1.6x1.15 t=0.55mm</td></tr> <tr><td>B1/B2</td><td>3.4x1.25 t=1.1mm</td></tr> <tr><td>K1</td><td>4.5x2.0 t=0.6mm</td></tr> <tr><td>S1</td><td>3.2x1.6 t=1.85mm</td></tr> <tr><td>P2</td><td>1.0x1.0 t=0.2mm</td></tr> <tr><td>52</td><td>1.3x1.5 t=0.6mm</td></tr> <tr><td>P34</td><td>1.0x1.0 t=0.2mm</td></tr> <tr><td>P36</td><td>1.5x1.0 t=0.2mm</td></tr> <tr><td>VN</td><td>3.5x2.8 t=0.6mm</td></tr> </table>	P1	1.0x0.6 t=0.2mm	E1	1.6x0.8 t=0.36mm	D1	1.6x0.8 t=0.55mm	H1	2.0x1.25 t=0.8mm	M1	2.0x1.25 t=0.8mm	O1	3.0x2.0 t=1.3mm	Z1/ZN	3.5x2.8 t=1.9mm	A1	1.6x1.15 t=0.55mm	B1/B2	3.4x1.25 t=1.1mm	K1	4.5x2.0 t=0.6mm	S1	3.2x1.6 t=1.85mm	P2	1.0x1.0 t=0.2mm	52	1.3x1.5 t=0.6mm	P34	1.0x1.0 t=0.2mm	P36	1.5x1.0 t=0.2mm	VN	3.5x2.8 t=0.6mm	<table border="1" style="border-collapse: collapse; width: 100%;"> <tr><td>0</td><td>Standard Type</td></tr> <tr><td>1</td><td>Low Current Type</td></tr> <tr><td>2</td><td>High Brightness type</td></tr> <tr><td>3</td><td rowspan="6">Ultra High Brightness type</td></tr> <tr><td>4</td></tr> <tr><td>5</td></tr> <tr><td>6</td></tr> <tr><td>7</td></tr> <tr><td>8</td></tr> </table>	0	Standard Type	1	Low Current Type	2	High Brightness type	3	Ultra High Brightness type	4	5	6	7	8	<table border="1" style="border-collapse: collapse; width: 100%;"> <tr><td>V</td><td>Red</td></tr> <tr><td>U</td><td>Red</td></tr> <tr><td>U2</td><td>Red</td></tr> <tr><td>D</td><td>Orange</td></tr> <tr><td>Y3</td><td>Yellow</td></tr> <tr><td>Y2</td><td>Yellow</td></tr> <tr><td>Y</td><td>Yellow</td></tr> <tr><td>W</td><td>Yellow</td></tr> <tr><td>M2</td><td>Yellowish green</td></tr> <tr><td>M</td><td>Yellowish green</td></tr> <tr><td>F</td><td>Green</td></tr> <tr><td>P</td><td>Green</td></tr> <tr><td>E</td><td>Green</td></tr> <tr><td>B</td><td>Blue</td></tr> <tr><td>WB</td><td>White</td></tr> <tr><td>T</td><td>Phototransistors</td></tr> <tr><td>RGB</td><td>Red/Green/Blue</td></tr> </table>	V	Red	U	Red	U2	Red	D	Orange	Y3	Yellow	Y2	Yellow	Y	Yellow	W	Yellow	M2	Yellowish green	M	Yellowish green	F	Green	P	Green	E	Green	B	Blue	WB	White	T	Phototransistors	RGB	Red/Green/Blue	<table border="1" style="border-collapse: collapse; width: 100%;"> <tr><td>U</td><td>Silicone</td></tr> <tr><td>W</td><td>Epoxy</td></tr> </table>	U	Silicone	W	Epoxy	<table border="1" style="border-collapse: collapse; width: 100%;"> <tr><td>T86</td><td>Cathode at sprocket hole side(the top)</td></tr> <tr><td>T87</td><td>Anode at sprocket hole side(the top)</td></tr> <tr><td>1</td><td>For white LED,</td></tr> <tr><td>3</td><td>csthode at sprocket hole side</td></tr> </table> <p style="font-size: small;">notice) S1 series, 81 seires</p> <table border="1" style="border-collapse: collapse; width: 100%;"> <tr><td>T86</td><td>Cathode at sprocket hole side(the back)</td></tr> <tr><td>T68</td><td>Cathode at sprocket hole side(the top)</td></tr> </table>	T86	Cathode at sprocket hole side(the top)	T87	Anode at sprocket hole side(the top)	1	For white LED,	3	csthode at sprocket hole side	T86	Cathode at sprocket hole side(the back)	T68	Cathode at sprocket hole side(the top)
P1	1.0x0.6 t=0.2mm																																																																																																			
E1	1.6x0.8 t=0.36mm																																																																																																			
D1	1.6x0.8 t=0.55mm																																																																																																			
H1	2.0x1.25 t=0.8mm																																																																																																			
M1	2.0x1.25 t=0.8mm																																																																																																			
O1	3.0x2.0 t=1.3mm																																																																																																			
Z1/ZN	3.5x2.8 t=1.9mm																																																																																																			
A1	1.6x1.15 t=0.55mm																																																																																																			
B1/B2	3.4x1.25 t=1.1mm																																																																																																			
K1	4.5x2.0 t=0.6mm																																																																																																			
S1	3.2x1.6 t=1.85mm																																																																																																			
P2	1.0x1.0 t=0.2mm																																																																																																			
52	1.3x1.5 t=0.6mm																																																																																																			
P34	1.0x1.0 t=0.2mm																																																																																																			
P36	1.5x1.0 t=0.2mm																																																																																																			
VN	3.5x2.8 t=0.6mm																																																																																																			
0	Standard Type																																																																																																			
1	Low Current Type																																																																																																			
2	High Brightness type																																																																																																			
3	Ultra High Brightness type																																																																																																			
4																																																																																																				
5																																																																																																				
6																																																																																																				
7																																																																																																				
8																																																																																																				
V	Red																																																																																																			
U	Red																																																																																																			
U2	Red																																																																																																			
D	Orange																																																																																																			
Y3	Yellow																																																																																																			
Y2	Yellow																																																																																																			
Y	Yellow																																																																																																			
W	Yellow																																																																																																			
M2	Yellowish green																																																																																																			
M	Yellowish green																																																																																																			
F	Green																																																																																																			
P	Green																																																																																																			
E	Green																																																																																																			
B	Blue																																																																																																			
WB	White																																																																																																			
T	Phototransistors																																																																																																			
RGB	Red/Green/Blue																																																																																																			
U	Silicone																																																																																																			
W	Epoxy																																																																																																			
T86	Cathode at sprocket hole side(the top)																																																																																																			
T87	Anode at sprocket hole side(the top)																																																																																																			
1	For white LED,																																																																																																			
3	csthode at sprocket hole side																																																																																																			
T86	Cathode at sprocket hole side(the back)																																																																																																			
T68	Cathode at sprocket hole side(the top)																																																																																																			
SCM Chip LED	<table border="1" style="border-collapse: collapse; width: 100%;"> <tr><td>01</td><td>3.0x1.5 t=2.2mm</td></tr> </table>	01	3.0x1.5 t=2.2mm																																																																																																	
01	3.0x1.5 t=2.2mm																																																																																																			

*Concerning the Brightness rank.
 *Please refer to the rank chart above for luminous intensity classification.
 *Part name is individual for each rank.
 *When shipped as sample,the part name will be a representative part name.
 General products are free of ranks.
 Please contact sales if rank appointment is needed.

■ Packing Specification

ROHM LED products are being shipped with desiccant (silica gel) included in moisture-proof bags. Pasting the moisture sensitive label on the outer surface of the moisture-proof bags or enclosing the humidity indication card inside the bag is available upon request. Please contact the nearest sales office or distributor if necessary.

■ Precaution (Surface Mount Device)

1. Storage

If the product is heated during the reflow under the condition of hygroscopic state, it may vaporize and expand which will influence the performance of the product.

Therefore, the package is waterproof. Please use the product following the conditions:

•Using Conditions

Classification	Temperature	Humidity	Expiration Date	Remark
①Before using	5~30℃	30~70%RH	Within 1 year from Receiving	Storage with waterproof package
②After opening package	5~30℃	Below 70%RH	Within 72h	Please storing in the airtight container with our desiccant (silica gel)

•Baking

Bake the product in case of below:

①The expiration date is passed.

②The color of indicator (silica gel) turned from blue to colorless or from green to pink.

(Even if the product is within the expiration date.)

•Baking Conditions

Temperature	Time	Humidity
60±3℃	40~48h	Below 20%RH
Remark	<ul style="list-style-type: none"> •Bake products in reel. •Reel and embossed tape are easy to be deformed when baking, so please try not to apply stress on it. •Recommend bake once. 	

2. Application Methods

2 – 1. Precaution for Drive System and Off Mode

Design the circuit without the electric load exceeding the ABSOLUTE MAXIMUM RATING that applies on the products. If drive by constant voltage, it may cause current deviation of the LED and result in deviation of luminous intensity, so we recommend to drive by constant current.

(Deviation of VF Value will cause deviation of current in LED.) Furthermore, for off mode, please do not apply voltage neither forward nor reverse. Especially, for the products with the Ag-paste used in the die bonding, there's high possibility to cause electro migration and result in function failure.

2 – 2. About Derating

It is considered that derating characteristics will not result in LED chip's electrical destruction. Even within the derating, the reliability and luminous life can be affected depending on operating conditions and ambient environment. So we would be appreciate it if you can confirm with your application again.

2 – 3. About product life

Depending on operating conditions and environment(applied current, ambient temperature and humidity, corrosive gas), decreasing of luminosity and change of chromaticity may occur even within the specification conditions.

Please contact our sales office if you use it for the following applications.

①It requires long luminosity life

②It is always lit

2 – 4. Applied Stress on Product

The top of the LED is very soft, which the silicon resin is used as sealing resin.

Therefore, please pay attention to the overstress on it which may influence its reliability.

2 – 5. Usage

The Product is LED. We are not responsible for the usage as the diode such as Protection Chip, Rectifier, Switching and so on.

3. Others

3 – 1. Surrounding Gas

Notice that if it is stored under the condition of acid gas (chlorine gas, sulfured gas) or alkali gas (ammonia), it may result in low soldering ability (caused by the change in quality of the plating surface) or optical characteristics changes (light intensity, chrominance) and change in quality of cause die bonding (Ag-paste) materials. All of the above will function failure of the products.

Therefore, please pay attention to the storage environment for mounted product (concern the generated gas of the surrounding parts of the products and the atmospheric environment).

3 – 2. Electrostatic Damage

The product is part of semiconductor and electrostatic sensitive, there's high possibility to be damaged by the electrostatic discharge. Please take appropriate measures to avoid the static electricity from human body and earthing of production equipment. Especially, InGaN type LEDs have lower resistance value of electrostatic discharge and it is recommended to introduce the ESD protection circuit.

The resistance values of electrostatic discharge (actual values) vary with products, therefore, please call our Sales staffs for inquiries.

3 – 3. Electromagnetic Wave

Applications with strong electromagnetic wave such as, IH cooker, will influence the reliability of LED, therefore please evaluate before using it.

4. Mounting

4-1. Soldering

- No resin hardening agent such as filler is used in the sealing resin of the product. Therefore, resin expansion and moisture absorption at humidity will cause heat stress during soldering process and finally has bad influence on the product's reliability.
- The product is not guaranteed for flow soldering.
- Do not expose the product in the environment of high temperature (over 100°C) or rapid temperature shift (within 3°C/sec. of temperature gradient) during the flow soldering of surrounding parts. In case of carrying out flow soldering of surrounding parts without recommended conditions, please contact us for inquiries.
- Please set appropriate reflow temperature based on our product usage conditions and specification.
- The max for reflowing is 2 times, please finish the second reflow soldering and flow soldering with other parts within the usage limitation after open the moistureproof package.
- Compare with N2 reflow, during air reflow, because of the heat and surrounding conditions, it may cause the discoloration of the resin.
- For our product that has no solder resist, because of its solder amount and soldering conditions, one of its specific characteristics is that solder will penetrate into LED. Thus, there's high possibility that will influence its reliability. Therefore, please be informed, concerning it before using it.

4-2. Automatic Mounting

4-2-1. Silicon Resin Sealing Product

The sealing resin of LED is very soft, so please select adsorption nozzle that would not apply stress directly on the sealing section.

4-2-2. Mini Package (Smaller than 1608 size)

- Vibration may result in low mounting rate since it will cause the static electricity of product and adhere to top cover tape. Therefore, the magnet should be set on parts feeder cassette of the mounter to control the product stabilization. In addition, it is recommended to set ionizer to prevent electrostatic charge.

4-3. Mounting Location

The stress like bending stress of circuit board dividing after mounting, may cause LED package crack or damage of LED internal junction, therefore, please concern the mounting direction and position to avoid bending or screwing with great stress of the circuit board.

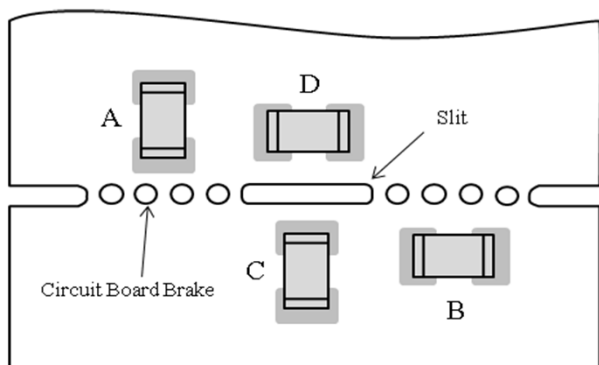

Stress strength according to the mounting position:
A > B > C > D

4-4. Mechanical Stress after Mounting

The mechanical stress may damage the LED after Circuit Mounting, so please pay attention to the touch on product.

4-5. Soldering Pattern for Recommendation

We recommend the soldering pattern that shows on the right. It will be different according to mounting situation of circuit board, therefore, please concern before designing.

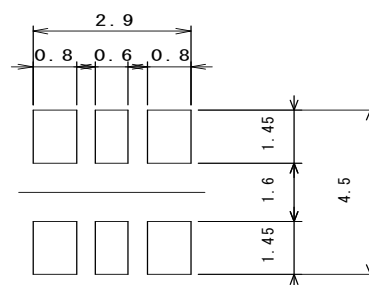

(Unit : mm)

4 – 6. Reflow Profile

For reflow profile, please refer to the conditions below:(※)

■ Meaning of marks, Conditions

Mark	Meanings	Conditions
T _{Smax}	Maximum of pre-heating temperature	180°C
T _{Smin}	Minimum of pre-heating temperature	140°C
t _s	Time from T _{Smin} to T _{Smax}	Over 60sec.
T _L	Reference temperature	230~260°C
t _L	Retention time for T _L	Within 40sec.
T _P	Peak temperature	260°C(Max)
t _p	Time for peak temperature	Within 10sec.
ΔT _R /Δt	Temperature rising rate	Under 3°C/sec.
ΔT _D /Δt	Temperature decreasing rate	Over -3°C/sec.

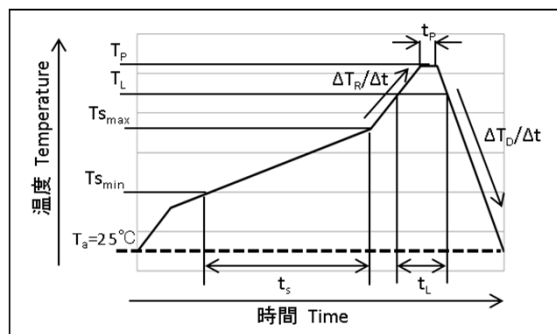

※Above conditions are for reference. Therefore, evaluate by customer’s own circuit boards and reflow furnaces before using, because stress from circuit boards and temperature variations of reflow furnaces vary by customer’s own conditions.

4 – 7. Attention Points in Soldering Operation

This product was developed as a surface mount LED especially suitable for reflow soldering. So reflow soldering is recommended. In case of implementing manual soldering, please take care of following points.

①SOLDER USED

Sn-Cu, Sn-Ag-Cu, Sn-Ag-Bi-Cu

②HAND SOLDERING CONDITION

LED products do not contain reinforcement material such as a glass fillers.

So thermal stress by soldering greatly influence its reliability.

Please keep following points for manual soldering.

	ITEM	RECOMMENDED CONDITION
a)	Heating method	Condition) Temp. of iron top less than 400°C within 3 sec. Heating on PCB pattern, not direct to the LED. (Fig-1)
b)	Handling after soldering	Please handle after the part temp. goes down to room temp.

Fig.1

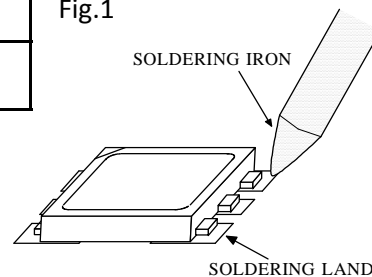

4 – 8. Cleaning after Soldering

Please follow the conditions below if the cleaning is necessary after soldering.

Solvent	We recommend to use alcohols solvent such as, isopropyl alcohols
Temperature	Under 30°C within 3 minutes
Ultrasonic Cleaning	15W/ Below 1 liter (capacity of tank)
Drying	Under 100°C within 3 minutes

Notes

- 1) The information contained herein is subject to change without notice.
- 2) Before you use our Products, please contact our sales representative and verify the latest specifications :
- 3) Although ROHM is continuously working to improve product reliability and quality, semiconductors can break down and malfunction due to various factors.
Therefore, in order to prevent personal injury or fire arising from failure, please take safety measures such as complying with the derating characteristics, implementing redundant and fire prevention designs, and utilizing backups and fail-safe procedures. ROHM shall have no responsibility for any damages arising out of the use of our Products beyond the rating specified by ROHM.
- 4) Examples of application circuits, circuit constants and any other information contained herein are provided only to illustrate the standard usage and operations of the Products. The peripheral conditions must be taken into account when designing circuits for mass production.
- 5) The technical information specified herein is intended only to show the typical functions of and examples of application circuits for the Products. ROHM does not grant you, explicitly or implicitly, any license to use or exercise intellectual property or other rights held by ROHM or any other parties. ROHM shall have no responsibility whatsoever for any dispute arising out of the use of such technical information.
- 6) The Products are intended for use in general electronic equipment (i.e. AV/OA devices, communication, consumer systems, gaming/entertainment sets) as well as the applications indicated in this document.
- 7) The Products specified in this document are not designed to be radiation tolerant.
- 8) For use of our Products in applications requiring a high degree of reliability (as exemplified below), please contact and consult with a ROHM representative : transportation equipment (i.e. cars, ships, trains), primary communication equipment, traffic lights, fire/crime prevention, safety equipment, medical systems, servers, solar cells, and power transmission systems.
- 9) Do not use our Products in applications requiring extremely high reliability, such as aerospace equipment, nuclear power control systems, and submarine repeaters.
- 10) ROHM shall have no responsibility for any damages or injury arising from non-compliance with the recommended usage conditions and specifications contained herein.
- 11) ROHM has used reasonable care to ensure the accuracy of the information contained in this document. However, ROHM does not warrant that such information is error-free, and ROHM shall have no responsibility for any damages arising from any inaccuracy or misprint of such information.
- 12) Please use the Products in accordance with any applicable environmental laws and regulations, such as the RoHS Directive. For more details, including RoHS compatibility, please contact a ROHM sales office. ROHM shall have no responsibility for any damages or losses resulting from non-compliance with any applicable laws or regulations.
- 13) When providing our Products and technologies contained in this document to other countries, you must abide by the procedures and provisions stipulated in all applicable export laws and regulations, including without limitation the US Export Administration Regulations and the Foreign Exchange and Foreign Trade Act.
- 14) This document, in part or in whole, may not be reprinted or reproduced without prior consent of ROHM.



Thank you for your accessing to ROHM product informations.
More detail product informations and catalogs are available, please contact us.

ROHM Customer Support System

<http://www.rohm.com/contact/>

Mouser Electronics

Authorized Distributor

Click to View Pricing, Inventory, Delivery & Lifecycle Information:

[ROHM Semiconductor:](#)

[SMLVN6RGB1W1](#) [SMLVN6RGB1U1](#)



Компания «ЭлектроПласт» предлагает заключение долгосрочных отношений при поставках импортных электронных компонентов на взаимовыгодных условиях!

Наши преимущества:

- Оперативные поставки широкого спектра электронных компонентов отечественного и импортного производства напрямую от производителей и с крупнейших мировых складов;
- Поставка более 17-ти миллионов наименований электронных компонентов;
- Поставка сложных, дефицитных, либо снятых с производства позиций;
- Оперативные сроки поставки под заказ (от 5 рабочих дней);
- Экспресс доставка в любую точку России;
- Техническая поддержка проекта, помощь в подборе аналогов, поставка прототипов;
- Система менеджмента качества сертифицирована по Международному стандарту ISO 9001;
- Лицензия ФСБ на осуществление работ с использованием сведений, составляющих государственную тайну;
- Поставка специализированных компонентов (Xilinx, Altera, Analog Devices, Intersil, Interpoint, Microsemi, Aeroflex, Peregrine, Syfer, Eurofarad, Texas Instrument, Miteq, Cobham, E2V, MA-COM, Hittite, Mini-Circuits, General Dynamics и др.);

Помимо этого, одним из направлений компании «ЭлектроПласт» является направление «Источники питания». Мы предлагаем Вам помощь Конструкторского отдела:

- Подбор оптимального решения, техническое обоснование при выборе компонента;
- Подбор аналогов;
- Консультации по применению компонента;
- Поставка образцов и прототипов;
- Техническая поддержка проекта;
- Защита от снятия компонента с производства.



Как с нами связаться

Телефон: 8 (812) 309 58 32 (многоканальный)

Факс: 8 (812) 320-02-42

Электронная почта: org@eplast1.ru

Адрес: 198099, г. Санкт-Петербург, ул. Калинина, дом 2, корпус 4, литера А.