

General Description

The MAX44299 evaluation kit (EV kit) provides a proven design to evaluate the MAX44299 current, voltage, and power monitor. The device offers a precision power monitor with very low offset for low-side monitoring. This EV kit demonstrates the MAX44299 in an ultra-small, 2.4mm x 2.4mm, 16-bump wafer-level package (WLP) with 0.5mm bump spacing.

The EV kit PCB is preconfigured with the CSA full-scale input voltage range (V_{SENSE}) of 10mV and 100 μ A of output current ranges, but can be reconfigured to 10mV/5mV of FS V_{SENSE} or 50 μ A of output current by changing a few jumpers.

The EV kit comes with a MAX44299EWE+ and a voltage divider to provide a forced full-scale V_{SENSE} of 10mV range at the CSA inputs installed.

Features

- Precision Real-Time, Low-Side Current/Voltage/Power Monitoring
- +3V to +5.5V Single-Supply Voltage Range
- Proven PCB Layout
- Fully Assembled and Tested

Ordering Information appears at end of data sheet.

Quick Start

Required Equipment

Before beginning, the following equipment is needed:

- MAX44299 EV kit
- +3V to +5.5V, 100mA DC power supply
- +0.4V to +1.005V DC power supply
- Precision DC voltage source
- Five digital multimeters (DMMs)

Procedure

The EV kit is fully assembled and tested. Follow the steps below to verify board operation. **Caution: Do not turn on power supply until all connections are made.**

- 1) Set the +3V to +5.5V supply to +3.3V and turn it off. Connect the positive terminal of the supply to the V_{DD} test point and the negative terminal of the supply to the nearest GND test point.
- 2) Set the +0.4V to +1.005V supply to +1V and turn it off. Connect the positive terminal of the supply to the V_{IN} test point and the negative terminal of the supply to the nearest GND test point.
- 3) Set the precision DC voltage source to 5mV and turn it off. Apply this voltage source across the V_{SENSE} inputs as a forced voltage V_{SENSE} (i.e., connect the positive terminal of the DC voltage source to the RS+ test point and connect its negative terminal to the RS- test point).
- 4) Connect one DMM across RS+ and RS- to monitor the V_{SENSE} input. Connect each DMM to each output of the device (I_{OUT} , V_{OUT} , P_{OUT} , and REF) to monitor the output voltages.
- 5) Enable all supplies.
- 6) Observe the output voltage from all four digital voltmeter displays. Verify that $V_{I_{OUT}} = 1.2V$, $V_{V_{OUT}} = 2.4V$, $V_{P_{OUT}} = 1.2V$ and $V_{REF} = 2.4V$.

Table 1. Jumper Description

JUMPER	SHUNT POSITION	DESCRIPTION
JU1 (I _{SET})	1-2	Sets the full-scale output current to 50μA.
	1-3	Reserved
	1-4*	Sets the full-scale output current to 100μA.
JU2 (CAL)	1-2	Enters calibration mode, sets the output current to 10μA (for I _{OUT} , V _{OUT} , and P _{OUT}) and full-scale output current set by JU1 (for the REF).
	1-3	Reserved
	1-4*	Sets the device in normal operation mode and the output current full scale is set by JU1.
JU3 (G0)	1-2	Connects G0 to logic 1 to set the full-scale sensing voltage range (V _{FS}). See Table 2.
	1-3	Reserved
	1-4*	Connects G0 to logic 0 to set the full-scale sensing voltage range (V _{FS}). See Table 2.
JU4 (G1)	1-2*	Connect G1 to logic1 to set the full-scale sensing voltage range (V _{FS}). See Table 2.
	2-3	Reserved
	1-4	Connect G1 to logic 0 to set the full-scale sensing voltage range (V _{FS}). See Table 2.

*Default configuration

Table 2. Full-Scale V_{SENSE} Range Selection

G1 (JU4)	G0 (JU3)	FS V _{SENSE}	R _{SENSE} = 1mΩ	R _{SENSE} = 2mΩ	R _{SENSE} = 10mΩ
0	1	5mV	5A	2.5A	0.5A
1*	0*	10mV*	10A	5A	1A
1	1	20mV	20A	10A	2A
0	0	Device enters power-down mode			

*Default configuration

Detailed Description of Hardware

The MAX44299 EV kit low-side current-sensing measures the load current by using a precision CSA, allowing accurate full-scale V_{SENSE} ranges of 5mV, 10mV, and 20mV, providing scaled output current at I_{OUT}. The floating source voltage is measured through a user-selectable resistive-divider (dividing the source input voltage down to a full-scale V_{IN} of 1.00V) and provides scaled output current at V_{OUT}. The device monitors the instantaneous input power by internally multiplying the scaled load current by a scaled fraction of the load voltage, providing scaled output current at P_{OUT}. The device also provides a reference output current at the REF output. All four output currents are converted to voltages by using scaled resistors (R3–R6).

Output-Scaling Resistors: R3, R4, R5, R6, and the I_{SET} Input

The output-scaling resistors should all be the same value and be of a type with very low temperature coefficients, with metal film types being recommended. Metal foil is more effective, though significantly more expensive. The chosen values of these resistors will depend on the I_{SET} setting. JU1 determines the full-scale output current range. When I_{SET} is connected to ground (JU1: 1-2), the full-scale output current from all four outputs will be 100μA. When I_{SET} is connected to V_{DD} (JU1: 1-4), the full-scale current will be 50μA. This can be a simple and convenient way to change all four scaling resistors simultaneously. The EV kit is shipped with all four 24kΩ scaling resistors.

Calibration

JU2 sets the device in operational mode (or CAL) mode. The EV kit is shipped with JU2 in 1-4 position for operational mode. Set JU2 in 1-2 position to place the device in CAL mode.

Applying the Source Voltage

The two options for applying source voltage are through an external voltage divider (R1 and R2) or as a direct voltage input (V_{IN}). For using an R1–R2 voltage-divider: apply the source voltage to IN+ and IN-. For a maximum input source voltage of say 57V, R1 could be 560k Ω with R2 being 10k Ω . The voltage-divider, formed by R1 and R2, provides 1V at the V_{IN} input test point. The second option is to apply the voltage directly to the V_{IN} test point. In either configuration, care must be taken not to apply a voltage greater than 1V to the V_{IN} input of the device. The EV kit is shipped with the voltage-divider formed by R1 (560k Ω) and R2 (10k Ω), and a V_{IN} test point as well.

Measuring the Low-Side Load Current

The device measures the unidirection load current (flowing from RS+ to RS-) as a voltage drop (V_{SENSE}) across an external sense resistor (R14, not installed) and provides scaled output at I_{OUT} . To ensure proper load current measurements, the sense resistor must be chosen so that its voltage drop does not exceed the full-scale sense voltage of the device. The full-scale sense voltage should be reached when the full-scale load current is being supplied to the load. The external sense resistor R14 is determined by setting the full-scale load current and selecting a full-scale sense voltage that does not exceed the full-scale sense-voltage rating of the IC:

$$R_{14} = \frac{V_{SENSE_FS}}{I_{LOAD_FS}}$$

The EV kit supports a full-scale sense voltage drop of 5mV, 10mV, and 20mV (see [Table 2](#) for selections). The EV kit defaults to the 10mV full-scale setting. For different full-scale sense ranges and full-scale load current arrangements, the equation above can be used to determine the appropriate sense-resistor value.

Other options to evaluate the current-sensing capability of the MAX44299 are to create a voltage across RS+ and RS- without applying heavy load current going through these two test points. Apply a negative voltage to the V_{NEG} test point (using the resistive-divider R12 and R13) or a direct precision voltage source across RS+ and RS-. In either case, ensure that the sense voltage across RS+ and RS- is within its set full-scale range. The device is shipped with a voltage-divider formed by R12 = 4.99k Ω and R13 = 10 Ω . When using this option, the users should note that there exists approximately 100 μ A bias current coming out of the RS- pin due to the CSA internal gain settings. This input bias current should be taken into account for error when sensing small currents in milli-ampere ranges. Therefore, measuring the actual drop across RS+ and RS- is necessary for accuracy. For example, applying a negative supply voltage of -5V at the V_{NEG} test point would give about 9mV across RS+ and RS- instead of 10mV, theoretically.

For 5mV and 20mV full-scale sense ranges, R12 and R13 should be re-scaled accordingly.

Monitoring the Load Power

The device monitors the instantaneous input power by internally multiplying the scaled load current and a scaled fraction of the load voltage and provides scaled output at P_{OUT} .

Component List, PCB Layout, and Schematic

See the following links for component information, PCB layout diagrams, and schematic.

- [MAX44299 EV BOM](#)
- [MAX44299 EV PCB Layout](#)
- [MAX44299 EV Schematic](#)

Ordering Information

PART	TYPE
MAX44299EVKIT#	EV Kit

#RoHS-compliant

Revision History

REVISION NUMBER	REVISION DATE	DESCRIPTION	PAGES CHANGED
0	3/16	Initial release	—

For pricing, delivery, and ordering information, please contact Maxim Direct at 1-888-629-4642, or visit Maxim Integrated's website at www.maximintegrated.com.

Maxim Integrated cannot assume responsibility for use of any circuitry other than circuitry entirely embodied in a Maxim Integrated product. No circuit patent licenses are implied. Maxim Integrated reserves the right to change the circuitry and specifications without notice at any time.

TITLE: Bill of Materials

DATE: 11/02/2015

DESIGN: max44299_evkit_a

NOTE: DNI--> DO NOT INSTALL ; DNP--> DO NOT PROCURE

ITEM	REF_DES	DNI/DNP	QTY	MFG PART #	MANUFACTURER	VALUE	DESCRIPTION	COMMENTS
1	C3-C6	-	4	C0603X7R500103JNP; C0603C103J5	KEMET	0.01UF	CAPACITOR; SMT (0603); CERAMIC CHIP; 0.01UF; 50V; TOL=5%; MODEL=X7R; TG=-55 DEGC TO +125 DEGC; TC=+/-	
2	C7	-	1	CGA5L1C0G2A683J160	TDK	0.068UF	CAPACITOR; SMT (1206); CERAMIC CHIP; 0.068UF; 100V; TOL=5%; TG=-55 DEGC TO +125 DEGC; TC=C0G AUTO	
3	C8	-	1	GCM3195C2A103JA16D	MURATA	0.01UF	CAPACITOR; SMT (1206); CERAMIC CHIP; 0.01UF; 100V; TOL=5%; MODEL=; TG=-55 DEGC TO +125 DEGC; TC=C0G	
4	C10	-	1	ECJ-1VB1H104K; GRM188R71H104KA; CGJ3E2X7R1H104K080AA; C1608X7R1H104K080AA	PANASONIC/MURATA/ TDK	0.1UF	CAPACITOR; SMT (0603); CERAMIC CHIP; 0.1UF; 50V; TOL=10%; TG=-55 DEGC TO +125 DEGC; TC=X7R;	
5	C11	-	1	C1608X5R1E475K080AC	TDK	4.7UF	CAPACITOR; SMT (0603); CERAMIC CHIP; 4.7UF; 25V; TOL=10%; MODEL=C SERIES; TG=-55 DEGC TO +85 DEGC; TC=X5R	
6	C13	-	1	C0603C100K1GAC	KEMET	10PF	CAPACITOR; SMT (0603); CERAMIC CHIP; 10PF; 100V; TOL=10%; MODEL=C0G; TG=-55 DEGC TO +125 DEGC; TC=+/-	
7	CF, VIN, IOUT, POUT, VOUT, VREF	-	6	5000	KEYSTONE	N/A	TEST POINT; PIN DIA=0.1IN; TOTAL LENGTH=0.3IN; BOARD HOLE=0.04IN; RED; PHOSPHOR BRONZE WIRE SILVER PLATE FINISH;	

8	IN+, IN-, LOAD+, LOAD-	-	4	108-0740-001	EMERSON NETWORK POWER	108-0740- 001	CONNECTOR; MALE; PANELMOUNT; BANANA JACK; STRAIGHT; 1PIN
9	JU1-JU4	-	4	PEC04SAAN	SULLINS ELECTRONICS CORP.	PEC04SAAN	CONNECTOR; MALE; THROUGH HOLE; BREAKAWAY; STRAIGHT; 4PINS
10	R1	-	1	1-1879417-3; CPF0603B560KE	TE CONNECTIVITY	560K	RESISTOR; 0603; 560K OHM; 0.1%; 25PPM; 0.063W; THIN FILM
11	R2	-	1	TNPW060310K0BE; RN731JTDD1002B	VISHAY DALE/KOA SPEER ELECTRONICS	10K	RESISTOR; 0603; 10K OHM; 0.1%; 25PPM; 0.1W; THICK FILM
12	R3-R6	-	4	RG1608P-243-B	SUSUMU CO LTD.	24K	RESISTOR; 0603; 24K OHM; 0.1%; 25PPM; 0.1W; THIN FILM
13	R7-R10	-	4	ERJ-3GEYJ472V	PANASONIC	4.7K	RESISTOR; 0603; 4.7K OHM; 5%; 200PPM; 0.10W; THICK FILM
14	R12	-	1	RG1608P-4991-B	SUSUMU CO LTD.	4.99K	RESISTOR; 0603; 4.99K OHM; 0.1%; 25PPM; 0.1W; THIN FILM
15	R13	-	1	CRT0603-BY-10R0ELF	BOURNS	10	RESISTOR; 0603; 10 OHM; 0.1%; 25PPM; 0.063W; THIN FILM
16	R15, R18	-	2	CRCW06030000Z0	VISHAY DALE	0	RESISTOR; 0603; 0 OHM; 0%; JUMPER; 0.1W; THICK FILM
17	RS+, RS-, VDD, VNEG	-	4	5010 ?		5010	TESTPOINT WITH 1.80MM HOLE DIA, RED, MULTIPURPOSE
18	SU4-SU7	-	4	STC02SYAN	SULLINS ELECTRONICS CORP.	STC02SYAN	TEST POINT; JUMPER; STR; TOTAL LENGTH=0.256IN; BLACK; INSULATION=PBT CONTACT=PHOSPHOR BRONZE; COPPER PLATED TIN OVERALL
19	TP1-TP4, TP6	-	5	5011 ?		5011	TEST POINT; PIN DIA=0.125IN; TOTAL LENGTH=0.445IN; BOARD HOLE=0.063IN; BLACK; PHOSPHOR BRONZE WIRE SILVER PLATE FINISH;

20	U1	-	1	MAX44299	MAXIM	MAX44299	EVKIT PART-IC; PACKAGE CODE: WLP162P2+1; DOC NO: 21-1000005	
21	C9	DNP	1	ECJ-1VB1H104K; GRM188R71H104KA; CGJ3E2X7R1H104K080AA; C1608X7R1H104K080AA	PANASONIC/MURATA/TDK	0.1UF	CAPACITOR; SMT (0603); CERAMIC CHIP; 0.1UF; 50V; TOL=10%; TG=-55 DEGC TO +125 DEGC; TC=X7R;	OPEN
22	C17, C41	DNP	2	GRM32ER72A225KA35; CGA6N3X7R2A225K230	MURATA/TDK	2.2UF	CAPACITOR; SMT (1210); CERAMIC CHIP; 2.2UF; 100V; TOL=10%; MODEL=GRM SERIES; TG=-55 DEGC to +125 DEGC; TC=X7R	OPEN
23	C18, C42	DNP	2	C0805C104J1RAL	KEMET	0.1UF	CAPACITOR; SMT; 0805; CERAMIC; 0.1uF; 100V; 5%; X7R; -55degC to + 125degC	OPEN
24	FB3	DNP	1	BLM18BD252SN1	MURATA	2500	INDUCTOR; SMT (0603); FERRITE-BEAD; 2500; TOL=+/-25%; 0.05A	OPEN
25	R11	DNP	1	TNPW060310K0BE; RN731JTDD1002B	VISHAY DALE/KOA SPEER ELECTRONICS	10K	RESISTOR; 0603; 10K OHM; 0.1%; 25PPM; 0.1W; THICK FILM	OPEN
26	R14	DNP	1	Y14880R00100D9	VISHAY FOIL RESISTOR	0.001	RESISTOR; 3637; 0.001 OHM; 0.5%; 25PPM; 3W; METAL FOIL	OPEN
27	R16	DNP	1	TNPW060320R0BE	VISHAY DALE	20	RESISTOR; 0603; 20 OHM; 0.1%; 25PPM; 0.10W; THICK FILM	OPEN
28	R17	DNP	1	PATT0603E8982BG	VISHAY DALE	89.8K	RESISTOR; 0603; 89.8K OHM; 0.1%; 25PPM; 0.15W; THIN FILM	OPEN
29	SU1-SU3	DNP	3	801-93-010-10-001000	MILL-MAX	801-93-010-10-001000	IC-SOCKET;SIP; STANDARD SOLDER TAIL; 801 SERIES; 0.024D/0.118L; 0.1IN GRID; STRAIGHT SOCKET; OPEN FRAME; 10PINS	OPEN
30	TP5	DNP	1	5011 ?		5011	TEST POINT; PIN DIA=0.125IN; TOTAL LENGTH=0.445IN; BOARD HOLE=0.063IN; BLACK; PHOSPHOR BRONZE WIRE SILVER PLATE FINISH;	OPEN

31	U2	DNP	1	MAX44285TAUA+	MAXIM	MAX44285T AUA+	IC; AMP; DUAL-CHANNEL; HIGH-PRECISION; HIGH- VOLTAGE; CURRENT- SENSE AMPLIFIER; GAIN=20V/V; UMAX8	OPEN
32	VCC	DNP	1	5010 ?		5010	TESTPOINT WITH 1.80MM HOLE DIA, RED, MULTIPURPOSE	OPEN
TOTAL			67					



This document contains information considered proprietary, and shall not be reproduced wholly or in part, nor disclosed to others without specific written permission.

HARDWARE NAME: MAX44299_EVKIT_A

HARDWARE NUMBER:

ENGINEER:

DESIGNER:

DATE: 06/12/2015

ODB++/GERBER: SILK_TOP

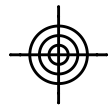
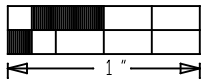
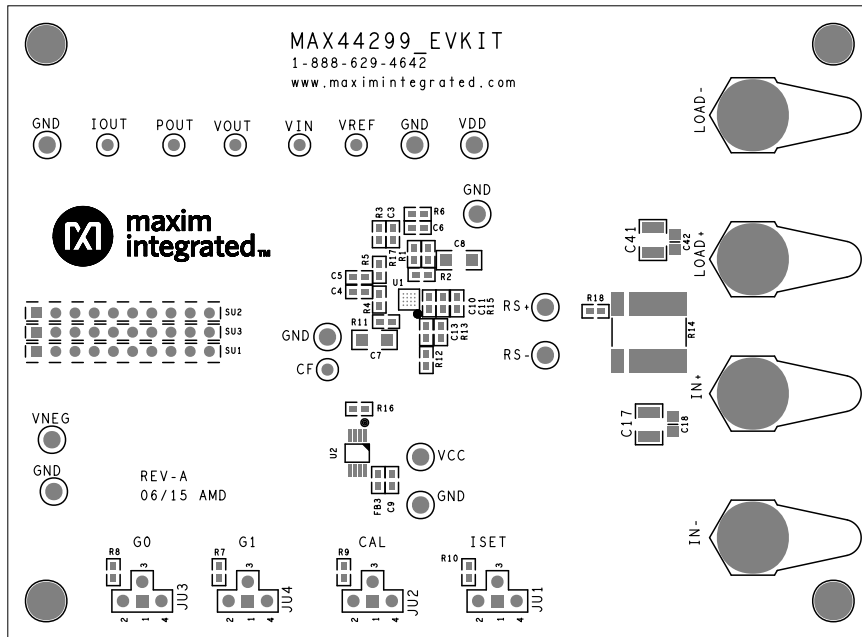
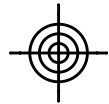



This document contains information considered proprietary, and shall not be reproduced wholly or in part, nor disclosed to others without specific written permission.

HARDWARE NAME: MAX44299_EVKIT_A

HARDWARE NUMBER:

ENGINEER:

DESIGNER:

DATE: 06/12/2015

ODB++/GERBER: TOP

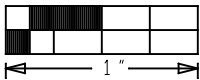
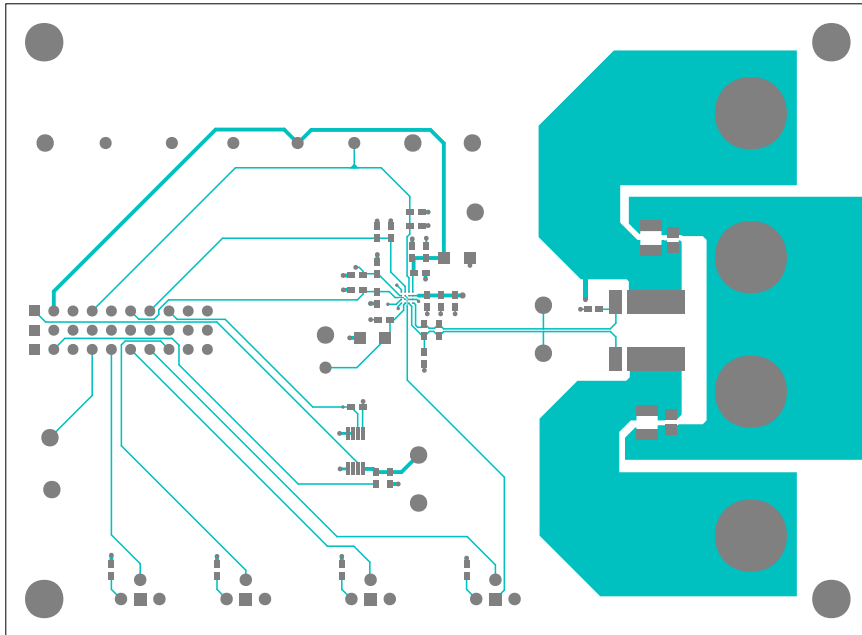
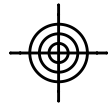

DO NOT MODIFY TOP SOLDERMASK ON U1

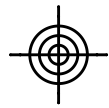



This document contains information considered proprietary, and shall not be reproduced wholly or in part, nor disclosed to others without specific written permission.

HARDWARE NAME: MAX44299_EVKIT_A

HARDWARE NUMBER:

ENGINEER:

DESIGNER:

DATE: 06/12/2015

ODB++/GERBER: LAYER 2

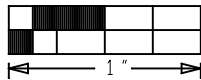
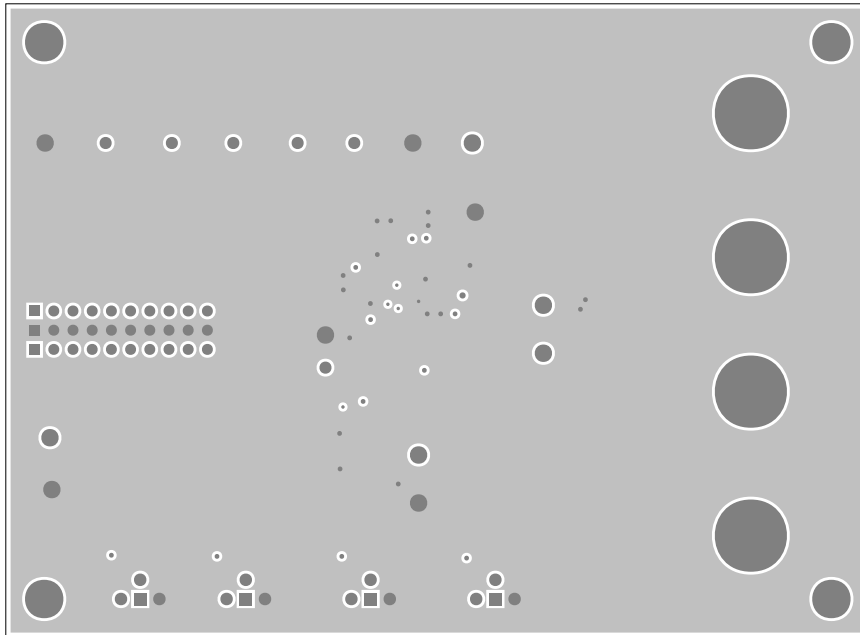

DO NOT MODIFY TOP SOLDERMASK ON U1





This document contains information considered proprietary, and shall not be reproduced wholly or in part, nor disclosed to others without specific written permission.

HARDWARE NAME: MAX44299_EVKIT_A

HARDWARE NUMBER:

ENGINEER:

DESIGNER:

DATE: 06/12/2015

ODB++/GERBER: LAYER 3

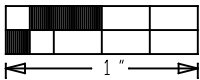
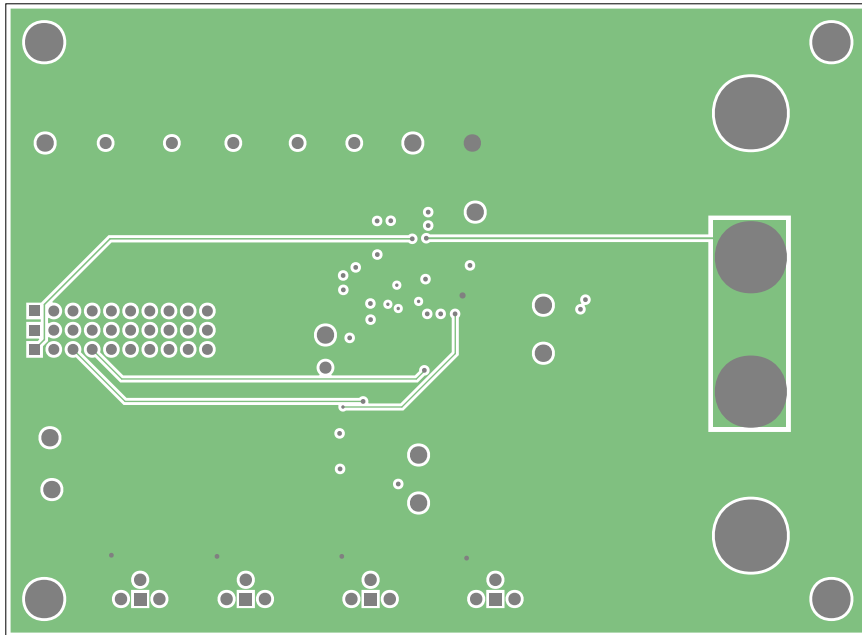
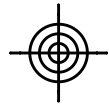

DO NOT MODIFY TOP SOLDERMASK ON U1





This document contains information considered proprietary, and shall not be reproduced wholly or in part, nor disclosed to others without specific written permission.

HARDWARE NAME: MAX44299_EVKIT_A

HARDWARE NUMBER:

ENGINEER: DESIGNER:

DATE: 06/12/2015 ODB++/GERBER: BOTTOM

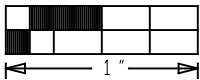
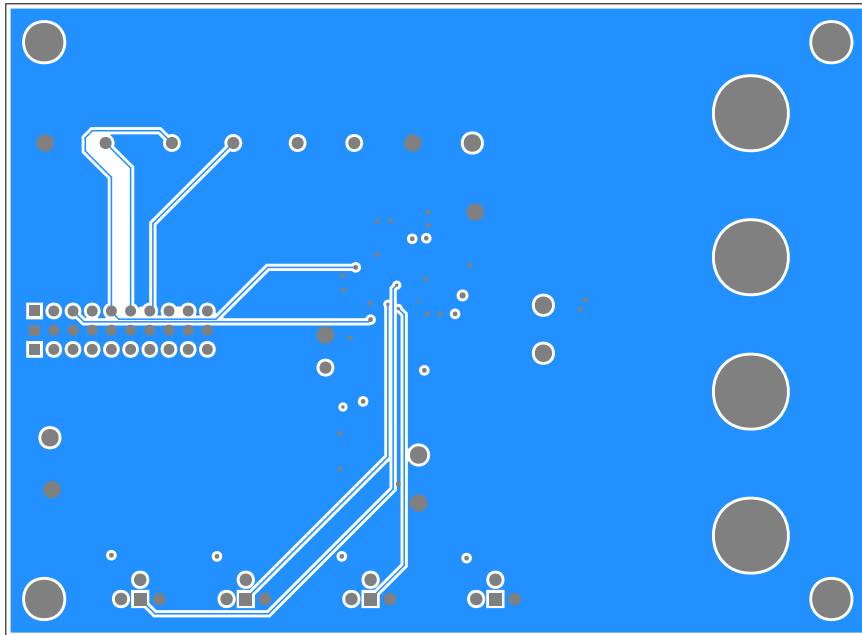
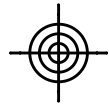

DO NOT MODIFY TOP SOLDERMASK ON U1

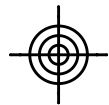



This document contains information considered proprietary, and shall not be reproduced wholly or in part, nor disclosed to others without specific written permission.

HARDWARE NAME: MAX44299_EVKIT_A

HARDWARE NUMBER:

ENGINEER:

DESIGNER:

DATE: 06/12/2015

ODB++/GERBER: SILK_BOT

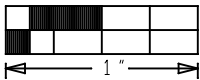
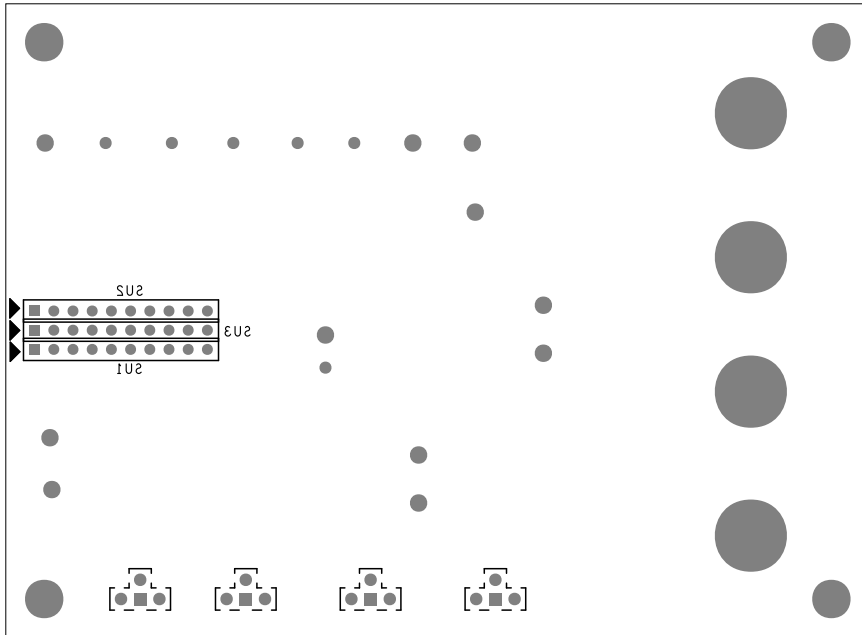
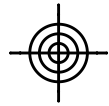

DO NOT MODIFY TOP SOLDERMASK ON U1



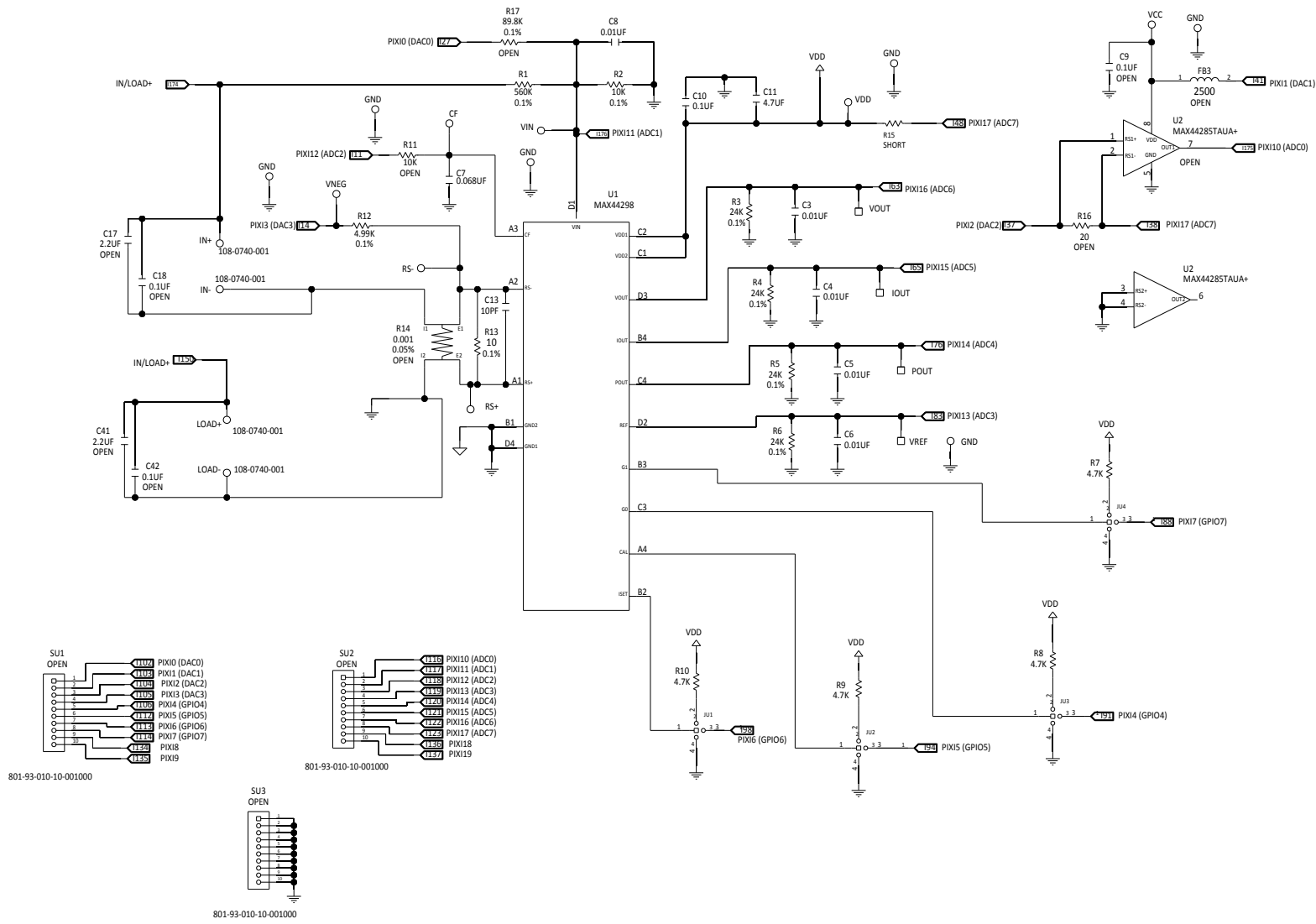

801-93-010-10-001000

801-93-010-10-001000

801-93-010-10-001000



Компания «ЭлектроПласт» предлагает заключение долгосрочных отношений при поставках импортных электронных компонентов на взаимовыгодных условиях!

Наши преимущества:

- Оперативные поставки широкого спектра электронных компонентов отечественного и импортного производства напрямую от производителей и с крупнейших мировых складов;
- Поставка более 17-ти миллионов наименований электронных компонентов;
- Поставка сложных, дефицитных, либо снятых с производства позиций;
- Оперативные сроки поставки под заказ (от 5 рабочих дней);
- Экспресс доставка в любую точку России;
- Техническая поддержка проекта, помощь в подборе аналогов, поставка прототипов;
- Система менеджмента качества сертифицирована по Международному стандарту ISO 9001;
- Лицензия ФСБ на осуществление работ с использованием сведений, составляющих государственную тайну;
- Поставка специализированных компонентов (Xilinx, Altera, Analog Devices, Intersil, Interpoint, Microsemi, Aeroflex, Peregrine, Syfer, Eurofarad, Texas Instrument, Miteq, Cobham, E2V, MA-COM, Hittite, Mini-Circuits, General Dynamics и др.);

Помимо этого, одним из направлений компании «ЭлектроПласт» является направление «Источники питания». Мы предлагаем Вам помощь Конструкторского отдела:

- Подбор оптимального решения, техническое обоснование при выборе компонента;
- Подбор аналогов;
- Консультации по применению компонента;
- Поставка образцов и прототипов;
- Техническая поддержка проекта;
- Защита от снятия компонента с производства.



Как с нами связаться

Телефон: 8 (812) 309 58 32 (многоканальный)

Факс: 8 (812) 320-02-42

Электронная почта: org@eplast1.ru

Адрес: 198099, г. Санкт-Петербург, ул. Калинина, дом 2, корпус 4, литера А.