

## Low capacitance Transil arrays for ESD protection

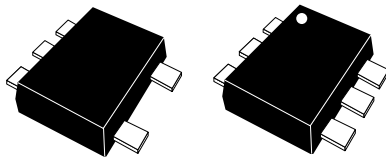

SOT-665

SOT-666IP

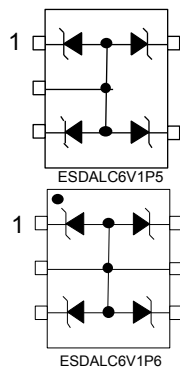

### Features

- 4 unidirectional Transil functions
- Breakdown voltage  $V_{BR} = 6.1 \text{ V min}$
- Low leakage current  $< 100 \text{ nA}$
- Low diode capacitance (7.5 pF at 3 V)
- UL94, V0
- RoHS package
- Complies with the following standards
  - IEC 61000-4-2 (exceeds level 4)  
20 kV (air discharge)  
8 kV (contact discharge)
  - MIL STD 883E - Method 3015-7: class 3  
25 kV HBM (human body model)

### Applications

Where transient overvoltage protection in ESD sensitive equipment is required, such as:

- Computers
- Printers
- Communication systems
- Set-top boxes

### Description

These devices are monolithic suppressors designed to protect components connected to data and transmission lines against ESD. They clamp the voltage just above the logic level supply for positive transients and to a diode drop below ground for negative transients.

Product status link

[ESDALC6V1Px](#)

# 1 Characteristics

**Table 1. Absolute maximum ratings ( $T_{amb} = 25\text{ }^{\circ}\text{C}$ )**

Symbol	Parameter		Value	Unit
$V_{PP}$	Peak pulse voltage	IEC 61000-4-2: Contact discharge	8	kV
		Air discharge	20	
		MIL STD 883G - method 3015-7: Class3	25	
$P_{PP}$	Peak pulse power	8/20 $\mu\text{s}$ , $T_j$ initial = $T_{amb}$	30	W
$T_{stg}$	Storage temperature range		-55 to +150	$^{\circ}\text{C}$
$T_j$	Junction temperature range		-40 to +150	
$T_L$	Maximum lead temperature for soldering during 10 s		260	
$T_{op}$	Operating temperature range		-40 to +150	

**Figure 1. Electrical characteristics (definitions)**

Symbol	Parameter
$V_{BR}$	= Breakdown voltage
$V_{CL}$	= Clamping voltage
$I_{RM}$	= Leakage current
$I_F$	= Forward current
$I_{PP}$	= Peak pulse current
$I_R$	= Breakdown current
$V_F$	= Forward voltage drop
$C$	= Capacitance
$R_d$	= Dynamic impedance
$\alpha T$	= Voltage temperature

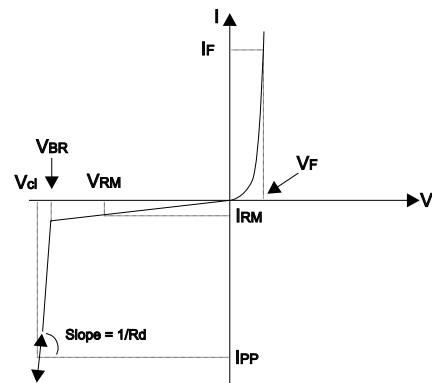
**Table 2. Electrical characteristics ( $T_{amb} = 25\text{ }^{\circ}\text{C}$ )**

Order code	$V_{BR}$ at $I_R$		$I_{RM}$ at $V_{RM}$			$R_d$	$\alpha T$	$C$	
	Min.	Max.	Typ.	Max.		Typ.	Typ.	Typ. at 3 V	
	V	V	mA	nA	$\mu\text{A}$	V	$\Omega$	$10^{-4}/^{\circ}\text{C}$	pF
ESDALC6V1P5	6.1	7.2	1	10	0.1	3	1.5	4.5	7.5
ESDALC6V1P6		8.0							

## 1.1 Characteristics (curves)

**Figure 2. Peak pulse power dissipation versus initial junction temperature**

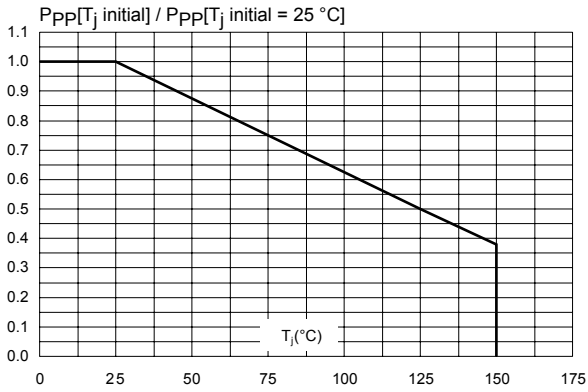

**Figure 3. Peak pulse power versus exponential pulse duration ( $T_j$  initial = 25 °C)**

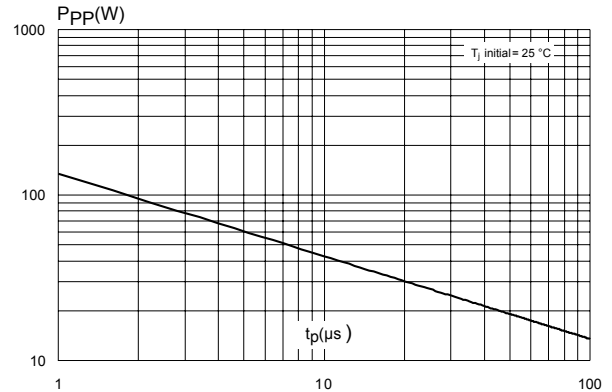

**Figure 4. Clamping voltage versus peak pulse current (rectangular waveform)**

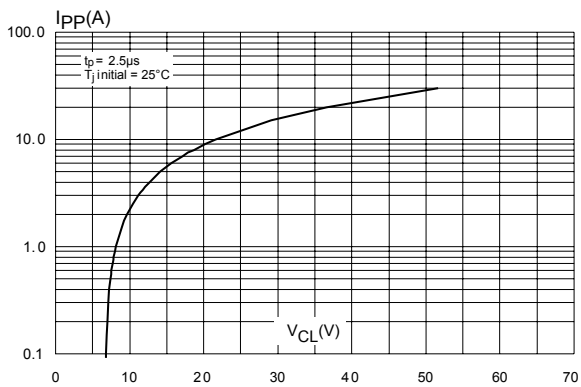

**Figure 5. Forward voltage drop versus peak forward current**

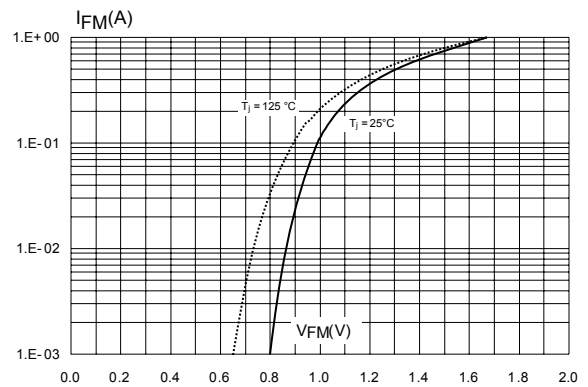

**Figure 6. Junction capacitance versus reverse applied voltage**

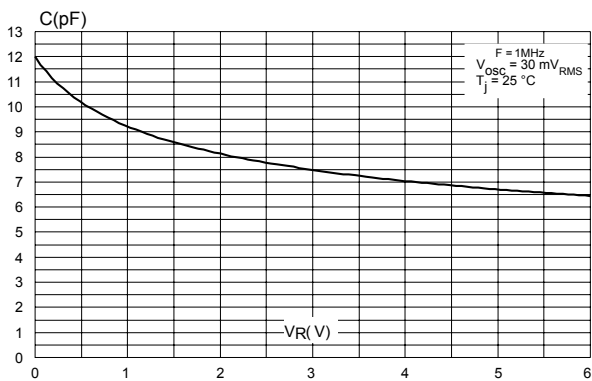

**Figure 7. Relative variation of leakage current versus junction temperature**

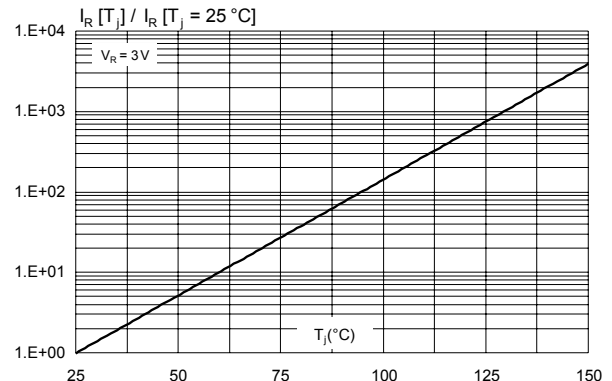

**Figure 8. ESD response to IEC 61000-4-2 (+15 kV air discharge)**

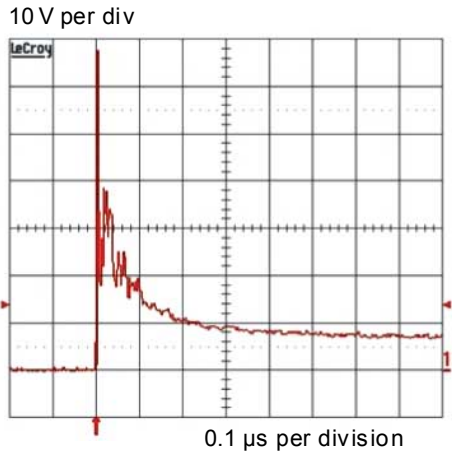

**Figure 9. Analog crosstalk**

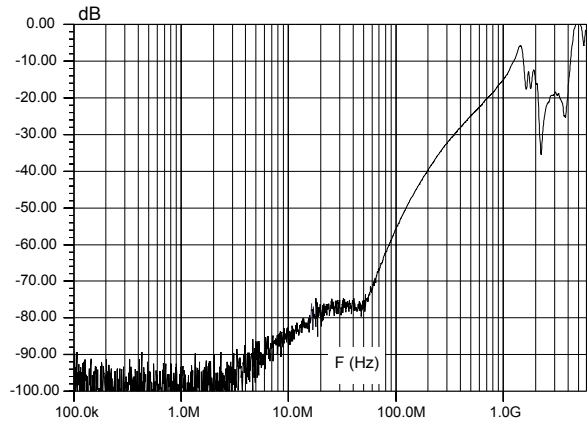

**Figure 10. Digital crosstalk test**

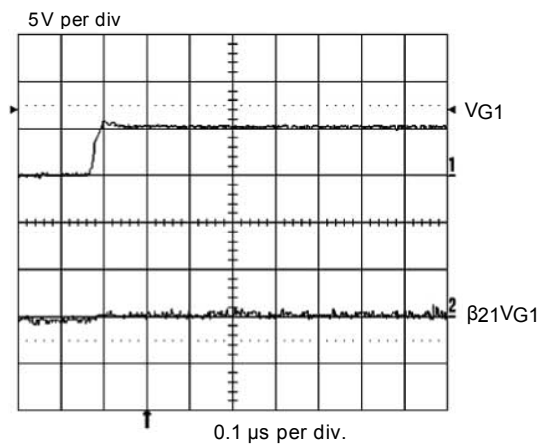

---

## 2 Package information

---

In order to meet environmental requirements, ST offers these devices in different grades of **ECOPACK** packages, depending on their level of environmental compliance. ECOPACK specifications, grade definitions and product status are available at: [www.st.com](http://www.st.com). ECOPACK is an ST trademark.

## 2.1 SOT-665 package information

Figure 11. SOT-665 package outline

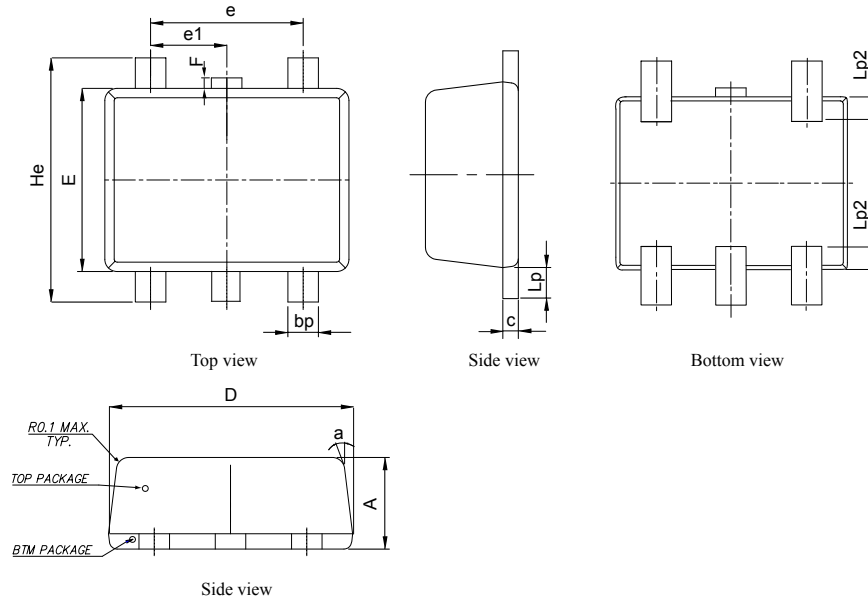

Table 3. SOT-665 package mechanical data

Ref.	Dimensions					
	Millimeters			Inches		
	Min.	Typ.	Max.	Min.	Typ.	Max.
A	0.50		0.62	0.019		0.025
bp	0.17	0.20	0.34	0.006	0.008	0.014
C	0.08		0.18	0.003		0.008
D	1.50		1.70	0.059		0.067
E	1.10		1.30	0.043		0.052
e1		0.50			0.020	
e		1.00			0.039	
F	0.00		0.10	0.000		0.004
He	1.50		1.70	0.059		0.067
Lp	0.10		0.30	0.003		0.012
Lp2		0.15			0.006	

Figure 12. Footprint recommendations, dimensions in mm

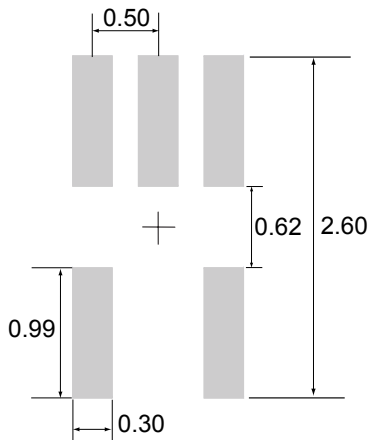

Figure 13. Marking layout (refer to ordering information table for marking)

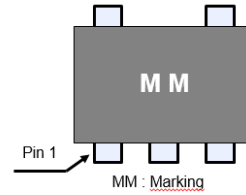
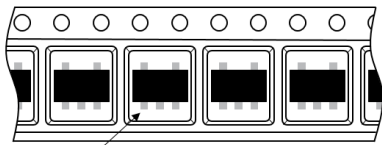

Figure 14. Package orientation in reel



Pin 1 located according to EIA-481

Note:  
Pocket dimensions are not on scale  
Pocket shape may vary depending on package

Figure 15. Tape and reel orientation

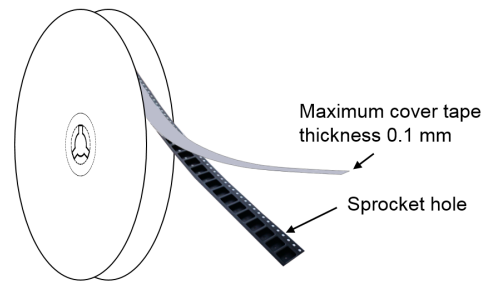

Figure 16. Reel dimensions (mm)

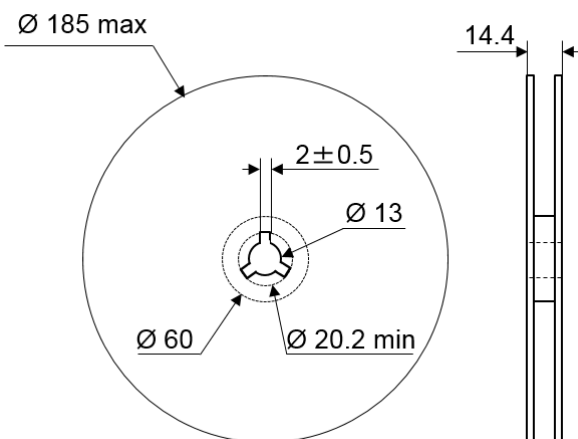

Figure 17. Inner box dimensions (mm)

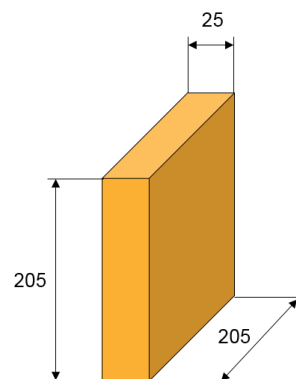
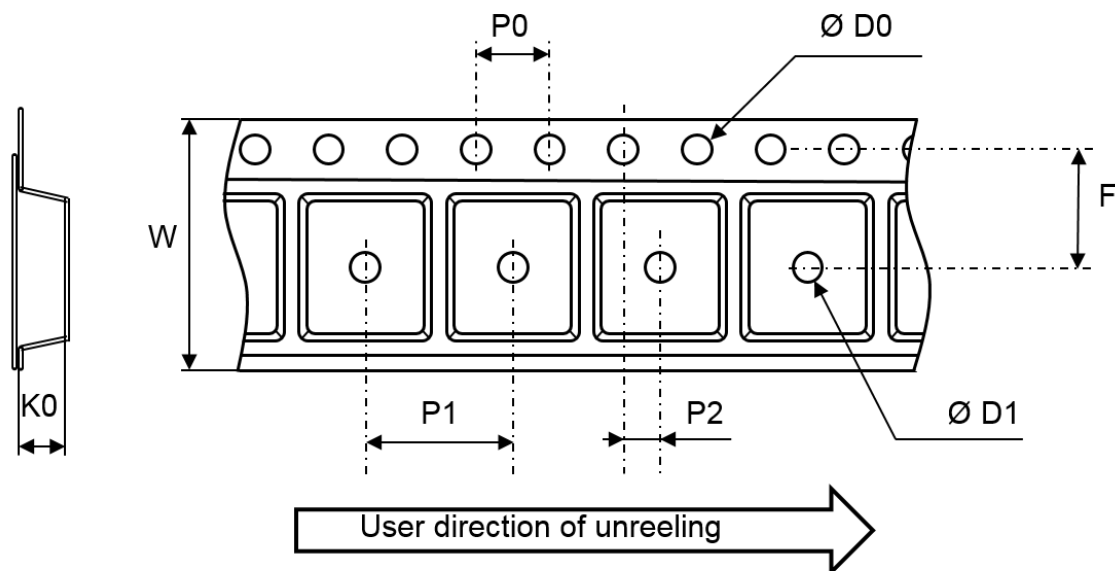

Figure 18. Tape and reel outline



Note: Pocket dimensions are not on scale  
Pocket shape may vary depending on package

Table 4. Tape and reel mechanical data

Ref.	Dimensions		
	Millimeters		
	Min.	Typ.	Max.
D0	1.5	1.55	1.6
D1	1		
F	3.45	3.5	3.55
K0	0.64	0.69	0.73
P0	3.9	4	4.1
P1	3.9	4	4.1
P2	1.95	2	2.05
W	7.9	8	8.3



## 2.2 SOT-666IP package information

Figure 19. SOT-666IP package outline

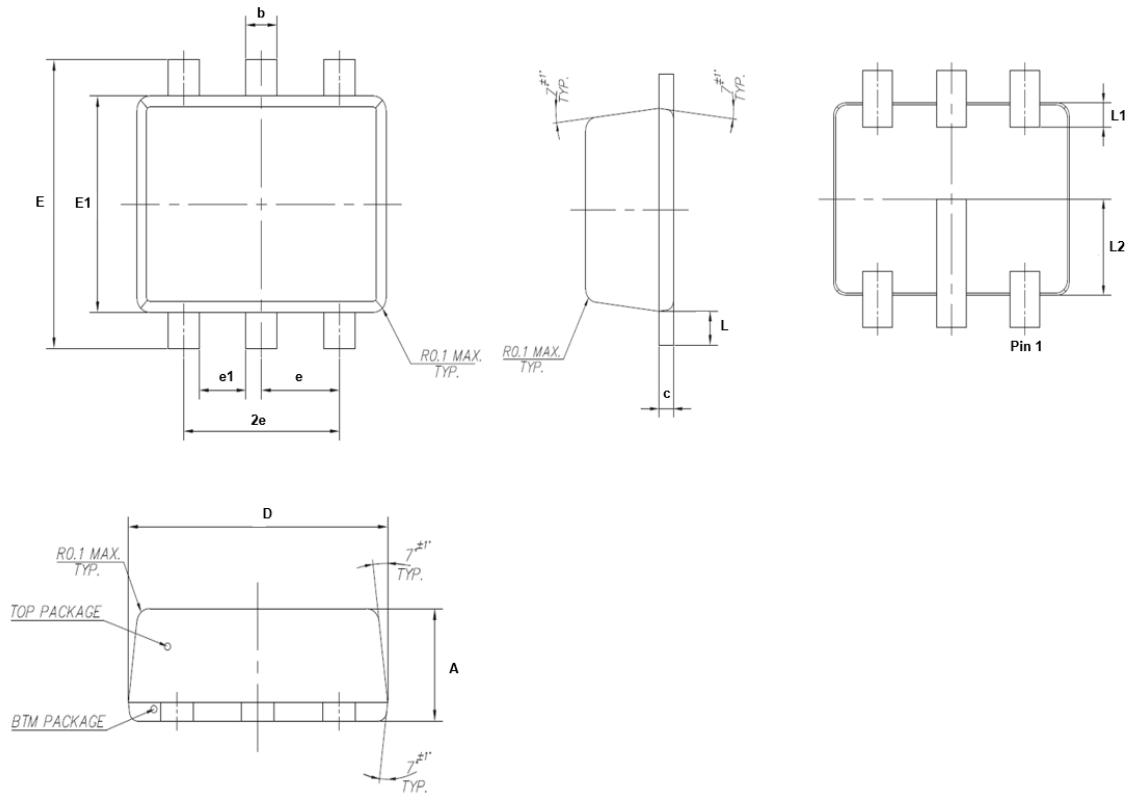

Table 5. SOT-666IP package mechanical data

Ref.	Dimensions					
	Millimeters			Inches		
	Min.	Typ.	Max.	Min.	Typ.	Max.
A	0.50	0.60	0.62	0.019	0.024	0.025
b	0.17	0.20	0.34	0.006	0.008	0.014
c	0.08	0.15	0.18	0.003	0.006	0.008
D	1.50	1.60	1.70	0.059	0.063	0.067
E	1.50	1.60	1.70	0.059	0.063	0.067
e	0.45	0.50	0.55	0.017	0.020	0.022
E1	1.10	1.20	1.30	0.043	0.047	0.052
e1		0.25			0.10	
L	0.10	0.20	0.30	0.003	0.008	0.012
L1	0.05	0.15	0.25	0.001	0.006	0.010
L2	0.50	0.60	0.70	0.019	0.024	0.028

Figure 20. Footprint recommendations, dimensions in mm

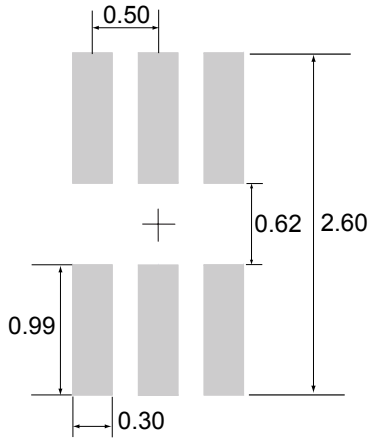

Figure 21. Marking layout (refer to ordering information table for marking)

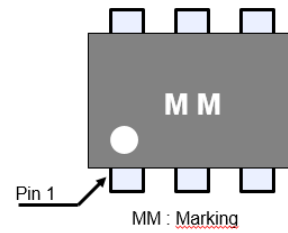
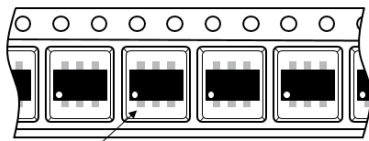

Figure 22. Package orientation in reel



Pin 1 located according to EIA-481  
Note: Pocket dimensions are not on scale  
Pocket shape may vary depending on package

Figure 23. Tape and reel orientation

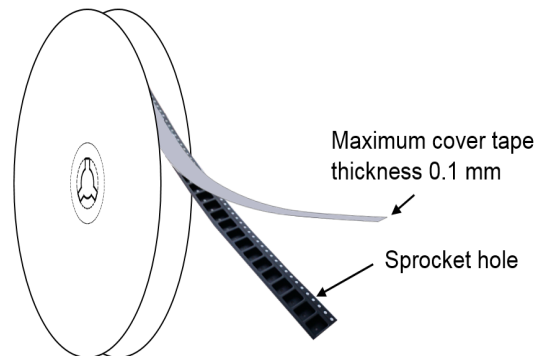

Figure 24. Reel dimensions (mm)

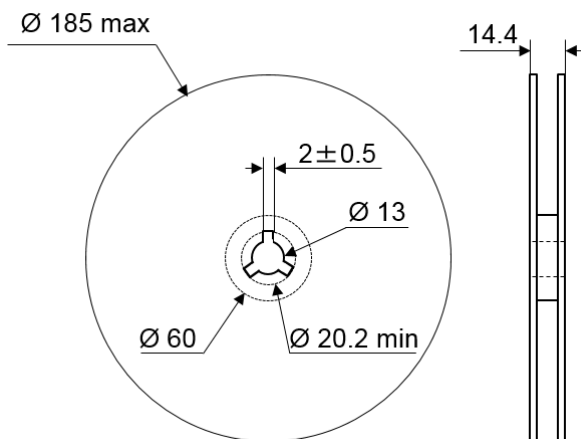

Figure 25. Inner box dimensions (mm)

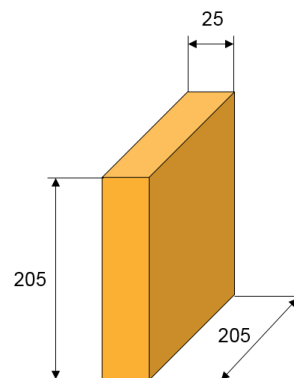
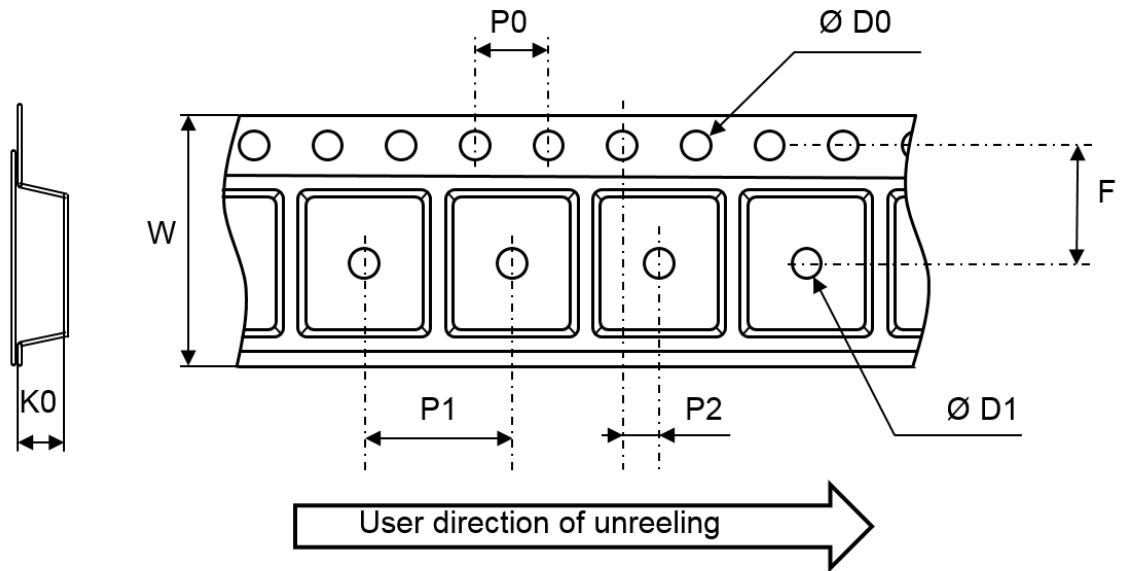

Figure 26. Tape and reel outline



Note: Pocket dimensions are not on scale  
Pocket shape may vary depending on package

Table 6. Tape and reel mechanical data

Ref.	Dimensions		
	Millimeters		
	Min.	Typ.	Max.
D0	1.5	1.55	1.6
D1	1		
F	3.45	3.5	3.55
K0	0.64	0.69	0.73
P0	3.9	4	4.1
P1	3.9	4	4.1
P2	1.95	2	2.05
W	7.9	8	8.3

## 2.3 Reflow profile

Figure 27. ST ECOPACK® recommended soldering reflow profile for PCB mounting

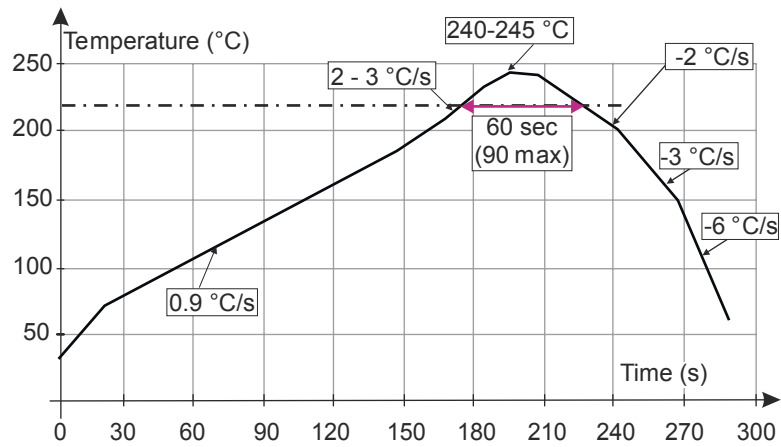

Note: Minimize air convection currents in the reflow oven to avoid component movement.

Note: Maximum soldering profile corresponds to the latest IPC/JEDEC J-STD-020.

### 3 Ordering information

Figure 28. Ordering information scheme

Table 7. Ordering information

Order code	Marking <sup>(1)</sup>	Package	Weight	Base qty.	Delivery mode
ESDALC6V1P5	A1	SOT-665	3.53 mg	3000	Tape and reel
ESDALC6V1P6	D	SOT-666IP	3.0 mg		

1. The marking can be rotated by multiples of 90° to differentiate assembly location

## Revision history

**Table 8. Document revision history**

Date	Revision	Changes
16-Aug-2006	1	ESDALC6V1P3, ESDALC6V1P5, and ESDALC6V1P6 merged and reformatted to current standards.
23-Aug-2006	2	Table 1 on page 2: Temperature range upgraded to $T_j \text{ max} = 150 \text{ }^\circ\text{C}$
11-Oct-2006	3	Added values for $V_{PP}$ in Table 1.
23-Apr-2008	4	Reformatted to current standards. Added $I_{RM}$ typical value in Table 2. Update minimum dimension for L2 of SOT-663 in Table 3.
15-Jan-2010	5	Updated Figure 17: SOT-665 footprint (dimensions in mm).
03-Dec-2014	6	Updated SOT-666IP dimension definitions and reformatted to current standard.
17-Mar-2017	7	Removed SOT-663 package. Updated Table 1. Absolute maximum ratings ( $T_{amb} = 25 \text{ }^\circ\text{C}$ ). Updated Table 3. SOT-665 package mechanical data and Table 4. SOT-666IP package mechanical data.
03-Aug-2017	8	Updated Section 2.1 SOT-665 package information.
26-Mar-2018	9	Updated Table 3. SOT-665 package mechanical data. Updated cover page.
13-May-2019	10	Updated Section Features, Section Applications, Table 1, Table 2 and Section 2 .

**IMPORTANT NOTICE – PLEASE READ CAREFULLY**

STMicroelectronics NV and its subsidiaries (“ST”) reserve the right to make changes, corrections, enhancements, modifications, and improvements to ST products and/or to this document at any time without notice. Purchasers should obtain the latest relevant information on ST products before placing orders. ST products are sold pursuant to ST’s terms and conditions of sale in place at the time of order acknowledgement.

Purchasers are solely responsible for the choice, selection, and use of ST products and ST assumes no liability for application assistance or the design of Purchasers’ products.

No license, express or implied, to any intellectual property right is granted by ST herein.

Resale of ST products with provisions different from the information set forth herein shall void any warranty granted by ST for such product.

ST and the ST logo are trademarks of ST. For additional information about ST trademarks, please refer to [www.st.com/trademarks](http://www.st.com/trademarks). All other product or service names are the property of their respective owners.

Information in this document supersedes and replaces information previously supplied in any prior versions of this document.

© 2019 STMicroelectronics – All rights reserved



Компания «ЭлектроПласт» предлагает заключение долгосрочных отношений при поставках импортных электронных компонентов на взаимовыгодных условиях!

Наши преимущества:

- Оперативные поставки широкого спектра электронных компонентов отечественного и импортного производства напрямую от производителей и с крупнейших мировых складов;
- Поставка более 17-ти миллионов наименований электронных компонентов;
- Поставка сложных, дефицитных, либо снятых с производства позиций;
- Оперативные сроки поставки под заказ (от 5 рабочих дней);
- Экспресс доставка в любую точку России;
- Техническая поддержка проекта, помощь в подборе аналогов, поставка прототипов;
- Система менеджмента качества сертифицирована по Международному стандарту ISO 9001;
- Лицензия ФСБ на осуществление работ с использованием сведений, составляющих государственную тайну;
- Поставка специализированных компонентов (Xilinx, Altera, Analog Devices, Intersil, Interpoint, Microsemi, Aeroflex, Peregrine, Syfer, Eurofarad, Texas Instrument, Miteq, Cobham, E2V, MA-COM, Hittite, Mini-Circuits, General Dynamics и др.);

Помимо этого, одним из направлений компании «ЭлектроПласт» является направление «Источники питания». Мы предлагаем Вам помощь Конструкторского отдела:

- Подбор оптимального решения, техническое обоснование при выборе компонента;
- Подбор аналогов;
- Консультации по применению компонента;
- Поставка образцов и прототипов;
- Техническая поддержка проекта;
- Защита от снятия компонента с производства.



#### Как с нами связаться

**Телефон:** 8 (812) 309 58 32 (многоканальный)

**Факс:** 8 (812) 320-02-42

**Электронная почта:** [org@eplast1.ru](mailto:org@eplast1.ru)

**Адрес:** 198099, г. Санкт-Петербург, ул. Калинина, дом 2, корпус 4, литера А.