

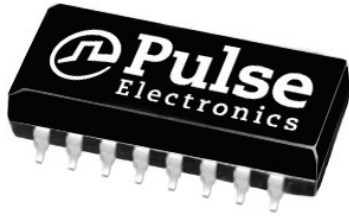





# Copperhead™ High Speed Dual Transformers



-  Compliant with ANSI X3T111, Fiber Channel, FC-PH-3 for quarter/full speed applications, SMPTE, IEEE1394 Firewire
-  Moisture sensitivity Level 3
-  Pick and place compatible
-  Peak temperature profile 250°C; NL parts peak temperature is 245°C.
-  AS9100 Certified (Based on and including ISO 9001:2000)

## Electrical Specifications @ 25°C - Operating Temperature -55°C to +125°C

Part Number	Turns Ratio (±5%)	Primary Inductance (µH MIN)	Rise Time @ 20 & 80% (pS MAX)	DC Resistance (ΩMAX)	Hi-Pot (Vrms MIN)	Insertion Loss (dB MAX)	Application Nominal Bit Rate (Mbaud)
T-330SCT	1CT : 1CT	26 @ 1 Vrms, 100kHz	350	0.2	1,500	-1.5 @ 15-165MHz	265.6 (1/4 speed)
T-531SCT	1CT : 1CT	7.5 @ 1 Vrms, 100kHz	325	0.2	1,500	-2.0 @ 50-265MHz	531 (half speed)
T-1062SCT	1CT : 1CT	3.75 @ 1 Vrms, 100kHz	280	0.2	1,500	-2.0 @ 100-531MHz	1,062.5 (full speed)
T-1250SCT	1CT : 1CT	3.75 @ 1 Vrms, 100kHz	280	0.2	1,500	-2.0 @ 125-650MHz	1,250
T-1485SCT	1CT : 1CT	3.75 @ 1 Vrms, 100kHz	280	0.2	1,500	-2.0	1,485 (SMTPE)
T-3200SCT	1 : 1	0.70	200	0.2	1,500	-4.5	3,200

### Notes:

- To order a RoHS compliant part, add the suffix "NL" to the part number, i.e. T-330SCT becomes T-330SCTNL.
- Add suffix "T" to part number for Tape & Reel package (i.e. T-330SCTT).

### Mechanical

### Schematic

#### T-330SCT, T-531SCT, T-1062SCT, T1250SCT and T-1485SCT

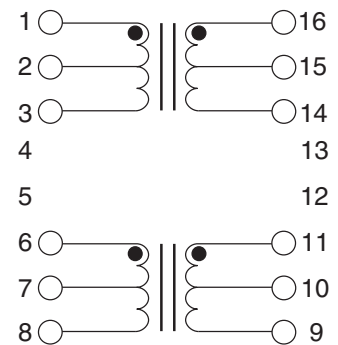
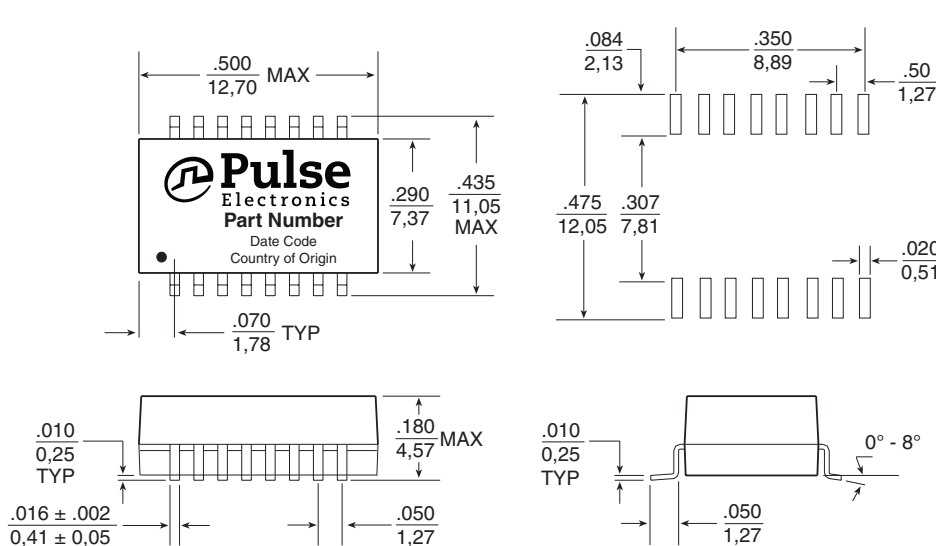

Weight . . . . . 1.0 grams  
 Tape & Reel . . . . . 400/reel  
 Dimensions:  $\frac{\text{Inches}}{\text{mm}}$   
 Unless otherwise specified,  
 all tolerances are  $\pm \frac{.005}{0,13}$

# Copperhead™ High Speed Dual Transformers

## Mechanical

## Schematic

### T-3200SCT

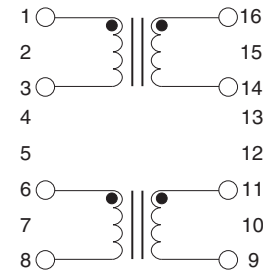
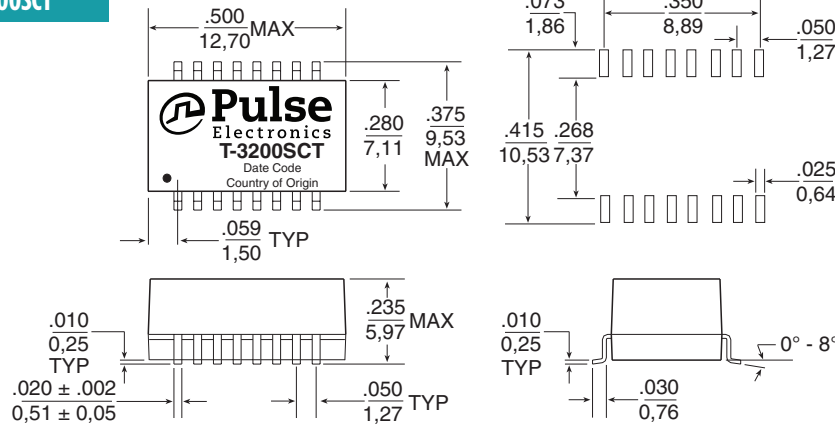

Weight . . . . . 1.0 grams  
Tape & Reel . . . . . 600/reel  
Dimensions: Inches  
mm  
Unless otherwise specified,  
all tolerances are ± .005  
0,13

## Application

Pulse Specialty Components has designed Fibre Channel dual transformers specifically for point to point coupling to 150 twinax cable. The isolation transformers protect the station from static charges that may develop on the cable, and prevents ground loop currents from being transferred between stations. The devices have also been designed to provide common mode rejection within the transmission band and thus reduce EMI. The wide bandwidth of these

devices minimizes data dependent jitter by providing fast signal rise times. Low-end bandwidth also minimizes base-line wander, another contributor to jitter. The dual package allows connection of both transmit and receive channels, as shown in the application circuit below. Surface-mount packaging also allows a cost-effective solution.

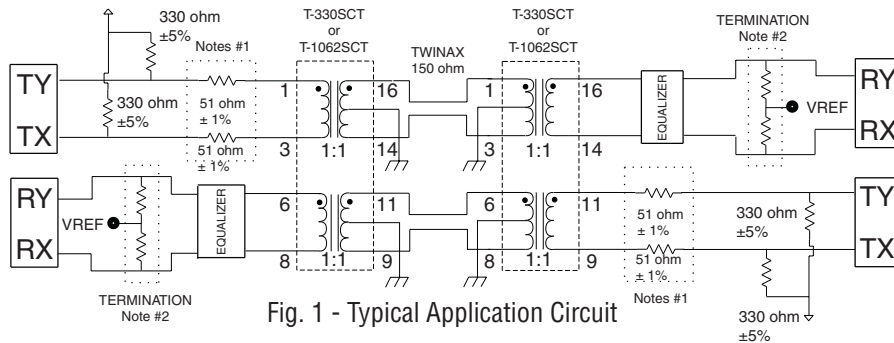

1. The transformer, 51 Ω resistors, and the impedance of the driver are matched to achieve the best return loss (S11) for the transmitter of the 150 Ω system.
2. The total impedance of termination resistor network is 150 Ω.
3. When laying out PCB, transmission line methods must be utilized to maintain return loss and signal integrity. Transformer must be located within .50 of the DB9

4. It is recommended that the center tap (CT) of transformer(s), cable side, be connected to earth/chassis (cable shield) ground either directly or via a transient voltage suppressor (TVS) type component and earth/chassis ground should be "AC-coupled" to signal (digital) ground through a 0.27uF, 500v capacitor.

## For More Information

### Pulse Worldwide Headquarters

12220 World Trade Drive  
San Diego, CA  
92128  
U.S.A.

Tel: 858 674 8100

### Pulse Europe

Einsteinstrasse 1  
D-71083 Herrenberg  
Germany

Tel: 49 7032 7806

### Pulse China Headquarters

B402, Shenzhen Academy of  
Aerospace Technology Bldg.  
10th Kejinan Road  
High-Tech Zone  
Nanshan District  
Shenzhen, PR China  
518057

### Pulse North China

Room 2704/2705  
Super Ocean Finance  
Ctr.  
2067 Yan An Road  
West  
Shanghai 200336  
China

### Pulse South Asia

135 Joo Seng Road  
#03-02  
PM Industrial Bldg.  
Singapore 368363

Tel: 65 6287 8998  
Fax: 65 6287 8998

### Pulse North Asia

3F, No. 198  
Zhongyuan Road  
Zhongli City  
Taoyuan County 320  
Taiwan R. O. C.  
Tel: 886 3 4356768  
Fax: 886 3 4356823  
(Pulse)

Performance warranty of products offered on this data sheet is limited to the parameters specified. Data is subject to change without notice. Other brand and product names mentioned herein may be trademarks or registered trademarks of their respective owners. © Copyright, 2014, Pulse Electronics, Inc. All rights reserved.



Компания «ЭлектроПласт» предлагает заключение долгосрочных отношений при поставках импортных электронных компонентов на взаимовыгодных условиях!

Наши преимущества:

- Оперативные поставки широкого спектра электронных компонентов отечественного и импортного производства напрямую от производителей и с крупнейших мировых складов;
- Поставка более 17-ти миллионов наименований электронных компонентов;
- Поставка сложных, дефицитных, либо снятых с производства позиций;
- Оперативные сроки поставки под заказ (от 5 рабочих дней);
- Экспресс доставка в любую точку России;
- Техническая поддержка проекта, помощь в подборе аналогов, поставка прототипов;
- Система менеджмента качества сертифицирована по Международному стандарту ISO 9001;
- Лицензия ФСБ на осуществление работ с использованием сведений, составляющих государственную тайну;
- Поставка специализированных компонентов (Xilinx, Altera, Analog Devices, Intersil, Interpoint, Microsemi, Aeroflex, Peregrine, Syfer, Eurofarad, Texas Instrument, Miteq, Cobham, E2V, MA-COM, Hittite, Mini-Circuits, General Dynamics и др.);

Помимо этого, одним из направлений компании «ЭлектроПласт» является направление «Источники питания». Мы предлагаем Вам помощь Конструкторского отдела:

- Подбор оптимального решения, техническое обоснование при выборе компонента;
- Подбор аналогов;
- Консультации по применению компонента;
- Поставка образцов и прототипов;
- Техническая поддержка проекта;
- Защита от снятия компонента с производства.



#### Как с нами связаться

**Телефон:** 8 (812) 309 58 32 (многоканальный)

**Факс:** 8 (812) 320-02-42

**Электронная почта:** [org@eplast1.ru](mailto:org@eplast1.ru)

**Адрес:** 198099, г. Санкт-Петербург, ул. Калинина, дом 2, корпус 4, литера А.