



FEATURES

- Basic/supplementary isolation to UL 60950²
- UL60601 (3rd Ed) recognition²
- Single and dual outputs
- UL 94V-0 package material
- SIP package style
- 5.2kVDC isolation
- 3.3V, 5V, 12V, 15V & 24V inputs
- 3.3V, 5V, 9V, 12V & 15V output
- Internal SMD construction
- Fully encapsulated with toroidal magnetics
- Pin compatible with the MEV, NMV, NMK, MEJ2, & NMJ series

PRODUCT OVERVIEW

The MEJ1 series are single and dual output DC/DC converters in a 7 pin SIP package style offering an isolation and insulation upgrade path from the NMV & MEV1 series¹. The MEJ1 series has UL60950 and UL60601 recognition, which makes it ideal for applications where safety and miniaturisation are of paramount importance.

SELECTION GUIDE

| Order Code | Nominal Input Voltage | Output Voltage | Output Current | Input Current (Typ) | Load Regulation (Typ) | Load Regulation (Max) | Ripple & Noise (Typ) ³ | Ripple & Noise (Max) ³ | Efficiency (Min) | Efficiency (Typ) | MTTF | | |
|-------------|-----------------------|----------------|----------------|---------------------|-----------------------|-----------------------|-----------------------------------|-----------------------------------|------------------|------------------|------|------|------|
| | V | V | mA | | % | | mVp-p | | % | kHrs | | | |
| Single | MEJ1S0303SC | 3.3 | 3.3 | 303 | 410 | 8.5 | 11 | 42 | 55 | 67 | 70 | 3653 | |
| | MEJ1S0305SC | 3.3 | 5 | 200 | 400 | 9 | 10 | 33 | 45 | 68 | 71.5 | 3810 | |
| | MEJ1S0503SC | 5 | 3.3 | 303 | 280 | 6.5 | 8 | 20 | 40 | 66 | 69 | 4117 | |
| | MEJ1S0505SC | 5 | 5 | 200 | 270 | 5.5 | 7 | 24 | 40 | 68 | 72 | 4082 | |
| | MEJ1S0509SC | 5 | 9 | 111 | 265 | 4.5 | 5 | 20 | 40 | 70 | 74 | 3939 | |
| | MEJ1S0512SC | 5 | 12 | 83 | 260 | 4.5 | 7 | 22 | 40 | 71 | 74 | 3816 | |
| | MEJ1S0515SC | 5 | 15 | 66 | 260 | 5 | 6 | 22 | 40 | 72 | 75 | 3412 | |
| | MEJ1S1203SC | 12 | 3.3 | 303 | 110 | 6 | 7 | 25 | 45 | 69 | 72 | 3461 | |
| | MEJ1S1205SC | 12 | 5 | 200 | 110 | 5 | 6 | 21 | 40 | 71 | 74.5 | 3319 | |
| | MEJ1S1209SC | 12 | 9 | 111 | 105 | 4 | 5 | 18 | 40 | 73 | 76.5 | 3218 | |
| | MEJ1S1212SC | 12 | 12 | 83 | 105 | 3.5 | 5 | 19 | 40 | 73 | 76.5 | 3494 | |
| | MEJ1S1215SC | 12 | 15 | 66 | 105 | 4 | 5 | 16 | 40 | 73 | 77 | 3150 | |
| | MEJ1S1505SC | 15 | 5 | 200 | 90 | 5 | 6 | 23 | 45 | 70 | 74 | 3048 | |
| | MEJ1S1509SC | 15 | 9 | 111 | 85 | 4 | 5 | 18 | 40 | 72 | 76 | 2963 | |
| | MEJ1S1512SC | 15 | 12 | 83 | 85 | 4 | 5 | 20 | 40 | 72 | 76.5 | 2733 | |
| | MEJ1S1515SC | 15 | 15 | 66 | 85 | 4 | 5 | 19 | 35 | 73 | 76.5 | 2333 | |
| | Dual | MEJ1D2405SC | 24 | 5 | 200 | 55 | 5 | 6 | 23 | 40 | 71 | 75 | 3353 |
| | | MEJ1D2409SC | 24 | 9 | 111 | 55 | 4 | 7 | 17 | 40 | 72 | 77 | 2940 |
| MEJ1D2412SC | | 24 | 12 | 83 | 55 | 4 | 5 | 19 | 40 | 72 | 78 | 2987 | |
| MEJ1D2415SC | | 24 | 15 | 66 | 55 | 3.5 | 5 | 17 | 40 | 74 | 78 | 2517 | |
| MEJ1D0503SC | | 5 | ±3.3 | ±151 | 280 | 6 | 8 | 19 | 40 | 67 | 70 | 4511 | |
| MEJ1D0505SC | | 5 | ±5 | ±100 | 275 | 5 | 6 | 23 | 35 | 69 | 72 | 4012 | |
| MEJ1D0509SC | | 5 | ±9 | ±55 | 265 | 4 | 6 | 16 | 35 | 69 | 74 | 3492 | |
| MEJ1D0512SC | | 5 | ±12 | ±42 | 260 | 4 | 5 | 15 | 30 | 72 | 74.5 | 3485 | |
| MEJ1D0515SC | | 5 | ±15 | ±33 | 260 | 4 | 5 | 13 | 35 | 71 | 75.5 | 2844 | |
| MEJ1D1203SC | | 12 | ±3.3 | ±151 | 110 | 5.5 | 6 | 19 | 40 | 70 | 73 | 3461 | |
| MEJ1D1205SC | | 12 | ±5 | ±100 | 110 | 4.5 | 5 | 18 | 40 | 72 | 75.5 | 3317 | |
| MEJ1D1209SC | | 12 | ±9 | ±55 | 110 | 4 | 5 | 15 | 35 | 73 | 77 | 2908 | |
| MEJ1D1212SC | | 12 | ±12 | ±42 | 110 | 3.5 | 5 | 14 | 30 | 74 | 76.5 | 2911 | |
| MEJ1D1215SC | | 12 | ±15 | ±33 | 110 | 4 | 5 | 11 | 35 | 73 | 77 | 2713 | |
| MEJ1D1505SC | | 15 | ±5 | ±100 | 90 | 4.5 | 5 | 19 | 40 | 72 | 75 | 3274 | |
| MEJ1D1509SC | | 15 | ±9 | ±55 | 85 | 4 | 5 | 14 | 35 | 73 | 76.5 | 3229 | |
| MEJ1D1512SC | | 15 | ±12 | ±42 | 85 | 3.5 | 5 | 13 | 35 | 73 | 77 | 2872 | |
| MEJ1D1515SC | | 15 | ±15 | ±33 | 85 | 3.5 | 5 | 20 | 35 | 73 | 76.5 | 2440 | |
| MEJ1D2405SC | 24 | ±5 | ±100 | 55 | 4.5 | 5 | 19 | 40 | 72 | 76.5 | 3316 | | |
| MEJ1D2409SC | 24 | ±9 | ±55 | 55 | 3.5 | 5 | 17 | 35 | 73 | 78 | 3208 | | |
| MEJ1D2412SC | 24 | ±12 | ±42 | 55 | 3.5 | 5 | 12 | 35 | 74 | 78 | 3362 | | |
| MEJ1D2415SC | 24 | ±15 | ±33 | 55 | 3.5 | 5 | 14 | 35 | 74 | 78.5 | 2697 | | |

INPUT CHARACTERISTICS

| Parameter | Conditions | Min. | Typ. | Max. | Units |
|------------------------|---------------------------------------|------|------|------|-------|
| Voltage range | Continuous operation, 3V input types | 2.97 | 3.3 | 3.63 | V |
| | Continuous operation, 5V input types | 4.5 | 5 | 5.5 | |
| | Continuous operation, 12V input types | 10.8 | 12 | 13.2 | |
| | Continuous operation, 15V input types | 13.5 | 15 | 16.5 | |
| | Continuous operation, 24V input types | 21.6 | 24 | 26.4 | |
| Input reflected ripple | 3.3V input types | | 40 | | mA |
| | 5V input types | | 24 | | |
| | 12V & 15V input types | | 12 | | |
| | 24V input types | | 8 | | |

1. Calculated using MIL-HDBK-217 FN2 calculation model with nominal input voltage at full load.

2. See safety approvals section for limitations of use.

3. See ripple & noise test method.

All specifications typical at T_a=25°C, nominal input voltage and rated output current unless otherwise specified.



OUTPUT CHARACTERISTICS

| Parameter | Conditions | Min. | Typ. | Max. | Units |
|----------------------------|---------------------------------------------|------|------|------|-------|
| Rated Power ² | T _A =-40°C to 85°C | | | 1 | W |
| Voltage Set Point Accuracy | See tolerance envelopes | | | | |
| Line regulation | High V _{IN} to low V _{IN} | | 1.1 | 1.2 | %/% |

ABSOLUTE MAXIMUM RATINGS

| | |
|-----------------------------------------------|----------|
| Short-circuit protection | 48 Hours |
| Lead temperature 1mm from case for 10 seconds | 260°C |
| Input voltage V _{IN} , MEJ1x03xxSC | 5V |
| Input voltage V _{IN} , MEJ1x05xxSC | 7V |
| Input voltage V _{IN} , MEJ1x12xxSC | 15V |
| Input voltage V _{IN} , MEJ1x15xxSC | 18V |
| Input voltage V _{IN} , MEJ1x24xxSC | 28V |

ISOLATION CHARACTERISTICS

| Parameter | Conditions | Min. | Typ. | Max. | Units |
|------------------------|---------------------------|------|------|------|-------|
| Isolation test voltage | Flash tested for 1 second | 5200 | | | VDC |
| Resistance | Viso= 500VDC | | 1 | | GΩ |
| Isolation capacitance | | | 3 | | pF |

GENERAL CHARACTERISTICS

| Parameter | Conditions | Min. | Typ. | Max. | Units |
|---------------------|------------|------|------|------|-------|
| Switching frequency | All types | | 50 | | kHz |

TEMPERATURE CHARACTERISTICS

| Parameter | Conditions | Min. | Typ. | Max. | Units |
|--------------------------------|------------------------------------------------------------------------------------------------------------------------------------------------------------------------------------------------------------------------------------------------------------------------------------------------------------------------------------------------------------------------------------------------------------------------------------------------------------------------------------------------------------------|------|----------------|------|-------|
| Specification | All output types (see safety approval section for limitations) | -40 | | 85 | °C |
| Storage | | -55 | | 125 | |
| Case Temperature above ambient | MEJ1S1212SC, MEJ1S1512SC, MEJ1S2412SC, MEJ1D1215SC, MEJ1D1512SC, MEJ1D2412SC, MEJ1D2415SC, MEJ1S1215SC, MEJ1S1509SC, MEJ1S2409SC MEJ1D1205SC, MEJ1D1209SC, MEJ1D2405SC, MEJ1D2409SC, MEJ1S1209SC, MEJ1S1515SC, MEJ1S2415SC, MEJ1D1212SC, MEJ1D1509SC, MEJ1S0515SC, MEJ1S2405SC, MEJ1D0512SC, MEJ1D0515SC, MEJ1D1515SC, MEJ1S1505SC, MEJ1D0505SC, MEJ1D0509SC, MEJ1D1203SC, MEJ1D1505SC, MEJ1S0509SC, MEJ1S0512SC, MEJ1S1205SC MEJ1S0505SC, MEJ1S1203SC, MEJ1D0503SC, MEJ1S0303SC, MEJ1S0305SC, MEJ1S0503SC | | 13 17 21 | | |
| Cooling | Free air convection | | | | |

TEMPERATURE DERATING GRAPH

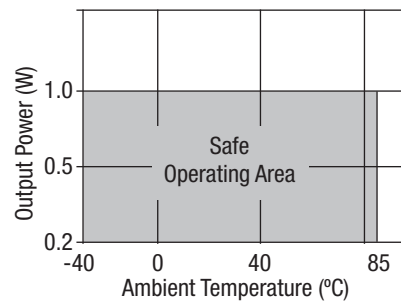

TECHNICAL NOTES**ISOLATION VOLTAGE**

'Hi Pot Test', 'Flash Tested', 'Withstand Voltage', 'Proof Voltage', 'Dielectric Withstand Voltage' & 'Isolation Test Voltage' are all terms that relate to the same thing, a test voltage, applied for a specified time, across a component designed to provide electrical isolation, to verify the integrity of that isolation.

Murata Power Solutions MEJ1 series of DC/DC converters are all 100% production tested at their stated isolation voltage. This is 5.2kVDC for 1 second.

A question commonly asked is, "What is the continuous voltage that can be applied across the part in normal operation?"

The MEJ1 series has been recognized by Underwriters Laboratory for various voltages, please see safety approval section below.

REPEATED HIGH-VOLTAGE ISOLATION TESTING

It is well known that repeated high-voltage isolation testing of a barrier component can actually degrade isolation capability, to a lesser or greater degree depending on materials, construction and environment. We therefore strongly advise against repeated high voltage isolation testing, but if it is absolutely required, that the voltage be reduced by 20% from specified test voltage.

SAFETY APPROVAL**UL 60601**

The MEJ1 series has been recognized by Underwriters Laboratory (UL) to the 3rd edition of 60601 and provides the following MOOP (means of operator protection), in a maximum ambient temperature of 85°C and/or case temperature limit of 130°C (case temperature measured on the face opposite the pins): 2 MOOP based upon a working voltage of 200 Vrms max. and 280 Vpkmax., between Primary and Secondary and 1 MOOP based upon a working voltage of 200 Vrms max., between Primary and its Enclosure. File Number E202895 applies.

UL 60950

The MEJ1 series has been recognized by Underwriters Laboratory (UL) to UL 60950 for basic/supplementary insulation to a working voltage of 200Vrms in a maximum ambient temperature of 85°C and/or case temperature limit of 130°C (case temperature measured on the face opposite the pins). File number E151252 applies.

FUSING

The MEJ1 Series of converters are not internally fused so to meet the requirements of UL an anti-surge input line fuse should always be used with ratings as defined below.

MEJ1x03xxSC 1A

MEJ1x05xxSC 1A

MEJ1x12xxSC 500mA

MEJ1x15xxSC 500mA

MEJ1x24xxSC 250mA

All fuses should be UL recognized and rated to at least the maximum allowable DC input voltage.

RoHS COMPLIANCE INFORMATION

This series is compatible with RoHS soldering systems with a peak wave solder temperature of 260°C for 10 seconds. The pin termination finish on this product series is Tin Plate, Hot Dipped over Matte Tin with Nickel Preplate. The series is backward compatible with Sn/Pb soldering systems. For further information, please visit www.murata-ps.com/rohs

APPLICATION NOTES

Minimum load

The minimum load to meet datasheet specification is 10% of the full rated load across the specified input voltage range. Lower than 10% minimum loading will result in an increase in output voltage, which may rise to typically double the specified output voltage if the output load falls to less than 5%.

Capacitive loading and start up

Typical start up times for this series, with a typical input voltage rise time of 2.2µs and output capacitance of 10µF, are shown in the table below. The product series will start into a capacitance of 47µF with an increased start time, however, the maximum recommended output capacitance is 10µF.

| Start-up time | | Start-up time | |
|---------------|-------|---------------|------|
| µs | | µs | |
| MEJ1S0303SC | 900 | MEJ1D0503SC | 700 |
| MEJ1S0305SC | 2000 | MEJ1D0505SC | 1600 |
| MEJ1S0503SC | 500 | MEJ1D0509SC | 3700 |
| MEJ1S0505SC | 2000 | MEJ1D0512SC | 4200 |
| MEJ1S0509SC | 3200 | MEJ1D0515SC | 7000 |
| MEJ1S0512SC | 7500 | MEJ1D1203SC | 600 |
| MEJ1S0515SC | 10500 | MEJ1D1205SC | 1200 |
| MEJ1S1203SC | 600 | MEJ1D1209SC | 3600 |
| MEJ1S1205SC | 1200 | MEJ1D1212SC | 3900 |
| MEJ1S1209SC | 2900 | MEJ1D1215SC | 6000 |
| MEJ1S1212SC | 2900 | MEJ1D1505SC | 1200 |
| MEJ1S1215SC | 3900 | MEJ1D1509SC | 3200 |
| MEJ1S1505SC | 1100 | MEJ1D1512SC | 3300 |
| MEJ1S1509SC | 2400 | MEJ1D1515SC | 4800 |
| MEJ1S1512SC | 2700 | MEJ1D2405SC | 1100 |
| MEJ1S1515SC | 3800 | MEJ1D2409SC | 2000 |
| MEJ1S2405SC | 1700 | MEJ1D2412SC | 3300 |
| MEJ1S2409SC | 2300 | MEJ1D2415SC | 6400 |
| MEJ1S2412SC | 2200 | | |
| MEJ1S2415SC | 3600 | | |

Typical Start-Up Wave Form

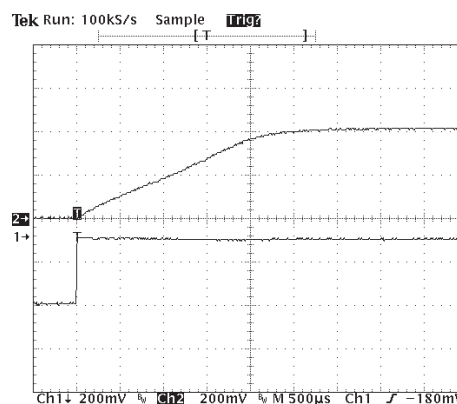

Ripple & Noise Characterisation Method

Ripple and noise measurements are performed with the following test configuration.

| | |
|-------|----------------------------------------------------------------------------------------------------------------------------------------------------------|
| C1 | 1µF X7R multilayer ceramic capacitor, voltage rating to be a minimum of 3 times the output voltage of the DC/DC converter |
| C2 | 10µF tantalum capacitor, voltage rating to be a minimum of 1.5 times the output voltage of the DC/DC converter with an ESR of less than 100mΩ at 100 kHz |
| C3 | 100nF multilayer ceramic capacitor, general purpose |
| R1 | 450Ω resistor, carbon film, ±1% tolerance |
| R2 | 50Ω BNC termination |
| T1 | 3T of the coax cable through a ferrite toroid |
| RLOAD | Resistive load to the maximum power rating of the DC/DC converter. Connections should be made via twisted wires |

Measured values are multiplied by 10 to obtain the specified values.

Differential Mode Noise Test Schematic

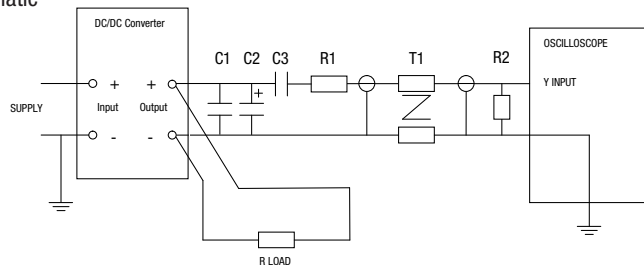

TOLERANCE ENVELOPES

The voltage tolerance envelope shows typical load regulation characteristics for this product series. The tolerance envelope is the maximum output voltage variation due to changes in output loading.

DUAL 1203,1515, 2412, SINGLE 0303, 0305, 1203

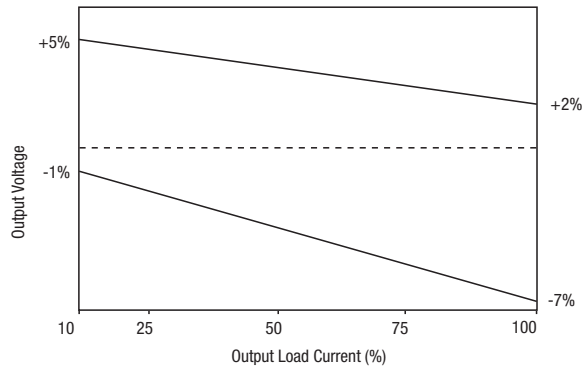

DUAL 1209, 1509, 2409

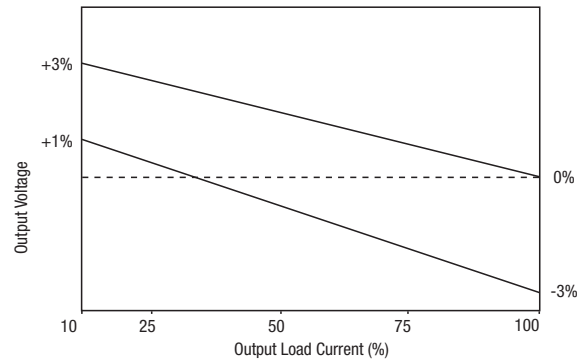

DUAL 0515, SINGLE 1515, 2415

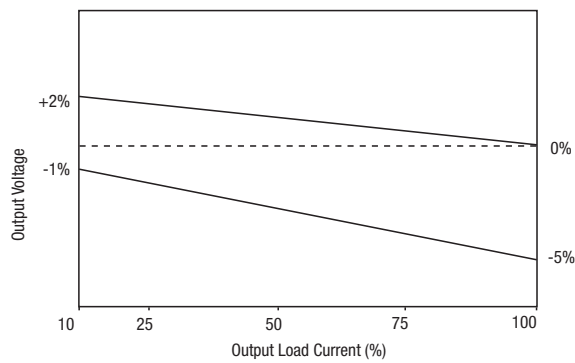

DUAL 1512, SINGLE 1212, 1512, 2412

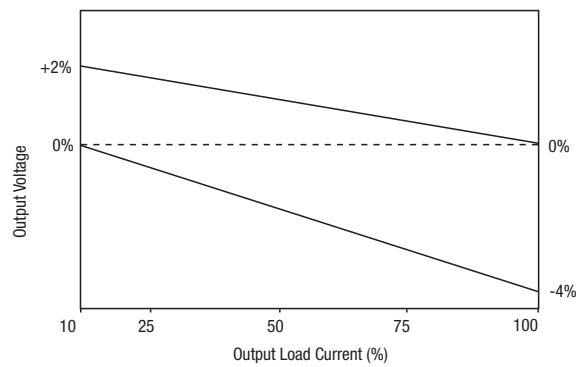

DUAL 0512, SINGLE 1209, 1509,

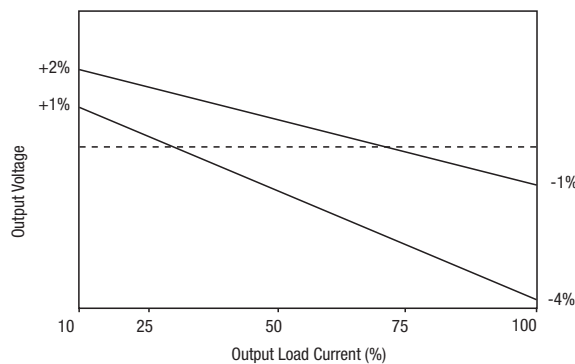

DUAL 1212, 1215, 2415, SINGLE 0509, 0512, 1215, 2409

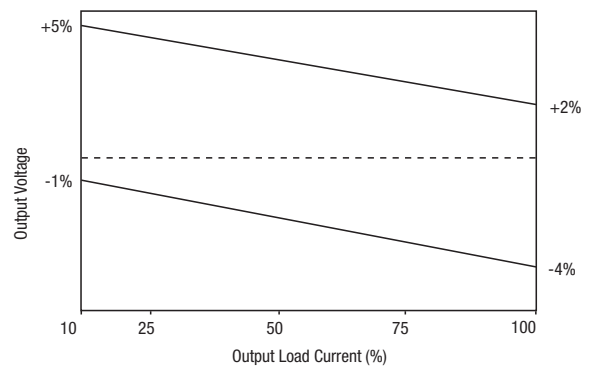

TOLERANCE ENVELOPES

SINGLE 1205, 1505, 2405, 0515



DUAL 1205, 0505, 1505, 2405



DUAL 0509, 0503, SINGLE 0503, 0505



EFFICIENCY VS LOAD Single Output

3.3V Input

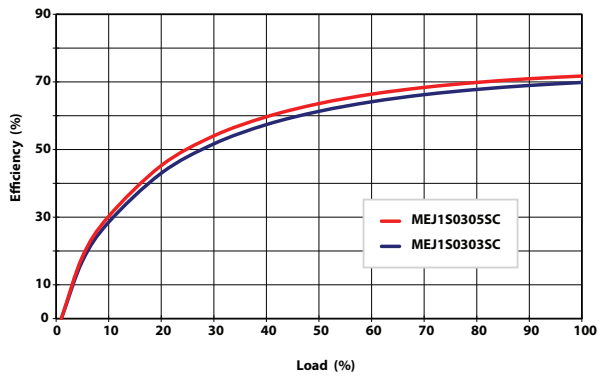

5V Input

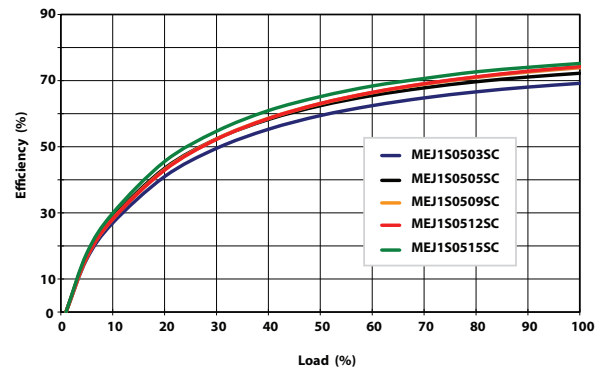

12V Input

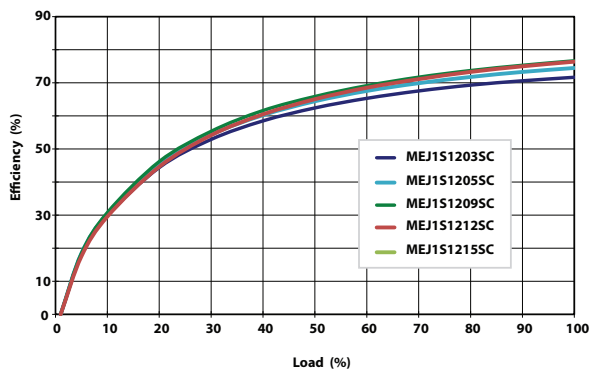

15V Input

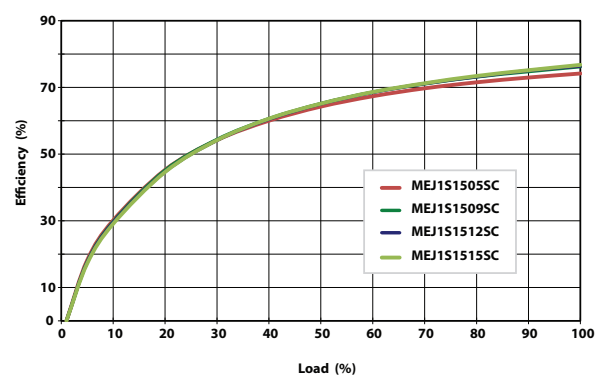

24V Input

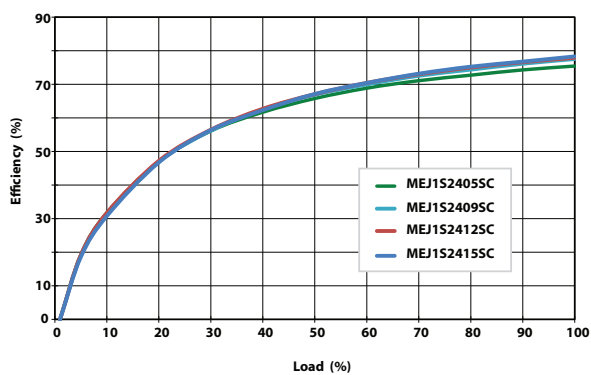

EFFICIENCY VS LOAD Dual Output

5V Input

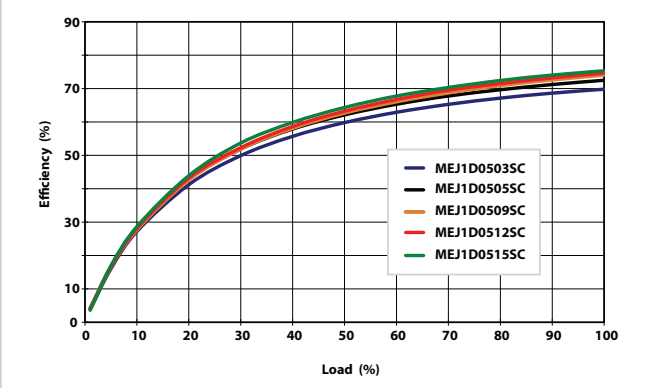

12V Input



15V Input

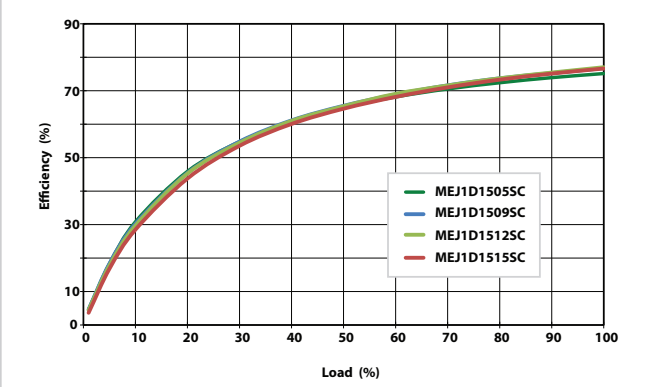

24V Input



PACKAGE SPECIFICATIONS

MECHANICAL DIMENSIONS

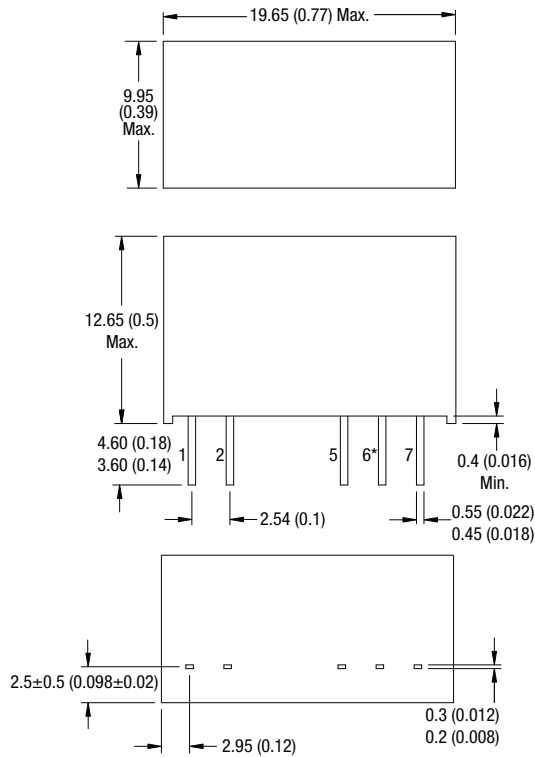

All dimensions in mm ±0.25mm (inches ±0.01). All pins on a 2.54 (0.1) pitch and within ±0.25 (0.01) of true position.

* Pin not fitted on single output variants.

Weight: 4.3g

PIN CONNECTIONS

Dual Output

| Pin | Function |
|-----|----------|
| 1 | +VIN |
| 2 | -VIN |
| 5 | -VOUT |
| 6 | OV |
| 7 | +VOUT |

Single Output

| Pin | Function |
|-----|----------|
| 1 | +VIN |
| 2 | -VIN |
| 5 | -VOUT |
| 7 | +VOUT |

RECOMMENDED FOOTPRINT DETAILS

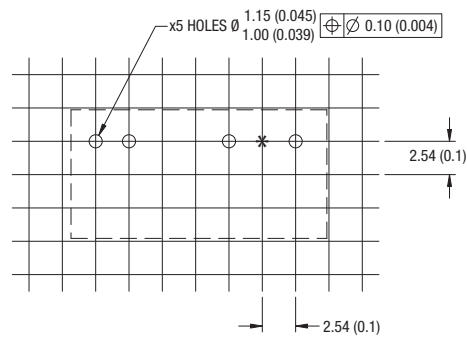

* Hole not required for single output variants.

All dimensions in inches ±0.01 (mm ±0.25mm).

TUBE OUTLINE DIMENSIONS

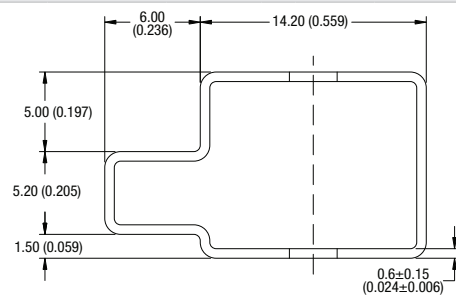

Unless otherwise stated all dimensions in inches ±0.02 (mm ±0.5mm).
Tube length : 20.669±0.079 (525mm±2mm).

Tube Quantity : 25

Murata Power Solutions, Inc.
11 Cabot Boulevard, Mansfield, MA 02048-1151 U.S.A.
ISO 9001 and 14001 REGISTERED



**This product is subject to the following operating requirements and the Life and Safety Critical Application Sales Policy:
Refer to: <http://www.murata-ps.com/requirements/>**

Murata Power Solutions, Inc. makes no representation that the use of its products in the circuits described herein, or the use of other technical information contained herein, will not infringe upon existing or future patent rights. The descriptions contained herein do not imply the granting of licenses to make, use, or sell equipment constructed in accordance therewith. Specifications are subject to change without notice. © 2013 Murata Power Solutions, Inc.



Компания «ЭлектроПласт» предлагает заключение долгосрочных отношений при поставках импортных электронных компонентов на взаимовыгодных условиях!

Наши преимущества:

- Оперативные поставки широкого спектра электронных компонентов отечественного и импортного производства напрямую от производителей и с крупнейших мировых складов;
- Поставка более 17-ти миллионов наименований электронных компонентов;
- Поставка сложных, дефицитных, либо снятых с производства позиций;
- Оперативные сроки поставки под заказ (от 5 рабочих дней);
- Экспресс доставка в любую точку России;
- Техническая поддержка проекта, помощь в подборе аналогов, поставка прототипов;
- Система менеджмента качества сертифицирована по Международному стандарту ISO 9001;
- Лицензия ФСБ на осуществление работ с использованием сведений, составляющих государственную тайну;
- Поставка специализированных компонентов (Xilinx, Altera, Analog Devices, Intersil, Interpoint, Microsemi, Aeroflex, Peregrine, Syfer, Eurofarad, Texas Instrument, Miteq, Cobham, E2V, MA-COM, Hittite, Mini-Circuits, General Dynamics и др.);

Помимо этого, одним из направлений компании «ЭлектроПласт» является направление «Источники питания». Мы предлагаем Вам помощь Конструкторского отдела:

- Подбор оптимального решения, техническое обоснование при выборе компонента;
- Подбор аналогов;
- Консультации по применению компонента;
- Поставка образцов и прототипов;
- Техническая поддержка проекта;
- Защита от снятия компонента с производства.



Как с нами связаться

Телефон: 8 (812) 309 58 32 (многоканальный)

Факс: 8 (812) 320-02-42

Электронная почта: org@eplast1.ru

Адрес: 198099, г. Санкт-Петербург, ул. Калинина, дом 2, корпус 4, литера А.